

The microphytobenthos and its role in aquatic food webs

**Dissertation
zur Erlangung des Doktorgrades**

der Mathematisch-Naturwissenschaftlichen Fakultät

**der Christian-Albrechts-Universität
zu Kiel**

vorgelegt von

Nicole Aberle-Malzahn

Kiel 2004

Referentin: PD Dr. K.H. Wiltshire

Koreferent/in:

Tag der mündlichen Prüfung:

Zum Druck genehmigt:

Kiel, den

Der Dekan

'THERE'S A UNIVERSE INSIDE THESE WATERS'

PATY MARSHALL-STACE, 'MEZA GEBEL' (1995)

Chapter 1 General introduction	5
Chapter 2 Seasonality and diversity patterns of freshwater and marine microphytobenthic communities	12
2.1 Introduction	13
2.2 Material & Methods	14
2.3 Results	18
2.4 Discussion	29
Chapter 3 ‘Spectral fingerprinting’ for specific algal groups on sediments <i>in situ</i> : a new sensor	38
3.1 Introduction	39
3.2 Material & Methods	40
3.3 Results	45
3.4 Discussion	51
Chapter 4 Microcosm experiments on grazing efficiency and selectivity of the freshwater hydrobiid snail <i>Potamopyrgus antipodarum</i> preying upon microphytobenthic assemblages.	54
4.1 Introduction	55
4.2 Material & Methods	56
4.3 Results	58
4.4 Discussion	62
Chapter 5 Factors influencing microphytobenthos community structures beneath macrophyte beds- a marine and freshwater mesocosm study.	67
5.1 Introduction	68
5.2 Material & Methods	69
5.3 Results	73
5.4 Discussion	84
Chapter 6 Selectivity and competitive interactions between two benthic invertebrate grazers (<i>Asellus aquaticus</i> and <i>Potamopyrgus antipodarum</i>)- an experimental study using ¹³ C- and ¹⁵ N-labelled diatoms.	102
6.1 Introduction	103
6.2 Material & Methods	104
6.3 Results	106
6.4 Discussion	111
Chapter 7 General Discussion	118
Chapter 8 Summary	127
Chapter 9 Zusammenfassung	130
Chapter 10 Reference list	133

Chapter 1

General introduction

The littoral regions of lakes and coastal seas are one of the most productive ecosystems on earth and their productivity by far exceeds that of the open oceans. The major primary producers are macro- and microalgae colonizing all sorts of substrates and covering vast areas within the euphotic zones of aquatic systems. Furthermore, since primary production is the basis for secondary producers, the overall importance of littoral zones as complex ecosystems cannot be underestimated. These areas provide extensive habitats and trophic linkages for a large variety of organisms ranging from microfauna to wading birds and demersal fish. Thus, their significance is not large merely from an ecological point of view but also with regard to commercial aspects (fisheries, recreation areas, tourism). The maintenance, protection and investigation of these zones should be of considerable public interest.

The benthos in the euphotic zones comprises not only of macroscopical vegetated habitats rather vast substrate areas are predominately colonized by photosynthetically active microorganisms. This is especially true for sediment surfaces which appear to be bare deserts without any obvious plant life, but on closer inspection the brownish or greenish colouring of the surfaces turns out to be due to microorganisms assemblages, the so called microphytobenthos. This term refers to the microscopic, unicellular eukaryotic algae (Baccilariophyceae, Chlorophyceae and Dinophyceae) and the prokaryotic Cyanobacteria which live on sediment surfaces. They grow in habitats ranging from intertidal sand and mud flats, salt marshes, submerged aquatic vegetation beds to subtidal sediments. Although less conspicuous than macroalgae or vascular plants, the microphytobenthos itself can contribute significantly to primary production in littoral zones (Daehnick et al., 1992; Pinckney & Zingmark, 1993; Colijn & De Jonge, 1984) and in many shallow aquatic systems the biomass of benthic microalgae exceeds that of the phytoplankton in the overlying waters.

External factors influencing microphytobenthos growth

The main limiting factors of microphytobenthos are the availability of nutrients and light. Thus, microphytobenthic assemblages are found at the uppermost surface layers of the sediments right at the sediment-water interface. As the penetration of light is largely confined to the upper 0.2-2 mm, the distribution of benthic microalgae is restricted to this relatively thin surface layer (Wolff, 1979; MacIntyre et al., 1996). The layers in which light is good enough allowing the microphytobenthos to photosynthesise vary both with the granulometry of the sediment and its organic content. Many benthic microalgae are known for their mobility and

they show diel rhythms of vertical migration, moving to and away from the surface in response to a multitude of factors e.g. light, tide cycles, desiccation, predation or resuspension (Admiraal et al., 1984; Pinckney & Zingmark, 1991; Paterson et al., 1998). Although the velocities at which the cells migrate vertically are low, ranging from 10 to 27 mm h⁻¹ (Hopkins; 1963), the ability to move is important to the alga as the top layers of the sediment represent a region with strong physical and chemical gradients. Within a few millimetres of depth, the sediment properties go from fully oxygenated to anoxic conditions and pH, sulphide, irradiance, and nutrients are known to show strong vertical variability (Joergensen et al., 1983; Wiltshire, 1992; Wiltshire, 1993). But despite their variability over vertical scales, there also appear to be considerable spatial fluctuations on a horizontal scale (centimetres to meters). Possible causes for the patchy distribution are variations in the texture and relief of the sediment surface (Joergensen & Revsbech, 1983; Jumars & Nowell, 1984; Gaetje, 1992) or microscale nutrient, irradiance, water content and salinity gradients (Wolff, 1979). Because of their location at the sediment surface, the microphytobenthos plays an important role in modulating nutrient fluxes at the sediment-water interface and this is particularly important with regard to oxygen and nitrogen budgets of the sediments (Sundbaeck et al., 1991; Wiltshire, 1993; Wiltshire et al., 1996). In general it is assumed that growth of benthic microalgae is not limited by nutrients, since nutrient concentrations in the pore water are generally high (Cadée & Hegemann, 1974; Admiraal, 1984). However, in the thin layer of diatoms at the sediment surface biomass may be highly concentrated, and thus nutrients may temporarily become depleted (Admiraal, 1977). When abundant, the microphytobenthos can, furthermore, stabilize the sediment surface against resuspension and erosion by secreting mucilaginous films and forming thin, brownish mats or carpets (Paterson et al., 1990; Delgado et al., 1991; De Brouwer & Stal, 2001). These biofilms are mainly formed by diatoms excreting Extracellular Polymeric Substances (EPS) whereas the amount of excretion is directly related to the rate of primary production (Cadée & Hegemann, 1974).

Microphytobenthic community structures

The microphytobenthos includes representatives of several algal classes (Baccilariophyceae, Chlorophyceae, Cyanobacteria, Dinophyceae). On sandy and muddy substrate, edaphic microalgae living on a variety of benthic surfaces are often dominated by diatoms (Colijn & De Jonge, 1984; Admiraal et al., 1984; De Jonge & Colijn, 1994; Agatz et al., 1999) whereas coccal and filamentous green algae and Cyanobacteria are usually known to occur at some seasonal stages (Yallop et al., 1994; Taylor & Paterson, 1998; Hillebrand & Kahlert, 2001; Nozaki et al., 2003). Microphytobenthic diatom populations are usually composed of pennate, prostrate forms, which are either epipsammic or epipellic (Daehnick et al., 1992;

Moncreiff et al., 1992; Gaetje, 1992; Agatz et al., 1999; Mitbavkar & Anil, 2002). Epipsammic diatoms are monoraphidean, araphidean, biraphidean and centric species of small size that grow attached to sediment particles to which they are glued by mucilaginous pads or stalks. The epipellic forms are biraphidean species which actively move through the sediment by means of the mucilaginous secretion of their raphes (Round, 1971). However, the difference between the two categories is not absolute as there are epipsammic diatoms that are capable of movement, though generally much slower than epipellic species (Harper, 1969) and furthermore, many diatom genera have representatives in either of these groups (e.g. *Nitzschia sp.*, *Navicula sp.*, *Amphora sp.*) (Wolff, 1979). In general, the relative exposure to wave action and currents is thought to favour the dominance of epipsammic biomass and relative shelter the dominance of epipellic forms. In contrast, to epi- or periphyton communities where a distinct three-dimensional layer is usually developed, these patterns are missing on microphytobenthic biofilms and only few erect forms are present. Thus, the microphytobenthos is characterized as a distinctly flat, two-dimensional community (Miller et al., 1987).

Despite the typical characteristics of a microphytobenthic community, it has increasingly been seen that benthic algae may not be strictly edaphic and that planktonic forms can temporarily dwell on sediments (Drebes, 1974, Gaetje, 1992; De Jong & De Jonge, 1995). The same algal classes are found in both the phytoplankton and the microphytobenthos and the basis of separating these types are mainly due to morphological and preferred habitat characteristics. However, the distinction between benthic and pelagic life styles can be fluid especially in shallow water systems since, the exchange of organisms between the sediment and the water column is common. The microphytobenthos can be resuspended by water currents and wave action and thus they then dwell in the water column and contribute to the planktonic community (Drebes, 1974; De Jonge & van Beusekom, 1995; De Jong & De Jonge, 1995). On the other hand, phytoplanktonic organisms can sink to the bottom under calm conditions and settle on the sediment in considerable amounts where they live on and photosynthesise and become incorporated into the microphytobenthos (Potter et al., 1975; Gaetje, 1992; Blomqvist, 1996). Thus, these benthic-pelagic forms must be taken into consideration.

Microphytobenthic life cycles

The life cycles of benthic microalgae are complex and past research showed that some broad generalizations can be made. The biomass in sheltered, muddy habitats is higher than in exposed sandy habitats (Cadée & Hegemann, 1974; Colijn & Dijkema, 1981; Delgado, 1989; Sundbaeck et al. 1991). Variations in the biomass of microphytobenthos in adjacent but distinct habitats can be as great as those over large geographic distances (Sullivan &

Moncreiff, 1990; Pinckney & Zingmark, 1993; Moncreiff & Sullivan, 2001). In temperate regions microphytobenthic biomass, primary production and chlorophyll contents show a spring or summer maximum similar to biomass peaks of planktonic algae (Kann, 1940; Admiraal & Peletier, 1980; Khondker & Dokulil, 1988; De Jonge & Colijn, 1994; Sundbaeck et al., 2000; Nozaki et al., 2003). Due to seasonal variations in light intensities in the northern hemisphere these blooms are of relatively short duration and with increasing latitude they occur later in the year. Many studies on primary productivity and chlorophyll contents of microphytobenthic assemblages have been conducted over the last 30 years. However, their comparability is severely restricted by differences in methodologies (sediment volume, sampling techniques, measurement techniques), habitats and geographical distance. In response to these factors the chlorophyll contents observed ranged from less than 1 mg m^{-2} (Golfe de Fos, France; Plante-Cuny & Bodoy, 1987) to 560 mg m^{-2} (Ems-Dollard Estuary, The Netherlands; Colijn & De Jonge, 1984) as well as primary production rates ranging from less than $1 \text{ mg C m}^{-2} \text{ d}^{-1}$ at the same site in France (Golfe de Fos, France; Plante-Cuny & Bodoy, 1987) to $115 \text{ mg C m}^{-2} \text{ h}^{-1}$ in the Ems-Dollard Estuary (Colijn & De Jonge, 1984). The production variability can be explained by changes in irradiance and chlorophyll a concentration ranges as well as by environmental factors (e.g. temperature, nutrient contents).

Seasonal and temporal fluctuations not only occur in terms of total biomass but they also have been demonstrated on a taxonomic level. The dominance of particular algal groups at different times of the year have been shown by several authors and it was found that despite a general dominance of diatoms, green algae and Cyanobacteria are known to occur in high abundances during the summer period (Kann, 1940; Kann, 1993; Khodker & Dokulil, 1988; Yallop et al., 1994; Taylor & Paterson, 1998; Hillebrand & Kahlert, 2002; Nozaki et al., 2003). Furthermore, seasonal succession has also been demonstrated on genera and species levels and thus, inter-annual taxonomic fluctuations are known to occur (De Jonge & Colijn, 1994; Khodker & Dokuli, 1988).

Food-web interactions and trophic significance

As pointed out before, sediment habitats represent complex aquatic ecosystems and, apart from the sediment microflora, they are also inhabited by innumerable invertebrate species. The sediment dwellers can be classified according to their size ranges as proposed by Plante-Cuny & Plante (1984) into microfauna (ciliates), meiofauna (harpacticoid copepods, nematodes, ostracods) and macrofauna (mainly amphipods, isopods, gastropods, polychaetes, mussels). Most of these taxa can be defined as deposit- and suspension-feeders that consume, obligatory or optionally, herbivorous food items. Furthermore, smaller benthic organisms may also play a governing role as trophic linkages to macrofaunal

consumers or other predators (e.g. demersal fish, birds). Apart from detritus and bacteria, the secondary production in shallow aquatic systems can be supported largely by the primary productivity of benthic microalgae (Daehnick et al, 1992; Moncreiff et al., 1992; Miller et al., 1996; Moncreiff & Sullivan, 2001). Past studies on grazer-microalgae interactions have stressed the relative importance of the microflora as food source for benthic consumers (Fenchel 1968; Fenchel, 1975 a; Sumner & McIntire, 1982; Plante-Cuny & Plante, 1984; Underwood & Thomas, 1990; Hillebrand et al., 2002; McCormick & Stevenson, 1991). Consequently, there is now a consensus of opinion that the microphytobenthos can be considered as the major food source for herbivore invertebrates in the euphotic zone. Additional support to these findings has been given by recent stable nitrogen, carbon and sulphur isotope studies which have demonstrated very convincingly that benthic microalgae are the basis for secondary production at the bottom of shallow freshwater and marine aquatic systems (Sullivan & Moncreiff, 1990; Hecky & Hesslein, 1995; Moncreiff & Sullivan, 2001; Herman et al., 2000; James et al., 2000b). Due to its high abundance and productivity, the microphytobenthos is considered to be a reliable and, furthermore, a highly nutritious food source (Fry & Sherr, 1984; Kitting et al. 1984; Plante-Cuny & Plante, 1984; Decho & Fleeger, 1988; Jernakoff et al. 1996; James et al., 2000b; Moncreiff & Sullivan, 2001). Thus, there is sufficient evidence that the relative importance of labile fractions derived from the renewable pool of microphytobenthos by far outweigh the significance of refractory detritus material as a food source for benthic organisms.

State of the art

To date, most studies dealing with microphytobenthic assemblages in temperate regions focused on intertidal areas in marine and estuarine habitats (Admiraal et al., 1984; Pinckney & Zingmark, 1991; Paterson et al., 1998; Pinckney & Zingmark, 1993; Colijn & De Jonge, 1984; De Jonge & Colijn, 1994; Herman et al., 2000). The restriction of microphytobenthic research to intertidal mud and sand flats of the northern hemisphere is most likely related to their great significance in terms of spatial distribution and ecological relevance. In addition, accessibility and sampling are facilitated in those regions due to low tides and thus intense research can easily be conducted. In contrast, the potential importance of the microphytobenthos in littoral zones and especially in freshwater lakes has received little attention. Thus, its role in freshwater ecosystems still remains poorly investigated (Lowe, 1996). If benthic microalgae in freshwater habitats were addressed at all, these studies focussed predominantly on epiphytic (Cholkny, 1927; Kann, 1940; Kann, 1993; Ho, 1979; Cox, 1993) or periphytic communities (Kann, 1940; McCormick & Stevenson, 1991; Hillebrand & Kahlert, 2001; Hillebrand et al. 2002) whereas studies on the sediment microflora are rare (Miller et al., 1987; Khondker & Dokulil, 1988; Nozaki et al. 2003;

Hillebrand & Kahlert, 2002). However, in the littoral zones of lakes not only do solid surfaces or macrophyte leaves serve as substrate for benthic microalgae, but soft sediments are widespread in lakes and their potential as habitat for sediment microalgae has mostly been neglected. Accordingly, not much is known about microphytobenthic communities in lakes and it can be speculated that its significance in whole lake ecosystems might be underestimated.

Focus of the present study

This work aimed at elucidating the impact of grazer-microalgae interactions in benthic food-webs. As a basis for forthcoming grazing experiments the assessment of microphytobenthic communities in a marine and a freshwater habitat have been conducted. To show distribution and seasonality pattern and to detect key species from each habitat were the primary focus of these field assessments. Proceeding from this basis, several aspects of microalgal consumption with an emphasis on feeding preferences, selectivity and competitive interactions were worked out. In this respect the interplay between positive and negative effects of grazer activity, the impact of active or passive selection and consumers versus productivity aspects were of considerable interest. Thus, the present study should demonstrate system-specific characteristics of microphytobenthic communities and to outline their ecological role in shallow aquatic environments.

In the following chapters, a variety of studies are described that investigated various aspects of the microphytobenthos in a number of different systems with an emphasis on community structure and trophic linkages. In Chapter 2 the primary focus was on the assessment of microphytobenthic communities with traditional methods. The purpose of these studies was, to evaluate succession patterns at two ecologically relevant and contrasting sites. These investigations ought to provide insights into the complex structure of the sediment microflora of each site and to improve our knowledge on taxonomic composition, fluctuation and seasonal variability. In this respect, the aspects of growth form, structure and morphological habit were of special interest. Nevertheless, it should be pronounced that the prevailing motive of assessing various microphytobenthic communities within this study was to detect key genera in each habitat which could be of considerable significance in the benthic food web. Thus, the field assessments enabled a classification of trophically relevant microalgal genera and these investigations served as a basis for following studies on grazer-microalgae interactions.

However, sampling sediment surfaces for microphytobenthic assessments with traditional methods in inter- and subtidal areas rapidly revealed several drawbacks. Although the technology of sampling and analysing microalgal populations in sediments has improved in the last couple of years (Revsbech et al. 1981; Revsbech & Joergensen, 1983; Wiltshire et

al. 1997; Paterson et al. 1998; Barranguet and Kromkamp 2000; Wiltshire 2000), the fact remains that it is extremely difficult to adequately sample populations of microalgae on sediments. In order to improve quantitative and qualitative assessments with high spatial and temporal resolution, a new benthic sensor was devised in this study (Chapter 3). Apart from monitoring the total chlorophyll concentrations at the sediment surface, the benthic fluoroprobe did now enable a rapid evaluation of the community structure and distribution in situ.

All experiments described in Chapter 4-6 aimed at throwing light on the various aspects of grazer-microalgae interactions and to elucidate the impact of feeding preferences, active versus passive selectivity and competitive interactions.

A first approach in order to study grazer-microalgae interactions was to focus on gastropod grazers from natural Schöhsee sediments (Chapter 4). For this purpose small-scale laboratory experiments with varying densities of the hydrobiid snail *Potamopyrgus antipodarum* were conducted. The aim was to quantify grazing efficiencies, feeding preferences and to evaluate the controversially discussed turning points between positive and negative effects of grazer activity.

In Chapter 5 the emphasis was on the functional role of several herbivore species in influencing ecosystem processes in vegetated subtidal habitats. Until relatively recently, macrophyte beds and sediment communities have been universally studied as isolated habitats and the coupling between the macrophyte communities and the sediment microflora have mostly been neglected. However, recent studies showed that the microphytobenthos contributes to large degrees to the food-web within macrophyte beds and, furthermore, the necessity of considering this habitat as a whole was emphasised (Sullivan & Moncreiff, 1990; Moncreiff et al, 1992; Moncreiff & Sullivan, 2001). By establishing treatments with all possible combinations of grazers, their impact on the sediment microflora beneath and adjacent to macrophyte beds was investigated. The aspects of constantly high nutrient loads, taxonomic composition shifts and competitive interactions were of special interest.

In order to investigate feeding selectivity and interspecific competition between herbivore grazers more closely, a stable isotope enrichment experiment was conducted (Chapter 6). For this purpose two diatom species with different morphologies and size ranges were labelled with ^{13}C and ^{15}N . Our aim in this study was to use this new tool to investigate the aspect of assimilation and to distinguish between active selectivity (active choice of food component) and passive feeding preferences (by mechanism of food intake or digestibility), factors that are hardly to detect with traditional methods.

The general outcomes of these various studies are further discussed in Chapter 7, thereby outlining system specific characteristics of the microphytobenthos, its trophic significance as well as nutritional aspects.

Chapter 2

Seasonality and diversity patterns of freshwater and marine microphytobenthic communities

In this chapter the primary focus was to evaluate succession patterns of microphytobenthic assemblages at two ecologically relevant and contrasting sites. Furthermore the purpose of these studies was to provide insights into the complex structure of the sediment microflora of each site and to improve the knowledge on taxonomic composition, fluctuation and seasonal variability. The assessments should serve as a basis for forthcoming grazing experiments on grazer-microalgae interactions.

2.1 Introduction

The diversity and functional role of microphytobenthic communities has become a major topic in benthic research the last two decades (Blanchard, 1990; Blanchard, 1991; Sundbaeck & Joensson, 1988; Montagna et al., 1995; Plante-Cuny & Plante, 1984). The term microphytobenthos refers to the microscopic, photosynthetic eukaryotic algae and Cyanobacteria that live on sediment surfaces. These microorganisms inhabit the surface layers of sediments on vertical and horizontal scales and therefore they play an important role for nutrient and oxygen fluxes at the sediment water interface (Joergensen et al., 1983; Asmus, 1984; Wiltshire et al., 1996). Their occurrence is limited through the depth penetration of light (MacIntyre et al., 1996) and therefore they are highly related to environmental parameters, e.g. grain sizes, nutrient supplies, mechanical stress. Their key function as primary producers in littoral zones has been emphasized in many studies (Daehnick et al., 1992; Pinckney & Zingmark, 1993; Colijn & DeJonge, 1984) and in addition to this their great importance within the benthic food-web has also been pointed out (Sumner & McIntire, 1982; Plante-Cuny & Plante, 1984; Underwood & Thomas, 1990; Hillebrand et al., 2002; McCormick & Stevenson, 1991; Herman et al., 2000).

Microphytobenthic habitats are widespread: they occur from salt marshes, submerged aquatic vegetation beds to intertidal and subtidal sediments including beaches (MacIntyre et al., 1996). Additionally, since the taxonomic composition of microphytobenthic assemblages is closely related to different nutrient levels, their overall importance as sensitive indicators of water quality has been stressed (Lange-Bertalot, 1979; Kann, 1986).

Despite their potential importance in the littoral zones of freshwater lakes, microphytobenthos has received relatively little attention from limnologists and its role in freshwater ecosystems still remains poorly investigated. Consequently, not much is known about the composition, fluctuation and seasonal occurrence of the sediment microflora (Lowe, 1996). Until now most studies in freshwater habitats focused on epiphytic algae (Kann, 1940; Kann, 1993; Cholkný, 1927; Ho, 1979; Cox, 1993) whereas studies on microphytobenthic assemblages are extremely rare (Kann, 1940; Miller et al., 1987; Khondker & Dokulil, 1988; Cyr, 1998; Nozaki et al. 2003). However, the littoral zones of lakes not only consist of solid substrate (e.g. rocks, wood) or macrophyte zones and soft sediments often represent the main substrate in lakes for microphytobenthic communities. Lake epipelagic and epipsammic algae often reach high biomasses and productivity (Gruendling, 1971; Khondker & Dokulil, 1988; Cyr, 1998), they regulate nutrient exchanges at the sediment–water interface (Carlton & Wetzel, 1987) and are an important and high quality food source for benthic invertebrates (Admiraal et al.,

1983; Montagna et al, 1995). Therefore, to comprehend a whole lake ecosystem, it is imperative not to neglect microphytobenthic communities.

In order to understand more about the specific composition of an example lake microphytobenthic community, a field experiment was conducted in the Schöhsee (Plön, Germany) from spring to autumn 2001. Two different sites of contrasting sediment types were chosen in order to compare microalgal communities from both sites and to evaluate similarities. This study should provide data on abundance, diversity and seasonal variations of benthic microalgae in the Schöhsee. The assessment of the microphytobenthic community was to serve as a basis for forthcoming experiments on grazer-microalgae interactions in order to investigate their role in freshwater sediments.

In addition to the assessment of the freshwater sediment microflora, a sampling campaign of intertidal sediments at a marine site was conducted. Since past research has stressed the importance of microphytobenthic assemblages especially in intertidal areas (Pinckney & Zingmark, 1993; Colijn & De Jonge, 1984; Herman et al., 2000), a marine Wadden Sea site was also chosen in this study (Dorum, Lower Saxony, Germany). The aim was to elucidate distribution and seasonality pattern and to reveal temporal fluctuation in algal biomass, abundance and composition.

2.2 Material & Methods

Schöhsee

Sampling sites

Investigations on natural microphytobenthic assemblages were conducted from May to October 2001 in the Schöhsee. The Schöhsee has a surface area of 0.78 km² with a shoreline of 4.7 km. The mean water depth is 10.9 m, with a maximum depth of 29.4 m. The lake has a low catchment area and is categorized as an oligotrophic lake of low productivity. Two different sites were chosen in order to investigate the influence of sediment characteristics (muddy and sandy) on the structure of microalgal communities. Both sites were 30m apart in the vicinity of the island “Kleiner Warder” and both had an experimental area of 0.25 m². The sandy site was at 0.8 m water depth whereas the muddy site was situated at 1.2 m water depth.

Experimental design

In order to apply precise sampling techniques and to keep disturbance of the sediment surfaces to a minimum while sampling, we decided to deploy sediment caps filled with natural sediments from the sites prior to the experiment. These caps were made from cylindrical plastic tubes (\varnothing 14 mm, surface area 154 mm²) provided with a screw cap. A

gauze with a mesh size of 500 μm was glued to the bottom of the caps in order to enable a sufficient permeability (sketch 1). The caps were filled with autoclaved sediment from each site respectively, closed with a lid and kept frozen. At the beginning of the experiment 36 caps were inserted by SCUBA into the sediment under frozen conditions at each site, afterwards the uppermost surface layer of the caps was adjusted to be flush with the surface of the surrounding sediments and finally the lids were removed. The first sampling took place four weeks after the field deployment and a monthly sampling interval was chosen. Each month six caps were chosen randomly from each site, closed under water and transferred to a tray in order to keep the samples in an upright position. Immediately after sampling the caps were returned to the water surface and preserved with liquid nitrogen.

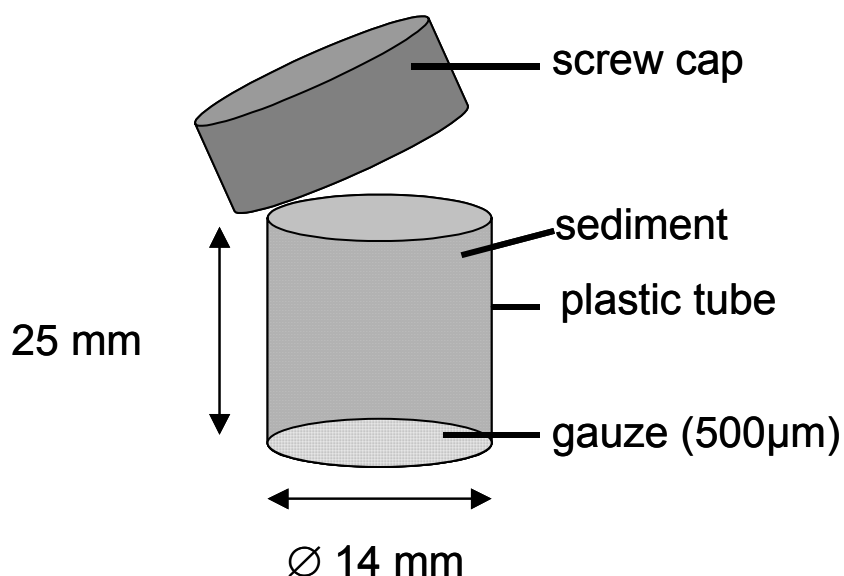

Sketch 1: Sediment cap made from cylindrical plastic tubes provided with a screw cap for closing *in situ*.

Sample preservation

The original Cryolander sampling procedure described by Wiltshire et al. (1997), was used in a modified way for these Schöhsee sediments. Since the device is not applicable under water, it was necessary to modify the techniques slightly. The Cryolander consists of a brass tube (1mm thick) which is 50 mm in diameter and 80 mm in height. In order to preserve the uppermost surface layer of the caps immediately after the return to the water surface, the Cryolander was placed on top of the sediment surface of each tube and subsequently liquid nitrogen (3-5 ml) was gently dribbled on to the absorbent cotton in it. The cotton is at ambient temperature, and this causes the liquid nitrogen to vaporize. This vapour freezes the sediment surface immediately without distortion even on a micrometer scale. Once the

surface is frozen, the liquid nitrogen was then poured onto it evenly through the Cryolander mesh. As the liquid nitrogen continues to freeze the sediment, the depth of frozen sediment increases rapidly until an approximately 2 cm thick layer is frozen. The samples can then be stored in liquid nitrogen for future use.

Sample processing

The frozen samples were cut into 0.5 cm thin discs in the laboratory. Subsequently the sediment disc was placed on the stage of a freezing microtome (Leica CM 1900) using a freezing medium ensuring that the sediment surface was absolutely horizontal. The surface was then cut into slices at 250 μm intervals down to a depth of 500 μm ; the surface layer from 0-250 μm and the deeper layer from 250-500 μm . A description of the micro-slicing technique is given in Wiltshire (2000). For cell counts and taxa composition these sediment sections were fixed with Lugol's iodide solution, transferred to a Sedgewick-Rafter counting chamber and counted under an inverted light microscope. The results from the surface and the sub-surface layer were pooled for taxonomic composition thus the data presented here comprises of algal cells from 0-500 μm sediment depth. Chlorophyll sample processing and HPLC-analysis followed the instructions given by Wiltshire (2000). For this purpose the sediment layers were freeze-dried and suspended in nanograde acetone and frozen at -70°C for a minimum of 72 hours. Afterwards, the extracts were sonified for 90 minutes, filtered through 0.2 μm pore-size cellulose filters and then injected by an autosampler straight into the HPLC-system (Waters Alliance 910). The pigments were identified and quantified using a diode-array detector (Waters Alliance 910). Chlorophyll measurements were conducted by extracting pigments from the different sediment layers with acetone (100%) and measured using high performance liquid chromatography (HPLC, Waters Alliance 910). A detailed description of the extraction procedure and the measurement conditions is given in Wiltshire (2000).

Statistical analysis

To test for significant differences in total cell numbers and chlorophyll a contents at both sediment types a full-factorial ANOVA and a Tukeys HsD-Test were used. For comparisons of seasonality patterns within every single sediment type a MANOVA and an Duncan-test were used. Diversity indices were calculated and multivariate analyses were carried out using PRIMER 5.2 (© 2001 Primer-E Ltd.) and STATISTICA. Diversity was measured by the Shannon-Weaver function (H' ; \log_e) (Shannon and Weaver, 1963) and Evenness was calculated by using Pielou's Evenness (Pielou, 1969). The similarity between samples was calculated using Cluster Analysis, based on clustering of untransformed data.

Dorum (Wadden Sea)

Sampling site

The sediment samples were obtained from a site near Dorum-Neufeld north of the Weser estuary (southern German Bight) in the Lower Saxony Wadden Sea National Park (53° 44' 00" N, 8° 30' 20" E) on the North Sea coast of Germany. Chlorophyll samples were taken from March to September 2002 (August excluded) on a monthly interval at low tide, whereas samples for cell numbers and taxonomic composition were retrieved from March to July only. According to Wickham et al. (2000), the sediment in this area is a fine sand (87% of the particles in Wentworth class 4, or 0.125 to 0.0625 mm diameter) with an average water content of 31% (salinity 36 PSU) and an organic content of 2% (dry weight).

Sample preservation

In contrast to the Schöhsee experiment, it was not necessary to use sediment caps as sampling devices this time. Since the Dorum-site was situated on an intertidal sand flat it was possible to use the Cryolander in its original way. The sediments were cryolanded in situ at monthly intervals and samples were always obtained at low tide from the same site. In order to sample the uppermost surface-layer as accurate as possible, the Cryolander was placed on the sediment surface and some liquid nitrogen was gently dribbled on to the absorbent cotton above (for descriptions see section "sample preservation" of Schöhsee sediments).

Sample processing

The cryolanded sediment discs (\varnothing 50 mm) were cut up in the laboratory into six equal sediment squares (app. 1 cm² each) whereas three of each blocks were used for chlorophyll a determination or light-microscope analyses.

Taxonomic analysis, microsclicing of the sediments and chlorophyll determination followed the same methods as described for Schöhsee sediments.

Statistical analysis

To test for significant changes in chlorophyll concentration an ANOVA was used, whereas the factor month served as independent variable and chlorophyll a content as dependent variable. Differences between month were detected with the aid of a Duncan post-hoc test. In addition, the same statistical procedure was performed for total cell numbers. Diversity indices were calculated and multivariate analyses were carried out using PRIMER 5.2 (© 2001 Primer-E Ltd.) and STATISTICA. Diversity was measured by the Shannon-Wiener function (H' ; \log_e) (Shannon & Weaver, 1963) and Evenness was calculated by using Pielou's Evenness (Pielou, 1969). The similarity between samples was calculated using Cluster Analysis, based on group average clustering of untransformed data.

2.3 Results

Schöhsee

Chlorophyll *a* content

Total chlorophyll *a* contents at the muddy site showed fairly uniform values throughout the whole sampling period (June-October) and no significant differences between months were detected ($p > 0.05$; figure 1). In addition, no significant differences were found between the chlorophyll *a* contents of surface and subsurface sediments ($p > 0.05$). Maximum chlorophyll *a* concentrations at the sediment surface occurred in June ($0.41 \mu\text{g cm}^{-2} \pm 0.13$) and lowest values in August ($0.16 \mu\text{g cm}^{-2} \pm 0.1$). The chlorophyll *a* concentrations at the sandy site showed higher variations. Significantly higher chlorophyll contents at the sediment surface were detected in July and September ($p < 0.05$) when compared to June and October when chlorophyll *a* concentrations were fairly low. In July and September the concentrations reached a maxima of $0.71 \mu\text{g cm}^{-2} \pm 0.36$ and $0.74 \mu\text{g cm}^{-2} \pm 0.26$. A minima of $0.24 \mu\text{g cm}^{-2} \pm 0.01$ and $0.24 \mu\text{g cm}^{-2} \pm 0.03$ were found in June and October. No significant difference between the chlorophyll *a* contents of surface and sub-surface sediments layers was detected. When comparing the chlorophyll *a* contents of surface sediments at both sites a significant difference between sandy and muddy substrate was seen ($p = 0.02$). The chlorophyll *a* concentrations on the sandy sediment were significantly higher than on the muddy sediment. In contrast, these differences disappeared with increasing sediment depth.

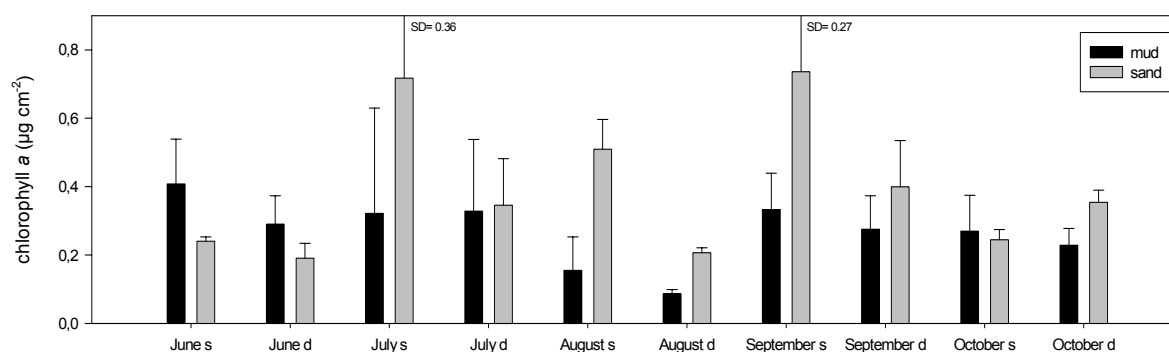

Figure 1: Chlorophyll *a* concentrations ($\mu\text{g cm}^{-2}$) on mud and on sand in the Schöhsee sampled from June to October 2001. Bars present mean values and standard deviations (SD) are given. Different sediment layers are indicated as *s* (surface layer; 0-250 μm) and *d* (deep layer; 250-500 μm).

Total cell numbers

The total cell numbers at both sites were highest in May and June and in October 2001 whereas a decline during the summer period (July to September) could be detected (figure 2). In general the highest algal abundances were in the surface layer (0-250 μm) of each site. A decrease in cell numbers occurred with increasing sediment depth (250-500 μm). At the beginning of the sampling period (May) the muddy site showed values of 266 cells $\text{cm}^{-2} \pm 36$ and the sandy site of 165 cells $\text{cm}^{-2} \pm 24$ at the sediment surface (0-250 μm) whereas the subsurface layer (250-500 μm) showed values ranging from 153 cells $\text{cm}^{-2} \pm 27$ (sand) and 53 cells $\text{cm}^{-2} \pm 11$ (mud). Lowest cell numbers occurred in September, were only 25 cells $\text{cm}^{-2} \pm 15$ were found at the sediment surface of muddy sediments and 35 cells $\text{cm}^{-2} \pm 19$ at the surface of the sandy substrate. A slight increase in total cell numbers was found in the surface layer in October (128 cells $\text{cm}^{-2} \pm 76$, mud; 47 cells $\text{cm}^{-2} \pm 28$, sand). When comparing the total cell numbers of both sites a significant difference in algal abundance occurred only in May ($p=0.019$). All other sampling periods showed no significant difference in algal abundance between the muddy and the sandy site ($p>0.05$).

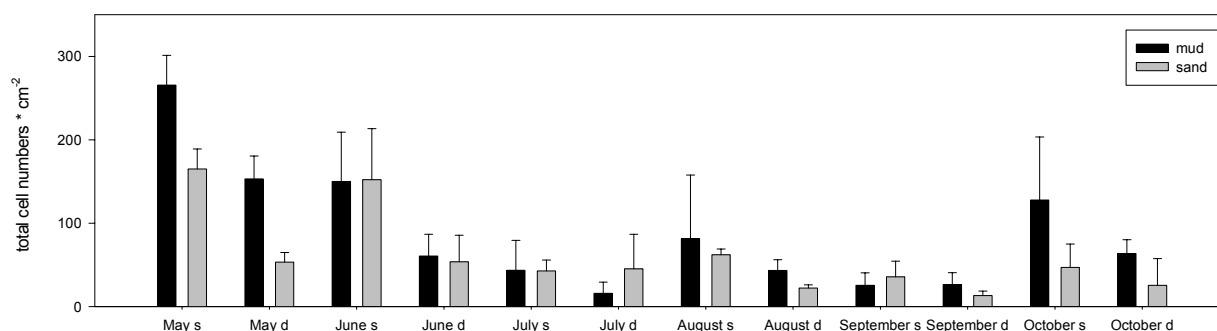

Figure 2: Total cell numbers (cells cm^{-2}) on mud and on sand in the Schöhsee sampled from May to October 2001. Bars present mean values and standard deviations (SD) are given. Different sediment layers are indicated as *s* (surface layer; 0-250 μm) and *d* (deep layer; 250-500 μm).

When comparing the seasonality patterns for the sediment types, significant differences between months were found for the sandy site surface but not for the subsurface layer. The cell numbers of the sediment surfaces showed significant differences between the samples taken in May and June compared to surface sediments sampled from July to October ($p<0.05$). In contrast no significant differences were detected for the subsurface layer of the sandy site. The May cell numbers for the muddy sediment surface showed significant differences compared to all other months ($p<0.05$). In addition, the June algal abundance in

the surface layer were significantly different to May ($p= 0.0235$), July ($p= 0.0341$) and September ($p= 0.0161$). The surface sediments sampled in September and October were significantly different from one another ($p= 0.0404$). In contrast to the sandy site, major variations also occurred in the subsurface layers of muddy sediments. Algal abundance beneath the surface showed significantly higher cell numbers in May compared to samples taken from June to October ($p<0.05$). In addition, June subsurface abundance data were significantly different to July ($p= 0.0149$) and again the September samples compared to October ($p= 0.0360$).

Taxonomic composition

Both sites showed no significant taxonomic composition differences ($p=0.58$). The sandy as well as the muddy sediments were colonized by similar algal assemblages and both sites showed the same seasonality patterns.

The similarities between months on the muddy site showed a clustering pattern of algal assemblages sampled in May and June (figure 3).

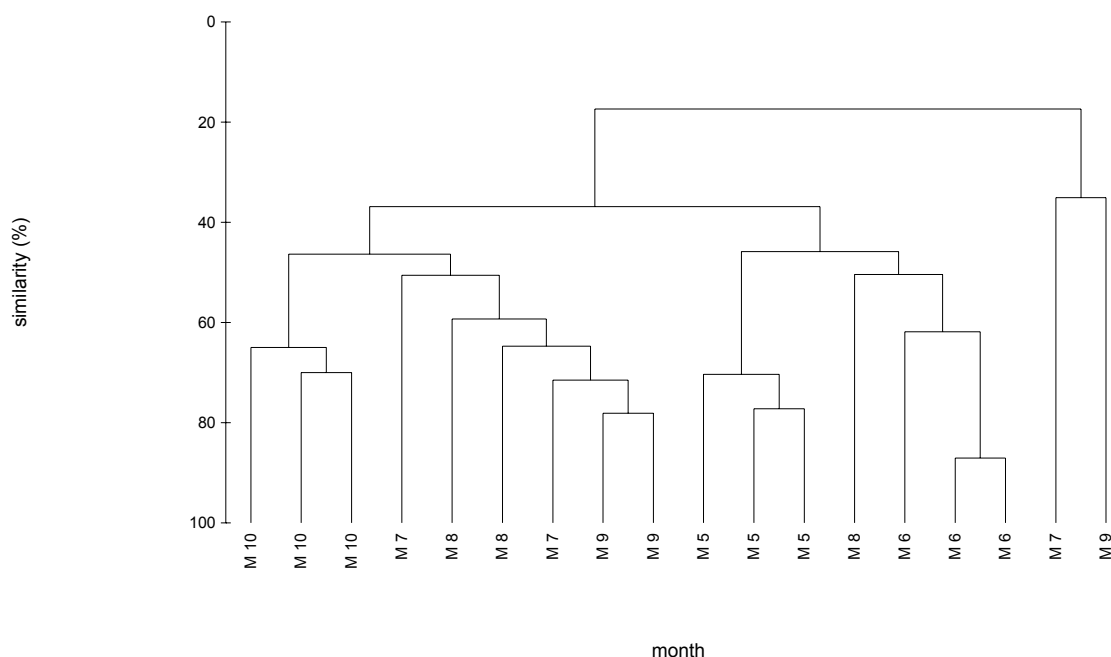

Figure 3: Similarities (%) in taxonomic composition between months on mud (M) in the Schöhsee sampled from May (M5) to October (M10). Absolute cell numbers in the top 500 μm of the sediments are considered.

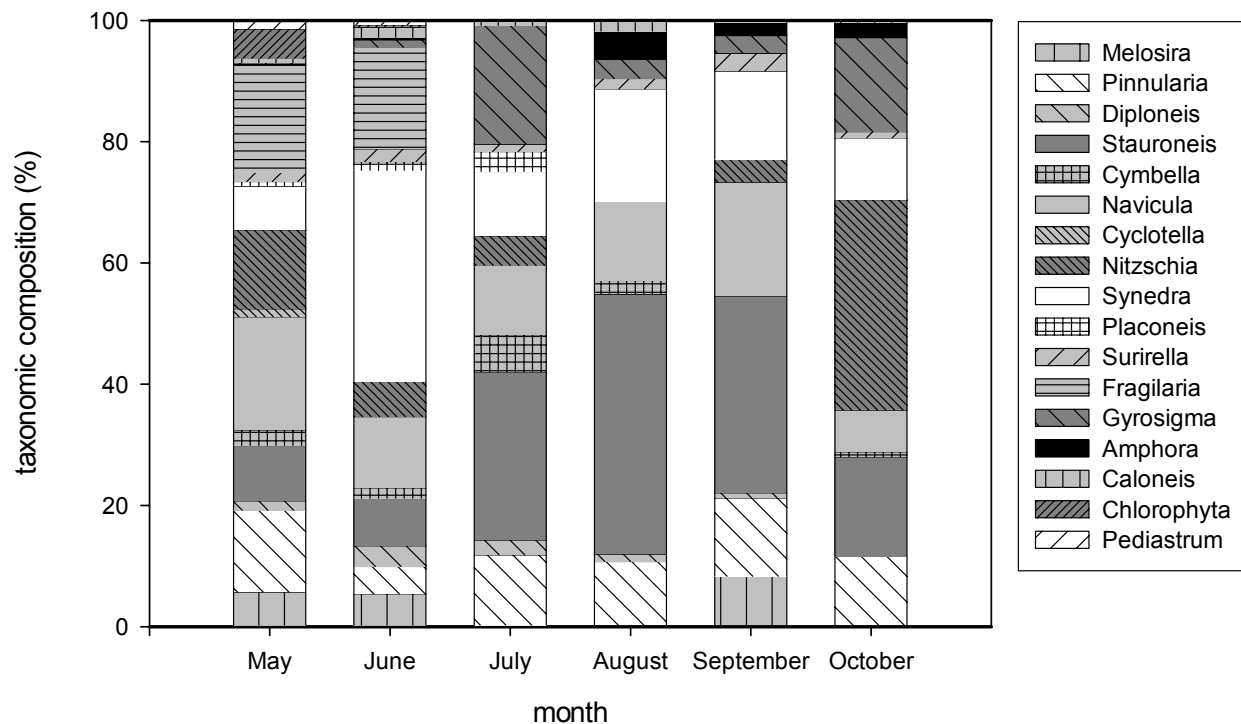

Figure 4: Taxonomic composition on mud in the Schöhsee sampled from May to October 2001. Relative abundances of different taxonomic groups are calculated as % of the total algal cells.

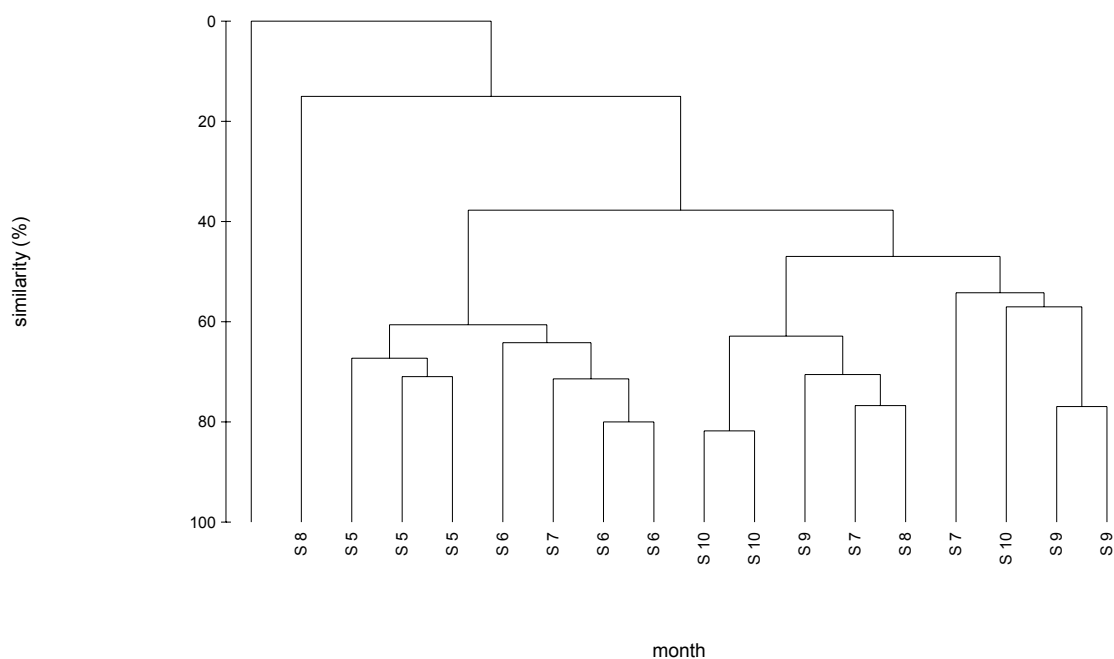

Figure 5: Similarities (%) in taxonomic composition between months on sand (S) in the Schöhsee sampled from May (S5) to October (S10). Absolute cell numbers in the top 500 μm of the sediments are considered.

Both months showed the dominance of *Fragilaria sp.* (17-19%), *Navicula sp.* (12-19%), *Nitzschia sp.* (5-13%), *Stauroneis sp.* (8-9%) and *Pinnularia sp.* (4-13%) (figure 4).

The chain-forming benthic-pelagic *Melosira sp.* comprised 5-6% of the total algal community. The genus *Synedra sp.* was present in both months but showed a strong dominance only in June (35%). In addition, filamentous green algae comprised 5% to the total algal community in May and the coccal green algae *Pediastrum sp.* 1 %. The numbers decreased in June dramatically. For all other diatom taxa percentages of 1-4% of the total were found. During summertime there was a clear change in taxonomic composition when compared to the spring period and samples from July to September showed clear similarities. From July onwards the algal community changed to a *Stauroneis sp.*-dominated population which contributed from 28 to 43% to the total algal community. Other dominant taxa were: *Synedra sp.* (11-15%), *Navicula sp.* (11-19%) and *Pinnularia sp.* (11-13%). In addition, the taxon *Gyrosigma sp.* was highly abundant in July (20%). In October these distribution patterns changed and a clear dominance of *Nitzschia sp.* was seen (35%). Other abundant taxa in October were: *Diploneis sp.* (15%), *Stauroneis sp.* (16%) and *Pinnularia sp.* (11%). From July to October no green algae were found.

On sandy substrate similar distribution and seasonality patterns were found as for muddy sediments. Cluster analysis revealed similarities between May and June samples (figure 5).

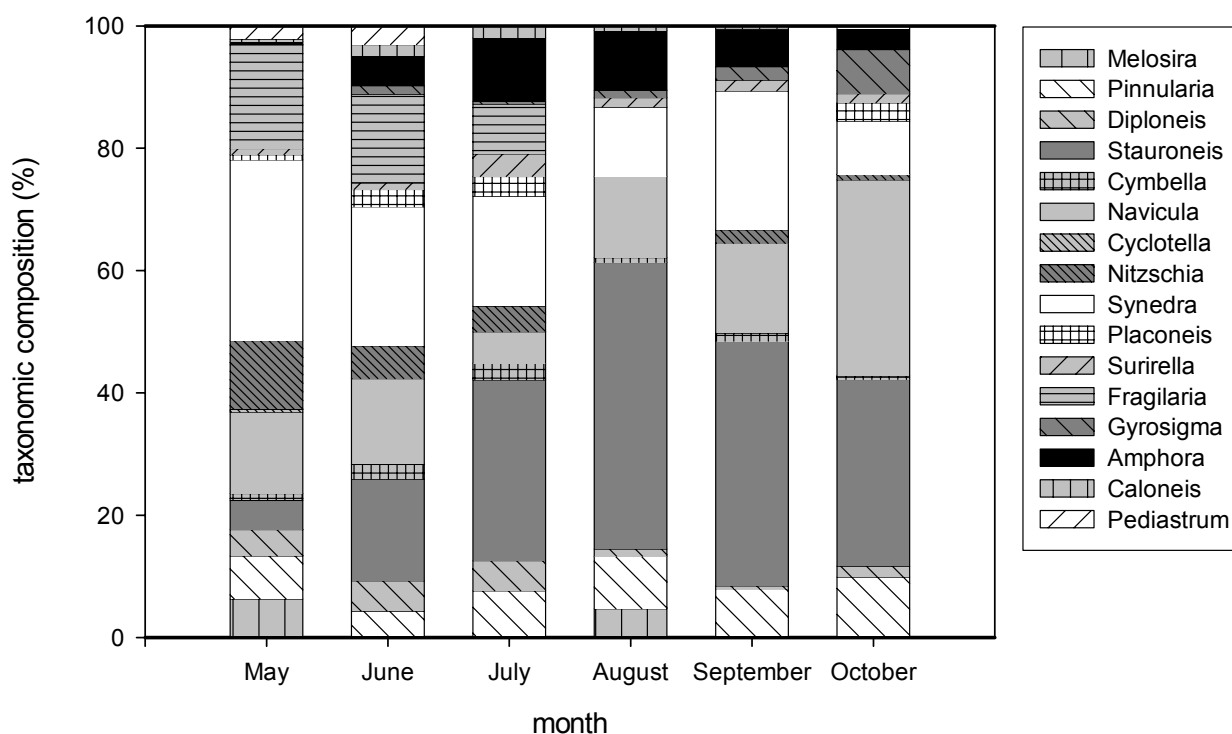

Figure 6: Taxonomic composition on sand in the Schöhsee sampled from May to October 2001. Relative abundances of different taxonomic groups are calculated as % of the total algal cells.

Both months showed high percentages of *Synedra sp.* (23-30%), *Fragilaria sp.* (14-17%) and *Navicula sp.* (13-14%) (figure 6).

In June *Stauroneis sp.* had increased to 16% of the total algal community and the genus *Amphora* appeared (5%). In addition, the green algae *Pediastrum sp.* comprised up to 5 % of the total algal community in May and up to 6 % in June. With the start of the summer period the samples changed in composition. In July the algal community still showed similar patterns as in May and June but cell numbers of *Stauroneis sp.* (30%) and *Amphora sp.* (10%) increased whereas percentages of *Navicula sp.*, *Synedra sp.* and *Fragilaria sp.* decreased. During the summer (July- September) the sediments were similar and *Stauroneis sp.* (30-47%) and *Synedra sp.* (11-23%) dominated. The genus *Amphora sp.* (6-10%), *Navicula sp.* (5-15%) and *Pinnularia sp.* (8-9%) contributed minor percentages to the total algal community. In October equal parts of the microphytobenthic assemblage were presented by *Navicula sp.* (32%) and *Stauroneis sp.* (31%) and *Synedra*-cells decreased in number (9%). *Pinnularia sp.* made up 10% of the autumn community and *Gyrosigma sp.* appeared (7%). No green algal taxa were found during the summer and autumn period.

Diversity and Evenness

The diversity index H' showed similar diversity patterns for both the sandy and the muddy substrate. Highest diversities were shown for microphytobenthic communities in May and June with H' ranging between of 2.0-2.2 on mud and 2.1-2.2 on sand (figure 7). During the summer period a continuous decrease in diversity was been reaching a minimum of 1.59 ± 0.16 (mud) and 1.60 ± 0.20 (sand) in August. A slight diversity increase was seen for September and October with H' ranging between of 1.71-1.80 on mud and 1.61-1.72 on sand. Pielou's Evenness index E showed no clear trend for seasonality and a high variability between months. On muddy and on sandy substrates E was lowest in August (0.71 ± 0.04 and 0.71 ± 0.11). A maximum for E was found on muddy sediments in September (0.85 ± 0.09).

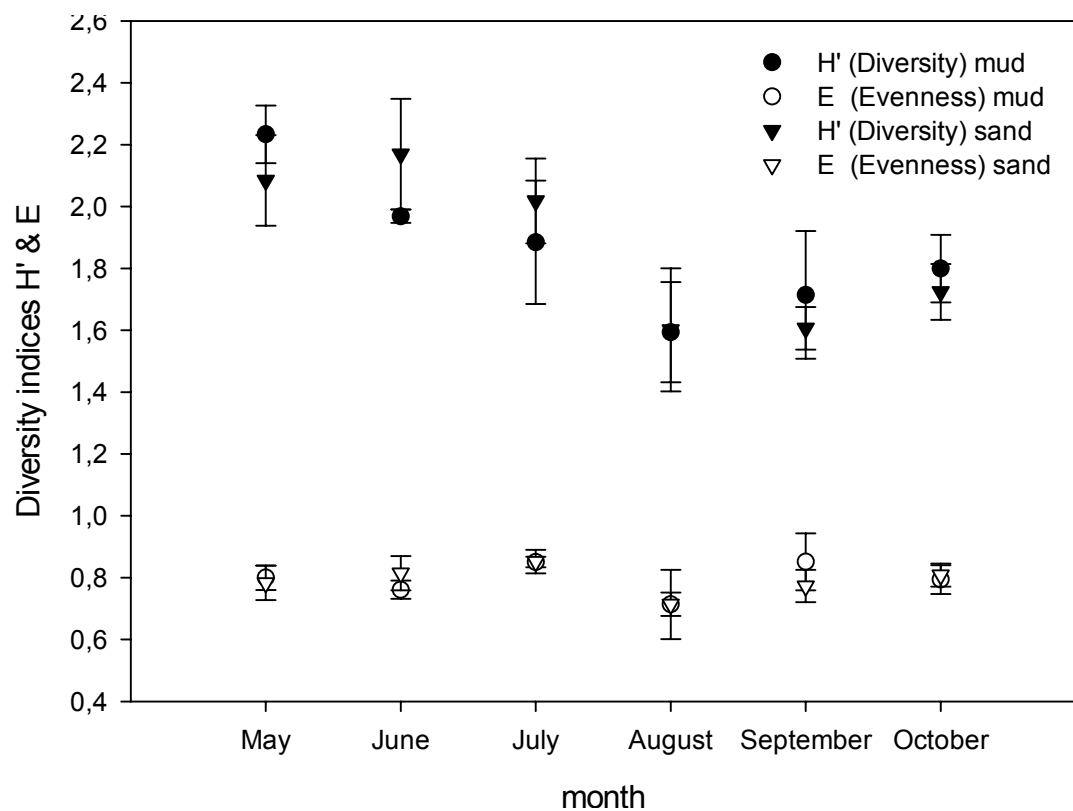

Figure 7: Diversity indices H' (Diversity) and E (Evenness) on mud and on sand in the Schöhsee sampled from May to October 2001. Mean values and standard deviations (SD) are given.

Dorum

Chlorophyll a content

During the whole sampling period from March to September the chlorophyll *a* contents of the Dorum sediments were highly variable. In general the concentrations in surface layer were slightly higher than at depth, although these differences were not significant (figure 8; $p > 0.05$). Lowest contents at the sediment surface (0-250 μm) occurred in May ($0.27 \mu\text{g cm}^{-2} \pm 0.04$) and highest in June ($0.69 \mu\text{g cm}^{-2} \pm 0.23$). Apart from April, the June surface values were significantly higher than all other surface sediments sampled ($p < 0.05$). In contrast, chlorophyll values from subsurface layers (250-500 μm) were more evenly distributed and significantly lower values were found only in March, May and September were achieved in comparison to June-samples.

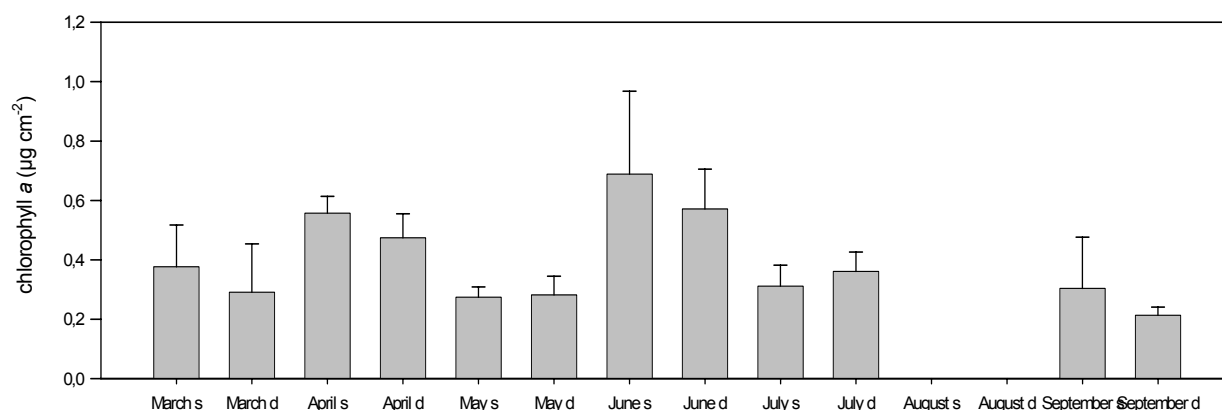

Figure 8: Chlorophyll *a* concentrations ($\mu\text{g cm}^{-2}$) on intertidal sediments (Dorum) sampled from March to September 2002. Bars present mean values and standard deviations are given. Different sediment layers are indicated as *s* (surface layer; 0-250 μm) and *d* (deep layer; 250-500 μm).

Total cell numbers

Highest cell numbers were found for surface sediments in April ($20781 \text{ cells cm}^{-2} \pm 11608$). A minimum of $4142 \text{ cells cm}^{-2} \pm 2029$ was found in May (figure 9). When compared to algal abundances of surface sediments in March and April, the May values were significantly lower ($p < 0.05$). In addition, cell numbers from 250-500 μm in March showed remarkably high numbers ($19854 \text{ cells cm}^{-2} \pm 17344$) and they were significantly higher than sub-surface May cell numbers.

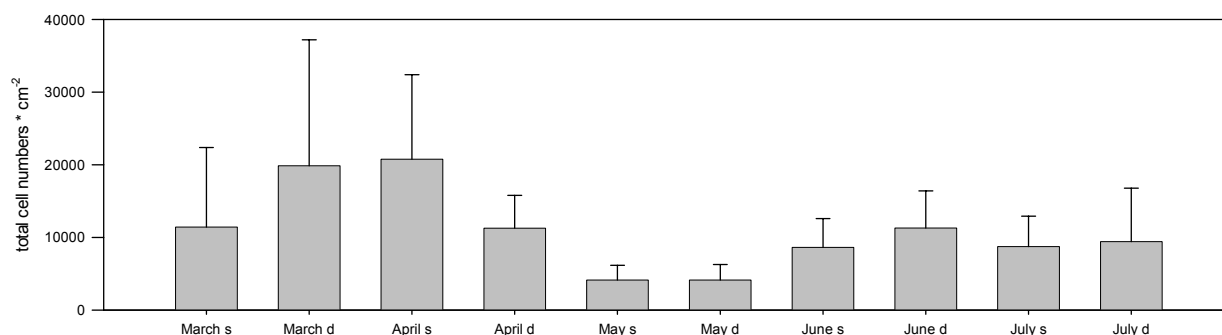

Figure 9: Total cell numbers (cells cm⁻²) on intertidal sediments (Dorum) sampled from March to July 2002. Bars present mean values and standard deviations are given. Different sediment layers are indicated as *s* (surface layer; 0-250 μ m) and *d* (deep layer; 250-500 μ m).

Taxonomic composition

During the sampling season from March to July, all months showed distinct differences in algal taxonomic composition. However, cluster analyses showed similarities between the March and April as well as the June and July community (figure 10). In contrast, the algal assemblages in May were distinctly different. The taxonomic composition of algal assemblages showed an overall dominance of *Navicula sp.* in March (91%), whereas the remaining algae consisted predominantly of *Amphora sp.* (3%) and *Stauroneis sp.* (3%) (figure 11). In April *Navicula sp.* comprised of more than 50% of the total algal community and the benthopelagic *Cylindrotheca closterium* made up 27%. Minor contributions (3-5%) consisted of *Amphora sp.*, *Stauroneis sp.* and some undetermined diatom species. When compared to the community patterns observed in April, *Navicula sp.* was also found in May (63%) and, the cyanobacterium *Merismopedia sp.* also appeared (10%). The remaining proportion was made of *Diploneis sp.*, *Amphora sp.*, *Stauroneis sp.*, *Cylindrotheca closterium* and undetermined diatom species. In June and July the relative contribution of *Merismopedia sp.* increased considerably making up 32% and 80% respectively. Simultaneously the proportions of *Navicula sp.* declined to 41% (June) and 12% in July. The number of taxonomic groups contributing to the total algal community remained almost constant even though.

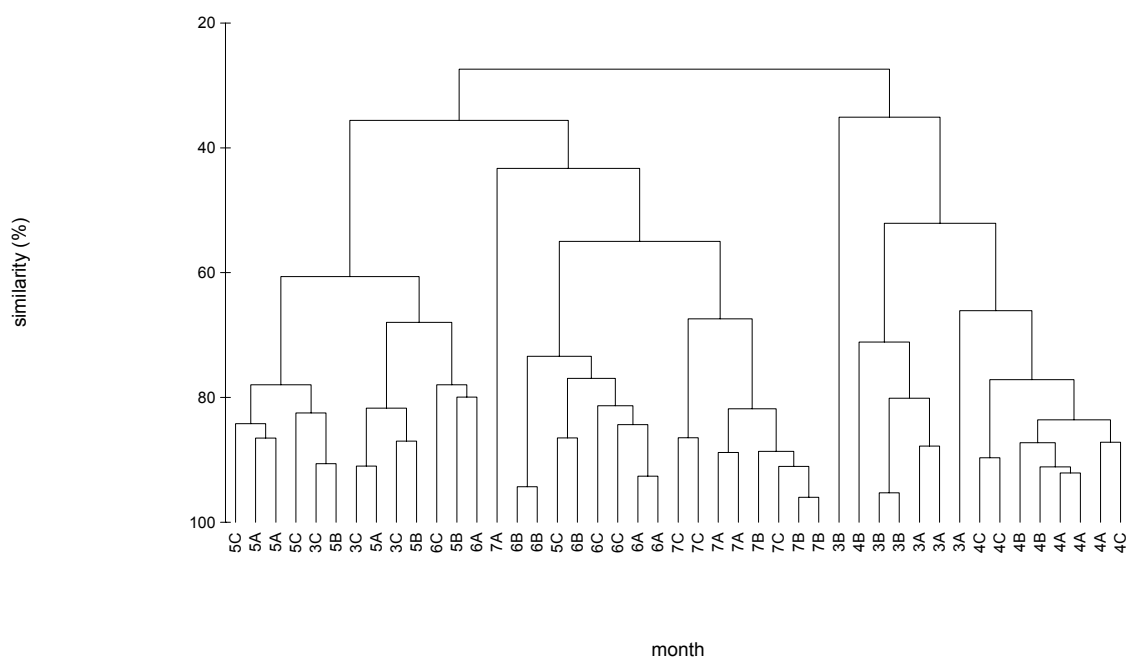

Figure 10: Similarities (%) in taxonomic composition between months of intertidal sediments (Dorum) sampled from March (3) to July (7). Sub-samples from each Cryolander are indicated as A-C. Absolute cell numbers in the top 500 μm of the sediments are considered.

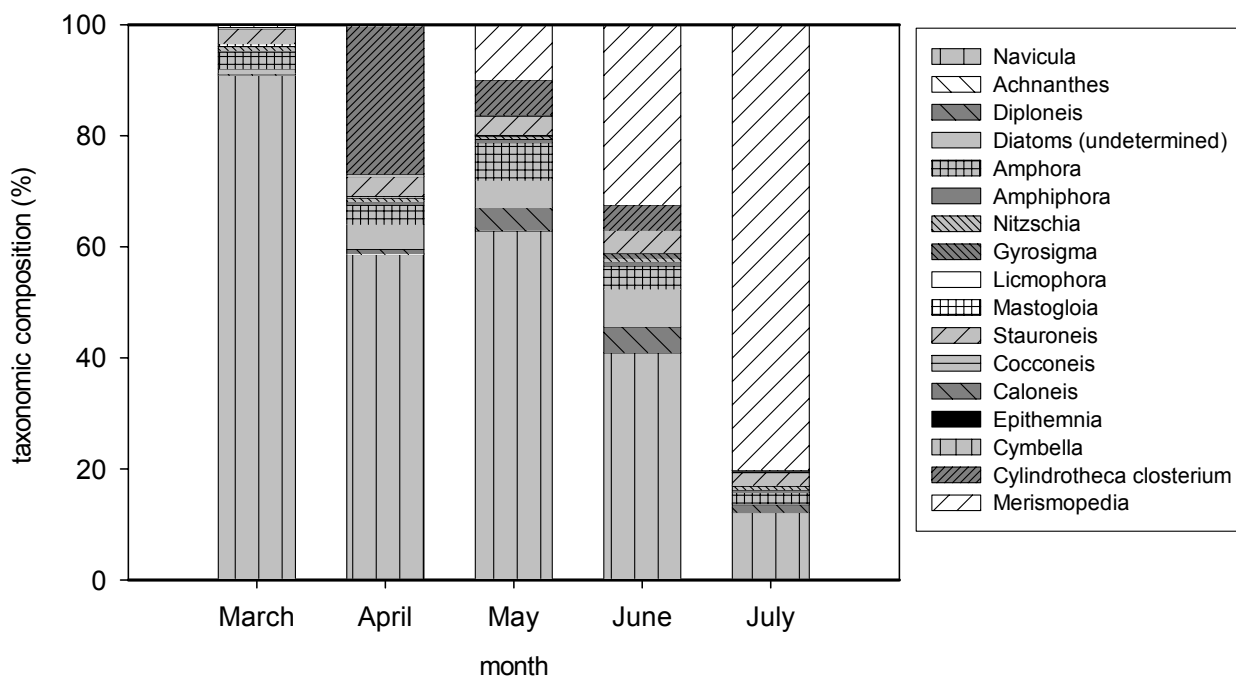

Figure 11: Taxonomic composition on intertidal sediments (Dorum) sampled from March to July 2002. Relative abundances of different taxonomic groups are calculated as % of the total algal cells.

Diversity and Evenness

The diversity index H' and the evenness E showed a steady increase from March to June followed by an abrupt decline in July (figure 12). A minimum of 0.5 ± 0.3 for H' and 0.3 ± 0.1 for E was seen in March and these values were significantly lower than from April to June

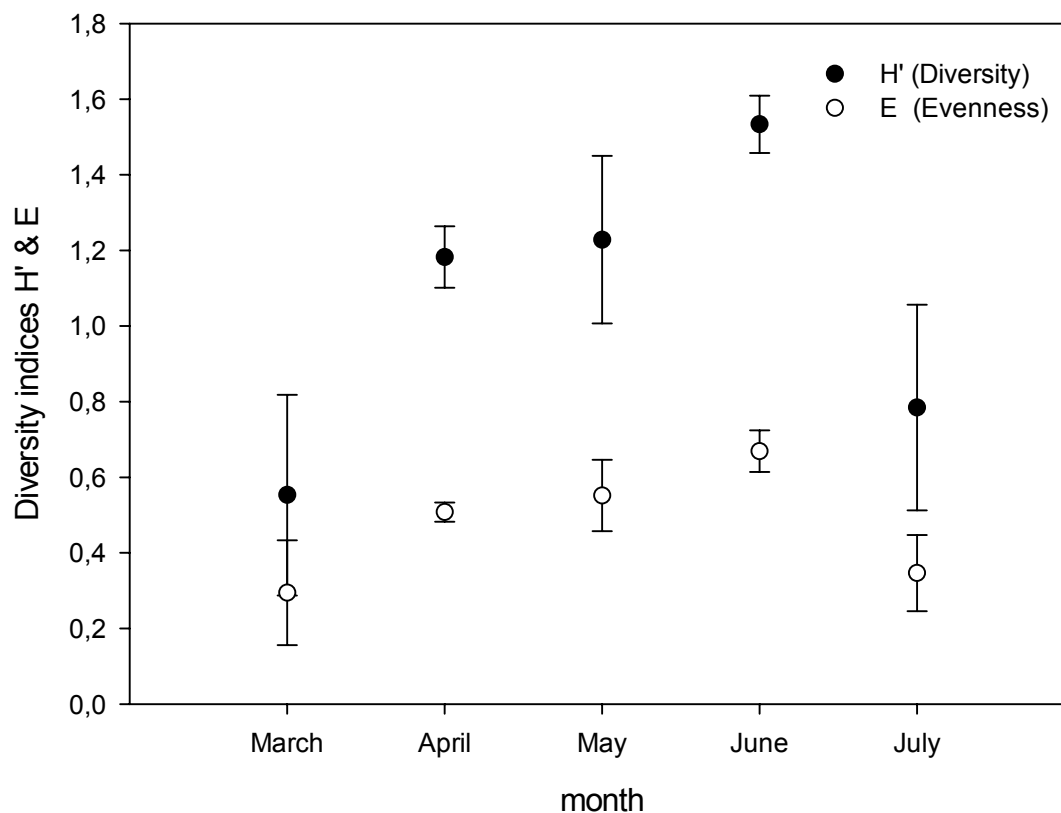

Figure 12: Diversity indices H' (Diversity) and E (Evenness) on intertidal sediments (Dorum) sampled from March to July 2002. Mean values and standard deviations (SD) are given.

($p < 0.05$). When compared to the sampling period from March to May, the diversity index H' increased significantly in June to values of 1.5 ± 0.1 ($p < 0.05$). A similar trend was recorded for Pielou's evenness. However, in this case, the increase in June was only significant in comparison to March and April data ($p < 0.05$). The sediment surfaces sampled in July showed a sharp decline to March values in diversity and evenness. These values were significantly lower than H' - and E -values detected from April to June ($p < 0.05$). The differences in diversity resulted mainly from the relative levels of dominance rather than from changes in the number of forms.

2.4 Discussion

Schöhsee

Chlorophyll a contents

The total chlorophyll *a* contents of the uppermost surface layers (0-500 μm) at both sites showed similar concentrations ranging from 0.2 (mud, August) to 1.1 μg chlorophyll *a* cm^{-2} (sand, September). When compared to former studies on lake sediments these values are at the lower end of concentrations measured at lake “Neusiedlersee”, “Mikolajskie”, “Biwa” and at three lakes in Southern Ontario (Wasmund, 1984; Khondker & Dokulil, 1988; Cyr, 1998; Nozaki et al., 2003). In cases where much higher chlorophyll *a* concentrations occurred, they were usually correlated with mass occurrence of special algal taxa depending on light and nutrient availability at different times of the year. Nozaki et al. (2003), for example found that the development of filamentous green algae contributed to a sharp increase in algal biomass from April to June in lake Biwa and that these mass occurrences were the result of eutrophication. The Schöhsee, with its low catchment area, is categorized as an oligotrophic lake. Mass occurrences of green or blue-green benthic microalgae were not detected in this study, neither at the muddy nor at the sandy site. The absence of these algal groups might be responsible for the low chlorophyll *a* concentrations detected at the sediment surfaces of Schöhsee. It can be speculated that low nutrient availabilities may have caused these low chlorophyll *a* contents at the sediment surface. This might be a typical feature of unproductive lake systems.

The vertical distribution of chlorophyll *a* contents showed different patterns for the muddy and the sandy site. On the muddy substrate the surface layer chlorophyll concentrations were similar to the sub-surface layer values. No significant decline with increasing sediment depth could be detected. In contrast, total chlorophyll *a* concentrations on the sandy substrate in general showed higher values at the sediment surface than at deeper sediment layers, although this pattern changed in October. In general total chlorophyll *a* concentrations are known to decline with increasing sediment depth (Wasmund, 1984) and therefore highest chlorophyll *a* concentrations are usually found at the surficial millimetre of sediments (Gaetje, 1992; Wiltshire 2000). However, chlorophyll distribution patterns are highly variable as they are influenced by many external factors, e.g. hydrography, grazers, sediment grain size, organic contents as well as physiological features of microalgal cells and their migrating behaviour (Admiraal et al., 1984; Wasmund, 1984; Pinckney & Zingmark, 1991; Gaetje, 1992; MacIntyre et al., 1996).

But when comparing chlorophyll data from different studies, it is necessary to take into account the different sediment volumes sampled as all these studies used different sampling techniques. In contrast to our study, the previously conducted studies used the first top

centimetre of the sediment surface in order to detect total chlorophyll *a* contents. Thus, the amount of pigments measured also includes chlorophyll *a* from deeper sediment layers. Wasmund (1989) for example found that appreciable amounts of intact chlorophyll could be found down to 10 cm sediment depths and consequently these pigments were situated below the depth to which light penetrates. However, a significant portion of chlorophyll found at deeper sediment layers originates from settled planktonic material (Stevenson et al., 1985; Wasmund, 1989) which is not distinguishable from benthic microalgae. Therefore, detecting chlorophyll from surface sediments at a centimetre scale may lead to an overestimation of chlorophyll *a* derived from benthic microalgae alone. Compounding this is the fact that the chlorophyll *a* contents of algae are highly variable depending on season, physiological status and physical conditions. As a consequence chlorophyll *a* measurements can only be indicative of biomass (Wolff, 1979; De Jonge & Colijn, 1994).

Cell numbers

Cell numbers at both sites reached a maximum in spring followed by a summer decline and higher numbers again in autumn. The spring maximum is consistent with seasonality patterns investigated for different lake systems all over the world (Kann, 1940; Khondker & Dokulil, 1988; Nozaki et al., 2003). High productivities of microalgae are known to be directly linked to environmental parameters (light, nutrient, temperature). As nutrient and light availabilities are generally high at this time of the year, spring biomass maxima of microphytobenthic algae are an expected phenomena. During summer, nutrients usually get depleted and macrophyte growth increases in the littoral zones and reduces light availability to a large extent. Thus, a decline of microalgal abundances must be expected. However, in the Schöhsee do not only macrophytes like *Phragmites sp.* and *Potamogeton sp.* affect the light regime at the sediment surfaces, but large Alder populations (*Alnus sp.*) also contribute to the shading of the shoreline. Evidence for decreasing light intensities at the experimental sites in summer is found in the development adjacent populations of *Chara aspera* which is known to be highly adapted to low light regimes (Kann, 1940).

These patterns are supported by seasonal variations in lake “Biwa” (Nozaki et al., 2003) and from several northern German lakes (Kann, 1940), where abundances declined during the summer period either. Thus, these studies are in good correspondence to seasonal algal abundance observed here. In contrast, studies from “Neusiedlersee” showed reasonable abundances of epipelagic algae during summer.

Similar to the lakes “Neusiedlersee” (Khondker & Dokuli, 1988) and “Biwa” (Nozaki et al., 2003), autumn abundances were low for the Schöhsee. As nutrient and light availabilities are parameters that show large variations between lakes and even within a single lake system, no general seasonality patterns for all lakes can be proposed. Each lake system has its

unique characteristics and especially the different nutrient levels, latitudes and physical parameters must be considered when comparing seasonality patterns.

Cell numbers at both sites showed highest cell numbers in the uppermost surface layer and a decrease with increasing sediment depth. This is not astonishing as the light availability is highest at the sediment surface and photosynthesis is restricted to a very thin layer at the sediment surface (Wasmund, 1984; Carlton & Wetzel, 1987). Therefore, in the sublittoral zones, algal abundances are usually expected to be highest at the uppermost sediment surface.

When comparing total chlorophyll contents and cell numbers no positive correlation was found. Usually both parameters are used to describe biomass characteristics of algal communities and often good correlations are found (Karlstroem & Backlund, 1977; Khondker & Dokuli, 1988; Mitbavkar & Anil, 2002). However, as already pointed out before, the total chlorophyll *a* content of algal communities is highly variable depending on e.g. the physiological status of algal cells, cell sizes and light intensities (Wolff, 1979) and thus both parameters do not always correlate.

Taxonomic composition & diversity

The taxonomic composition of benthic microalgae in the Schöhsee was mainly restricted to diatom assemblages. In contrast to other lake sediments, where green algae or Cyanobacteria are known to be abundant in some seasons, diatoms were by far the most important taxonomic group found associated with Schöhsee sediments. Green coccal and filamentous algae were only detected in spring in low percentages and these then completely disappeared from July to October.

Mass occurrences of filamentous green algae or Cyanobacteria, as described for several lake systems, are known to be directly linked to high water column nutrient loadings (Kann, 1940; Kann 1993; Hillebrand & Kahlert, 2001; Nozaki et al., 2003). The Schöhsee, with its oligotrophic and unproductive character, seems to favour diatom-dominated sediment communities. A possible explanation could be that diatoms are not as dependent on water column nutrients as filamentous algae (Kann, 1940; Kann, 1993) since they have highly effective mechanisms in getting access to nutrients at the sediment-water interface (Admiraal, 1984; Sundbaeck et al., 1991; Wiltshire, 1993; Hillebrand & Kahlert; 2002). In addition, diatoms are known for their mobility and they show diel rhythms of vertical migration in response to a multitude of factors e.g. light, hydrodynamics, tides, nutrient and perhaps as a strategy protecting them from grazing or erosion (Admiraal, 1984; Pinckney & Zingmark, 1991; Paterson et al., 1998). These characteristics might promote a higher competitiveness of diatoms in unproductive lakes. The assumption is supported by the fact, that green algae occurred only in spring when enough nutrients were potentially still available, but as soon as

the nutrient levels declined the community was dominated by diatoms again. This phenomenon is in good agreement with studies conducted by Hillebrand & Kahlert (2001) and Nozaki et al. (2003), who found high chlorophyte numbers in spring.

In addition to nutrient availabilities, different microalgal taxa have different light demands and consequently light conditions can regulate colonization patterns of microalgal assemblages. As described by Kann (1940), benthic diatoms have a highly adaptive photosynthetic pigment apparatus and they are well adapted to low-light regimes. Depending on the light intensities, seasonal shifts in the xanthophyll cycle have been shown (Wiltshire et al., 1997) and thus their viability at different light regimes is most likely related to their adaptive potential. In contrast to chlorophyll *a*, these pigments have more efficient photosynthetic yields and light absorption capacities and therefore it enables diatoms to grow at low-light conditions. The two investigation sites of this study, were situated in the upper sublittoral zone with a north-easterly orientation. The plots were close to the shore and, as already pointed out before, the shoreline was characterized by large Alder-populations and vast *Chara aspera*-meadows indicating low-light conditions. It can be concluded that the diatoms probably were better adapted to these environmental factors as they have a higher resilience to low light conditions. The colonization patterns can not be generalized for the whole littoral zone of the Schöhsee as different littoral zones probably had varying environmental conditions.

The diversities detected for Schöhsee sediments at both sites showed relatively high values which is similar to data from "Neusiedlersee" (Khondker & Dokulil, 1988). Most of the dominant taxa can be categorized as pennate, prostrate forms, which were either epipsammic or epipellic. Epipsammic diatoms grow attached to sediment particles whereby epipellic forms actively move through the sediments by means of their raphes (Round, 1971). Prostrate forms are typical for variable environments (sand, mud) where disturbance, predominantly through wave action or current, plays an important role in structuring the algal community. On highly exposed substrates, however, algal assemblages are found to be dominated by epipsammic forms (Wolff, 1979). Thus, unstable sediments are usually colonized by prostrate diatoms, forming distinctly flat, two-dimensional communities (Miller et al., 1987). In contrast with epi- or periphyton communities, where a third, vertical dimension usually develops over time, this did not occur with these microphytobenthic biofilms and only few erect forms were present.

In our study the sandy as well as the muddy sediments were colonized by similar algal assemblages and both sites showed the same seasonality patterns. A clear succession from spring to summer was observed, as a shift from a *Navicula*-, *Fragilaria*- and *Synedra*-dominated population in spring to a *Stauroneis*-dominated community in summer was detected. Furthermore, the autumn community also showed clear changes and this was

especially distinct on muddy substrate where the algal population changed to a *Nitzschia*-dominated community in October. In addition, the genus *Amphora sp.* and *Gyrosigma sp.* gained considerably in importance in summer and autumn.

It can be summarized that the microphytobenthic communities at the Schöhsee-sites were dominated both by epipellic and epipsammic diatoms (e.g. *Navicula sp.*, *Nitzschia sp.*, *Pinnularia sp.*, *Stauroneis sp.*) thus indicating an intermediate degree of exposition. This is in good correspondence with studies conducted by Miller et al. (1987). Wasmund (1984) also found that these diatom taxa are abundant on epipellic or epipsammic substrate. However, some typical forms like *Cocconeis sp.* or *Achnanthes sp.*, which are usually found closely attached to sediment particles were missing at our sites. This might be considered characteristic for Schöhsee sediments. In addition, it has to be pointed out that only one erect form was present in considerable amounts throughout the season and this was the genus *Synedra*. This microalga has the ability to stick to surfaces by forming mucilage pads and apparently this feature made it possible for the algae to grow well even on unstable substrates. Only two other erect forms were found periodically- the chain-forming diatoms *Fragilaria sp.* and *Melosira sp.*. The vegetative cells of both diatoms occurred mainly in spring at the sediment surfaces and as these taxa are known to have benthic-pelagic life cycles, it can be assumed that they had settled from the water column and inhabited, for a short time period, the surface of the sediments. They also could have germinated from resting stages in the sediment.

Conclusions Schöhsee

The microphytobenthic assemblages in the Schöhsee were characterized by relatively low chlorophyll contents and cell numbers. The low productivity was most likely related to the oligotrophic character of the Schöhsee and by reduced light conditions in the near-shore sublittoral. The algal assemblages at both sites showed distinct seasonality and succession patterns with clear shifts in community composition in spring, summer and autumn. In general, the sediment microflora consisted predominately of prostrate diatoms forming a distinctly flat, two-dimensional community. Cyanobacteria, green algae and erect diatoms occurred rarely and in low abundances.

Dorum

Chlorophyll a contents

At our Wadden Sea site Dorum, the chlorophyll concentrations at the sediment surface (0-500 μm) showed distinct variations during the sampling period that ranged from 0.5 to 1.3 $\mu\text{g cm}^{-2}$. Compared to other intertidal regions like the Ems-Dollard estuary or intertidal sand flats in Sylt, where ranges of 2.5-25.0 $\mu\text{g cm}^{-2}$ were recorded (Colijn & De Jonge, 1984; De Jonge

& Colijn, 1994; Agatz et al., 1999), our contents in Dorum seem fairly low. But since the previously mentioned studies used different analytical techniques and, in addition, they considered the uppermost 1 cm of the sediment surface for chlorophyll determination, comparisons are not really possible. Similar surface chlorophyll concentrations to our study were achieved from several studies sampling the top 1000 μm of surface layer, showing ranges of 0.1 to 4.0 $\mu\text{g cm}^{-2}$ in the Westerschelde estuary (Barranguet & Kromkamp, 2000; Middelburg et al., 2000), 0.5 to 8.0 $\mu\text{g cm}^{-2}$ on a sandy tidal flat in Sylt (German Wadden Sea; Riethmueller et al., 2000) and Gaetje (1992) gives values of 1.3 to 5.0 $\mu\text{g cm}^{-2}$ for sandy and muddy substrates in the Elbe Estuary.

In general, pigment concentrations are known to decrease with increasing sediment depth (Wasmund, 1984; De Jonge & Colijn, 1994) and highest chlorophyll concentrations are known to occur in the uppermost 1000 μm of the sediment surface (Gaejje, 1992; Wiltshire, 2000). These distribution patterns result from the fact, that light availability is highest at the sediment surface and photosynthesis is restricted to a very thin layer at the sediment surface (Wasmund, 1984; Carlton & Wetzel, 1987). However, the thickness of the euphotic sediment layer varies between 2 and 5 mm, depending on sediment characteristics e.g. grain size (Wolff, 1979), and therefore the occurrence of benthic microalgae is highly related to the depth penetration of light into the sediment. The sediment characteristics of the Dorum tidal flat obviously favoured a homogeneous distribution in the top 500 μm of the sediment surface and this is still within the depth range of 1000 μm given by Gaetje (1992) and Wiltshire (2000) where highest chlorophyll concentrations are known to occur.

Cell numbers

The microalgae cell numbers showed high seasonal variation. A maximum was found at the sediment surface in April and a minimum in May. When compared to cell counts from other regions in the German Wadden Sea area, the Dorum cell numbers are at the lower range of data (Gaejje, 1992; Agatz et al. 1999; Riethmueller et al. 2000). However this is likely to be a result of different sampling techniques and the sampled sediment volumes since the previously mentioned studies sampled not only the top millimetre of the sediment surface and thus, the amount of pigments measured also includes chlorophyll *a* from deeper sediment layers. Pronounced seasonality is a typical feature of microphytobenthic communities in intertidal areas and several studies have shown that seasonal variations are mainly driven by temperature and irradiance (Admiraal & Peletier, 1980; Blanchard & Cariou-Le Gall, 1994; Sundbaeck et al., 2000). In temperate regions intertidal benthic microalgae show biomass peaks similar to the water column in spring due to an increase in sediment surface temperature. The Dorum site showed a biomass maximum in spring as well as slight decreases in summer. This data fits well with seasonality patterns observed by several

authors (Admiraal & Peletier, 1980; Gaetje, 1992; De Jonge & Colijn, 1994; Sundbaeck et al., 2000).

Taxonomic composition & diversity

The taxonomic composition of the microphytobenthic community showed three different successional phases that occurred during the sampling period from May to July 2002. The first phase indicates a spring bloom that was predominately dominated by *Navicula*-species. This small, prostrate form is widespread on intertidal flats and this genus is known to contribute substantially to microphytobenthic communities (Gaejje, 1992; Agatz et al. 1999; Riethmueller et al. 2000, Mitbavkar & Anil, 2002; Hagerthey et al., 2002). But in April proportions of *Navicula sp.* decreased and this reduction was directly related to the occurrence of the diatom species *C. closterium* which contributed to considerable amounts to the total algal community in April. Gaetje (1992) found this particular diatom species to out compete *Navicula* species in case of high grazing pressure while assuming that the large-sized and needle-shaped morphology of *C. closterium* favoured its grazing-resistance. Since *Navicula*-species are known to be a preferred food item for several meiofauna organisms (Admiraal et al., 1983), it seems likely that the observed sudden biomass depression of *Navicula*-cells in this study were most likely the result of efficient and highly selective grazing. The importance of *C. closterium* for intertidal sand- and mud flats has been emphasized by several authors, as this species has been found to be one of the most important exopolysaccharides producers and thus make the special matrix which increases sediment stability (Alcoverro et al., 2000; Staats et al., 2000; Underwood & Provot, 2000). In May, however, the relative proportion of *C. closterium* decreased and apart from high abundances of *Navicula sp.*, other taxonomic groups gained considerable importance. From cluster analysis it was shown that the diatom composition in May mainly reflected the spring and summer populations and thus, this second seasonal stage could be characterized as transition phase. This taxonomic composition was underpinned by the appearance of *Merismopedia sp.*, a Cyanobacterium that can be found regularly on sediment surfaces forming mucus filament networks (Gaejje, 1992; Agatz et al. 1999; Riethmueller et al., 2000). Since *Merismopedia sp.* is known to occur on nutrient-poor intertidal flats (Agatz et al., 1999), the occurrence of the cyanobacterium was most likely related to diminished nutrient supplies resulting from the previous diatom spring bloom. The assumption, that not only algal composition but also total algal biomass could be affected by potential nutrient declines at the sediment-water interface, was supported by low chlorophyll concentrations and decreasing cell numbers in May. This is in good correspondence to investigations conducted by De Jonge & Colijn (1994) who detected gradual or sudden decreases in microphytobenthic biomass right after a spring bloom event. However, not only external

parameters such as nutrient and light availabilities are potential causes for biomass declines during the summer period since the impact of grazer presence in reducing algal biomass to considerable degrees has been stressed in several studies (Plante-Cuny & Plante, 1984; Underwood & Thomas, 1990; Hillebrand et al., 2002; McCormick & Stevenson, 1991). Most benthic consumers show high abundances, reproduction and growth rates in summer and thus, grazing losses often exceed microalgal production at this time of the year. These findings are supported by several studies which showed that such summer depressions of microphytobenthic biomass are directly related to high grazer efficiencies (Colijn & Dijkema, 1981; Gaetje, 1992).

Thereafter, the transition phase was followed by a third vegetation phase, the summer period, which was clearly dominated by *Merismopedia* sp. and which displaced the relative proportions of the remaining diatom taxa. The occasionally high abundances of Cyanobacteria on the Dorum sandflat is not astonishing as previous studies have shown the overall importance of Cyanobacteria in intertidal, microphytobenthic assemblages (Yallop et al., 1994; Taylor & Paterson, 1998). It can be summarized that the habit of the microphytobenthos in the intertidal of the Wadden Sea site was characterized by a distinct, flat, two-dimensional community where other forms, such as stalked or chained diatoms, were missing. Thus also here, a typical microphytobenthic assemblage as predicted by Miller et al. (1987) was found.

The seasonal distribution of taxonomic groups showed a steady increase of diversity and evenness over the course of the sampling period and an abrupt decrease in summer. The actual low values in March and July, however, indicate associations influenced by a predominance of a few taxa rather than from changes in the number of taxonomic groups. In this regard, the low diversity was obviously related to mass occurrences of the diatom *Navicula* sp. (March) and the Cyanobacterium *Merismopedia* sp. (July). When opposed to diversity variables observed by Hillebrand & Sommer (1997) and Agatz et al. (1999), the mean diversities in Dorum were within similar ranges. Furthermore, as pointed out by Agatz et al. (1999), the herein detected diversity values might indicate an intertidal area of moderate nutrient supplies.

Conclusions Dorum

Chlorophyll concentrations and cell numbers of the intertidal flat near Dorum showed considerable temporal and seasonal variations. In good correspondence to biomass changes, these fluctuations were underlined by distinct taxonomic compositions which enabled the classification of a spring, a transition and a summer phase. Clear community and diversity shifts were predominantly induced by mass occurrences of *Navicula* sp. and *Merismopedia* sp. The composition of sediment microflora in Dorum represented a typical

microphytobenthic community with its distinct flat and two-dimensional habit and the absence of stalked or chained forms throughout the season.

Chapter 3

‘Spectral fingerprinting’ for specific algal groups on sediments *in situ*: a new sensor

This chapter presents a new benthic sensor for the differentiation of algal groups on sediments *in situ*. This instrument was developed in order to improve quantitative and qualitative assessments with high spatial and temporal resolution. This non-retrospect approach was successfully applied in this study and results from the differentiation on microphytobenthos populations in the field and in mesocosm experiments are compared with algal biomass and pigment estimations. The potential role of this sensor for ground truth investigations on the large-scale spatial and temporal variation of algal populations in sediments is discussed.

3.1 Introduction

Microphytobenthos of marine and freshwater sediments is a diverse assemblage of pro- and eukaryotic autotrophic microalgae. The qualitative and quantitative assessment of this important algal association, which is the main primary producer in shallow, especially intertidal and littoral, coastal ecosystems (Admiraal & Peletier, 1980; Colijn & DeJonge, 1984) is a major scientific challenge. The determination of algal biomass has always been problematic. Since 1890, when Haeckel, who considered phytoplankton counting a task which could not be accomplished without 'ruin of mind and body', not much has changed and this is even more true for algal biomass on sediments. Until the early nineties microphytobenthos was a poorly studied subject primarily because the methods available to us were few and difficult. As the technology of sampling and analysing microalgal populations in sediments has improved (Revsbech et al., 1981; Revsbech & Joergensen, 1983; Wiltshire et al., 1997; Paterson et al., 1998; Barranguet & Kromkamp, 2000; Wiltshire, 2000), studies on microphytobenthos populations have become increasingly popular. However, the fact remains that it is extremely difficult to adequately sample populations of microalgae on sediments and the requirement of differentiating algal populations over large areas for ground-truthing in remote sensing studies is usually statistically difficult to achieve because the sediments are so patchy. Even the improved current methods, although quite accurate, involve rather time consuming enumeration to species or major taxonomic groups using counting chamber methods (Utermoehl, 1958) or High Performance Liquid Chromatography analyses (Wiltshire & Schroeder, 1994) of the sediments using microtome methods (Wiltshire, 2000). Perhaps the greatest problem with these methods is that they are usually retrospect and not suited to instant assays in situ. Aspects such as patchiness and algal migration are often not detected.

Fluorescence-emission measured around 685 nm is widely accepted as a measure of chlorophyll contents of algae in aquatic systems. Indeed, depth profiling of chlorophyll fluorescence in water bodies has been carried out since the early seventies (Kiefer, 1973; Cullen et al., 1997). Since then some attempts have been made to distinguish different algal groups in phytoplankton communities using their fluorescence properties (Yentsch & Yentsch, 1979; Yentsch & Phinney, 1985; Kolbowski & Schreiber, 1995). Some of these fluorescence methods have been adapted for sediments. Gorbunov et al. (2000) used FRR (Fast-Repetition Rate) fluorometry to estimate photochemical yield and other photosynthetic parameters of microphytobenthos in situ. Barranguet & Kromkamp (2000), Serodio et al. (2001) and Glud et al. (2002) used PAM (pulse amplitude modulation)-technique (Schreiber et al., 1986) to estimate primary productivity and electron transport rates of benthic samples. However, none of these methods allowed in situ algal group differentiation.

Based on our earlier work with a phytoplankton sensor (Beutler et al., 2002a) we set out to devise a new benthic method for the quantitative and qualitative assessment in situ of diverse populations of microphytobenthos with high spatial and temporal resolution, enabling rapid evaluation of the community structure and distribution.

3.2 Material & Methods

Measurement principles

The colour of a photosynthetic organism is influenced by the pigments of the photosynthetic apparatus. Furthermore, the colour of algae is a useful taxonomic criterion. Various taxonomic groups differ significantly in their fluorescence excitation spectrum. Here, we designate algal groups characterised by similar fluorescence excitation spectra as distinct 'spectral signature groups'. We are able to distinguish four spectral groups (1) green: algae containing chlorophyll *a/b*, 2) blue: algae containing phycobilisomes rich in phycocyanin, 3) brown: algae containing chlorophyll *a/c* and green light absorbing xanthophylls and 4) mixed: algae containing chlorophyll *a/c* and phycoerythrin.

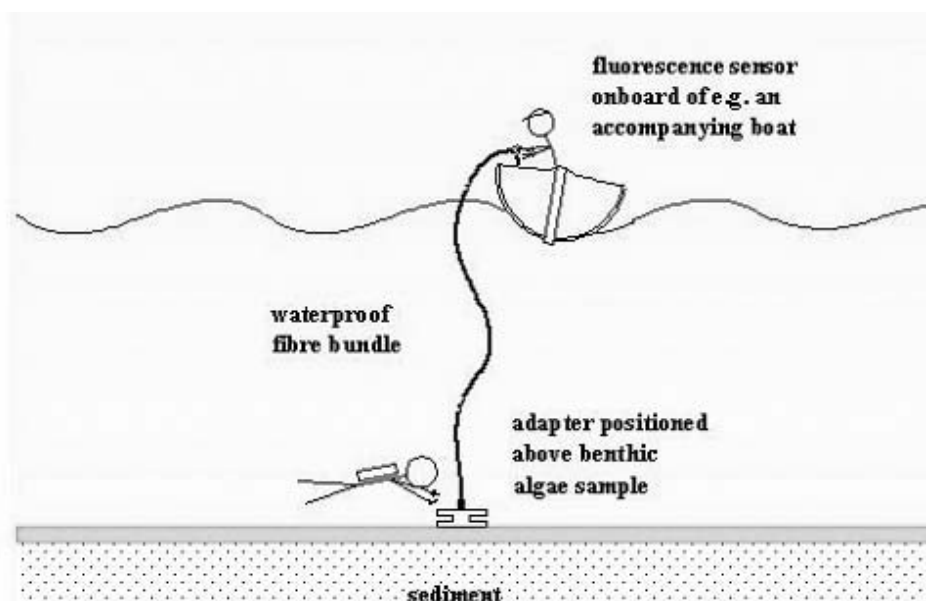

Figure 1: Schematic representation of the benthofluorometric measuring principle.

Our concept is based on the fact that fluorescence is emitted mainly by the chlorophyll *a* of the photosystem II (PS II) antenna system, which consists of the evolutionarily conserved chlorophyll *a* core antenna and species-dependent peripheral antennae. This association results in spectral differences in the fluorescence excitation spectra. Using this method for phytoplankton, Beutler et al. (1998; 2001; 2002a,b) were able to distinguish between four algal groups within in situ fluorescence profiles and could correlate the biomass concentrations of different spectral groups of algae. In Beutler et al. (2002b) the chlorophyll

profiles were corrected for the influence of yellow substances. These determinations are based on the concept that six spectral excitation ranges can be used to differentiate groups of microalgae in situ within a few seconds. In addition, since sediments contain a lot of yellow substances which can affect the optical differentiation of the algae, the device was equipped with a correcting UV-LED for yellow substances.

Submersible sediment instrument

Because the sediments of interest are often underwater or, as in the intertidal, intermittently underwater, it was important to build an underwater device. The optics and electronics are mounted in a waterproof stainless-steel housing (l = 45 cm, \varnothing = 14 cm) with a sealed optical fibre bundle (5 m long; \varnothing = 0.9 cm; Zeutec, Germany) extending out to a small light-proof measuring chamber which is placed on the sediment and ensures a constant distance from the sediment surface to the detector bundle. A schematic representation of the measuring principle is depicted in figure 1. A diagram of the structure of the instrument is given in figure 2 a+b.

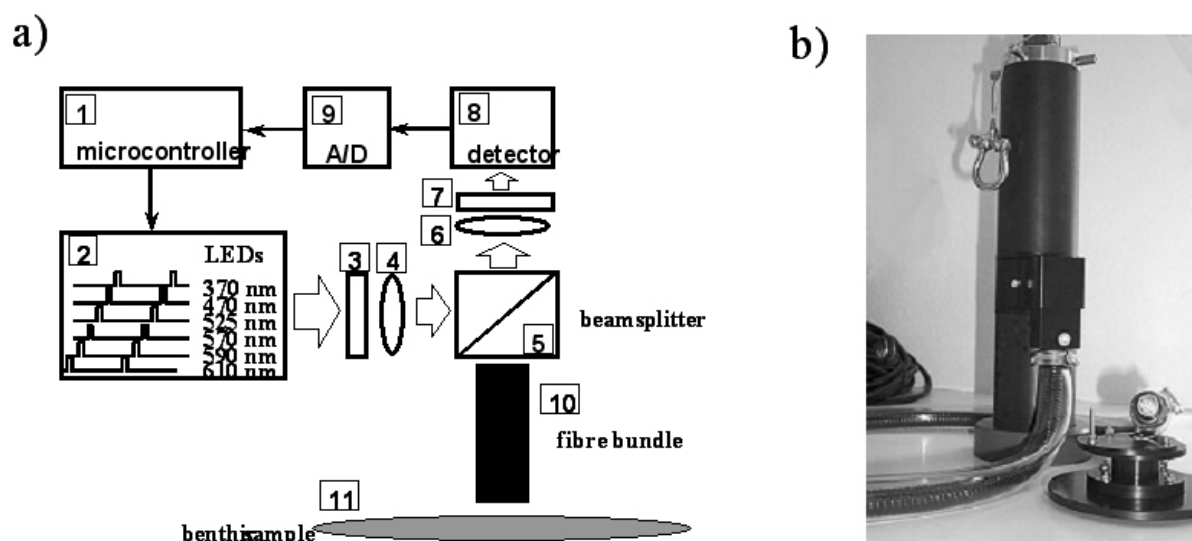

Figure 2: a) The fluorometer components: (1) microcontroller, (2) six light-emitting diodes, (3) short-pass filter to block red and IR emission, (4) focussing lens ($f = 25$ mm), (5) beamsplitter, (6) focussing lens, (7) band-pass filter (see B), (8) integrated photomultiplier, (9) 12-bit AD-converter (conversion rate of 100 kHz), (10) fibre bundle and (11) benthic sample. b) Photo of the fluorometer housed in a water resistant cylindrical case. The fluorometer is connected with a 5 m long optical fibre to the measuring head. The special disc-shaped measuring chamber that is placed on top of the sediment and used as a connecting device for the fibre bundle is shown in the front.

Algal chlorophyll *a* and yellow substances are excited using light from six LEDs with the following emission wavelengths: 370 nm (UV-A), 470 nm (blue), 525 nm (dark green), 570 nm (light green), 590 nm (yellow/orange) and 610 nm (red). The excitation light is guided

through the beam splitter and the fibre bundle shown in figure 2 a. The exact specifications of the light-emitting diodes used for the excitation of the pigment complexes are as follows (centre wavelength and light intensity are given in parenthesis): 470 nm, Oshino OL-ESB 41510 (470 nm, 3 $\mu\text{E m}^2 \text{ s}^{-1}$, Oshino Lamps, Tokio, Japan), 2 \times 590 nm Oshino OL Hewlett Packard HLMP-DL08 (590 nm, 6 $\mu\text{E m}^2 \text{ s}^{-1}$), 610 nm, Oshino OL-SUA 14180 (610 nm, 3 $\mu\text{E m}^2 \text{ s}^{-1}$ Oshino Lamps). The LED light passes through a short-pass filter (50% transmission at 615 nm DT cyan special, Balzers, Liechtenstein) and a focusing lens. The five light-emitting diodes (LEDs) are switched on sequentially at a frequency of 5 kHz. The measuring pulse duration is 0.1 ms. Light intensities were determined at the position of the algal filter with the PhAR sensor Hansatech QRT 1 (Hansatech, UK). Chlorophyll *a* fluorescence with wavelengths between 690nm and 710nm is detected using a photomultiplier(H6779-01, Hamamatsu, Hamamatsu City, Japan) behind a band pass filter (bbe-fk1, bbe Moldaenke, Kiel, Germany). The photomultiplier signal is digitised by an AD converter (12-bit AD converter, conversion rate: 100 kHz) and processed by the same microcontroller (MM-103-5CAQ 18, Phyttec, Mainz, Germany) used for controlling the LEDs.

Data can be stored in the probe or transferred directly to a PC, or for field measurements, a handheld data logger. High sensitivity and dynamic range are extremely important as the light is transmitted to and from the sediment surface via a sealed optical fibre enabling measurement of fluorescence excitation spectra at low chlorophyll concentrations. During measurement the probe can either be in water or, as in the intertidal, in air. For large-scale spatial assessments of the benthic microflora, for example in the intertidal, the probe can additionally be equipped with a backpacking device, allowing the user to carry the fluorometer easily leaving the users hands free for the fibre bundle and the measuring chamber. The spectra are recorded automatically with an integration-time of a second.

Determination of chlorophyll concentrations on surfaces using algal cultures

The basic running parameters of the benthic fluorometer were initially set against bench-top multialgal fluorometer. It was, as described above, precalibrated for algal group differentiation using suspensions of the standard calibration microalgae used by the company bbe Moldaenke in their fluorometer calibrations. These were for the green spectral group: *Chlorella vulgaris*; blue spectral group: *Synechococcus leopoliensis*; and for the brown spectral group: *Cyclotella meneghiniana*. The mixed group (cryptophytes) were excluded in this investigation because of their rarity in the benthic samples. These algae were measured against a standardised bbe Moldaenke bench-top multialgal fluorometer, filtered onto filters and measured by the probe. The factors used in the algorithms are given in table 1. For general information on calibrating a multialgal fluorometer see also details in Beutler et al. 2001; 2002 (a) and (b). After these initial settings, the benthic probe was adjusted for concentration gradients by measuring different amounts (1-20 ml) of algal suspensions filtered onto GFF-filters (Whatmann). The filters were subsequently measured by placing the optical measuring fibre of the new instrument at a specific distance (5 mm) above the surface. Using a lightproof measuring chamber placed on the sediment, with a fixed height, constant distance between the fibre and the sediment surface was provided. From the known filtered volume and a known filter surface area (4.2 cm²) the chlorophyll quantities on the filter were calculated ($\mu\text{g cm}^{-2}$) and set against the fluorescence response of the instrument. See examples in figure 3.

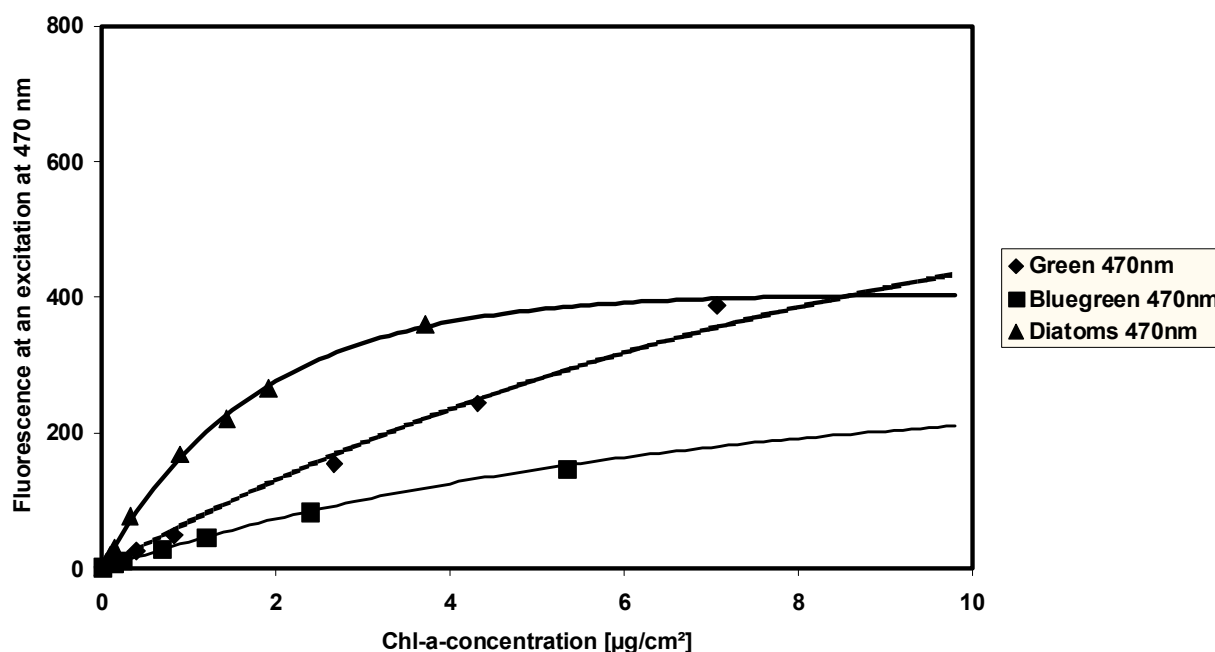

Figure 3: Fluorescence intensities of three spectral algal groups at various concentrations at an excitation wavelength of 470nm

The filtrate was also measured to check that all the algae were retained on the filters. In the measurement procedure described above, relative intensities $a_{\lambda k}$ were determined by measuring benthic samples with the benthic probe containing one algal group. The estimated $a_{\lambda k}$ are shown in table 1.

Table 1 The estimated $a_{\lambda k}$ coefficients (1); 1= green: algae containing chlorophyll *a/b*, 2= blue: algae containing phycobilisomes rich in phycocyanin and 3= brown: algae containing chlorophyll *a/c* and green light absorbing xanthophylls. $a_{\lambda k}$ are given in relative fluorescence intensities per chlorophyll density of the samples ($\mu\text{g cm}^{-2}$) at excitation wavelength λ .

	370 nm	470 nm	525 nm	570 nm	590 nm	610 nm
$a_{\lambda k =1}$	1	76.1	252.5	7.9	268.0	215.1
$a_{\lambda k =2}$	12.9	-1.8	118.1	22.1	483.2	507.0
$a_{\lambda k =3}$	48.8	90.6	706.3	23.5	344.1	280.8

After the measurement with the probe, these filters were then extracted in 100 % acetone and the chlorophyll concentrations measured in the HPLC; method as described in Wiltshire (2000).

The determination of the distribution of the spectral algal groups is based on the premise that the measured excitation spectrum at a fixed emission wavelength is a superposition of the signals from the individual cells and yellow substances (see Beutler et al 2002a for details). For the total fluorescence intensity at a single excitation intensity we get equation (1)

$$F(\lambda_{ML}) = \sum_{k=1 \text{ to } n} C_{CHLa.k} f_{\lambda k} I_{ML}(\lambda_{ML}) \quad (1)$$

where: $C_{Chl.k}$ is the concentration of Chl a which is contained in cells of the k'th algal group (or yellow substances). I_{ML} : the intensity of the measuring light (in $\mu\text{E m}^{-2} \text{s}^{-1}$);

$$X^2 = \sum_{\lambda_{ML}} (F_{\text{measured}}(\lambda_{ML}) - \sum_{k=1 \text{ to } n} C_{CHLa.k} f_k(\lambda_{ML}) I_{ML}(\lambda_{ML})) \quad (2)$$

with $F_{\text{measured}}(\lambda_{ML})$: the measured fluorescence intensity of the sample at wavelength λ_{ML}

To obtain the algal concentration $C_{Chl.k}$ equation (2) was minimized by the use of the fit procedure of Beutler et al (2002 a). The method was found to be sufficiently linear in the

laboratory at chlorophyll densities below $5 \mu\text{g cm}^{-2}$, with errors due to self shading of below 5 %.

3.3 Results

In order to evaluate the applicability of the new benthic probe to natural situations, in particular in view of the precalibration with merely three laboratory algae, we carried out a series of tests. The first involved isolating and measuring a diverse array of benthic microalgae from sediments and culturing these under standard laboratory conditions. The second was to test the measurement efficiency on benthic algal assemblages and to detect succession patterns under controlled laboratory conditions and the third was to evaluate the probes performance on natural intertidal and littoral sediments.

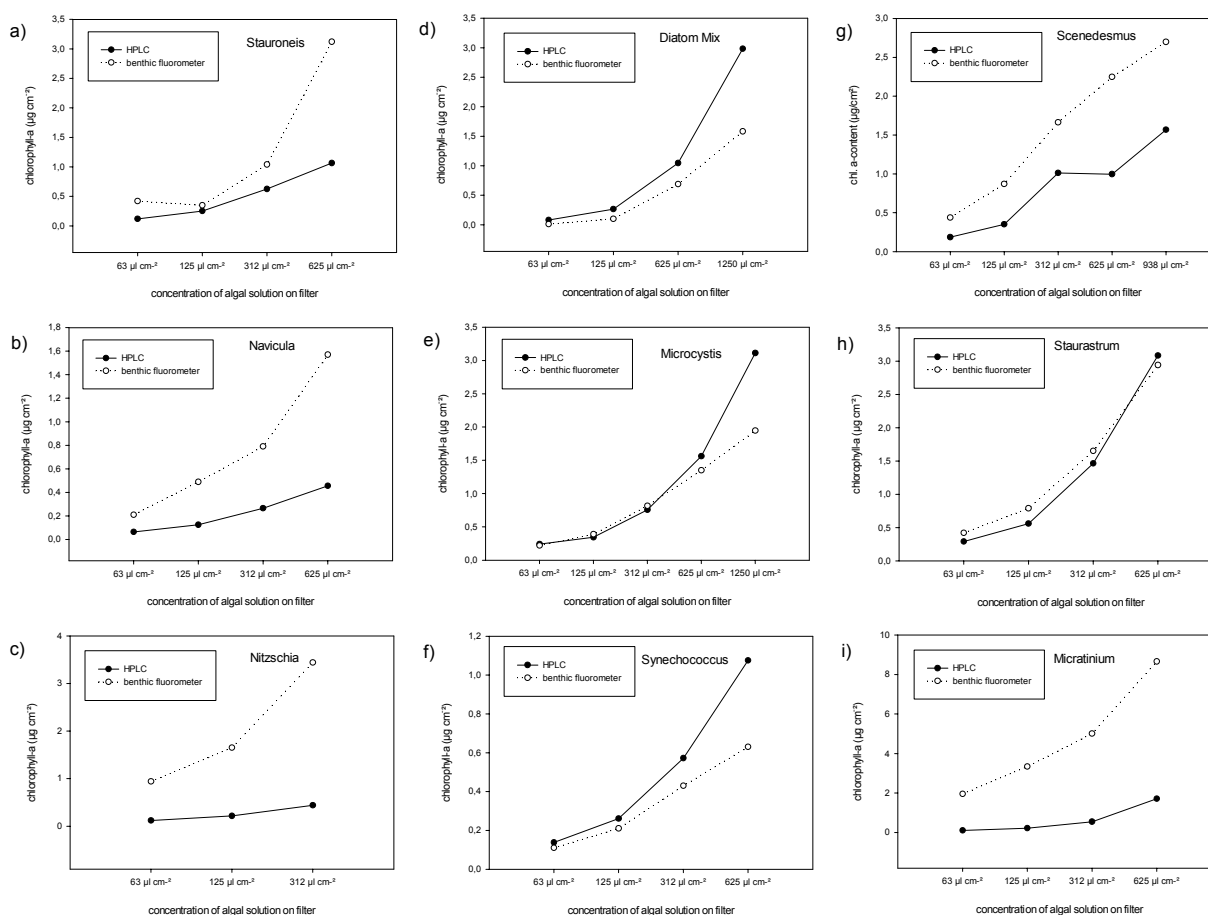

Figure 4: (a-i): Chlorophyll *a* concentrations ($\mu\text{g cm}^{-2}$) of different microalgal culture suspensions measured with HPLC and the benthic fluorometer respectively. Microalgal cultures measured were: *Navicula sp.*, *Nitzschia sp.*, *Stauroneis sp.* and a mixed diatom solution (brown group); *Scenedesmus sp.*, *Staurastrum sp.*, *Micratinium sp.* (green group) and *Microcystis sp.*, *Synechococcus sp.* (blue group).

Assessment of precalibration of the fluorometer with microalgae

Culture suspensions of benthic microalgae, *Navicula sp.*, *Nitzschia sp.*, *Stauroneis sp.* (brown group); *Scenedesmus sp.*, *Staurastrum sp.*, *Micractinium sp.* (green group); *Microcystis sp.*, *Synechococcus sp.* (blue group) in different concentrations (63-625 $\mu\text{l cm}^{-2}$), were filtered onto Whatmann GFF filters and placed under the lightproof probe cuvette as described above. After the measurement with the probe these filters were then extracted in 100 % acetone and the chlorophyll concentrations measured in the HPLC using the methods of Wiltshire (1998). Examples of the relationships between the HPLC data and the probe are depicted in figure 4 (a-i).

It is clear from the results that the precalibration of the probe was not optimal. The examples show, when tested in an ANOVA, that for all the algae, the slopes of the chlorophyll relationships of the methods were all significantly different (table 2). A good example is the relationship between the data of various diatoms (brown group) shown in figure 4 a-d. Other data showed that at times the HPLC values were higher than those values measured and fitted using the initial algorithms of the probe (e.g. figures 4 d-f). Normally the HPLC values were lower. The data also showed that at higher chlorophyll concentrations (above 2 $\mu\text{g cm}^{-2}$) the relationship between device and HPLC-derived values became unreliable.

Table 2: Assessment of precalibration of the fluorometer with microalgae. Algal culture, colour type, slope, intercept and r^2 of the chlorophyll concentrations of single culture.

	type	slope	intercept	r^2
Mixed diatom culture	diatom	0,54	0,003	0,99
<i>Synechococcus sp.</i>	blue-green	0,55	0,06	0,97
<i>Microcystis sp.</i>	blue-green	0,58	0,24	0,95
<i>Staurastrum sp.</i>	green	0,89	0,25	0,99
<i>Scenedesmus sp.</i>	green	1,62	0,25	0,94
<i>Stauroneis sp.</i>	diatom	2,9	-0,26	0,90
<i>Navicula sp.</i>	diatom	3,35	0,00007	0,98
<i>Micractinium sp.</i>	green	3,86	2,24	0,96
<i>Nitzschia sp.</i>	diatom	7,85	-0,02	0,99

The result of such problems was that this information relayed back to the company bbe and used to fine tune the calibration of the probe to the actual chlorophyll concentrations in the algal layer on the filter. The new factors then used in the algorithms are given in table 3.

Table 3: The estimated $a_{\lambda,k}$ coefficients (1); 1= green: algae containing chlorophyll *a/b*, 2= blue: algae containing phycobilisomes rich in phycocyanin and 3= brown: algae containing chlorophyll *a/c* and green light absorbing xanthophylls. $a_{\lambda,k}$ are given in relative fluorescence intensities per chlorophyll density of the samples ($\mu\text{g cm}^{-2}$) at excitation wavelength λ .

	370 nm	470 nm	525 nm	570 nm	590 nm	610 nm
$A_{\lambda,k=1}$	94.4	15.2	57.6	0.4	82	71.2
$A_{\lambda,k=2}$	7	4	40	1.4	360	345
$A_{\lambda,k=3}$	99	13	98	0.5	84	62

Experimental cultivation of mixed microphytobenthic mats

In order to test whether the benthic fluoroprobe could be used to detect changes in microphytobenthos populations over time, mixed microphytobenthic mats were grown including defined numbers of rooting plants and grazing invertebrates under freshwater and marine conditions in the laboratory. Natural sediments from the field were sieved into experimental units and incubated under controlled conditions (16 hours light/8 hours dark cycle with constant water flow) for 21 days. The fluorescence measurements were conducted by laying the special disc-shaped measuring chamber on top of the sediment and, after a short dark-adaptation time, measuring the chlorophyll *a* concentrations per spectral algal group using the probe. In addition, surface sediments were sampled from the same units in order to measure the chlorophyll *a* concentrations at the sediment surface (top 0-240 μm) via HPLC. Measurements were made at the outset of the experiment, after seven and 21 days in order to determine if the probe could be implemented for differentiating temporal microphytobenthos population shifts in both freshwater and marine benthic systems.

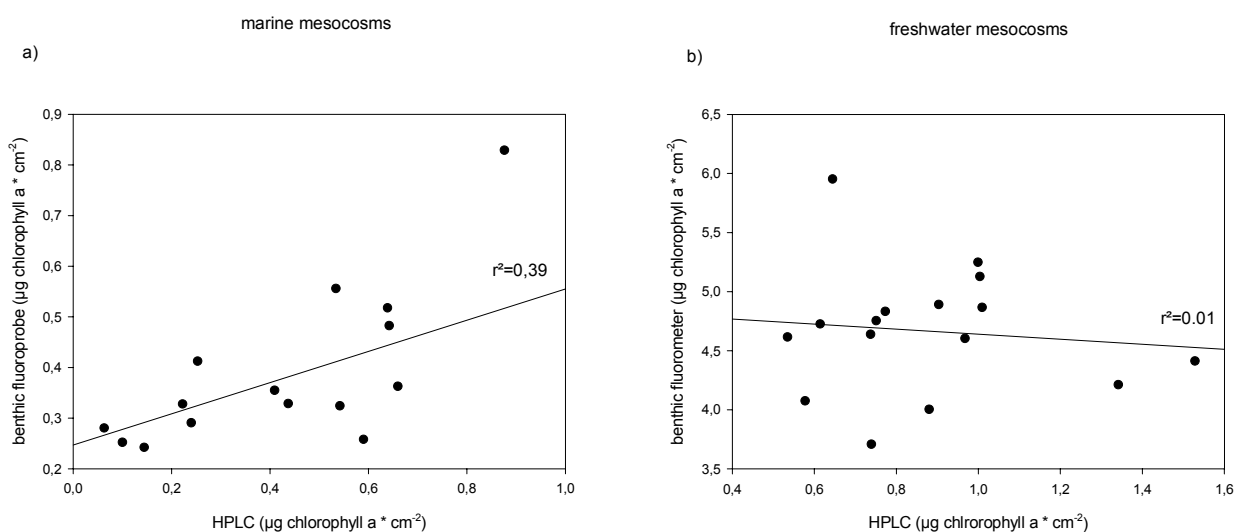

Figure 5: Correlation of chlorophyll *a* concentrations ($\mu\text{g cm}^{-2}$) obtained from HPLC- and fluorometric measurements in the marine (a) and the freshwater (b) mesocosms. Linear regression lines are given.

The correlation between HPLC- and fluorescence measurements is given in figure 5 (a+b). Within the marine units the chlorophyll a concentrations detected ranged from 0.06 to 1.22 $\mu\text{g cm}^{-2}$ (HPLC) and 0.24 to 0.83 $\mu\text{g cm}^{-2}$ (benthic fluorometer) (figure 5a) and an acceptable correlation between both methods was achieved. The freshwater sediment, however, showed much higher concentrations and the correlation between both methods was weak. Chlorophyll a concentrations in the freshwater units ranged from 0.53 to 1.53 $\mu\text{g cm}^{-2}$ (HPLC) and 3.71 to 5.95 $\mu\text{g cm}^{-2}$ (benthic fluorometer) (figure 5b). The measured concentration ranges are rather high considering the fact that at values above 2 $\mu\text{g cm}^{-2}$, the correlation with quantitative HPLC values seemed dubious in our extended algal test described above (see figure 4).

The population differentiation of the microphytobenthos showed that the chlorophyll contents of the marine sediments initially comprised mainly of diatom (99%) and only 1% was represented by Cyanobacteria (figure 6a). In the presence of grazers the community shifted to a three-constituent-community after seven days comprising of Cyanobacteria, Chlorophyta and diatoms (figure 6b) and this pattern changed only slightly after 21 days of grazer presence (figure 6c). In the freshwater units, however, no green algae were detected and the sediment microflora comprised of diatoms and Cyanobacteria. At the beginning of the incubation diatoms made up 86% of the total algal community and Cyanobacteria 14% (figure 6d). In the presence of grazers the proportion of Cyanobacteria increased to 26% (day 7; figure 6e) and 21% (day 21; figure 6f). The algal differentiation detected fluorometrically was checked for accuracy under the microscope and cell count analysis showed very similar taxonomic compositions as detected with the probe. In the marine units the algal assemblage was dominated by prostrate (*Diploneis sp.*, *Nitzschia sp.*) and chain-forming diatoms (*Melosira nummuloides*). Filamentous Cyanobacteria and green algae showed lower proportions. The freshwater incubations showed a dominance of the chain-forming diatom *Fragilaria sp.* and the cyanobacterium *Merismopedia sp.*.

Thus, these experiments with natural microphytobenthic communities served to show the benthic fluorometer proved to be very useful in following temporal changes in both marine and freshwater mats. Increases and decreases of algal chlorophyll as well as differentiation into the various algal groups on small time scales were be easily detectable using the device.

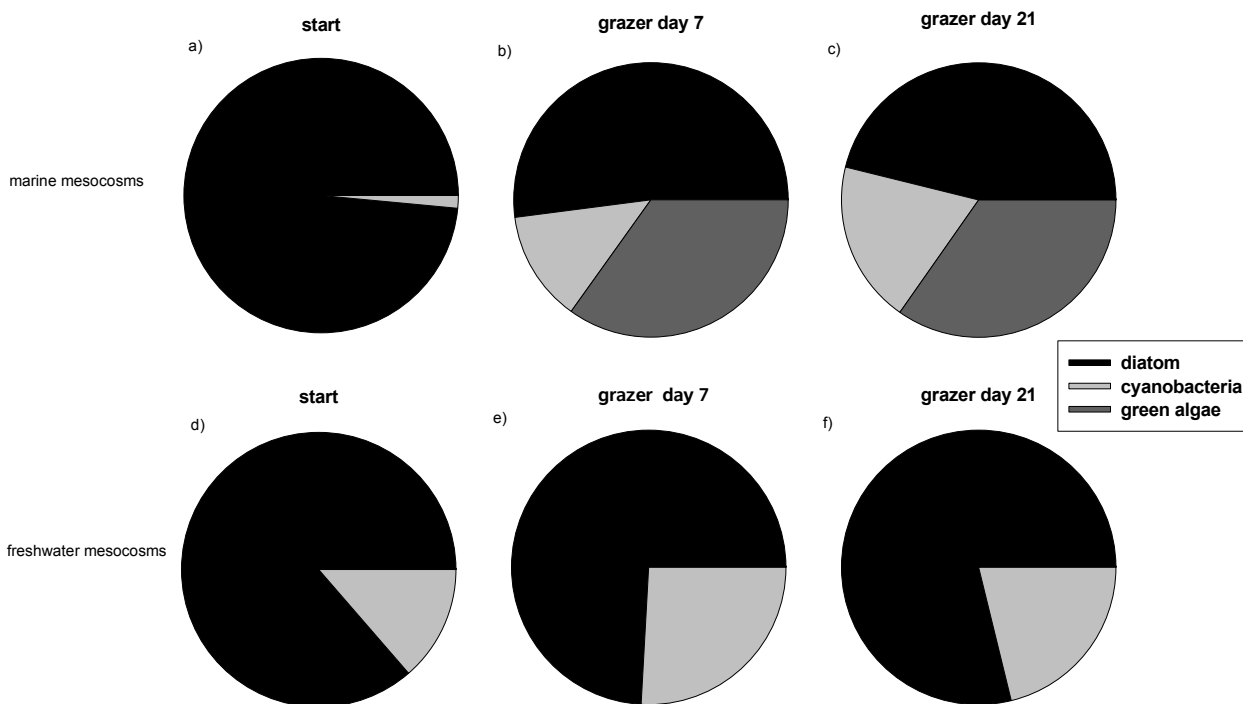

Figure 6: (a-f): Major taxonomic components of the microphytobenthos in the marine (a-c) and the freshwater (d-f) mesocosms detected with the probe. Relative proportions of different algal groups are calculated as % of the total chlorophyll *a* contents of the microphytobenthos. The relative contributions are shown for the starts, after 7 days and after 21 days of incubation.

Natural intertidal and littoral sediments

The sediment fluorometer was tested on natural emerged intertidal sediments at neighbouring sites in the German Wadden Sea (Dorum; Lower Saxony). Based on the colour

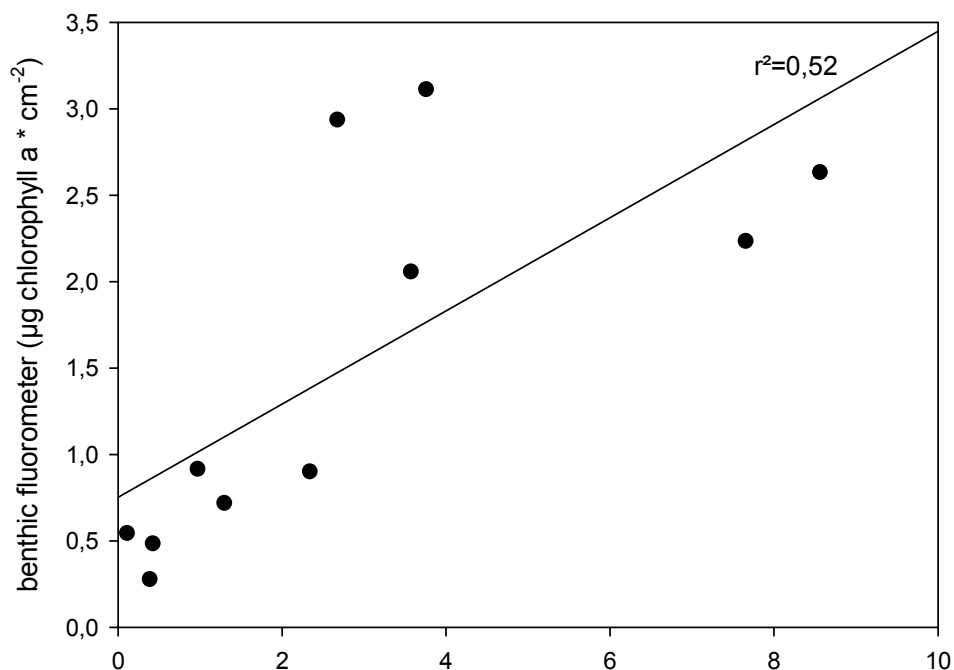

Figure 7: Correlation of chlorophyll *a* concentrations ($\mu\text{g cm}^{-2}$) obtained from HPLC- and fluorometric measurements at an intertidal flat (Dorum, Wadden Sea). Linear regression line is given.

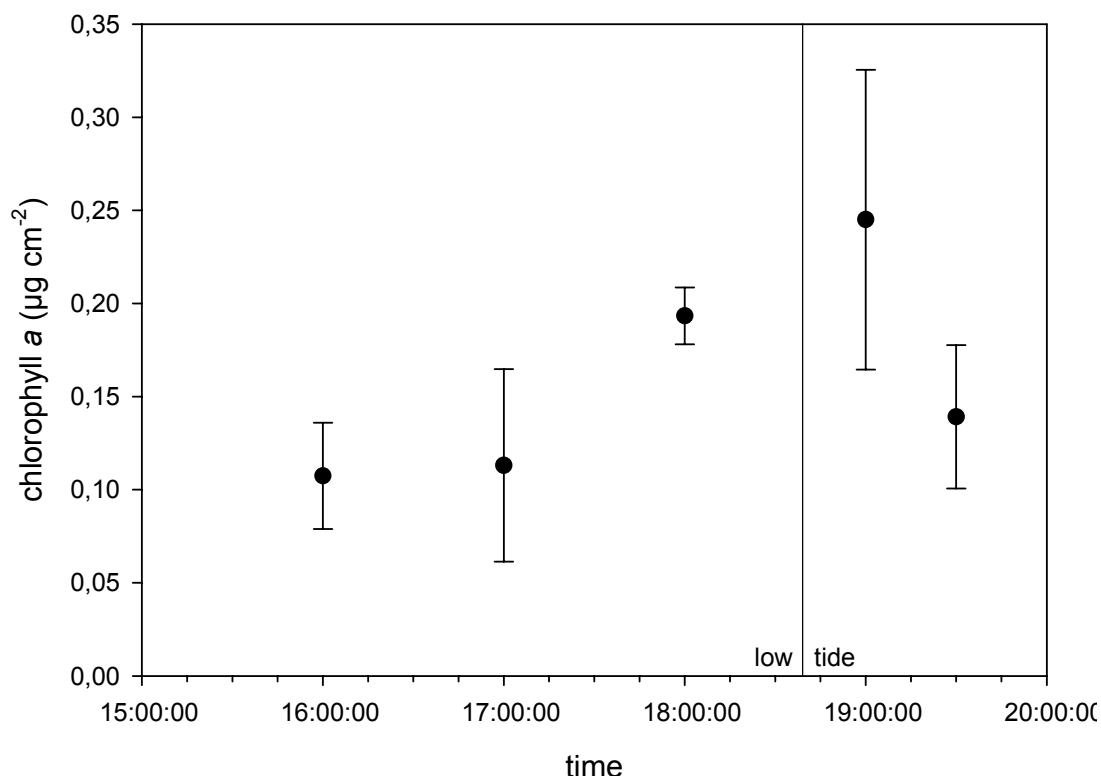

Figure 8: Migration patterns detected from chlorophyll *a* measurements ($\mu\text{g cm}^{-2}$) with the benthic fluoroprobe in the Elbe Estuary (Belum) around sunset. Measurements started 2.5 hours before and ended 1 hour after low tide. The vertical line indicates the exact time of low tide.

intensity, optically different sites were chosen. The sites were coloured light brown to dark brown and they all were situated within an area of 20 m². The total chlorophyll *a* concentrations at each site were first detected with the benthic fluorometer. These measurements were verified with HPLC, using samples taken with the Cryolander method (Wiltshire et al., 1997) and the micro-sliced surface layer (the top 0-240µm), see methods as described by Wiltshire (2000). When measured with the fluorometer the sites were shown to be very similar in their algal make-up as a dominance of diatoms was observed for all sediment surfaces and this was verified by the pigments found in the chromatograms of the HPLC analyses. The correlations of the HPLC values with the probe are given in figure 7 ($r^2=0.52$). Chlorophyll *a* concentrations in the field ranged from 0.11 to 8.56 $\mu\text{g cm}^{-2}$ (HPLC) and 0.28 to 3.11 $\mu\text{g cm}^{-2}$ (benthic fluorometer). The extreme patchy nature of the sediments at this location was remarkable since all sites were situated at short distance to one another. Such patchy distributions of benthic microalgae at small horizontal scales are well known from intertidal as well as subtidal areas. Such distinct variations are most likely related to the micro texture of the sediment surface (Joergensen et al., 1983; Jumars & Nowell, 1984) or to microscale nutrient, irradiance and salinity gradients (Wolff, 1979). It is important that this patchiness is detectable easily especially for ground truthing purposes.

Perhaps one of the most difficult phenomena to measure in situ is the migration of benthic algae to and away from sediment surfaces related to light, tides, rain etc. (Paterson et al.,

1998; Underwood et al., 1999). We used this phenomenon as a challenge to the new fluorometer.

Depicted in figure 8 is the change in chlorophyll concentrations at the surface of a sediment measured over the course of four hours during sunset at an intertidal flat in the Wadden Sea (Belum; Lower Saxony, Elbe estuary). The measurements were started 2.5 hours before low tide. At the beginning of the measurements concentrations of $0.11 \mu\text{g cm}^{-2} \pm 0.03$ were detected which increased continuously over exposure time to values of $0.25 \mu\text{g cm}^{-2} \pm 0.08$ at just around low tide. Right before the tide came in, the concentrations at the sediment surface decreased to values of $0.14 \mu\text{g cm}^{-2} \pm 0.04$ and this phenomenon was related to the migration behaviour of benthic microalgae, a means of escaping erosion by tidal movement. Thus, the migration of the algae to and from the sediment surface from deeper layers was successfully monitored using the new probe. Thus, the probe could be used for this form of temporal resolution and indicates that it will be useful at differentiating successional switches in algal groups at the sediment surfaces over the course of the daily light rhythms.

3.4 Discussion

It was our aim in this work to apply the concepts of multialgal fluorometry (Beutler et al., 2002b) to a benthic probe. Taking into account the variety of sediments measured under laboratory and under field conditions, the applicability of the probe in determining algal populations on sediments in situ was successfully tested. However, we also found that calibrating such a device is far from trivial and should ideally be an ongoing process. It could be conceived that a data bank of measurements (should) be automatically set up in the instrument software with exact chlorophyll concentrations (measured by HPLC) in the uppermost 0-200 μm of sediments and ideally also with cell counts, whereby the weighting factors for the algorithms be reevaluated to suit a scientists system. The data also shows that at higher chlorophyll concentrations (above $2 \mu\text{g cm}^{-2}$) which was less than assumed after the initial laboratory calibrations, in the surface layers the device becomes unreliable. It should be investigated if this problem could be alleviated by using a linear fit at lower concentrations and an exponential fit at higher concentrations.

The preliminary calibration of such a device should be with mean factors for as many benthic algal mats on and as many different substrates as possible. It does not suffice to calibrate it with the usual algal standards or against a standardized instrument as is often carried out for pelagic multialgal fluorometers. Under no circumstances should the device be calibrated using wet chemical analytical techniques for chlorophyll estimation as these methods are, particularly for sedimentary systems, extremely prone to error (see Wiltshire, 2000).

Our approach can be used to monitor algal assemblage composition on sediments and it is an ideal tool for investigations on large-scale spatial and temporal variation of algal

populations in sediments. It was, until now, not possible to carry out such detailed investigations of algal assemblage structures in surface sediments within a reasonable time frame. All measurements on sediments, apart from PAM measurements (Barranguet & Kromkamp, 2000; Serodio et al., 2001; Glud et al., 2002), are retrospect and even PAM measurements do not allow differentiation of algal populations. The results, particularly of long-term sediment mesocosm experiments, show that the domination of algae in sediment assemblages change rapidly (weeks) and that they not only comprise diatoms, which is often assumed. Past research showed that strong seasonality patterns occur in microphytobenthic communities and that, under certain circumstances, Cyanobacteria and chlorophytes can contribute to large amounts to the sediment microflora (Agatz et al., 1999; Riethmueller et al., 2000). Thus, the current resolution of three algal groups is useful and it enables in situ differentiations of algal assemblages. However, the accuracy of the algal group differentiation is probably limited by the species-dependent variability within each individual algal group and by the influence of environmental factors on the fluorescence yield.

Apart from the advantages of in situ differentiation and determination of total algal biomasses, we with this device could rapidly discern differences without having to wait for the analyses. The latter is always a nuisance, as it doesn't allow for experimental rethinking.

Furthermore, with its in situ practicality the sensor was well suited to monitoring migration events of microalgae to and from the sediment surface, from deeper layers. This has been done a few times using reflectance measurements (Paterson et al., 1998) and fluorescence measurements (Mazel, 1997). However the methods used were cumbersome. Our probe will also be useful when it comes to differentiating different tidal and diurnal succession of populations, i.e. the replacement of diatoms at a sediment surface during the course of exposure by green algae or Euglenids (Paterson et al., 1998). The sensor could be used for long-term measurements (monitoring) of chlorophyll *a* concentrations related to different spectral groups of algae in sediments over large spatial and temporal scales. This would be of considerable use in ground-truth measurements in remote sensing.

Conclusions

Our new method represents a unique approach to the qualitative and quantitative assessment of microphytobenthos in situ, with high spatial and temporal resolution, enabling a rapid evaluation of the community structure and its distribution. In addition, the new method can serve as a tool for long-term experimental investigations. In our case a marine and freshwater mesocosm experiment served as an ideal experimental unit to test this technique under laboratory conditions prior to field deployments. We, thus, believe that our approach will become an important new tool in aquatic benthic ecology and in the management of benthic aquatic resources. We also envisage that the device could be implemented on

Landers in the submerged intertidal or in shallow lake systems were benthic microphytobenthic communities are a rather underestimated but highly productive community. Further developments and measurement refinements will permit a more detailed classification of algal groups in future.

Chapter 4

Microcosm experiments on grazing efficiency and selectivity of the freshwater hydrobiid snail *Potamopyrgus antipodarum* preying upon microphytobenthic assemblages.

In this chapter I focused on grazer effects of the freshwater hydrobiid snail *Potamopyrgus antipodarum* preying upon microphytobenthos. To quantify grazing efficiencies, feeding preferences and to evaluate the controversially discussed turning points between positive and negative effects of grazer activity were of special interest in this study.

4.1 Introduction

Benthic microalgae contribute significantly to the primary production of shallow aquatic systems and serve as an ideal diet for a large variety of small-sized grazing biota (protists, meio- and macrofauna). Microalgae therefore play an important role in benthic food webs, either as epiphytes or as sediment algae. Studies of grazing interactions between microalgae and invertebrates have played a major role in aquatic ecology for decades (Asmus & Asmus, 1985; Blanchard, 1991; Miller et al., 1996; Montagna et al., 1995; James et al., 2000a). Numerous investigations have been conducted in order to obtain an insight into food-web structures in freshwater systems. Most of these studies have focused on the role of grazer-microalgae interactions in pelagic ecosystems. In contrast, benthic food-webs are still poorly understood. This is especially true for sediment microflora assemblages. In addition, although having been often studied in marine systems we know virtually nothing about freshwater microphytobenthic assemblages (Lowe, 1996; Cyr, 1998; Nozaki et al. 2003).

In our study we focused on the impact the gastropod grazer *Potamopyrgus antipodarum* on natural microphytobenthic sediment communities from lake Schöhsee (Plön, Germany) as these are one of the dominant grazers in this lake. In order to quantify their grazing efficiency and to investigate feeding preferences, small-scale laboratory experiments with varying grazer densities and different incubation times were carried out.

Past investigations on grazer-microalgae interactions have provided contradictory results as far as the positive and negative effects of grazing invertebrates on microphytobenthic communities are concerned (Underwood & Thomas, 1990). The literature to date is controversial and can be divided into three categories: reduction or increase of cell numbers and biomass, chlorophyll densities as well as abundances and diversity of particular species or of whole algal communities. In some cases a negative effect on microphytobenthos could be detected as a decrease of chlorophyll content (Cattaneo, 1983; Lamberti & Resh, 1983) or of algal cell numbers or of biomass (Castenholz, 1961; Kesler, 1981; Lamberti & Resh, 1983; Underwood & Thomas, 1990; Hillebrand et al., 2002). In contrast, other studies showed positive, beneficial effects of grazing activities which resulted in increased diversity of algal assemblages (Sumner & McIntire, 1982; Eichenberger & Schlatterer, 1978) or an increase in abundance of particular algal taxa (Hunter, 1980; Jacoby, 1987; Lamberti & Resh, 1983). The fertilizing effect on microalgal assemblages resulting from grazer activities can be explained by an increased nutrient supply. This can be triggered by several mechanisms (McCormick & Stevenson, 1991). Grazers may increase nutrient diffusion while physically destroying the structure of the uppermost surface layer and thus facilitating nutrient release from deeper sediment layers (Wetzel, 1996). They can also cause this release by removing senescent cells (Hillebrand & Kahlert, 2001), by sloppy feeding and

adding nutrients via their excretion products (Kahlert & Baunsgaard, 1999; Mulholland et al., 1991). Moreover this, the diverse array of effects is dependent on specific grazer types and densities which can be directly related to the feeding mode of the animals. Grazing invertebrates preying on benthic microalgae comprise a large group of organisms ranging from the very small protists to larger-sized gastropods and crustaceans. Apart from their size ranges, they differ considerably in their feeding habits since they are characterized by specialized mouthparts and feeding techniques. Crustaceans like isopods or amphipods, for example, have specific mandibles which allow them to shred larger food items and also to choose between algae and detritus (Moore, 1975; Friberg & Jacobsen, 1994; Constantini & Rossi, 1998; Duffy & Hay, 2001). Gastropods are known to be very efficient grazers on biofilms, since they are able to reduce algal biomass with their radulas on a larger spatial scale although rather unselectively (Nicotri, 1977; Hunter, 1980; McCormick & Stevenson, 1991; Sommer, 1997). However, feeding specializations not only exist between, but also within these groups. For example nematodes are known to have very specialized mouthparts ranging from a pipette-like mouth specialized to suck in bacteria and small microalgae to a toothed pharynx in order to crack larger food items (Wieser, 1953; Jensen, 1987).

The primary aim of this study was to quantify the gastropods grazing efficiency and to detect selectivity patterns. Moreover, the points at which positive and negative effects of grazer activity were switched and also correlations between biovolume, morphology or motility of special algal taxa in case of feeding preferences were of particular interest to us in this study.

4.2 Material & Methods

Experimental design

Laboratory grazing experiments with varying grazer densities and at different incubation times were conducted in July and November 2001 with natural sediments from a freshwater lake (Schöhsee, Plön, Germany). Rectangular tanks with a surface area of 106 cm² (8.5 x 12.5 cm) served as experimental units. The sediments used, contained natural microphytobenthic communities taken from a sandy site in the littoral zones of the Schöhsee at 0.5 m depth. Prior to the experiments the sediments were sieved with a 1000 µm sieve in order to remove macrofauna. The aquaria were then filled with this sieved sediment and water from the Schöhsee and left undisturbed for 24 hours. In the Schöhsee *P. antipodarum* is one of the most important benthic grazers reaching abundances of 200 individuals m⁻². Therefore this species was chosen as the consumer for the experimental units. The individuals were hand-picked from natural sediments, sorted by size class into petri-dishes and stored overnight at 17°C without any food source. As a grazer fraction individuals with a shell length of 3 mm were used. Three different experimental considerations existed: start (t₀), grazer treatments (+GR) and grazer-free controls (ctrl). Each treatment was replicated

three times. The experimental set-up followed a randomised design. During the first experiment (Experiment I, July 2001) an incubation time of 24 hours was chosen whereas the second experiment (Experiment II, November 2001) was conducted at two incubation intervals (24h and 48h) in order to achieve a higher temporal resolution of grazer effects. The light regime was kept constant at a 12 hours day-12 hours night-cycle. At the beginning of the experiment the initial starts (t_0) were sampled and grazers were subsequently added to the grazer units. Grazers were added at relatively high densities (approximately four to eight times the maximum field densities) to ensure that short-term grazer effects would be detected. A grazer density of seven *P. antipodarum* (700 individuals m^{-2}) was chosen during the first experiment in July 2001 and 15 individuals (1500 individuals m^{-2}) were used during the November experiment.

Sample processing

The determination of microalgal distribution, cell density and chlorophyll *a* content was carried out using one Cryolander-core with a surface area of 18 cm^2 (\varnothing 4.8 cm) which was sampled from each treatment following the method described by Wiltshire et al. (1997). Each cryo-preserved sediment disc was cut into six equal subsamples whereas three of each of the subsamples were used either for chlorophyll *a* measurements or for light-microscope analyses. The sediment surface of each sample was sliced at 60 μm intervals with a Cryomicrotom (Leica CM 1900) down to a depth of 480 μm and this sediment horizon was also used for further analyses. Chlorophyll sample processing and HPLC analyses followed the method of Wiltshire (2000). For cell counts and microalgae determination the prepared sediment layers were preserved with Lugol's solution, inserted into a Sedgewick-Rafter counting chamber and counted under an inverted light microscope.

Grazing rates were calculated from the equation: $\lambda = \mu - r$ whereas λ is the grazing rate (hr^{-1}), μ the gross growth rate and r the net gross rate. The standard deviations are indicated by the symbol \pm in the text.

To test for significant differences in chlorophyll contents, a full-factorial ANOVA and Tukeys HSD-Test were used. In the case of total cell numbers a full-factorial ANOVA and a Duncan Post hoc-Test were applied. Diversity indices were calculated by using PRIMER 5.2 (© 2001 Primer-E Ltd.). Diversity (H') was measured by the Shannon-Weaver function: $H' = -\sum (P_i * \log_e P_i)$ whereas $P_i = n_i/n$ (n_i is the number of individuals from one particular species, n the total number of individuals of all species (Shannon and Weaver, 1963). The Evenness (E) was calculated by using Pielou's Evenness: $E = H' * \log S$ whereas S is the total number species (Pielou, 1969).

4.3 Results

Total chlorophyll a contents

Experiment I

During the first grazing experiment the highest total chlorophyll *a* contents of $0.65 \mu\text{g cm}^{-2} \pm 0.14$ and $0.34 \mu\text{g cm}^{-2} \pm 0.04$ were measured at the beginning of the experiment (t_0 ; 0-240 μm and 240-480 μm respectively) (figure 1A). The control units showed a significant decline in chlorophyll *a* content at the sediment surface when compared to t_0 ($p = 0.0002$). No significant difference could be detected for surface chlorophyll concentrations of the starts and the grazer treatments. Chlorophyll *a* contents of the deeper sediment horizons remained constant within all the three different treatments and showed a significant decrease with increasing sediment depth in the start samples ($p = 0.0004$).

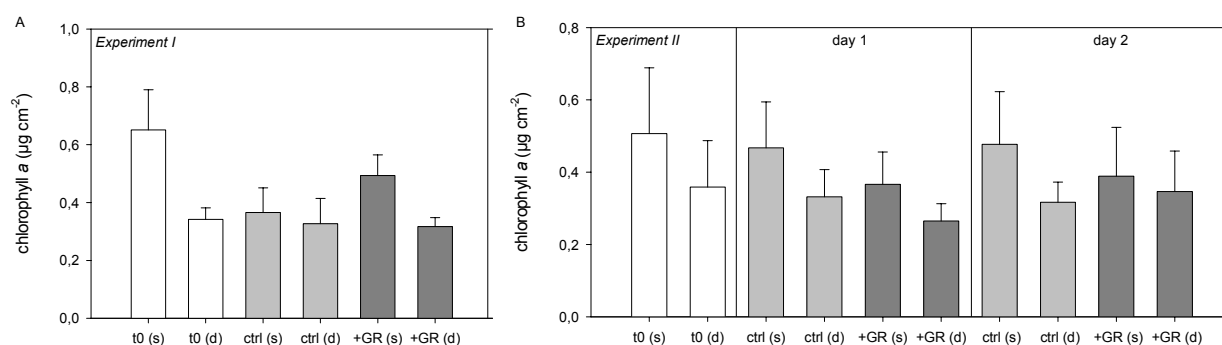

Figure 1: A) Chlorophyll *a* concentrations ($\mu\text{g cm}^{-2}$) at the top surface layer (s; 0-240 μm) and the deeper layer (d; 240-480 μm) in the start (t_0), control (ctrl) and grazer treatments (+GR) of Experiment I after one day of incubation. B) Chlorophyll *a* concentrations ($\mu\text{g cm}^{-2}$) at the top surface layer (s; 0-240 μm) and the deeper layer (d; 240-480 μm) in the start (t_0), control (ctrl) and grazer treatments (+GR) of Experiment II after day 1 and day 2 of incubation.

Experiment II

At the beginning of the second grazing experiment the initial values of chlorophyll *a* were similar to those of Experiment I with values of $0.51 \mu\text{g cm}^{-2} \pm 0.18$ (figure 1B). After the first and the second day of the experiment the values of the control units remained constant when compared to t_0 . A slight decrease in chlorophyll *a* contents was detected for the grazer treatments with chlorophyll contents reaching values of $0.26 \mu\text{g cm}^{-2}$ (day 1) and $0.39 \mu\text{g cm}^{-2}$ (day 2). However this decline was marginally not significant.

Total cell numbers

Experiment I

Total cell numbers at the sediment surface (0-240 μ m) showed similar values at the beginning of the first grazing experiment (72.9 cells cm⁻² \pm 25.7) when compared to the control units (70.8 cells cm⁻² \pm 30.5) (figure 2A). In the presence of grazers a significant decline of cell numbers could be detected within the uppermost surface layer (26.3 cells cm⁻² \pm 2.3) when compared to t0 and control treatments ($p < 0.05$). The cell numbers at 240-480 μ m sediment depth showed similar patterns and reflected the same trends for surface sediments.

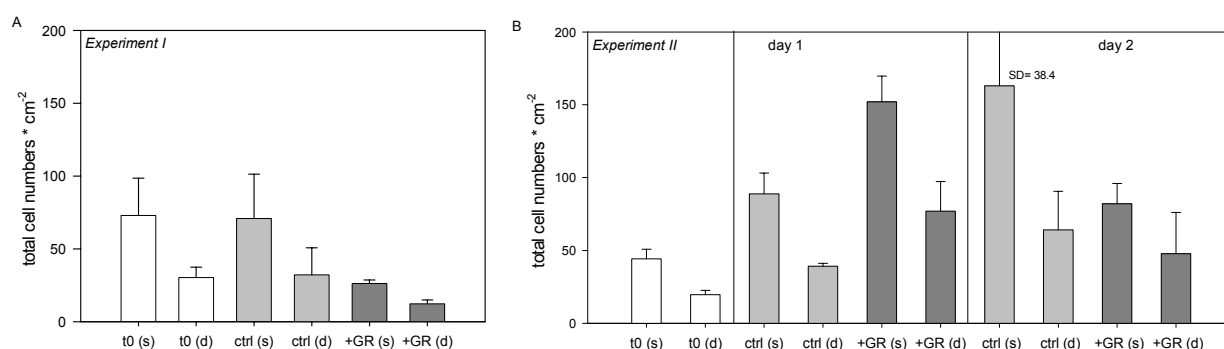

Figure 2: A) Total cell numbers (per cm²) at the top surface layer (s; 0-240 μ m) and the deeper layer (d; 240-480 μ m) in the start (t0), control (ctrl) and grazer treatments (+GR) of Experiment I after one day of incubation. B) Total cell numbers (per cm²) at the top surface layer (s; 0-240 μ m) and the deeper layer (d; 240-480 μ m) in the start (t0), control (ctrl) and grazer treatments (+GR) of Experiment II after day 1 and day 2 of incubation.

Experiment II

Unlike in the first grazing experiment in comparison to cell numbers at the beginning of the experiment, a significant increase in cell numbers in both sediment layers was detected in the control and the grazer treatments (day 1; $p < 0.05$; figure 2B). In addition, the surface layers of the grazer treatments showed significantly higher cell numbers after 24 hours when compared to the control units ($p = 0.002$). On the second day of the experiment the cell numbers in the absolute surface layer of the control treatments had increased significantly when compared to the first day of incubation ($p = 0.0004$). A maximum of 163.1 cells cm⁻² \pm 38.4 was reached. In contrast, cell numbers at the sediment surface of the grazer treatments decreased significantly after two days ($p = 0.0001$) to fairly low numbers (47.7 cells cm⁻² \pm 28.4).

Taxa composition

The analyses of the algal assemblages revealed five major taxonomic groups in both grazing experiments: *Pinnularia* sp., *Stauroneis* sp., *Cymbella* sp., *Synedra* sp. and *Amphora* sp.. The genus *Caloneis* sp. was abundant during the second grazing experiment. Both experiments showed great differences as far as grazing effects and the influence of grazers on different taxonomic groups are concerned.

Experiment I

During the first grazer experiment all algal taxa showed a decrease in cell numbers when grazers were present. In some cases the reduction of cell numbers within the grazer treatments was more than 50% compared to the controls (*Stauroneis* sp., *Synedra* sp., *Caloneis* sp., *Amphora* sp.; figure 3A). When comparing the initial cell numbers with the numbers detected within the control treatments it becomes clear that only few genera managed to increase their cell numbers within one day of incubation (*Stauroneis* sp., *Diploneis* sp., *Amphora* sp.). All other genera showed declining values when compared to the start samples. In addition, the alga *Surirella* sp., present in the start and in the control treatments at low abundances, disappeared completely in the presence of grazers.

Experiment II

During the second grazing experiment, with 15 grazers present, contrasting trends were seen. All major algal groups showed highest cell numbers within the grazer treatments after one day when compared to the control treatments or the start values (especially the genera *Pinnularia* sp., *Stauroneis* sp., *Cymbella* sp., *Synedra* sp., *Diploneis* sp. and *Amphora* sp.; figure 3B). These patterns changed after two days and decreasing cell numbers within the grazer treatments were detected. However, when compared to the first grazing experiment

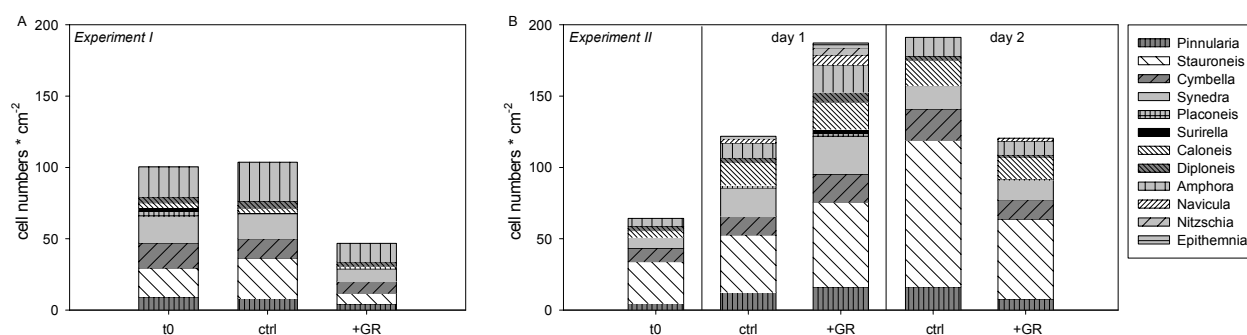

Figure 3: A) Taxonomic composition of the microphytobenthos in Experiment I. The proportions of each genera are given as relative cell numbers * cm⁻² in the start (t0), control (ctrl) and grazer treatments (+GR) after one day of incubation. B) Taxonomic composition of the microphytobenthos in Experiment II. The proportions of each genera are given as cell numbers * cm⁻² in the start (t0), control (ctrl) and grazer treatments (+GR) after day 1 and day 2 of incubation.

the overall reduction of cell numbers was less clear for the second grazing experiment, even though the grazer abundance was higher. The control treatments showed increasing cell numbers for both incubation days and the highest cell numbers were detected after the second day. In this regard, *Stauroneis* was by far the fastest growing genera.

Grazing rates

The grazing rates calculated for every single algal group were higher for the first grazing experiment (Experiment I, day 1) compared to the second experiment (figure 4). During the first incubation all nine algal groups were grazed by *P. antipodarum* whereby the highest grazing rates were detected for *Surirella sp.*, *Stauroneis sp.*, *Placoneis sp.*, *Caloneis sp.* and *Amphora sp.*. In contrast to the first grazing experiment, the second experiment showed different temporal trends and grazer efficiencies. Even though grazer abundance was higher within the second experiment, negative grazing rates were calculated for all taxonomic groups after the first day of incubation. This amounted to an overall positive effect on the

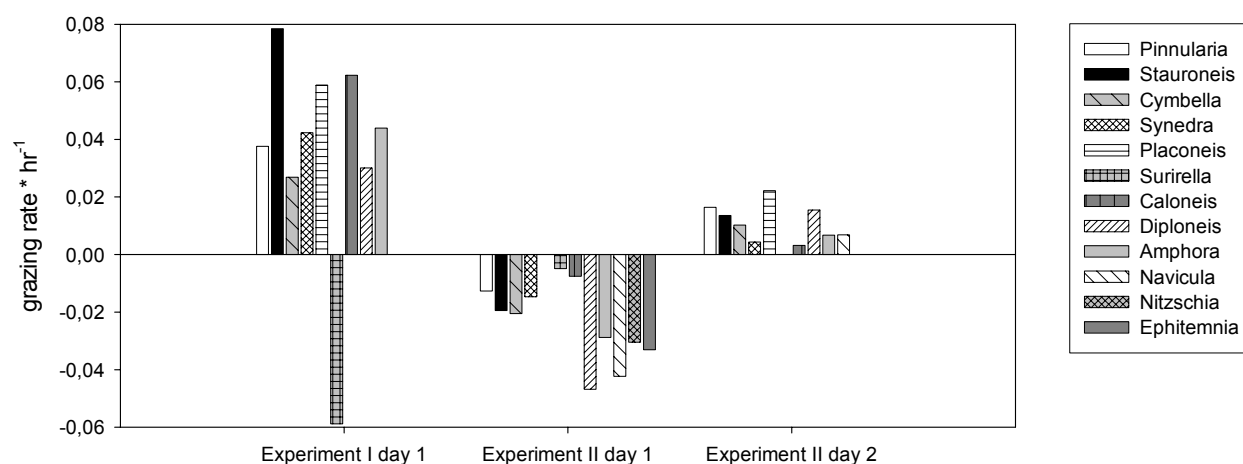

Figure 4: Grazing rates λ (hr^{-1}) detected in the grazer treatments (+GR) of Experiment I (day 1) and Experiment II (day 1+2).

total algal community within the grazer treatments. *Diploneis sp.* and *Navicula sp.* were the genera that benefited most. After two days of incubation a shift from negative to positive grazing rates was observed for all taxonomic groups. The whole algal community was thus reduced by grazer activity.

Diversity and Evenness

The diversity index H' showed slightly higher values at the beginning of the first grazing experiment ($H' = 1.8 \pm 0.1$) when compared to the second experiment ($H' = 1.6 \pm 0.2$). During the first experiment the diversities decreased in the control and the grazer treatments and reached similar values of 1.6 ± 0.1 and 1.7 ± 0.2 (figure 5A). Different diversity patterns were observed during the second experiment, where diversities first increased after the first day of incubation in the grazer and the control treatments and then declined by day 2 (figure 5B).

Despite the different trends in diversity, Pielou's Evenness showed very similar values both for the first and the second grazing experiment. The evenness at the beginning of the experiments were almost identical with values of 0.9 ± 0.03 (Experiment I) and 0.8 ± 0.1 (Experiment II). All through the experiments, the evenness remained constant and no differences between treatments were seen.

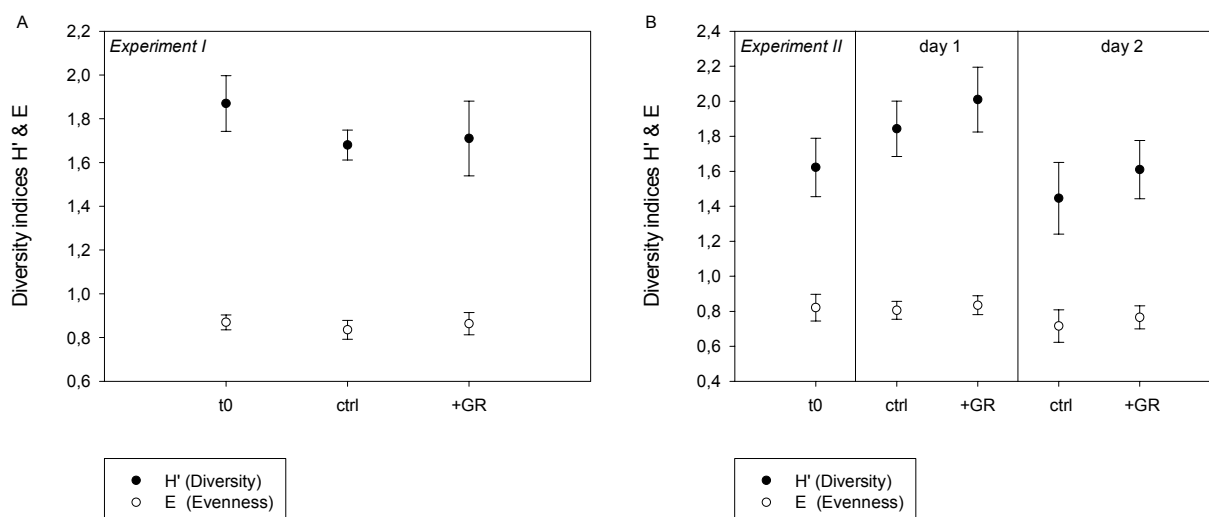

Figure 5: A) Diversity indices H' (Diversity) and E (Evenness) in the start (t_0), control (ctrl) and grazer treatments (+GR) in Experiment I after one day of incubation. B) Diversity indices H' (Diversity) and E (Evenness) in the start (t_0), control (ctrl) and grazer treatments (+GR) in Experiment II after day 1 and day 2 of incubation.

4.4 Discussion

Although past research has provided extensive information on grazer-microalgae interactions, the interplay between positive and negative effects still remains one of the most discussed research topics in benthic ecology (Underwood & Thomas, 1990). Since grazer effects are complex and variable, depending on grazer type, abundance as well as on external parameters, the ecological role of grazer activity cannot be generalized.

In our study, the chlorophyll concentrations at the beginning of each experiment were similar and therefore the initial conditions were comparable. However, in the presence of grazers only slight changes in chlorophyll contents at the sediment surfaces were found. This is in contrast to a variety of grazer studies that demonstrated clear decreases of chlorophyll *a* in the presence of gastropod grazers (Cattaneo, 1983; Lamberti & Resh, 1983; Jacoby, 1987; Hill et al, 1992). However, despite these differences, some studies support our findings. Hillebrand & Kahlert (2002), e.g., found contradictory grazer effects on sediment chlorophyll *a* contents for two freshwater sites in Sweden. Interestingly also, in contrast to the freshwater habitat lake "Erken", the chlorophyll *a* concentrations at their brackish site "Väddö" were completely unaffected by grazer presence even though gastropod abundances were higher than for the brackish habitat. Hunter (1980) has also described increasing chlorophyll *a* contents in the presence of gastropod grazers and concluded that grazing proportionally increases primary productivity. Our results show that the chlorophyll contents at the sediment surface remained almost unaffected by grazing. This is quite astonishing since clear feeding tracks from the gastropods' radula were visible on the sediment surface and therefore decreasing chlorophyll concentrations could have been expected. Chlorophyll contents are known to provide only rough estimates for the determination of grazing activity since the amount of chlorophyll in the algal cells is known to be highly variable and dependent on a variety of parameters, e.g. light and physiological status (Wolff, 1979; De Jonge & Colijn, 1994). Furthermore, the accuracy of chlorophyll determination depends also on the methods used, since spectrophotometric measurements don't differentiate for breakdown products while HPLC-analysis does. Thus, detecting grazer effects from chlorophyll *a* measurements only, may lead to an underestimation of algal consumption and a misjudgement of the actual grazer efficiency.

In contrast to chlorophyll *a* contents, the total cell numbers at the sediment surface fluctuated depending on grazer densities and incubation time. A significant decline of cell numbers in the presence of grazers occurred during the first experiment after an incubation time of 24 hours, whereas the second experiment revealed a sharp increase in cell numbers over the same time period. After two days this pattern changed and a significant grazer effect on cell numbers was detected. These contradictory effects seem common in studies on gastropod grazing. Most studies report a high grazing efficiency of gastropods resulting mostly in a significant decrease in cell numbers and biomass (Nicotri, 1977; Sumner & McIntire, 1982; Lamberti & Resh, 1983; Underwood & Thomas, 1990; McCormick & Stevenson, 1991; Hillebrand & Kahlert, 2001). However, grazing may benefit both the algal community as a whole or individual species, as the presence of herbivore invertebrates may increase the diversity and the abundance of certain species (Nicotri, 1977; Hunter, 1980; Sumner & McIntire, 1982; Jacoby, 1987; McCormick & Stevenson, 1991). The reasons for these

diverse effects are still a main focus of studies in benthic food web ecology and it is often assumed that these patterns are mainly caused by selective or differential grazing. However, other mechanisms such as those involved with the exchange of nutrients between the invertebrates and the algae must also be considered. It has been shown that grazing pressure on microalgal assemblages can result in increased nutrient content or productivity of algal cells (Lamberti & Resh, 1983; McCormick & Stevenson, 1991; Hillebrand & Kahlert, 2001). This positive effect of consumers on their prey can be the result of the excretion of nutrients, the removal of senescent cells, or increased uptake of nutrients by the remaining cells (Lamberti et al. 1987; McCormick and Stevenson, 1991; Hillebrand & Kahlert, 2001).

The hydrobiid snail *P. antipodarum* is known to be an effective grazer on benthic microalgal assemblages (Fenchel, 1975a; James et al., 2000a, b; Dorgelo & Leonards, 2001; Broekhuizen et al. 2002). In the Schöhsee *P. antipodarum* is one of the most important benthic grazers reaching abundances of 200 individuals m⁻². The natural densities are low compared to reports from James et al. (2000a) where *P. antipodarum*-densities of up to 1000 m⁻² were found (Lake Coldridge, New Zealand). In our experiments the grazers were added at relatively high densities to ensure the detection of short-term grazer effects, but not unnaturally, so the densities were similar to those reported by James et al. (2000a).

In general, the grazing efficiency is considered to be closely related to consumer density. Steinman et al. (1987) and McCormick & Stevenson (1991), e.g., reported strong density-dependent effects of grazer abundances on algal biomass, taxonomic composition and physiognomic properties in the presence of gastropod and caddisfly predators. Our results do not show such clear density-related trends but rather indicate a switching of positive and negative effects on algal assemblages in relation to grazer numbers and incubation time. At low grazer densities, an immediate reduction of cell numbers to more than 50% of the available biomass was detected. However, an increase in grazer densities initially showed an inverse correlation with algal abundances and a fertilizing effect on microalgal assemblages was revealed. This positive trend on the total algal community disappeared over the duration of the experiment and effective grazing could be detected after two days of incubation. As already mentioned before, our results are in good correspondence to grazing patterns found by Hillebrand & Kahlert (2002) since they detected no direct correlation to grazer density either. Thus, the relation between grazing efficiency and consumer densities seems to be a highly complex interplay and the turning points between the positive and negative effects are hardly to define.

In our study, both grazing experiments showed very similar taxonomic compositions and diversities. The algal assemblages were dominated by the same five major taxonomic groups within both grazing experiments and only the genus *Caloneis* sp. showed higher densities during the second grazing experiment. The diversity indices H' and E showed no significant

differences for the different treatments and both experimental approaches. As already mentioned before, intermediate grazer abundances are known to favour nutrient availabilities at the sediment-water interface to some extent. High nutrient supplies on the other hand are known to function as triggers for decreasing diversity in microalgal communities (Sullivan, 1976; Carrick et al. 1988; Hillebrand & Sommer, 1997) and therefore our constant diversity variables seem contradictory. However, there are a variety of other studies which have postulated both increases or decreases of algal diversity in the presence of grazers (Sumner & McIntire, 1982; Jacoby, 1987; McCormick & Stevenson, 1989; Underwood & Thomas, 1990). Thus diversity shifts caused by grazer activity seem complex. Our results do not indicate grazer-related diversity changes. Although the algal community as a whole was obviously not effected by grazing pressure, individual taxa showed positive or negative trends when consumers were present.

Taxonomic compositions of algal assemblages are often considered to be a function of grazer selectivity. Selective removal of algal cells is assumed to be facilitated by morphological and size-dependent features (Nicotri, 1977; Hunter, 1980; McCormick & Stevenson, 1991). McCormick & Stevenson (1989), e.g. reported that stalked and loosely attached forms were more susceptible to snail grazing than firmly attached, prostrate algae. In addition, they indicated that grazers stimulate the growth of understory species by removing overlying cell assemblages. However, our experiments revealed that sometimes the same taxonomic groups benefited from grazing activity while in other cases they were strongly preyed upon. For example, the large-sized genera *Stauroneis sp.*, *Amphora sp.*, *Synedra sp.* and *Cymbella sp.* were highly reduced in their abundances during the first experiment while in the second grazing experiment it was shown that after one day the same genera benefited most from grazing activity.

These distinct grazing differences compared to other studies may originate from the differences in microalgal assemblages investigated. All of the studies in the literature focused on periphyton communities. Microphytobenthic assemblages on unstable substrates such as mud and sand, have been neglected. In contrast, to epi- or periphyton communities where a distinct three-dimensional layer is usually developed, these patterns are missing on microphytobenthic biofilms and only few erect forms are present. The microphytobenthos is usually characterized by prostrate diatoms, forming distinctly flat, two-dimensional communities (Miller et al., 1987). Therefore, it is not astonishing that most of the dominant taxa in our experiments fall into the category of prostrate forms, living closely attached to sediment particles. These were in particular *Pinnularia sp.*, *Stauroneis sp.*, *Amphora sp.*, and *Cymbella sp.*, the major taxonomic groups that were mainly affected through grazer activity. In addition, it has to be pointed out, that stalked or erect forms were a minor component of the algal assemblages and most of the characteristic taxa forming three-dimensional

communities were completely missing (e.g. *Gomphonema sp.*, *Diatoma sp.*, *Fragilaria sp.*, *Melosira sp.*). The only erect form that was present in considerable amounts was the genus *Synedra sp.*. This microalgae has the ability to stick to surfaces by forming mucilage pads and therefore it is the only stalked form that could have shown a higher susceptibility to snail grazing due to its morphological habits. When comparing the grazing efficiency on prostrate forms versus stalked forms in our experiment, it becomes apparent that both forms were preyed upon similarly. Furthermore, *Synedra sp.* was reduced only slightly, especially during the second grazing experiment. However there is one feature that connects all major taxonomic groups and this is their size range. Each of these algal groups is characterized by relatively high biovolumes when opposed e.g. to *Navicula*- or *Nitzschia*-species. This facilitates their potential as food sources and makes them an easy prey for consumers. This is especially evident in case of the gastropods' bulldozer-like feeding mode which characterizes them as rather unselective grazers but with a large spatial efficiency (Sommer, 1997).

Conclusions

In this study we have shown that the gastropod *P. antipodarum* can have both positive (fertilizing) and negative effects on microphytobenthic algal biomass. The diversity of the algae remained unaffected by these snails alluding to their unselectivity and the fact that microalgal morphology and growth form was unimportant. This is in contrast to periphyton communities where morphological habits play a major role in grazer-microalgae interactions and thus these results provide evidence for predominately size- and density-dependent grazing patterns in microphytobenthic communities dominated by *P. antipodarum*.

Chapter 5

Factors influencing microphytobenthos community structures beneath macrophyte beds- a marine and freshwater mesocosm study.

This chapter focuses on the impact of the sediment microflora beneath and adjacent to macrophyte beds and on the functional role of several herbivore species in influencing ecosystem processes in vegetated subtidal habitats. The aspects of constantly high nutrient loads, taxonomic composition shifts and competitive interactions are discussed.

5.1 Introduction

Macrophyte beds in shallow aquatic areas constitute extremely productive ecosystems. The main contributors to the high productivity are vascular plants and, associated with them, microscopic algae living closely attached to macrophyte leaves. In addition, the sediment microflora covering the sediments beneath and adjacent to the macrophyte beds play an important role. Apart from their major importance as primary producers these systems are characterized by a high biodiversity as they function as a habitat for many invertebrate and small vertebrate organisms. This plants and microalgae association plays an important role within the benthic food web and as sediment stabilizers in highly dynamic systems. Recent studies indicate that epiphytic and microphytobenthic microalgae were by far the most important primary productivity component within macrophyte beds contributing up to 87% of the total primary production of the system (Moncreiff et al, 1992; Moncreiff & Sullivan, 2001). Research has shown that the plant-associated microflora can be considered the major food source in this community. Unlike macrophyte leaves and detritus, they represent a reliable and highly nutritious diet (Fry & Sherr, 1984; Kitting et al. 1984; Plante-Cuny & Plante, 1984; Decho & Fleeger, 1988; Jernakoff et al. 1996; Moncreiff & Sullivan, 2001). Apparently, the main function of the vascular plant is to provide shelter and structure for associated organisms as well as to provide a source of detritus, while hardly contributing to the food web itself.

Until relatively recently, macrophyte beds and sediment communities have been universally studied as isolated habitats and the coupling between the plant-epiphyte community and the sediment microflora have mostly been neglected. However, studies have shown the relative importance of considering this habitat as a whole, instead of ignoring the microphytobenthos beneath and adjacent to macrophyte beds (Sullivan & Moncreiff, 1990; Moncreiff et al, 1992; Moncreiff & Sullivan, 2001).

From studies on macrophyte-epiphyte communities it is known that grazers activity maintains an intact macrophyte habitat (Orth & Van Montfrans, 1984; van Montfrans et al., 1984; Neckles et al, 1993; Jernakoff et al., 1996; Valentine & Heck, 1999; Heck et al., 2000). As long as light and nutrients are available in sufficient quantities, microalgae are considered to be more competitive than vascular plants and an increase in epiphytes can impede the growth of the macrophyte hosts (Worm & Sommer, 2000). Consequently, grazing by macro- or meiofaunal invertebrates plays an important role in regulating microalgal growth and thus contribute to the stability of the system (Orth & van Montfrans, 1984; van Montfrans et al., 1984; Neckles et al, 1993). Similar patterns have been shown in studies dealing with periphyton and microphytobenthic communities (Sumner & McIntire, 1982; Lamberti & Resh, 1983; McCormick & Stevenson, 1991; Kahlert & Baunsgaard, 1999). Most of the former experimental studies have considered the grazer community to be a relatively homogeneous

functional group grazing unselectively on microalgae and detritus (Edgar 1990; Jernakoff et al, 1996) thus, there are strong seasonal and spatial variations in grazer assemblages in the field. Conversely other investigations showed differences in feeding preferences and selectivity by grazing organisms and governing roles of particular taxa have also been detected (Duffy & Hay, 1994; Brendelberger, 1995; Jernakoff & Nielsen, 1997; Sommer, 1997; Duffy & Hay, 2000).

The aim of our study was to simulate freshwater and marine macrophyte bed assemblages under controlled conditions in order to study the impact of different macrograzers on the macro- and microfloral community. We wished to evaluate the importance of the sand microflora beneath and adjacent to the macrophyte beds in particular. To this end, we used freshwater and marine mesocosm experiments to test the influence of the most common grazing invertebrates on microphytobenthic communities within macrophyte beds.

5.2 Material & Methods

Experimental design

In summer 2002 marine and freshwater laboratory mesocosm experiments were set up. The experiments were run using nine plastic tanks (117 x 93 x 60 cm; see sketch 1).

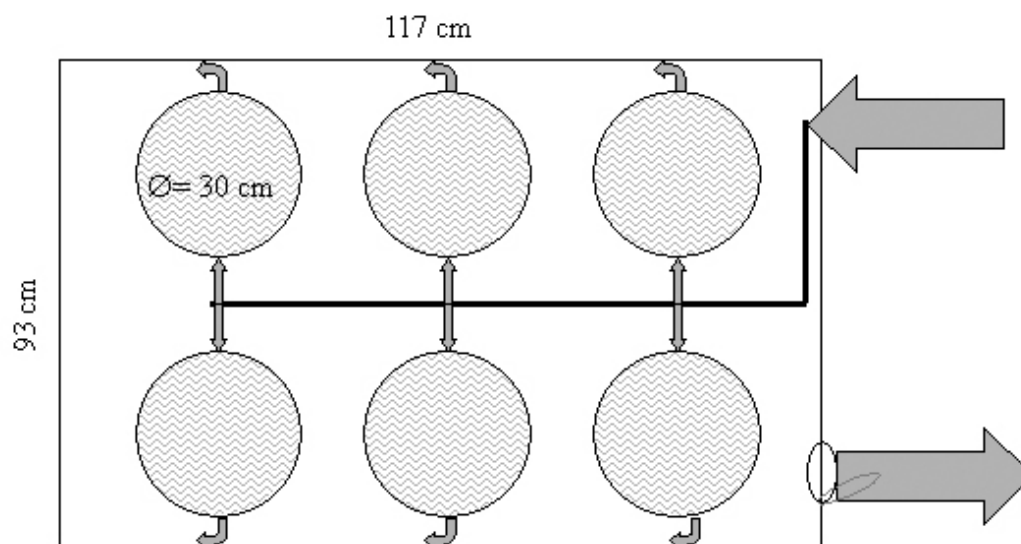

Sketch 1: Experimental set-up of the mesocosms. Circles present the six sub-units from each tank. Arrows show the water-flow direction and the irrigation system of the sub-units.

Each tank was split into six smaller mesocosm units, using cylindrical transparent plastics (BP Chemicals; \varnothing 30 cm, height: 60 cm; see sketch 2). The two experiments were conducted with 54 mesocosms for each experiment. Plastic trays (Gies, \varnothing 30 cm) were set up at the

bottom of each treatment, filled with 2000 μm -sieved sediment from the field in order to eliminate the presence of macroinvertebrate grazers. After the sediment had settled for 24h the experimental units were planted with freshly harvested and washed macrophytes. The marine experiments were planted with the seagrass *Zostera marina* and set up with sediments from patches within the same seagrass meadow from the Baltic site "Falkensteiner-Strand" in the Kiel Fjord. For the freshwater experiments we used the macrophyte *Potamogeton perfoliatus* and sediments from the Schluensee. Each unit was stocked with the same number of macrophytes as was known for the natural abundances at each site. *Z. marina* was planted at abundances of 20-23 shoots per unit (total plant length: 10 m) and *P. perfoliatus* with a total number of 5-6 plants per unit (total plant length: 1 m). After having planted the mesocosms the macrophyte-sediment-community was left undisturbed for four days.

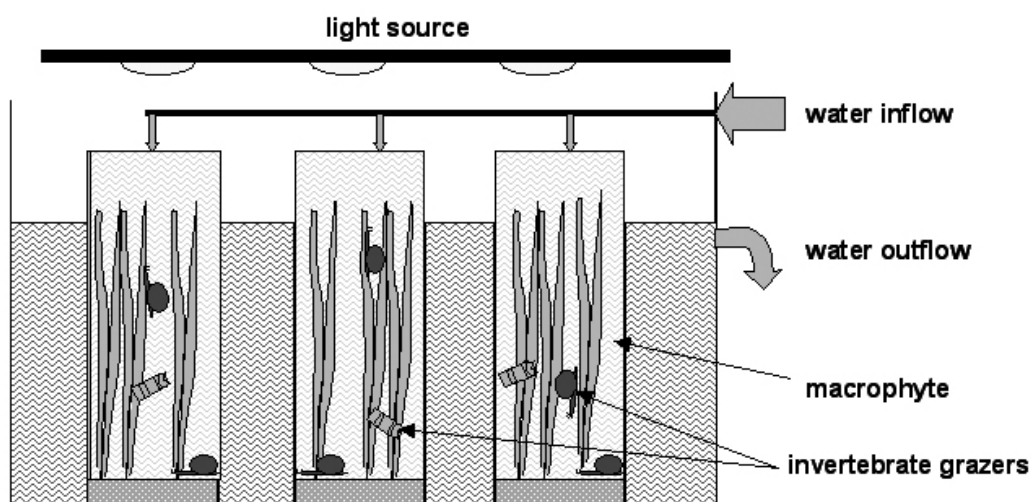

Sketch 2: Experimental set-up (side view) of the mesocosm units with grazer presence. Arrows present the water-flow direction.

Littorina littorea (Gastropoda), *Idotea balthica* (Isopoda) and *Gammarus salinus* (Amphipoda) were used as grazing organisms in the marine experiment. In the freshwater experiment we introduced *Radix ovata* (Gastropoda), *Asellus aquaticus* (Isopoda) and *Gammarus pulex* (Amphipoda) into the experimental units. In addition to the starts and the control treatments, seven different grazer-treatments were chosen (see table 1) in order to investigate the influence of the three different macroinvertebrate grazers.

Table 1: List of treatments and grazer combinations in the marine and the freshwater mesocosm experiments

	treatment	grazer combinations
Marine mesocosm experiment	start	-
	control	-
	I	<i>Idotea balthica</i>
	G	<i>Gammarus salinus</i>
	L	<i>Littorina littorea</i>
	IG	<i>Idotea balthica, Gammarus salinus</i>
	IL	<i>Idotea balthica, Littorina littorea</i>
	GL	<i>Gammarus salinus, Littorina littorea</i>
IGL	<i>Idotea balthica, Gammarus salinus, Littorina littorea</i>	
Freshwater mesocosm experiment	start	-
	control	-
	A	<i>Asellus aquaticus</i>
	G	<i>Gammarus pulex</i>
	R	<i>Radix ovata</i>
	AG	<i>Asellus aquaticus, Gammarus pulex</i>
	AR	<i>Asellus aquaticus, Radix ovata</i>
	GR	<i>Gammarus pulex, Radix ovata</i>
AGR	<i>Asellus aquaticus, Gammarus pulex, Radix ovata</i>	

The aim of this study was to induce effects of several grazer species on benthic algal biomass and community structure. The focus herein was to detect varying grazing patterns considering interspecific competition and grazer exclusion.

Grazer abundances introduced into the grazer treatments were related to natural abundances found by Jaschinski & Gohse-Reimann (pers. com.) for each natural site. The initial grazer biomass was 40 mg organic carbon in the marine treatments and 10 mg organic carbon in the freshwater mesocosms which is well within the range of field abundance. The number of grazers in the single grazer treatments, corresponding to 40 or 10 mg organic carbon, were 18 *I. balthica*, 25 *G. oceanicus* and 6 *L. littorea* in the marine experiment and 18 *A. aquaticus*, 18 *G. pulex* and 3 *R. ovata* in the freshwater treatments. Mixed-grazer treatments were stocked using a supplementary design whereby biomass of total numbers of grazers were kept constant and only fractions of total grazer numbers were used to achieve a total estimate of 40 or 10 mg organic carbon. Each treatment was replicated in three independent mesocosms in a randomised design. The marine as well as the freshwater experiments were sampled at the beginning of the experiment (time 0) and after seven and 21 days of incubation. The marine experiment was started on the 17th of July 2002 when grazers were introduced to the tanks and the last samples were taken after 21 days on the 8th of August 2002. The freshwater experiment was run straight after the marine experiment had finished and ran from the 22nd of August to the 12th of September 2002. The mesocosms were supplied independently with a constant flow of either sand-filtered brackish water from

the Kiel Fjord (salinity: $14.7 \text{ PSU} \pm 0.7$) or, in case of the freshwater mesocosms, with tap water. Water flowed out of each tank continuously through a hole, 2 cm in diameter, that was covered with a 1-mm plastic mesh. The light regime was adapted to summer conditions with a 16h day and 8h night cycle. Light intensities from the lamps above tanks ranged within treatments between $86.0 \mu\text{mol s}^{-1} \text{ m}^{-2} \pm 19.5$ at the water surface, $7.2 \mu\text{mol s}^{-1} \text{ m}^{-2} \pm 5.6$ at the sediment surface of the marine mesocosms and $33.4 \mu\text{mol s}^{-1} \text{ m}^{-2} \pm 12.0$ in the freshwater units. The temperature in the climate room was 17°C whereas water temperature in the mesocosms was slightly higher due to a heating-effect of the lamps; $18.3^\circ\text{C} \pm 0.5$ in the marine mesocosms and $18.0^\circ\text{C} \pm 0.2$ in the freshwater treatments. Nutrients from the inflow to the experimental units were determined daily using an auto-sampler from the Institute of Marine Science/Kiel using the methods of Grasshoff et al. (1983). In addition, pore water nutrient analyses from the sediment were performed at the end of each experiment. The nutrient data was provided by Jaschinski (unpublished data).

Sampling & sample processing

In order to sample sediment surfaces for chlorophyll *a* and cell counts two plastic tubes (Vol. 50 ml) were inserted into the freshly-sieved sediments of each tank prior to the regeneration period of the sediment-macrophyte regeneration time at the beginning of each experiment. The tubes (\varnothing 2.3 cm; height: 2.5 cm) had been cut off at the bottom and covered with a 500 μm plastic mesh in order to guarantee a transfer within the sediment column (see Chapter 2). The top of the tube was placed level with the surface of the sediment. Prior to the sampling, the tubes were closed *in-situ* with a screw-lid and could therefore be retrieved easily. Subsequently the sediment samples were preserved by using a slightly modified Cryolander-technique as described in Wiltshire et al. (1997). The Cryolander was placed on top of the sediment surface of each tube and some liquid nitrogen was dribbled onto the absorbent cotton in it. The liquid nitrogen was instantly vaporised due to the cottons' ambient temperature and the vapour froze the sediment surface without any distortion. Afterwards the entire sample was dropped into liquid nitrogen and subsequently stored at -80°C until further processing. The microslicing of the sediment surface and further pigment analysis was carried out using method Wiltshire (2000). Frozen samples were cut into 0.5 cm thin discs, placed on the stage of a freezing microtome (Leica CM 3050S) by using frozen oil and cut into slices at 125 μm intervals at an area of 1 cm^2 . The sediment layers were cut to a sediment depth of 0-500 μm and subsequently frozen in liquid nitrogen and then freeze-dried overnight. The pigment analysis of freeze dried sediment samples was conducted by using a Waters 910-HPLC-system. Details on extraction, gradients, flow rate etc. are given by Wiltshire (2000).

Statistics

To test for significant differences in chlorophyll *a* contents and cell numbers a full-factorial ANOVA and an LSD Post hoc-Test were applied. Diversity variables H' and E were calculated with PRIMER 5.2 (© 2001 Primer-E Ltd.) whereas diversity was based on the Shannon-Weaver function (H' ; \log_e) (Shannon and Weaver, 1963) and Evenness (E) on Pielou's Evenness (Pielou, 1969). The tests for significant diversity differences were performed by applying an ANOVA and LSD post hoc-Tests.

5.3 Results

Marine mesocosms

Chlorophyll *a* content

In the *Z. marina* beds of the marine mesocosm experiment the chlorophyll *a* content at the sediment surface showed slightly higher concentration during the short-term incubation when compared to the long-term period. After seven days the lowest chlorophyll *a* concentrations were detected in the treatments with IGL ($0.37 \mu\text{g cm}^{-2} \pm 0.36$) whereas maximum contents were in the combined-grazer treatment IG ($1.70 \mu\text{g cm}^{-2} \pm 0.40$) (figure 1A). Significantly lower chlorophyll *a* concentrations after seven days occurred in the presence of all three grazers when compared to the G- and the IG-units ($p < 0.05$). However, no significant differences were detected between the grazer treatments and the starts (t_0) and the controls (ctrl) ($p > 0.05$). As the experiment progressed, some of the grazer units showed decreased chlorophyll contents (figure 1B). For example by day seven to day 21 with *G. salinus* as a single grazer and *I. balthica* in combination with *G. salinus* (IG) and *L. littorea* (IL) ($p < 0.05$).

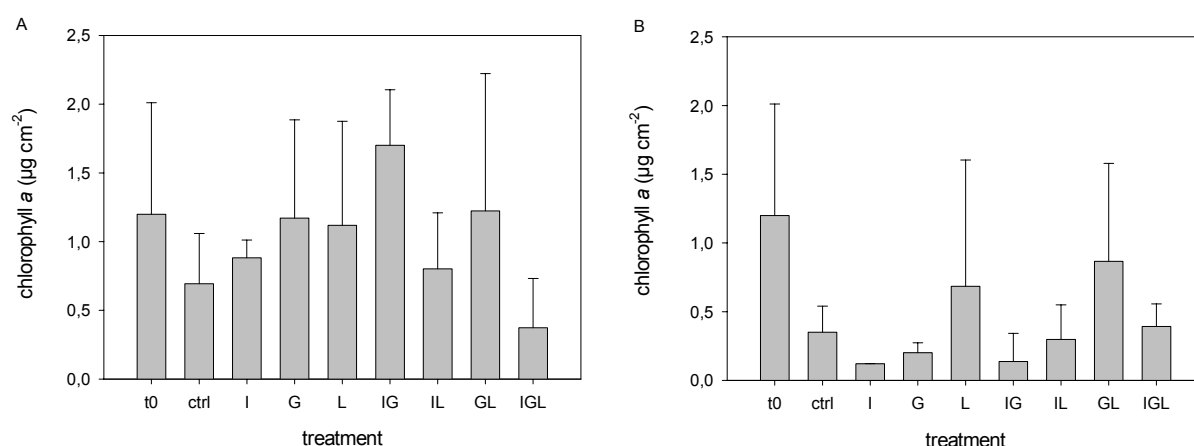

Figure 1: A, B: Chlorophyll *a* concentrations ($\mu\text{g cm}^{-2}$) at the top 500 μm of the sediment surface in the marine mesocosms after 7 (A) and after 21 days (B) of incubation. The x-axis presents the start values (t_0) and the different treatments: control (ctrl), single-grazer treatments (I, G, L), the combined grazer treatments (IG, IL, GL) and the all-three grazer-treatment (IGL). Bars present mean values and standard deviations are given.

Cell numbers

In contrast to the total chlorophyll contents, the cell numbers at the sediment surface gave contradictory results. In the first seven days of the experiment very low cell numbers were found and no significant differences between the different treatments could be detected (figure 2A; $p > 0.05$). After seven days a minimum of 492 cells cm^{-2} (IGL) and a maximum of 2775 cells cm^{-2} (IG) were counted. At the end of the three week incubation period, a significant increase in cell number was found in the controls and in the majority of grazer treatments (figure 2B; treatments: ctrl, I, L, GL, IGL) and as much as 10 to 15 times higher cell numbers were determined. The lowest cell numbers of 4719 cells cm^{-2} were found in the combined presence of *I. balthica* and *L. littorea* (IL) and this treatment therefore differed significantly from the I- and the IGL-units.

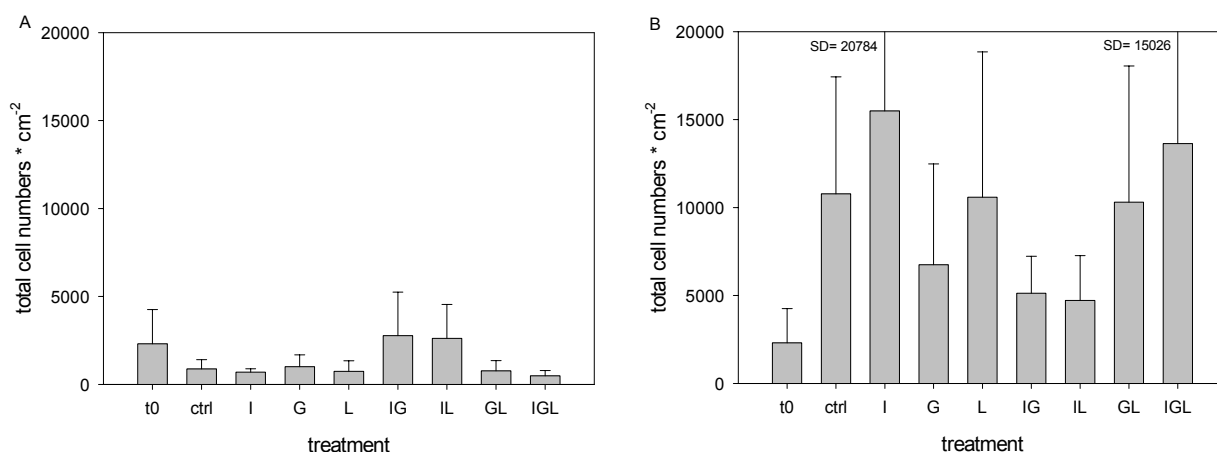

Figure 2: A, B: Total cell numbers (cells cm^{-2}) at the top 500 μm of the sediment surface in the marine mesocosms after 7 (A) and after 21 days (B) of incubation. The x-axis presents the start values (t0) and the different treatments: control (ctrl), single-grazer treatments (I, G, L), the combined grazer treatments (IG, IL, GL) and the all-three grazer-treatment (IGL). Bars present mean values and standard deviations are given

Major taxonomic groups

At the beginning of the marine mesocosm experiment the microphytobenthic community was dominated by diatoms (>90%). Over 70% of these diatoms were of the prostrate type and only 16% belonged to chain forming or stalked diatom genera (1%) (figure 3A). 8% of the algae were Cyanobacteria and only 0.5% chlorophytes. After one week of incubation this pattern changed slightly in the control units. Most of the grazer treatments however showed distinct composition changes when compared to the start (t0) and the control-units (ctrl). One thing which was remarkable after the first week was the simultaneous increase in stalked diatoms and chlorophytes in the controls and in the grazer treatments respectively (I, IG, IL). Diatom chains were reduced in almost every treatment, in the controls as well as in the

grazer units. The strongest composition changes in comparison to start- and control-samples were detected for treatments with the single grazers *G. salinus* and *L. littorea*. These invertebrates obviously allowed the dominance of prostrate diatoms as this group made up 94-99% of the total algal community of these units. In contrast, the combined grazer treatments IG and IL showed that prostrate forms made up 25 and 34% of the microphytobenthos of these units. Increasing shares of stalked diatoms and/or Cyanobacteria and chlorophytes could be detected for the treatments I, IG, IL, GL and IGL. In the marine mesocosms the long incubation period showed distinct composition changes and an overall dominance of chain forming diatoms appeared (67-87%; figure 3B).

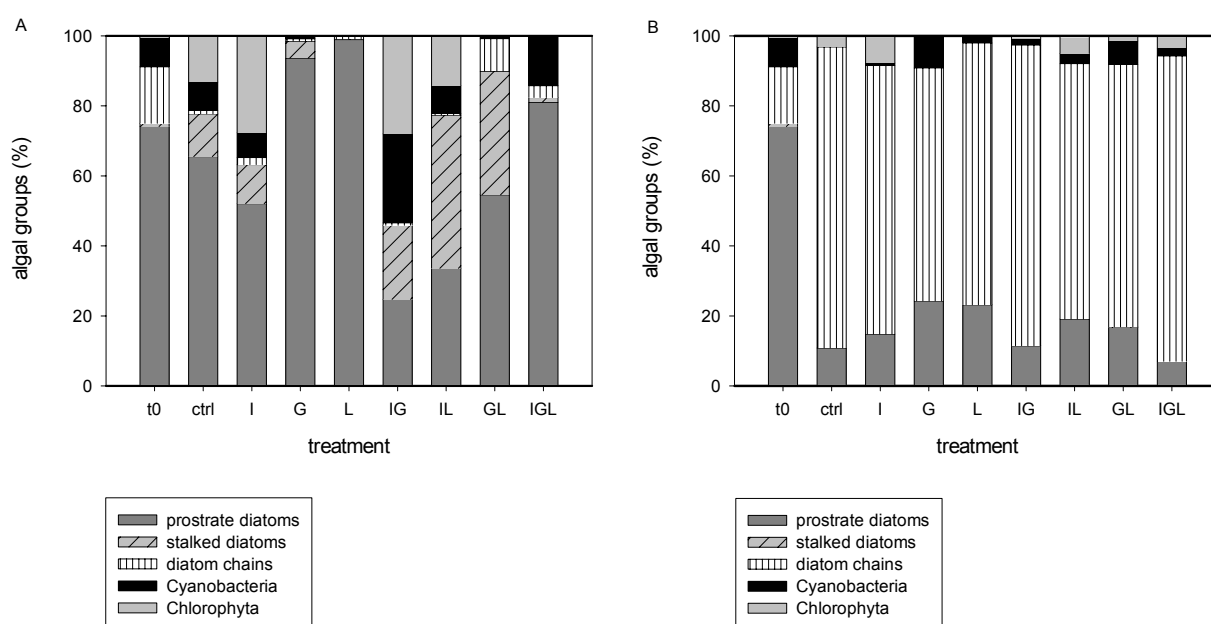

Figure 3: A, B: Algal group composition at the top 500 µm of the sediment surface in the marine mesocosms after 7 (A) and after 21 days (B) of incubation. Relative proportions of the different taxonomic groups are calculated as % of the total algal cells. The x-axis presents the start values (t0) and the different treatments: control (ctrl), single-grazer treatments (I, G, L), the combined grazer treatments (IG, IL, GL) and the all-three grazer-treatment (IGL).

Detailed taxonomic composition

Despite the similarities of the algal communities in all of the marine mesocosms after one week, the detailed taxonomic composition still showed differences between the starts (t0), the controls (ctrl) and the grazer treatments. When comparing the initial community structure (t0) with the controls (ctrl), lower proportions of *Fragilaria sp.*, *Amphora sp.* and *Navicula sp.* were detected in the controls concurrent with an increase of *Diploneis sp.*, *Synedra sp.* and chlorophytes (figure 4A). In the presence of the *G. salinus* and *L. littorea* as single grazers, the microphytobenthos showed distinct taxonomic differences when compared to treatments with *I. balthica*. In contrast to the I-treatments, G- and L-treatments showed a sharp decline of *Synedra sp.*, Cyanobacteria and Chlorophyta and only very few *Melosira nummuloides* were found, whereas the proportions of *Nitzschia sp.* and *Diploneis sp.* increased. In addition, similar trends were found for the combination of these both grazers (GL), although *Synedra sp.* showed much higher proportions this time and *M. nummuloides* increased. The combined grazer treatments IG and IL were characterized by similar community structures with high total shares of *Synedra sp.*, Cyanobacteria and Chlorophyta and the reduction of *Pinnularia sp.*. In the presence of all three grazers (IGL) the sediment had a composition that was dominated by *Diploneis sp.*, *Navicula sp.*, *Amphora sp.*, *Nitzschia sp.* and Cyanobacteria and low numbers of *M. nummuloides*. Complete extinction of chlorophytes and the stalked diatom *Synedra sp.* occurred.

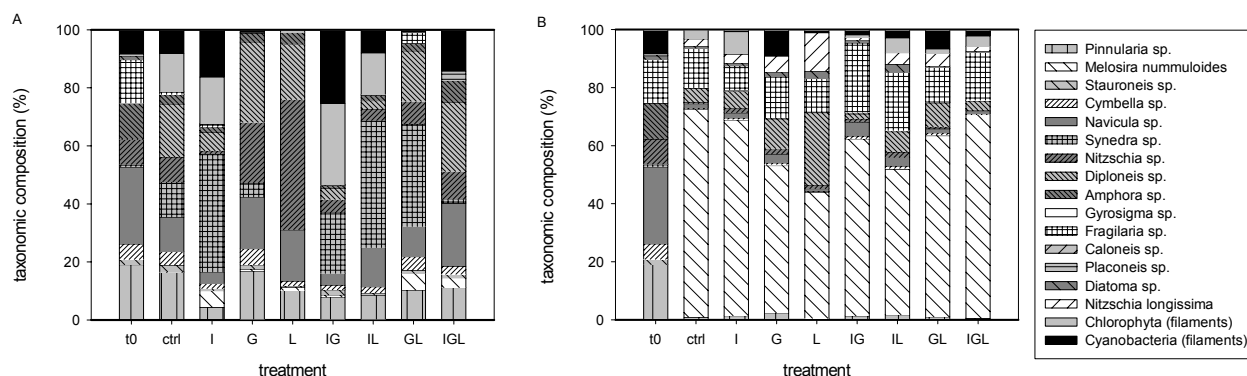

Figure 4: A, B: Taxonomic composition at the top 500 µm of the sediment surface in the marine mesocosms after 7 (A) and after 21 days (B) of incubation. Relative proportions of the different genera are calculated as % of the total algal cells. The x-axis presents the start values (t0) and the different treatments: control (ctrl), single-grazer treatments (I, G, L), the combined grazer treatments (IG, IL, GL) and the all-three grazer-treatment (IGL).

After three weeks the microalgal assemblage changed completely and no similarity between the initial community structure and the control- and grazer treatments could be found. In this case *M. nummuloides*, a chain-forming diatom that was not present initially, dominated the

community in numbers between 43% (L) and 72% (control) (figure 4B). In addition, the species *Nitzschia longissima* appeared during the long-term-incubation for the first time and *Fragilaria sp.* recurred. The genera *Navicula*, *Pinnularia*, *Nitzschia*, *Amphora* and *Cymbella*. which initially colonized the sediment surface, were reduced after three weeks and some of them were almost extinct. One grazer treatment that showed a slightly different distribution in comparison to the majority of grazer units, was the treatment with *L. littorea* as single grazer. Here low *M. nummuloides* as well as low Cyanobacteria proportions and a complete reduction of Chlorophyta were seen. Higher percentages of *Diploneis sp.* and *Nitzschia longissima* were detected.

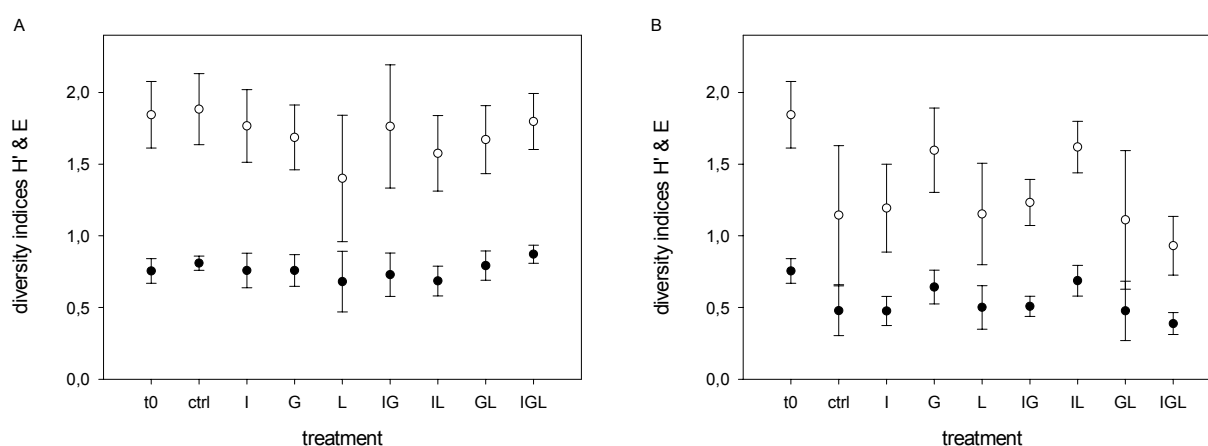

Figure 5: A, B: Diversity indices H' (Diversity) and E (Evenness) at the top 500 µm of the sediment surface in the marine mesocosms after 7 (A) and after 21 days (B) of incubation. The x-axis presents the start values (t0) and the different treatments: control (ctrl), single-grazer treatments (I, G, L), the combined grazer treatments (IG, IL, GL) and the all-three grazer-treatment (IGL). Mean values and standard deviations are given.

Diversity & evenness

Diversity (H') and evenness (E) evaluations gave similar values at the beginning of the experiment (t0) when compared to control- and grazer-treatments after one week of incubation (figure 5A). The diversity in the *L. littorea*-units declined slightly although these differences were not significant ($p > 0.05$). In addition, no changes for evenness could be detected for either the start- or for the control values or for grazer treatments. As the experiment proceeded both indices showed higher variances and, in general, diversity and evenness declined (figure 5B). After 21 days diversity and evenness in the control treatments had declined significantly when compared to the first incubation period ($p < 0.05$). The diversity in the G- and IL-units were significantly higher than in the presence of all three grazers (IGL) and evenness was higher at the beginning of the experiment (t0) as well as in the IL- treatment in comparison to the IGL-units ($p < 0.05$). Diversity and evenness of the microphytobenthic community both showed a clear decrease with regard to total cell

numbers (figure 6). The declining trend of H' with increasing cell numbers showed a steeper gradient ($y = -0.36x + 2.7$).

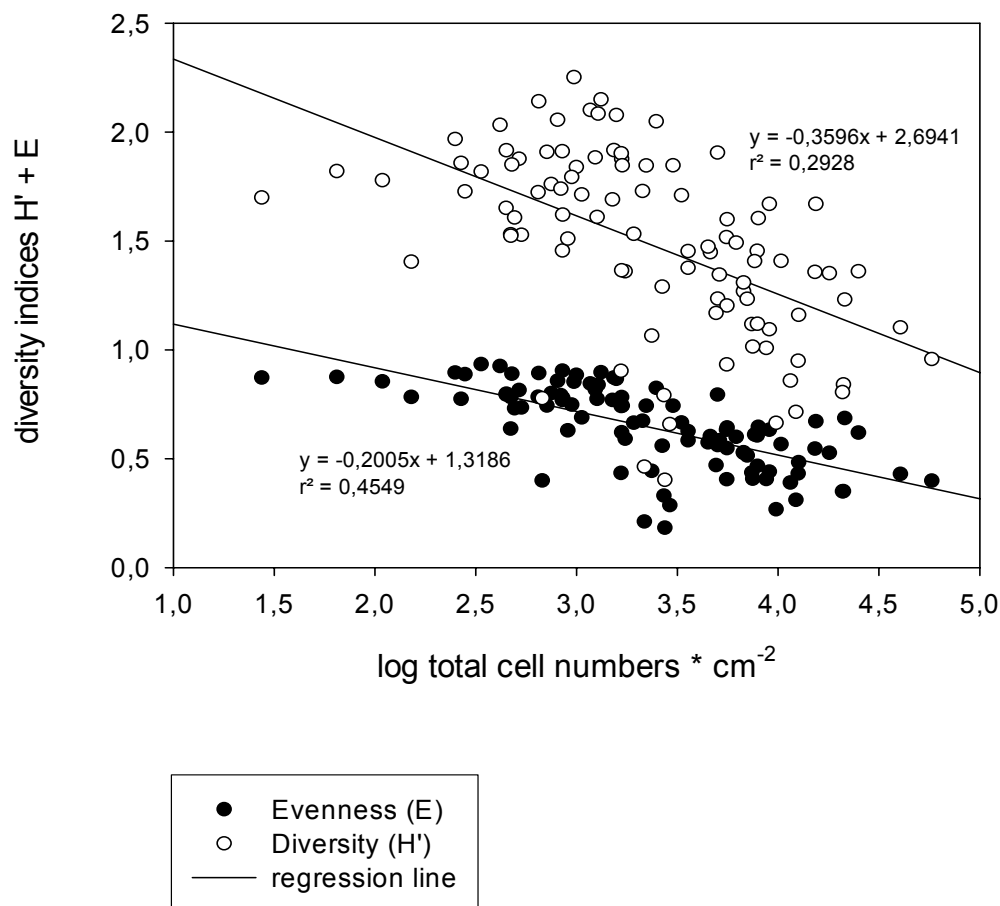

Figure 6: Correlation between the total algal biomass (\log total cell numbers $\cdot \text{cm}^{-2}$) and the diversity indices H' (Diversity) and E (Evenness) respectively at the top 500 μm of the sediment surface in the marine mesocosm treatments. Solid lines are linear regressions.

Freshwater mesocosms

Chlorophyll a content

The chlorophyll *a* contents at the sediment surface of the freshwater units showed similar concentration ranges both after one and after three weeks of incubation. During the short-term incubation period the total chlorophyll *a* values ranged from $1.1 \mu\text{g cm}^{-2} \pm 0.2$ in the AG-treatment to $3.1 \mu\text{g mesocosms cm}^{-2} \pm 1.2$ in the presence of *A. aquaticus* (figure 7A; $p < 0.05$). The chlorophyll *a* contents in the AG-units were also significantly lower compared to all single-grazer units (A,G,R), the combined-grazer treatment AR and the start samples (t_0) ($p < 0.05$). Significantly higher concentrations were shown for *A. aquaticus*-units (A) in

comparison with combined-grazer treatments AG and GR as well as the treatments with all three grazers present (AGR) ($p < 0.05$). After 21 days of incubation the chlorophyll *a* concentrations changed only slightly. A significant decrease was found in the presence of *A. aquaticus* and an increase in the AG-units (figure 7B). For the combined-grazer treatment AG highest chlorophyll *a* concentrations were found ($2.6 \mu\text{g cm}^{-2} \pm 0.5$). These values were significantly higher than data obtained after three weeks from the G-, AR- and AGR-treatments ($p < 0.05$).

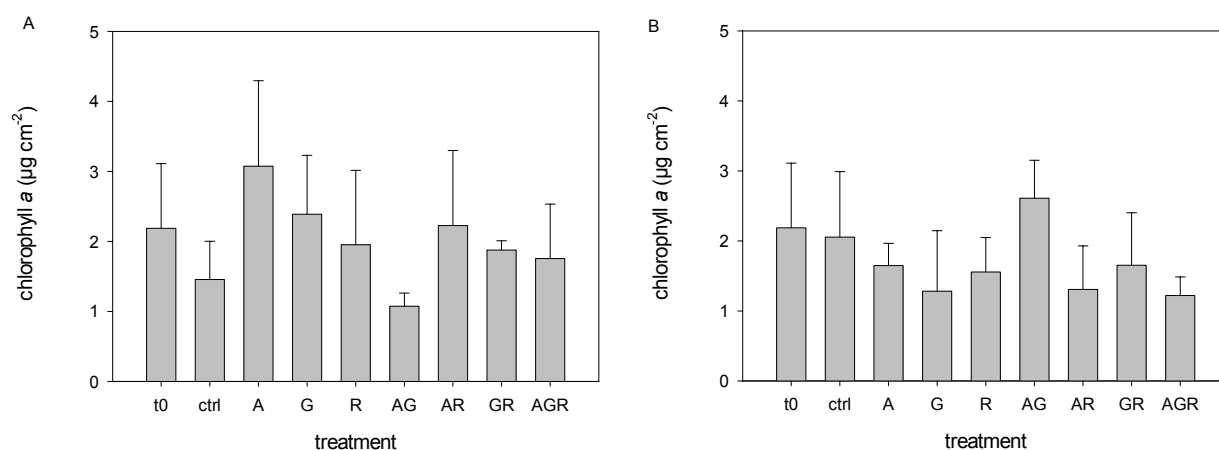

Figure 7: A, B: Chlorophyll *a* concentrations ($\mu\text{g cm}^{-2}$) at the top 500 μm of the sediment surface in the freshwater after 7 (A) and after 21 days (B) of incubation. The x-axis presents the start values (t_0) and the different treatments: control (ctrl), single-grazer treatments (A, G, R), the combined grazer treatments (AG, AR, GR) and the all-three grazer-treatment (AGR). Bars present mean values and standard deviations are given.

Cell numbers

The number of algal cells showed lower abundances after the first week and at the end of the three weeks period an increase in cell numbers was found. As far as total cell numbers during the first incubation period are concerned, no significant differences between the various treatments could be detected (figure 8A; $p > 0.05$).

After three weeks, cell numbers increased significantly within the single-grazer treatments A and G as well as in the presence of all three grazers (AGR) (figure 8B; $p < 0.05$). When compared to initial cell numbers (t_0), most of the long-term treatments showed distinct increases in algal abundance (A, G, R, AG, AGR). The single-grazer units A and G showed significant differences compared to the controls ($p < 0.05$). A minimum of 70075 cells cm^{-2} was detected in the presence of *G. pulex* and *R. ovata* (GR). These abundances were significantly lower when compared to the treatments A, G, R and AGR.

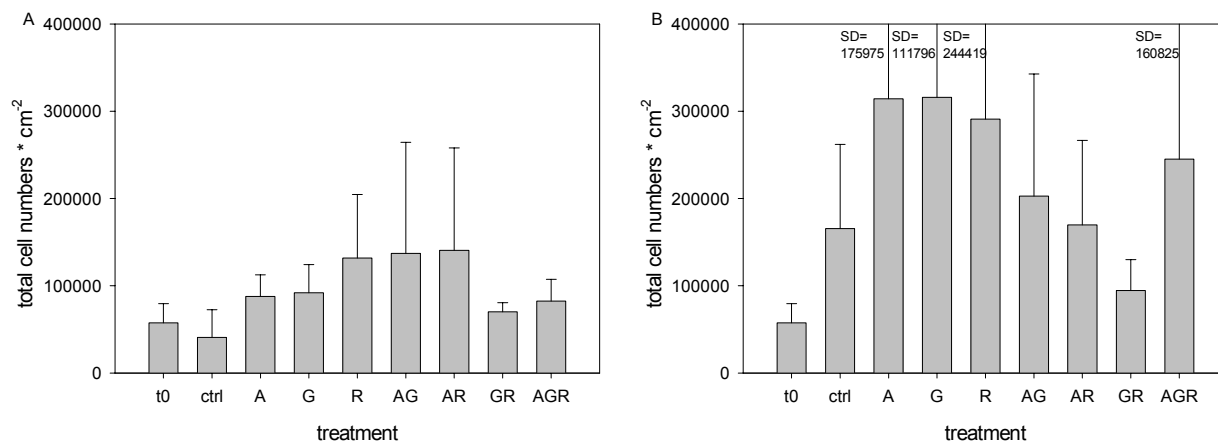

Figure 8: A, B: Total cell numbers (cells cm⁻²) at the top 500 μm of the sediment surface in the freshwater mesocosms after 7 (A) and after 21 days (B) of incubation. The x-axis presents the start values (t0) and the different treatments: control (ctrl), single-grazer treatments (A, G, R), the combined grazer treatments (AG, AR, GR) and the all-three grazer-treatment (AGR). Bars present mean values and standard deviations are given.

Major taxonomic groups

During the short-term freshwater experiment the algal assemblages were dominated by chain-forming diatoms (28-55%) and Cyanobacteria (32-62%; figure 9A). Chlorophyta were not present. In contrast to the grazer treatments and the controls, the starting community (t0) showed higher percentages of prostrate diatoms (34%). However, this pattern changed after the first week where this taxonomic group made up 10 to 16% of the total algal community. Although the proportions of prostrate and stalked diatoms remained almost constant in all grazer units as well as in the controls, the shares of Cyanobacteria and diatom chains showed high variations. Especially high proportions of Cyanobacteria were detected for the combined-grazer unit AR (62%) and the single grazer treatment G (55%) whereas diatom chains contributed approximately 50% to the total algal community in the controls and the AGR-treatments. Three weeks of incubation produced a shift in the community structure as a clear dominance of chain-forming diatoms with percentage shares ranging from 72% (GR) to 87% (AGR) occurred (figure 9B). In contrast to the short-term incubation, the relative importance of stalked and prostrate diatoms declined considerably and Cyanobacteria contributed between 9% (AGR) and 21% (AR) to the total algal community.

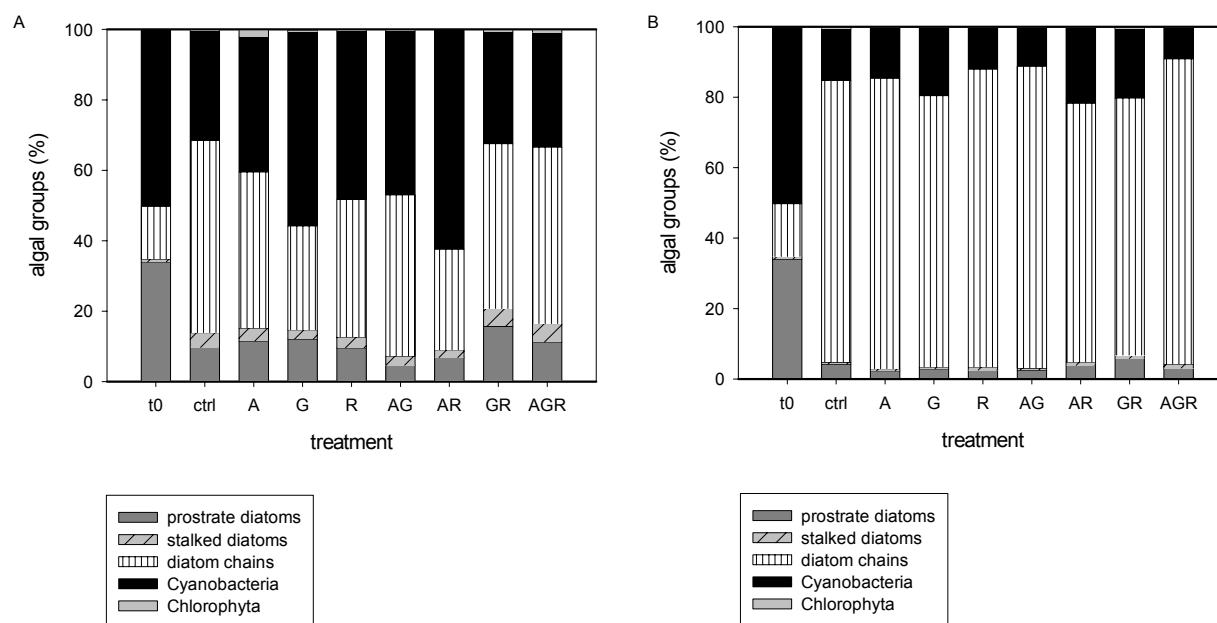

Figure 9: A, B: Algal group composition at the top 500 µm of the sediment surface in the freshwater mesocosms after 7 (A) and after 21 days (B) of incubation. Relative proportions of the different taxonomic groups are calculated as % of the total algal cells. The x-axis presents the start values (t0) and the different treatments: control (ctrl), single-grazer treatments (A, G, R), the combined grazer treatments (AG, AR, GR) and the all-three grazer-treatment (AGR).

Detailed taxonomic composition

During the first incubation period, the controls (ctrl) as well as the grazer treatments showed similar proportions of algal taxa (figure 10A). When comparing the initial community structure (t0) with the controls, lower proportions of *Fragilaria sp.* (15%) and *Gomphonema sp.* (1%) occurred and higher abundances of *Pinnularia sp.* (4%), *Stauroneis sp.* (4%), *Nitzschia sp.* (17%) and *Merismopedia sp.* (50%) were detected at the beginning of the experiment. These distribution patterns changed in the grazer- and the control-units after one week as they showed higher proportions of *Fragilaria sp.* ranging from 28% (AR) to 52% (ctrl) and relatively higher abundances of *Gomphonema sp.* (2-5%) were found. The highest amounts of *Merismopedia sp.* during the short-term incubation were found for the combination of *A. aquaticus* and *R. ovata* (AR; 62%) and fairly low percentage of 30-40% were detected in the ctrl-, A-, GR- and AGR-treatments. In the long-term a distinct dominance ranging from 72% (GR) to 88% (AGR) of *Fragilaria sp.* was observed in all different treatments (figure 10B). *Merismopedia sp.* became less important and made up only 7-21% of the total algal community. All other taxonomic groups, originally present in the different treatments, showed proportions of below 2%.

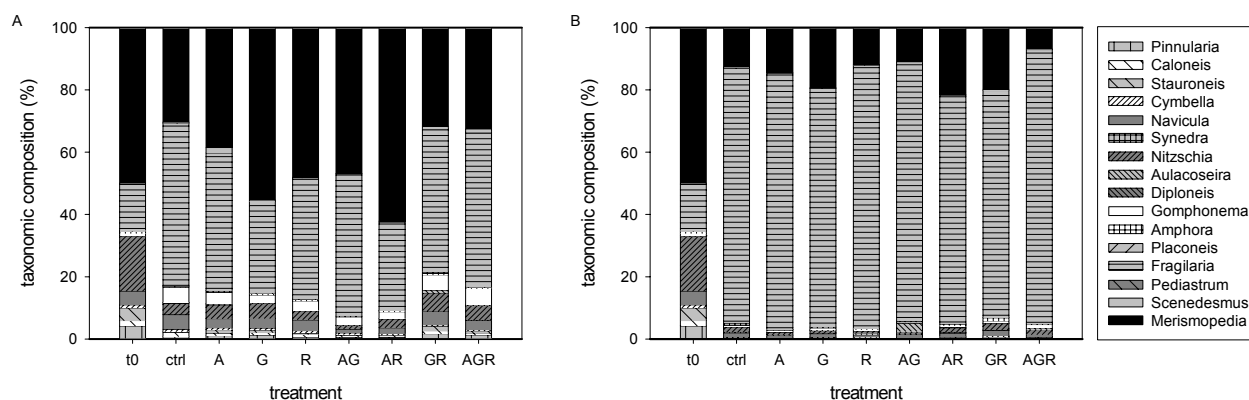

Figure 10: A, B: Taxonomic composition at the top 500 µm of the sediment surface in the freshwater mesocosms after 7 (A) and after 21 days (B) of incubation. Relative proportions of the different genera are calculated as % of the total algal cells. The x-axis presents the start values (t0) and the different treatments: control (ctrl), single-grazer treatments (A, G, R), the combined grazer treatments (AG, AR, GR) and the all-three grazer-treatment (AGR).

Diversity & Evenness

The highest values for diversity (H') and evenness (E) were seen at the beginning of the experiment (t0). However, decreases in H' and E were observed after one and three weeks (figure 11 A, B; $p < 0.5$). After seven days evenness was significantly lower in the treatments with *R. ovata* as single grazer (R) compared with the t0-values ($p < 0.5$). In terms of diversity all grazer treatments showed similar H' -values and no significant differences could be

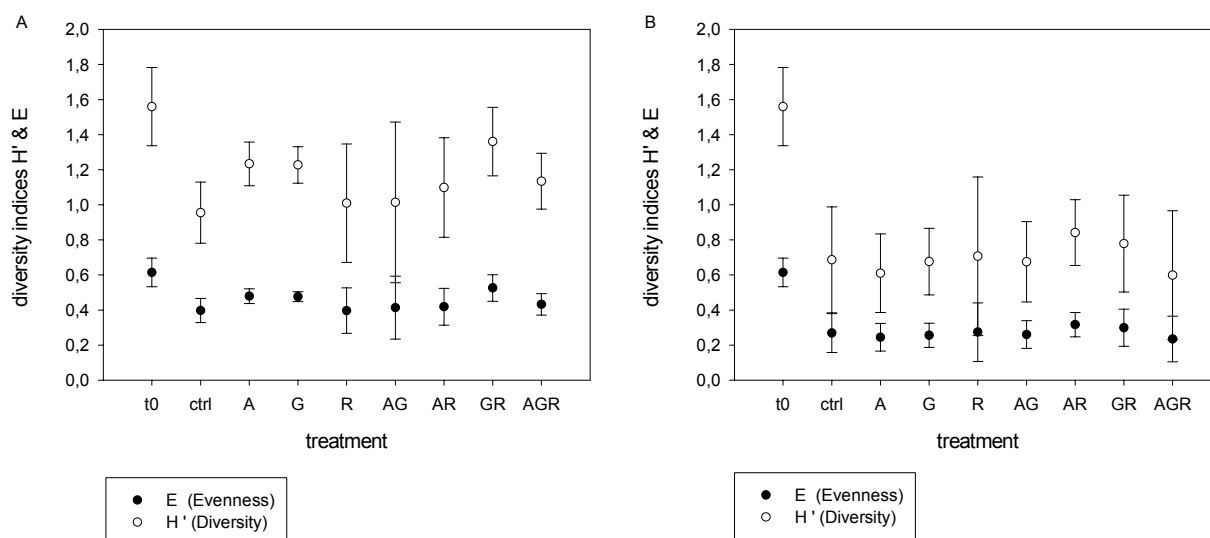

Figure 11: A, B: Diversity indices H' (Diversity) and E (Evenness) at the top 500 µm of the sediment surface in the freshwater mesocosms after 7 (A) and after 21 days (B) of incubation. The x-axis presents the start values (t0) and the different treatments: control (ctrl), single-grazer treatments (A, G, R), the combined grazer treatments (AG, AR, GR) and the all-three grazer-treatment (AGR). Mean values and standard deviations are given.

detected ($p > 0.05$). During the course of the experiment, the ctrl- as well as the grazer-units showed a significantly lower diversity and evenness when compared to the initial values (t_0 ; $p < 0.5$). No differences between the control- and the grazer-treatments were seen (figure 11b). In addition, the correlation between total cell numbers and diversity variables evinces a decrease in diversity with increasing cell numbers (figure 12).

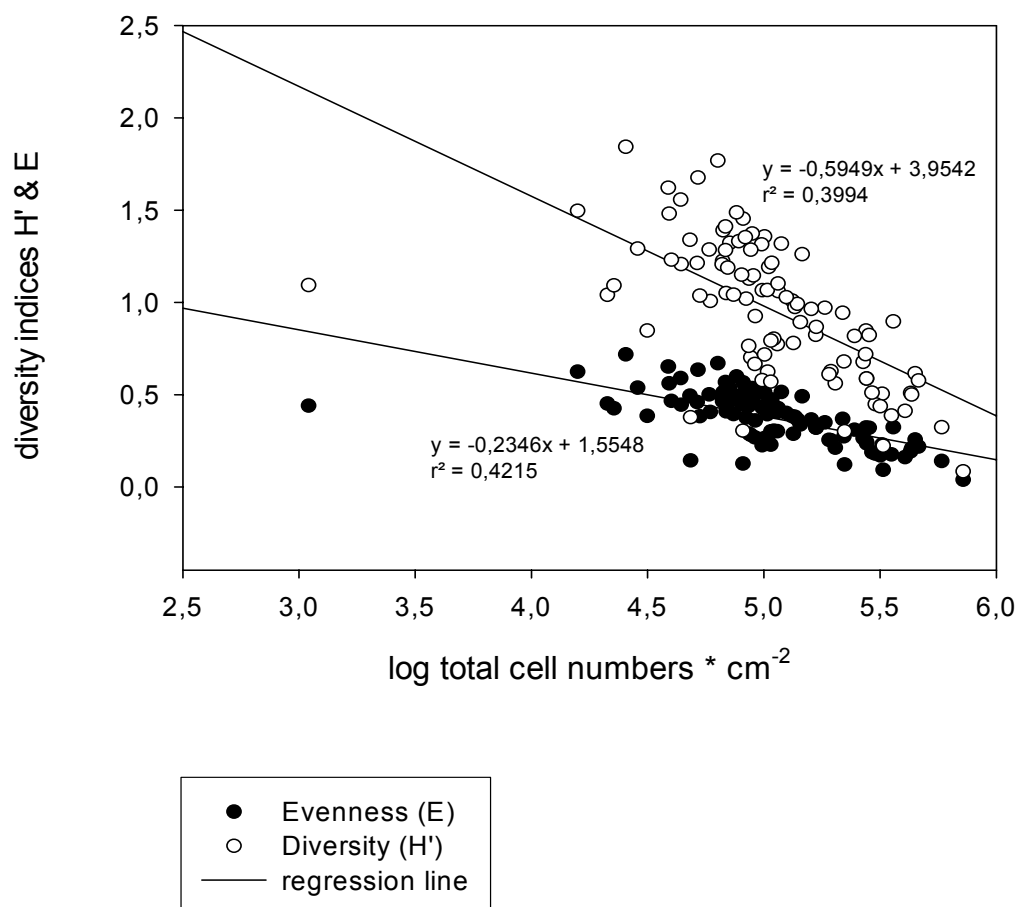

Figure 12: Correlation between the total algal biomass (log total cell numbers * cm⁻²) and the diversity indices H' (Diversity) and E (Evenness) respectively at the top 500 μm of the sediment surface in the freshwater mesocosm treatments. Solid lines are linear regressions.

5.4 Discussion

The impact of grazers on the community structure of macrophyte beds and their associated flora has become an important research field in aquatic benthic ecology over the last decades. Since nutrient supply is a major variable that regulates primary productivity and species composition in benthic communities, this topic has also gained in importance. Thus, the analysis of the combined impacts of consumers and nutrient resources on benthic floral diversity are of considerable relevance to understand benthic-pelagic systems better.

Marine mesocosms

Total chlorophyll a concentrations and cell numbers

During the marine mesocosm experiment with *Z. marina* beds the chlorophyll concentrations at the sediment surface in general showed higher contents after one week compared to the three incubation week period. Since grazing, in general, is considered to cause decreases in chlorophyll a contents at the sediment surface these data fit well into previously published studies (Cattaneo, 1983; Lamberti & Resh, 1983; Feminella & Hawkins, 1995; Steinman, 1996; Hillebrand & Kahlert, 2002). Thus, our assumption, that the presence of invertebrates affects chlorophyll concentrations negatively over the total duration of the experiment, was confirmed.

The total chlorophyll concentrations at the sediment surface of our marine mesocosms ranged from $0.1 \mu\text{g cm}^{-2}$ to $1.7 \mu\text{g cm}^{-2}$. Since comparable estimates for any other seagrass beds are rare, comparisons are difficult. Until now, there is only one study known by the authors that provided chlorophyll a concentration from microphytobenthic assemblages within a seagrass bed (Daehnick et al., 1992). In contrast to our investigations, this study showed relatively high chlorophyll a concentrations of $1.4\text{-}12.5 \mu\text{g cm}^{-2}$ adjacent to and beneath the seagrass *Halodule wrightii* in the Mississippi Sound. Additionally, studies from intertidal or subtidal regions provide chlorophyll a data although the comparability of sediments within seagrass beds are limited. De Jonge and Colijn (1994) recorded ranges of $2.8\text{-}24.7 \mu\text{g cm}^{-2}$ and Agatz et al. (1999) of $13.0\text{-}23.8 \mu\text{g cm}^{-2}$, respectively, for intertidal sand flats, while Sundbaeck (1983) found a range of $2.3\text{-}25.8 \mu\text{g cm}^{-2}$ for a shallow subtidal sand flat. These discrepancies might be explained by the different sediment volumes sampled. All these mentioned studies determined chlorophyll a concentrations from the first one cm of the sediment surface. In our case the data was restricted to the uppermost $500 \mu\text{m}$ of the surface layer and therefore it can be best compared to an intertidal field study conducted by Barranguet & Kromkamp (2000) which detected chlorophyll a ranges of $1.0\text{-}4.0 \mu\text{g cm}^{-2}$ at the uppermost $1000 \mu\text{m}$.

Contrasting with the chlorophyll measurements, the results for total cell numbers were less easy to interpret. During the first period of the experiment, low cell numbers occurred and no

significant differences between the treatments could be detected. However, after three weeks a sharp increase in cell numbers was found in the controls and also in the majority of grazer treatments. Since chlorophyll *a* concentrations and cell numbers are used as biomass estimates and as they often show good correlation (Karlstroem & Backlund, 1977; Khondker & Dokulil, 1988; Mitbavkar & Anil, 2002), the discrepancies in our results are not easily explained. Sediment samples for chlorophyll *a* and cell count analysis were both obtained following the same technique, consequently a methodological error seems unlikely. A possible explanation could be that the increase in algal abundance at the uppermost surface layer shaded the underlying cell layers and thus overstory algae negatively affected the pigment composition of understory forms. This might explain the weak correlation between chlorophyll content and algal cell numbers.

Major taxonomic groups

The initial sediment microflora showed a clear dominance of diatoms, whereby prostrate forms were the major constituents. Cyanobacteria made up only 8% of the whole sediment community. This is in good correspondence to earlier microphytobenthos studies in the intertidal as well as in subtidal macrophyte beds. Edaphic algae dwelling on sediments consist mainly of diatoms and blue-green or green algae occur only temporarily. In addition, the diatom populations are usually composed of pennate, prostrate forms, which are either epipsammic (attached to sand grains) or epipellic (motile forms within the sediment) (Daehnick et al., 1992; Moncreiff et al. 1992; Agatz et al., 1999; Mitbavkar & Anil, 2002). But apart from these prostrate forms, chain-forming diatoms occurred in considerable abundances.

During the course of the marine experiment a shift in taxonomic composition was observed after one and after three weeks. Apart from grazing activity, there are a variety of abiotic factors which can regulate species composition in algal assemblages, e.g. temperature, salinity or nutrient loads. The first fractions were constant in our experiments, nutrients showed particular dynamics.

Nutrient effects:

Nutrient analyses from the inflow of the mesocosm units showed a clear increase in nitrate and silicate concentrations during the first week (figure 13; Jaschinski, unpublished data). As each unit was supplied autonomously with the same source of water, it is highly unlikely that inter-variations in nutrient supply occurred. Both nutrient components showed a maximum concentration on day seven of the experiment whereby nitrate reached values of $13 \mu\text{mol l}^{-1}$ and silicate of $27 \mu\text{mol l}^{-1}$. The nutrient loads in the experimental units were due to the inflow

of the nutrient rich seawater from the Kiel Fjord. These values are extremely high when compared to field data achieved from the *Z. marina*-site in Falkenstein during the seasons 2001 and 2002 (Jaschinski, pers. comm.). Accordingly the nutrient compositions in our experiment resembled a spring- or autumn-nutrient situation. It is known, that there is a nutrient limitation in the water-column from late spring to autumn, especially in terms of nitrogen and that for example distribution patterns in epilithic communities can be altered by nutrient supplies from the water-column (Hillebrand & Sommer, 1997). Consequently, the observed taxonomic composition changes in our mesocosms were highly related to increased nutrient availabilities. Tendencies towards a shift in community structure after one week were observed as stalked diatoms and green algae benefited from the changing nutrient supplies.

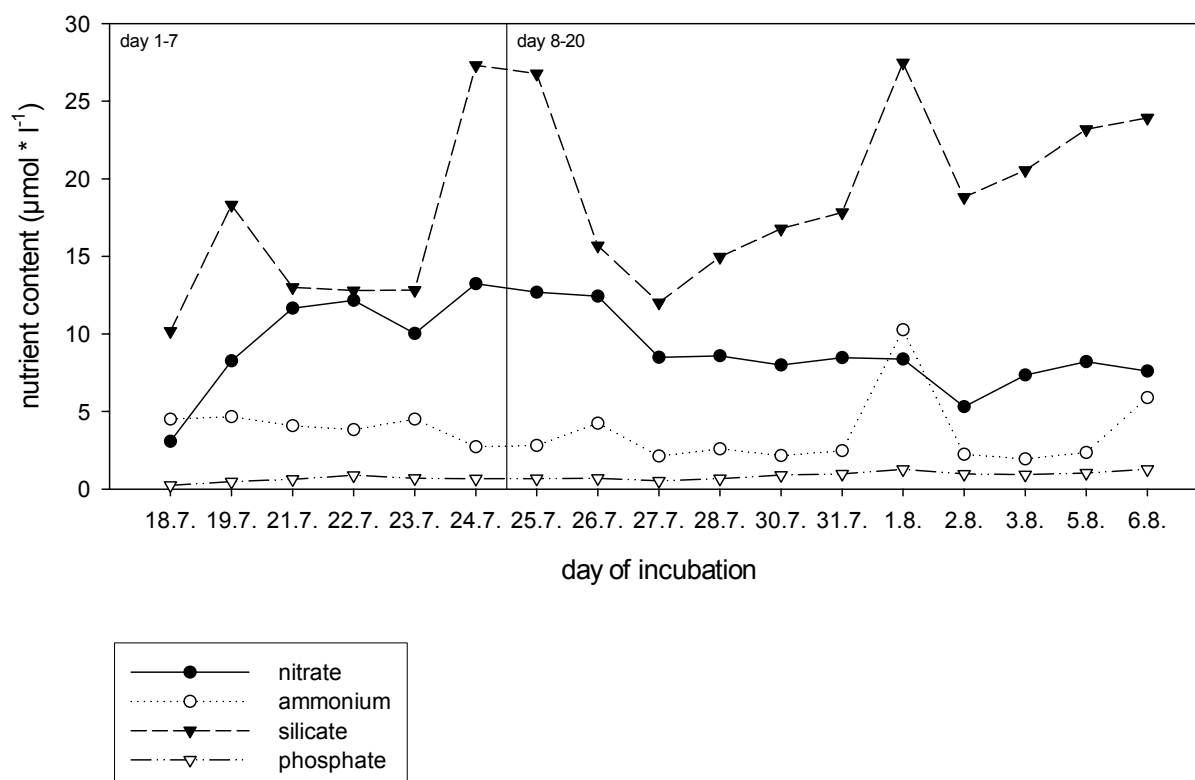

Figure 13: Nutrient concentrations ($\mu\text{mol} \cdot \text{l}^{-1}$) in the water-column of the experimental units measured from the inflow during the course of the marine mesocosm experiment (day 1-20).

Grazer effects & competitive interactions:

Compared to the controls, grazer treatments showed distinct composition changes and interspecific variations. Consequently, the community structure of the microphytobenthos was not only regulated by nutrient supplies but also by feeding preferences and competitive interactions. The single grazers *G. salinus* and *L. littorea*, e.g., influenced the algal assemblages significantly after seven days by reducing characteristic constituents like

chlorophytes, cyanophytes and stalked diatoms, leaving behind a sediment microflora comprising almost exclusively of prostrate diatoms. In combination with the isopod *I. balthica* (IG or IL), however, a clear reduction of prostrate forms was seen. This indicates that while there was no co-occurring grazer present, the single grazers *G. salinus* and *L. littorea* showed a preference for chlorophytes, cyanophytes and stalked diatoms. But when these invertebrates had to share food sources with *I. balthica* they changed from their preferred diets to prostrate diatoms as food source. Thus, the presence of *I. balthica* induced a shift in resource use of *G. salinus* and *L. littorea*. The resource use of competitors has been a major topic in pelagic community ecology for many years. The mechanisms that determine species coexistence with shared resources are still discussed controversially (Ricklefs & Schluter, 1993; Gaston, 2000) but the central assumption of competition theory is that the strength of interspecific competition is inversely related to the amount of resource partitioning (Pacala & Roughgarden, 1982). Thus it can be assumed, that some of the distribution patterns obtained from our mesocosm units were also induced by species competing for resources. Furthermore, the diverse array of grazer effects might be a result of overlapping trophic niches.

Nutrient versus consumer effects:

The nitrate and silicate concentrations remained high during the course of the experiment and persisting high nutrient loads resulted in sharp composition changes of the microphytobenthic community over the long-term. An overall dominance of chain-forming diatoms appeared and no differences between treatments occurred. Thus, under these circumstances, diatom chains benefited most from continuously high nutrient supplies resulting in tremendous growth rates and biomasses. Due to their high abundances, diatom chains remained almost unaffected by consumers and they out-competed other taxonomic groups that were originally residents of the sediment community. At such high algal biomasses, grazing activity was no longer successful in affecting microphytobenthic community structures.

Detailed taxonomic composition

The consideration of different microalgal taxa provided a more detailed knowledge of how special genera interact and in which way single taxonomic groups are affected by changing nutrient availability and grazer presence.

When comparing the initial community structure with the controls after one week, lower proportions of *Fragilaria sp.*, *Amphora sp.* and *Navicula sp.* were detected and increasing proportions of *Diploneis sp.*, *Synedra sp.* and chlorophytes were seen. These changes in

community composition most likely resulted from a combination of increased nutrient supplies in the water column and from grazers' selectivity.

Nutrient effects:

In contrast to the short-term incubation, the duration of the experiment showed a considerable increase in cell numbers which was directly related to higher biomasses of the chain-forming diatoms *Fragilaria sp.* and *M. nummuloides*. Due to this mass occurrence, other taxonomic forms were almost overgrown and their relative importance decreased, however it should be stressed that in terms of absolute cell numbers small, prostrate genera remained almost unaffected. The viability of prostrate forms despite the high productivity of chain-forming diatoms is noteworthy, as the light conditions at the uppermost surface layer most probably had declined due to shading from overstory algae. Competition for nutrients between prostrate and erect forms was obviously not given, since microalgae, living closely attached to or within the sediment, mainly depend on the sediment nutrient pool (Admiraal, 1984). From pore water analysis at the end of the experiment it was shown that nutrient concentrations were high in the sediment ($5 \mu\text{mol l}^{-1}$ nitrate, $158 \mu\text{mol l}^{-1}$ ammonium, $130 \mu\text{mol l}^{-1}$ silicate, $5 \mu\text{mol l}^{-1}$ phosphate; Jaschinski, unpublished data) and thus a nutrient limitation of the sediment microflora was not given. The chain-forming diatoms *Fragilaria sp.* and *M. nummuloides* clearly dominated the sediment microflora after three weeks of incubation and therefore these forms played a tremendous role in forming the microphytobenthic community. Both genera can be characterized as benthic-pelagic diatoms (Round et al., 1990). They temporarily reside at the sediment surface where they often contribute to large amounts to the population dynamics of the sediment microflora by forming an overstory within the microalgal mat (MacIntire & Overton, 1971; Nicotri, 1977). This habitat is in contrast to traditional microphytobenthic communities, that are usually characterized by prostrate diatoms, forming distinctly flat, two-dimensional communities (Miller et al., 1987). But beside their benthic stage, *Fragilaria sp.* and *M. nummuloides* have neritic phases either as they get frequently resuspended by hydrodynamic processes and they then dwell in the water column and contribute to the planktonic community (Drebes, 1974). In our experiment one pattern that showed out was the fluctuation of *Fragilaria sp.* in the marine mesocosm units. At the beginning of the experiment this genera was quite abundant but after one week of incubation these chains almost disappeared. The *Fragilaria*-chains emerged again in interaction with the centric filaments of *M. nummuloides* and both taxa clearly dominated the sediment microflora after three weeks. In this context the occurrence of *M. nummuloides* is of considerable interest since the vegetative cells of that species were not observed in the sediments initially and they first occurred at low numbers in some of the grazer treatments after one week. Possibility *M. nummuloides* germinated from

resting stages and appeared in culture due to the high nutrient and light availabilities. Factors that assure success in microalgal growth are a high resilience to external parameters (e.g. predation, hydrodynamics, nutrient stress) that favours a high competitiveness. In contrast to prostrate diatoms, which reside permanently in the sediments and which are more dependent on nutrient conditions at the sediment-water interface (Admiraal, 1984; Hillebrand & Kahlert, 2002), the chain-forming, temporarily edaphic, microalgae are known to be highly influenced by nutrient supplies from the water column (Mitbavkar & Anil, 2002). A study published by Sommer (1997), e.g. clearly showed that *M. nummuloides* was favoured by high silicate concentrations and a similar effect was detected by Hillebrand & Sommer (1997) in case of low nitrogen enrichments. The three-dimensional habit of *Fragilaria sp.* and *M. nummuloides* enables a nutrient uptake from the water column which is impossible for small pennate forms living closely attached to or within the sediment (see Chapter 2). In case of high nitrate and silicate concentration in the water column, the productivity of long-chained diatoms seems to be stimulated and therefore high nutrient loads in the water column favour their competitiveness.

Grazer effects & competitive interactions:

As pointed out in the section on “major taxonomic groups”, the grazers *G. salinus* and *L. littorea* demonstrate the importance of feeding preferences and inter-specific competition. Both grazers preyed predominantly upon Cyanobacteria, chlorophytes and the stalked diatoms *Synedra sp.* and thus, an active selection for large, filamentous and erect genera was detected. As a result of selectivity, the proportions of the small prostrate forms *Nitzschia sp.* and *Diploneis sp.* increased in the G- and L-treatments. Thus, their feeding preferences differed considerably from the feeding habits of *I. balthica* which was shown to predominantly reduce these small, prostrate forms.

There are many studies dealing with invertebrate grazers such as amphipods, isopods and gastropods preying on benthic microalgae (van Montfrans et al., 1984; Brendelberger, 1995; Jernakoff & Nielsen, 1997; Sommer, 1997; Duffy & Hay, 2000; Duffy et al., 2001). The majority of studies have focused on these types of grazers because these are the most abundant and productive ones. In general, gastropods, amphipods and isopods are considered as obligatory or optionally herbivore with a broad dietary overlap and gastropods being more efficient but slightly less selective as opposed to crustaceans (Klumpp et al., 1992; Jernakoff & Nielsen, 1997; Sommer 2000). These differences in food selectivity are most likely related to the grazers' feeding mode and different morphologies of the invertebrates mouthparts. Gastropods appear to be a more generalised browser (see also Chapter 2) and *L. littorea* in particular is known to scrape surfaces with its radula thus sequestering rather unselectively as much food as possible with a large spatial efficiency

(Sommer, 2000). However, food items not only consist of algae and plant material but also of detritus, although a certain preference for large-sized, overstory microalgae was observed for gastropods in general and therefore the removal of algal cells is also assumed to be facilitated by morphological and size-dependent features (Nicotri, 1977; Hunter, 1980; McCormick & Stevenson, 1991). Despite the fact that the mandibles of crustaceans are specialized mouthparts, the isopod *I. balthica* was found to have a rather broad food range grazing on microalgae, macroalgae and seagrass. It does however show a preference for microalgae instead of macroalgae (Shacklock & Doyle, 1983; Sommer, 2000; Worm et al., 2000; Duffy et al. 2001). Furthermore, amphipods are also known to exploit a wide variety of food types, shapes and sizes, however they appear to be selective feeders with a preference for softer food material (Jernakoff & Nielsen, 1997). The genera *Gammarus* in particular is known to graze extensively on microalgae, detritus and associated microbes (Zimmermann et al., 1979; Smith et al. 1982; Duffy et al. 2001).

Unlike the studies conducted by Sommer (1997) where green filamentous algae and the diatom *Synedra* (= *Fragilaria*) *tabulata* suffered high grazing losses by the isopod *I. balthica*, our short-term incubation showed that this species mainly influenced the abundances of unicellular, prostrate diatoms. *Stauroneis* sp., *Nitzschia* sp., *Navicula* sp. and *Diploneis* sp. were preferred by *I. balthica* as opposed to green filamentous ones and *Synedra* sp. which were selected by the gastropods and amphipods. The reduction of filamentous Cyanobacteria and chlorophytes by amphipod grazers confirm the findings of Jernakoff & Nielsen (1997) that showed a high grazing loss for these algal groups in the presence of amphipods. In addition, *L. littorea*-only treatments showed similar distributions, and as the feeding habit of gastropods is characterized by a “bulldozer”-like biofilm grazing, it seems likely that this feeding mode reduces primarily large, overstory algal species as opposed to small, prostrate forms. This was also supported by the fact, that the stalked diatom *Synedra* sp. was affected considerably by grazing *L. littorea*.

Nutrient versus consumer effects:

But even though *Fragilaria* sp. and *M. nummuloides* showed extremely high production rates, it is still surprising that the presence of invertebrate grazers did not regulate the mass occurrence of these diatom chains. In this respect, only the occurrence of *L. littorea* seemed to reduce the occurrence of *M. nummuloides* to any degree. In general, consumers are known to minimize the algal crop and, furthermore, past research detected a selective removal of large, overstory species (Nicotri, 1977; Van Montfrans et al., 1982; Steinman et al. 1987; McCormick & Stevenson, 1989). In addition, some studies even showed that grazers stimulate the growth of understory species by removing overlying algae and senescent cells (Lamberti et al., 1987; McCormick & Stevenson, 1989). However, in our case

the high abundances of *Fragilaria sp.* and *M. nummuloides* showed, that the population grew faster than grazed. Therefore, intermediate grazer abundances were not successful in controlling mass occurrences of particular algal genera.

Diversity & evenness

At the beginning of the experiment and after one week relatively high and constant values were determined, both for diversity and evenness. When compared to data from Hillebrand & Sommer (1997) for epiphytic communities in the western Baltic, our mean results of 1.7 for H' and 0.8 for E in control- and grazer-treatments after one week of incubation are in a similar range albeit at the upper end. Throughout the experiment both indices showed higher variances and, in general, diversity and evenness declined considerably. This is in close correlation with total cell numbers, as with an increase in algal abundance a decreasing trend in diversity could be detected (figure 6). However, the decrease in evenness resulted from the dominance of the two chain-forming diatoms *Fragilaria sp.* and *M. nummuloides* rather than from a loss in taxonomic groups, as the number of species and genera remained almost constant within the whole mesocosm experiment. In general, high nutrient supplies are known to function as triggers for decreasing diversity in microalgal communities (Sullivan, 1976; Carrick et al. 1988; Hillebrand & Sommer, 1997) and therefore the herein detected decline in diversity after three weeks seems most likely to be linked to nutrient conditions. As opposed to grazer presence, the consistently high silicate and nitrate contents in the water column affected the microphytobenthic community structure to a higher degree especially in cases where populations increase faster than they are grazed.

The results from this experiment support the 'consumer vs. resource control'-model developed by Worm et al. (2002). These authors stated that shifts in diversity are induced by a combined change in grazer activity and nutrient supply. In addition, their model assumes that in case of low or intermediate consumer pressure and high productivity, diversity increases. After one week diversity and evenness in all treatments showed relatively high values which resembled intermediate grazer activity and productivity. During this period obviously both consumers and nutrients regulated the microphytobenthic community. On the long run, however, the productivity increased significantly resulting in mass occurrences of only few genera while consumer pressure remained constant. Nutrients then clearly took on a governing role resulting in a decrease in diversity.

Conclusions

There were three main results of the marine mesocosm experiment: nutrient effects, grazer effects and competitive interaction. Nutrients significantly affected the sediment microflora from the beginning on and their impact steadily increased with the duration of the experiment. In this respect the decrease in diversity as a result from constantly high nutrient availabilities were especially remarkable. Effects from grazer activity and competition clearly influenced the sediment community on the short-term of the experiment since large differences between grazer treatments occurred. Consumer effects were best detected from taxonomic composition patterns of the microphytobenthos.

General trends observed on microphytobenthic assemblages in the marine mesocosms are summarized in table 2. The marine mesocosms showed contradictory trends for chlorophyll contents and cell numbers during the course of the experiment. Although pigment concentrations decreased after three weeks, possibly due to shading effects from overstory algae, an increase in cell numbers was observed at the same period. Due to these contradictory results future quantification of grazer and nutrient effects from chlorophyll or cell count analyses alone seems inappropriate. Community shifts in the microphytobenthos as a consequence of grazer presence and nutrient enrichment were best detected both from morphological characteristics of major taxonomic groups and from detailed community structure analysis. Hence a shift from a community that was dominated by Cyanobacteria, Chlorophyta and prostrate diatoms after one week, to an assemblage mainly comprising of chain-forming diatoms after three weeks was observed. In this respect, the governing role of *M. nummuloides*- and *Fragilaria*-chains was remarkable. Grazer presence did not affect the microphytobenthic community homogeneously since a shift in food sources was observed in the cases of species coexistence.

Table 2: General trends in marine mesocosms during the course of the experiment

parameter	incubation time: 7 days	incubation time: 21 days
chlorophyll <i>a</i> concentration	+	-
cell number	-	+
diversity & evenness	constant	-
major taxonomic groups	prostrate diatoms, Cyanobacteria, Chlorophyta	chained & prostrate diatoms
main genera	<i>Synedra</i> , <i>Diploneis</i> , <i>Navicula</i> , <i>Nitzschia</i> , filamentous Cyanobacteria & Chlorophyta	<i>Fragilaria</i> , <i>Melosira nummuloides</i>

Freshwater mesocosms

Total chlorophyll a concentrations and cell numbers

The chlorophyll contents at the sediment surface of the freshwater mesocosm ranging from 1.0 to 3.0 $\mu\text{g cm}^{-2}$ showed similar concentration ranges when compared to studies on benthic microalgae in freshwater lakes. For example Khondker & Dokulil (1988) showed average chlorophyll a concentrations of 2.0 $\mu\text{g cm}^{-2}$ for microphytobenthic communities in a shallow Austrian lake (Neusiedlersee) and Nozaki et al. (2003) detected concentration ranges from 0-6.0 $\mu\text{g cm}^{-2}$ for sand microflora from lake "Biwa". Although direct comparisons to similar sand communities adjacent to or beneath macrophyte beds with *P. perfoliatus* are missing, our data are within the expected range. During the short-term period the grazers *A. aquaticus* and *G. pulex* together reduced algal biomass significantly, whereas a fertilizing effect could be detected for single *A. aquaticus*. This pattern changed after three weeks of incubation since this time algal biomass benefited from the presence of *A. aquaticus* and *G. pulex* and decreases were detected for *G. pulex*-only units. Thus, the macrograzers in the freshwater units affected chlorophyll concentrations more strongly than the hydrobiid snail *P. antipodarum* in a previously described study (see Chapter 3). For the freshwater mesocosms the assumption, that the presence of invertebrates affects chlorophyll a concentrations and that the degree of grazing may differ when species coexist, was confirmed. In addition, this data fits well with past grazing studies that detected decreasing chlorophyll contents at sediment surfaces caused by grazing activity (Cattaneo, 1983; Lamberti & Resh, 1983; Feminella & Hawkins, 1995; Steinman, 1996; Hillebrand & Kahlert, 2002). Thus, detecting feeding patterns on the basis of such rough estimates as chlorophyll concentrations (Wolff, 1979; De Jonge & Colijn, 1994) also seems possible for our system.

In contrast to the relatively constant chlorophyll concentrations, the cell numbers showed lower abundances after seven days than after three weeks of incubation and grazer effects could only be detected over the long-term. Disproportionably high cell numbers occurred in the presence of all three single grazers, whereas the combination of grazers resulted in lower productivities. In this context it can be speculated that the co-occurrence of *G. pulex* and *R. ovata* stimulated grazing activity, as considerably lower algal biomass occurred in the presence of these consumers. Numerous ecological studies have focused on the effect of inter-specific competition on the resource use of competitors and the effects of coexistence are still controversially discussed. The central assumption of competition theory, however, is that the strength of interspecific competition is inversely related to the amount of resource partitioning (Pacala & Roughgarden, 1982). Two grazer species with similar feeding preferences could therefore be regarded as highly competitive and a stimulation of feeding activity seems plausible.

Major taxonomic groups

Diatoms and Cyanobacteria dominated the sediment microflora from the start of the experiment whereas chlorophytes were found in only negligible abundances. This is in good correspondence with other lake sediments, where diatoms usually dominate the sediment communities and where Cyanobacteria are known to be highly abundant in some seasons for example during the summer period (Kann, 1940; Kann, 1993; Khodker & Dokuli, 1988; Hillebrand & Kahlert, 2002). In contrast to grazer treatments and the controls, the initial community showed higher percentages of prostrate diatoms, but this form was almost completely replaced by chain-forming diatoms after one week. In general, freshwater diatom assemblages are considered to predominantly comprise of pennate, prostrate forms living closely attached to or within the sediment (Steinman et al. 1987; Miller et al. 1987; McCormick & Stevenson, 1989). However, apart from these prostrate forms, chain-forming diatoms, e.g. *Fragilaria sp.*, *Diatoma sp.*, *Bacillaria sp.*, *Melosira sp.*, are also known to occur in considerable abundances in some benthic microflora assemblages (Miller et al. 1987; Kann, 1993; Hillebrand & Kahlert, 2002, Hillebrand et al., 2002). The occurrence of such chained forms changes the community structure considerably since this results in a shift from a two- to a three-dimensional community.

Nutrient effects:

The detected large proportions of chained diatoms and cyanophytes in the control- and grazer units need to be interpreted in combination with water column nutrient data provided by Jaschinski (unpublished data). Nutrient measurements from the freshwater inflow to the mesocosm units showed extremely high nitrate and silicate contents with mean nitrate values of $33 \mu\text{mol l}^{-1}$ and $410 \mu\text{mol l}^{-1}$ for silicate (figure 14). When compared to field data from the Schluensee in August and September 2001/2002 (Jaschinski, unpublished data), the concentrations detected in this study were disproportionably high. This was due to the nutrient-rich tap water used for the constant water exchange in the experimental units. The same was true for nutrient contents in the pore water of the sediments, which showed values of $15 \mu\text{mol l}^{-1}$ for nitrate, $10 \mu\text{mol l}^{-1}$ ammonium, $247 \mu\text{mol l}^{-1}$ silicate, $3 \mu\text{mol l}^{-1}$ phosphate; (Jaschinski, unpublished data). Thus, the high nitrogen and silicate concentrations in the water column resembled more an autumn or winter situation, whereas even then the silicate concentrations were ten times higher in our experiment as opposed to the field. The impact of water column nutrient enrichment on benthic algal biomasses are discussed controversially in the literature. Although Admiraal (1984) suggested that the nutrient pool in the sediment pore water should prevent nutrient limitation for the sediment microflora, other studies showed that an increased nutrient supply had a positive effect on algal growth

(Nilsson et al., 1991; Sundbaeck & Snoeijs, 1991, Rosemond et al., 1993). On the other hand, Hillebrand & Kahlert (2002) demonstrated that a high nutrient supply in the water column did not affect benthic algal biomass and, furthermore, they speculated that water column nutrients remained almost unavailable to benthic microalgae at least on short time scales. Nevertheless, especially benthic Cyanobacteria and diatom chains are known to be somehow related to water column nutrients as several studies detected biomass increases of those forms at high nutrient levels (Kann, 1940; Kann 1993; Yallop et al., 1994; Taylor & Paterson, 1998; Hillebrand et al., 2002; Nozaki et al., 2003).

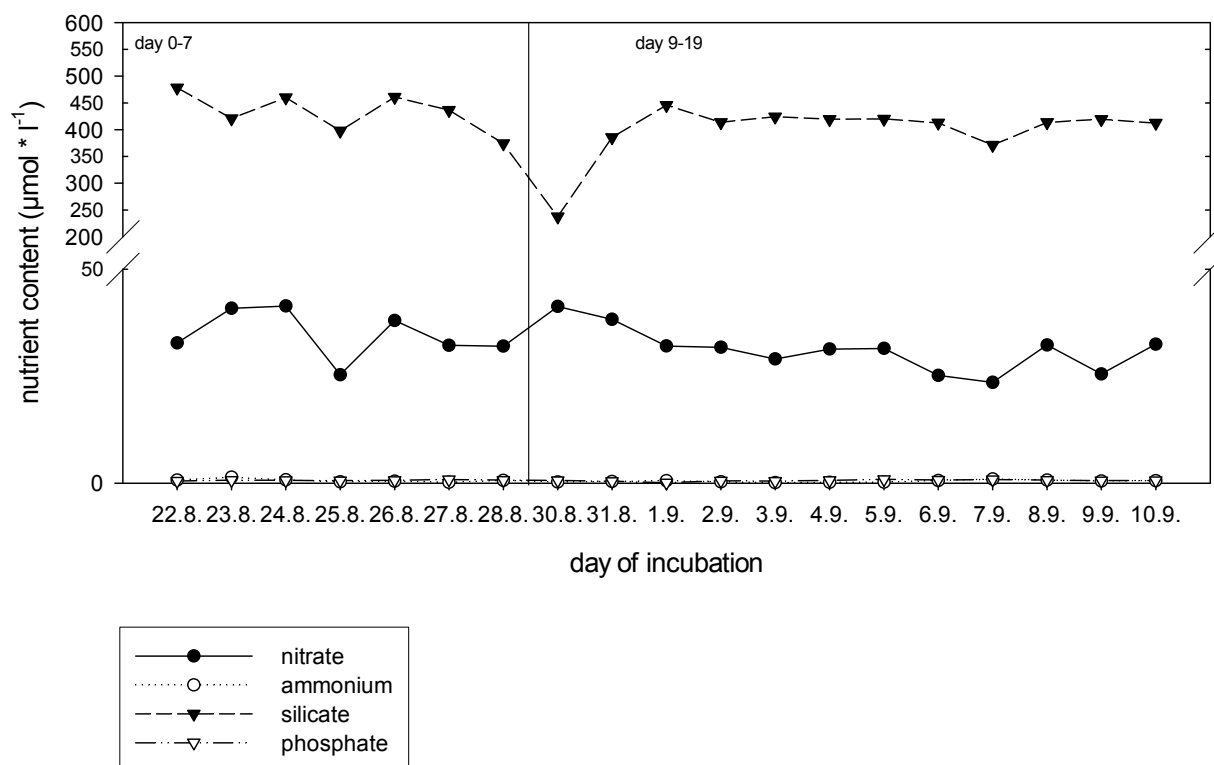

Figure 14: Nutrient concentrations ($\mu\text{mol} \cdot \text{l}^{-1}$) in the water-column of the experimental units measured from the inflow during the course of the freshwater mesocosm experiment (day 1-19).

Grazer effects & competitive interactions:

It was remarkable, that the proportions of prostrate and stalked diatoms remained almost constant in the grazer units and in the controls in the first week, whereas the shares of Cyanobacteria and diatom chains showed high variability. In some cases grazer presence and inter-specific competition favoured the dominance of cyanophytes (AR + G), whereas others showed a clear dominance of diatom cells (control, A, GR, AGR). This is in good correspondence to a grazing study conducted by Rosemond et al. (1993) which detected high cyanophyte biomass in the presence of grazers. In addition, Hillebrand & Kahlert (2001) have supported these findings in that they showed composition changes in algal

assemblages under grazing pressure, whereby the relative importance of Cyanobacteria was often enhanced.

Nutrient versus consumer effects:

Our data shows that shifts in the community compositions within the freshwater mesocosms most likely resulted from a combination of effects, both nutrient enrichment and grazer-specific selectivity. Throughout the experiment, the nitrate and silicate concentrations remained constant and an overall dominance of chain-forming diatoms occurred. Since the contributions of Cyanobacteria to the benthic food-web are still poorly understood, it remains unclear whether the relative proportion of cyanophytes declined due to grazing losses or as a result from nutrient competition. Since neither diatom chains nor cyanophytes showed grazer-dependent variations on the long-term, and as Cyanobacteria are in general considered to be a low quality or even toxic food source (Lampert, 1987; Blomqvist, 1996; DeMott, 1998), it can only be speculated that the dominance of chain-forming diatoms was triggered by the high nutrient supplies rather than by the invertebrates' grazing activity.

Detailed taxonomic composition

During the first incubation period, the controls as well as the grazer treatments showed similar proportions of algal taxa. These units differed slightly from the initial composition as a decrease of prostrate forms like *Pinnularia sp.*, *Stauroneis sp.*, and *Nitzschia sp.* was detected, whereas *Fragilaria sp.* and *Gomphonema sp.* showed higher proportions. In general, the taxonomic composition of the benthic microflora adjacent to or beneath the *P. perfoliatus*-beds in our experiment mainly comprised of taxonomic groups that are considered either as epiphytic or epipsammic. This is especially true for *Fragilaria sp.* which is known to occur on sediment surfaces (Miller et al., 1987; Winterbourn & Fegley, 1989; Hillebrand & Kahlert, 2002) and also as an epiphyte on macrophyte leaves in general (Ho, 1979) and on *Potamogeton*-blades specifically (Carlton & Wetzel, 1987). In addition, the stalked diatom *Gomphonema sp.* which was present at a lower proportion in the grazer units and the controls, has been documented as epipellic (Kann, 1940; Hill et al., 1992), as an epiphyte on *P. perfoliatus*-leaves (Kann, 1940) or on *Potamogeton sp.* (Carlton & Wetzel, 1987), as well as epipsammic (Wasmund; 1984). This genus is also characterised by its ability to adhere to solid surfaces as well as to sediment particles by forming mucilaginous pads.

The coccoid cyanobacterium *Merismopedia sp.* is characterized by a benthic-pelagic life cycle as this form typically comprises to the plankton and settles periodically from the water column in considerable amounts where it lives on (Potter et al., 1975; Blomqvist, 1996). *Merismopedia sp.* can be frequently found as "Aufwuchs" and on sediment surfaces (Kann,

1940; Agatz et al. 1999; Riethmueller et al., 2000). The only mentionable prostrate diatoms that made up the microphytobenthos to some extent were *Nitzschia sp.* and *Navicula sp.*. Those forms played a minor role within the total mesocosm community. This pattern is contradictory to studies conducted by Miller et al. (1987) and Wasmund (1984) as well as to our data from the Schöhsee, where epipellic and epipsammic assemblages were found to form distinct flat, two-dimensional communities, mainly comprising of prostrate, attached diatoms like *Navicula sp.*, *Nitzschia sp.*, *Pinnularia sp.* and *Stauroneis sp.*. In contrast, stalked or erect forms are usually considered to be minor components of the microphytobenthos. Thus, the three-dimensional habit of the sediment microflora in our experiment seems to have been atypical.

Nutrient effects:

A possible explanation for the replacement of prostrate forms with overstory algae could be an increase in water-column nutrients in the experimental units. As already mentioned in the section on “Major taxonomic groups”, the persistently high nutrient loads obviously favoured the overall dominance of *Merismopedia sp.* and *Fragilaria sp.*. Nutrient enrichment experiments conducted by Hillebrand et al. (2002) showed that the chain-forming diatom *Fragilaria sp.* increased in abundance when nutrients were added to the water column. Similar effects have been shown for cyanophytes as they are known to be triggered by water column nutrients and several studies detected biomass increases at higher nutrient loadings (Kann, 1940; Kann 1993; Hillebrand et al., 2002). But a potential fertilizing effect of *Merismopedia sp.* must be treated with caution, since Blomqvist (1996) documented that this cyanobacterium did not respond to nutrient additions and hence concluded that *Merismopedia sp.* was unable to use nitrate as nitrogen source. This is supported by a study of Agatz et al. (1999), who showed that *Merismopedia sp.* was mainly found at nutrient poor sites on a tidal flat. This could indicate, that the variations in relative proportions of Cyanobacteria in the grazer treatments we observed were probably related to the grazing activity of invertebrate grazers rather than to nutrient supply.

Grazer effects & competitive interactions:

However, the assumption that Cyanobacteria-consumption might have occurred is in contrast to studies which showed that grazing affects predominantly large erect or chain-forming species (Nicotri, 1977; Van Montfrans et al., 1982; Steinman et al. 1987; McCormick & Stevenson, 1989). Thus, a higher mechanical vulnerability of *Fragilaria*-cells rather than of the coccoid cells of *Merismopedia sp.* could be assumed. Furthermore, Cyanobacteria are in general considered as an inadequate, toxic food source (Lampert, 1987; DeMott, 1998) and, as pointed out by Blomqvist (1996), *Merismopedia sp.* in particular is not grazed in the

plankton. As a consequence of this he concluded, that this cyanobacterium may act as a dead-end in energy flow towards higher trophic levels. Unlike *Merismopedia*-cells, *Fragilaria sp.* is known to suffer high grazing losses. Other research has shown a high grazing efficiency by a variety of freshwater and marine consumers preying on *Fragilaria*-cells (Nicotri, 1977; Winterbourn & Fegley, 1989; Sommer, 1997). Chains of *Fragilaria sp.* seem to be a very edible and, additionally, a fast growing food source. Taking this into account it is most likely that varying Cyanobacteria proportions resulted from different degrees of *Fragilaria*-consumption rather than from Cyanobacteria grazing.

However, the proportions of *Fragilaria*-cells were not only generally related to grazer presence, but they also showed variation between grazer treatments. For example in the presence of *G. pulex* (G) and also when *A. aquaticus* and *R. ovata* co-occurred (AR), lowest proportions of *Fragilaria sp.* were detected. Thus, the degree of *Fragilaria*-consumption differed also between species and when grazers coexisted. Several previous studies have shown that co-occurring mesograzer species can have quite different feeding preferences (Moore, 1975; Shacklock & Doyle, 1983; Brendelberger, 1995; Constantini & Rossi, 1998; Duffy et al., 2001). The relative decline of *Fragilaria sp.* in the single-grazer treatments with *G. pulex* is interesting, since the impact of grazing amphipods is discussed controversially in the literature. Gammaridae are known to feed on a diverse array of food items, e.g. microalgae, detritus, and associated microbes (Moore, 1975; Zimmermann et al. 1979; Smith et al., 1982; Friberg & Jacobsen, 1994) and hence, this genus is considered more a generalist. Past research considered amphipods to be less efficient and less selective grazers compared with isopods and gastropods (Jernakoff & Nielsen, 1997; Duffy et al., 2001). However, their strong impact on benthic communities has been stressed (Duffy and Hay, 2000) and their selective potential shown (Shacklock & Doyle, 1983; Friberg & Jacobsen, 1994). A study conducted by Moore (1975) showed that diatoms were the most common algae ingested by *G. pulex* and that cyanophytes were consumed in relatively small amounts. Therefore, an active consumption of *Fragilaria*-cells by *G. pulex* at the sediment surface can be hypothesized. Similar patterns occurred for combinations of *A. aquaticus* and *R. ovata*, whereas the single-grazer units of both species did not show a reduction of *Fragilaria sp.* *A. aquaticus* is generally considered as herbivore or detritivore (Moore, 1975; Marcus et al., 1978; Constantini & Rossi, 1998). Gastropods are known to have overlapping food spectra (Lodge, 1986; McCormick & Stevenson, 1989; Norton et al., 1990; Rosemond et al., 1993; Jernakoff & Nielsen, 1998). Interestingly, both grazers did not show grazing pressure on *Fragilaria*-cells as long as they were separated, but in combination these diatoms declined. Potentially, one of these grazers changed its feeding mode slightly in the presence of a co-occurring species and this might indicate a shift in resource-partitioning. However, as this pattern occurred only in one of the combined grazer treatments this effect

was the exception rather than the rule. This is especially true as high food availabilities occurred in all of the treatments and resources were far from limited.

Nutrient versus consumer effects:

Even though slight grazing impacts could be detected after one week of incubation, this pattern disappeared after three weeks. In the long-term of the experiment a distinct dominance of *Fragilaria sp.* appeared in all different treatments and *Merismopedia sp.* became less important. This truly indicates that *Fragilaria sp.* was favoured by the constantly high nitrogen and silicate concentrations from the water column, and thus these diatom chains could out-compete other microphytobenthic forms. Finally, a monoculture of *Fragilaria sp.* developed and, as the population increased faster than it was grazed, the presence of consumers at natural abundances was unable to regulate the algal community. This is in contrast with studies conducted by Hillebrand & Kahlert (2001) as well as Rosemond et al. (1993) which showed that grazing had stronger effects on microalgal assemblages than nutrient supplies. However our results show the opposite.

In comparison with other enrichment studies, it must be pointed out that the nutrient level in the freshwater mesocosms were extremely high, especially in terms of silicate. To date studies on nutrient effects on benthic microalgal assemblages mainly focused on the aspect of eutrophication as a result from elevated nitrate, nitrite, ammonium or phosphorus concentrations whereas silicate levels were usually neglected. Thus, the comparability to other studies is limited. Nevertheless, it has been shown that water column nutrient enrichments affect only those species that are directly dependent on nutrient contents from the overlying water body (e.g. planktonic, benthic-pelagic or periphytic forms) but not sediment-dwelling algae (Blumenshine et al., 1997; Vadeboncoeur & Lodge, 2000; Hillebrand & Kahlert, 2002). The chain-forming *Fragilaria sp.* were previously shown to largely increase their biomass when nutrients were added to the water column (Hillebrand et al., 2002). Thus, the colonization- and growth-success of this form in the benthos seems to be highly related to water-column nutrient supplies and as long as sufficient resources are available this genus seems to be able to out-compete and to overgrow prostrate taxa. The described composition shift from prostrate diatoms to a dominance of the chained *Fragilaria sp.* resulted in a complete restructuring of the whole microphytobenthos community in the freshwater mesocosms.

This experiment provides evidence that extreme nutrient loadings in the long-term can affect microphytobenthic assemblages to a considerable degree and that consumers, at intermediate abundances, are unable to regulate algal biomasses. The high food quantities, however, seemed to boost the grazers' growth rates since all three grazers showed extreme biomass increases in the experimental units and, in addition, high reproduction rates were

observed during the course of the experiment for the gastropod *R. ovata* (Gohse-Reimann, pers. comm.). It can be speculated that at a longer duration of the experiment (> 3 weeks) the grazer effects could have potentially increased in the experimental units as increasing biomass and abundance of adult consumers could have then shown higher efficiencies. These patterns confirm the general assumption that the factors controlling the ups and downs in microphytobenthic communities are complex and that it is not useful to consider both, grazer consumption and nutrient, separately.

Diversity & evenness:

In general, high nutrient supplies are known to decrease the diversity of benthic microalgal assemblages (Sullivan, 1976; Carrick et al. 1988; Hillebrand & Sommer, 1997). Since the diversity and evenness in our mesocosm experiment declined after three weeks of incubation and no differences between grazer-treatments and controls occurred, this decline in diversity seems most likely to be linked to the high nutrient levels from the water column. This is closely correlated with total cell numbers, as, for example, with an increase in algal abundance a decrease in diversity was detected (figure 12). However, the observed decrease in evenness resulted from the dominance of the chain-forming diatom *Fragilaria sp.* rather than from a general loss in taxonomic groups, since the number of species and genera remained constant within the whole experiment.

When compared to diversity data obtained by Khondker & Dokulil (1988) for lake "Neusiedlersee" or to Schöhsee values (see Chapter 2), the diversity variables in the controls and the grazer treatments of our freshwater mesocosms can be considered relatively low. Therefore, our data could be best described by a univariate model predicting that diversity variables peak at intermediate resource supply or productivity and that H' and E decline as soon as nutrient concentrations increase as it was stated by several authors (Sullivan, 1976; Carrick et al. 1988; Hillebrand & Sommer, 1997; Kassen et al., 2000). Thus, the continuous decreases in diversity and evenness in our mesocosm were the consequence of persisting nutrient enrichment. The result was a shift from a relatively diverse and even distribution of the benthic microflora at the beginning of the experiment to an almost monocultural community after three weeks.

Conclusions

The microphytobenthic community in the freshwater mesocosms was severely affected by nutrient supplies since constantly high water-column nutrients resulted in a restructuring of the microphytobenthos over the course of the experiment. Significant decreases in diversity were the consequence. Grazer presence and competitive interaction influenced the sediment

microflora only on the short-term and consumers' impact decreased with increasing productivity.

General trends resulting from the freshwater mesocosm experiment are listed in table 3. Although constant chlorophyll concentrations were observed in the freshwater mesocosm, the number of algal cells steadily increase during the course of the experiment. Both parameters are usually considered to give good correlations, but possibly due to self-shading from overstory algae, this was not confirmed in our study. Taxonomic analysis showed that the sediment microflora was dominated by diatoms and Cyanobacteria after one week and that the proportion of cyanophytes decreased considerably after three weeks. However, due to the fact that Cyanobacteria are in general considered an inadequate food source, it can be speculated that the reduction of cyanophytes was more a result of them being out-competed by the very productive chained diatoms rather than from grazing loss. The persistently high nutrient loads in the freshwater mesocosms favoured the overall dominance of the cyanobacterium *Merismopedia sp.* and the diatom *Fragilaria sp.* during the first experimental period whereas on the long run chains of *Fragilaria sp.* persisted. Despite the high food availabilities in the experimental units, however, the consumption of microalgae in the short-term showed inter-specific variations and, in some cases, also effects of coexistence. Furthermore, diversity and evenness in the mesocosms declined during the course of the experiment and thus, these results support one of the major predictions of community ecology claiming that high nutrient supplies lead to decreased diversities in an ecosystem.

Table 3: General trends in freshwater mesocosms during the course of the experiment

parameter	incubation time: 7 days	incubation time: 21 days
chlorophyll <i>a</i> concentration	constant	constant
cell number	+	++
diversity & evenness	-	--
major taxonomic groups	chained diatoms, Cyanobacteria	chained diatoms
main genera	<i>Fragilaria, Merismopedia</i>	<i>Fragilaria</i>

Chapter 6

Selectivity and competitive interactions between two benthic invertebrate grazers (*Asellus aquaticus* and *Potamopyrgus antipodarum*)- an experimental study using ^{13}C - and ^{15}N -labelled diatoms.

The relevance of feeding selectivity and interspecific competition between herbivore grazers were the primarily focus of the study presented in this chapter. The aim was to investigate the aspect of assimilation and to distinguish between active and passive selectivity patterns. A stable isotope enrichment approach was successfully used elucidating major aspects that regulate microphytobenthic communities such as selectivity, competition, assimilation, nutrients as well as coexistence.

6.1 Introduction

Benthic microalgae contribute significantly to the primary production of shallow aquatic systems and serve as an ideal diet for small sized, grazing biota. They therefore play an important role in benthic food webs and are valuable food sources for a large variety of organisms (protists, meio- and macrofauna).

The literature on benthic grazing patterns consists of a diverse array of studies focussing on grazer-microalgae interactions to elucidate the impact of herbivory in benthic food-webs. Until now most studies concentrated on the possible effects of grazing on algal cell numbers, biomass and chlorophyll *a* (Steinman 1996, Feminella and Hawkins 1995, Hillebrand 2002). Most studies indicate a strong, direct impact of benthic grazers on benthic microalgal biomass, which often correlates with grazer density, specific grazer types, and feeding morphology (Lodge, 1986; Underwood & Thomas, 1990; Sommer, 1997; Chase, Wilson & Richards, 2001). Furthermore, the degree of digestion and the survival of gut passage by some microalgal species are factors that can also regulate grazer-microalgae interactions (Porter, 1973; Moore, 1975; Underwood & Thomas, 1990; Brendelberger, 1997 a,b) but this aspect of assimilation has mostly been neglected.

In this context, aspects gaining in importance are selectivity and feeding preferences, as these may be regulatory mechanisms for grazer-prey interactions in freshwater and marine systems (Steinmann, 1996; Feminella & Hawkins, 1995; Chase et al., 2001; Hillebrand, 2002). We distinguish between active selectivity (active choice of food component) and passive feeding preferences (by mechanism of food intake or digestibility). Most evidence points to a predominance of passive feeding preferences in grazer-microalgae interactions (Steinman 1996, Brendelberger, 1997a; Hillebrand et al. 2000). If grazers have differing assimilation efficiencies for different diatom species, microalgal community structure could affect benthic grazer communities because different food sources have different qualities. Selective or differential feeding may also be the primary cause for coexistence among grazer species that share resources. Differentiation in size ratios between coexisting snail species is a classical example of reduced niche overlap between competing species (Fenchel, 1975).

In recent years the use of stable isotope techniques have been used increasingly to investigate trophic interactions in freshwater and marine food-webs. Natural isotope compositions can be used for the analysis of food sources and trophic interactions (Peterson & Fry, 1987; Fry, 1988) as the stable isotope signatures of a consumer generally reflect the isotope composition of their diets in a relatively dependable manner (De Niro & Epstein, 1981, Post 2002). Moreover, labelling with stable isotopes can serve in a tracer concept allowing the investigation of flux processes or feeding habits. For example the stable isotope

^{13}C has successfully been used as a tracer for enrichment studies quantifying the uptake and incorporation of tracer carbon into body tissues (Levin et al., 1999; Middelburg et al. 2000, Aberle & Witte, 2003). Herman et al. (2000) also used stable isotopes as tracers in a dual labelling experiment where pelagic algae were enriched with ^{15}N and benthic algae with ^{13}C . We used this new tool to investigate the grazing of two co-occurring herbivores on prey of different size. The isopod *Asellus aquaticus* and the gastropod *Potamopyrgus antipodarum* differ in their feeding mechanism. Both invertebrates are abundant herbivores in the littoral zones of European freshwaters and are known to feed on, among other things, a variety of microalgal species (Marcus, Sutcliffe & Willoughby, 1978; James et al., 2000). Due to their high abundances they play an important role in freshwater food-webs and therefore serve as model organisms for the detection of trophic relations.

We used stable isotopic enrichment of food sources to investigate interspecific trophic interactions between two co-occurring herbivores, and specifically the differentiation of feeding selection, during competition as compared to isolated species treatments.

6.2 Material & Methods

Experimental design

Grazer preference experiments with *P. antipodarum* (size range 3 mm) and *A. aquaticus* (size range 5-6 mm) were conducted using four different treatments: a control treatment without grazers (C), two single-grazer treatments with *A. aquaticus* or *P. antipodarum* (A or P) and a combined-grazer treatment where both grazers were present (PA). Each treatment was replicated four times and the complete experimental set-up was duplicated to retrieve independent samples for two different incubation times (day 1; day 2). Erlenmeyer flasks (300 ml) served as experimental units and were filled with 100 ml filtered (0.2 μm) and autoclaved water from lake Schöhsee, Germany. Each culture flask from each treatment was inoculated with a mixed, labelled algal solution of 10ml of *Nitzschia palea* (26000 cells ml^{-1}) and 2 ml of *Fragilaria crotonensis* (61000 cells ml^{-1}). Different initial volumes of algal solution represented a comparable biovolume of each algal species. The grazer addition followed a supplementary design where grazer biomass in each treatment was kept constant. The number of individuals added to each experimental unit were calculated from the individual dry weights: eight *A. aquaticus* (5.6 mg total dry weight) in treatment A; ten *P. antipodarum* (6.0 mg total dry weight) in treatment P; and the mixed-grazer units (PA) containing four *A. aquaticus* and five *P. antipodarum* (5.8 mg total dry weight). At the end of the experiment, the animals were picked live from the flasks and oven dried at 60°C for 24h. Snail body tissues were removed from the shells after treating with 1M HCl-solution to dissolve inorganic carbon. For the determination of cell numbers and biovolume, 10 ml of the algal suspension were transferred into brown-glass bottles and fixed with Lugol's solution. To collect faecal

pellets for measurements of excretion of ^{13}C and ^{15}N by the animals, the remaining suspension was sieved through a 100 μm -gauze and the sieve-residues collected on a pre-combusted GF/F-filter. The residues were checked for purity under a binocular microscope to ensure that only faecal pellets, and no algal colonies were retained on the filters. Faecal pellet material from all four replicates of each treatment were pooled to obtain sufficient material for stable-isotope analysis.

For the determination of algal cell numbers and biovolumes, the Lugol's-fixed samples were mixed gently and 10ml of the sample immediately transferred to Utermöhl counting chambers (total volume 10ml). After leaving to settle for 24h, algal cells were counted under an inverted microscope and converted to biovolume following the methods of Hillebrand et al. (1999). The grazing rates per hour were calculated from the difference between the gross growth rate $\mu = (\ln V_c - \ln V_0) \times \text{h}^{-1}$ and the net growth rate $r = (\ln V_{gr} - V_0) \times \text{h}^{-1}$ (V_c = biovolume control; V_0 = biovolume start; V_{gr} = biovolume grazer treatment).

Stable isotope labelling

Prior to the experiment, the diatoms *Fragilaria crotonensis* (large-celled, sessile colonies) and *Nitzschia palea* (single-celled, mobile) were cultured at 17°C in artificial freshwater amended with WC medium (Guillard & Lorenzen, 1972). The axenic *F. crotonensis* cultures contained 30% $\text{NaH}^{13}\text{CO}_2$ (99 atom%; Chemotrade Leipzig) whereas 30% $\text{Na}^{15}\text{NO}_3$ (95 atom%; Chemotrade Leipzig) was added to the cultures of *N. palea*. The algae were cultivated in 500ml Erlenmeyer flasks under a 16h light:8h dark regime for four weeks. At the beginning of the *in-situ* labelling experiment the isotope signatures of the labelled cultures of *F. crotonensis* ($\delta^{13}\text{C}$ 30.4‰; $\delta^{15}\text{N}$ -15.4‰) and *N. palea* ($\delta^{13}\text{C}$ -19.6‰; $\delta^{15}\text{N}$ 488.8‰) as well as the background isotope signatures of unlabelled algae (*F. crotonensis*: $\delta^{13}\text{C}$ -22.5‰; $\delta^{15}\text{N}$ -15.9‰; *N. palea*: $\delta^{13}\text{C}$ -19.4‰; $\delta^{15}\text{N}$ -7.7‰) were determined.

Stable isotope analysis

Individual *A. aquaticus* were weighed into tin cups, whereas two or three individual *P. antipodarum* were pooled to obtain sufficient weight of nitrogen for a representative analysis. Tin cups were oxidised in a Carlo Erba NA 1500 elemental analyser coupled to a Micromass IsoPrime continuous flow isotope ratio mass spectrometer. Isotope ratios are expressed using the Δ -notation ($\delta^{13}\text{C}$, $\delta^{15}\text{N}$) in units of per mil (‰). Reference materials used were atmospheric nitrogen, and a secondary standard of known relation to the international standard of Vienna Pee Dee belemnite for carbon. Repeat analyses of an internal standard resulted in typical precision and accuracy of <0.2‰ for $\delta^{13}\text{C}$ and <0.4‰ for $\delta^{15}\text{N}$. The uptake of ^{13}C (and similarly for ^{15}N) by the herbivores was calculated as excess (above background) and is expressed as the specific uptake $\Delta\delta^{13}\text{C}$ ($\Delta\delta^{13}\text{C} = \delta^{13}\text{C}_{\text{sample}} - \delta^{13}\text{C}_{\text{background}}$). Thus, prior

to the labelling experiment, background (natural) isotope signatures of each grazer species obtained directly from Lake Schöhsee, were measured to substitute into the calculation of specific uptake. A selectivity index (Q) was defined as the quotient $\Delta\delta^{13}\text{C}/\Delta\delta^{15}\text{N}$, which expresses the relative uptake of ^{13}C compared to the uptake of ^{15}N .

Statistical analysis

To test for a significant impact of herbivores on algal biomass, and on ^{13}C and ^{15}N -uptake, a full-factorial ANOVA was used. Independent factors in both cases comprised time (F1) and treatment (F2). Algal biomass was log-transformed to reduce the observed heterogeneity in variance. No transformation was necessary for the ^{13}C - and ^{15}N -uptake as the variances showed no significant deviation from homogeneity. To test for significant relationships between the biomass-specific grazing rate and the ^{13}C - and ^{15}N -uptake, linear regression analysis were implemented. In addition, an ANOVA on selectivity was performed using the log-transformed dependent variable Q ($^{13}\text{C}/^{15}\text{N}$) and the independent factors time (F1) and treatment (F2).

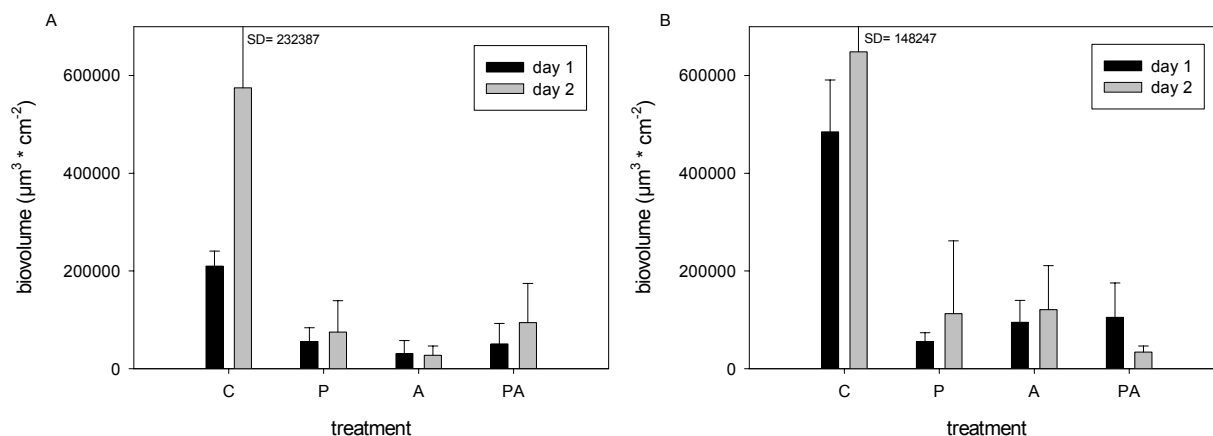

Figure 1: A) Biovolume (mean \pm SE) of *F. crotonensis* in control (C), single-grazer (P and A), and mixed grazer treatments (PA) on day 1 and day 2 of incubation. B) Biovolume (mean \pm SE) of *N. palea* in control (C), single-grazer (P and A), and mixed grazer treatments (PA) on day 1 and day 2 of incubation.

6.3 Results

Algal biovolume

The two grazers significantly reduced the biovolume of both algal species during both days of incubation (table 1). The biovolume of *F. crotonensis* increased in both control treatments, but showed a significant decline in all grazer treatments (figure 1A; $p = 0.0000$, table 1).

Grazer presence reduced the biovolume of *F. crotonensis* by 74-95 %. Although there appeared to be a marked decline in biovolume in the treatments containing only *A. aquaticus* (A) relative to treatments with the single grazer *P. antipodarum* (P) and the mixed grazers *A. aquaticus* and *P. antipodarum* (PA), a significant difference between grazer species was not detected. The grazing rates on *F. crotonensis* ranged from 0.04 (*P. antipodarum* as single-grazer, day 2) to 0.09 (*A. aquaticus* as single-grazer, day 1) μm^3 biovolume h^{-1} . A significant grazer effect was also detected for the reduction in biovolume of *N. palea* (figure 1B; $p=0.0000$, table 1), both in the single, and the mixed-grazer treatments (78-95 %). Again, there was no significant difference between grazer species. The biovolume of *N. palea* in the control treatments increased from day 1 to day 2. The hourly grazing rates for *N. palea* ranged from 0.04 (*A. aquaticus* as single-grazer, day 2) to 0.10 (*P. antipodarum* as single-grazer, day 1) μm^3 biovolume h^{-1} .

Table 1: Grazing on *N. palea* + *F. crotonensis* . Results of a full factorial ANOVA for total algal biovolume, with time and treatment as independent factors and total biovolume as dependent variable. Log-transformed data gave homogeneity of variance.

	(df)	MS	F-ratio	p-level
Grazer effect on <i>N. palea</i>				
Time	1	0.0172	0.23	0.6346
Treatment	3	1.8085	24.38	0.0000
Time x treatment	3	0.1323	1.78	0.1771
Error	24	0.0742		
Grazer effect on <i>F. crotonensis</i>				
Time	1	0.1924	1.245	0.2755
Treatment	3	2.0684	13.382	0.0000
Time x treatment	3	0.0976	0.631	0.6020
Error	24	0.1546		

Background isotope signatures

The two species showed clear differences in their natural (Lake Schöhsee) isotope composition, especially in $\delta^{13}\text{C}$. The mean $\delta^{13}\text{C}$ of *P. antipodarum* was $-21.5 \pm 1.3\text{‰}$ while *A. aquaticus* was $-23.6 \pm 0.1\text{‰}$. Mean $\delta^{15}\text{N}$ values were $4.4 \pm 0.4\text{‰}$ for *P. antipodarum* and $4.3 \pm 0.1\text{‰}$ for *A. aquaticus*.

Uptake ^{13}C and ^{15}N

Potamopyrgus antipodarum typically showed a higher $\Delta\delta^{13}\text{C}$ in comparison to *A. aquaticus* (figure 2A). After two days the specific uptake of *P. antipodarum* declined slightly whereas the uptake of *A. aquaticus* remained constant over time. Differences between single- and mixed-grazer treatments of both grazers were negligible. Despite these slight differences in specific ^{13}C -uptake, a univariate test of significance showed that the differences between grazer treatments were not significant (table 2). However, a Tukey HSD posthoc test revealed slightly significant differences between the single-grazer treatments with *P. antipodarum* and *A. aquaticus*. Both grazers can be considered isotopically identical to the ^{13}C -enriched cultures of *F. crotonensis*.

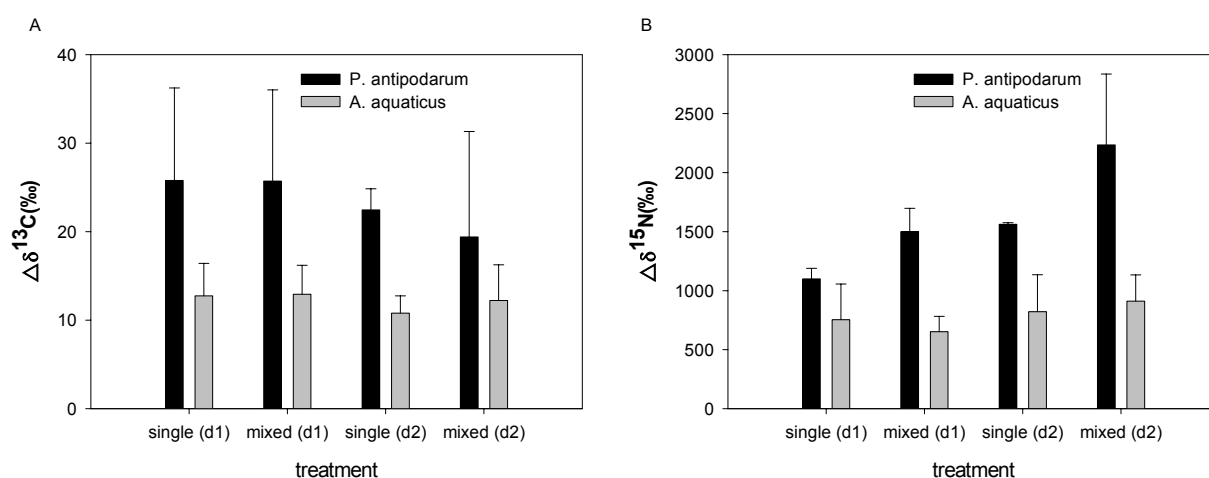

Figure 2: A) $\Delta\delta^{13}\text{C}$ (mean \pm SE) of *P. antipodarum* and *A. aquaticus* in the single- and mixed-grazer treatments after one day (day 1) and after the second day (day 2) of incubation. B) $\Delta\delta^{15}\text{N}$ (mean \pm SE) of *P. antipodarum* and *A. aquaticus* in the single- and mixed-grazer treatments after one day (day 1) and after the second day (day 2) of incubation.

Mean specific uptake of *N. palea* led to ^{15}N -enrichment of both grazers (figure 2B). $\Delta\delta^{15}\text{N}$ values were generally higher for *P. antipodarum* than for *A. aquaticus*, and were highest within the mixed-grazer treatments. The $\Delta\delta^{15}\text{N}$ of *P. antipodarum* appeared to increase on day 2, whereas the $\Delta\delta^{15}\text{N}$ of *A. aquaticus* remained relatively constant within the different treatments and with time. However, a univariate test of significance showed that these differences between treatments were not significant (table 2). The grazers exhibited $\delta^{15}\text{N}$ values two to four times higher relative to the ^{15}N -labelled *N. palea*-cultures.

There was no clear correlation between biomass-specific grazing rates and stable isotope-uptake, either for different treatments or for incubation time. The only positive correlation was found on day 1 between the ^{13}C -uptake and the biomass-specific grazing rate ($p = 0.049$), but this relation disappeared on day 2.

Table 2: Grazer ^{13}C / ^{15}N -uptake. Results of a full factorial ANOVA for tracer uptake, with time and treatment as independent factors and total ^{13}C - and ^{15}N -uptake as dependent variable. Untransformed data gave homogeneity of variance.

	(df)	MS	F-ratio	p-level
Grazer ^{13}C-uptake				
Time	1	82.480	1.5123	0.2346
Treatment	2	183.747	3.3690	0.0572
Time x treatment	2	42.392	0.7772	0.4745
Error	18	54.541		
Grazer ^{15}N-uptake				
Time	1	483903	3.4028	0.0816
Treatment	2	461023	3.2419	0.0627
Time x treatment	2	222760	1.5665	0.2359
Error	18	142206		

Faecal pellets

Stable isotope analyses of faecal material revealed distinctive signatures for *P. antipodarum*-pellets; the degree of ^{15}N -enrichment on days 1 and 2 was greater than ^{13}C -enrichment (figure 3). Faecal pellets of *A. aquaticus* were also ^{15}N - and ^{13}C -enriched, but to a lesser extent compared to *P. antipodarum*. Pellets measured from the mixed-grazer treatments showed intermediate values.

Selectivity Q

The selectivity index Q ($\Delta\delta^{13}\text{C}/\Delta\delta^{15}\text{N}$) showed significant variation over time and between single and mixed species treatments (figure 4, table 3). Both grazers showed a significant decline in Q between day 1 and day 2 (*A. aquaticus* $p=0.0013$; *P. antipodarum* $p=0.034$). Thus, a significant change in feeding preferences from day 1 to day 2 could be detected for both species, with a higher uptake of *F. crotonensis* (^{13}C) at the beginning of the experiment. Differences in selectivity between the single and mixed-grazer treatments of *A. aquaticus* could not be detected (table 3, figure 4). In contrast, the Q -values for *P. antipodarum* showed significant differences between the single- and mixed-grazer treatments ($p=0.0039$, table 3; figure 4). During the first day of incubation, *P. antipodarum* alone showed Q -values two times higher compared to individuals from the mixed-grazer treatments.

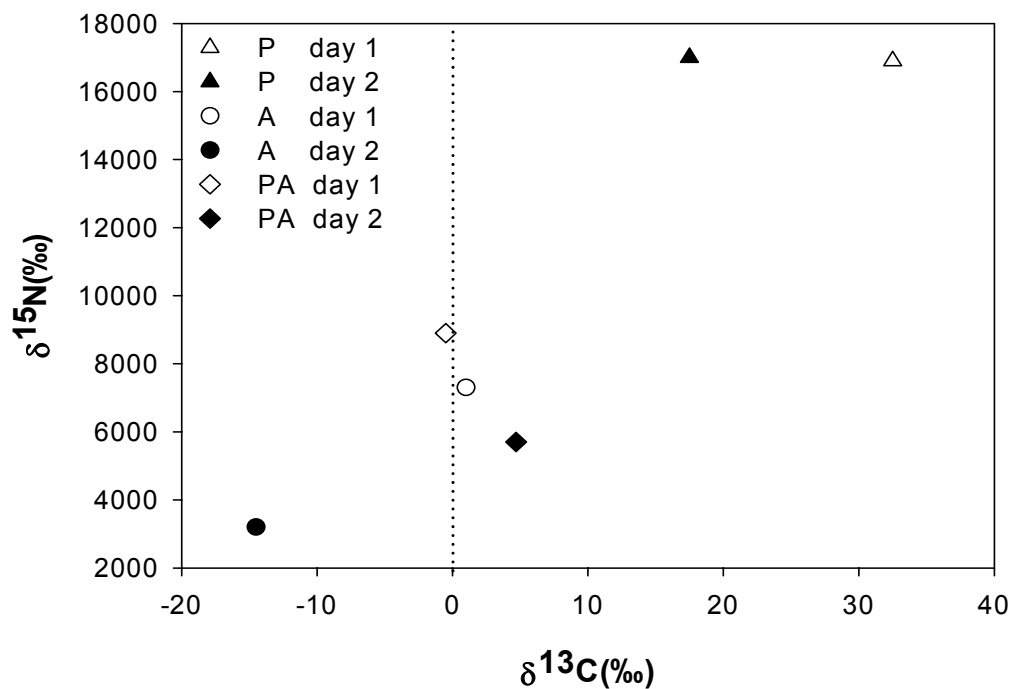

Figure 3: $\delta^{13}\text{C}$ and $\delta^{15}\text{N}$ of faecal pellets (single measurements) in single-grazer (P and A) and mixed grazer treatments (PA) on the first (day 1) and the second day (day 2) of incubation.

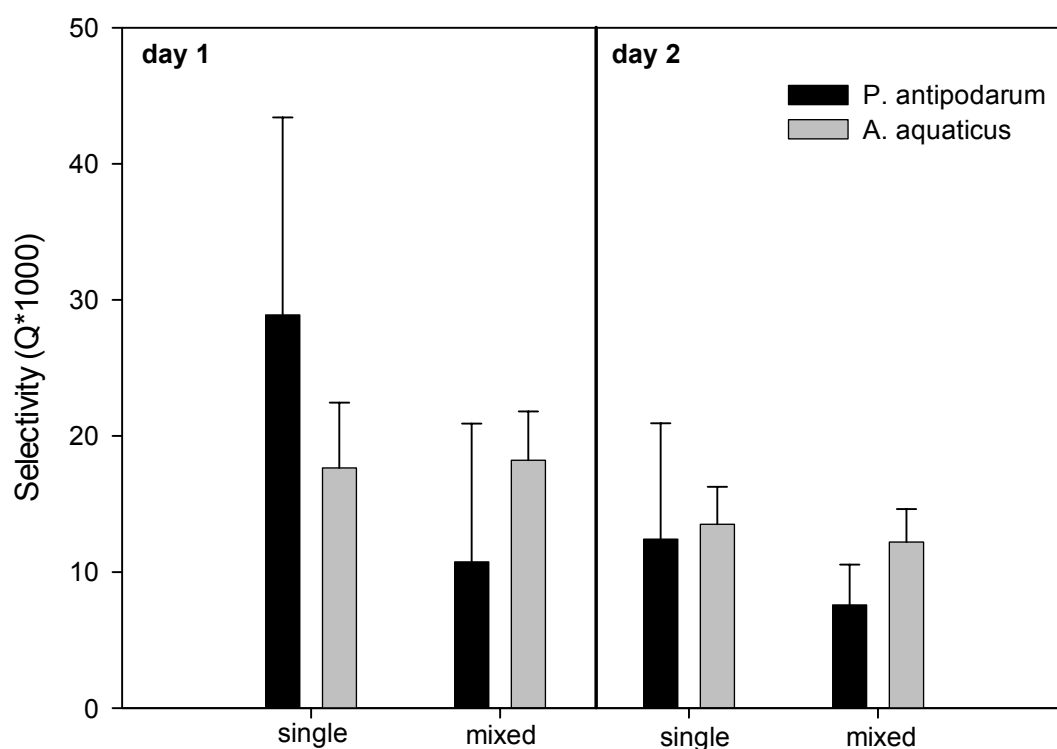

Figure 4: Selectivity index Q ($\Delta\delta^{13}\text{C}/\Delta\delta^{15}\text{N} * 1000$) of *P. antipodarum* and *A. aquaticus* in single-grazer (P and A) and mixed grazer treatments (PA) on the first (day 1) and the second day (day 2) of incubation (mean \pm SE).

Table 3: Selectivity Q. Results of an ANOVA for selectivity, with time and treatment as independent factors and Q ($\delta^{13}\text{C}/\delta^{15}\text{N}$) as dependent variable. Log-transformed data gave homogeneity of variance.

	(df)	MS	F-ratio	p-level
Q for <i>A. aquaticus</i>				
Time	1	0.3951	10.95	0.0013
Treatment	1	0.0179	0.495	0.4834
Time x treatment	1	0.0092	0.256	0.6144
Error	90	0.0361		
Q for <i>P. antipodarum</i>				
Time	1	0.464	4.71	0.034
Treatment	1	0.890	9.08	0.0039
Time x treatment	1	0.0041	0.042	0.837
Error	53	0.0985		

6.4 Discussion

We were able to detect differences between grazing and assimilation, as well as significant changes in food preference, of two co-occurring species as a result of interspecific competition, using differential labelling of algal food with stable isotopes. Such an outcome would have been difficult to observe with traditional methods.

Algal biovolume

A decrease in biovolume within microphytobenthic or epiphytic communities in the presence of invertebrate grazers is an expected pattern which has been detected in numerous studies (Steinman 1996, Feminella and Hawkins 1995, Hillebrand 2002). In general, it is assumed that the diet of *A. aquaticus* and *P. antipodarum* largely consists of diatoms, whereas both grazers are known to show selectivity patterns for different algal taxa (Moore, 1975; Marcus et al., 1978; James et al., 2000). The two grazer species consumed both microalgal species within our experimental set-up, indicating that the chosen diatoms were a suitable food source. No biovolume differences in consumption of algae were to be found between the grazer species, or over time. Therefore, using this particular methodological approach, no implications for active selectivity could be found. This is in direct contrast to our data derived from incorporation of stable isotopes. Evidently then, uptake and assimilation are not necessarily correlated, supported by the weak or absent correlations between grazing rates

per biomass and uptake of ^{15}N or ^{13}C . Stable isotope analyses appear to provide insights unobtainable from more classical grazing studies.

Background isotope signatures

The background isotope signatures of both grazers in our study were similar to values reported in the literature. James et al. (2000), observed $\delta^{13}\text{C}$ values of -19.5 to -22.5 ‰ for *P. antipodarum* from New Zealand lakes. Animals from the Schluensee, a neighbouring lake to the Schöhsee, were isotopically enriched in comparison to individuals from Schöhsee ($\delta^{13}\text{C}$ of -19.1 ‰ and $\delta^{15}\text{N}$ of 10.1 ‰ (Brendelberger, pers. comm.). *A. aquaticus* from Schluensee showed comparable $\delta^{13}\text{C}$ and $\delta^{15}\text{N}$ of -23.4 and 9.5 ‰ respectively (Brendelberger, pers. comm.), and similar to individuals from Windermere (-26.5 and 8.8 ‰) and Esthwaite (-26.5 and 6.0 ‰) (Grey, unpublished data). The natural isotope signatures of both these species reflects a dependence on microalgae as a food source, since microalgae typically show values of -22.6 ‰ to -19.4 ‰ (Hecky & Hesslein, 1995, James et al., 2000). Indeed, *A. aquaticus* and *P. antipodarum* both use macrophyte/epiphyte-communities in the littoral zones of lakes as habitats, and so an overlap of trophic niches between both grazer species seems likely.

Uptake of ^{13}C and ^{15}N

The $\Delta\delta^{13}\text{C}$ values for both invertebrates indicated a rapid uptake of ^{13}C from the labelled *F. crotonensis* but uptake by *P. antipodarum* was higher than by *A. aquaticus* (sketch 1). Although these results were not significant they still infer differences in ^{13}C -uptake from the large-celled, colony forming diatom *F. crotonensis*. Similarly, the uptake of ^{15}N via consumption of the single celled diatom *N. palea* resulted in considerable ^{15}N -enrichment of the animals on day 1. The $\Delta\delta^{15}\text{N}$ values were slightly higher for *P. antipodarum* relative to *A. aquaticus* but the differences were not as marked as for *F. crotonensis*.

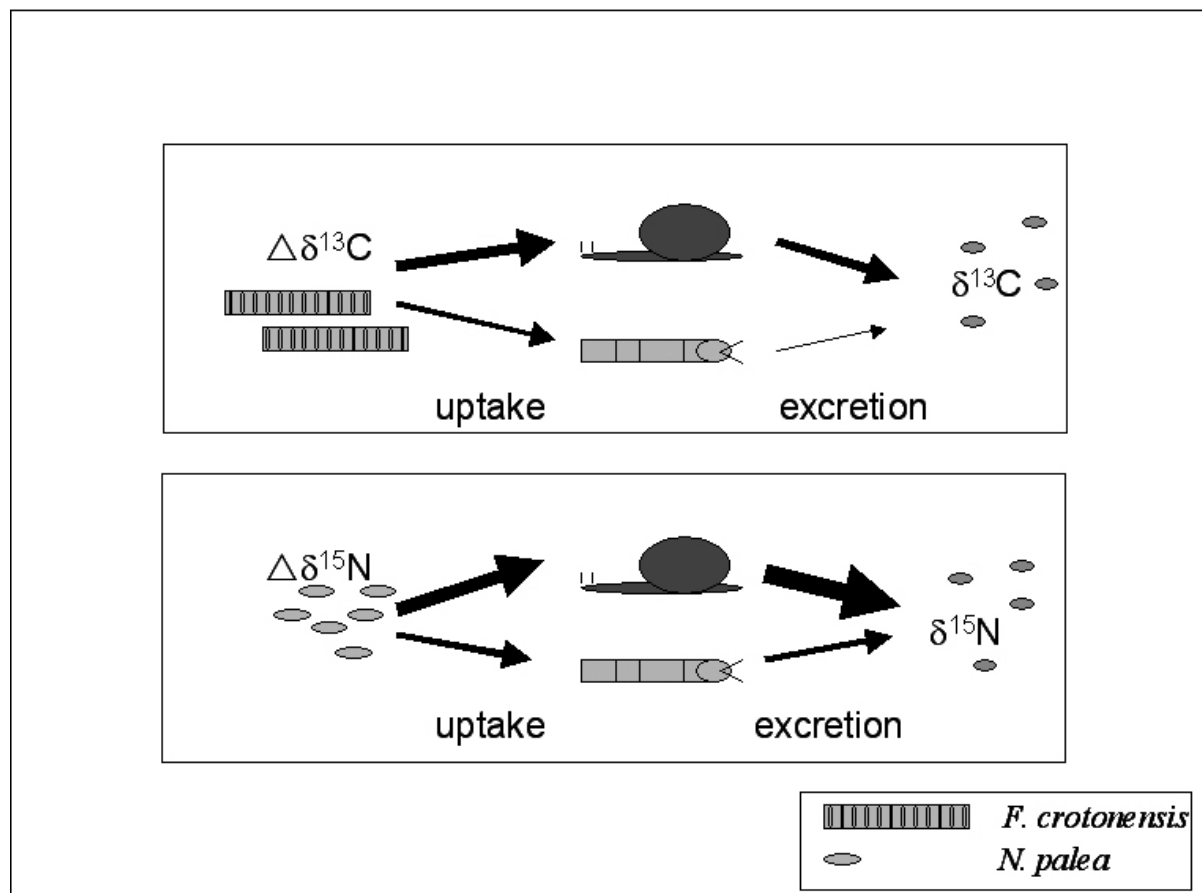

Sketch 1: Simplified diagram on the uptake of ^{13}C (top sketch) and ^{15}N (bottom sketch) by both grazers. Arrow thickness presents the relative amounts of uptake and excretion.

A possible explanation for the contrast in results from tracer uptake and algal biovolume might be due to different degrees of assimilation and digestion. Traditional methods such as the analyses of cell numbers, biovolumes or chlorophyll *a* content provide an overall view of the total amount of algae ingested within a particular time and therefore they can be used to detect active selectivity patterns. However, such methods do not provide detailed information on the actual degree of assimilation and digestibility. Digestion efficiency is known to be a function of cell wall structure, morphotype and defensive strategy that can influence digestive pathways (Moore 1975; Underwood & Thomas, 1990; Brendelberger, 1997b). Moore (1975) reported a very low digestive efficiency for *A. aquaticus* but could not find any evidence for cell size-dependent explanations. The digestive enzymes of *A. aquaticus* appear to show low penetration of diatom cells despite a gut evacuation time of 25 hours (Moore, 1975). Thus we might expect a less efficient uptake of ^{13}C and ^{15}N from the labelled algal material in our experiment. Not so much is known regarding the assimilation efficiency of *P. antipodarum*, but the much higher gut evacuation time of *P. antipodarum* (4.5 hrs.; James et al. 2000) suggests more efficient assimilation. We infer that *P. antipodarum* was able to digest *F. crotonensis* and *N. palea* more efficiently than *A. aquaticus* from the $\Delta\delta^{15}\text{N}$ and $\Delta\delta^{13}\text{C}$

values generated, and therefore that passive selectivity patterns occurred between both grazer species. The difference in digestion efficiency is even more striking for *F. crotonensis*, but we can only speculate whether this might be due to colony type, larger cell size or thicker cell walls.

Faecal pellets

When the $\Delta\delta^{13}\text{C}$ and $\Delta\delta^{15}\text{N}$ values derived for the animals are compared to the isotope composition of their faecal pellets it becomes obvious that an accumulation of ^{15}N and ^{13}C in the faecal pellets had occurred (sketch 1). The extent to which the accumulation took place differed, ^{15}N more so than ^{13}C , and particularly in the pellets of *P. antipodarum* (single grazer) after both experimental days. In comparison the pellets from the mixed-grazer treatments and the treatments with *A. aquaticus* as a single grazer showed much lower $\Delta^{15}\text{N}$ suggesting an active selectivity towards the lighter isotopes. Variability in isotope fractionation is becoming more widely recognised, but the causative factors are difficult to define in many circumstances and there are few experimental studies addressing such variation. Needoba et al. (2003) described significant differences in isotope discrimination between different algal groups and species. Studies on natural stable isotope signatures have shown that fractionation by metazoans can be rather variable or even species-specific (Macko, Lee & Parker, 1982; DeNiro & Epstein, 1981; Vander Zanden & Rasmussen, 2001; Post, 2002). Possible explanations for species-specific discrimination of heavier isotopes include differences in metabolic processes (e.g. protein synthesis), gastrointestinal assimilation, and excretion (Vanderklift & Ponsard, 2003). In addition, there seems to be a correlation between the level of isotope enrichment, and the C:N ratios of diets and consumers (Gorokhowa & Hansson, 1999; Adams & Sterner, 2000; Vanderklift & Ponsard, 2003). Our results suggest that the gastropod *P. antipodarum* discriminates more strongly between ^{15}N and ^{14}N compared to the isopod *A. aquaticus*. Indeed, both invertebrates exhibited discrimination in both carbon and nitrogen stable isotopes. Similar patterns have already been shown from natural stable isotope studies (Vander Zanden & Rasmussen, 2001; Post, 2002) and our data provide further support that an active fractionation had taken place and that these patterns were species-dependent.

Selectivity Q

Interpretation of $\Delta\delta^{13}\text{C}$ and $\Delta\delta^{15}\text{N}$ values requires care since the degree of isotope enrichment of both algal species was initially very different. Drawing comparisons between the ^{13}C - and ^{15}N -uptake is difficult. We do not treat the values derived from isotope uptake as absolute values. Direct comparisons should be drawn only between treatments rather than between the $\delta^{13}\text{C}$ and $\delta^{15}\text{N}$ values.

In contrast to a discrete consideration of $\delta^{13}\text{C}$ and $\delta^{15}\text{N}$ values, the Q value represents a ratio between both signatures and therefore it can be used to evaluate the relative importance of each diatom species to the diet of each grazer. This index enables detection of relative shifts in preference despite the difficulties in comparing the $\delta^{13}\text{C}$ values directly with the $\delta^{15}\text{N}$ values. Many studies have used two-end-member-mixing- models to determine the relative importance of two food sources to the diet of consumers (e.g. Vander Zanden & Rasmussen, 2001; Post, 2002). The advantage of this method is, that when using this model, the isotope data is corrected for fractionation effect first and afterwards the actual importance of each food source can be estimated. As ^{15}N fractionates more strongly than ^{13}C , that is generally considered to be constant, this correction is especially useful as far as nitrogen isotope signatures are concerned. However, an implicit assumption of the model is that the consumer is in isotopic equilibrium with its diet. Our experiment was of two days duration, a too short period for complete turnover of the experimental animal tissues, and thus precludes us from using such a model. We used the selectivity index Q even though it does not incorporate a fractionation factor. Excluding trophic fractionation may lead to an underestimation of the relative importance of ^{13}C within this study.

Each grazer treatment showed a significant effect of time indicating both grazers consumed a higher percentage of *F. crotonensis* during the first day of incubation, and subsequently switched to a *N. palea*-based diet on the second day (sketch 2a,b).

The shift from one food source to the other can easily be explained by changing food source, and the increased effort in gathering the more firmly attached *N. palea* compared to *F. crotonensis*. Since the biovolume of each algal species already had declined significantly after day 1 it seems likely that consuming the single-celled diatom *N. palea* (which presented a more uniform distribution within the experimental units) was a better feeding strategy than having to scavenge actively to find the few remaining colonies of *F. crotonensis*. The shift in preference from day 1 to day 2 indicates that as long as large amounts of different algae are available, an active selectivity takes place. However, as soon as food sources become limited, a rather unselective but more efficient feeding strategy is chosen. The correlation between food concentration and selectivity is a well known phenomenon in planktonic systems (Cowles et al., 1979; DeMott, 1995; Boenigk et al., 2002). Thus our assumption of concentration-dependent shifts in preference seems more likely.

Feeding preference based on Q-ratios

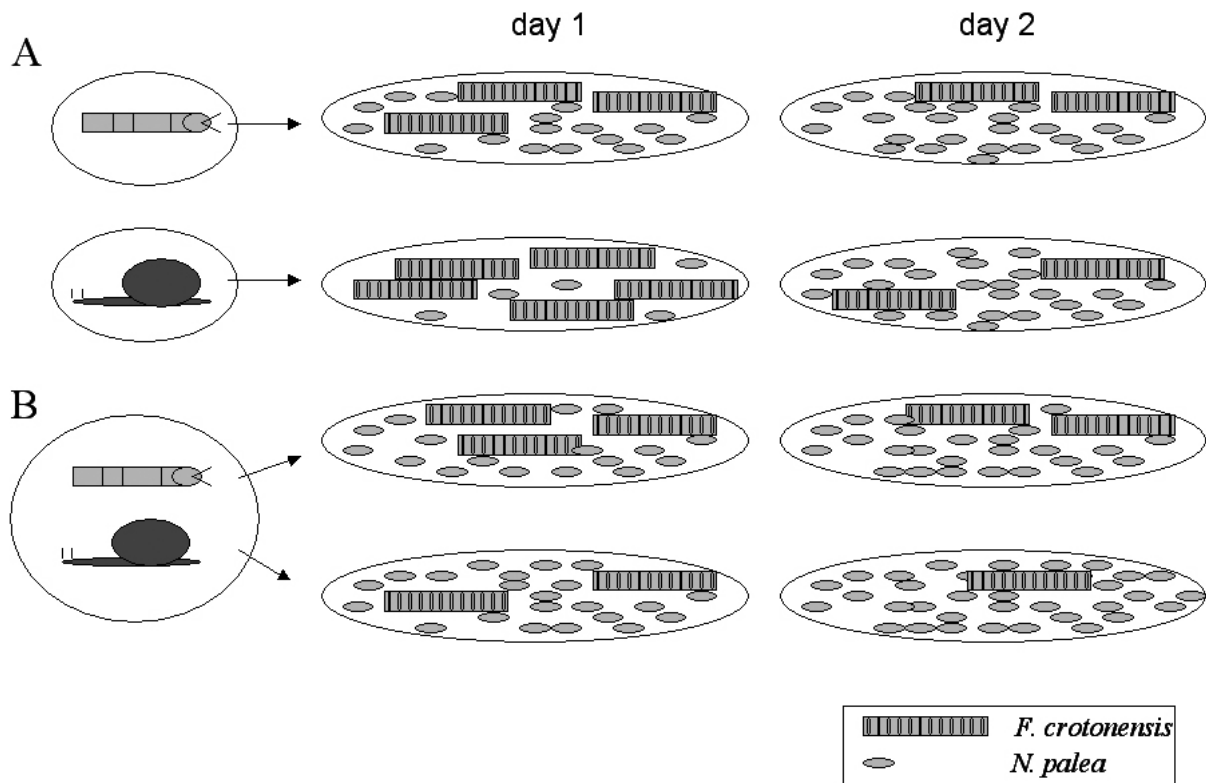

Sketch 2: Simplified diagram on feeding preferences of the two invertebrate grazers based on Q-ratios. (A) Showing single-grazer treatments and (B) mixed-grazer treatments.

In addition to the effect of time, a significant difference between single- and mixed-grazer treatments of the gastropod *P. antipodarum* was detected. This species only showed a preference for *F. crotonensis* while there was no co-occurring grazer present. When both invertebrates had to share food sources, *P. antipodarum* changed from a *F. crotonensis*-based to a *N. palea*-based diet (sketch 2b). The presence of *A. aquaticus* induced a shift in resource use of *P. antipodarum*. Differing mobility of the two species might be an explanation for the change in food preference. It is noteworthy that the more mobile grazer species (the isopod, *A. aquaticus*) was able to maintain the relative preference of *F. crotonensis*, whereas the less mobile snail switched to less preferred food. Many studies in community ecology have investigated the effect of inter-specific competition on the resource use of competitors. The central assumption of competition theory is that the strength of interspecific competition is inversely related to the amount of resource partitioning (Pacala & Roughgarden, 1982) but much discussion and debate regarding mechanisms that determine species coexistence with shared resources still remains (Ricklefs & Schluter, 1993; Gaston, 2000). Studies on the coexistence of species have often produced contradictory results (Costantini & Rossi, 1998; Rossi et al., 1983), whereas it appears clear from our study that there is an induced shift in

feeding preferences in the case of interspecific competition. However, the differentiation was based on digestion rather than ingestion and this gives evidence that passive selection may occur even if active selection does not. Since the biovolumes of *F. crotonensis* declined in the single- as well as in the mixed-grazer treatments, it is assumed that differential digestion results from different gut evacuation times, digestion efficiencies, or digestive enzymes. Our data confirm that the actual abundance of grazed algal cells does not automatically reflect the real amount of digested material. Insights into grazer feeding preferences in microphytobenthic systems achieved from a new combination of stable isotope labelling, have provided us with a basis for further experiments on feeding preferences and resource partitioning.

Chapter 7

General Discussion

The present study outlines system-specific characteristics of microphytobenthic communities and it provides further insights into their ecological role in shallow aquatic environments. Microphytobenthic assemblages in various habitats were investigated emphasising their overall significance in benthic food-webs and the complexity of trophic linkages. This work was divided up into an assessment of communities *in situ* and this provides the basic information for investigations of grazer-microalgae interactions.

Microphytobenthic community structures

Life cycles & dynamics

Microphytobenthic assemblages in the intertidal of the Wadden Sea site (Dorum) and on sediments in the Schöhsee were characterized by distinct seasonality and succession patterns. These changes in microalgal abundance were directly linked to community shifts and thus each season was characterized by a particular taxonomic composition. The observed seasonality and succession patterns are similar to pelagial communities and they were also confirmed for microphytobenthic assemblages. However, such studies dealing with seasonal variability in the microphytobenthos mainly focussed on intertidal marine or estuarine habitats (Admiraal & Peletier, 1980; Blanchard & Cariou-Le Gall, 1994; De Jonge & Colijn, 1994) whereas similar investigations on the freshwater microphytobenthos are rare. However, the few seasonality and succession studies addressing freshwater sediment communities (Khodker & Dokuli, 1988; Nozaki et al., 2003) are in good correspondence to data achieved for Schöhsee sediments. Thus, the fact that microphytobenthic communities in the Wadden Sea and in the Schöhsee showed similar seasonality patterns confirms the assumption that such successions are a general feature of temperate sediment communities rather than distinct characteristics of particular aquatic habitats.

Growth structure & habits

The taxonomic composition of the microphytobenthos at the marine and the freshwater site in this study were characterized by similar two-dimensional communities. Both habitats were dominated by pennate, prostrate diatom taxa with either epipsammic or epipelagic life styles. These forms are typical for variable environments (sand, mud) where disturbance plays an important role in structuring the algal community. Stalked or chained forms occurred only sporadically and thus they were a minor component of the microphytobenthos at the Wadden Sea site and on Schöhsee sediments. Miller et al. (1987) originally described the morphological habit of distinctly flat, two-dimensional communities for freshwater sediment communities and opposed them to the three-dimensional community structure of epiphytic and periphytic community structures. The field assessments at both sites confirm these growth patterns and thus, despite the differences in habitat characteristics, such habits most likely can be generalized for microphytobenthos assemblages.

These findings are in direct contrast to community patterns observed in the freshwater and marine mesocosms where a transition from an initially prostrate to an erect community structures had developed with course of the experiments. In the long run, the sediment microflora in the mesocosms was dominated by large, chain-forming diatoms which considerably restructured the microphytobenthic community. As already pointed out before (Chapter 2.1), such three-dimensional growth forms are typical for epiphytic or periphytic algal assemblages and thus, the question was posed whether sheltered microphytobenthic communities adjacent to or beneath macrophyte beds would probably contradict the typical microphytobenthos habit. It can be speculated that the mesocosm sediments in close vicinity to macrophytes were potentially colonized by epiphytic diatom species which have settled from the macrophytes' leaves. However, the literature to date neglects the coupling between macrophyte-epiphyte communities and the sediment microflora and until now only few studies considered this habitat as a whole (Sullivan & Moncreiff, 1990; Moncreiff & Sullivan, 2001). The present study indicates that the microphytobenthos in association with vascular plants or macroalgae shows pronounced differences to microphytobenthic communities on macroscopically un-vegetated, open sand or mud surfaces. Thus, a three-dimensional habit might not only be a characteristic feature of algal assemblages on hard substrate but also of the sediment microflora sheltered by macrophyte beds. It must be pointed out that there is an ecological need for investigations on such complex macrophyte-epiphyte-microphytobenthos ecosystems and that further developments in this research field are required if we wish to fill the gaps in this field.

Food web interactions and trophic linkages

Studies on grazer-microalgae interactions have a long tradition in benthic aquatic ecology and despite intense research in this field for decades a lot of debate still remains (Underwood & Thomas, 1990; Miller et al., 1996). Past research has provided extensive information on the significance of herbivory in regulating such complex ecosystems like salt marshes, macrophyte beds and sediment communities. Grazer effects can be considered as highly complex and variable since they depend on grazer types, abundances as well as on external parameters e.g. nutrient contents or food availabilities. Most of the former experimental studies have considered the grazer community to be a relatively homogeneous functional group grazing unselectively on microalgae and detritus (Edgar 1990; Jernakoff et al, 1996). However, investigations on feeding preferences and selectivity by consumers have emphasized the overall importance of particular grazer species in regulating benthic ecosystems (Duffy & Hay, 1994; Brendelberger, 1995; Jernakoff & Nielsen, 1997; Sommer, 1997; Duffy & Hay, 2000).

Grazing efficiency and active selectivity of *P. antipodarum*

The hydrobiid snail *Potamopyrgus antipodarum* was subject of two different grazing studies; the first one emphasising grazing patterns and feeding preferences in general, and the second one focussing on competitive interactions as well as on the aspect of active versus passive selectivity. Gastropods are assumed to be generalised browsers grazing rather unselectively but with a high spatial efficiency on a diverse array of food items (Underwood & Thomas, 1990; McCormick & Stevenson, 1991; Sommer, 1997). However, several studies from periphytic or epiphytic communities also demonstrated particular preference of gastropods for large-sized, overstory microalgae (Nicotri, 1977; Hunter, 1980; McCormick & Stevenson, 1991).

In this study the emphasis lay on the grazer impact of *P. antipodarum* as this species is known to be an effective grazer on benthic microalgal assemblages in freshwater lakes (Fenchel, 1975a; Dorgelo & Leonards, 2001; Broekhuizen et al. 2002) and it was a dominant species in our system. In the first experiment on the grazing activity of *P. antipodarum* clear trends for grazer efficiency were not found. It was shown that these snails can have both positive (fertilizing) and negative effects on microphytobenthic algal biomass. In the literature it has been assumed that such interplays between positive and negative effects are mainly caused by selective or differential grazing. However, the present study showed that in some cases specific genera benefited from grazer presence and in other cases the same taxa were strongly preyed upon. Accordingly, the diversity of the algal assemblage remained unaffected by these gastropods eluding to their rather unselective feeding mode. Thus, the morphology and size-dependent features of benthic microalgae that are known to facilitate

snail grazing in periphyton or epiphytic communities seem to be neglectable in case of *P. antipodarum* grazing on sediment surfaces. However, the selective potential of this species when grazing on epiphytes on macrophyte leaves was stressed by James et al. (2000a). This may originate from the fact that the structure of the microphytobenthos contrasts considerably the three-dimensional habit of biofilms on solid substrates, e.g. epiphytic and periphytic communities. As already pointed out before, large, erect or chain-forming microalgae are usually missing on sediment surfaces. Consequently, morphology-triggered feeding preferences might be irrelevant for grazers preying on microphytobenthic assemblages. Distinct differences in grazing patterns between sediment communities and solid substrates can be assumed.

Despite the typical characteristics of a microphytobenthic community, it has increasingly been seen that benthic algae may not be strictly edaphic and that planktonic forms can temporarily dwell on sediments (Drebes, 1974, Gätje, 1992; De Jong & De Jonge, 1995). Such benthopelagic microalgae are characterised by distinct morphotypes e.g. long chains, and thus, such forms can occasionally play an important role in restructuring microphytobenthic assemblages. In order to intensify investigations on the selective potential of *P. antipodarum* and to expand these studies on different growth forms of algae, an additional grazing experiment was conducted. The emphasis was to show whether *P. antipodarum* can really be considered as the unselective grazer as proposed above, or whether it shows feeding preferences in case of distinct morphological differences between diatom taxa. If so, this would indicate changing feeding habits depending on the substrate type grazed by the snails. Since *P. antipodarum* is known to prey upon microphytobenthos as well as on epiphytes this aspect was of considerable relevance in order to clarify its selective potential. For this purpose two different diatom species were chosen as food sources; the large-celled, chain-forming *Fragilaria crotonensis* and the single-celled, prostrate form *Nitzschia palea*. The genus *Fragilaria* sp. is characterized by a benthopelagic life cycle (Round et al., 1990) and it is known to temporarily reside at sediment surfaces. This genus frequently contributes to large amounts to the population dynamics of the sediment microflora by forming an overstorey within the microalgal mat (MacIntire & Overton, 1971; Nicotri, 1977). In order to investigate potentially morphology-triggered feeding preferences of *P. antipodarum*, tracer experiments with these diatoms labelled with stable isotopes were conducted. Data from the labelling experiment showed clear feeding preferences of *P. antipodarum* for chains of *F. crotonensis* and thus, this supports the assumption that these snails are potentially able to select for particular morphotypes. On exclusively two-dimensional sediment communities dominated by small prostrate forms, however, there seems to be no necessity for the development of feeding preferences by *P. antipodarum*. However, it can be speculated that food choices may be of higher relevance when these

snails are grazing on three-dimensional communities were a large variety of overstory algae are known to occur. These results indicate that *P. antipodarum* has the potential to select food items by its growth forms or morphology and consequently, these gastropods' can be regarded as facultative selective depending on the community structure of the grazed surfaces.

Passive selection and competitive interactions

A labelling experiment was, however, not only used to provide further insights on the role of active selectivity by *P. antipodarum*. In addition, it was carried out to understand competitive interactions between the gastropods and the herbivore isopod *Asellus aquaticus* and to detect pronounced differences in tracer uptake in case of species coexistence. From stable isotope ratios it was shown that *P. antipodarum* only showed a preference for *F. crotonensis* while there was no co-occurring grazer present. When both invertebrates had to share food sources, *P. antipodarum* changed from a *F. crotonensis*-based to a *N. palea*-based diet. Thus, the presence of *A. aquaticus* induced a shift in resource use of *P. antipodarum*. Differing mobility of the two species were assumed to cause the change in food preference. Many studies in community ecology have investigated the effect of inter-specific competition on the resource use of competitors. The central assumption of competition theory is that the strength of interspecific competition is inversely related to the amount of resource partitioning (Pacala & Roughgarden, 1982) but much discussion and debate regarding mechanisms that determine species coexistence with shared resources still remains (Ricklefs & Schluter, 1993; Gaston, 2000). It appears clear from this study that there is an induced shift in feeding preferences in the case of interspecific competition and thus, the present study support the theory of divergences of trophic niches through competitive interactions. It was distinguished between the qualitative uptake of carbon and nitrogen sources and on the quantitative selection of different food items. Thus, these techniques successfully enabled the direct quantification of the grazers' uptake and assimilation and therefore served as an ideal tool for the detection of passive selectivity. The differentiation, however, was based on digestion rather than ingestion and this provides evidence that passive selection may occur even if active selection does not.

Induced diversity shifts- consumer versus nutrient effects

These simplified, straight-forward grazing experiments were expanded into more complex investigations on grazer-microalgae interactions including higher trophic levels. For this purpose mesocosm experiments were conducted to study the impact of various combinations of macrograzers on the sediment microflora both by simulating a freshwater and a marine habitat in the laboratory. Since the coupling between plant-epiphyte

communities and the sediment microflora have mostly been neglected in benthic research to date, these mesocosm experiments focussed on microphytobenthic communities beneath and adjacent to macrophyte beds. These studies were aimed at evaluating the trophic significance of the sediment microflora in macroscopical vegetated, submersed habitats.

The emphasis of this investigation was to outline the functional role of several herbivore species in influencing ecosystem processes whereby the aspects of feeding preferences, competitive interactions and induced diversity shifts were of special interest. Among other grazers, the impact of snail grazers on microphytobenthic communities was also of particular interest in the present study, although gastropods with larger body sizes were considered this time (*Littorina littorea* and *Radix ovata*).

The diversity of a system can be used as an indicator for the detection of environmental conditions since diversity variables are known to reflect external parameters like physical disturbance, grazing pressure or resource supply (Agatz et al., 1999; Worm et al., 2002; Mitbavkar & Anil, 2002). However, the amplitude to which each of these factors contributes to a systems' diversity is still a key question in aquatic ecology leading to controversial discussions. Feeding preferences and selectivity by grazing organisms are known to form distinct community structures and thus their governing role in benthic food webs has been pointed out by several authors (Duffy & Hay, 1994; Jernakoff & Nielsen, 1997; Sommer, 1997; Duffy & Hay, 2000). In addition, Pacala & Roughgarden (1982) have stressed the significance of inter-specific competition on resource partitioning and the overall impact of coexistence.

Apart from grazing activity, productivity and resource supply are factors that can influence diversity (Sullivan, 1976; Carrick et al. 1988; Hillebrand & Sommer, 1997; Kassen et al., 2000; Worm et al., 2002). Thus, nutrient concentrations in the sediment and in the overlying water body can regulate community structure of benthic algal assemblages (Admiraal, 1984; Hillebrand & Sommer, 1997; Hillebrand & Kahlert, 2002; Mitbavkar & Anil, 2002).

To date there is a consensus that all the previously mentioned variables show a relationship with diversity, when manipulated in isolation (Connell, 1978; Tilman, 1994, Kassen et al., 2000). Recent studies, however, emphasized that multivariate models should be addressed since the diversity of a system is triggered by an interaction of factors rather than from unimodal relationships (Worm et al., 2002). Thus, these authors developed a 'consumer versus resource control'-model stating that shifts in diversity are induced by a combined change in grazer activity and nutrient supply. Moreover, they showed that in case of low or intermediate grazing pressure and high productivity the diversity of a systems decreases significantly.

In this study community shifts in the freshwater and the marine microphytobenthic assemblages were found to be induced by grazer presence and nutrient enrichment

respectively. Despite the high food availabilities in the experimental units resulting from constantly high nutrient concentrations, the consumption of microalgae in the short-term indicated inter-specific variations and competitive interactions. On the long run, however, persisting nutrient enrichment induced decreases in diversity and evenness in the mesocosms leading to enormous microphytobenthos biomass and almost monoculture conditions. Accordingly, consumers at intermediate abundances were able to control algal biomass but, as soon as productivity exceeded grazing losses, the equilibrium collapsed. Over the course of the experiments clear shifts from a relatively diverse and even distribution of the sediment microflora to mass occurrences of only few genera were observed and nutrients took on a governing role. Thus, data from the mesocosm experiments support the 'consumer versus resource control'-model predicting that diversity variables peak at intermediate grazer abundance and intermediate productivity and that diversity variables decline as soon as productivity exceeds grazing pressure (Worm et al., 2002).

Future prospects

The present study outlines several trends which contribute considerably to further understanding on microphytobenthic assemblages and on trophic linkages between the sediment microflora and invertebrate consumers. Furthermore, some fundamental ideas have been raised and applying these aspects in future approaches could consolidate a profound knowledge on grazer-microalgae interactions. Three aspects can be summarized as major interest:

Improved methods for large scale assessments

The development of a new algal sensor in this study now allows monitoring algal assemblages on larger scales enabling non-retrospect assessments. Apart from monitoring the total chlorophyll concentrations at the sediment surface, the benthic fluoroprobe now enables a rapid evaluation of the community structure and distribution *in situ*. The necessity of developing such a device arose from the fact that sampling sediment surfaces for the determination of microphytobenthic assemblages with traditional methods rapidly revealed several drawbacks: a time-consuming enumeration and large financial effort of adequately sampling sediment communities on larger scales. In order to improve quantitative and qualitative assessments with high spatial and temporal resolution, this benthic sensor was devised. Apart from monitoring the total chlorophyll concentrations at the sediment surface, the benthic fluoroprobe now enabled a rapid evaluation of the community structure and distribution *in situ*. Applying the benthic fluorometer will facilitate field assessments allowing higher resolution of both seasonality and community patterns with higher accuracy *in situ*.

Comparisons between numerous habitats and even inter-annual variability might be easily assessed and thus, this technique represents a challenge for future application.

Uptake versus assimilation

The technique of labelling various food items with different stable isotopes was developed in the present study in order to investigate the aspect of assimilation and to distinguish between active selectivity (active choice of food component) and passive feeding preferences (by mechanism of food intake or digestibility). These factors are hardly detectable with traditional methods and thus, the stable isotope enrichments successfully enabled the direct quantification of the grazers' uptake and assimilation. Passive selectivity patterns were detected indicating that passive selection may occur even if active selection does not. This first attempt to use the labelling-technique to differentiate between active and passive selection seems very promising. Therefore, applying this method to further investigations on food-web interactions and on resource partitioning of coexisting species would be a challenge.

Consumer versus nutrient effects

The mesocosm experiments simulating macrophyte habitats pointed to the overall relevance of consumer presence and nutrient effects in affecting the microphytobenthos population. In this study community shifts from a diverse microphytobenthic assemblage to an assemblage mainly comprising of only few genera were induced predominantly by high water column nutrient concentrations. An initially two-dimensional community was restructured by developing a third dimension. It can be hypothesised that the sediment microflora and adjacent macrophyte beds are in strong conjunction with one another and that in the case of high water column nutrients the microphytobenthos is invaded by epiphytes from macrophyte leaves and by benthopelagic forms. The strong competitive potential of these forms observed in the present study indicate that three-dimensional community structures on sediment surfaces might be the rule in case of high water column nutrients. Thus, the transition from a two-dimensional to a three dimensional community and an outline of the turning points are of special interest for further investigations.

Outlook

The present study addressed manifold aspects of interactions between microphytobenthos populations and herbivore consumers. Several characteristics of the complex sediment community structure were elucidated leading to new ideas for future approaches. To fill the gaps in microphytobenthos research some of the posed questions could stimulate intense

investigations especially in the field of freshwater sediment microflora. Applying these future approaches could establish a consolidated knowledge on microphytobenthic ecosystems.

Chapter 8

Summary

Microphytobenthos represents an important component in freshwater and marine habitats as it contributes significantly to the primary production in shallow-water ecosystems and benthic microalgae biomass supports higher trophic levels. Microphytobenthic assemblages are found in all sorts of sediments ranging from salt marshes, intertidal sand and mud flats, submerged macrophyte beds as well as subtidal sediments. The microphytobenthos modifies substrate characteristics by forming special matrices in which sediment particles and algal cells are embedded and it is a reliable and highly nutritious food source for micro-, meio- and macrofaunal grazers in shallow aquatic ecosystems.

In marine systems it has become clear that microphytobenthic communities are very significant both in terms of their wide-spread spatial distribution and ecological relevance. In contrast, their potential importance in freshwater littoral zones and especially in lakes has received little attention. Where benthic microalgae in limnic habitats have been addressed, investigations focussed predominantly on epiphytic or periphytic communities and studies on the sediment microflora are rare.

This study had the main aim of elucidating which microphytobenthic community structures and key organisms were important *in situ* and then, based on this, to differentiate key grazer-microalgae interactions. In order to achieve this I measured diversity and evenness over short seasonal ranges in freshwater and in intertidal marine sediments. The assessments of microphytobenthic communities were carried out to evaluate succession patterns at two ecologically relevant and contrasting sites. These investigations were to provide enhanced knowledge on taxonomic composition, seasonal and temporal variations, structures and morphological habits of the microphytobenthos.

Pronounced seasonality and succession patterns were a typical feature of the marine, intertidal sediments both in the Wadden Sea and of freshwater subtidal regions in the Schöhsee. Chlorophyll concentration and cell numbers at these sites were concentrated predominantly on the spring period and decreasing values were found in summer. The chlorophyll concentrations in surface sediments showed similar values for Schöhsee and Dorum although cell numbers were much higher at the Wadden Sea site. The freshwater microphytobenthic assemblage was characterized by higher diversities than the marine

microphytobenthos. Clear shifts in community composition occurred at both sites showing changing taxonomic compositions at different times of the year. The algal assemblages on Dorum and on Schöhsee sediments were characterized by a distinctly flat, two-dimensional community which is considered a typical feature of the microphytobenthos. However, the dominant taxa found on Schöhsee sediments showed distinct differences to those observed at the Wadden Sea site. In the Schöhsee mainly the genera *Synedra*, *Fragilaria*, *Nitzschia*, *Stauroneis* and *Navicula* were common. On Wadden Sea sediments *Navicula*, *Cylindrotheca* and *Merismopedia* dominated the community.

Because of the man-hour problems associated with differentiating the variability of microphytobenthos populations spatially *in situ* a new multi-algal fluorometer was devised and tested. This probe enabled a rapid evaluation of microphytobenthic communities, instantaneous monitoring of total chlorophyll concentrations and differentiation of major taxonomic groups on a non-retrospect approach. The prototype of the benthic fluorometer was tested under laboratory and under field conditions and the applicability of the probe in determining algal populations on sediments *in situ* has successfully been realised.

The information on community structures gleaned from the *in situ* investigations was then used as a fundament to carry out three types of grazer-microphytobenthos experiments: (1) Investigations on the grazer efficiency and active selectivity of the freshwater snail *Potamopyrgus antipodarum*, (2) Experiments on the functional role of consumer presence and nutrient supply on microphytobenthic assemblages in macrophyte ecosystems and (3) Labelling experiments on selectivity patterns and competitive interactions between coexisting benthic grazers.

Grazer efficiency and active selectivity of P. antipodarum

To elucidate the role of grazer-microalgae interactions on natural Schöhsee sediments laboratory experiments with varying densities of the hydrobiid snail *P. antipodarum* were conducted. It was shown that the gastropods had both positive and negative effects on microphytobenthic algal biomass and that taxonomic composition and diversity remained unaffected by these snails. Moreover, predominately size- and density-dependent grazing patterns were observed and no morphology-triggered feeding preferences were found. Thus, it was assumed that *P. antipodarum* has a rather unselective feeding mode.

Functional role of consumers versus nutrient effects

The functional role of several herbivore grazers in influencing the microphytobenthos beneath macrophyte beds was subject to complex mesocosm studies simulating freshwater and marine vegetated habitats. Grazer presence did not affect the microphytobenthic community homogeneously and tendencies for a shift in food sources were observed in case

of coexistence. Apart from grazer activity, an impact of constantly high nutrient availabilities in the water column in changing taxonomic compositions was found. Both mesocosm experiments showed a community shift from a diverse microphytobenthic assemblage to an assemblage mainly comprising of large, chain-forming overstory diatom species. These data strongly suggest that both grazer presence and nutrient enrichment induced microphytobenthic community shifts and on the long run nutrients took over a governing role in restructuring the microphytobenthos.

Selectivity patterns and competitive interactions

Feeding selectivity and interspecific competition between two herbivore grazers were investigated by conducting stable isotope enrichment experiments. The emphasis of this study was to investigate the aspect of assimilation and to distinguish between active selectivity and passive feeding preferences. Measurements on isotope signatures enabled a quantification of the tracer uptake and the actual degree of assimilation. Strong differences between both factors were observed. The results indicated a shift in feeding preferences related to intra-specific competition and a potential divergence of trophic niches through competitive interactions. Thus, this techniques served as an ideal tool for distinguishing between active and passive selectivity patterns.

This work represents the first step to differentiate grazer-microalgae interactions particularly in freshwater sediments and it elucidates major aspects regulating microphytobenthic communities such as selectivity, competition, assimilation, nutrients as well as coexistence.

Chapter 9

Zusammenfassung

Das Mikrophytobenthos repräsentiert einen wichtigen Bestandteil von limnischen und marinen Lebensräumen. Es trägt in hohem Maße zur Primärproduktion in Flachwasserökosystemen bei und dient als Nahrungsgrundlage für höhere trophische Ebenen. Diese Sedimentlebensgemeinschaften findet man in nahezu allen Küstenlebensräumen, wie z.B. Salzmarschen, Watten und Makrophytenbestände.

Durch das Formen charakteristischer Algenmatten und die Ausscheidung von Schleim tragen sie wesentlich zur Stabilisierung und Umformung von Sedimenten bei. Des Weiteren stellen benthische Mikroalgen eine zuverlässige und hochwertige Nahrungsquelle für Mikro-Meio- und Makrofaunaorganismen dar.

Bisher wurde die Bedeutung des Mikrophytobenthos bezüglich ihrer räumlichen Ausdehnung und ihrer ökologischen Relevanz besonders in marinen Systemen betont. Im Gegensatz hierzu konnte seine potentielle Bedeutung im Littoral limnischer Systemen noch nicht hinreichend geklärt werden. Wenn überhaupt, dann beschränkten sich Untersuchungen in Süßwasserlebensräumen lediglich auf epiphytische oder periphytische Gemeinschaften; Sedimentmikroalgen wurden jedoch bis dato vernachlässigt.

Das Hauptziel dieser Studie lag darin, die Struktur von Mikrophytobenthosgemeinschaften näher zu beleuchten und Schlüsselorganismen herauszuarbeiten. Basierend auf diesen Untersuchungen wurden Interaktionen zwischen Mikroalgen und deren Fraßfeinden genauer untersucht. Die Freilanduntersuchungen wurden durchgeführt um Sukzessionsmuster an zwei unterschiedlichen Standorten zu erfassen. Sie sollten Aufschlüsse darüber geben welche taxonomischen Zusammensetzungen, Saisonalitäten und Fluktuationen in den Sedimentgemeinschaften vorherrschen.

Ausgeprägte Saisonalitäts- und Sukzessionsmuster waren ein charakteristisches Merkmal sowohl des marinen Standortes im Wattenmeer als auch des Schöhsees. Die Chlorophyllkonzentrationen und Zellzahlen erreichten jeweils im Frühjahr ihr Maximum, eine Biomasseabnahme wurde im Verlauf des Sommers beobachtet. Die Chlorophyllkonzentrationen an der Sedimentoberfläche zeigten vergleichbare Werte für den Schöhsee und dem Wattstandort Dorum. Die Zellzahlen waren jedoch am Wattenmeerstandort deutlich höher. Die Süßwassergemeinschaften waren hierbei wesentlich diverser als die marinen Gemeinschaften. Deutliche Veränderungen in der

Gemeinschaftsstruktur zu unterschiedlichen Jahreszeiten waren für beide Standorte charakteristisch. Die Struktur des Mikrophytobenthos zeigte eine ausgeprägte zweidimensionale Ausdehnung. Aufrechte Wuchsformen stellten die Ausnahme dar. Diese Wuchsform gilt als typisches Merkmal für das Mikrophytobenthos. Die taxonomische Zusammensetzung zeigte jedoch deutliche Unterschiede zwischen den Schöhsee und den Wattsedimenten. Im Schöhsee dominierten hauptsächlich die Gattungen *Synedra*, *Fragilaria*, *Nitzschia*, *Stauroneis* und *Navicula*, auf den Wattoberflächen waren hauptsächlich *Navicula*, *Cylindrotheca* und *Merismopedia*.

Aufgrund des hohen Zeit- und Arbeitsaufwandes, der beim erfassen von Sedimentalgen mit herkömmlichen Untersuchungsmethoden anfällt, wurde ein Multialgenfluorometer in dieser Arbeit entwickelt. Dieses Instrument ermöglicht eine schnelle Erfassung des Mikrophytobenthos und eine sofortige Ermittlung der Chlorophyllkonzentrationen. Außerdem konnten die Hauptalgengruppen *in situ* ermittelt werden. Der Prototyp des Benthosfluorometers wurde unter Labor- und Freilandbedingungen auf seine Tauglichkeit überprüft. Diese Untersuchungen zeigten, das die neuentwickelte Sonde ein ideales Hilfsmittel zur großflächigen Erfassung von Mikroalgenpopulationen darstellt.

Die aus den Freilanduntersuchungen gewonnenen Erkenntnisse wurden im Folgenden als Grundlage für drei verschiedene Versuchsansätze verwendet: (1) Untersuchungen zur Grazingeffektivität und aktiver Selektivität der Süßwasserschnecke *Potamopyrgus antipodarum*, (2) Experimente zum Einfluss von Konsumenten und Nährstoffbedingungen auf Mikrophytobenthosgemeinschaften in Makrophytenbeständen, (3) Markierungsexperimente zur Selektivität und Interaktionen zwischen konkurrierenden Arten.

Fraßeffizienz und aktive Selektivität von P. antipodarum

Um die Interaktion zwischen dem Mikrophytobenthos und dessen Fraßfeinden genauer zu untersuchen, wurden Laborexperimente mit unterschiedlichen Abundanzen von *P. antipodarum* durchgeführt. Es konnte gezeigt werden, das diese Gastropoden das Mikrophytobenthos sowohl positive als auch negative beeinflussen können. Die taxonomische Zusammensetzung und Diversität blieb jedoch von der die Fraßaktivität unberührt. Es zeigten sich keine Fraßpräferenzen im Bezug auf morphologische Charakteristika der Mikroalgen. Eine unselektive Ernährungsweise von *P. antipodarum* wird somit vermutet.

Einfluss von Konsumenten und Nährstoffbedingungen.

Die Bedeutung von verschiedenen herbivoren Grazern für die Mikroalgensedimentgemeinschaft mariner und limnischer Makrophytenhabitats wurde in unterschiedlichen Mesokosmenszenarien simuliert. Das Mikrophytobenthos zeigte keine

einheitliche Reaktion auf die Anwesenheit von Grazern. Im Falle von koexistierenden Arten wurden jedoch keine Anzeichen für eine Verschiebung von Nahrungspräferenzen gefunden. Zusätzlich zu dem Einfluss durch Grazing beeinflussten auch die hohen Nährstoffkonzentrationen in der Wassersäule die taxonomische Zusammensetzung der Sedimentmikroalgen. Sowohl die marinen als auch die limnischen Mesokosmenexperimente zeigten eine Verschiebung der Mikrophytobenthosgemeinschaft von divers zu artenarm. Die artenarmen Gemeinschaften waren geprägt durch kettenbildende Diatomeen. Die Ergebnisse aus diesen Experimenten zeigten, daß sowohl die Präsenz von Fraßfeinden als auch hohe Nährstoffkonzentrationen die Gemeinschaftsstruktur in höchstem Maße beeinflussen.

Selektivität und Interaktionen zwischen konkurrierenden Arten

Zur Untersuchung von Konkurrenz- und Fraßverhalten von zwei koexistierenden Invertebraten wurden Anreicherungsversuche mit stabilen Isotopen durchgeführt. Aspekte wie passive und aktive Selektivität sowie Assimilationseffizienz waren hierbei von besonderem Interesse. Mit Hilfe der Isotopensignaturen konnte die Traceraufnahme quantifiziert und der tatsächliche Assimilationsgrad bestimmt werden. Das Experiment zeigte, dass eine Verschiebung der Fraßpräferenzen in Abhängigkeit der Konkurrenzsituation auftrat. Außerdem wurde eine Tendenz zur Nischenverschiebung unter Konkurrenzdruck deutlich. Die Methode stellte hierbei ein ideales Mittel dar um aktive und passive Selektivitätsmuster aufzudecken.

Diese Arbeit repräsentiert eine der wenigen Studien, die sich mit Grazer-Mikroalgen-Interaktionen, besonders in limnischen Sedimenten beschäftigt. Viele Hauptmechanismen, die zur Regulierung des Mikrophytobenthos beitragen, wie z.B. Selektivität, Konkurrenz, Assimilation, Nährstoffbedingungen sowie Koexistenz wurden im Besonderen betrachtet und neue Aspekte aufgezeigt.

Chapter 10

Reference list

- Aberle N, Witte U (2003) Deep-sea macrofauna exposed to a simulated sedimentation event in the abyssal NE Atlantic: in situ pulse-chase experiments using ¹³C-labelled phytodetritus. *Marine Ecology Progress Series* **251**, 37-47.
- Adams TS, Sterner RW (2000) The effect of dietary nitrogen content on trophic level ¹⁵N-enrichment. *Limnology & Oceanography* **3**, 601-607.
- Admiraal W (1977) Tolerance of estuarine benthic diatoms to high concentrations of ammonia, nitrite ion, nitrate ion and orthophosphate. *Marine Biology* **43**, 307-315.
- Admiraal W, Peletier H (1980) Influence of seasonal variations of temperature and light on the growth rate of cultures and natural populations of intertidal diatoms. *Marine Ecology Progress Series* **2**, 35-43.
- Admiraal W, Bouwman LA, Heekstra L, Romeyn K (1983) Qualitative and quantitative interactions between microphytobenthos and herbivorous meiofauna on a brackish intertidal mudflat. *Internationale Revue der gesamten Hydrobiologie* **68**, 175-191.
- Admiraal W (1984) The ecology of estuarine sediment inhabiting diatoms. *Progress in Phycological Research* **3**, 269.
- Admiraal W, Peletier H, Brouwer T (1984) The seasonal succession patterns of diatom species on an intertidal mudflat: An experimental analysis. *Oikos* **42**, 30-40.
- Agatz M, Asmus RM, Deventer B (1999) Structural changes in the benthic diatom community along a eutrophication gradient on a tidal flat. *Helgoland Marine Research* **2**, 92-101.
- Alcoverro T, Conte E, Mazzella L (2000) Production on mucilage by the Adriatic epipelagic diatom *Cylindrotheca closterium* (Bacillariophyceae) under nutrient limitation. *Journal of Phycology* **36**, 1087-1095.
- Asmus R (1984) 'Investigations on benthic and pelagic primary production and nutrient balance in North Sea Wadden Sea'. Berichte aus dem Institut fuer Meereskunde an der Christian-Albrechts-Universitat Kiel, 31, pp. 148.
- Asmus H, Asmus R (1985) The importance of grazing food chain for energy flow and production in three intertidal sand bottom communities of the northern Wadden Sea. *Helgolaender Meeresuntersuchungen* **39**, 273-301.
- Barranguet C, Kromkamp J (2000) Estimating primary production rates from photosynthetic electron transport in estuarine microphytobenthos. *Marine Ecology Progress Series* **191**, 163-174.
- Beutler M, Meyer B, Wiltshire KH, Moldaenke C, Dau H (1998) Rapid depth-profiling of the distribution of 'spectral groups' of microalgae in lakes, rivers and the sea. the method and a newly-developed submersible instrument which utilizes excitation of chlorophyll fluorescence in five distinct wavelength ranges. In 'Photosynthesis: Mechanisms and Effects 5'. (Kluwer, Ed. G. Garab).

- Beutler M, Wiltshire KH, Meyer B, Moldaenke C, Dau H (2001) In situ profiles of phytoplankton: algal composition and biomass determined fluorometrically. In 'Ninth Conference on Harmful Algal Blooms'. Hobart (Australia). (Editors S Hallegraeff, C Blackburn, C Bolch and R Lewis) pp. 202-205
- Beutler M, Wiltshire KH, Luring C, Moldaenke C, Lohse D (2002a) Fluorometric depth-profiling of chlorophyll corrected for yellow substances. In 'Aquaculture, environment and marine phytoplankton' pp. 231-238
- Beutler M, Wiltshire KH, Meyer B, Moldaenke C, Luring C, Meyerhoefer M, Hansen U, Dau H (2002b) A fluorometric method for the differentiation of algal populations in vivo and in situ. *Photosynthesis Research* **72**, 39-53.
- Blanchard GF (1990) Overlapping microscale dispersion patterns of meiofauna and microphytobenthos. *Marine Ecology Progress Series* **68**, 101-111.
- Blanchard GF (1991) Measurement of meiofauna grazing rates on microphytobenthos is primary production a limiting factor. *Journal of Experimental Marine Biology & Ecology* **147**, 37-46.
- Blanchard GF, Cariou-Le Gall V (1994) Photosynthetic characteristics of microphytobenthos in Marennes-Oleron Bay, France: Preliminary results. *Journal of Experimental Marine Biology & Ecology* **182**, 1-14.
- Blomqvist P (1996) Late summer phytoplankton responses to experimental manipulations of nutrients and grazing in unlimed and limed Lake Njupfatet, central Sweden. *Archiv fuer Hydrobiologie* **137**, 425-455.
- Blumenshine SC, Vadeboncoeur Y, Lodge DM, Cottingham KL, Knight SE (1997) Benthic-pelagic links: Responses of benthos to water-column nutrient enrichment. *Journal of the North American Benthological Society* **16**, 466-479.
- Boenigk J, Matz C, Juergens K, Arndt H (2002) Food concentration-dependent regulation of food selectivity of interception-feeding bacterivorous nanoflagellates. *Aquatic Microbial Ecology* **27**, 195-202.
- Brendelberger H (1995) Dietary preference of three freshwater gastropods for eight natural foods of different energetic content. *Malacologia* **36**, 147-153.
- Brendelberger H (1997a) Contrasting feeding strategies of two freshwater gastropods, *Radix peregra* (Lymnaeidae) and *Bithynia tentaculata* (Bithyniidae). *Archiv fuer Hydrobiologie* **140**, 1-21.
- Brendelberger H (1997b) Coprophagy: a supplementary food source for two freshwater gastropods? *Freshwater Biology* **38**, 145-157.
- Broekhuizen N, Parkyn S, Miller D, Rose R (2002) The relationship between food density and short term assimilation rates in *Potamopyrgus antipodarum* and *Deleatidium* sp. *Hydrobiologia* **477**, 181-188.
- Cadee GC, Hegeman J (1974) Primary production of the benthic microflora living on tidal flats in the Dutch Wadden Sea. *Netherlands Journal of Sea Research* **8**, 260-291.
- Carlton RG, Wetzel RG (1987) Distributions and fates of oxygen in periphyton communities. *Canadian Journal of Botany* **65**, 1031-1037.

- Carrick HJ, Lowe RL, Rotenberry JT (1988) Guilds of benthic algae along nutrient gradients: Relationships to algal community diversity. *Journal of the North American Benthological Society* **7**, 117-128.
- Castenholz RW (1961) The effects of grazing on marine littoral diatom populations. *Ecology* **42**, 783-794.
- Cattaneo A (1983) Grazing on epiphytes. *Limnology & Oceanography* **28**, 124-132.
- Chase J, Wilson W, Richards S (2001) Foraging trade-offs and resource patchiness: Theory and experiments with a freshwater snail community. *Ecology Letters* **4**, 304-312.
- Cholnoky B (1927) Untersuchungen über die Ökologie der Epiphyten. *Archiv fuer Hydrobiologie* **18**, 661-705.
- Colijn F, Dijkema KS (1981) Species composition of benthic diatoms and distribution of chlorophyll-a on an intertidal flat in the Dutch Wadden sea. *Marine Ecology Progress Series* **4**, 9-21.
- Colijn F, De Jonge VN (1984) Primary production of microphytobenthos in the Ems-Dollard Estuary. *Marine Ecology Progress Series* **14**, 185-196.
- Connell JH (1978) Diversity in tropical rainforests and coral reefs. *Science* **199**, 1302-1310.
- Costantini ML, Rossi L (1998) Competition between two aquatic detritivorous isopods: A laboratory study. *Hydrobiologia* **368**, 17-27.
- Cowles T (1979) The feeding response of copepods from the Peru upwelling system: a food selection. *Journal of Marine Reserach* **37**, 601-622.
- Cox EJ (1993) Freshwater diatom ecology: Developing an experimental approach as an aid to interpreting field data. *Hydrobiologia* **269-270**, 447-452.
- Cullen JJ, Ciotti AM, Davis RF, Lewis MR (1997) Optical detection and assessment of algal blooms. *Limnology & Oceanography* **42**, 1223-1239.
- Cyr H (1998) How does the vertical distribution of chlorophyll vary in littoral sediments of small lakes? *Freshwater Biology* **40**, 25-40.
- Daehnick AE, Sullivan MJ, Moncreiff CA (1992) Primary production of the sand microflora in seagrass beds of Mississippi Sound. *Botanica Marina* **35**, 131-139.
- De Brouwer JFC, Stal LJ (2001) Short-term dynamics in microphytobenthos distribution and associated extracellular carbohydrates in surface sediments of an intertidal mudflat. *Marine Ecology Progress Series* **218**, 33-44.
- De Jong DJ, De Jonge VN (1995) Dynamics and distribution of microphytobenthic chlorophyll-a in the western Scheldt Estuary (SW Netherlands). *Hydrobiologia* **311**, 21-30.
- De Jonge VN, Colijn F (1994) Dynamics of microphytobenthos biomass in the Ems estuary. *Marine Ecology Progress Series* **104**, 185-196.
- De Jonge VN, Van Beusekom JEE (1995) Wind- and tide-induced resuspension of sediment and microphytobenthos from tidal flats in the Ems Estuary. *Limnology & Oceanography* **40**, 766-778.

- Decho AW, Fleeger JW (1988) Microscale dispersion of meiobenthic copepods in response to food-resource patchiness. *Journal of Experimental Marine Biology & Ecology* **118**, 229-243.
- Delgado M (1989) Abundance and distribution of microphytobenthos in the bays of Ebro Delta (Spain). *Estuarine, Coastal and Shelf Science* **29**, 183-194.
- Delgado M, De Jonge VN, Peletier H (1991) Experiments on resuspension of natural microphytobenthos populations. *Marine Biology* **108**, 321-328.
- Demott WR (1995) Food selection by calanoid copepods in response to between-lake variation in food abundance. *Freshwater Biology* **33**, 171-180.
- Demott WR (1998) Utilization of a cyanobacterium and a phosphorus-deficient green alga as complementary resources by daphnids. *Ecology* **79**, 2463-2481.
- Deniro MJ, Epstein S (1981) Influence of diet on the distribution of nitrogen isotopes in animals. *Geochemical Journal* **45**, 341-352.
- Dorgelo J, Leonards PEG (2001) Relationship between C/N ratio of food types and growth rate in the snail *Potamopyrgus jenkinsi* (E. A. Smith). *Journal of the North American Benthological Society* **20**, 60-67.
- Drebes G (1974) 'Marines Phytoplankton.' (Georg Thieme Verlag: Stuttgart pp.186)
- Duffy JE, Hay ME (1994) Herbivore resistance to seaweed chemical defense: The roles of mobility and predation risk. *Ecology* **75**, 1304-1319.
- Duffy JE, Hay ME (2000) Strong impacts of grazing amphipods on the organization of a benthic community. *Ecological Monographs* **70**, 237-263.
- Duffy JE, MacDonald KS, Rhode JM, Parker JD (2001) Grazer diversity, functional redundancy, and productivity in seagrass beds: An experimental test. *Ecology* **82**, 2417-2434.
- Edgar GJ (1990) Population regulation, population dynamics and competition amongst mobile epifauna associated with seagrass. *Journal of Experimental Marine Biology & Ecology* **144**, 205-234.
- Eichenberger E, Schlatterer A (1978) Effect of herbivorous insects on the production of benthic algal vegetation in outdoor channels. *Verhandlungen der Internationalen Vereinigung für Theoretische und Angewandte Limnologie* **20**, 1806-1810.
- Feminella JW, Hawkins CP (1995) Interactions between stream herbivores and periphyton: A quantitative analysis of past experiments. *Journal of the North American Benthological Society* **14**, 465-509.
- Fenchel T (1968) The ecology of marine microbenthos. II. The food of marine benthic ciliates. *Ophelia* **5**, 73-121.
- Fenchel T (1975a) Character displacement and coexistence in mud snails Hydrobiidae. *Oecologia* **20**, 19-32.
- Fenchel T (1975b) Factors determining the distribution patterns of mud snails (Hydrobiidae). *Oecologia* **20**.

- Friberg N, Jacobsen D (1994) Feeding plasticity of two detritivore-shredders. *Freshwater Biology* **32**, 133-142.
- Fry B, Sherr E (1984) Delta 13C measurements as indicators of carbon flow in marine and freshwater ecosystems. *Contributions in Marine Science* **27**, 13-47.
- Fry B (1988) Food web structure on Georges Bank Northwestern Atlantic Ocean from stable carbon nitrogen and sulfur isotopic compositions. *Limnology & Oceanography* **33**, 1182-1190.
- Gaetje C (1992) 'Artenzusammensetzung, Biomasse und Primärproduktion des Mikrophytobenthos des Elbe-Ästuars'. Dissertation thesis, Universität Hamburg. pp. 211.
- Gaston K (2000) Global patterns in biodiversity. *Nature* **405**, 220-227.
- Glud RN, Rysgaard S, Kuehl M (2002) A laboratory study on O₂ dynamics and photosynthesis in ice algal communities: quantification by microsensors, O₂ exchange rates, 14C incubations and a PAM fluorometer. *Aquatic Microbial Ecology* **27**, 301-311.
- Gorbunov MY, Falkowski PG, Kolber ZS (2000) Measurement of photosynthetic parameters in benthic organisms in situ using a SCUBA-based fast repetition rate fluorometer. *Limnology & Oceanography* **45**, 242-245.
- Gorokhova E, Hansson S (1999) An experimental study on variations in stable carbon and nitrogen isotope fractionation during growth of *Mysis mixta* and *Neomysis integer*. *Canadian Journal of Fisheries & Aquatic Sciences* **56**, 2203-2210.
- Grasshoff K, Ehrhardt M, Kremling K, Almgren T (1983) 'Methods of seawater analysis.' (Weinheim Verlag Chemie, pp. 419)
- Gruendling GK (1971) Ecology of the epipelagic algal communities in Marion Lake, British Columbia. *Journal of Phycology* **7**, 239-249.
- Guillard RL, Lorenzen C (1972) Yellow-green algae with chlorophyllide c. *Journal of Phycology* **8**, 10-14.
- Haeckel E (1890) 'Plankton Studien.' (G. Fischer Verlag)
- Hagerthey SE, Defew EC, Paterson DM (2002) Influence of *Corophium volutator* and *Hydrobia ulvae* on intertidal benthic diatom assemblages under different nutrient and temperature regimes. *Marine Ecology Progress Series* **245**, 47-59.
- Harper M (1969) Movement and migration of diatoms on sand grains. *British Phycological Journal* **4**, 97-103.
- Heck KJ, Pennock J, Valentine J, Coen L, Sklenar S (2000) Effects of nutrient enrichment and small predator density on seagrass ecosystems: An experimental assessment. *Limnology & Oceanography* **45**, 1041-1057.
- Hecky RE, Hesslein RH (1995) Contributions of benthic algae to lake food webs as revealed by stable isotope analysis. *Journal of the North American Benthological Society* **14**, 631-653.

- Herman PMJ, Middelburg JJ, Widdows J, Lucas CH, Heip CHR (2000) Stable isotopes as trophic tracers: Combining field sampling and manipulative labelling of food resources for macrobenthos. *Marine Ecology Progress Series* **204**, 79-92.
- Hill WR, Boston HL, Steinman AD (1992) Grazers and nutrients simultaneously limit lotic primary productivity. *Canadian Journal of Fisheries & Aquatic Sciences* **49**, 504-512.
- Hillebrand H, Sommer U (1997) Response of epilithic microphytobenthos of the Western Baltic Sea to in situ experiments with nutrient enrichment. *Marine Ecology Progress Series* **160**, 35-46.
- Hillebrand H, Duerselen C, Kirschtel D, Pollinger U, Zohary T (1999) Biovolume calculation for pelagic and benthic microalgae. *Journal of Phycology* **35**, 403-424.
- Hillebrand H, Kahlert M (2001) Effect of grazing and nutrient supply on periphyton biomass and nutrient stoichiometry in habitats of different productivity. *Limnology & Oceanography* **46**, 1881-1898.
- Hillebrand H, Kahlert M (2002) Effect of grazing and water column nutrient supply on biomass and nutrient content of sediment microalgae. *Aquatic Botany* **72**, 143-159.
- Hillebrand H, Kahlert M, Haglund A, Berninger U, Nagel S, Wickham S (2002) Control of microbenthic communities by grazing and nutrient supply. *Ecology* **83**, 2205-2219.
- Ho SC (1979) Structure, species diversity and primary production of epiphytic algal communities in the Schöhsee (Holstein), West Germany. Dissertation thesis, Mathematische Naturwissenschaftliche Fakultät der Universität zu Kiel (Germany).
- Hopkins J (1963) A study of the diatoms of the Ouse estuary, Sussex. I. The movement of the mud-flat diatoms in response to some chemical and physical changes. *Journal of the Marine Biological Association of the United Kingdom* **43**, 653-663.
- Hunter RD (1980) Effects of grazing on the quantity and quality of fresh water Aufwuchs. *Hydrobiologia* **69**, 251-260.
- Jacoby J (1987) Alterations in periphyton characteristics due to grazing in a cascade foothill stream. *Freshwater Biology* **18**, 495-508.
- James MR, Hawes I, Weatherhead M (2000a) Removal of settled sediments and periphyton from macrophytes by grazing invertebrates in the littoral zone of a large oligotrophic lake. *Freshwater Biology* **44**, 311-326.
- James MR, Hawes I, Weatherhead M, Stanger C, Gibbs M (2000b) Carbon flow in the littoral food web of an oligotrophic lake. *Hydrobiologia* **441**, 93-106.
- Jensen P (1987) Feeding ecology of free-living aquatic nematodes. *Marine Ecology Progress Series* **35**, 187-196.
- Jernakoff P, Brearley A, Nielsen J (1996) Factors affecting grazer-epiphyte interactions in temperate seagrass meadows. *Oceanography and Marine Biology: An Annual Review* **34**, 109-162.
- Jernakoff P, Nielsen J (1997) The relative importance of amphipod and gastropod grazers in *Posidonia sinuosa* meadows. *Aquatic Botany* **56**, 183-202.

- Joergensen BB, Revsbech NP, Cohen Y (1983) Photosynthesis and structure of benthic microbial mats: Microelectrode and SEM studies of four cyanobacterial communities. *Limnology & Oceanography* **28**, 1075-1093.
- Jumars PA, Nowell ARM (1984) Effects of benthos on sediment transport: Difficulties with functional grouping. *Continental Shelf Research* **3**, 115-130.
- Kahlert M, Baunsgaard MT (1999) Nutrient recycling: A strategy of a grazer community to overcome nutrient limitation. *Journal of the North American Benthological Society* **18**, 363-369.
- Kann E (1940) Ökologische Untersuchungen an Litoralalgen ostholsteinischer Seen. *Archiv fuer Hydrobiologie* **37**, 177-269.
- Kann E (1986) Could benthic algae be used as water quality indicators? *Archiv fuer Hydrobiologie, Supplement* **73**, 405-423.
- Kann E (1993) The littoral algal biocoenoses of lake Erken and its outlet (Uppland, Sweden). *Archiv fuer Hydrobiologie* **69**, 91-112.
- Karlstrom J, Backlund S (1977) Relationship between algal cell number, chlorophyll *a* and fine particulate organic matter in a river in Northern Sweden. *Archiv fuer Hydrobiologie* **80**, 192-199.
- Kassen R, Buckling A, Bell G, Rainey PB (2000) Diversity peaks at intermediate productivity in a laboratory microcosm. *Nature* **406**, 508-512.
- Kesler D (1981) Periphyton grazing by *Ammicola limosa*. An enclosure-exclosure experiment. *Journal of Freshwater Biology* **1**, 51-59.
- Khondker M, Dokulil M (1988) Seasonality, biomass and primary productivity of epipellic algae in a shallow lake (Neusiedlersee, Austria). *Acta Hydrochimica Hydrobiologica* **16**, 499-515.
- Kiefer DA (1973) Fluorescence properties of natural phytoplankton populations. *Marine Biology* **22**, 263-269.
- Kitting CL, Fry B, Morgan MD (1984) Detection of inconspicuous epiphytic algae supporting food webs in seagrass meadows. *Oecologia* **62**, 145-149.
- Klumpp DW, Salita-Espinosa JS, Fortes MD (1992) The role of epiphytic periphyton and macroinvertebrate grazers in the trophic flux of a tropical seagrass community. *Aquatic Botany* **43**, 327-349.
- Kolbowski J, Schreiber U (1995) Computer-controlled phytoplankton analyser based on a 4-wavelength PAM chlorophyll fluorometer. In 'Photosynthesis: From Light to Biosphere'. (Ed. P Mathis) pp. 825-828. (Kluwer)
- Lamberti GA, Resh VH (1983) Stream periphyton and insect herbivores an experimental study of grazing by a caddis-fly *Helicopsyche borealis*-population. *Ecology* **64**, 1124-1135.
- Lamberti GA, Ashkenas LR, Gregory SV, Steinman AD (1987) Effects of three herbivores on periphyton communities in laboratory streams. *Journal of the North American Benthological Society* **6**, 92-104.

- Lampert W (1987) Laboratory studies on zooplankton-cyanobacteria interactions. *New Zealand Journal of Marine and Freshwater Research* **21**, 483-490.
- Lange-Bertalot H (1979) Tolerance and population dynamics of benthic diatoms under varying waste water loading. *Archiv fuer Hydrobiologie* **56**, 184-219.
- Levin LA, Blair NE, Martin CM, DeMaster DJ, Plaia G, Thomas CJ (1999) Macrofaunal processing of phytodetritus at two sites on the Carolina margin: In situ experiments using ¹³C-labeled diatoms. *Marine Ecology Progress Series* **182**, 37-54.
- Lodge D (1986) Selective grazing on periphyton: a determinant of freshwater gastropod microdistribution. *Freshwater Biology* **16**, 831-841.
- Lowe R (1996) Periphyton patterns in lakes. In 'Algal Ecology: Freshwater benthic ecosystems'. (Eds R Stevenson, M Bothwell and R Lowe) pp. 57-76. (Academic Press: San Diego)
- MacIntyre HL, Geider RJ, Miller DC (1996) Microphytobenthos: The ecological role of the "secret garden" of unvegetated, shallow-water marine habitats. 1. Distribution, abundance and primary production. *Estuaries* **19**, 186-201.
- Macko SA, Lee WY, Parker PL (1982) Nitrogen and carbon isotope fractionation by two species of marine amphipods- laboratory and field studies. *Journal of Experimental Marine Biology & Ecology* **63**, 145-150.
- MacIntire CD, Overton WS (1971) Distributional patterns in assemblages of attached diatoms from Yaquina Estuary, Oregon. *Ecology* **52**, 758-777.
- Marcus J, Sutcliffe D, Willoughby L (1978) Feeding and growth of *Asellus aquaticus*, Isopoda, on food items from the littoral of Windemere, England UK, including green leaves of *Elodea canadensis*. *Freshwater Biology* **8**, 505-520.
- Mazel C (1997) Diver-operated instrument for in situ measurements of spectral fluorescence and reflectance of marine benthic organisms and substrates. *Optical Engineering* **36**, 2612-2617.
- McCormick PV, Stevenson RJ (1989) Effects of snail grazing on benthic algal community structure in different nutrient environments. *Journal of the North American Benthological Society* **8**, 162-172.
- McCormick PV, Stevenson RJ (1991) Grazer control of nutrient availability in the periphyton. *Oecologia* **86**, 287-291.
- Middelburg J, Barranguet C, Boschker H, Herman P, Moens T, Heip C (2000) The fate of intertidal microphytobenthos carbon: An in situ ¹³C-labeling study. *Limnology & Oceanography* **45**, 1224-1234.
- Miller AR, Lowe RL, Rotenberry JT (1987) Succession of diatom communities on sand grains. *Journal of Ecology* **75**, 693-710.
- Miller DC, Geider RJ, MacIntyre HL (1996) Microphytobenthos: The ecological role of the "secret garden" of unvegetated, shallow-water marine habitat. 2. Role in sediment stability and shallow-water food webs. *Estuaries* **19**, 202-212.
- Mitbavkar S, Anil AC (2002) Diatoms of the microphytobenthic community: population structure in a tropical intertidal sand flat. *Marine Biology* **140**, 41-57.

- Moncreiff CA, Sullivan MJ, Daehnick AE (1992) Primary production dynamics in seagrass beds of Mississippi Sound: The contributions of seagrass, epiphytic algae, sand microflora, and phytoplankton. *Marine Ecology Progress Series* **87**, 161-171.
- Moncreiff CA, Sullivan MJ (2001) Trophic importance of epiphytic algae in subtropical seagrass beds: Evidence from multiple stable isotope analyses. *Marine Ecology Progress Series* **215**, 93-106.
- Montagna PA, Blanchard GF, Dinet A (1995) Effect of production and biomass of intertidal microphytobenthos on meiofaunal grazing rates. *Journal of Experimental Marine Biology & Ecology* **185**, 149-165.
- Moore J (1975) The role of algae in the diet of *Asellus aquaticus* and *Gammarus pulex*. *Journal of Animal Ecology* **44**, 719-730.
- Mulholland PJ, Steinman AD, Palumbo AV, Elwood JW, Kirschtel DB (1991) Role of nutrient cycling and herbivory in regulating periphyton communities in laboratory streams. *Ecology* **72**, 966-982.
- Neckles HA, Wetzel RL, Orth RJ (1993) Relative effects of nutrient enrichment and grazing on epiphyte-macrophyte (*Zostera marina* L.) dynamics. *Oecologia* **93**, 285-295.
- Needoba J, Waser N, Harrison P, Calvert S (2003) Nitrogen isotope fractionation in 12 species of marine phytoplankton during growth on nitrate. *Marine Ecology Progress Series* **255**, 81-91.
- Nicotri M (1977) Grazing effects of four grazing inter tidal herbivores on the micro flora. *Ecology* **58**, 1020-1032.
- Nilsson P, Joensson B, Swanberg IL, Sundbaeck K (1991) Response of a marine shallow-water sediment system to an increased load of inorganic nutrients. *Marine Ecology Progress Series* **71**, 275-290.
- Norton TA, Hawkins SJ, Manley NL, Williams GA, Watson DC (1990) Scraping a living: a review of littorinid grazing.
- Nozaki K, Khadbaatar D, Tetsuji A, Naoshige G, Osamu M (2003) Development of filamentous green algae in the benthic algal community in a littoral sand-beach zone of Lake Biwa. *Limnology* **4**, 161-165.
- Orth RJ, J VM (1984) Epiphyte seagrass relationships with an emphasis on the role of micro grazing: A review. *Aquatic Botany* **18**, 43-70.
- Pacala S, Roughgarden J (1982) Resource partitioning and interspecific competition in two species insular *Anolis* lizard communities. *Science* **217**, 444-446.
- Paterson DM, Wiltshire KH, Miles A, Blackburn J, Davidson I, Yates MG, McGroarty S, Eastwood JA (1998) Microbiological mediation of spectral reflectance from intertidal cohesive sediments. *Limnology & Oceanography* **43**, 1207-1221.
- Paterson DM, Crawford RM, Little C (1990) Subaerial exposure and changes in the stability of intertidal estuarine sediments. *Estuarine, Coastal and Shelf Science* **30**, 541-556.
- Peterson B, Fry B (1987) Stable Isotopes in Ecosystem Studies. *Annual Review for Ecological Systematic* **18**, 293-320.

- Pilou E (1969) 'An introduction to mathematical ecology.' (John Wiley & Sons: New York)
- Pinckney J, Zingmark RG (1991) Effects of tidal stage and sun angles on intertidal benthic microalgal productivity. *Marine Ecology Progress Series* **76**, 81-89.
- Pinckney JL, Zingmark RG (1993) Modelling the annual production of intertidal benthic microalgae in estuarine ecosystems. *Journal of Phycology* **29**, 396-407.
- Plante-Cuny MR, Plante R (1984) Benthic diatoms as food source for benthic animals. In '8th Diatom Symposium' pp. 525-537
- Plante-Cuny MR, Bodoy A (1987) Biomass and primary production of phytoplankton and microphytobenthos in a sheltered and an exposed beach (Gulf of Fos, France). *Oceanologica acta* **10**, 223-237.
- Porter KG (1973) Selective grazing and differential digestion of algae by zooplankton. *Nature* **244**, 179-180.
- Post D (2002) Using stable isotopes to estimate trophic position: Models, methods and assumptions. *Ecology* **83**, 703-718.
- Potter IC, Cannon D, Moore JW (1975) The ecology of algae in the Moruya River Australia. *Hydrobiologia* **47**, 415-430.
- Revsbech NP, Joergensen B, Brix O (1981) Primary production of microalgae in sediments measured by oxygen microprofile carbon-14 labeled bi carbonate fixation and oxygen exchange methods. *Limnology & Oceanography* **26**, 717-730.
- Revsbech NP, Joergensen BB (1983) Photosynthesis of benthic microflora measured with high spatial resolution by the oxygen microprofile method capabilities and limitations of the method. *Limnology & Oceanography* **28**, 749-756.
- Ricklefs R, Schluter D (1993) 'Species diversity in ecological communities: Historical and geographical perspectives.' (University of Chicago Press: Chicago IL, USA)
- Riethmueller R, Heineke M, Kuhl H, Keuker-Rudiger R (2000) Chlorophyll-a concentration as an index of sediment surface stabilisation by microphytobenthos. *Continental Shelf Research* **20**, 1351-1372.
- Rosemond AD, Mulholland PJ, Elwood JW (1993) Top-down and bottom-up control of stream periphyton: Effects of nutrients and herbivores. *Ecology* **74**, 1264-1280.
- Rossi L, Fano E, Basset A (1983) Sympatric coevolution of the trophic niche of two detritivorous isopods *Asellus aquaticus* and *Proasellus coxalis*. *Oikos* **40**, 208-215.
- Round FE (1971) Benthic marine diatoms. *Oceanography and Marine Biology: An Annual Review* **9**, 83-139.
- Round FE, Crawford RM, Mann DG (1990) 'The diatoms: Biology and morphology of the genera, Cambridge University Press, Cambridge (UK).'
- Schreiber U, Schliwa U, Bilger W (1986) Continuous recording of photochemical and nonphotochemical chlorophyll fluorescence quenching with a type of modulation fluorometer. *Photosynthesis Research* **10**, 51-62.

- Serodio J, Da Silva JM, Catarino F (2001) Use of in vivo chlorophyll a fluorescence to quantify short-term variations in the productive biomass of intertidal microphytobenthos. *Marine Ecology Progress Series* **218**, 45-61.
- Shacklock PF, Doyle RW (1983) Control of epiphytes in seaweed cultures using grazers. *Aquaculture* **31**, 141-152.
- Shannon C, Weaver W (1963) 'The mathematical theory of communication.' (University of Illinois Press: Urbana 117 pp.)
- Smith GA, Nickels JS, Davis WM, Martz RF, Findlay RH, White DC (1982) Perturbations in the biomass, metabolic activity, and community structure of the estuarine detrital microbiota: Resource partitioning in amphipod grazing. *Journal of Experimental Marine Biology & Ecology* **64**, 125-144.
- Sommer U (1997) Selectivity of *Idothea chelipes* (Crustacea: Isopoda) grazing on benthic microlagae. *Limnology & Oceanography* **42**, 1622-1628.
- Sommer U (2000) Benthic microalgal diversity enhanced by spatial heterogeneity of grazing. *Oecologia* **122**, 284-287.
- Staats N, Stal LJ, Mur LR (2000) Exopolysaccharide production by the epipellic diatom *Cylindrotheca closterium*: effects of nutrient conditions. *Journal of Experimental Marine Biology & Ecology* **1**, 13-27.
- Steinman A, McIntire C, Gregory S, Lamberti G, Ashkenas L (1987) Effects of herbivore type and density on taxonomic structure and physiognomy of algal assemblages in laboratory streams. *Journal of the North American Benthological Society* **6**, 175-188.
- Steinman A (1996) Effects of grazers on freshwater benthic algae. In 'Algal Ecology: Freshwater benthic ecosystems'. (Eds RJ Stevenson, ML Bothwell and RL Lowe) p. 341-373. (Academic Press, Inc.: San Diego)
- Stevenson RJ, Singer R, Roberts DA, Boylen CW (1985) Patterns of benthic algal abundance with depth, trophic status, and acidity in poorly buffered New Hampshire lakes. *Canadian Journal of Fisheries & Aquatic Sciences* **42**, 1501-1512.
- Sullivan MJ (1976) Long-term effects of manipulating light intensity and nutrient enrichment on the structure of a salt marsh diatom community. *Journal of Phycology* **12**, 205-210.
- Sullivan MJ, Moncreiff CA (1990) Edaphic algae are an important component of salt marsh food-webs: Evidence from multiple stable isotope analyses. *Marine Ecology Progress Series* **62**, 149-159.
- Sumner WT, McIntire CD (1982) Grazer periphyton interactions in laboratory streams. *Archiv fuer Hydrobiologie* **93**, 135-157.
- Sundbaeck K (1983) Microphytobenthos on sand in shallow brackish water, Öresund, Sweden. Doctoral Dissertation thesis, University of Lund.
- Sundbaeck K, Joensson B (1988) Microphytobenthic productivity and biomass in sublittoral sediments of a stratified bay Southeastern Kattegat, North Sea. *Journal of Experimental Marine Biology & Ecology* **122**, 63-82.

- Sundbaeck K, Snoeijs P (1991) Effects of nutrient enrichment on microalgal community composition in a coastal shallow-water sediment system: An experimental study. *Botanica Marina* **34**, 341-358.
- Sundbaeck K, Enoksson V, Graneli W, Pettersson K (1991) Influence of sublittoral microphytobenthos on the oxygen and nutrient flux between sediment and water: A laboratory continuous-flow study. *Marine Ecology Progress Series* **74**, 263-279.
- Sundbaeck K, Miles A, Goeransson E (2000) Nitrogen fluxes, denitrification and the role of microphytobenthos in microtidal shallow-water sediments: an annual study. *Marine Ecology Progress Series* **200**, 59-76.
- Taylor IS, Paterson DM (1998) Microspatial variation in carbohydrate concentrations with depth in the upper millimetres of intertidal cohesive sediments. *Estuarine, Coastal and Shelf Science* **46**, 359-370.
- Tilman D (1994) Competition and biodiversity in spatially structured habitats. *Ecology* **75**, 2-16.
- Underwood GJC, Thomas JD (1990) Grazing interactions between pulmonate snails and epiphytic algae and bacteria. *Freshwater Biology* **23**, 505-522.
- Underwood GJC, Nilsson C, Sundbaeck K, Wulff A (1999) Short-term effects of UVB radiation on chlorophyll fluorescence, biomass, pigments, and carbohydrate fractions in a benthic diatom mat. *Journal of Phycology* **4**, 656-666.
- Underwood GJC, Provot L (2000) Determining the environmental preferences of four estuarine epipelagic diatom taxa: Growth across a range of salinity, nitrate and ammonium conditions. *European Journal of Phycology* **35**, 173-182.
- Utermoehl H (1958) Zur Vervollkommnung der quantitativen Phytoplankton-Methodik. *Mitteilungen der Internationalen Vereinigung für Limnologie* **9**, 1-38.
- Vadeboncoeur Y, Lodge DM (2000) Periphyton production on wood and sediment: substratum-specific response to laboratory and whole-lake nutrient manipulations. *Journal of the North American Benthological Society* **19**, 68-81.
- Valentine JF, Heck KLJ (1999) Seagrass herbivory: Evidence for the continued grazing of marine grasses. *Marine Ecology Progress Series* **176**, 291-302.
- Van Montfrans J, Orth RJ, Vay SA (1982) Preliminary studies of grazing by *Bittium varium* on eelgrass periphyton. *Aquatic Botany* **14**, 75-89.
- Van Montfrans J, Wetzel RL, Orth RJ (1984) Epiphyte-grazer relationships in seagrass meadows: Consequences for seagrass growth and production. *Estuaries* **7**, 289-309.
- Vander Zanden M, Rasmussen J (2001) Variation in delta15N and delta13C trophic fractionation: Implications for aquatic food web studies. *Limnology & Oceanography* **46**, 2061-2066.
- Vanderklift M, Ponsard S (2003) Sources of variation in consumer-diet delta 15N enrichment: a meta-analysis. *Oecologia* **136**, 169-182.
- Wasmund N (1984) Production and distribution of the microphytobenthos in the sediment of Lake Mikolajskie. *Internationale Revue der gesamten Hydrobiologie* **69**, 215-229.

- Wasmund N (1989) Micro-autoradiographic determination of the viability of algae inhabiting deep sediment layers. *Estuarine, Coastal and Shelf Science* **28**, 651-656.
- Wetzel R (1996) Benthic algae and nutrient cycling. In 'Algal Ecology: Freshwater benthic ecosystems'. (Eds R Stevenson, M Bothwell and R Lowe) p. 641-667. (Academic Press: San Diego)
- Wickham S, Gieseke A, Berninger UG (2000) Benthic ciliate identification and enumeration: an improved methodology and its application. *Marine Ecology Progress Series* **22**, 79-91.
- Wieser W (1953) Die Beziehung zwischen Mundhöhlengestalt, Ernährungsweise und Vorkommen von freilebenden marinen Nematoden. *Arkiv för Zoologie* **4**, 439-484.
- Wiltshire KH (1992) Der Einfluss von Mikrophytobenthos auf Nährstoffflüsse zwischen Sediment und Wasserphase in der Tide-Elbe. Dissertation thesis, Universität zu Hamburg, pp. 176.
- Wiltshire KH (1993) The influence of photosynthetic oxygen production by microphytobenthos on the oxygen and nutrient status of sediment water systems in the Elbe estuary. *Verhandlungen der Internationalen Vereinigung für Theoretische und Angewandte Limnologie* **25**, 1141-1146.
- Wiltshire KH, Schroeder F (1994) Pigment patterns in suspended matter from Elbe and associated waters as determined using high performance liquid chromatography. *Netherlands Journal of Aquatic Ecology* **28**, 255-265.
- Wiltshire KH, Schroeder F, Knauth H-D, Kausch H (1996) Oxygen consumption and production rates and associated fluxes in sediment-water systems: A combination of microelectrode, incubation and modelling techniques. *Archiv Fuer Hydrobiologie* **137**, 457-486.
- Wiltshire KH, Blackburn J, Paterson DM (1997) The Cryolander: A new method for fine-scale in-situ sampling of intertidal surface sediments. *Journal of Sedimentary Research* **67**, 977-981.
- Wiltshire KH (2000) Algae and associated pigments of intertidal sediments, new observations and methods. *Limnologica* **30**, 205-214.
- Winterbourn MJ, Fegley A (1989) Effects of nutrient enrichment and grazing on periphyton assemblages in some spring-fed South Island streams, New Zealand. *New Zealand Natural Sciences* **16**, 57-66.
- Wolff WJ (1979) 'Flora and vegetation of the Wadden Sea'. Report 3 (Final Report of the Section Marine Biology of the Wadden Sea; published by A.A. Balkema, Rotterdam, The Netherlands), pp. 206.
- Worm B, Lotze HK, Sommer U (2000) Coastal food web structure, carbon storage and nitrogen retention regulated by consumer pressure and nutrient loading. *Limnology & Oceanography* **45**, 339-349.
- Worm B, Sommer U (2000) Rapid direct and indirect effects of a single nutrient pulse in a seaweed-epiphyte-grazer system. *Marine Ecology Progress Series* **202**, 283-288.
- Worm B, Lotze HK, Hillebrand H, Sommer U (2002) Consumer versus resource control of species diversity and ecosystem functioning. *Nature* **417**, 848-851.

- Yallop ML, De WB, Paterson DM, Stal LJ (1994) Comparative structure, primary production and biogenic stabilization of cohesive and non-cohesive marine sediments inhabited by microphytobenthos. *Estuarine, Coastal and Shelf Science* **39**, 565-582.
- Yentsch C, Yentsch C (1979) Fluorescence spectral signatures: The characterisation of phytoplankton populations by the use of excitation and emission spectra. *Journal of Marine Research* **7**, 617-632.
- Yentsch C, Phinney D (1985) Spectral fluorescence: An taxonomic tool for studying the structure of phytoplankton populations. *Journal of Plankton Research* **7**, 617-632.
- Zimmerman R, Gibson R, Harrinton J (1979) Herbivory and detritivory among gammaridean amphipods from a Florida seagrass community. *Marine Biology* **54**, 41-47.

Danksagung

- Mein besonderer Dank gilt meiner Betreuerin Karen Wiltshire, die mich während der gesamten Zeit uneingeschränkt gefördert, unterstützt und motiviert hat. Ihrer wissenschaftliche Herangehensweise und Ihr Engagement waren bei der Durchführung dieser Arbeit unersetzlich.
- Prof. Dr. W. Lampert möchte ich für seine Anregungen und seine zuverlässige Unterstützung auch nach dem „Übersiedeln“ nach Helgoland ganz herzlich danken.
- Helmut Hillebrand danke ich für die anregende Zusammenarbeit, die hilfreichen Diskussionen und seine Gastfreundschaft.
- Für die gute Zusammenarbeit und den freundschaftlichen Zusammenhalt möchte ich meinen „Mitreiterinnen“ Sybill Jaschinski und Sandra Gohse-Reimann ganz herzlich danken.
- Karen Stumm danke ich für die Kooperation bei der gemeinsamen Versuchsdurchführung und Bestandsbeprobung.
- Vielen Dank an Martin Beutler für die nette Zusammenarbeit, die anregenden Diskussionen und seinen unersetzlichen Einsatz als Sonden „Trouble Shooter“.
- Jon Grey danke ich für die Kooperation bei der Messung der stabilen Isotopenverhältnisse.
- Den Mitarbeitern des MPI für Limnologie (Plön) möchte ich an dieser Stelle meinen herzlichen Dank aussprechen; allen voran Tina, Kirsten, Conny, Claes, Eckart, Heinke und Anita.
- Den Kollegen an der Biologischen Anstalt Helgoland danke ich für das nette Arbeitsklima, das mir ein schnelles Einleben auf der Insel ermöglichte. Ein besonderes Dankeschön geht hierbei an die „Food Webber“, sowie an Silvia, Peter und Kristine.
- Der Deutschen Forschungsgemeinschaft danke ich für die Finanzierung dieses Projektes.
- Den Kollegen aus HIMOM, besonders Wolfgang, Mireille und Maria, möchte ich für den netten Austausch und die gute Zusammenarbeit danken.
- Ein „Grazie mille“ geht an Petra Ringeltaube und Thomas Pillen die mich auf diesen Weg gebracht haben und mit denen ich die Freude am aquatischen Milieu stets teilen konnte.
- Meinen lieben Eltern möchte ich an dieser Stelle von Herzen danken. Sie haben mir diesen Weg ermöglicht, mich stets mit vereinten Kräften unterstützt und es ist immer ein Genuss gemeinsam mit Ihnen die Seele auf der Mühle baumeln zu lassen.
- Abschließend möchte ich Arne, meinem allerliebsten Gefährten, dem besten Mann aller Zeiten und meinem Lieblingsbiologen, für seinen grenzenlosen Einsatz, die unendliche Geduld und die vielen, schönen gemeinsamen Stunden danken.

Lebenslauf

Name Aberle-Malzahn

Vorname Nicole

- Persönliche Angaben**
- Geburtsdatum: 25.03.1974
 - Geburtsort: Rheinfeldern
 - Staatsangehörigkeit: deutsch

Ausbildung

1980 - 1984	Grundschule Wehr
1984 - 1991	Theodor-Heuss Gymnasium Schopfheim
1991 - 1993	Scheffeligymnasium Bad Säckingen
Mai 1993	Abitur
1994 - 1997	Grundstudium Biologie an der Christian- Albrechts Universität zu Kiel
November 1997	Vordiplom Biologie
1997 - 2001	Hauptstudium an der CAU zu Kiel (Diplom: Februar 2001)
November 1999	Diplomprüfungen in den Fächern: Biologische Meereskunde (Hauptfach), Zoologie (Nebenfach), Physikalische Ozeanographie (Nebenfach)
Januar 2000 – Januar 2001	Diplomarbeit am Max-Planck Institut für Marine Mikro- biologie (Bremen) mit dem Thema: „Reaktionen der Tiefseemakrofauna auf einen Nahrungspuls: <i>in-situ</i> Experimente mit ¹³ C/ ¹⁵ N-markiertem Algenmaterial“ unter der Betreuung von Dr. U. Witte
Januar 2001	Beginn der Doktorarbeit am Max-Planck Institut für Limnologie (Plön) in dem DFG-finanzierten Projekt : „Diversität und Funktion von benthischen Mikroalgen“ unter der Betreuung von PD Dr. K. H. Wiltshire
August 2003	Anstellung an der Biologischen Anstalt Helgoland (Stiftung Alfred-Wegener Institut) und dortige Weiterführung der Arbeit innerhalb des DFG-Projektes

Tätigkeiten neben dem Studium

Juni 1996 – Dezember 1998

Wissenschaftliche Hilfskraft am Forschungszentrum
GEOMAR (Kiel) bei Dr. U. Witte

Januar 1999 – Oktober 1999

Aushilfstätigkeit bei der Firma MariLim (Kiel)

März 2000 – Mai 2000

Wissenschaftliche Hilfskraft am Max- Planck Institut für
Marine Mikrobiologie (Bremen) bei Prof. Dr. B.B. Jörgensen

Auslandsaufenthalte

August 1993 – November 1993

Research Assistant an der Heron Island Research Station
(Great Barrier Reef, Australien) bei Dr. P. Ringeltaube

August 1994 – September 1994

Research Assistant am Institut für Marine Biologie
(Isola del Giglio, Italice) bei Dr. T. Pillen

Forschungsfahrten

28.03.1997 – 12.05.1997

Forschungsreise mit FS Sonne ins Arabische Meer
(Forschungsprojekt BIGSET I, GEOMAR)

29.06.1999 – 30.07.1999

Forschungsreise mit FS Sonne Honolulu-Oregon
(Forschungsprojekt TECFLUX, GEOMAR)

14.02.2000 – 26.02.2000

Forschungsreise mit FS Heincke in den Sognefjord
(Norwegen) (Forschungsprojekt BIGSET II, GEOMAR)

03.05.2000 – 28.05.2000

Forschungsreise mit FS Poseidon in den Nordost- Atlantik
(Forschungsprojekt BIGSET II, GEOMAR)

Spezielle Qualifikationen

Juli 1998

Ausbildung zur staatliche geprüften Forschungstaucherin
der Berufsgenossenschaft Tiefbau

Kiel, den 15. März 2004

Erklärung

Hiermit erkläre ich, dass die vorliegende Dissertation selbstständig von mir angefertigt wurde und dass sie nach Form und Inhalt meine eigenen Arbeit ist. Sie wurde keiner anderen Stelle im Rahmen eines Prüfungsverfahrens vorgelegt. Dies ist mein einziges und bisher erstes Promotionsverfahren. Die Promotion soll im Fach Limnologie erfolgen. Des weiteren erkläre ich, dass ich Zuhörer bei der Disputation zulasse.

Kiel, den 15.3.2004

Nicole Aberle-Malzahn