

This discussion paper is/has been under review for the journal Atmospheric Measurement Techniques (AMT). Please refer to the corresponding final paper in AMT if available.

**High accuracy
measurements of
CO₂ and CH₄ in
humid air**

C. W. Rella et al.

High accuracy measurements of dry mole fractions of carbon dioxide and methane in humid air

C. W. Rella¹, H. Chen², A. E. Andrews², A. Filges³, C. Gerbig³, J. Hatakka⁴, A. Karion², N. L. Miles⁵, S. J. Richardson⁵, M. Steinbacher⁶, C. Sweeney⁷, B. Wastine⁸, and C. Zellweger⁶

¹Picarro, Inc., Santa Clara, CA, USA

²National Oceanic and Atmospheric Administration, Earth System Research Laboratory, Global Monitoring Division, Boulder, CO, USA

³Max Planck Institute for Biogeochemistry, Jena, Germany

⁴FMI, Finnish Meteorological Institute, Helsinki, Finland

⁵The Pennsylvania State University, Department of Meteorology, University Park, PA, USA

⁶Empa, Laboratory for Air Pollution/Environmental Technology, Duebendorf, Switzerland

⁷CIRES, University of Colorado, Boulder, CO, USA

⁸Laboratoire des Sciences du Climat et l'Environnement, Gif-sur-Yvette, France

Title Page

Abstract

Introduction

Conclusions

References

Tables

Figures

⏪

⏩

◀

▶

Back

Close

Full Screen / Esc

Printer-friendly Version

Interactive Discussion

Received: 31 July 2012 – Accepted: 8 August 2012 – Published: 21 August 2012

Correspondence to: C. W. Rella (rella@picarro.com)

Published by Copernicus Publications on behalf of the European Geosciences Union.

AMTD

5, 5823–5888, 2012

**High accuracy
measurements of
CO₂ and CH₄ in
humid air**

C. W. Rella et al.

Title Page

Abstract

Introduction

Conclusions

References

Tables

Figures



Back

Close

Full Screen / Esc

Printer-friendly Version

Interactive Discussion

Abstract

Traditional techniques for measuring the mole fractions of greenhouse gas in the well-mixed atmosphere have required extremely dry sample gas streams (dew point $< -25^{\circ}\text{C}$) to achieve the inter-laboratory compatibility goals set forth by the Global Atmospheric Watch program of the World Meteorological Organization (WMO/GAW) for carbon dioxide (± 0.1 ppm) and methane (± 2 ppb). Drying the sample gas to low levels of water vapor can be expensive, time-consuming, and/or problematic, especially at remote sites where access is difficult. Recent advances in optical measurement techniques, in particular Cavity Ring Down Spectroscopy (CRDS), have led to the development of highly stable and precise greenhouse gas analyzers capable of highly accurate measurements of carbon dioxide, methane, and water vapor. Unlike many older technologies, which can suffer from significant uncorrected interference from water vapor, these instruments permit for the first time accurate and precise greenhouse gas measurements that can meet the WMO/GAW inter-laboratory compatibility goals without drying the sample gas. In this paper, we present laboratory methodology for empirically deriving the water vapor correction factors, and we summarize a series of in-situ validation experiments comparing the measurements in humid gas streams to well-characterized dry-gas measurements. By using the manufacturer-supplied correction factors, the dry-mole fraction measurements have been demonstrated to be well within the GAW compatibility goals up to at least 1 % water vapor. By determining the correction factors for individual instruments once at the start of life, this range can be extended to at least 2 % over the life of the instrument, and if the correction factors are determined periodically over time, the evidence suggests that this range can be extended above 4 %.

High accuracy measurements of CO_2 and CH_4 in humid air

C. W. Rella et al.

Title Page

Abstract

Introduction

Conclusions

References

Tables

Figures

⏪

⏩

◀

▶

Back

Close

Full Screen / Esc

Printer-friendly Version

Interactive Discussion



1 Introduction

In recent decades, there has been growing scientific consensus that the increase in the concentrations (i.e., dry mole fractions) of several key long-lived species is contributing to an overall global warming trend via the radiative forcing effect (IPCC, 2007). Carbon dioxide is the largest contributor to the total increase in radiative forcing (since pre-industrial times) due to long-lived greenhouse gases, accounting for 62.9% of this total in 2005 (IPCC, 2007); methane is the second largest single contributor at 18.2% of the 2005 total (IPCC, 2007). Together, these two greenhouse gases account for 81% of the total radiative forcing. Between 1990 and 2010, carbon dioxide accounts for 79.5% of the increase in radiative forcing due to long-lived greenhouse gases (WMO, 2011b), with methane contributing an additional 5.0% of the increase. Because these gases are long-lived, with a lifetime of about 100 yr for carbon dioxide and 12 yr for methane (IPCC, 2007), the effects of emissions are cumulative over their atmospheric lifetimes. Since 1958, with the installation of the first continuous greenhouse gas observing station on Mauna Loa, Hawaii (Keeling, 1960), scientific focus on quantifying carbon dioxide and methane mole fractions in the well-mixed atmosphere has increased significantly, with the goal of using these data for quantifying the magnitude of the sources and sinks of these gases. Today, there are extensive networks of such monitoring stations, with many more being brought online with each passing year. These measurement networks provide crucial validation for estimates of anthropogenic emissions as well as constraining the role of the biosphere and the oceans in modulating the atmospheric signals. The increasing spatial resolution afforded by these networks is already leading to increased spatial resolution of emissions from global/continental scales (Bousquet, 2009; Enting et al., 1995; Fan et al., 1998; Gurney et al., 2002; Peters et al., 2007, 2010; Peylin et al., 2005; Schuh et al., 2010) to regional scales (Corbin et al., 2010; Lauvaux et al., 2009, 2012a,b; Matross et al., 2006; Tolk et al., 2009) to even municipal scales (McKain et al., 2012).

High accuracy measurements of CO₂ and CH₄ in humid air

C. W. Rella et al.

Title Page

Abstract

Introduction

Conclusions

References

Tables

Figures



Back

Close

Full Screen / Esc

Printer-friendly Version

Interactive Discussion



High accuracy measurements of CO₂ and CH₄ in humid air

C. W. Rella et al.

Title Page

Abstract

Introduction

Conclusions

References

Tables

Figures

⏪

⏩

◀

▶

Back

Close

Full Screen / Esc

Printer-friendly Version

Interactive Discussion



The rapid expansion of greenhouse gas monitoring networks has driven the need for simpler and easier methods for making greenhouse gas measurements. Traditional methods of measuring the mole fractions of greenhouse gas in the well-mixed atmosphere have relied upon NDIR (non-dispersive infrared) spectroscopy for carbon dioxide and GC (Gas Chromatography) for methane. Typically, these measurements are performed on dried gas streams because the mole fractions for carbon dioxide and methane are only meaningful when extrapolated back to dry-gas conditions. Generally, it has not been possible to achieve the overall inter-laboratory comparability stipulated by the WMO/GAW standard (95% coverage factor) for CO₂ (± 0.1 ppm) and CH₄ (± 2 ppb) (WMO, 2011a) with these technologies without eliminating or rigorously accounting for humidity differences between sample and standard air. Due to the high variability of the water vapor content in the atmosphere, the effect of dilution by water vapor needs to be removed before meaningful data are obtained. A water vapor mole-fraction of 500 ppm (dew point -32°C at 1 bar) causes a dilution error of 0.2 ppm for CO₂. Thus, in order to compute accurate mole fractions relative to dry standards, it has been necessary to dry samples to very low levels of water vapor. The dilution effect is proportional to the humidity difference between standards and samples, rather than the absolute water amount, and the approach employed by Bakwin et al. (1995) is to dry the sample gas to a more moderate level (-25°C dew point) and humidify the standard gases to the same extent by passing both the sample and standard gases through a common Nafion membrane dryer.

Given the fact that dry-gas measurements are the ultimate goal, it would seem to be appropriate to dry the samples prior to measurement. However, installing drying systems brings several disadvantages:

1. drying systems add both cost and complexity to the sampling system, increasing the number of fittings and thus the chances of a leaky connection;
2. these systems often require consumables that require periodic replacement;

**High accuracy
measurements of
CO₂ and CH₄ in
humid air**C. W. Rella et al.

[Title Page](#)[Abstract](#)[Introduction](#)[Conclusions](#)[References](#)[Tables](#)[Figures](#)[⏪](#)[⏩](#)[◀](#)[▶](#)[Back](#)[Close](#)[Full Screen / Esc](#)[Printer-friendly Version](#)[Interactive Discussion](#)

3. the drying systems often rely on hardware that can fail (e.g., heated rechargeable desiccators) or on materials whose performance can degrade over time (e.g., Nafion membranes);
- 5 4. many drying systems require at least some human intervention periodically to ensure proper operation, which is a significant drawback at remote sites where access is limited;
5. they often increase the wetted surface area of the inlet system, increasing the residence time;
- 10 6. methods for drying may also induce biases in the dry mole fraction, by affecting (positively or negatively) the mole fraction of the analyte gas in the sample stream during the process of drying. For example, the permeability of Nafion to carbon dioxide has been shown to depend strongly upon the amount of humidity in the gas stream (Ma and Skou, 2007);
- 15 7. some drying methods are also sensitive to changes in ambient temperature or pressure;
8. dryers can be impractical to implement robustly on aircraft, which provide critical vertical profiles of greenhouse gases in the troposphere;
- 20 9. finally, and perhaps most importantly, dryers prevent measurements of ambient water vapor, unless a dedicated water vapor sensor is installed upstream of the dryer. Water vapor provides a critical tracer for identifying atmospheric layers such as the boundary layer top from airborne measurements, or changes in air masses on stationary towers (Gupta et al., 2009), and can additionally provide a valuable indicator of water condensation or ingress into the inlet sampling manifold.

25 Clearly, it would be a significant practical advantage to be able to measure dry-gas mole fractions for carbon dioxide and methane directly in the humid gas stream, which would

High accuracy measurements of CO₂ and CH₄ in humid air

C. W. Rella et al.

Title Page

Abstract

Introduction

Conclusions

References

Tables

Figures

⏪

⏩

◀

▶

Back

Close

Full Screen / Esc

Printer-friendly Version

Interactive Discussion



in turn simplify the rapid, reliable, and cost-effective deployment of large measurement networks. However, it has hitherto been impractical to make measurements in the humid gas stream, not only because many traditional techniques suffer from significant cross-talk between water vapor, carbon dioxide, and methane, but also because until recently, water vapor measurements of sufficient stability and precision have not been practical in the field. With an analyzer that can directly measure the water vapor content of the air stream at the same time as carbon dioxide and methane, the dry gas mole fractions of these two critically important greenhouse gases can be directly quantified with high precision and high accuracy, even in very humid gas streams such as in tropical regions.

In recent years, advances in optical spectroscopy have led to the development of a new class of greenhouse gas analyzers capable of highly stable and precise measurements of carbon dioxide, methane, and water vapor. In this paper, we will focus on analyzers based upon CRDS manufactured by Picarro, Inc. (Santa Clara, CA). In particular, we consider those instruments which measure CO₂, CH₄, and H₂O: the G1301, the G2301, and the G2401 (note: the G2302 uses a different spectroscopic feature to measure water vapor, and for simplicity and consistency will not be considered here). The G1301 was the first commercial instrument of this type, released in 2006, and described in greater detail in Crosson (2008). A second generation instrument, the G2301, has been available commercially since 2010, and the G2401, an instrument that measures carbon monoxide as well as the other three constituents, became available in 2011. These later instruments are based on the same core optical spectrometer as the G1301 with essentially identical performance characteristics. For the purpose of this paper, they will be assumed to behave interchangeably. This family of instruments has been adopted throughout the greenhouse gas measurement community, and a great deal of work has been done to establish their performance under humid sample gas conditions. We note that any measurement system that is capable of accurate and precise measurements of carbon dioxide, methane, and water vapor, without

systematic bias, can in principle deliver GAW-quality greenhouse gas measurements in humid gas streams.

These analyzers are all based upon cavity ring down spectroscopy (CRDS), an all-optical technology that delivers high stability and precision in a compact, field-deployable package. The CRDS analyzer is made up of the optical cavity with highly reflective mirrors, which serves as a compact flow cell with a volume of less than 10 standard cm³ and an effective optical path length of 15–20 km. This long path length allows for measurements with ppb and even ppt (parts-per-trillion) precision, using compact and highly reliable near-infrared laser sources. The instrument employs a precise wavelength monitoring and control system which delivers sub-picometer wavelength targeting on a microsecond timescale. The resulting spectrograms are analyzed using nonlinear spectral pattern recognition routines, and the outputs of these routines are converted into gas concentrations with a typical precision of about 1 part in 7500 on CO₂ and CH₄ in a 5 s measurement. Two of the key design features of these instruments are the temperature and pressure control loops that stabilize the spectroscopic signatures, which allow the instrument (when properly calibrated) to deliver accurate measurements that need very infrequent calibration relative to other CO₂ and CH₄ instrumentation.

In these instruments, separate and distinct spectral lines are used for each measured species. The lines have been carefully selected to provide high precision, and little or no interference from other nearby spectral lines of other atmospheric constituents. At a given temperature and pressure (which are stabilized to within 10 mK and 0.05 Torr of the internal set points, respectively), and in a given gas composition, the characteristics of these spectral lines do not vary; the line strength and line shape are intrinsic properties of the target molecule. That fact combined with the Beer-Lambert law, which dictates that the absorption per unit length at the peak of a spectral line is proportional to the number of molecules in the gas sample, means that the response of the instrument is linear to increases in mole fraction.

**High accuracy
measurements of
CO₂ and CH₄ in
humid air**

C. W. Rella et al.

Title Page

Abstract

Introduction

Conclusions

References

Tables

Figures

⏪

⏩

◀

▶

Back

Close

Full Screen / Esc

Printer-friendly Version

Interactive Discussion



**High accuracy
measurements of
CO₂ and CH₄ in
humid air**

C. W. Rella et al.

Title Page

Abstract

Introduction

Conclusions

References

Tables

Figures

⏪

⏩

◀

▶

Back

Close

Full Screen / Esc

Printer-friendly Version

Interactive Discussion



A critical assumption in the above analysis is that the gas composition does not change. The gas composition in particular has a strong effect upon the line shape. Different gases have different broadening cross-sections, and therefore broaden the spectral line to varying degrees; for example, 1 ppm of carbon dioxide in nitrogen has a broader line with lower peak height than 1 ppm of carbon dioxide in oxygen. For most variations in ambient air, these effects are negligible, because the mole fractions of most gases do not vary by a large amount in regular air samples. For example, the oxygen to nitrogen ratio varies less than 500 per meg in urban air (Keeling, 1988), and less than 250 per meg at remote locations (Keeling et al., 1992). Of more significant concern are variations in the O₂/N₂ ratio present in calibration and target tanks. Specifically, in standards generated from synthetic air, the fraction of O₂ can vary from 18–24 %, depending on the manufacturer. Furthermore, Ar, which is present in whole air at a level of 0.9 %, is often absent from synthetic air. In addition, there are certainly other applications where the O₂/N₂ ratio can be far from the standard clean air values, such as when equilibrating CO₂ or CH₄ in seawater where O₂ mole fraction can vary by 20 %, resulting in significant changes in the CO₂ and CH₄ peak heights. In Nara et al. (2012), the effects of O₂, N₂, and Ar have been carefully characterized and quantified for the CRDS instruments models described in this manuscript. Provided the concentrations of these gases are known, it is possible to correct for their effects. However, for simplicity we recommend using standards generated from ambient air.

Similarly, tropospheric water vapor content can be extremely large in the atmosphere, ranging from 100–500 ppm in arctic regions or dry alpine deserts to more than 40 000 ppm (4 %) in rainforests and other warm and humid environments. The variations of water vapor in the atmosphere modify the mole fractions of CO₂ and CH₄ (known as the dilution effect), and need to be corrected for. Beside this, the line broadening effect of this variability must be accounted for as well.

This paper is organized as follows. We begin with a short discussion of the theory behind the effects of water vapor on the measurement of dry mole fractions of carbon dioxide and methane. Next, we present several alternative experimental methods for

determining the empirical correction factors necessary to calculate dry mole fractions from measurements of the humid gas mole fractions of CO₂, CH₄, and H₂O. The results of instrument-to-instrument variations in the correction factors, and the drift in the correction factors over time on a single instrument, are also presented. Next, we present the results of several in-situ side-by-side comparisons of measurements in humid gas to well-validated dry-gas measurement systems. Finally, we conclude with a summary of the validation measurements.

2 Effects of water vapor on the measurements of carbon dioxide and methane

For greenhouse gas measurements and inversion analysis, dry-gas mole fractions (moles analyte gas/moles air) for carbon dioxide and methane are the relevant physical quantities to report; variability in these mole fractions, due to fluctuations in water vapor due to evaporation and condensation processes, only masks the underlying atmospheric variations resulting from surface-atmosphere exchange fluxes. The diluted and dry-gas mole fractions are related by the following expression:

$$\frac{c_{\text{dilution}}}{c_{\text{dry}}} = 1 - 0.01H_{\text{act}} \quad (1)$$

where c is the mole fraction of carbon dioxide or methane (the same equation holds for each), and H_{act} is the actual water mole fraction (in %). The challenge of implementing even this simple equation becomes immediately apparent: the water mole fraction H_{act} must be known to a high degree of both precision and accuracy, to support a high degree of accuracy in the measured dry gas concentrations. For example, to maintain an uncertainty of less than 50 ppb on a 400 ppm carbon dioxide measurement, the water vapor measurement must be accurate and precise to within 0.0125 %, or 125 ppm. This requirement exceeds the limit of the reference method for hygrometry, the chilled mirror method, which typically guarantees an accuracy of 0.1 °C dew point, which is 34 ppm at 10 °C but 260 ppm at 30 °C.

High accuracy measurements of CO₂ and CH₄ in humid air

C. W. Rella et al.

Title Page

Abstract

Introduction

Conclusions

References

Tables

Figures

⏪

⏩

◀

▶

Back

Close

Full Screen / Esc

Printer-friendly Version

Interactive Discussion



High accuracy measurements of CO₂ and CH₄ in humid air

C. W. Rella et al.

Title Page

Abstract

Introduction

Conclusions

References

Tables

Figures

⏪

⏩

◀

▶

Back

Close

Full Screen / Esc

Printer-friendly Version

Interactive Discussion



Rather than use Eq. (1) directly, which requires an accurate determination of H_{act} (and c_{dilution}) from these quantities, we instead derive empirical forms that relate the highly precise but humidity-biased outputs (CO_2)_{wet}, (CH_4)_{wet}, and (H_2O)_{rep} to dry mole fractions of CO_2 and CH_4 . Then, by performing the appropriate experiments (described in Sect. 3), dry-mole fractions may then be provided without ever needing to determine the absolute calibration of the water vapor. This empirical relationship is derived below.

The quantity c_{dilution} exhibits systematic bias due to water vapor via changes in the spectroscopic line shape. There are three principal mechanisms that determine the spectral line shape for isolated ro-vibrational lines, such as those used in the CRDS instrumentation discussed here: Doppler broadening, Lorentzian broadening, and Dicke line narrowing (Varghese and Hanson, 1984). The Doppler broadening coefficient is an intrinsic property of the analyte molecule, and does not depend on the constituents of the background gas composition. However, the Lorentzian broadening and Dicke line narrowing effects do depend both on the analyte gas and on the constituents of the background gas composition. Thus, as the concentration of water vapor changes, the shape of the spectral line changes. In spectroscopy, the total area of the spectral line is conserved throughout this process. However, the Picarro instrumentation uses peak height rather than area as a quantitative measure of the concentration, due to the fact that the measurement of peak height is more precise and more stable than the area measurement. As a result, the peak height of the absorption features for carbon dioxide and methane have a systematic bias with increasing water vapor due to the effect of the water vapor on both the line broadening and line narrowing effects. A more detailed treatment of these line shape effects is given in Nara et al. (2012) for the broadening effects of oxygen, nitrogen, and argon; a completely analogous treatment applies to water vapor.

As a result, we find that the effect of water vapor on the analyte peak heights can be expressed by a Taylor series expansion in water vapor concentration, and the effect is also proportional to the analyte gas peak height. Thus, the lineshape effect on the peak height of carbon dioxide or methane due to water vapor is proportional to the

peak height itself, but it can be nonlinear in water vapor concentration due to higher order terms in the Taylor series. We model this effect with the following expression:

$$\frac{C_{\text{wet}}}{C_{\text{dilution}}} = 1 + xH_{\text{act}} + yH_{\text{act}}^2 \quad (2)$$

Here, we have kept terms to second order in the water vapor concentration.

The final step is to relate the actual water vapor concentration H_{act} to the measured water vapor concentration H_{rep} , which is again derived from the peak height of a water vapor line. This line suffers from a similar lineshape effect that affects the carbon dioxide and methane lines with increasing water vapor concentration (called self-broadening), which leads to a nonlinearity in the measured water scale. This nonlinearity is expressed in the following way (again, keeping terms to second order):

$$H_{\text{act}} = r_1 H_{\text{rep}} + r_2 H_{\text{rep}}^2 \quad (3)$$

The values r_1 and r_2 were determined by Winderlich et al. (2010) to be 0.772 and 0.019493, respectively, comparing against a calibrated hygrometer, with a relative accuracy of 1.5%. We emphasize that any uncertainty in these values does not affect the determination of the correction coefficients (as is shown below). Equations (1)–(3) can then be combined, resulting in the following expression (after grouping terms and keeping all terms 2nd order and lower):

$$\frac{C_{\text{wet}}}{C_{\text{dry}}} = 1 + aH_{\text{rep}} + bH_{\text{rep}}^2 \quad (4)$$

Note that C_{wet} , C_{dry} , and H_{rep} are all values that can be determined directly from a properly designed experiment (which is discussed below), which means that the constants a and b (which are different for CO_2 and CH_4) can be determined entirely empirically, without ever measuring the intermediate constants x , y , r_1 , and r_2 . In other words, no specific knowledge of the lineshape effects on any of the species is required to derive

High accuracy measurements of CO_2 and CH_4 in humid air

C. W. Rella et al.

Title Page

Abstract

Introduction

Conclusions

References

Tables

Figures

⏪

⏩

◀

▶

Back

Close

Full Screen / Esc

Printer-friendly Version

Interactive Discussion



High accuracy measurements of CO₂ and CH₄ in humid air

C. W. Rella et al.

Title Page

Abstract

Introduction

Conclusions

References

Tables

Figures

⏪

⏩

◀

▶

Back

Close

Full Screen / Esc

Printer-friendly Version

Interactive Discussion



this empirical relationship. In addition, note that high accuracy water vapor measurements are not required for the correction proposed in this paper; what is required is a high degree of precision and stability. As long as H_{rep} is a well-behaved, monotonically increasing function of the actual water vapor concentration, H_{rep} is a functionally identical equivalent measure of water vapor for the purposes of correcting the CO₂ and CH₄ measurements. When discussing the laboratory experiments, we will use H_{rep} , because this is the more physically relevant quantity that is derived directly from the absorbance peak as measured by the optical spectrometer. However, when presenting ambient air measurements, we will use H_{act} , because this is the more physically relevant quantity in the atmosphere.

The correction coefficients determined by Chen et al. (2010) are as follows:

$$\text{CO}_2 : a = -1.20 \times 10^{-2}, \quad b = -2.67 \times 10^{-4}$$

$$\text{CH}_4 : a = -9.823 \times 10^{-3}, \quad b = -2.39 \times 10^{-4}$$

Obviously, the precision of the dry-mole fractions of CO₂ and CH₄ is degraded somewhat by the finite precision of the water vapor measurement as modified by the calculations above. By straightforward propagation of errors, the additional noise due to noise in the measurement of water vapor can be shown to be $\sigma_{\text{corr}} = C_{\text{wet}}(a - 2bH_{\text{rep}})\sigma_{H_{\text{rep}}}$, or about 0.015 ppm for CO₂ (over 5 min) and ~ 0.075 ppb for CH₄, using the manufacturer-guaranteed noise specification of 0.003 % for water on the 5 min measurement. This noise, added in quadrature to the instrument noise of 0.050 ppm and 0.22 ppb for CO₂ and CH₄, respectively, does not significantly affect the performance of the instruments relative to the GAW targets or the uncorrected measurements.

We do highlight two important assumptions inherent in this analysis. First, we have assumed that the correction due to water is proportional to the concentration of the analyte species (i.e., CO₂ or CH₄) – that is, that there is no direct absorption due to water vapor in the spectral regions of CO₂ and CH₄ that causes a systematic bias in the fits for those two gases even at zero CO₂ and CH₄ concentration. Second, we have assumed that there is no cross-talk from carbon dioxide and methane to the water vapor

measurement, which would cause cross-species contamination and concentration dependence in the correction factors. We will examine these assumptions in greater detail in the laboratory results section, below. Next, in the experimental section, we discuss several experimental techniques for determining the constants a and b in Eq. (4).

3 Experimental techniques for determining the water vapor correction factors

Experimentally, the problem of determining the constants in Eq. (4) can be reduced to the challenge of devising a reliable and simple methodology for generating a gas stream that has constant (or varying but known) and nonzero dry mole fraction of carbon dioxide and/or methane, but variable humidity. There are many possible and functionally equivalent solutions to this problem. In this section, we describe two separate methodologies that have been performed independently at MPI (Max Planck Institute for Biogeochemistry in Jena, Germany), NOAA/ESRL (NOAA Earth System Research Laboratory, Boulder, Colorado), LSCE (Laboratoire des Sciences du Climat et l'Environnement in Gif sur-Yvette, France), Empa (Swiss Federal Laboratories in Zurich, Switzerland), and Picarro, Inc. (Santa Clara, CA).

3.1 Method #1 – switching between wet and dry gas streams

3.1.1 MPI implementation

The wet and dry mole fractions of CO_2 and CH_4 of a humidified gas stream can be obtained when the gas stream is alternately provided to one or more CRDS analyzers through two paths, one with a chemical dryer and the other without. This method relies on the ability to generate a humidified gas stream with rather constant mole fractions of CO_2 , CH_4 , and H_2O during each of multiple time steps. The wet/dry ratios of CO_2 and CH_4 are then calculated for each water vapor level. This method has been described elsewhere (Chen et al., 2010; Nara et al., 2012). A detailed description of this method as implemented at MPI is given by Chen et al. (2010), and a variant of the

High accuracy measurements of CO_2 and CH_4 in humid air

C. W. Rella et al.

Title Page

Abstract

Introduction

Conclusions

References

Tables

Figures

⏪

⏩

◀

▶

Back

Close

Full Screen / Esc

Printer-friendly Version

Interactive Discussion



**High accuracy
measurements of
CO₂ and CH₄ in
humid air**C. W. Rella et al.

[Title Page](#)[Abstract](#)[Introduction](#)[Conclusions](#)[References](#)[Tables](#)[Figures](#)[⏪](#)[⏩](#)[◀](#)[▶](#)[Back](#)[Close](#)[Full Screen / Esc](#)[Printer-friendly Version](#)[Interactive Discussion](#)

setup is shown in Fig. 1. To produce humidified gas streams with varying water vapor mole fractions, dry air from a tank (compressed ambient air) was provided to a dew point generator (LI-COR model 610) with varying dew point settings. A magnesium perchlorate dryer was used to deliver the dry gas stream. The flow and pressure were carefully balanced between the two paths so that the pressure at the chemical dryer was not changing when switching between wet and dry gas streams, which eliminated the possible modification of CO₂ mole fractions. The whole experiment can be performed in a temperature controlled room to avoid condensation of water vapor on the surface of the inlet tubes.

The advantage of this method is that wet/dry ratios of CO₂ and CH₄ can be accurately determined for a series of water vapor levels that may be chosen to be evenly distributed over the experimentally realized range. Cycles of e.g., 20 min (10 min wet and 10 min dry) can be used, and for each wet air measurement the CO₂ and CH₄ values of neighboring dry air measurements is interpolated in the analysis to provide wet/dry ratios. However, only discrete experimental points can be obtained, and no data are available for water vapor levels below 0 °C dew point, due to the limitation of the dew point generator used in the experiment.

3.1.2 LSCE implementation

The experimental setup used at LSCE is substantially similar to this setup, with the exception that a single instrument was used, and the measurements were performed in a room with the standard laboratory air-conditioning set to 30 °C. A commercial dew point generator (LI-COR 610) was used to humidify a dry working standard to 25 °C dew point, and a magnesium perchlorate dryer was used to generate the dry gas stream.

3.1.3 NOAA implementation

The NOAA/ESRL lab has set up a slightly different approach to get a steady-state value of water vapor by using a gas permeable membrane device (“micromodule”),

http://www.liqui-cel.com/product-information/micromodule.cfm) in which slightly acidified water (pH ~ 5) resides on the shell side of the micromodule while standard air flows through the lumen side. The micromodule temperature is controlled between 2 and 30 °C (by immersing it in a temperature controlled water bath) to obtain water vapor values ranging from 0.7 % to 4.2 %. The flow rate of the standard gas through the membrane is regulated by the upstream pressure from the standard tank regulator. Overflow gas is vented so that ambient pressure is maintained at the analyzer inlet and in the micromodule itself. This methodology can be run in the configuration suggested in Fig. 1 but has the added advantage that it can be used to slowly vary the water vapor concentration over the specified range using subtle changes in water bath temperature and standard gas flow rate. Lower water vapor concentrations (down to fully dry) are also easily achieved by using a simple plumbing and valve arrangement to blend dry tank air with some of the wetted air from the micromodule.

3.1.4 Method #1 discussion

Method #1 is perhaps the most straightforward implementation of a test method to determine the correction coefficients. Since the dry mole fractions of gases are directly checked on the same analyzer, it provides an accurate way of determining wet/dry ratios. One advantage of this method, in addition to its conceptual simplicity, is that the concentration of water vapor can be set to specific values in a controlled fashion, at least within the operating range of the dew point generator used for these measurements. This method also provides a robust way to confirm that the system has reached some equilibrium state at each water level. Other methods that dry a filter or membrane, such as method #2, below, make it hard to know whether equilibrium has been reached. In addition to requiring a dedicated dew point generator, one potential problem with this method is that the water used to humidify the standard can have a variable amount of carbon dioxide dissolved in the liquid (or in carbonate form), which can be released into the gas phase during the course of the experiment. This makes it necessary to frequently check the dry mole fraction during the measurement to track this

High accuracy measurements of CO₂ and CH₄ in humid air

C. W. Rella et al.

Title Page

Abstract

Introduction

Conclusions

References

Tables

Figures

⏪

⏩

◀

▶

Back

Close

Full Screen / Esc

Printer-friendly Version

Interactive Discussion



potential bias. Further, the method is somewhat cumbersome and therefore difficult to implement in a field setting.

3.2 Method #2 – water droplet method

For the water droplet method, a working standard is humidified by passing it over a water droplet in a vessel. Each laboratory involved in this research has developed slightly different implementations of method #2, which are described in detail below.

3.2.1 MPI/NOAA implementations

One implementation of the water droplet method is given by Winderlich et al. (2010). During a test, air is humidified when it flows through a stainless steel water trap that contains a droplet of water (< 1 ml). The pressure in the water trap is manually adjusted to obtain varying mole fractions of water vapor while the temperature of the water trap is stabilized using an ice bath. Due to its portability, the water trap provides a feasible tool for performing the water test in the field. However, careful attention is required to eliminate the potential for contamination of the humidified gas stream.

Alternatively, a small amount of deionized water (~ 0.5 ml) added to the inlet line of the CRDS analyzer can also humidify the gas stream and does not modify its mole fractions of CO₂ and CH₄, which provides an easy way of performing the water test. This apparatus is shown in Fig. 2. The water droplet added to the inlet line is held at the hydrophobic particulate filter of the analyzer, through which water can pass only in the form of water vapor. During a test, the water vapor mole fraction in the gas stream decreases as the water droplet is depleted. A second analyzer is employed to measure dry air mole fractions simultaneously to check any potential influences of injected water on CO₂ and CH₄. Laboratory tests show that within the noise levels, water droplets made of deionized or acidified deionized water do not modify the CO₂ and CH₄ mole fractions, where those made of tap water could modify the CO₂ mole fractions up to a few tenths of ppm (see the Supplement for details). Besides this, it has

High accuracy measurements of CO₂ and CH₄ in humid air

C. W. Rella et al.

Title Page

Abstract

Introduction

Conclusions

References

Tables

Figures

⏪

⏩

◀

▶

Back

Close

Full Screen / Esc

Printer-friendly Version

Interactive Discussion



been found that dry mole fractions of CO₂ in the first 2–3 min after injection of water droplet are enhanced by a few tenths of ppm (confirmed by measurements by the CRDS analyzer with a dryer). We suggest discarding this period when the dry values are not independently measured.

5 This water droplet test often results in abrupt change of water vapor mole fractions, and it provides sparse measurements in certain water vapor ranges. The sparseness of water vapor measurements introduces errors that are associated with the interpolation of water vapor measurements to the times when CO₂ and CH₄ measurements are made, and contributes to the uncertainty of derived water corrections. To obtain
10 slowly changing water vapor mole fraction, a small amount of silica gel soaked with deionized or acidified water has been used at NOAA/ESRL to humidify the gas stream. In practice, the silica gel was housed in a stainless steel Swagelok filter with the internal elements removed. Plastic instead of stainless steel connectors may be utilized to connect the filter to the inlet of the analyzer to avoid additional CH₄ from metal-metal
15 friction.

3.2.2 Empa implementation

In the Empa set-up (Fig. 3, and described in Zellweger et al., 2012), water is injected into a piece of 1/4 inch Synflex 1300 tubing which is shaped to a coil in order to prevent water from entering the instrument. The pressure remains constant at roughly atmospheric pressure for the duration of the experiment. Injection of approx. 0.8 ml ultrapure
20 water and a flow rate of 500 ml min⁻¹ of the dry standard gas is optimal. Such an experiment usually takes approximately 2 h, and there is enough conditioning time at the beginning of the experiment to allow for equilibration. Usually, the first data during the saturation phase have to be discarded. The water vapor range that is covered by this set-up ranges from 0 to approximately 2.8 % at 23 °C and 1013 hPa. A further
25 advance of this set-up is that the water vapor range is completely covered. The resulting water vapor concentrations and carbon dioxide mole fractions are shown in the left

**High accuracy
measurements of
CO₂ and CH₄ in
humid air**

C. W. Rella et al.

Title Page

Abstract

Introduction

Conclusions

References

Tables

Figures

⏪

⏩

◀

▶

Back

Close

Full Screen / Esc

Printer-friendly Version

Interactive Discussion



panel of Fig. 4, and the resulting fit of the data to the water vapor correction function are shown in the right panel.

3.2.3 LSCE implementation

In the LSCE version of the setup, a 0.2 ml droplet of ultrapure water is injected into a hydrophobic filter (M&C – LB-1SS) located upstream of the inlet to the Picarro system. Delivery pressure of the dry standard gas is about 0.2 bar(g). As in the other methods, the experiment continues until the droplet is completely evaporated. Dry values are measured before the water droplet injection and are checked after the droplet evaporation. The first two to three minutes following the water injection are discarded for the final calculations. The filter may be heated to generate water vapor levels above the ambient dew point in the laboratory, even above 5 % water vapor. Experiments usually take 1–2 h. They are usually repeated three times to have sufficient experimental data points and to guarantee a more robust correction assessment.

3.2.4 Picarro implementation

In the Picarro implementation (Fig. 5), two mass flow controllers are added to the LSCE implementation. One mass flow controller (MFC) is situated upstream of the hydrophobic filter, and the second MFC is used to dilute the flow of humid air exiting the hydrophobic filter. The filter can be heated above ambient to allow measurements at elevated dew points, and the plumbing downstream of the filter is heated to above the filter temperature to ensure that water vapor does not condense in the transfer lines. By varying the ratios of the flows through MFCs, one can generate an arbitrary water vapor concentration profile in the instrument until the water droplet fully evaporates (although the concentration delivered by this system is not targeted as well as with a dew point generator), which reduces the potential for bias associated with the emission or uptake of carbon dioxide from the water droplet as the droplet evolves. Unlike the other

High accuracy measurements of CO₂ and CH₄ in humid air

C. W. Rella et al.

Title Page

Abstract

Introduction

Conclusions

References

Tables

Figures

⏪

⏩

◀

▶

Back

Close

Full Screen / Esc

Printer-friendly Version

Interactive Discussion

variations, this variation has not been applied repeatedly to multiple instruments and over time, so its overall stability has not yet been assessed.

3.2.5 Method #2 discussion

The various implementations of Method #2 all have the advantage that they relatively easy to deploy, which makes this method highly attractive for in-situ testing of the water vapor correction factors. The accuracy in the water corrections determined from this method, especially for CO₂, depends on the integrity of the assumed dry mole fractions and the measured mole fractions of the humidified gas for CO₂ and CH₄ by the CRDS analyzer. Usually the dry mole fractions are measured before and after the water droplet test, and the difference should be sufficiently small, e.g., below 0.05 ppm, to exclude potential biases caused by insufficiently flushed pressure regulators or an unwanted leak. Besides the effect that mole fractions of CO₂ are slightly enhanced by a few tenths of ppm immediately after a water droplet is injected, any contamination in sampling system may cause a potential bias for CO₂ and CH₄ as well. By using a very small volume of liquid water (typically 0.2–0.8 ml), and by using distilled (deionized) and/or slightly acidified water, the effects of dissolved carbon dioxide can be reduced relative to the larger water volumes associated with dew point generators. However, the possibility for bias due to carbon dioxide dissolved in the gas remains a concern and a potential source of bias with this method. In addition, the simpler implementations of the droplet method allow for no control over the water vapor level delivered to the instrument, although this problem can be solved by varying the pressure or a dilution flow, at the cost of complexity. Finally, the pressure-variation alternative has the additional disadvantage that the head pressure above the liquid water is varied, which can lead to carbon dioxide either being outgassed or dissolved by the liquid sample.

High accuracy measurements of CO₂ and CH₄ in humid air

C. W. Rella et al.

Title Page

Abstract

Introduction

Conclusions

References

Tables

Figures

⏪

⏩

◀

▶

Back

Close

Full Screen / Esc

Printer-friendly Version

Interactive Discussion



4 Laboratory validation and discussion

4.1 MPI/NOAA results

4.1.1 Repeatability of water vapor measurements

Key to being able to correct for the effect from water vapor in a wet air measurement is the precise and stable measurement of water vapor. To assess the stability of the CRDS water vapor measurements over time, different pairs of analyzers at different times were exposed to the same gas stream (humidified calibration gas) for the water vapor range of 0–3% (H_{rep}), and the readings were compared. Figure 6 shows the comparisons of three different analyzers against the CFADS37 analyzer. The two comparisons between CFADS15 and CFADS37 were performed with more than three years separation, and indicate a good long-term stability. The largest differences in the reported H_2O are about 125 ppm, corresponding to an error in the water-corrected CO_2 mole fraction of about 0.06 ppm, based on the Chen et al. (2010) correction.

This error can be reduced by referring all CRDS water measurements to the same scale, i.e., to that of a single “golden” instrument. Repeated comparisons of different analyzers showed the stability of this “calibration” over time and indicated differences of less than about 100 ppm in H_2O corresponding to an error in the water vapor correction for CO_2 of less than 0.05 ppm.

All G1301 and G2301 instruments shipped by Picarro have used the same numerical factor to relate the height of the water vapor absorption line to the concentration of water vapor; no experiments are performed to adjust this constant from instrument to instrument, due to the difficulty of generating an accurate water vapor concentration in the laboratory. However, there is statistical information on other species, such as CO_2 , which allows us to estimate the variability of the water vapor scale from instrument to instrument. For a sample size of $N = 23$ randomly selected instruments, the standard deviation of the slope constant is 0.22% for CO_2 , and all of the calibration constants are within 0.5% of the mean. Assuming that the same relative

High accuracy measurements of CO_2 and CH_4 in humid air

C. W. Rella et al.

Title Page

Abstract

Introduction

Conclusions

References

Tables

Figures

⏪

⏩

◀

▶

Back

Close

Full Screen / Esc

Printer-friendly Version

Interactive Discussion



High accuracy measurements of CO₂ and CH₄ in humid air

C. W. Rella et al.

Title Page

Abstract

Introduction

Conclusions

References

Tables

Figures

⏪

⏩

◀

▶

Back

Close

Full Screen / Esc

Printer-friendly Version

Interactive Discussion



relationship holds for H₂O, this result implies that variation in the slope would lead to variability of 50 ppm H₂O/% H₂O. This estimate is consistent with the observations in Fig. 6. This error in the water vapor concentration propagates to the measurement of the dry mole fractions, leading to an additional instrument-to-instrument variability of 0.024 ppm/% H₂O and 0.10 ppb/% H₂O for CO₂ and CH₄, respectively. These errors do not apply when instrument specific correction factors are generated, since the water scale variability is accounted for directly in the measurement method.

4.1.2 Stability over time and transferability across multiple instruments

Based on Method #1 and #2, water corrections for the CO₂/CH₄/H₂O analyzer (CFADS37) from Max Planck Institute for Biogeochemistry have been derived in February 2009, November 2010, and July 2012 to assess the long-term stability of the correction. Furthermore, a number of analyzers have been evaluated, including the more recent 2000 series, to evaluate the transferability of the correction between different analyzers. The stability of the water corrections for both CO₂ and CH₄ are demonstrated in Fig. 7, which shows the differences between the measured dry air mole fraction and the corrected values for the measurements in wet air for the different experiments and analyzers. Note that for all analyzers the same coefficients in the wet-dry correction are used based on Chen et al. (2010), and all instruments use the same scale for water vapor measurements. The results shown in Fig. 7 indicate an excellent stability over time, with differences between corrected and actual dry air mole fractions less than 0.05 ppm and 1 ppb for CO₂ and CH₄, respectively, for the experiments with the CFADS37 separated by about 3.5 yr. Furthermore, the results for analyzers CFADS15 and CFADS30 (red squares and grey small dots in Fig. 7) show similar differences, indicating full transferability of the correction at least for the range up to about 2 % water vapor mole fraction. The results from a recent experiment with the CFKB2004 four-species analyzer and CFADS37 (in July 2012) show slightly larger differences for up to 2 % water vapor mole fraction, but all except for one value are within the limits given by the WMO recommended compatibility goal. Similar results have been shown for three

High accuracy measurements of CO₂ and CH₄ in humid air

C. W. Rella et al.

Title Page

Abstract

Introduction

Conclusions

References

Tables

Figures

⏪

⏩

◀

▶

Back

Close

Full Screen / Esc

Printer-friendly Version

Interactive Discussion



CRDS analyzers tested at NOAA/ESRL using Method #2 (Fig. 8), which demonstrates that transferring the coefficients based on Chen et al. (2010) to the three analyzers causes an error less than 0.1 ppm CO₂ and less than 2 ppb for CH₄ for up to 3 % water vapor mole fraction. Note that the water vapor measurements have not been cross-referenced to each other. The differences at low water vapor mole fractions may be due to the small differences between the three analyzers and the one tested by Chen et al. (2010).

4.2 LSCE results

Repeatability in the determination of the correction factors using different methods on a single instrument

Over a period of twenty days, the correction factors were determined on a single instrument with multiple trials of methods #1 and #2. The differences between these correction factors relative to the values described in Chen et al. (2010) are shown in Fig. 9, for nominal levels of 400 ppm and 1900 ppb for CO₂ and CH₄, respectively. The repeated trials appear to lead to a significant spread in the corrected values, although we note that all values are within the GAW compatibility targets up to 2 % water vapor for CO₂ and 4 % water vapor for CH₄, and the range for CO₂ increases to 4 % if one of the humidifier tests is eliminated as an outlier. The root cause of this outlier has not been identified. This result clearly points to the fact that the different methodologies are all capable of producing high-quality results, but that the confidence in the results can be increased by performing multiple measurements.

4.3 Empa results

Stability over time and transferability across multiple instruments

At Empa, the water correction factors were determined using Method #2 on a single instrument (CFADS49) over a period of 18 months. The results of these repeated

High accuracy measurements of CO₂ and CH₄ in humid air

C. W. Rella et al.

Title Page

Abstract

Introduction

Conclusions

References

Tables

Figures

⏪

⏩

◀

▶

Back

Close

Full Screen / Esc

Printer-friendly Version

Interactive Discussion



measurements are shown in Fig. 10, where the difference between the first measurement and the subsequent five measurements are shown, along with the GAW compatibility targets. The correction factors produce dry mole fraction results that are within the GAW compatibility targets up to 2 % and 4 % water vapor for CO₂ and CH₄, respectively. Note that this result is a combined uncertainty that captures the errors in Method #2 as implemented at Empa, as well as drift in the instrument over time.

Similarly, one may compare the correction factors determined on multiple instruments. These results are shown in Fig. 11, along with the values described in Chen et al. (2010). As is clear from the figures, the transferability of the correction factors between instruments extends to about 1 % water vapor for both CO₂ and CH₄. This result highlights the point that using a single set of coefficients for all instrumentation leads to GAW-quality results at low to moderate humidity levels, but that at high levels, it is strongly encouraged that the correction functions be determined for each individual instrument independently. In addition, regular repetitions of the experiment are recommended to quantify the correction functions over time.

4.4 Direct spectroscopic interference analysis

In the previous sections, we have implicitly assumed that the correction to water vapor the simple dependence described by Eq. (4) is valid for the three species. In this section, we discuss and quantify two possible effects which could bias the dry mole calculation: direct spectroscopic interference between carbon dioxide, methane, and water vapor, and the effects of stable isotopes on these measurements.

4.4.1 Direct spectroscopic interference

To derive Eq. (4), it was necessary to explicitly assume that the bias in the reported dry mole fractions of CO₂ and CH₄ measurements is zero when the water vapor concentration is zero, or when the CO₂ or CH₄ concentrations are zero. However, if there is direct spectroscopic interference between the species, then this could cause a bias

in the measurements that would not follow this same functional form. To investigate this effect, the following three sets of measurements were performed in the Picarro research laboratory:

1. Measurements where the CO₂ and CH₄ were zero, but the water vapor was varied over a wide range of values.
2. Measurements where water vapor and CH₄ were zero, but CO₂ was varied over a wide range of values.
3. Measurements where water vapor and CO₂ were zero, but CH₄ was varied over a wide range of values.

As a result of these measurements, we arrive at the following results for the bias between different species:

$$(\text{CO}_2)_{\text{bias}} = -0.0339 \text{ ppm}/\% \text{H}_2\text{O}$$

$$(\text{CH}_4)_{\text{bias}} = -0.46 \text{ ppb}/\% \text{H}_2\text{O}$$

$$(\text{H}_2\text{O})_{\text{bias}} = 9.1 \times 10^{-6} \% \text{H}_2\text{O} (\text{ppm CO}_2)^{-1} - 9.4 \times 10^{-6} \% \text{H}_2\text{O} (\text{ppm CH}_4)^{-1}$$

Although these measurements were performed on a single G2401 instrument, we expect all G1301, G2301, and G2401 analyzer to exhibit substantially identical behavior. The first two biases are not insignificant relative to the GAW targets for CO₂ and CH₄ dry mole fractions. However, it is important to remember that *all* of these biases are included in the measurement of the water vapor correction factors at whatever mole fraction of CO₂ and CH₄ is used for determining the correction factors. These biases only emerge when the ambient air differs from the nominal test concentrations for CO₂ and CH₄. The biases are proportional to the difference between ambient and tested values, divided by the tested value, due to the fact that these offset errors are taken up by the linear coefficients during fitting of

High accuracy measurements of CO₂ and CH₄ in humid air

C. W. Rella et al.

Title Page

Abstract

Introduction

Conclusions

References

Tables

Figures

⏪

⏩

◀

▶

Back

Close

Full Screen / Esc

Printer-friendly Version

Interactive Discussion



High accuracy measurements of CO₂ and CH₄ in humid air

C. W. Rella et al.

Title Page

Abstract

Introduction

Conclusions

References

Tables

Figures

⏪

⏩

◀

▶

Back

Close

Full Screen / Esc

Printer-friendly Version

Interactive Discussion

the data. For example, when the ambient dry mole fraction is 400 ppm and the instrument is tested at 440 ppm, the CO₂ error from water vapor of 0.0339 ppm/% water corresponds to a bias of $(440 - 400)/400 \cdot (-0.0339) = -0.00339$ ppm/% H₂O. This is negligible. Similarly, for ambient methane at 2.1 ppm measured on an instrument that was tested at 1.9 ppm, the bias in the corrected dry mole fraction is $(2.1 - 1.9)/1.9 \cdot (-0.46) = -0.048$ ppb/% H₂O, which is similarly negligible. Nevertheless, to avoid any unnecessary bias in the correction function, experiments deriving the correction coefficients should be performed using working standards with mole fraction close to ambient values. Finally, the bias term for water, for a 40 ppm change in CO₂ and a 0.2 ppm change in CH₄, leads to a 0.00036 % bias in the water vapor concentration, which corresponds to a 0.002 ppm bias in the reported dry mole fraction of CO₂, and a 0.007 ppb bias in the dry mole fraction of CH₄. On the whole, these biases are small and can be ignored for most monitoring situations, but for best results, one may consider removing these dependences from the reported humid values prior to testing for, and applying, the water vapor corrections.

4.4.2 Stable isotope effects

There is no bias in the water vapor correction factor associated with the stable isotopes of the analyte species CO₂ or CH₄ (although there are biases associated with the isotopic composition of the calibration tanks which must be considered). However, the stable isotope composition of water vapor is a different story. The water vapor concentration is measured using the most abundant isotopologue of water. Variability in the other, less abundant isotopologues in the ambient air (or during testing for the water vapor coefficients) can lead to errors in the dry-mole fraction corrections.

The four most abundant isotopologues of water are ¹H₂¹⁶O, ¹H₂¹⁸O, ¹H₂¹⁷O, and ²H¹H¹⁶O. The nominal abundances of these species are 99.7 %, 0.21 %, 0.038 %, and 0.023 %, respectively, with the next most abundant isotopologue having a relative abundance of just 2.4×10^{-7} . As long as these ratios remain constant throughout the process of determining the correction factors and for all ambient measurements, then

High accuracy measurements of CO₂ and CH₄ in humid air

C. W. Rella et al.

[Title Page](#)
[Abstract](#)
[Introduction](#)
[Conclusions](#)
[References](#)
[Tables](#)
[Figures](#)
[⏪](#)
[⏩](#)
[◀](#)
[▶](#)
[Back](#)
[Close](#)
[Full Screen / Esc](#)
[Printer-friendly Version](#)
[Interactive Discussion](#)

there is no effect whatsoever upon the dry mole calculation. However, in the real world, the isotope ratios of water vapor can vary over a wide range: the abundances of ¹H₂¹⁸O, ¹H₂¹⁷O, and ²H¹H¹⁶O relative to ¹H₂¹⁶O can vary by up to 3%, 1.5%, and 25%, respectively, depending on the conditions under which the measurements are made (Gupta et al., 2009; Galewsky et al., 2011). Larger variations can be seen, but only in alpine or arctic environments, where the water vapor concentration is extremely low (less than 0.1%). The errors in the three isotopologues are almost always well-correlated for naturally derived waters. We may then estimate the error in the dry-mole fraction calculations by taking the maximum value of each of these ranges as the worst case scenario. The maximal error in the estimation of the total water vapor concentration of all isotopologues from the single measurement of the ¹H₂¹⁶O line is 1 part in 8000. If we assume that the other isotopologues have the same broadening effect on CO₂ and CH₄ as does the most abundant isotopologue, this error in the water vapor concentration corresponds to a bias in the CO₂ dry mole fraction of 0.0006 ppm/% H₂O, and of 0.003 ppb/% H₂O for CH₄. These errors are negligible compared to the GAW targets for these gases.

5 Field validation

5.1 MPI – validation of CO₂/CH₄ measurements during BARCA

One CRDS analyzer (CO₂/CH₄/H₂O) was flown without drying the air and without in-flight calibrations for two weeks on a research aircraft over the Amazon rain forest during the BARCA campaign in May 2009 (Chen et al., 2010). On the same aircraft, CO₂ measurements were also made by an NDIR analyzer with a drying system and frequent in-flight calibrations. Besides these two continuous in situ measurements, air samples taken in glass flasks on the aircraft were analyzed for CO₂ and CH₄ in the laboratory. The fact that there was no significant trend in the per flight mean differences between the two in situ continuous CO₂ measurements suggests that the CO₂

measurements of the CRDS analyzer (including the wet-dry corrections) were stable over the period of two weeks.

We have also compared the in situ measurements of CO₂ and CH₄ from the CRDS analyzer with the analysis results of flask samples (see Fig. 12). For the comparison of in situ with flask measurements, weighting functions have been used to integrate the in situ measurements to account for atmospheric variability (Chen et al., 2012).

5.2 LSCE – parallel measurements of CO₂ and CH₄ at Mace Head

Two Picarro CRDS instruments are running at the Mace Head (MHD) atmospheric monitoring station. The setup for performing the parallel measurements is shown in Fig. 13. One instrument is a G1301 (CFADS046) that belongs to the Irish EPA. This instrument has been running at the station since May 2009 measuring ambient air without drying. The second instrument is a G2301 (CFADS2122) owned by LSCE, and which was co-located at MHD in March of 2011. This instrument measures ambient air after a cryogenic water trap. Each of the two instruments is equipped with a dedicated ambient air line (1/2" O.D. Synflex) leading to an inlet at the top of a 20 m high mast. Both instruments share the same multi-position valve (VICI EMT2CSD8UWE), which means that they use the same calibration and target tank, as well as the same measurement sequence (i.e., ambient measurements and calibration are performed at the same time). Both instruments use the same water vapor correction coefficients as described in Chen et al. (2010).

Measurements were made over a period of about 2 months in this configuration, during which time the ambient water vapor concentration varied over a range from 1–2%. The measurement results are shown in Fig. 14. The top graph of each panel (CO₂ on the left, CH₄ on the right) shows the two data sets, along with the difference between the two instruments. There is a fair amount of scatter in the difference. In the bottom graphs of each panel, the results for the dry target tanks are also shown, along with the difference between the two instruments. Clearly the G2301 has a much higher degree of drift than the G1301. This drift is in fact mirrored in the ambient air differences, with

High accuracy measurements of CO₂ and CH₄ in humid air

C. W. Rella et al.

Title Page

Abstract

Introduction

Conclusions

References

Tables

Figures

⏪

⏩

◀

▶

Back

Close

Full Screen / Esc

Printer-friendly Version

Interactive Discussion



a high degree of correlation (note: as a result of these observations, the G2301 was shipped back to the Picarro factory for repair, where this fault was corrected). The drift in this instrument tends to mask the performance of the water correction methodology. For this reason, the target tank data was used as a single-point calibration to better track and correct for this drift. The result of this drift correction process is shown in Fig. 15, showing the hourly difference between the two instruments over time, as well as a histogram of this difference. Both the bias and the standard deviation are well within the compatibility targets for both gases, indicating that the water vapor correction of the G1301 is not biasing or otherwise degrading the results.

5.3 Empa and FMI – parallel measurements of CO₂ and CH₄ at Pallas

Parallel measurements using two Picarro G2401 CO, CO₂, CH₄ and H₂O analyzers were made at the Global GAW station Pallas (67.97° N, 24.12° E, 560 m a.s.l.) as part of a system and performance audit conducted by the World Calibration Centre WCC-Empa within the framework of the WMO/GAW quality assurance system.

The Pallas Picarro G2401 (CFKADS-2018) instrument is connected to the common air inlet system of the station. The inlet system consists of an acid-proof stainless steel manifold with an outer diameter of 60 mm, and it is continuously flushed with a nominal flow rate of 130 m³ h⁻¹ (residence time 1 s). From there the analyzer is connected by 1/8 inch stainless steel (SS) tubing. The sample air passes through a 3-way solenoid valve to a Nafion dryer (Perma Pure MD-070-96S-2) and then to the analyzer. Purge air for the Nafion is taken from the analyzer's vacuum line (reflux method). A target cylinder of dried compressed air is connected to the remaining port of the 3-way valve. The target cylinder is measured every 9.5 h for 15 min. This Nafion based drying system achieves a water vapor mole fraction of approximately 0.1 % (range 0.04–0.15 %) for the sample air. It also humidifies the air from the target cylinder to about the same mole fraction. The analyzer is calibrated against a set of WMO/CCL standards 4–5 times a year, at which time each cylinder is measured for 30 min. The target cylinder results are not used to adjust the data between calibrations.

High accuracy measurements of CO₂ and CH₄ in humid air

C. W. Rella et al.

Title Page

Abstract

Introduction

Conclusions

References

Tables

Figures

⏪

⏩

◀

▶

Back

Close

Full Screen / Esc

Printer-friendly Version

Interactive Discussion



High accuracy measurements of CO₂ and CH₄ in humid air

C. W. Rella et al.

Title Page

Abstract

Introduction

Conclusions

References

Tables

Figures

⏪

⏩

◀

▶

Back

Close

Full Screen / Esc

Printer-friendly Version

Interactive Discussion



For the WCC-Empa Picarro G2401 (CFKADS-2001), two separate inlet lines are used. The measurement cycle is as follows: The air is sampled for 30 h from a separate 1/4 inch Synflex tubing which is additionally flushed by a by-pass pump at 2 l min⁻¹. The air intake of the separate inlet line is mounted within 0.5 m from the Pallas inlet.

5 Afterwards, the air is sampled for 10 h from the Pallas manifold. Then, 3 standards (one working and two target tanks) are measured for 15 min each. This sequence is repeated throughout the whole measurement campaign. The sample air is not dried in contrast to the Pallas instrument, and a correction which was determined by Method #2 is applied to the data. For the Picarro G2401 CFKADS-2001, the following fitting parameters were derived:

$$\text{CO}_2 : a = -1.186 \times 10^{-2} \pm 1.029 \times 10^{-5}, \quad b = -2.497 \times 10^{-4} \pm 3.446 \times 10^{-6}$$

$$\text{CH}_4 : a = -9.635 \times 10^{-3} \pm 1.818 \times 10^{-5}, \quad b = -1.917 \times 10^{-4} \pm 6.091 \times 10^{-6}$$

15 The dry air mole fraction calculated based on this method was then corrected for instrument drift using the working standard measurements that were made every 40 h. Figure 16 shows the CO₂ time series (1-min data) measured with the Pallas and the WCC Picarro G2401 instruments for the period from 20 April to 30 May 2012 (upper panel). The WCC analyzer was using its own inlet system (blue) alternating with the manifold of the Pallas station (orange). The difference between the Pallas and the WCC instruments is plotted in the lower panel of Fig. 16 together with the H₂O mole fraction measured by the WCC instrument (not calibrated). Both instruments capture changes in the CO₂ mole fraction very well, and the overall agreement between the two instruments is further illustrated in Fig. 17. It can also be seen that the two independent inlet systems gave identical results with no significant change in the CO₂ mole fraction for both inlets. Furthermore, the bias between the two instruments did not depend on the water vapor content of the ambient air, illustrated in Fig. 18 where the CO₂ difference of the two analyzers is plotted against the H₂O measured by the WCC instrument. This lack of dependence of the bias on water vapor indicates that the applied correction

function as determined by the experiment in Sect. 3.1.2 is fully adequate to compensate for H₂O dilution and interference.

The same analysis has also been made for the CH₄ measurements of the two instruments. The results are presented in Figs. 19–21. These results indicate that the H₂O correction is also applicable to CH₄ measurements. The agreement between the two instruments was excellent, without significant difference between the two inlet systems and humid vs. dry measurements.

Figure 22 shows the water mole fraction measured with the Pallas G2401 analyzer after the Nafion dryer (left y-axis) and the ambient H₂O (right y-axis). The ambient H₂O levels ranged from 0.24 to 1.27 %; after drying, the remaining humidity ranged from 0.05 to 0.11 %. However, it should be noted that the H₂O mole fraction after the Nafion dryer regularly dropped by approx. 0.005 % when the Pallas working standard was measured. This is due to humidification of the working standard, which itself is completely dry, on the Nafion dryer. For CO₂, this can result in a bias of approx. 0.02 ppm at ambient mole fractions of 400 ppm CO₂.

5.4 Penn State University – parallel measurements of CO₂ in Indianapolis

To assess the accuracy of the water vapor correction in field conditions, two CRDS instruments (Picarro, Inc., Santa Clara, CA, USA, models CADS and G2401) were co-located at a tower in Indianapolis, IN for 3 months. 1/4" O.D. Synflex tubing (part number 1300-04403) was used from the sample level (121 m a.g.l.) to the instruments, with a 3-way compression fitting to split the flow. While the G2401 instrument was dried using a Nafion dryer (Permapure, part number MD-110-24S-2), with a dry air generator (Twin Tower Engineering, part number MW200) providing the counter flow, the CADS instrument was not dried and relied on the internal water vapor correction. The CADS instrument is different from the other instruments in this study, in the sense that the water vapor is measured using a different spectroscopic line than the other instrumentation, due to the fact that the laser used to measure the water vapor in the G1301 and G2301 is not available in the CADS instrument (Richardson et al., 2012).

High accuracy measurements of CO₂ and CH₄ in humid air

C. W. Rella et al.

Title Page

Abstract

Introduction

Conclusions

References

Tables

Figures



Back

Close

Full Screen / Esc

Printer-friendly Version

Interactive Discussion



**High accuracy
measurements of
CO₂ and CH₄ in
humid air**

C. W. Rella et al.

Title Page

Abstract

Introduction

Conclusions

References

Tables

Figures

⏪

⏩

◀

▶

Back

Close

Full Screen / Esc

Printer-friendly Version

Interactive Discussion



To cross-calibrate the two spectroscopic lines, a special test was performed at the Picarro factory on a G1301 that was modified to measure both lines quasi-simultaneously (alternating between the two measurements every three seconds), while ramping the water vapor concentration over a substantial range (0–3%). The software of the CADS instrument was then modified so that the water vapor concentration was reported on the same scale as the G1301. The wet-dry coefficients used were those described in Chen et al. (2010).

Figure 23 shows a schematic of the sampling and measurement components of the two systems. Both systems used Parker Inc. (Cleveland, OH, USA, part number 003-0216-900) valves, Air Liquide (Plumsteadville, PA, Model 51-14B-590) regulators and 1/8" O.D. stainless steel tubing. Field calibrations were performed separately for each system, sampling NOAA-ESRL tanks for 10 min each every 23 h. The CO₂ only field standards for the CADS system were prepared by NOAA-ESRL (thus containing near atmospheric values of CO₂ isotopic ratios) and were calibrated at Penn State, while the field standards for the G2401 system were prepared and calibrated by NOAA-ESRL. The G2401 system also sampled an additional tank hourly to assess drifts in the CO measurement, and sampled 10 m and 40 m a.g.l. hourly as well. Data from the CADS system were subsampled according to when the G2401 data were available and hourly values were compared. Water vapor values ranged over a wide range during this period of time, even higher than 4% at times. While these high levels give some reason to suspect that the inlet line upstream of both analyzers may have been contaminated with liquid water during the measurements, the fact that both instruments are sampling from the same inlet means that this potential contamination would not affect the head-to-head comparison presented here.

The overall difference between the CO₂ levels of the two systems (Fig. 24) was 0.01 ± 0.09 ppm over a period of 90 days, excluding points with the difference greater than two standard deviations above the mean in magnitude (3% of points). A least squares best fit line to the CO₂ difference as a function of water vapor indicated a slight water vapor dependence, with a slope of 0.02 ppm CO₂/ % H₂O. The difference in CO₂

also had a slight CO₂ dependence, decreasing from 0.07 ppm at 360 ppm to -0.05 ppm at 420 ppm. Both of these dependences are smaller than the WMO inter-laboratory compatibility goal of 0.1 ppm for CO₂.

5.5 NOAA – parallel measurements of CO₂ at the BAO tall tower

5 The Picarro CRDS instrument (Model G1301, SN CFADS09) was installed for about two months during Fall 2011 at the 300-m tall Boulder Atmospheric Observatory (BAO) tower near Boulder, CO, where routine in-situ measurements are made using a LI-COR NDIR CO₂ analyzer on a dried ambient air stream (Andrews et al., 2012). The water vapor correction coefficients were measured in the laboratory using Method #2
10 several months prior to this deployment. Ambient air for the CRDS instrument was drawn from a dedicated inlet line directly into the instrument. The sample airstream for the NDIR LI-COR instrument (model Li-7000) was drawn from a separate inlet line and compressed to approximately 10 p.s.i.g, passed through a chilled glass trap (1.5 °C), a solenoid manifold, and a 144" Nafion membrane dryer. The LI-COR baseline drift is
15 monitored every 2 h, and a full calibration is performed twice per day. The flow rates through the two inlet systems were nearly the same, and a constant time offset was applied to account for different lag times through the 300 m long inlet line.

The left panel of Fig. 25 shows the CO₂ time series for a typical 3 day period from both instruments. When the CRDS data stream is averaged over 30 s, the results become essentially indistinguishable on this graph. The right panel of Fig. 25 shows the difference between the two sets of measurements. The median difference between the two measurements over this period of time is 0.042 ppm, with a standard deviation of 0.056 ppm, well within the stated GAW compatibility goal of 0.1 ppm. This provides further strong evidence that the dry-mole fraction reported by the G1301 on humid air is
25 statistically indistinguishable from measurements made on a dry gas stream. Finally, in Fig. 26, the difference between the two measurements is plotted vs. water vapor (left panel) and carbon dioxide (right panel). No significant bias is visible with respect to

High accuracy measurements of CO₂ and CH₄ in humid air

C. W. Rella et al.

Title Page

Abstract

Introduction

Conclusions

References

Tables

Figures

⏪

⏩

◀

▶

Back

Close

Full Screen / Esc

Printer-friendly Version

Interactive Discussion

either species. During this test the water vapor level varied from about 0.6 to 1.4 % as measured by the G1301.

6 Conclusions

Until recently, it has been accepted in the world of greenhouse gas monitoring that drying to low levels (below -25°C dew point) is required for high quality measurements which meet or exceed the WMO targets for inter-laboratory compatibility. However, recent advances in laser-based optical spectroscopy have allowed high quality dry mole fraction measurements of CO_2 and CH_4 directly in the humid gas stream. Operating without drying allows one to measure the ambient water vapor level, an important atmospheric tracer for air mass changes, as well as serving as a diagnostic for condensation or other liquid contamination in the inlet system. Several leading research laboratories have demonstrated the performance of these CRDS analyzers both in the lab and in the field. Some of these key results are collected here. From these results, we may draw the following conclusions:

1. There are at least two straightforward and effective methods for determining the water vapor correction factors (with several variations). Measurements on multiple instruments, and on a single instrument over time, indicate that the analyzers exhibit the high degree of stability necessary to maintain high standards for accuracy over time. The methods for performing this test are straightforward and do not require cumbersome or highly specialized equipment, and can be performed in the laboratory or even in the field, provided that some care is taken to remove potential biases in the measurement due to dissolved CO_2 and CH_4 in the liquid water. No significant biases have been detected between the different methods, or between the different implementations performed at different laboratories.
2. By using the single set of values for the water vapor correction factors described in Chen et al. (2010), it is possible to make measurements of CO_2 and CH_4 that meet

AMTD

5, 5823–5888, 2012

High accuracy measurements of CO_2 and CH_4 in humid air

C. W. Rella et al.

Title Page

Abstract

Introduction

Conclusions

References

Tables

Figures

⏪

⏩

◀

▶

Back

Close

Full Screen / Esc

Printer-friendly Version

Interactive Discussion



High accuracy measurements of CO₂ and CH₄ in humid air

C. W. Rella et al.

[Title Page](#)[Abstract](#)[Introduction](#)[Conclusions](#)[References](#)[Tables](#)[Figures](#)[⏪](#)[⏩](#)[◀](#)[▶](#)[Back](#)[Close](#)[Full Screen / Esc](#)[Printer-friendly Version](#)[Interactive Discussion](#)

the GAW inter-laboratory compatibility targets for water vapor concentrations up to at least 1 %, or a dew point of about 5 °C. This result is already a significant step forward, allowing the use of simpler, less effective drying techniques (0.1–0.3 % residual water vapor) than those typically employed in this community (< 0.005 % residual water vapor). In particular, this strategy has been adopted by Earth Networks, a commercial greenhouse gas monitoring network (Welp et al., 2012), and has been recommended elsewhere (Nara et al., 2012). Also, it is important to note that many alpine or other cold weather locales never experience humidity levels above 1 %.

3. By measuring the water vapor correction factors at the start of life on a per-instrument basis as described in Sect. 3, the range of water vapor mole fraction can be extended up to at least 2 %.
4. By measuring the water vapor correction factors periodically (perhaps once every several months), the evidence suggests that the range of water vapor over which GAW quality measurements can be made extends above 4 %, covering even the most humid ambient conditions.
5. Several in-situ comparison studies between measurements on humid and dry ambient gas streams have been performed to date, using water vapor correction coefficients determined using the methods described in this manuscript. In these studies, the mean difference between wet and dry measurements is observed to be well within GAW compatibility targets, indicating that the laboratory methodologies for determining these coefficients generate unbiased results. In addition, the standard deviation of the difference between the dry mole fractions measured in humid and dry measurements is also well within GAW targets. This result is an important validation of the idea that simply by measuring the water vapor concentration of ambient air in a highly precise and stable (though not necessarily accurate) way, the dry-mole fraction can be determined with a high degree of precision and accuracy (provided standards are applied in an appropriate manner).

High accuracy measurements of CO₂ and CH₄ in humid air

C. W. Rella et al.

Title Page

Abstract

Introduction

Conclusions

References

Tables

Figures

⏪

⏩

◀

▶

Back

Close

Full Screen / Esc

Printer-friendly Version

Interactive Discussion



Given conclusion #4, above, it would be desirable to devise a method for quantifying the water vapor correction factors in-situ in an automated fashion. Such a method would further simplify the field deployment of these analyzers and improve the quality of the data, by increasing the frequency of the determination of the water correction coefficients. We emphasize that a field deployable method that would meet the requirements of periodically testing the water vapor correction coefficients need not be a complete measurement method, such as those described above. It is likely to be sufficient to periodically check the proper operation of the dry-mole fraction reporting, such as by humidifying (e.g., with Nafion) a standard or target tank.

Supplementary material related to this article is available online at:
<http://www.atmos-meas-tech-discuss.net/5/5823/2012/amtd-5-5823-2012-supplement.pdf>.

Acknowledgements. Laboratory experiments at the Max Planck Institute for Biogeochemistry were supported through the IAGOS research infrastructure, funded in its preparatory phase under the European Community's Seventh Framework Programme FP7, grant agreement no. 212128. The measurement campaign at Pallas was supported by MeteoSwiss through engagement in the WMO Global Atmosphere Watch Programme. A portion of the data from Mace Head observatory was provided thanks to Michael Geever and Gerard Spain from National University of Ireland, Galway; and thanks to David Dood from Environment Protection Agency, Dublin, Ireland. Finally, the authors would also like to thank R. Keeling, R. Weiss, and L. Welp-Smith for thoughtful discussion.

References

- Bakwin, P. S., Tans, P. P., Zhao, C., Ussler, W., and Quesnell, E.: Measurements of carbon dioxide on a very tall tower, Tellus B, 47, 535–549, 1995.
- Bousquet, P.: Regional changes in carbon dioxide fluxes of land and oceans since 1980, Science, 290, 1342–1346, doi:10.1126/science.290.5495.1342, 2000.

High accuracy measurements of CO₂ and CH₄ in humid air

C. W. Rella et al.

[Title Page](#)
[Abstract](#)
[Introduction](#)
[Conclusions](#)
[References](#)
[Tables](#)
[Figures](#)
[Back](#)
[Close](#)
[Full Screen / Esc](#)
[Printer-friendly Version](#)
[Interactive Discussion](#)

- Chen, H., Winderlich, J., Gerbig, C., Hoefler, A., Rella, C. W., Crosson, E. R., Van Pelt, A. D., Steinbach, J., Kolle, O., Beck, V., Daube, B. C., Gottlieb, E. W., Chow, V. Y., Santoni, G. W., and Wofsy, S. C.: High-accuracy continuous airborne measurements of greenhouse gases (CO₂ and CH₄) using the cavity ring-down spectroscopy (CRDS) technique, *Atmos. Meas. Tech.*, 3, 375–386, doi:10.5194/amt-3-375-2010, 2010.
- Chen, H., Winderlich, J., Gerbig, C., Katrynski, K., Jordan, A., and Heimann, M.: Validation of routine continuous airborne CO₂ observations near the Bialystok Tall Tower, *Atmos. Meas. Tech.*, 5, 873–889, doi:10.5194/amt-5-873-2012, 2012.
- Corbin, K. D., Denning, A. S., Lokupitiya, E. Y., Schuh, A. E., Miles, N. L., Davis, K. J., Richardson, S., Corbin, K. D., Denning, A. S., Lokupitiya, E. Y., Schuh, A. E., Miles, N. L., Davis, K. J., Richardson, S., and Baker, I. T.: Assessing the impact of crops on regional CO₂ fluxes and atmospheric concentrations, *Tellus B*, 62, 521–532, doi:10.1111/j.1600-0889.2010.00485.x, 2010.
- Crosson, E. R.: A cavity ring-down analyzer for measuring atmospheric levels of methane, carbon dioxide, and water vapor, *Appl. Phys. B*, 92, 403–408, doi:10.1007/s00340-008-3135-y, 2008.
- Enting, I. G., Trudinger, C. M., and Francey, R. J.: A synthesis inversion of the concentration and $\delta^{13}\text{C}$ of atmospheric CO₂, *Tellus B*, 47, 35–52, doi:10.1034/j.1600-0889.47.issue1.5.x, 1995.
- Fan, S.: A large terrestrial carbon sink in North America implied by atmospheric and oceanic carbon dioxide data and models, *Science*, 282, 442–446, doi:10.1126/science.282.5388.442, 1998.
- Galewsky, J., Rella, C., Sharp, Z., Samuels, K., and Ward, D.: Surface measurements of upper tropospheric water vapor isotopic composition on the Chajnantor Plateau, Chile, *Geophys. Res. Lett.*, 38, 1–5, doi:10.1029/2011GL048557, 2011.
- Gupta, P., Noone, D., Galewsky, J., Sweeney, C., and Vaughn, B. H.: Demonstration of high-precision continuous measurements of water vapor isotopologues in laboratory and remote field deployments using wavelength-scanned cavity ring-down spectroscopy (WS-CRDS) technology, available at: <http://www.ncbi.nlm.nih.gov/pubmed/19603459>, *Rapid Commun. Mass Spectrom.*, 23, 2534–2542, 2009.
- Gurney, K. R., Law, R. M., Denning, A. S., Rayner, P. J., Baker, D., Bousquet, P., Bruhwiler, L., Chen, Y.-H., Ciais, P., Fan, S., Fung, I. Y., Gloor, M., Heimann, M., Higuchi, K., John, J., Maki, T., Maksyutov, S., Masarie, K., Peylin, P., Prather, M., Pak, B. C., Randerson, J.,

High accuracy measurements of CO₂ and CH₄ in humid air

C. W. Rella et al.

[Title Page](#)
[Abstract](#)
[Introduction](#)
[Conclusions](#)
[References](#)
[Tables](#)
[Figures](#)
[⏪](#)
[⏩](#)
[◀](#)
[▶](#)
[Back](#)
[Close](#)
[Full Screen / Esc](#)
[Printer-friendly Version](#)
[Interactive Discussion](#)

Sarmiento, J., Taguchi, S., Takahashi, T., and Yuen, C.-W.: Towards robust regional estimates of CO₂ sources and sinks using atmospheric transport models, *Nature*, 415, 626–630, doi:10.1038/415626a, 2002.

IPCC: Summary for policymakers, in: *Climate Change 2007: The Physical Science Basis, Contribution of Working Group I to the Fourth Assessment Report of the Intergovernmental Panel on Climate Change*, edited by: Solomon, S., Qin, D., Manning, M., Chen, Z., Marquis, M., Averyt, K. B., Tignor, M., and Miller, H. L., Cambridge University Press, Cambridge, UK and New York, NY, USA, 2007.

Keeling, C. D.: The concentration and isotopic abundances of carbon dioxide in the atmosphere, *Tellus*, 12, 200–203, doi:10.1111/j.2153-3490.1960.tb01300.x, 1960.

Keeling, R. F.: Measuring correlations between atmospheric oxygen and carbon dioxide mole fractions: a preliminary study in urban air, *J. Atmos. Chem.*, 7, 153–176, 1988.

Keeling, R. F. and Shertz, S. R. Seasonal and interannual variations in atmospheric oxygen and implications for the global carbon cycle, *Nature*, 358, 723–727, 1992.

Lauvaux, T., Gioli, B., Sarrat, C., Rayner, P. J., Ciais, P., Chevallier, F., Noilhan, J., Miglietta, F., Brunet, Y., Ceschia, E., Holman, H., Elbers, J. A., Gerbig, C., Hutjes, R., Jarosz, N., Legain, D., and Uliasz, M.: Bridging the gap between atmospheric concentrations and local ecosystem measurements, *Geophys. Res. Lett.*, 36, L19809, doi:10.1029/2009GL039574, 2009.

Lauvaux, T., Schuh, A. E., Uliasz, M., Richardson, S., Miles, N., Andrews, A. E., Sweeney, C., Diaz, L. I., Martins, D., Shepson, P. B., and Davis, K. J.: Constraining the CO₂ budget of the corn belt: exploring uncertainties from the assumptions in a mesoscale inverse system, *Atmos. Chem. Phys.*, 12, 337–354, doi:10.5194/acp-12-337-2012, 2012a.

Lauvaux, T., Schuh, A. E., Bocquet, M., Wu, L., Richardson, S., Miles, N., and Davis, K. J.: Network design for mesoscale inversions of CO₂ sources and sinks, *Tellus B*, 64, 17980, doi:10.3402/tellusb.v64i0.17980, 2012b.

Ma, S. and Skou, E.: CO₂ permeability in Nafion[®] EW1100 at elevated temperature, *Solid State Ionics*, 178, 615–619, doi:10.1016/j.ssi.2007.01.030, 2007.

Matross, D. M., Andrews, A., Pathmathevan, M., Gerbig, C., Lin, J. C., Wofsy, S. C., Daube, B. C., Gottlieb, E. W., Chow, V. Y., Lee, J. T., Zhao, C., Bakwin, P. S., Munger, J. W., and Hollinger, D. Y.: Estimating regional carbon exchange in New England and Quebec by combining atmospheric, ground-based and satellite data, *Tellus B*, 58, 344–358, doi:10.1111/J.1600-0889.2006.00206.X, 2006.

High accuracy measurements of CO₂ and CH₄ in humid air

C. W. Rella et al.

[Title Page](#)
[Abstract](#)
[Introduction](#)
[Conclusions](#)
[References](#)
[Tables](#)
[Figures](#)
[Back](#)
[Close](#)
[Full Screen / Esc](#)
[Printer-friendly Version](#)
[Interactive Discussion](#)

- McKain, K., Wofsy, S. C., Nehrkorn, T., Eluszkiewicz, J., Ehleringer, J. R., and Stephens, B. B.: Assessment of ground-based atmospheric observations for verification of greenhouse gas emissions from an urban region, *P. Natl. Acad. Sci.*, 109, 8423–8428, doi:10.1073/pnas.1116645109, 2012.
- 5 Nara, H., Tanimoto, H., Tohjima, Y., Mukai, H., Nojiri, Y., Katsumata, K., and Rella, C.: Evaluation of factors affecting accurate measurements of atmospheric CO₂ and CH₄ by wavelength-scanned cavity ring-down spectroscopy, *Atmos. Meas. Tech. Discuss.*, 5, 5009–5041, doi:10.5194/amtd-5-5009-2012, 2012.
- 10 Peters, W., Jacobson, A. R., Sweeney, C., Andrews, A. E., Conway, T. J., Masarie, K., Miller, J. B., Bruhwiler, L. M. P., Pétron, G., Hirsch, A. I., Worthy, D. E. J., van der Werf, G. R., Randerson, J. T., Wennberg, P. O., Krol, M. C., and Tans, P. P.: An atmospheric perspective on North American carbon dioxide exchange: CarbonTracker, *P. Natl. Acad. Sci.*, 104, 18925–18930, doi:10.1073/pnas.0708986104, 2007.
- 15 Peters, W., Krol, M. C., van der Werf, G. R., Houweling, S., Jones, C. D., Hughes, ., Schaefer, K., Masarie, K. A., Jacobson, A. R., Miller, J. B., Cho, C. H., Ramonet, M., Schmidt, M., Ciattaglia, L., Apadula, F., Heltal, D., Meinhardt, F., Di Sarra, A. G., Piacentino, S., Sferlazzo, D., Aalto, T., Hatakka, J., Ström, J., Haszpra, L., Meijer, H. A. J., Van der Laan, S., Neubert, R. E. M., Jordan, A., Rodó, X., Morguí, J.-A., Vermeulen, A. T., Popa, E., Rozanski, K., Zimnoch, M., Manning, A. C., Leuenberger, M., Uglietti, C., Dolman, A. J., Ciais, P., Heimann, M., and Tans, P. P.: Seven years of recent European net terrestrial carbon dioxide exchange constrained by atmospheric observations, *Global Change Biol.*, 16, 1317–1337, doi:10.1111/j.1365-2486.2009.02078.x, 2010.
- 20 Richardson, S. J., Miles, N. L., Davis, K. J., Crosson, E. R., Rella, C. W., and Andrews, A. E.: Field testing of cavity ring-down spectroscopy analyzers measuring carbon dioxide and water vapor, *J. Atmos. Ocean. Tech.*, 29, 397–406, doi:10.1175/JTECH-D-11-00063.1, 2012.
- 25 Tolk, L. F., Peters, W., Meesters, A. G. C. A., Groenendijk, M., Vermeulen, A. T., Steenveld, G. J., and Dolman, A. J.: Modelling regional scale surface fluxes, meteorology and CO₂ mixing ratios for the Cabauw tower in the Netherlands, *Biogeosciences*, 6, 2265–2280, doi:10.5194/bg-6-2265-2009, 2009.
- 30 WMO: Report of the 15th WMO/IAEA Meeting of Experts on Carbon Dioxide, Other Greenhouse Gases, and Related Tracers Measurement Techniques, 7–10 September 2009, GAW Report No. 194, WMO TD No. 1553, available at: <http://www.wmo.int/pages/prog/arep/gaw/>

documents/GAW_194_WMO_TD_No_1553_web_low_resol.pdf last access: 14 August 2012, Jena, Germany, 2011a.

WMO: WMO Greenhouse Gas Bulletin, available at: http://www.wmo.int/pages/prog/arep/gaw/ghg/documents/GHGbulletin_7_en.pdf (last access: 10 August 2012), 2011b.

- 5 Varghese, P. L. and Hanson, R. K.: Collisional narrowing effects on spectral line shapes measured at high resolution, *Appl. Optics*, 23, 2376, doi:10.1364/AO.23.002376, 1984.
- Welp, L. R., Keeling, R. F., Weiss, R. F., Paplawsky, W., and Heckman, S.: Design and performance of a Nafion dryer for continuous operation at CO₂ and CH₄ air monitoring sites, *Atmos. Meas. Tech. Discuss.*, 5, 5449–5468, doi:10.5194/amtd-5-5449-2012, 2012.
- 10 Winderlich, J., Chen, H., Gerbig, C., Seifert, T., Kolle, O., Lavric, J. V., Kaiser, C., Höfer, A., and Heimann, M.: Continuous low-maintenance CO₂/CH₄/H₂O measurements at the Zotino Tall Tower Observatory (ZOTTO) in Central Siberia, *Atmos. Meas. Tech.*, 3, 1113–1128, doi:10.5194/amt-3-1113-2010, 2010.
- 15 Zellweger, C., Steinbacher, M., and Buchmann, B.: Evaluation of three new laser spectrometer techniques for in-situ carbon monoxide measurements, *Atmos. Meas. Tech. Discuss.*, 5, 4735–4769, doi:10.5194/amtd-5-4735-2012, 2012.

AMTD

5, 5823–5888, 2012

High accuracy measurements of CO₂ and CH₄ in humid air

C. W. Rella et al.

Title Page

Abstract

Introduction

Conclusions

References

Tables

Figures

⏪

⏩

◀

▶

Back

Close

Full Screen / Esc

Printer-friendly Version

Interactive Discussion

High accuracy measurements of CO₂ and CH₄ in humid air

C. W. Rella et al.

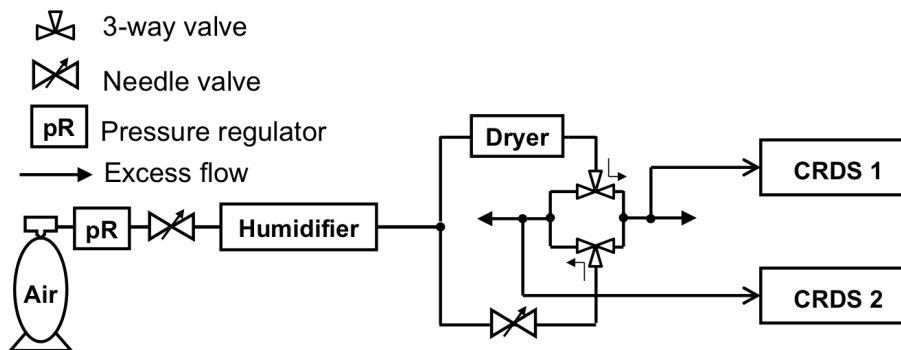

Fig. 1. Schematic for the setup of Method #1.

Title Page

Abstract

Introduction

Conclusions

References

Tables

Figures

◀

▶

◀

▶

Back

Close

Full Screen / Esc

Printer-friendly Version

Interactive Discussion

**High accuracy
measurements of
CO₂ and CH₄ in
humid air**

C. W. Rella et al.

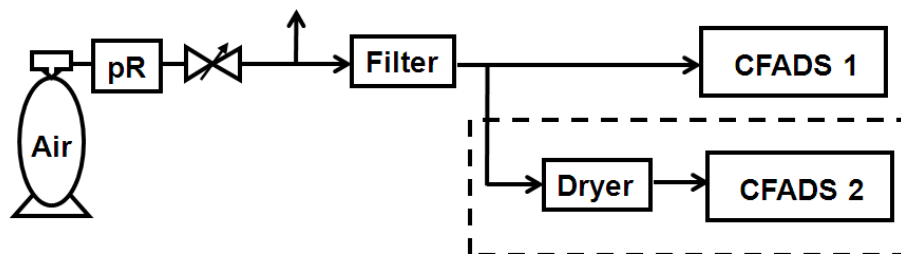

Fig. 2. Schematics of the setup for Method #2 (NOAA/MPI implementation). The water droplet is injected through a tee connector before the hydrophobic membrane filter. The components enclosed in a dashed rectangle are optional, and are used to verify the droplet method.

[Title Page](#)[Abstract](#)[Introduction](#)[Conclusions](#)[References](#)[Tables](#)[Figures](#)[◀](#)[▶](#)[◀](#)[▶](#)[Back](#)[Close](#)[Full Screen / Esc](#)[Printer-friendly Version](#)[Interactive Discussion](#)

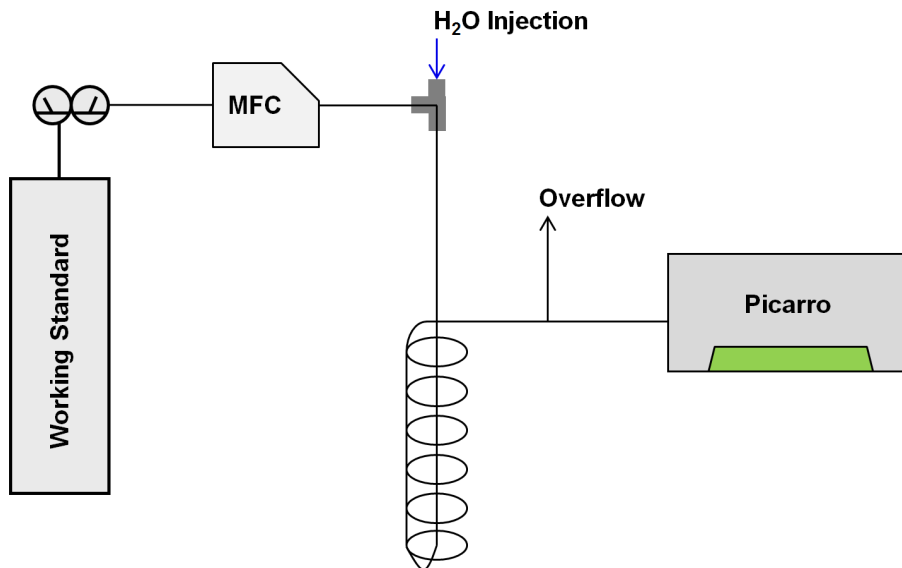

Fig. 3. Schematic for the setup of Method #2 (Empa implementation)

High accuracy measurements of CO₂ and CH₄ in humid air

C. W. Rella et al.

Title Page	
Abstract	Introduction
Conclusions	References
Tables	Figures
◀	▶
◀	▶
Back	Close
Full Screen / Esc	
Printer-friendly Version	
Interactive Discussion	

High accuracy measurements of CO₂ and CH₄ in humid air

C. W. Rella et al.

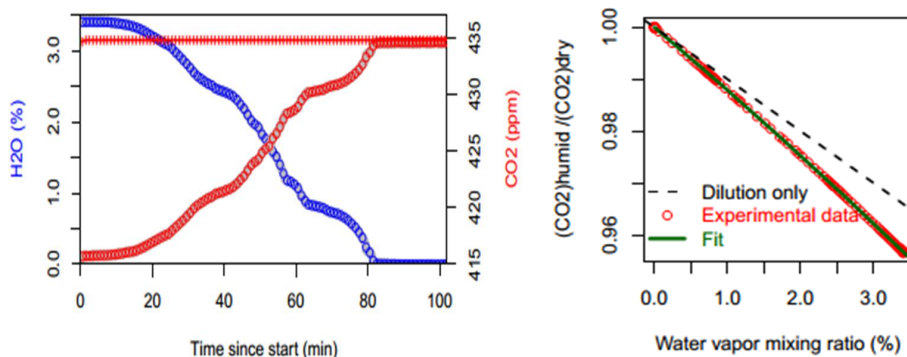

Fig. 4. Left: example of CO₂ and H₂O measured during a water vapor interference experiment as described above for a Picarro G2401 analyser. Grey circles are raw data and open circle are 1min-averages. The red crosses are water vapor corrected CO₂ data based on the fitting parameters determined by this experiment. Right: experimentally derived (CO₂)_{wet}/(CO₂)_{dry} ratios vs. water mixing ratios and fitted correction function.

[Title Page](#)
[Abstract](#)
[Introduction](#)
[Conclusions](#)
[References](#)
[Tables](#)
[Figures](#)
[◀](#)
[▶](#)
[◀](#)
[▶](#)
[Back](#)
[Close](#)
[Full Screen / Esc](#)
[Printer-friendly Version](#)
[Interactive Discussion](#)

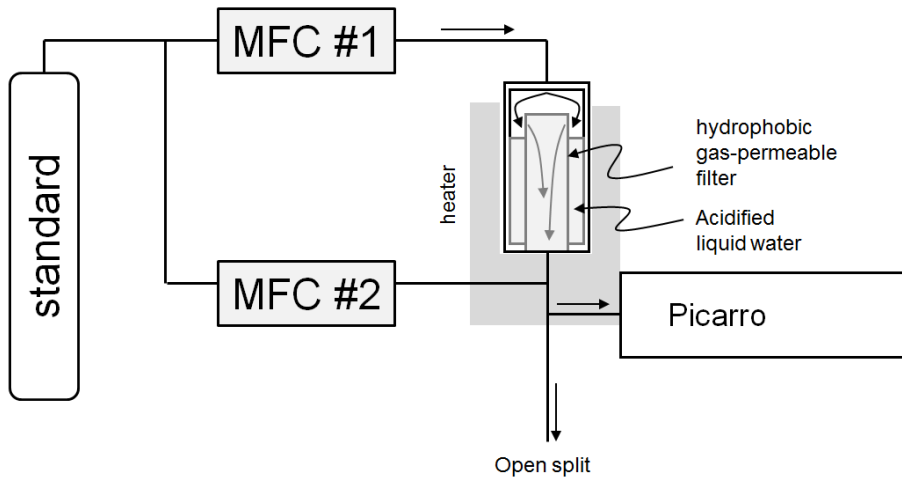

Fig. 5. Schematic for the setup of Method #2 (Picarro implementation).

High accuracy measurements of CO₂ and CH₄ in humid air

C. W. Rella et al.

Title Page	
Abstract	Introduction
Conclusions	References
Tables	Figures
◀	▶
◀	▶
Back	Close
Full Screen / Esc	
Printer-friendly Version	
Interactive Discussion	

High accuracy measurements of CO₂ and CH₄ in humid air

C. W. Rella et al.

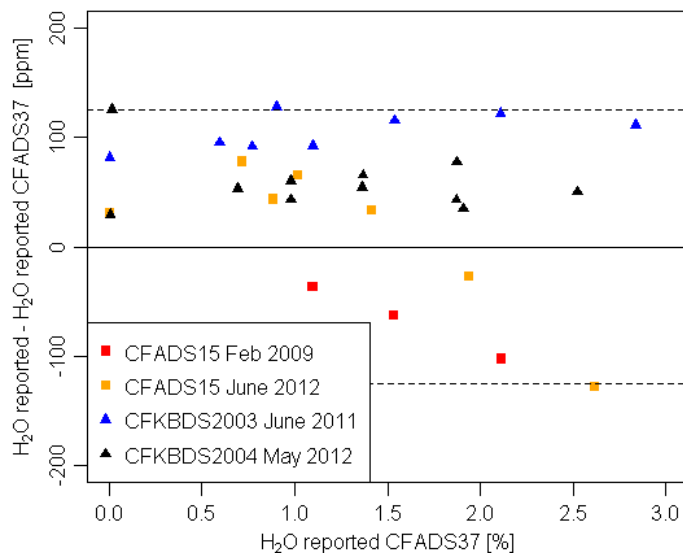

Fig. 6. Water vapor comparisons between the analyzers indicated in the legend and the CFADS37 analyzer. Shown are the differences of $(\text{H}_2\text{O})_{\text{rep}}$ from the respective analyzer and the CFADS37, against the $(\text{H}_2\text{O})_{\text{rep}}$ from the CFADS37 analyzer. The dashed lines indicate the 125 ppm H₂O differences.

Title Page

Abstract

Introduction

Conclusions

References

Tables

Figures

◀

▶

◀

▶

Back

Close

Full Screen / Esc

Printer-friendly Version

Interactive Discussion



High accuracy measurements of CO₂ and CH₄ in humid air

C. W. Rella et al.

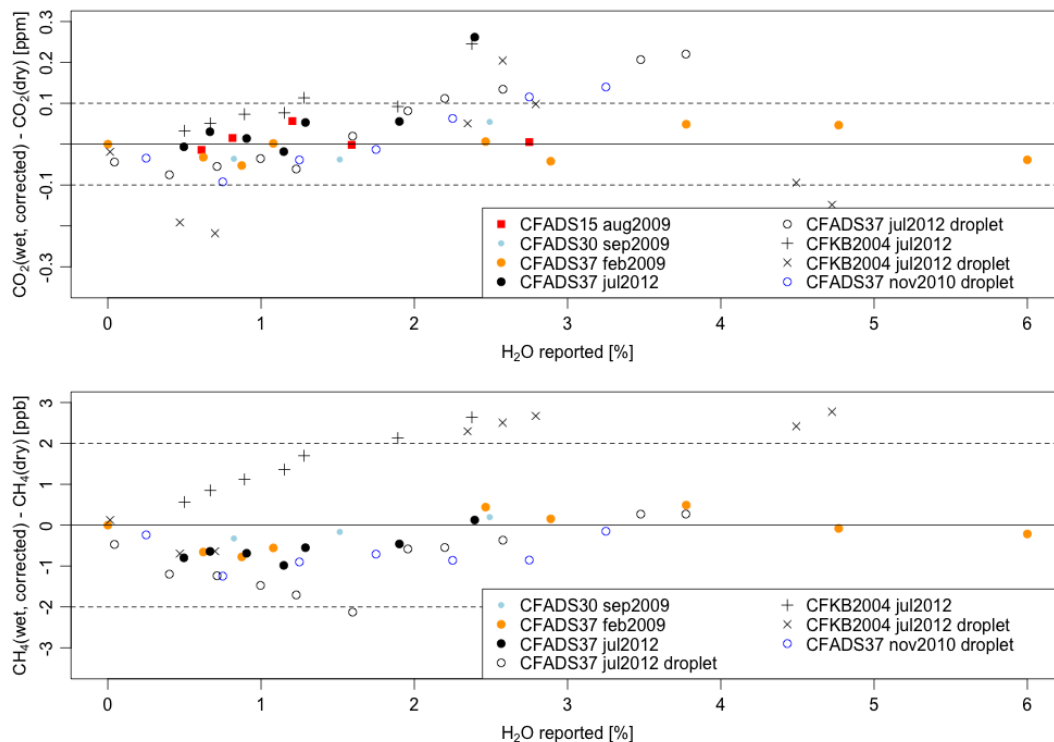

Fig. 7. Results from wet-dry experiments using method #1 at MPI Jena for CO₂ (top panel) and CH₄ (bottom panel). Shown are differences of dry measurements and corrected wet measurements using the Chen et al. (2010) coefficients. Different symbols indicate different instruments, and different colors indicate different times. Dashed lines indicate the compatibility goals set by the WMO (2011).

Title Page

Abstract

Introduction

Conclusions

References

Tables

Figures

◀

▶

◀

▶

Back

Close

Full Screen / Esc

Printer-friendly Version

Interactive Discussion

High accuracy measurements of CO₂ and CH₄ in humid air

C. W. Rella et al.

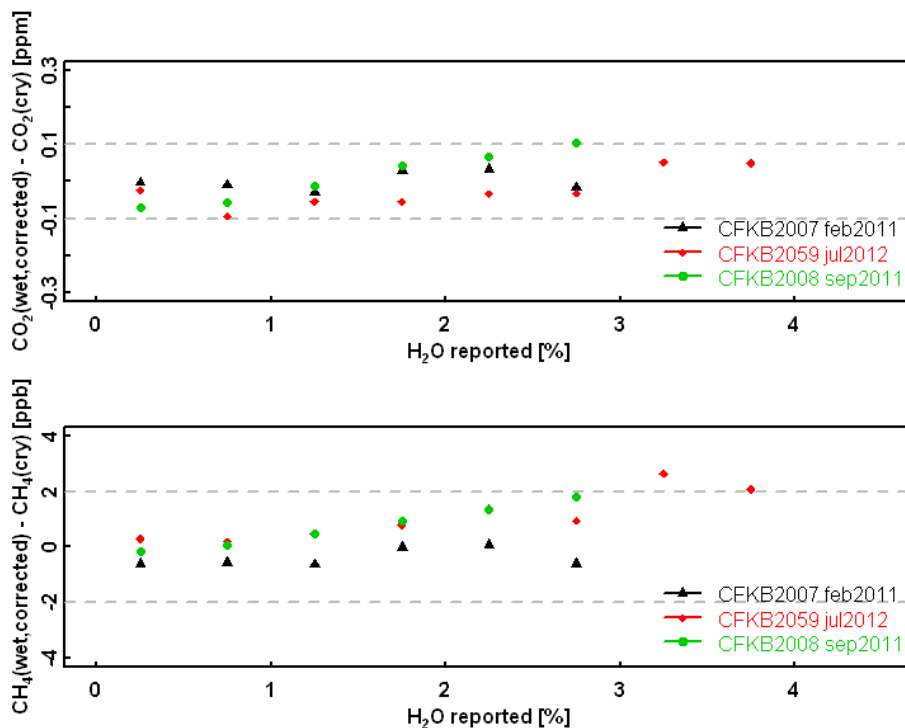

Fig. 8. Results from water droplet tests at NOAA Boulder for CO₂ (top panel) and CH₄ (bottom panel). Shown are differences of dry measurements and corrected wet measurements using the Chen et al. (2010) coefficients (without changes in water vapor). Different symbols indicate different instruments. Dashed lines indicate the compatibility goals set by the WMO (2011).

[Title Page](#)
[Abstract](#)
[Introduction](#)
[Conclusions](#)
[References](#)
[Tables](#)
[Figures](#)
[Back](#)
[Close](#)
[Full Screen / Esc](#)
[Printer-friendly Version](#)
[Interactive Discussion](#)

High accuracy measurements of CO₂ and CH₄ in humid air

C. W. Rella et al.

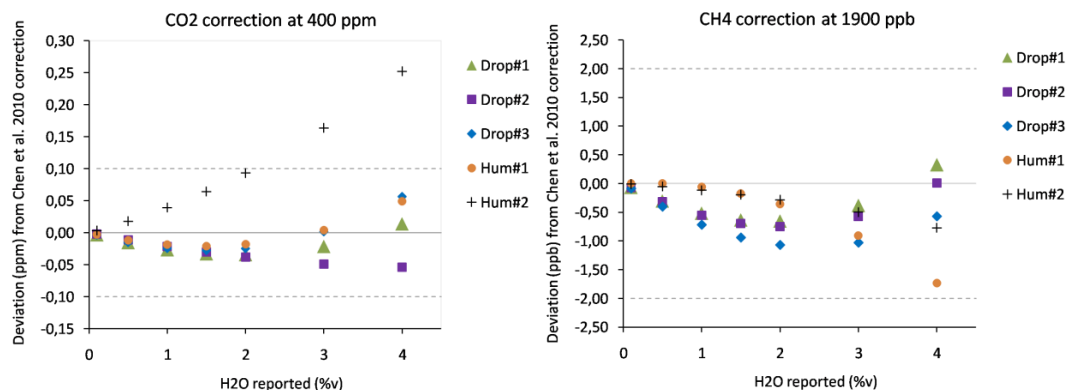

Fig. 9. Deviations between the correction factors determined on a single instrument using methods #1 and #2, and the values reported in Chen et al. (2010). Left panel: CO₂ measured at 400 ppm. Right panel: CH₄ measured at 1900 ppb.

**High accuracy
measurements of
CO₂ and CH₄ in
humid air**

C. W. Rella et al.

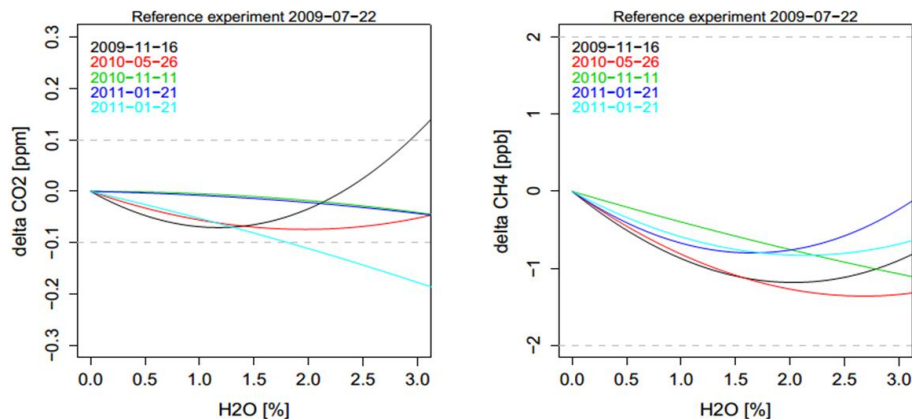

Fig. 10. Correction factors for a single G1301 instrument for CO₂ (left panel) and CH₄ (right panel) over a period of 18 months, plotted as a deviation against the initial determination of the correction on 22 July 2009.

Title Page

Abstract

Introduction

Conclusions

References

Tables

Figures

◀

▶

◀

▶

Back

Close

Full Screen / Esc

Printer-friendly Version

Interactive Discussion

**High accuracy
measurements of
CO₂ and CH₄ in
humid air**

C. W. Rella et al.

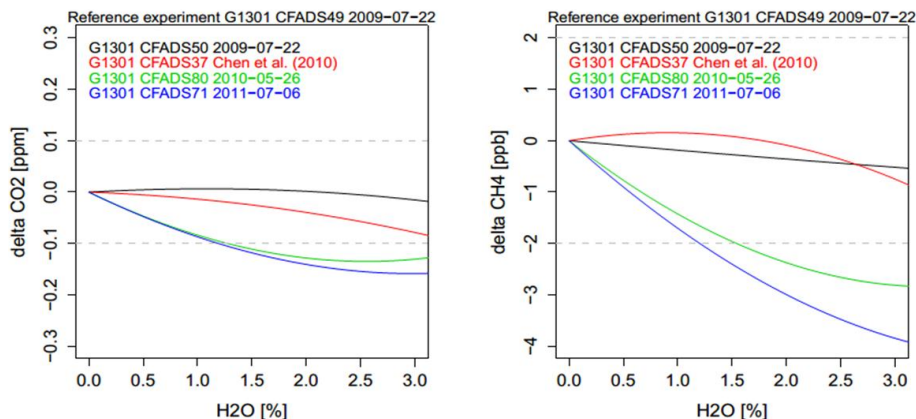

Fig. 11. Dry mole-fraction corrections for several instruments compared against a reference instrument (CFADS49), indicating instrument transferability the correction coefficients.

Title Page

Abstract

Introduction

Conclusions

References

Tables

Figures

◀

▶

◀

▶

Back

Close

Full Screen / Esc

Printer-friendly Version

Interactive Discussion

**High accuracy
measurements of
CO₂ and CH₄ in
humid air**

C. W. Rella et al.

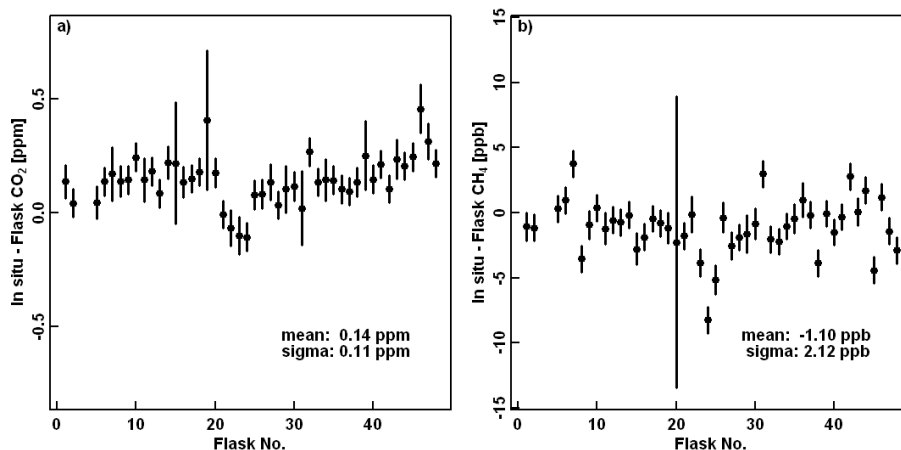

Fig. 12. Comparison of in situ with flask measurements of CO₂ and CH₄ mole fractions, plotted as a function of flask number, with mean and standard deviations shown in each figure. The error bars are calculated based on the uncertainty of flask analyses and variability of integrated in situ measurements with weighting functions shifted ± 4 s.

[Title Page](#)[Abstract](#)[Introduction](#)[Conclusions](#)[References](#)[Tables](#)[Figures](#)[◀](#)[▶](#)[◀](#)[▶](#)[Back](#)[Close](#)[Full Screen / Esc](#)[Printer-friendly Version](#)[Interactive Discussion](#)

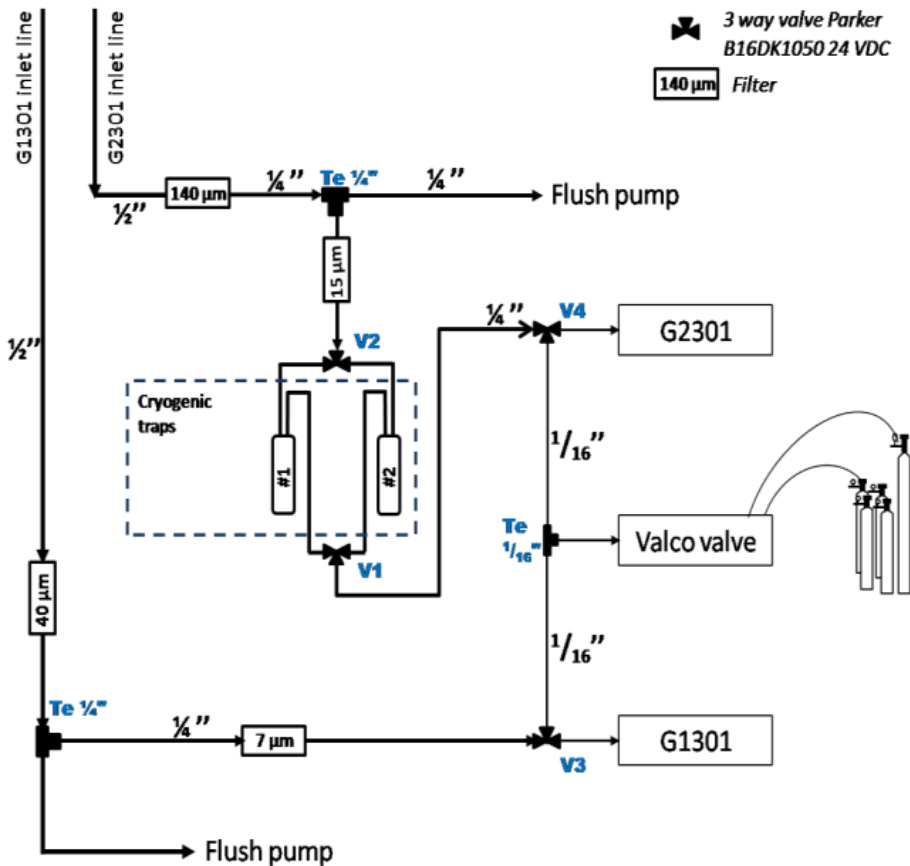

Fig. 13. Schematic for performing parallel measurements at the Mace Head (MHD) station.

High accuracy measurements of CO₂ and CH₄ in humid air

C. W. Rella et al.

Title Page	
Abstract	Introduction
Conclusions	References
Tables	Figures
◀	▶
◀	▶
Back	Close
Full Screen / Esc	
Printer-friendly Version	
Interactive Discussion	

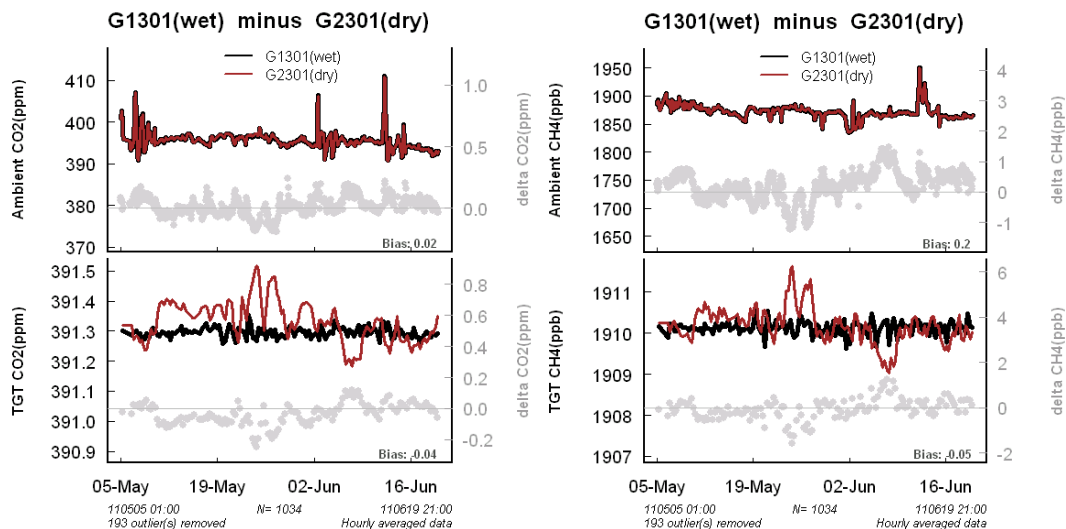

Fig. 14. Comparison between G1301 (wet) and G2301(dry) at MHD for CO_2 (left panels) and CH_4 (right panels). The top panel for each species shows the hourly data for both instruments (black and red curves, left axes) along with the different between the instruments (grey points, right axes). The bottom panels indicate the results for the target tank measurements for each instrument (red and black curves, left axes), as well as the different (grey points, right axis). Note the dramatically higher drift in the G2301 target tank, which is mirrored in the difference between the two instruments for both the target tank and ambient measurements.

High accuracy measurements of CO_2 and CH_4 in humid air

C. W. Rella et al.

Title Page

Abstract

Introduction

Conclusions

References

Tables

Figures

⏪

⏩

◀

▶

Back

Close

Full Screen / Esc

Printer-friendly Version

Interactive Discussion

High accuracy measurements of CO₂ and CH₄ in humid air

C. W. Rella et al.

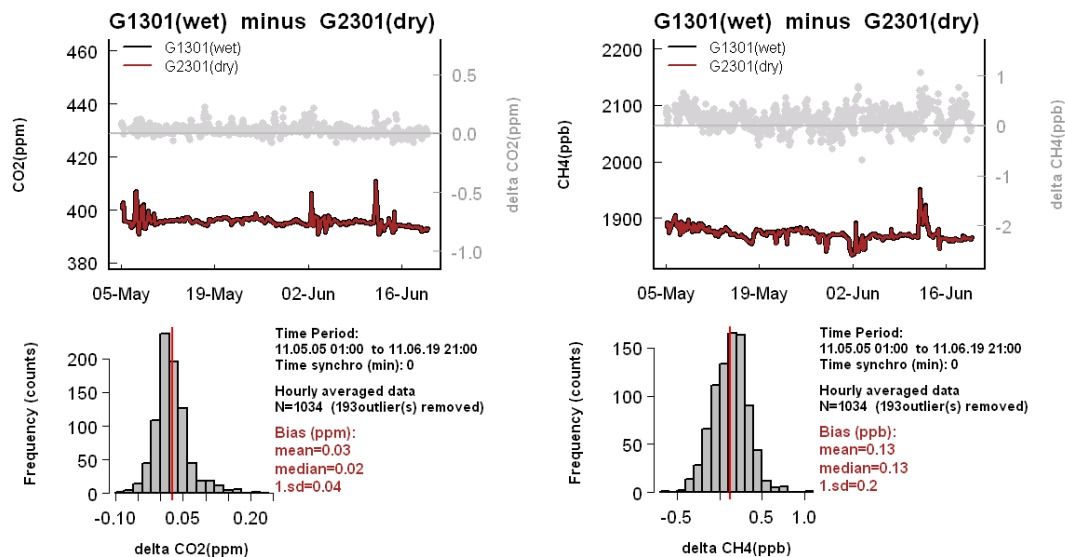

Fig. 15. Top panels: the hourly data for both instruments (black and red curves, left axes) along with the different between the instruments (grey points, right axes), is shown after removal of the drift by using the target tank as a single point calibration. Histogram of the target-corrected difference between the G1301 (wet) and G2301 (dry) measurements for CO₂ (lower left) and CH₄ (lower right).

[Title Page](#)
[Abstract](#)
[Introduction](#)
[Conclusions](#)
[References](#)
[Tables](#)
[Figures](#)
[⏪](#)
[⏩](#)
[◀](#)
[▶](#)
[Back](#)
[Close](#)
[Full Screen / Esc](#)
[Printer-friendly Version](#)
[Interactive Discussion](#)

High accuracy measurements of CO₂ and CH₄ in humid air

C. W. Rella et al.

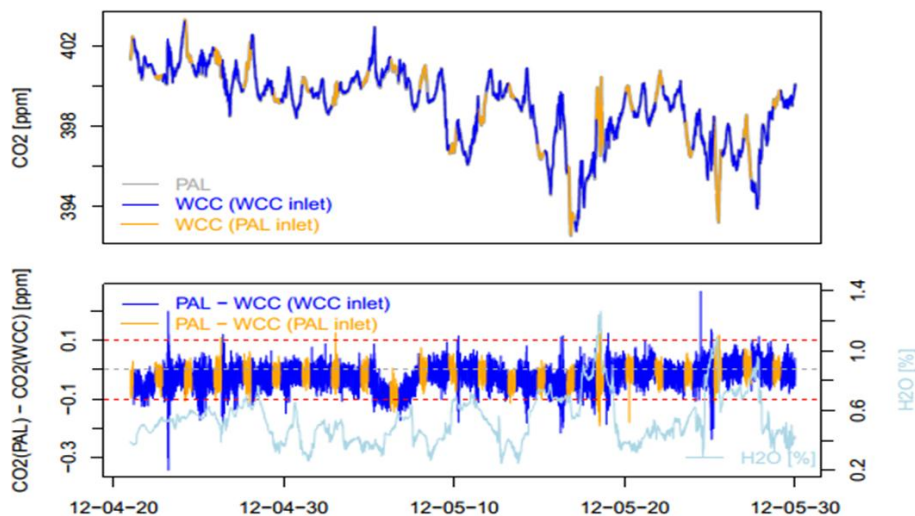

Fig. 16. Upper panel: 1-min average CO₂ mole fractions measured at Pallas by the Pallas Picarro G2401 with sample drying and the WCC Picarro G2401 without sample drying. The WCC instrument was alternating between its own inlet system and the Pallas manifold. Lower panel: CO₂ bias between the two analyzers (left y-axis) and H₂O measured by the WCC instrument (right y-axis). Red dashed lines correspond to GAW targets of 0.1 ppm CO₂.

**High accuracy
measurements of
CO₂ and CH₄ in
humid air**

C. W. Rella et al.

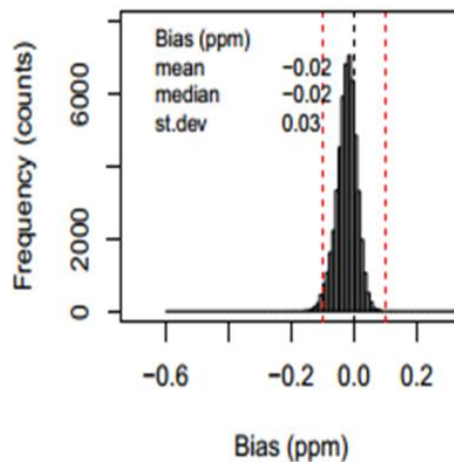

Fig. 17. Frequency distribution of the bias between the two CRDS instruments (bin width 0.01 ppm, 1-min averages). Red dashed lines correspond to GAW targets.

[Title Page](#)[Abstract](#)[Introduction](#)[Conclusions](#)[References](#)[Tables](#)[Figures](#)[◀](#)[▶](#)[◀](#)[▶](#)[Back](#)[Close](#)[Full Screen / Esc](#)[Printer-friendly Version](#)[Interactive Discussion](#)

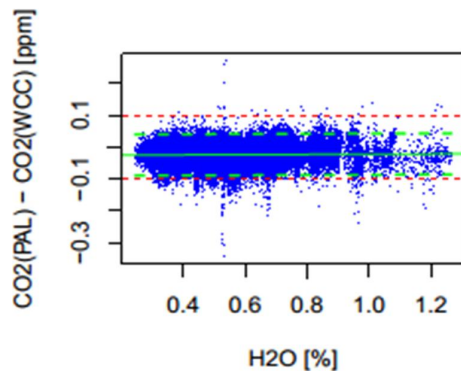

Fig. 18. CO₂ bias between the two instruments vs. H₂O mole fraction, measured by the WCC instrument for 1-min data. The green lines correspond to a linear regression (solid) with 95 % confidence intervals (dashed). Red dashed lines correspond to GAW targets.

High accuracy measurements of CO₂ and CH₄ in humid air

C. W. Rella et al.

Title Page

Abstract Introduction

Conclusions References

Tables Figures

⏪ ⏩

◀ ▶

Back Close

Full Screen / Esc

Printer-friendly Version

Interactive Discussion

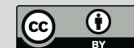

High accuracy measurements of CO₂ and CH₄ in humid air

C. W. Rella et al.

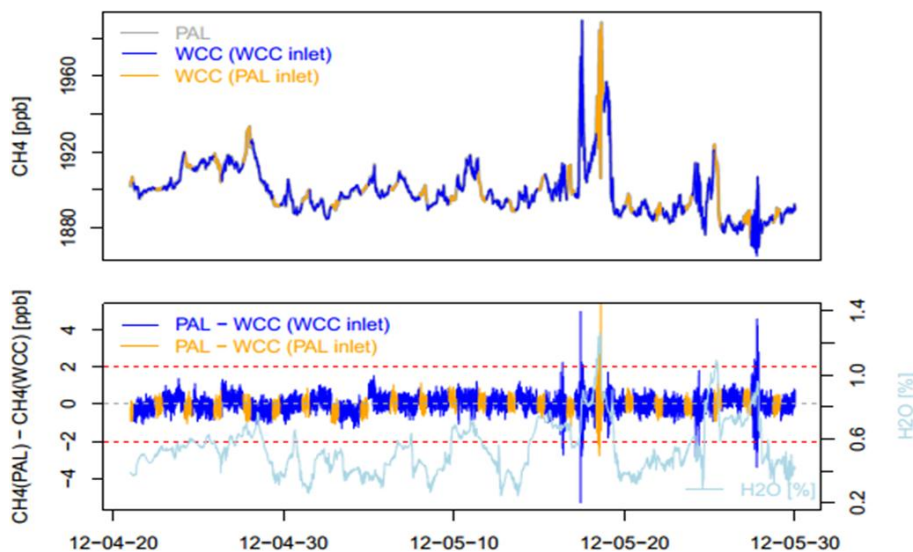

Fig. 19. Same as Fig. 16 for CH₄.

[Title Page](#)
[Abstract](#) [Introduction](#)
[Conclusions](#) [References](#)
[Tables](#) [Figures](#)
[◀](#) [▶](#)
[◀](#) [▶](#)
[Back](#) [Close](#)
[Full Screen / Esc](#)
[Printer-friendly Version](#)
[Interactive Discussion](#)

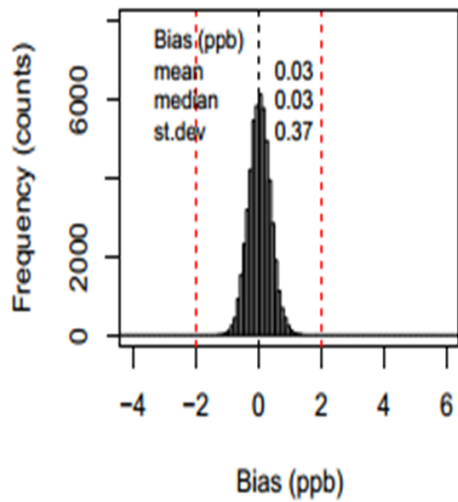

Fig. 20. Same as Fig. 17 for CH₄.

High accuracy measurements of CO₂ and CH₄ in humid air

C. W. Rella et al.

[Title Page](#)

[Abstract](#) | [Introduction](#)

[Conclusions](#) | [References](#)

[Tables](#) | [Figures](#)

[⏪](#) | [⏩](#)

[◀](#) | [▶](#)

[Back](#) | [Close](#)

[Full Screen / Esc](#)

[Printer-friendly Version](#)

[Interactive Discussion](#)



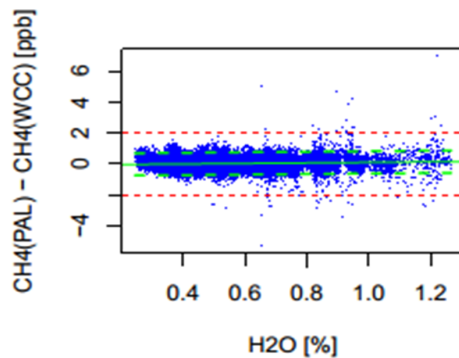

Fig. 21. Same as Fig. 18 for CH₄.

High accuracy measurements of CO₂ and CH₄ in humid air

C. W. Rella et al.

Title Page

Abstract

Introduction

Conclusions

References

Tables

Figures



Back

Close

Full Screen / Esc

Printer-friendly Version

Interactive Discussion



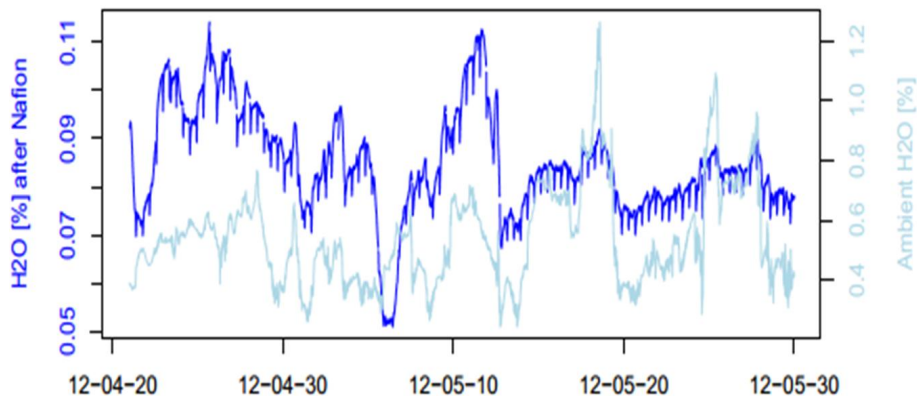

Fig. 22. H₂O mole fractions measured with the Pallas instrument after the Nafion dryer (left axis, dark blue line) and ambient H₂O measured with the WCC instrument (right axis, light blue line).

High accuracy measurements of CO₂ and CH₄ in humid air

C. W. Rella et al.

Title Page

Abstract

Introduction

Conclusions

References

Tables

Figures

⏪

⏩

◀

▶

Back

Close

Full Screen / Esc

Printer-friendly Version

Interactive Discussion



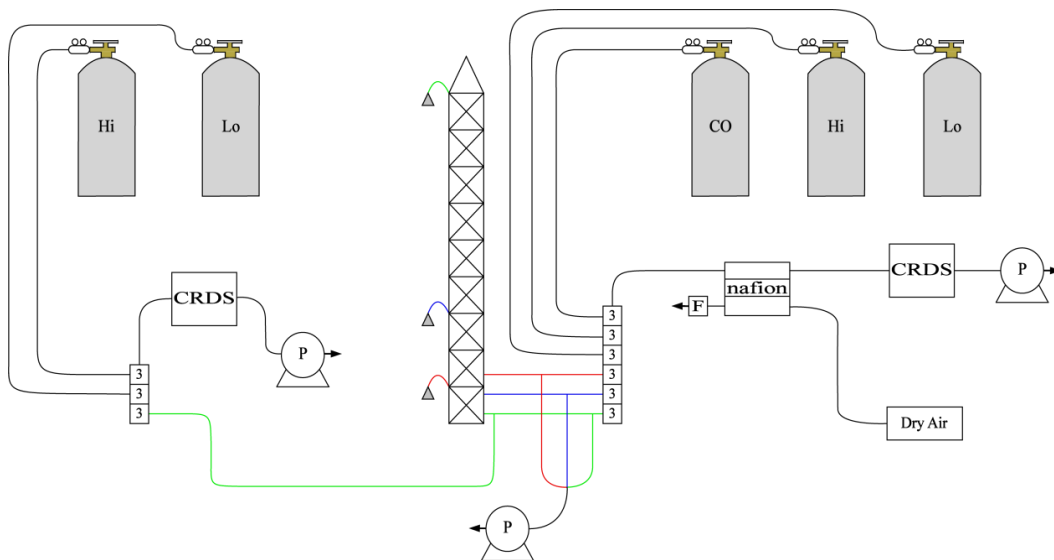

Fig. 23. Setup for parallel measurements in Indianapolis by Penn State University.

High accuracy measurements of CO₂ and CH₄ in humid air

C. W. Rella et al.

Title Page

Abstract

Introduction

Conclusions

References

Tables

Figures

◀

▶

◀

▶

Back

Close

Full Screen / Esc

Printer-friendly Version

Interactive Discussion

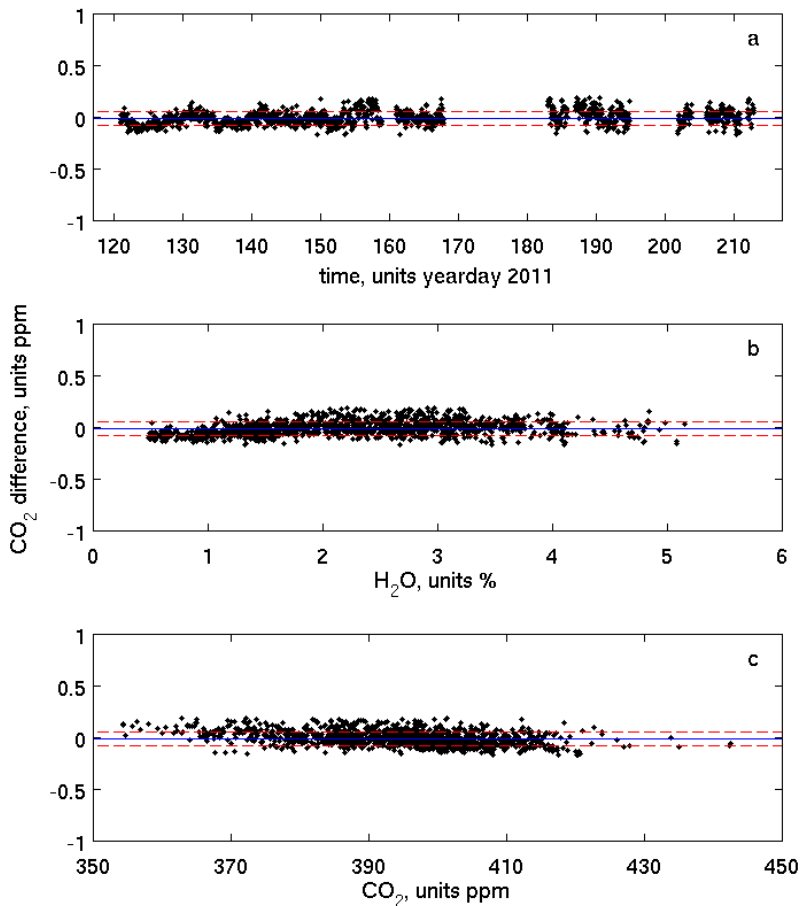

Fig. 24. Difference in CO₂ as measured between two CRDS systems measuring atmospheric air from a height of 121 m a.g.l., one with drying and one without, as a function of **(a)** day of year, **(b)** water vapor, and **(c)** CO₂.

High accuracy measurements of CO₂ and CH₄ in humid air

C. W. Rella et al.

Title Page

Abstract Introduction

Conclusions References

Tables Figures

⏪ ⏩

⏴ ⏵

Back Close

Full Screen / Esc

Printer-friendly Version

Interactive Discussion



High accuracy measurements of CO₂ and CH₄ in humid air

C. W. Rella et al.

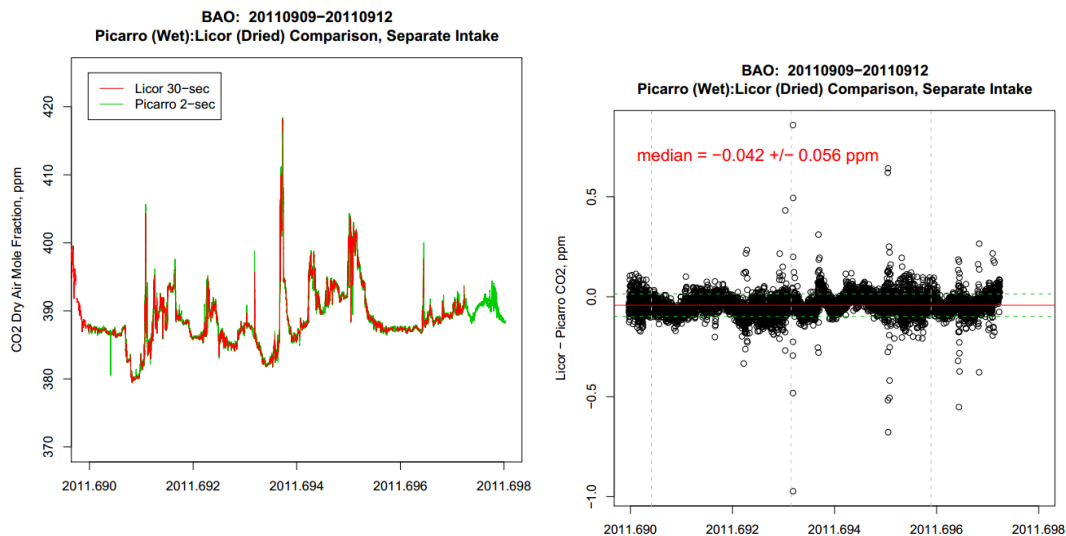

Fig. 25. Time series comparing the humid air measurements (G2401) vs the dry measurements (LI-COR) (left panel), along with the difference between the humid and dry measurements (right panel), as a function of time. The median value and 1 sigma values are plotted for reference.

Title Page

Abstract

Introduction

Conclusions

References

Tables

Figures

⏪

⏩

◀

▶

Back

Close

Full Screen / Esc

Printer-friendly Version

Interactive Discussion



**High accuracy
measurements of
CO₂ and CH₄ in
humid air**

C. W. Rella et al.

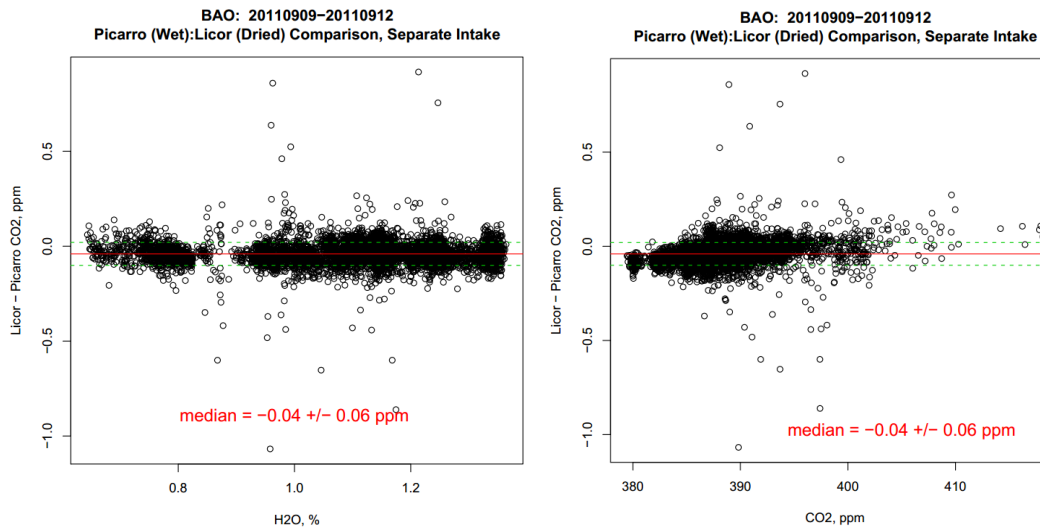

Fig. 26. Difference from the right panel of Fig. 25, plotted against water vapor mole fraction (left panel) and CO₂ (right panel). The median and 1 sigma values are plotted for reference.

Title Page

Abstract

Introduction

Conclusions

References

Tables

Figures

◀

▶

◀

▶

Back

Close

Full Screen / Esc

Printer-friendly Version

Interactive Discussion