

Gianfranco Federici, Charles H. Skinner, Jeffrey N. Brooks,  
Joseph Paul Coad, Christian Grisolia, Anthony A. Haasz,  
Ahmed Hassanein, Volker Philipps, C. Spencer Pitcher,  
Joachim Roth, William R. Wampler, Dennis G. Whyte

## **Plasma-Material Interactions in Current Tokamaks and their Implications for Next-Step Fusion Reactors**

*This IPP-Report has been printed as author's manuscript elaborated under the collaboration between IPP and EURATOM on the field of plasma physics. All rights reserved.*

*IPP-Reports express the views of the authors at the time of writing and do not necessarily reflect the opinions of the Max-Planck-Institut für Plasmaphysik or the final opinion of the authors on the subject.*

*Neither the Max-Planck-Institut für Plasmaphysik, nor the Euratom Commission, nor any person acting on behalf of either of these:*

- 1) gives any guarantee as to the accuracy and completeness of the information contained in this report, or that the use of any information, apparatus, method or process disclosed therein may not constitute an infringement of private owned right; or*
- 2) assumes any liability for damage resulting from the use of any information, apparatus, method or process disclosed in this report.*



**Plasma-Material Interactions in Current Tokamaks  
and their  
Implications for Next-Step Fusion Reactors.**

**Gianfranco FEDERICI<sup>1</sup>**

*ITER Garching Joint Work Site, Boltzmannstraße 2, D-85748 Garching, Germany.*

**Charles H. SKINNER<sup>†</sup>**

*Plasma Physics Laboratory, Princeton University, Princeton, New Jersey 08543, USA.*

**Jeffrey N. BROOKS<sup>‡</sup>**,

*Argonne National Laboratory, 9700 S. Cass Ave., Argonne, Illinois 60439, USA.*

**Joseph Paul COAD**

*JET Joint Undertaking, Abingdon, Oxfordshire, OX14 3EA, UK.*

**Christian GRISOLIA**

*Tore Supra, CEA Cadarache, F-13108 St Paul lez Durance, Cedex, France.*

**Anthony A. HAASZ<sup>§</sup>**

*University of Toronto, Institute for Aerospace Studies, Toronto, Ontario, M3H 5T6, Canada.*

**Ahmed HASSANEIN<sup>¶</sup>**

*Argonne National Laboratory, 9700 S. Cass Ave., Argonne, Illinois 60439, USA*

**Volker PHILIPPS**

*Institut für Plasmaphysik, Forschungszentrum Jülich, D-52425 Jülich, Germany.*

**C. Spencer PITCHER<sup>||</sup>**

*MIT Plasma Science and Fusion Center, 175 Albany Street - Cambridge, MA, 02139, USA.*

**Joachim ROTH**

*Max-Planck-Institut für Plasmaphysik, EURATOM Association, D-85748 Garching, Germany.*

**William R. WAMPLER<sup>\*\*</sup>**

*Sandia National Laboratories, Albuquerque, NM 87185, USA.*

**Dennis G. WHYTE<sup>††</sup>**

*University of California San Diego, La Jolla, California 92093-0417, USA*

---

<sup>1</sup> corresponding author: e-mail: federig@ipp.mpg.de, tel. +49-89-32994228; fax. +49-89-32994110.

<sup>†</sup> supported by the United States Department of Energy under Contract DE-AC02-76CH03073.

<sup>‡</sup> supported by the United States Department of Energy under Contract W-31-109-Eng-38.

<sup>§</sup> supported by the Natural Sciences and Engineering Research Council of Canada and ITER Canada.

<sup>¶</sup> supported by the United States Department of Energy under Contract W-31-109-Eng-38.

<sup>||</sup> supported by the United States Department of Energy under Contract DE-FC02-99ER54512.

<sup>\*\*</sup> supported by the United States Department of Energy under Contract DE-AC04-94AL85000.

<sup>††</sup> supported by the United States Department of Energy under Grant No. DE-FG03-95ER54301.

## PREFACE

Managing the interface between a burning plasma and the material world has long been regarded as one of the grand challenges of fusion. The issues came in to sharp focus in the process of designing of ITER. It also became clear that the diversity of phenomena at work in plasma-surface interactions had led to compartmentalisation - specialists were active within their areas but the issues often demanded integrated solutions that transcended the boundaries of individual disciplines. The link between the condition of plasma-facing surfaces and plasma performance was experimentally obvious to all, but the lack of an easily accessible up-to-date overview fostered lingering suspicions of 'kitchen physics' at the plasma boundary.

Three years ago we conceived a review that would make accessible the progress in understanding the physics of plasma-material interactions and the strong implications for next-step devices. An international group of co-authors joined together to provide the most authoritative overview of the different areas. What we naively underestimated was a quantity increasingly scarce in the world today, the time needed to weld the material into a coherent whole. Electronic communication, especially email attachments, proved to be an essential tool to facilitate input and integrate material from co-authors spread over the globe.

The review is aimed for publication in Nuclear Fusion. We are making the material immediately accessible in a joint pre-print by the Max-Planck-Institut fuer Plasma Physik at Garching and the Princeton Plasma Physics Laboratory. The review is lengthy but we have structured the material so that a busy reader can skip immediately to the topic of his or her immediate interest and branch from there to other relevant areas. We hope we have illuminated the physics of plasma-material interactions for specialists in other areas of magnetic fusion and that together, we will continue to foster progress toward solutions to the long-term energy needs of mankind.

*Gianfranco Federici - ITER,  
Charles Skinner - PPPL,  
Joachim Roth, - IPP-Garching.*

**ABSTRACT** The major increase in discharge duration and plasma energy in a next-step DT fusion reactor will give rise to important plasma-material effects that will critically influence its operation, safety and performance. Erosion will increase to a scale of several cm from being barely measurable at a micron scale in today's tokamaks. Tritium co-deposited with carbon will strongly affect the operation of machines with carbon plasma-facing components. Controlling plasma wall interactions is critical to achieving high performance in present-day tokamaks and this is likely to continue to be the case in the approach to practical fusion reactors. Recognition of the important consequences of these phenomena has stimulated an internationally co-ordinated effort in the field of plasma-surface interactions supporting the Engineering Design Activities of the International Thermonuclear Experimental Reactor project (ITER) and significant progress has been made in better understanding these issues. This paper reviews the underlying physical processes and the existing experimental database of plasma-material interactions both in tokamaks and laboratory simulation facilities for conditions of direct relevance to next-step fusion reactors. Two main topical groups of interactions are considered: (i) erosion/re-deposition from plasma sputtering and disruptions, including dust and flake generation, (ii) tritium retention and removal. The use of modelling tools to interpret the experimental results and make projections for conditions expected in future devices is explained. Outstanding technical issues and specific recommendations on potential R&D avenues for their resolution are presented.

## Contents

<b>1. INTRODUCTION/BACKGROUND</b>	<b>18</b>
1.1. Introduction . . . . .	18
1.2. Plasma-Edge Parameters and Plasma-Material Interactions . . . . .	19
1.2.1. Plasma interaction with the divertor . . . . .	20
1.2.2. Additional divertor functions . . . . .	21
1.2.3. Plasma interaction with the main-chamber wall . . . . .	22
1.2.4. Physical and chemical sputtering and its consequences . . . . .	23
1.3. History of Plasma-Facing Materials . . . . .	24
1.3.1. Limiter and divertor tokamaks . . . . .	25
1.3.2. Plasma-facing materials . . . . .	26
<b>2. PLASMA-EDGE AND PLASMA-MATERIAL INTERACTION ISSUES IN NEXT-STEP TOKAMAKS</b>	<b>33</b>
2.1. Introduction . . . . .	33
2.2. Progress Towards a Next-Step Fusion Device . . . . .	33
2.2.1. Advances in today's fusion devices and prospects . . . . .	33
2.2.2. Distinctive features of a next-step tokamak . . . . .	36
2.3. Most Prominent Plasma-Material Interaction Issues for a Next-Step Fusion Device . . . . .	37
2.3.1. Power dispersal and density control . . . . .	37
2.3.1.1. <i>Power dispersal and removal</i> . . . . .	37

2.3.1.2.	<i>Density control and helium exhaust</i>	38
2.3.1.3.	<i>Erosion lifetime</i>	39
2.3.1.4.	<i>Plasma contamination and wall conditioning</i>	40
2.3.2.	Effects of disruptions and other plasma disturbances	42
2.3.2.1.	<i>General remarks</i>	42
2.3.2.2.	<i>Effects of disruptions and design considerations</i>	43
2.3.2.3.	<i>Other plasma disturbances, e.g., ELMs</i>	44
2.3.2.4.	<i>Disruption and ELM mitigation</i>	45
2.3.3.	Control of the in-vessel tritium inventory	46
2.3.3.1.	<i>In-vessel tritium inventory in plasma-facing components</i>	46
2.3.3.2.	<i>Tritium removal from co-deposited layers</i>	48
2.3.3.3.	<i>Fuel Isotopic tailoring</i>	49
2.3.3.4.	<i>DT neutron effects and tritium self-sufficiency</i>	49
2.3.4.	Control of the in-vessel dust inventory	51
2.4.	Selection Criteria for Plasma-Facing Materials	53
2.5.	Overview of Design Features of Plasma-Facing Components for Next-Step Tokamaks	55
<b>3.</b>	<b>REVIEW OF PHYSICAL PROCESSES AND UNDERLYING THEORY</b>	<b>72</b>
3.1.	Introduction	72
3.2.	Sputtering Erosion/Re-deposition Processes	72
3.2.1.	Physical sputtering	72
3.2.2.	Non-recycling impurities	74
3.2.3.	Chemical erosion due to hydrogen isotopes	74
3.2.4.	Chemical erosion due to oxygen	77
3.2.5.	Radiation-enhanced sublimation (RES)	78
3.2.6.	Erosion under tokamak conditions	79
3.2.6.1.	<i>Erosion due to charge-exchange neutrals at the main chamber wall</i>	79
3.2.6.2.	<i>Synergy between incident impurity and plasma ions</i>	80
3.2.6.3.	<i>Erosion data of mixed-materials</i>	81
3.2.6.4.	<i>Properties of deposited layers</i>	82
3.3.	Erosion by Arcing	82
3.4.	Erosion during Off-Normal Plasma Events	84
3.4.1.	Physical processes	84
3.4.2.	Erosion of metallic plasma-facing materials	85
3.4.3.	Erosion of carbon-based materials	86
3.5.	Hydrogen Interactions with Plasma-Facing Materials	86
3.5.1.	Implantation	87
3.5.2.	Hydrogen behaviour in metals	88
3.5.2.1.	<i>Hydrogen diffusion in metals</i>	88
3.5.2.2.	<i>Hydrogen trapping in metals</i>	89
3.5.2.3.	<i>Hydrogen precipitation in metals</i>	93

3.5.2.4.	<i>Hydrogen retention in Be and W</i> . . . . .	96
3.5.3.	Hydrogen retention in carbon . . . . .	98
3.5.3.1.	<i>Bulk transport of hydrogen in carbon</i> . . . . .	99
3.5.3.2.	<i>Trapping of hydrogen in carbon</i> . . . . .	99
3.5.3.3.	<i>Thermal release of hydrogen from carbon</i> . . . . .	100
3.5.3.4.	<i>Isotope-exchange of hydrogen in carbon</i> . . . . .	100
3.5.3.5.	<i>Ion-induced release of hydrogen from carbon</i> . . . . .	101
3.5.3.6.	<i>Co-deposition</i> . . . . .	101
<b>4.</b>	<b>EXISTING EXPERIMENTAL DATABASE ON PLASMA-MATERIAL INTERACTIONS IN TOKAMAKS</b>	<b>132</b>
4.1.	Introduction . . . . .	132
4.2.	Measurements of Plasma-Material Interactions . . . . .	132
4.3.	Review of Tokamak Erosion/Re-deposition Experience . . . . .	136
4.3.1.	Divertor erosion/deposition . . . . .	136
4.3.2.	Limiter erosion/deposition . . . . .	141
4.3.3.	Main chamber wall erosion . . . . .	143
4.3.4.	Impurity flow pattern in divertor tokamaks . . . . .	145
4.4.	Experimental Evidence for Arcing in Tokamaks . . . . .	146
4.4.1.	Arcing at limiter surfaces . . . . .	146
4.4.2.	Arcing at divertor surfaces . . . . .	147
4.5.	Disruption Erosion in Simulation Devices and Tokamaks . . . . .	148
4.5.1.	Disruption simulation experiments . . . . .	148
4.5.1.1.	<i>Experiments with lasers and high-energy electron beams</i> . . . . .	148
4.5.1.2.	<i>Experiments with plasma gun devices</i> . . . . .	149
4.5.2.	Off-normal events in tokamaks . . . . .	150
4.5.2.1.	<i>JET Be-target melting experiment</i> . . . . .	150
4.5.2.2.	<i>DIII-D/DIMES observations on disruptions</i> . . . . .	151
4.5.2.3.	<i>Runaway electrons</i> . . . . .	152
4.6.	Control of Plasma-Material Interactions . . . . .	154
4.6.1.	Introduction . . . . .	154
4.6.2.	Wall conditioning . . . . .	155
4.6.3.	Hydrogen isotope recycling . . . . .	158
4.7.	Database on H-isotope Retention and Removal . . . . .	160
4.7.1.	Deuterium retention in tokamaks . . . . .	161
4.7.1.1.	<i>Deuterium retention in TFTR</i> . . . . .	161
4.7.1.2.	<i>Deuterium retention in JET</i> . . . . .	163
4.7.1.3.	<i>Deuterium retention in other tokamaks</i> . . . . .	166
4.7.2.	Tritium retention and removal in large tokamaks . . . . .	170
4.7.2.1.	<i>Tritium resulting from DD operations</i> . . . . .	170
4.7.2.2.	<i>Tritium resulting from DT operations</i> . . . . .	171
4.7.2.2.1	<i>The JET Preliminary Tritium Experiment (PTE) in 1991</i> . . . . .	171

4.7.2.2	<i>The TFTR DT phase 1993-97</i>	172
4.7.2.3	<i>The JET DT Experiment (DTE1) in 1997</i>	174
4.7.3.	H-isotope removal from C-based co-deposited layers	177
4.7.3.1.	<i>Laboratory studies on co-deposit removal via high temperature oxidation</i>	178
4.7.3.2.	<i>Oxidation experiments in TEXTOR</i>	181
4.7.3.3.	<i>Co-deposit removal via plasma discharges</i>	181
4.8.	Dust and Flake Experience	183
4.8.1.	Introduction	183
4.8.2.	Dust found in tokamaks	184
4.8.3.	Flakes in tokamaks	187
<b>5.</b>	<b>APPLICATION OF MODELS AND PREDICTIONS FOR NEXT-STEP TOKAMAKS</b>	<b>246</b>
5.1.	Introduction	246
5.2.	Plasma-Edge Modelling	247
5.2.1.	Simple one-dimensional modelling	247
5.2.2.	Two or three-dimensional fluid modelling	249
5.3.	Sputtering Erosion and Co-deposition Modelling	251
5.3.1.	Modelling approaches and validation	251
5.3.2.	Erosion lifetime and tritium co-deposition inventory analysis for ITER	256
5.4.	Modelling Erosion during Off-Normal Events	258
5.4.1.	Modelling approach and validation	258
5.4.2.	Erosion during a disruption thermal quench	259
5.4.3.	Erosion during ELMs	260
5.4.4.	Effects of longer plasma instabilities and runaway electrons	260
5.5.	Modelling of Particle-Wall Recycling	261
5.5.1.	Modelling approaches	261
5.5.1.1.	<i>Global modelling</i>	261
5.5.1.2.	<i>Refined plasma-edge modelling</i>	263
5.5.1.3.	<i>Refined wall modelling</i>	263
5.5.2.	Status of model validation	264
5.6.	Modelling of Long-Term Implanted Tritium Inventory/Permeation	266
5.6.1.	Modelling approaches	266
5.6.2.	Status of model validation	268
5.6.3.	Implanted tritium inventory analysis for next-step devices	269
<b>6.</b>	<b>CONCLUSIONS AND FUTURE R&amp;D PRIORITIES</b>	<b>285</b>
6.1.	Erosion and Co-deposition Effects	285
6.2.	Tritium Retention and Control of the In-Vessel Tritium Inventory	288
6.3.	Requirements for Modelling and Interpretation of Tokamak Data	289
6.4.	Need for Improved Wall Diagnostics	291
6.5.	Dust Effects	291

6.6. A Next-Step Fusion Reactor without Carbon Plasma-Facing-Components . . .	291
6.7. Concluding Remarks . . . . .	292
7. GLOSSARY OF TERMS AND ACRONYMS	293
8. ACKNOWLEDGEMENTS	306

List of Figures

1	Poloidal cross-section of a tokamak plasma (with a single magnetic null divertor configuration), illustrating the regions of the plasma and the boundary walls where important PMIs and atomic physics processes take place. The characteristic regions are: (i) the plasma core, (ii) the edge region just inside the separatrix, (iii) the scrape-off-layer (SOL) plasma outside the separatrix, and (iv) the divertor plasma region, which is an extension of the SOL plasma along field lines into the divertor chamber. The baffle structure is designed to prevent neutrals from leaving the divertor. In the private flux region below the 'X' point, the magnetic field surfaces are isolated from the rest of the plasma. . . . .	31
2	Showing the dramatic 64 x increase in the fusion triple product $n_e \tau_E T_i$ in TFTR with wall conditioning. . . . .	32
3	Combination of surface heat flux and pulse length required to vaporise the surface of an uncooled "thermally-thick" material. . . . .	64
4	Dependence of the surface heat flux that produces melting of Be, and W and sublimation of C, on the pulse length, for case (a) with dashed lines of an uncooled "thermally-thick" material, and (b) with continuous lines of a typical actively cooled divertor component. . . . .	65
5	Remaining thickness vs. shots for Be, CFC, and W alloy (W3Re used here) at a nominal power of $5 \text{ MW}\cdot\text{m}^{-2}$ (90% re-deposition). The curves for CFC refer to two cases: high-power - $Q_{ion}=2.5 \text{ MW}\cdot\text{m}^{-2}$ and $Q_{rad}=2.5 \text{ MW}\cdot\text{m}^{-2}$ ; and low-power - $Q_{ion}=1.25 \text{ MW}\cdot\text{m}^{-2}$ and $Q_{rad}=0.5 \text{ MW}\cdot\text{m}^{-2}$ . Melt loss varied for metals and two cases were analysed with 10% and 50% melt loss, respectively. See text for assumptions on initial thickness; (reproduced with permission from [154]). . . . .	66



6	Plasma magnetic and thermal energies in tokamaks. Magnetic and thermal data are not necessarily simultaneous. Magnetic energies are estimated from major radius, $R$ , minor radius, $a$ , plasma elongation, $k$ (see glossary), and toroidal field, $B_T$ , and assume a safety factor, $q_{95} \approx 3$ . Energy shown is only internal plasma energy: magnetic energy outside the plasma is not included. Thermal energies are derived from Refs. [165, 167]. Relative auxiliary heating, and hence plasma energy capabilities, vary among experiments. The $(B^2R^3)^{1.2}$ 'scaling' fit is empirical and has been drawn by eye. Data are for the 1998 ITER design (labelled as ITER-FDR) and the most recent ITER-FEAT design parameters. The increase in $W_{mag}/R^2$ and $W_{th}/R^2$ from COMPASS-D to the 1998 ITER design is about 70. This applies for the scaling of radiation of thermal energy to the first-wall. For divertor thermal energy deposition, if one assumes a fixed SOL width, then the increase in energy loading per unit area from JT-60U and JET to the 1998 ITER design scales as $W_{th}/R$ and increases by about 40; (figure provided by J. Wesley of General Atomics). . . . .	67
7	High-heat-flux test results: Heat flux vs. number of cycles for prototypical W/Cu and Be/Cu high-heat-flux components; (figure provided by M. Ulrickson Sandia National Laboratory [256].) . . . . .	68
8	Castellated armour concepts for tungsten-armoured high heat flux components; (figure provided by Vladimir Barabash, ITER JCT.) . . . . .	69
9	(a) Cross-sectional view and (b) isometric view of the vessel of the 1998 ITER design showing blanket and divertor. . . . .	70
10	Poloidal cross-section through the divertor of the ITER-FEAT design. Area (1) at the divertor strike-zones receives high thermal power and flux of particles, deposition of energy during ELMs, high thermal (direct plasma impact) and electromagnetic loads during disruptions. Area (2), which consists of the baffle, the dome, and the liner in the private flux region, receives low heat flux and high charge-exchange neutral fluxes. Some parts are subject to direct interaction with the SOL plasma, radiative power from X-point, and possible deposition of re-radiated energy during disruptions and mechanical loads due to eddy and halo currents (see glossary). . . . .	71
11	Comparison of measured values for the sputtering yield at normalised incidence for Be (closed squares), C (open squares), and W (closed triangles) by deuterium ions with results from analytic modelling of physical sputtering [267] (dotted lines). The experimental data were obtained from the weight loss of polished samples after ion bombardment. The divergence between experimental points and modelling for carbon at low energies is due to chemical effects not included in the model. . . . .	105
12	Sputtering yields of carbon materials by typical impurity ions: Measured values for $O^+$ [280] and $C^+$ [281] and TRIM-SP computer simulations for $Be^+$ and $W^+$ [279]. . . . .	106

Review: Plasma-material interactions

13	Fluence dependence of the weight loss of a W sample bombarded by 6 keV $C^+$ at different angles of incidence. The dashed lines are the predictions of a Monte-Carlo code, TRIDYN; (reproduced with permission from [283].) . . . . .	107
14	Temperature dependence of the erosion yield of pyrolytic graphite by deuterium ions at different ion energies as measured by weight loss [289]. . . . .	108
15	Energy dependence of the erosion yield of carbon by deuterium ions at room temperature (open symbols) and at the maximum temperature for chemical erosion, $T_{max}$ , (solid symbols) (see Fig. 14). Squares are weight loss data collected in [289], circles are total erosion data from mass spectroscopy [288]. Solid curves are from an analytic model [285]. Physical sputtering is also shown (dotted line.) . . . . .	109
16	Flux dependence of the chemical erosion yield of carbon with deuterium ions near (a) room temperature and (b) $T_{max}$ . The data combine weight loss and spectroscopic measurements from ion-beam experiments [288, 289, 302, 303], spectroscopic measurements from plasma simulators [295, 296, 304, 305] and from the ASDEX-Upgrade divertor [298]. The curves are fits to the data using the models described in [285, 293]. . . . .	110
17	Temperature dependence of the sputtering yield of pyrolytic graphite by $H^+$ , $D^+$ , $He^+$ , and $Ar^+$ in the temperature range of RES. Solid curves are from the model described in Ref. [330]; (reproduced with permission from [330].) . . . . .	111
18	Energy distribution of the charge-exchange neutral flux to the inner heat-shield and the divertor baffle of ASDEX-Upgrade as calculated using the B2/EIRENE code [156]. . . . .	112
19	Dependence of the effective sputtering yield of Be, C, and W by deuterium charge-exchange neutrals on the average energy of the neutrals [156]. . . . .	113
20	(a) Fluence dependence of the deposited depth for W bombarded with deuterium ions from a 20 eV divertor plasma with various levels of carbon impurities; (reproduced with permission from [335]). (b) Boundaries of erosion and deposition conditions for W bombarded with deuterium ions depending on plasma electron temperature, $T_e$ , and carbon impurity content, $f_c^*$ . The four possible time developments (A-D) are schematically indicated in the figure in their region of validity; (reproduced with permission from [335].) . . . . .	114
21	(a) Fluence dependence of the deposited amount of atoms during the bombardment of Be with 5 keV $C^+$ or 13 keV $CO^+$ [338]; (b) Fluence dependence of the weight loss during the bombardment of W with 3 keV $C^+$ or 3 keV $CH_3^+$ [339] at 300 K; and (c) same as (b) but at 770 K. . . . .	115
22	Schematic of typical arc history at the plasma-facing wall of a tokamak. . . . .	116
23	Schematic illustration of different interaction zones during a plasma disruption; (reproduced with permission from [357].) . . . . .	117
24	Time evolution of tungsten surface temperature, melt layer, and eroded thickness following a plasma disruption [363]. . . . .	118

25 Schematic diagram showing main transport mechanisms for hydrogen migration and release at a surface of a metal subject to implantation of energetic particles. The concentration profile is also shown for two cases: (1) with a high near-surface concentration resulting from a sluggish re-emission from the surface, and (2) with a lower near-surface concentration resulting from an enhanced re-emission of implanted flux to the plasma. This, in turn, means a reduced driving potential for diffusion into the bulk; (figure provided by G. Longhurst, INEEL, Idaho Falls.) . . . . . 119

26 Potential energy diagram for hydrogen in tungsten. Enthalpy of solution  $Q_s=1.04$  eV [403], activation energy for diffusion  $E_m=0.39$  eV [403], binding enthalpy of hydrogen to a vacancy  $Q_t=1.1$  eV [400, 401], enthalpy of adsorption  $Q_a=0.7$  eV [404, 405]. The activation energy for detrapping is  $Q_t+E_m$ . . . . . 120

27 The binding energy of a hydrogen or helium atom in a homogeneous electron gas as a function of average electron density in units of electrons/ $a_o^3$ , where  $a_o$  is the Bohr radius. . . . . 121

28 Measured solubility of hydrogen in tungsten (dashed line [403]) and beryllium (solid lines 1 [413], 2 [430] and 3 [431].) . . . . . 122

29 Measured diffusivity of hydrogen in tungsten (dashed line [403]) and beryllium (solid lines 1a&b [432], 2 [430] and 3 [433].) . . . . . 123

30 Retention of 1 keV deuterium implanted into Be and W, at 300 K versus incident fluence, measured by thermal desorption; (reproduced with permission from [434].) . . . . . 124

31 Retention of deuterium and tritium in Be as a function of incident particle fluence [427]. For purposes of comparing results from different experiments using different ion energies, the data have been scaled to correspond to an equivalent 100-eV deuterium ion energy. Numerical values next to the symbols and in the legend are specimen exposure temperatures, in degrees Celsius; (reproduced with permission from [427].) . . . . . 125

32 Illustration of hydrogen retention and transport in graphite; (reproduced with permission from [207].) . . . . . 126

33 Depth profiles measured by secondary ion mass spectroscopy (SIMS) of deuterium implanted at 530 and 1500 eV into carbon at room temperature at fluences of  $10^{22}$  D·m<sup>-2</sup> (solid lines) and  $10^{20}$  D·m<sup>-2</sup> (dotted curves). For comparison, the low dose curves are scaled up by a factor of 100; (reproduced with permission from [443].) . . . . . 127

34 Areal density of implanted deuterium retained in carbon versus incident fluence for different energies, measured by NRA (symbols) and calculated (curves) using implantation profiles and a saturation concentration of D/C=0.44; (reproduced with permission from [443].) . . . . . 128

35 Retention of deuterium implanted in various types of graphite versus incident fluence; (reproduced with permission from [445].) . . . . . 129

36 Relative D retention in carbon versus temperature measured by NRA [440]. Squares show D retained after implantation at room temperature to doses of  $10^{20}$  D·m<sup>-2</sup> (open) and  $10^{22}$  D·m<sup>-2</sup>·s<sup>-1</sup> (filled) followed by five minute anneals at each temperature. The dots show relative retention of D implanted to saturation at the indicated temperature. The open circles show release of implanted tritium during isochronal annealing reported by Sawicki et. al. [459]; (reproduced with permission from [440].) . . . . . 130

37 Comparison of hydrogen isotope retention in beryllium films produced by collecting sputtered Be from plasma and ion-beam exposed Be targets. Data correspond to experiments with the TPE simulator (Causey [469]), and experiments with an ion-beam (Mayer [470]); (reproduced with permission from [427].) . . . . . 131

38 (a) Schematic of sniffer probe used on TEXTOR. (b) Measured chemical erosion yield in TEXTOR for deuterium and hydrogen vs. sample temperature; (reproduced with permission from [480].) . . . . . 200

39 Net carbon erosion rate at the divertor strike-point vs. strike-point heat flux on JET and DIII-D. JET data [110] and DiMES at 1.5 MW·m<sup>-2</sup> [521] were obtained with colorimetry. All other DiMES data come from depth-marked insertable probes [480, 530]. The DIII-D long-term results are from net changes in divertor tile height after 9 months of operation [491]. (OSP in the figure means outer-strike-point.); (reproduced with permission from [530].) 201

40 Erosion rate of different divertor materials as a function of atomic mass. While most of the data were obtained from marker erosion experiments, Be, C and W have been used as bulk materials in widely differing divertor conditions [109, 112, 493, 494, 533–535]. . . . . 202

41 Sputtering yield of C and W as divertor materials in ASDEX-Upgrade, as a function of the divertor electron temperature as measured spectroscopically. The data are compared with computer calculations (shown as dashed lines) for physical sputtering. For the case of W, sputtering due to 1% C<sup>4+</sup> impurity ions is included. The grey region indicates variations of the sputtering yield due to different degrees of surface coating by carbon deposition [114, 477]; (figure provided by K. Krieger - IPP Garching.) . . . . . 203

42 Comparison of the flux dependence of the chemical erosion yield of carbon at  $T_{max}$  measured in plasma simulators and in tokamaks for (a) incident ion energy between 20-50 eV [295, 296, 299, 304, 541, 542] and (b) between 200-300 eV [297, 305, 480, 539, 540, 543]. The curves are analytic fits to the data using the analytic model [285] (see also Fig. 16). . . . . 204

43 Deposition pattern of local re-deposition of eroded material from Be and W markers in the DIII-D divertor [494]. Two sets of data are shown for each material at slightly different positions on the same divertor probe. The magnetic field direction is from left to right. (Plasma parameters:  $n_e = 4 \cdot 10^{19}$  m<sup>-3</sup>,  $T_e = 70$  eV, power =  $7 \cdot 10^5$  W·m<sup>-2</sup>, ion fluence  $8 \cdot 10^{22}$  m<sup>-2</sup>). . . . . 205

44 Radial distribution of erosion of a deposited carbon layer and re-deposition onto the JET divertor plate as measured from colorimetry measurements (solid points) and DIVIMP calculations of net and gross erosion (solid and dashed lines respectively); (reproduced with permission from [110].) . . . . . 206

45 Re-deposition pattern of carbon onto the divertor plates of DIII-D, JET Mk-I, ASDEX-Upgrade Div. I and Div. II LYRA, as documented by the D co-deposition pattern [63]. The inserts show the different divertor geometries. . . 207

46 Erosion and re-deposition pattern (over a campaign of many discharges) across the carbon JET rail limiter; (reproduced with permission from [559].) . 208

47 Distribution of the sputtered atom flux from the ASDEX-Upgrade vessel wall for a carbon and tungsten wall material due to charge-exchange neutral sputtering as calculated from B2/EIRENE code calculations [156]. The carbon values can be compared to spectroscopically measured fluxes from the inner heat shield shown as solid squares [334]. The conditions in the divertor during erosion are: experiment:  $\langle n_e \rangle = 3 \cdot 10^{19} \cdot \text{m}^{-3}$ , calculations:  $n_e^{sep} = 5.2 \cdot 10^{19} \cdot \text{m}^{-3}$ . . 209

48 (a) Schematic erosion/re-deposition pattern of carbon wall material in the ASDEX-Upgrade divertor tokamak. For a total charge-exchange neutral flux of  $8 \times 10^{22}$  D/s, the calculated C-impurity flux is of  $8 \times 10^{19}$  C/s at the inner divertor and  $2 \times 10^{19}$  C/s at the outer divertor. (b) Schematic of the erosion/re-deposition pattern of divertor material in a divertor tokamak as obtained from the ASDEX-Upgrade W divertor experiment; (reproduced with permission from [585].) . . . . . 210

49 Surface profile showing arc traces on a polished graphite tile from the outer divertor of ASDEX-Upgrade exposed to 57 neutral beam heated 1.5 s discharges. Direction of scan is parallel to the magnetic field and therefore perpendicular to the direction of the arc traces; (reproduced with permission from [355].) . . . . . 211

50 Example of arc traces on a  $0.1 \mu\text{m}$  W film on a graphite substrate exposed to a divertor plasma in DIII-D. . . . . 212

51 JET Mk-I Beryllium target plate tiles after plasma operation. A poloidal set of pairs of Be target tiles at the outer strike region are shown at the end of the Be phase. Shown are tiles in row 10 just outboard of the divertor centre line (left of the figure), to tiles in row 13 in the outer SOL (right of figure). The deliberate melting is seen on the tiles in row 12. A small amount of melting is also seen on the tiles in rows 10 and 11, resulting from giant ELMs prior to the melting experiment. Each tile is  $\approx 75 \times 40$  mm in size; (reproduced with permission from JET [631].) . . . . . 213

52 Frascati Tokamak limiter of a tungsten-coated TZM mushroom type (60 mm in diameter) after plasma transient events. (Figure provided by G. Maddaluno - ENEA, Frascati.) . . . . . 214

53 Volume average density evolution for very long discharges in Tore Supra; (reproduced with permission from [652].) . . . . . 215

Review: Plasma-material interactions

54	Removal of H <sub>2</sub> by ICRH plasmas from the first-wall of TEXTOR. 1 Pa·m <sup>3</sup> = 2.7x10 <sup>20</sup> molecules; (reproduced with permission from [41].) . . . . .	216
55	Operational density limits for TEXTOR for ohmic (OH) and beam heated plasmas for different surface conditions. Data for metallic walls are for hydrogen operation; all others are for deuterium. Data for carbonised walls include carbonised steel limiters and liners (squares and crosses) or graphite limiters and carbonised liner (other labels); (reproduced with permission from [671]). Triangles are data points measured recently with siliconised wall conditions [670]. . . . .	217
56	Deuterium (x) and carbon (o) influx in helium discharge cleaning pulses following a 1 MA ohmic disruption in TFTR; (reproduced with permission from [108].) . . . . .	218
57	The areal density of metal atoms on one sector of the TFTR limiter measured by beta back-scattering. The highest metal atom deposition (lightest region in the figure) is $\approx 10^{22}$ atoms·m <sup>-2</sup> ; (reproduced with permission from [488].) . . . . .	219
58	Retained deuterium on tiles from the TFTR bumper limiter. . . . .	220
59	Fraction of D fuelling retained in various regions of TFTR averaged over period from 1985 to 1991. . . . .	221
60	Fraction of deuterium retained in TFTR versus average neutral beam power. . . . .	222
61	Geometry of (a) Mk-I, (b) Mk-IIA, and (c) Mk-II Gas-Box JET divertors; (reproduced with permission from JET.) . . . . .	223
62	Retained deuterium and net erosion on tiles from the DIII-D divertor; (reproduced with permission from [721].) . . . . .	224
63	(a) Poloidal cross-section of the JT-60U divertor; (reproduced with permission from [724].) (b) Retained deuterium on divertor tiles in JT-60U; (figure provided by K. Masaki - JAERI.) . . . . .	225
64	The tritium depth profile for the near-surface region of the JET mid-plane inner wall graphite tile; (reproduced with permission from [735].) . . . . .	226
65	The number of tritium gas atoms released from the JET vacuum vessel as a function of pulse number for the PTE campaign and subsequent clean-up. The data are integrated for the first 560 s (open triangles) or 1160 s (closed triangles), and the solid curve is the prediction of a model; (reproduced with permission from [739].) . . . . .	227
66	The decay, in between periods of tritium injection, of the central (r/a < 0.2) T/D density ratio, as derived from the DT/DD neutron ratio. The long-term decay (starting at discharge #73950) followed a time constant of 404 discharges. The short-term decay is shown in the inset: (●) is the T $\alpha$ /(H $\alpha$ +D $\alpha$ +T $\alpha$ ) ratio showing the T influx from the limiter and (x) the central T/D density over 9 deuterium discharges following a sequence of tritium NBI discharges; (reproduced with permission from [745].) . . . . .	228

67	High retention during tritium gas puffing into TFTR during September-November 1995. The fractional retention is defined as the ratio of the cumulative tritium injected less the cumulative exhaust, divided by the cumulative tritium injected; (reproduced with permission from [528].) . . . . .	229
68	Tritium fraction measured in JET throughout the DTE by different diagnostics, compared to expectation based on the PTE; (reproduced with permission from [204].) . . . . .	230
69	The tritium inventory in the JET vessel (measured as the difference between the tritium fuelling and the amount recovered from the vessel) plotted against pulse number for the 1997 DTE1 campaign. Also plotted are predictions of the inventory based on the behaviour during the PTE campaign of 1991, made by (i) merely scaling up the amount of T fuelling, (ii) adding an extra retention equal to 10% of the fuelling, and (iii) adding an extra retention equal to 20% of the fuelling; (reproduced with permission from [719].) . . . . .	231
70	Tritium inventory in the torus versus cumulative tritium input during the JET DTE1 campaign; (reproduced with permission from [203].) . . . . .	232
71	Rate of tritium release during air exposure of the torus at ambient temperature following the JET DTE1 campaign; (reproduced with permission from [203].) . . . . .	233
72	Distribution of tritium in the JET vessel in the shutdown following DTE1. The amounts at each location are integrated around the torus; (reproduced with permission from [758].). The photograph in the inset shows a typical region of the flaking deposition on the louvres at the inner corner of the JET Mk-IIA divertor; (reproduced with permission from JET.) . . . . .	234
73	Depth profile changes in carbon, deuterium, oxygen, and hydrogen in a-C:D films due to air exposure at 650 K: (a) before annealing, (b) after annealing for 2 h, (c) after annealing for 4 h, and (d) after annealing for 8 h. The original film thickness was 730 nm. For each temperature step a fresh sample was used; (reproduced with permission from [468].) . . . . .	235
74	Partial pressure of reaction products formed during $^{18}\text{O}_2$ exposure of an a-C:D film at 470 K; (reproduced with permission from [210].) . . . . .	236
75	D content of TFTR co-deposit as a function of gas ( $\text{O}_2$ , $\text{H}_2\text{O}$ , air) exposure time at (a) 523 K and (b) 623 K; (reproduced with permission from [209].) . . . . .	237
76	Tokamak and plasma gun particulate data used to specify values used in ITER safety analysis; (figure provided by K. McCarthy and D. Petti - INEEL, Idaho Falls.) . . . . .	238
77	BET specific surface area of tokamak dust compared to theoretical carbon and molybdenum spheres; (figure provided by K. McCarthy and D. Petti - INEEL, Idaho Falls.) . . . . .	239
78	SEM photographs of particulates generated from the SIRENS plasma gun; (figure provided by K. McCarthy and D. Petti - INEEL, Idaho Falls.) . . . . .	240



Review: Plasma-material interactions

79	Photograph of the heavy deposition at the side of a TEXTOR limiter. The scale is in mm (visible are 23 mm) and refers to the detail of the flaking region shown on the upper right part of the figure; (reproduced with permission from TEXTOR.) . . . . .	241
80	An SEM image of a piece of film that has flaked from the side of a TEXTOR limiter. (EPMA = Electron Probe Microanalysis;) (reproduced with permission from [800].) . . . . .	242
81	Blistering and flake detachment on TFTR graphite tiles at Bay H on February 25th 2000. The vertical height of a tile is 81 mm; (reproduced with permission from TFTR.) . . . . .	243
82	Polished cross-section of a flake from the JET Mk-IIA divertor, showing the layer structure. The scale marker on the figure is 20 $\mu\text{m}$ , which makes the film thickness $\approx 100 \mu\text{m}$ ; (reproduced with permission from JET.) . . . . .	244
83	Location of flakes and films of carbon in ASDEX-Upgrade. The flakes were found below the divertor, whereas carbon films were found on the divertor structure. They are located at surfaces perpendicular to the magnetic field. The direction on the inner and outer divertor are reversed; (figure provided by V. Rohde - ASDEX-Upgrade, Garching.) . . . . .	245
84	Comparison between SOL conditions as measured on Alcator C-Mod (discrete points) with results from the Two-Point Model with extensions (lines). In the figure 'u' refers to upstream parameters and 't' refers to parameters at the target plate; (reproduced with permission from [802].) . . . . .	274
85	Results from a B2/EIRENE simulation of the ITER edge plasma [829]. $r-r_{sep}$ is the distance from the last closed flux surface (outside mid-plane equivalent); (figure provided by A. Kukushkin, ITER.) . . . . .	275
86	Flow in the JET SOL measured for different types of plasma. Using a Mach Probe on the Reciprocating Probe inserted near the top of the torus; (reproduced with permission from [841].) . . . . .	276
87	(a) Plasma parameters/fluxes along the ITER divertor outer vertical for so-called 'partially-detached' plasma conditions (see text); (b) ITER divertor outer vertical target. (Part (a) of the figure reproduced with permission from [153].) . . . . .	277
88	Number of ELMs $N$ to erode 1 cm of W (solid symbols) or 2 cm of C (hollow symbols) vs. Elm energy per unit area $E$ , for ELM duration of 0.1 (diamonds) and 1 ms (squares). Melt limit for W is also shown. Disruption evaporation and melt loss numbers with vapour shield (see references in [154]) are shown for comparison. Product $N \cdot E = 2 \cdot 10^6 \text{ MJ} \cdot \text{m}^{-2}$ (expected ELM energy deposited in 2000 shots, see text) is also indicated. . . . .	278
89	Interface copper surface temperature rise during a VDE for different surface coating materials. . . . .	279

90	Experiments (solid line) and simulation results (closed circles) for the density behaviour during limiter transition and divertor phases in JT-60; (reproduced with permission from [879].) . . . . .	280
91	Density behaviour of deuterium during a typical limiter to divertor transition in the 1998 ITER design for various values of the fuelling rate; (figure provided by M. Sugihara, ITER.) . . . . .	281
92	(a) Time evolution of the total puffed particles calculated to match the time behaviour of measured density for a long-pulse Tore Supra discharge (shot 9016). Experimental results are represented with a solid line with open circles, whereas the results of the simulation are represented with a dotted line for a case with and a case without enhanced diffusion. The initial wall concentration was adjusted to match the total puffed particles at t=60 s with the experimental value (solid line with open circles). (b) Time behaviour of gas puff rate calculated with enhanced diffusion (dotted line) and the experimental value (solid line with open circles); (reproduced with permission from [706].) . . . . .	282
93	Comparison of measured deuterium retention in beryllium with that calculated by the saturation model and the classical model in the TMAP4 code for experiments in TPE [919]; (figure provided by G. Longhurst, INEEL, Idaho Falls.) . . . . .	283
94	Comparison of the rate of tritium accumulation in the beryllium first-wall (with and without n-effects) and divertor co-deposition for two indicative tritium co-deposition rates of 1 and 10 g/1000 s. . . . .	284

**List of Tables**

1	Major toroidal confinement devices, giving their location, approximate years of operation, limiter material, divertor plate material (if applicable), plasma-facing wall material and gettering technique. . . . .	29
2	Distinctive features of a next-step device and related PMI issues. . . . .	58
3	Comparison of parameters* of contemporary divertor tokamak research facilities and ITER. . . . .	59
4	Type, range of parameters and major consequences of plasma transient events in the ITER design. The numbers refer to the 1998 ITER design and where available (in parenthesis) to the ITER-FEAT design. . . . .	60
5	Tritium in current facilities and future devices. . . . .	61
6	Identified advantages and shortcomings of candidate armour materials that are considered for the design of the ITER reactor. . . . .	62
7	Estimated operation parameters used for the design of the ITER PFCs, as documented in the 1998 ITER design [117]. Where available, parameters of the reduced-size ITER-FEAT design [118, 133] are also included in parenthesis. Design specifications for off-normal events are summarised in Table 4. . . . .	63

## Review: Plasma-material interactions

8	Values of binding enthalpy (eV) of H to vacancies relative to a solution site ( $Q_t$ shown in Fig. 26) at low occupancy in several metals obtained both from experiments and from first principles calculations. . . . .	103
9	Binding enthalpies (eV) of hydrogen to helium bubbles in metals. . . . .	104
10	Summary of tokamak PMI diagnostics (Symbols: t: time resolution or cw (continuous operation). Scale: * signifies spatial resolution, otherwise depth resolution). . . . .	190
11	The mean energy and flux of charge-exchange neutrals at the outer midplane of TFTR during ohmically heated (OH) and neutral beam heated portions of the discharge, with the wall saturated with deuterium and unsaturated by "supershot" conditioning [483]. . . . .	191
12	Some examples of disruption simulators that were primarily used in the experiments. . . . .	192
13	Deuterium retention and fuelling in TFTR. . . . .	193
14	Summary of tritium removal techniques used in TFTR and JET. . . . .	194
15	Comparison of retention in TFTR and JET. . . . .	196
16	Thermo-oxidative and plasma discharge techniques for a-C:T co-deposit removal†. . . . .	197
17	C-erosion and D-removal rates for tokamak co-deposits during oxygen exposure. . . . .	198
18	C-erosion and D-removal rates for tokamak co-deposits during air and H <sub>2</sub> O exposure. . . . .	199
19	Summary of selected results of divertor erosion and tritium co-deposition analysis of various evolving ITER divertor designs. From analysis of J.N. Brooks et al. (Reference in the table: (1) [846], (2) [552], (3) [153], (4) [157].) . . . . .	270
20	Vaporisation and melting thickness ( $\mu\text{m}$ ) per disruption event [861]. . . . .	271
21	Vaporisation and melting thickness ( $\mu\text{m}$ ) per VDE (without any vapour shielding effect) [861]. . . . .	272
22	Summary of tritium inventory and permeation calculated by the TMAP4 code [901] through the PFCs of the 1998 ITER design for the Basic Performance Phase. This does not include tritium inventory due to co-deposition; (Table reproduced from [3].) . . . . .	273

## 1. INTRODUCTION/BACKGROUND

### 1.1. Introduction

Fusion power is a promising long-term candidate to supply the energy needs of mankind [1]. Substantial fusion power has been produced in two large magnetic confinement devices: TFTR (10.7 MW) and JET (16 MW). An International Thermonuclear Experimental Reactor (ITER) to generate 1500 MW has been successfully designed, but the high cost of construction has led to work on a reduced scale option (see glossary). In magnetic confinement devices the edge plasma (see glossary) and surrounding material surfaces provide a buffer zone between the 'astrophysical,' high temperature conditions in the plasma core and the normal 'terrestrial' environment. The interaction between the edge plasma and surrounding surfaces profoundly influences conditions in the core plasma (see glossary) and is a key engineering issue. Robust solutions of issues of plasma-material interactions (PMIs) are required for the realisation of a commercially attractive fusion reactor. The edge plasma needs to provide good thermal insulation, and prevent impurity influx from poisoning the burning core plasma (see glossary). The wall needs to withstand the intense heat load and particle flux from the core plasma, over months or years of operation, with little or no maintenance. The wall surface plays an important role in the recycling of hydrogen isotopes, and in plasma fuelling. The approach to practical fusion reactors inevitably leads to an increase in plasma energy content, pulse duration, and cumulative run time. Plasma-physics effects and PMIs that are only partially observed or accessible in present-day experiments will become important. Higher heat loads, more intense transient heating events (i.e., Edge Localised Modes (ELMs) and disruptions (see glossary)), and the predicted magnitude of plasma-facing component (PFC) damage by melting and evaporation are critical issues [2] (Sect. 2.3.2). The orders of magnitude increase of the duty-cycle (see glossary) in a next-step device will lead to centimetre scale erosion of PFCs. This represents a 3-4 orders of magnitude increase from present tokamaks, a change that is much larger than the change in any of the core physics parameters needed for ignition (see glossary). Erosion of carbon in deuterium-tritium fuelled tokamaks will lead to co-deposition with tritium, and tritium retention will constrain operations [3, 4] (Sect. 2.3.3). Dust generated by erosion must be controlled (Sect. 2.3.4).

Our knowledge of PMI processes has greatly expanded during the past two decades. Significant advances have been made in uncovering the physical principles that govern the behaviour of plasma-facing materials (Sect. 3). The release of wall material into the plasma is now better understood. Advances in wall conditioning techniques has led to impressive gains in performance in many tokamaks (Sects 1.3 and 4.6). Probes installed in large tokamaks specifically for materials studies have provided time resolved erosion measurements to benchmark models (Sect. 4.2). The low sputtering yield (see glossary) of tungsten and molybdenum PFCs has been exploited to produce clean core plasmas (Sect. 4.3). These and other advances have greatly improved the knowledge base of PMI in next-step machines (Sect. 5).

The present review surveys PMIs in magnetic fusion devices, in particular, the tokamak,

since this is the most common approach and the most advanced candidate for a reactor. We critically discuss the implications of PMIs in contemporary facilities for the design, and the selection of materials for the first-wall and divertor chamber components in a next-step long-pulse device. Often, the design features and parameters of ITER are used in this paper to exemplify issues that are generic to a reactor-scale next-step experimental facility. Extensive cross referencing between related topics is incorporated to facilitate finding particular topics in the review. A glossary of acronyms and technical terms is provided at the end of this review to help make the material more accessible to those new to this field.

Detailed information on PMIs is reported in a biannual conference series [5] and in specialised journal issues [6]. Early work has been surveyed in Refs. [7, 8]. The physics of divertors in tokamaks has also been reviewed [9] and a book on the plasma boundary of magnetic fusion devices has been recently published [10]. A separate review is planned that will concentrate on the materials properties of plasma-facing materials [11]. Novel high power density wall concepts including liquid walls, are presented in Ref. [12]; these may offer the potential for attractive fusion energy systems if a number of challenging engineering science issues can be solved. A comprehensive review of the technical basis for the design of the ITER is available, which focusses on the plasma physics database provided by the present generation of tokamaks and on the methodologies used to predict ITER's performance [13].

## 1.2. Plasma-Edge Parameters and Plasma-Material Interactions

The edge plasma and wall are a strongly coupled system whose interactions range over an extraordinary breadth of scale, from eV scale atomic interactions to hundred megajoule disruptions. This 27 order of magnitude range in energy rivals the ratio between the size of a grain of dust and the  $3 \times 10^{21}$  m scale of the known universe! Not surprisingly, the subject spans several technical disciplines (materials physics, chemistry, atomic & molecular physics, and plasma physics, from cold, mostly neutral plasmas, to multi-keV temperature plasmas).

This section introduces the configuration of the PFCs of modern tokamaks and their interaction with the plasma.

PMIs critically affect tokamak operation in many ways. Erosion by the plasma determines the lifetime of PFCs, and creates a source of impurities (see glossary), which cool and dilute the plasma. Deposition of material onto PFCs alters their surface composition and can lead to long term accumulation of large in-vessel tritium inventories. Retention and recycling of hydrogen from PFCs affects fuelling efficiency, plasma density control and the density of neutral hydrogen in the plasma boundary, which impacts particle and energy transport.

The primary driver for the interactions between the core plasma, edge plasma and wall is the power deposited or generated in the plasma core. The fraction of this power, which is not radiated from the plasma core as bremsstrahlung (see glossary) or line radiation, is transported across field lines to the edge plasma. The edge plasma has a strong influence on the core plasma transport processes and thereby on the energy confinement time (see glossary) [8] and plays an essential role in the transition from the low (L) to the enhanced (H) plasma confinement regime [14]. A schematic representation of the regions of the plasma and boundary walls in a divertor tokamak is portrayed in Fig. 1.

*Insert Fig. 1*

The outermost closed magnetic field surface forms an “X-point” of zero poloidal magnetic field within the vessel. This boundary is called the “last closed flux surface” (LCFS) or “separatrix” (see glossary). Magnetic field surfaces inside the LCFS are closed, confining the plasma ions. The edge region, just inside the LCFS, contains significant levels of impurities not fully ionised, and perhaps neutral particles. Impurity line radiation and neutral particles transport some power from here to the wall. The remaining power,  $P_{SOL}$  enters the region outside the LCFS either by conduction or by convection. This region is known as the scrape-off layer or “SOL” (see glossary) as here the power is rapidly “scraped off” by electron heat conduction along open field lines, which are diverted to intersect with material targets, in what is known as a “divertor” (see glossary); see inset in Fig. 1).

Cross-field transport of power continues in the SOL, either through conduction and/or convection, and the relative rates of the cross-field versus parallel transport along magnetic field lines determine the power width of the SOL,  $\lambda_p$ . Since parallel transport is very rapid compared to cross-field transport rates, the SOL is very thin in the radial direction. The power e-folding width  $\lambda_p$  (the distance required to decrease by a factor  $1/e$ ), typically ranges between 3 mm and 10 mm at the outside mid-plane in present devices, and is expected to be 10 mm to 30 mm wide in a device such as ITER [13]. Typically, density and temperature SOL e-folding widths are factors of 2 to 5 larger than power widths [9].

The interaction of the edge plasma with the PFCs is determined by plasma density, temperature, flows, power fluxes, and neutral fluxes, and is most intense in the vicinity of the ‘strike-point’ where the separatrix intersects the divertor target plate (see inset in Fig. 1). The plasma density and temperature determine the flux density and energy of plasma ions striking plasma-wetted surfaces. These, in turn, determine the rate of physical sputtering, chemical sputtering, ion implantation, and impurity generation (Sect. 1.2.4). In addition, the plasma conditions determine where eroded material is re-deposited, and to what degree co-deposition of tritium occurs (Sects. 4.3, 4.7 and 5.3). The power flow determines the level of active structural cooling required. Neutral fluxes also cause erosion and co-deposition, even on areas not contacted by the plasma.

### 1.2.1. Plasma interaction with the divertor

We define the divertor to be the volume below the X-point, which also usually means below the divertor baffle structure (see glossary), Fig. 1). We assume that plasma ions strike the divertor plate, are recycled back into the plasma either as atoms or molecules, and are ionised/dissociated primarily in the divertor, i.e., not directly penetrating the confined plasma or the SOL outside of the divertor. Neutrals are prevented from leaving the divertor either by the opacity of the divertor plasma itself (through ionisation) or are simply blocked by the mechanical baffle structure. Such a divertor condition we call an ‘opaque divertor’ [9]. In the ‘detached regime’ (see glossary), the plasma temperature (density) in the divertor is significantly lower (higher) than in the SOL outside of the divertor, for example, at the outside mid-plane. Plasma-detached regimes are present at moderate or high levels of

collisionality in the SOL, i.e., sufficiently high that parallel field temperature gradients can be sustained between the main SOL, where power enters by cross-field transport from the confined plasma, and the sink of power, in or near the divertor. Detached conditions are usually found at moderate to high levels of the ratio of plasma density/input power in present machines [9], see Sect. 5.2.1. With typical plasma temperatures of  $\approx 100$  eV at the mid-plane and of  $\approx 3$  eV in a detached divertor, the corresponding ion energies will be about 500 eV and 15 eV, respectively. The difference in erosion rate between these two energies can be enormous, since 15 eV is below the physical sputtering threshold for most materials (Sect. 3.2.1).

One can see from Fig. 1 that the SOL width varies around the poloidal circumference, being smallest at the outside mid-plane and expanding near the divertor, particularly near the X-point. Typical expansion factors are  $\approx 4$  between the divertor plate and the mid-plane, reflecting the decrease in poloidal field in the divertor compared with the mid-plane location. This expansion has a very beneficial effect in that it effectively reduces the power flux on the divertor plates, while increasing the plasma volume available for volumetric loss mechanisms such as impurity/hydrogenic radiation and volume recombination [9, 15]. Radiative processes (e.g., due to intrinsic or intentionally added impurities in the divertor region) can produce a further reduction in power flux. Most present divertor machines have reduced the power flowing to the divertor plate by factors of  $>5$  using radiative processes [9] (Sect. 2.3.1). Thus, through flux expansion and radiative processes, the divertor can deliver a factor  $> 20$  reduction in incident power density over what would be experienced by a (hypothetical) toroidal belt limiter normal to the SOL in the main chamber [16].

The materials of the PFCs are optimised for the plasma conditions in the specific regions. For example, near the baffle region of the divertor (Fig. 1) lies the interface between the hot SOL plasma outside of the divertor ( $> 100$  eV) and the high neutral density in the divertor. This region is expected to generate significant fluxes of energetic charge-exchange atoms (see glossary), which bombard the neighbouring structures. These particles have energies  $> 100$  eV, and up to perhaps several keV, and cause physical sputtering of PFCs in the baffle region. For this reason, the present ITER design calls for a high-Z material, tungsten, in this region, which has a low yield for physical sputtering [17]. The selection of plasma-facing materials is further discussed in Sects. 2.4 and Refs. [17–19].

### 1.2.2. Additional divertor functions

The divertor must in addition simultaneously perform two other essential functions - helium exhaust and impurity control. High neutral pressures and high pumping speeds at the entrance of the pump duct are necessary to remove helium ash and maintain high fusion reactivity in the core plasma [20–22]. In addition, strong pumping of hydrogen isotopes aids in plasma density control and possibly in impurity compression (see below).

Second, despite the low plasma temperatures in the divertor, impurities are inevitably present, either through chemical sputtering (in the case of graphite), from C and O impurity surface contaminants, or from impurity gases, which have been intentionally added to the discharge to increase radiative cooling [23–25]. The divertor must ensure that these impu-



urities are not transported into the plasma core. Both the flow of recycling fuel ions to the plate, plus the net flow in the SOL in cases where very strong divertor pumping is present (with main chamber puffing [23]), tend to compress/sweep impurities into the divertor. In fact, recent results in several divertor tokamaks have shown that the concentration of impurities in the divertor gas can be enhanced by factors of  $> 3$  over that present in the core plasma [23, 25, 26]. Such a situation is very encouraging, suggesting that relatively pure core plasmas can be obtained, while maintaining a relatively impure and highly radiating divertor. Some considerations on impurity production and plasma contamination for a next-step reactor are included in Sect. 2.3.1. The database for impurity production via erosion in tokamaks is reviewed in Sect. 4.3.

### 1.2.3. Plasma interaction with the main-chamber wall

The wall is a major source of neutral atoms and molecules, and hence plasma ions. Outside the divertor, in the region between the SOL plasma and the vessel wall, the density of neutrals is relatively low, typically a factor of 30 - 300 smaller than in the divertor. However, when spatially integrated over the large chamber wall, the total flux (in particles per second) can be quite significant, comparable in absolute number to the number of recycling ions at the divertor plates. Energetic hydrogen from the plasma can be retained in the wall, or return as neutrals to the plasma edge. Since the quantity of hydrogen in the wall is typically much greater than the quantity in a plasma, small relative changes in recycling of hydrogen from the wall strongly affects fuelling of individual discharges. Neutral particles coming from the wall readily cross magnetic field lines, increasing in energy as they repeatedly charge-exchange into the boundary plasma, until they are ionised. They then diffuse back out across field lines as ions carrying plasma power through convection. Since the divertor is likely to be opaque to recycling neutrals, this main chamber recycling goes on independently from the divertor [9, 27]. In addition to this cross-field flow, there may be additional parallel and poloidal flows in the SOL in the main chamber induced by a variety of forces, e.g., observations in JET [28, 29] and JT-60U [30] imply strong drift in the  $\nabla B$  direction (Sect. 5.3.1).

The average ion leaves and re-enters the plasma many times over the course of a discharge - this process is called recycling and average recycling times are in the range of 1 ms to 10 ms. Typically, the flux of hydrogen isotopes from the wall is a larger global particle source into the plasma than external fuelling by gas puffing [31], pellet injection (see glossary) [32] or neutral beam injection [33]. Wall-released hydrogen (H, D or T) can lead to an uncontrolled density rise and high plasma performance is often only possible when the influx of hydrogenic ions and impurities from the wall is controlled by wall conditioning (Sect. 4.6). Hydrogen (protium) influx is undesirable as it dilutes the reactivity of a deuterium-tritium plasma.

Wall conditioning has been used since the early phases of fusion research to provide the necessary conditions for plasma production and high plasma performance (Sect. 1.3) [34-42]. High-temperature bake and specialised discharges are used to deplete hydrogen trapped in the wall and to either volatilise and pump out contaminants from the wall, or to chemically bind them to the wall by gettering (Sect. 4.6). Extrapolation of currently-used tokamak wall

and surface conditioning methods to long pulse reactor tokamaks is not straightforward and is briefly discussed in Sect. 2.3.1.4.

Many advances in plasma performance in the last decade have come through improved wall conditioning, for example: boronisation in Alcator C-Mod [43] and DIII-D [44, 45], JT60-U [46], TEXTOR [47], START [48] and most recently, the best performance on MAST [49] and NSTX [50]. Lithium conditioning in TFTR [51–53] produced a dramatic 64 x increase in the fusion triple product ( $n_e \tau_E T_i$ ) (see Fig. 2 and Sect. 4.6 for more detailed discussion). Liquid lithium is being explored as a potential plasma-facing material in fusion reactors [54] and its use may open very attractive, stable, high beta ‘zero-recycling’ regimes [55]. Even when the plasma confinement does not improve, the use of wall conditioning permits density and recycling control, greatly widening the operational space in JET [56], ASDEX-Upgrade [57], and during long-duration (> 1 minute) plasma discharges on Tore Supra [58]. Although a predictive theory of the relation between the composition of the wall and plasma performance is lacking, some correlations of ‘cause’ and ‘effect’ are emerging. TFTR L-mode energy confinement was found to be correlated to the same parameters that are important for TFTR supershots [59] (see glossary). In both regimes the plasma transport coefficients increased with increased edge deuterium influx, suggesting a physical connection between energy confinement and hydrogen influx from the wall. A candidate for such a connection is shear stabilisation of ion toroidal gradient modes [60], which has reproduced the sensitive dependence of TFTR confinement on edge recycling.

*Insert Fig. 2*

#### 1.2.4. Physical and chemical sputtering and its consequences

Plasma ions approaching the material surfaces are accelerated by the sheath potential to an energy  $E_0 = 2 T + 3 Z T$ , where  $T$  is the plasma temperature adjacent to the material and  $Z$  is the charge of the ion. Above a certain threshold, the exchange of kinetic energy between the impacting ions and atoms in the top monolayers of the material, can knock surface atoms out into the plasma in a process termed physical sputtering. A fairly complete theory of physical sputtering now exists (Sect. 3.2). The predicted sputtering yields, as well as the expected trends with species properties (e.g., atomic mass, surface binding energy), have been experimentally verified in both tokamaks and laboratory devices. Incoming ions can also react chemically with surface atoms releasing atoms and molecules into the plasma. This chemical erosion process depends on molecular potentials and is significantly more complex than physical sputtering.

While physical sputtering is greatly reduced in a low temperature detached divertor plasma (Sect. 1.2.1), chemical erosion has a weak energy threshold and can cause significant erosion of carbon. This reduces the lifetime of divertor components (Sect. 5.3) and create the opportunity for the re-deposition of released carbon with tritium giving rise to operational and safety concerns (Sects. 2.3.3, 4.7 and 5.3). The importance of these consequences has stimulated vigorous recent investigation of the dependence of chemical erosion on a wide variety of plasma and surface parameters such as surface temperature, incident

species and energy, and incident flux. The complex role of molecular neutral and radical states and their transport/interactions with the plasma is posing a substantial challenge to PMI modelling. The flux dependence is a key parameter of interest for next-step devices (Sect. 5.3). Material mixing (e.g., metals sputtered from the first-wall depositing on a carbon divertor plate) can further complicate these already complex PMI phenomena.

The use of partially-detached plasmas (see glossary) in current tokamaks has been found to dramatically change the carbon divertor erosion rate; e.g., eliminating net carbon erosion due to physical sputtering in the DIII-D outer divertor, and leading to net deposition in both legs of the ASDEX-Upgrade LYRA divertor (Sects. 4.3.4 and 4.7.1.3). In particular, there are high levels of hydrocarbon molecules in the divertor plasma, which are dissociated by the plasma, resulting in high flux densities of carbon atoms and carbon-bearing molecules. The most dramatic result of this was the surprisingly large amount of deposition and associated tritium retention in the inner divertor louvres in JET (see Ref. [61] and Sect. 4.7.2.2.3).

Sputtered wall material represents a source of impurities for the plasma. It has been shown from modelling that impurities that enter the plasma in the main chamber are more efficient at contaminating the core compared to impurities entering at the divertor plate [62, 9]. Contamination of the core plasma with impurities from the wall dilutes the hydrogenic fuel (for a fixed plasma density) and causes energy to be lost by radiation. High-Z elements such as tungsten are very efficient radiators and concentrations much above  $10^{-5}$  impurity ions per hydrogen ion are intolerable. Low-Z impurities, on the other hand, are stripped of their electrons and do not radiate appreciably in the high temperature plasma core, thus graphite and beryllium cover large areas of the plasma-facing first-wall area in most of today's tokamaks, although the dilution problem remains (Sect. 1.3). A recent comparison of three tokamaks with carbon PFCs has indeed shown very similar erosion/re-deposition and hydrogenic retention patterns [63] (see also Sect. 4.3), with a marked asymmetry between the inner and outer divertor legs that remains largely unexplained (see Sect. 5.3).

### 1.3. History of Plasma-Facing Materials

PMIs have been recognised as a key issue in the realization of practical fusion power since the beginning of magnetic fusion research. As early as 1951, Spitzer [64] recognized the threat to plasma purity by impurities arising from PMIs and proposed a divertor to help alleviate the problem. In the following early years of research in the 1950's on stellarators and pinches [65–68], relatively primitive vacuum techniques were employed, resulting in severely contaminated plasmas (primarily carbon and oxygen desorbed from the wall). These discharges had such poor confinement and low plasma temperatures that even these low-Z impurities were not fully stripped in the plasma core, resulting in large central radiation losses.

By the time of the first tokamaks in the 1960's in the USSR and subsequently elsewhere, means of reducing the level of carbon and oxygen were being employed [69, 70]. These included the use of stainless steel vacuum vessels and all-metal seals, vessel baking, and discharge cleaning. Ultimately, these improvements, along with improved plasma confinement led to the first production of relatively hot and dense plasmas in the T-3 tokamak

( $\approx 1$  keV and  $\approx 3 \times 10^{19} \text{ m}^{-3}$ ) [71, 72]. These plasmas were cleaner and with low-Z elements fully stripped in the core but still had unacceptable levels of carbon, oxygen and metallic impurities. The metallic contamination inevitably consisted of wall and limiter materials. At one point it was thought that metallic impurity production was related to unipolar arcs (see glossary) [70], whose tracks could be visually observed on wall structures. It was later concluded that impurity production by arcs in stable, well-behaved discharges was relatively minor [73] (see also Sects. 2.3 and 4.4). Early work in this field has been reviewed by Behrisch [69] and McCracken and Stott [70].

### 1.3.1. Limiter and divertor tokamaks

Early in magnetic fusion research it was recognised that localising intense PMIs at some type of “sacrificial” structure was desirable, if only to ensure that the vacuum walls were not penetrated. Hence, the birth of the “limiter,” usually made very robust, from refractory material and positioned to ensure a gap of at least several centimetres between the plasma edge and more delicate structures like bellows, electrical breaks, vacuum walls, etc. Even with these precautions, vacuum wall penetration by trapped electrons has been reported [74]. Typical materials used for limiters (see glossary) in these early days included, stainless steel in ATC [75] and ISX-A [76] and many others, molybdenum in Alcator A [77], TFR [78], tungsten in ST [79] and PLT [80] and titanium in PDX [81]. A number of novel experiments have also been done with gold in DIVA [82], aluminium in ST [83], alumina in PETULA [84] and boron carbide in TFR [78]. A list of major toroidal plasma devices, past and present, appears in Table 1, giving their location, years of operation, limiter/divertor/wall materials and getter (see also glossary).

#### *Insert table 1*

By the mid-1970's the divertor concept, originally developed for the C-stellarator at Princeton [85, 86], was being tried on a number of tokamaks, starting with DIVA in Japan [87], T-12 in the USSR [88] and DITE in the U.K. [89]. The original divertor concept was to remove the source of first plasma contact to some remote location away from the thermonuclear plasma where impurities generated by the wall contact could be retained [64]. In addition, it was hoped that wall-produced impurities would be swept by the SOL into the divertor and be retained there. By the early 1980's [90–93], it was also recognised that in addition to these functions, the divertor should make it easier to reduce the plasma temperature immediately adjacent to the “limiting” surface, thus reducing the energies of incident ions and thus the physical sputtering rate. Complementary to this, high divertor plasma and neutral densities were found. The high plasma density has several beneficial effects in dispersing the incident power [9], while the high neutral density makes for efficient pumping. Pumping helps with plasma density control, divertor retention of impurities and, ultimately, in a reactor is necessary for helium exhaust.

A number of tokamaks continue to explore concepts other than the standard axisymmetric divertor, particularly, TEXTOR [94] and Tore Supra [95]. TEXTOR is devoted to PMI issues and a large area carbon pump limiter has been used to handle both the power and helium

exhaust. Near steady-state operation has been achieved in Tore Supra in limiter discharges, demonstrating active heat removal by PFCs. In addition, Tore Supra has investigated the performance of an ergodic divertor [96] (see glossary). This concept uses internal coils to ergodize (see glossary) the plasma boundary, creating conditions in some ways similar to that present in the SOL of conventional divertor tokamaks, i.e., reduced plasma temperature adjacent to surfaces and better impurity screening (see glossary).

### 1.3.2. Plasma-facing materials

By the late 1970's, various tokamaks were starting to employ auxiliary heating systems, primarily neutral beam injection (NBI). Experiments with NBI on PLT resulted in the achievement of the first thermonuclear class temperatures [80, 97, 98]. PLT at the time used tungsten limiters, and at high NBI powers and relatively low plasma densities, very high edge plasma temperatures and power fluxes were generated, resulting in tungsten sputtering and high core radiation from partially stripped tungsten impurity ions. For this reason, PLT switched limiter material to nuclear grade graphite. Graphite has the advantage that eroded carbon atoms are fully stripped in the plasma core, thus reducing core radiation. In addition, the surface does not melt if overheated - it simply sublimates. This move to carbon by PLT turned out to be very successful, alleviating the central radiation problem. For these reasons, carbon has tended to be the favoured limiter/divertor material in magnetic fusion research ever since.

By the mid-1980's, many tokamaks were operating with graphite limiters and/or divertor plates. In addition, extensive laboratory tests/simulations on graphite had begun, primarily aimed at understanding the chemical reactions between graphite and hydrogenic plasmas, i.e., chemical erosion (Sects 1.2.4 and 3.2). Early laboratory results suggested that carbon would be eroded by hydrogenic ions with a chemical erosion yield of  $\approx 0.1 C/D^+$ , a yield several times higher than the maximum physical sputtering yield. Another process, radiation-enhanced sublimation (RES), was discovered at elevated temperatures, which further suggested high erosion rates for carbon (Sect. 3.2.5). Carbon's ability to trap hydrogenic species in co-deposited layers became recognised (Sect. 3.5). These problems, along with graphite's (anticipated) poor mechanical properties in a neutron environment (which had previously been known for many years from fission research [99]), led to the consideration of beryllium as a plasma-facing material, primarily promoted at JET [100]. Beryllium has the advantage of being a low-Z material, non-reactive with hydrogenic isotopes and a good thermal conductor. However, beryllium has several negative features, including, a low melting temperature (1560 K), potential toxicity in manufacturing and relatively high physical sputtering rates. Nevertheless, two small tokamaks successfully tested beryllium (ISX-B [101], UNITOR [102]), and this led to extensive JET operation with beryllium limiters, divertor plates and evaporative gettering [100]. In fact, melting and evaporation of the beryllium limiters was extensive in all three cited tokamak experiments [100-102]. One immediate and clearly beneficial effect of beryllium operation was the observation of strong oxygen gettering by the evaporated beryllium.

At present, carbon is the dominant material in the major tokamaks world-wide, with

the exceptions of Alcator C-Mod at MIT, USA [103], which uses molybdenum, and FT-U at Frascati, Italy [104], which has used a variety of moderate to high-Z materials. Many machines have expanded graphite coverage to include virtually all of the vacuum vessel wall, in addition to the limiter/divertor plates (e.g., DIII-D [105]). In some cases, the inner wall is used as a large area limiter, and such structures, if carefully constructed, are able to handle enormous power loads, greatly exceeding the power limits of divertor plates (e.g., TFTR [106–108]).

Over the years, a variety of divertor plate materials have been used (see Table 1). In general, the success with carbon in limiter machines led to the use of carbon for divertor plates, although there are a number of cases where metals have been used. The argument for carbon in the case of divertor plates is not as strong as in the case of limiter machines. Carbon or other low-Z materials are most suited to high edge plasma temperatures, typically at low plasma density, as one finds at the edge of a high-powered limiter device. Again, this is related to the fact that carbon is fully-stripped in the core of tokamak discharges and thus does not cool by line radiation. When the plasma temperature adjacent to material surfaces is low, on the other hand, as in most divertor plasmas, the incident particle energies can very often be below the physical sputtering threshold of higher-Z materials. In contrast, carbon has a weak energy threshold for chemical erosion (Sect. 3.2). This, along with the fact that ion fluxes are very high in the divertor (high plasma density), means that relatively high erosion rates are expected and found for carbon divertor plates [109–111] (Sects. 3.2, 5.3). As a consequence, large hydrogenic retention has been found in films forming primarily on cold surfaces (see Sect. 4.7). The last decade of divertor research has seen a return of interest to metals, which had been largely put aside in favour of carbon. Sputtered high-Z metal atoms, such as tungsten, have a lower ionisation potential and lower velocity than sputtered carbon and are quickly ionised close to the surface and are promptly re-deposited onto the target near their point of origin. Divertor machines that have tried high-Z metal divertor plates in the low temperature/high-recycling mode (e.g., molybdenum in Alcator C-Mod [112, 113] and tungsten in ASDEX-Upgrade [114]) have indeed found very low levels of net erosion at the divertor plate. The installation of tungsten tiles on the inner wall of ASDEX-Upgrade has also given very encouraging results [115, 116]. No influence is observed on plasma discharges and the central radiation, intrinsic impurities, confinement H-mode (see glossary) threshold, density and beta-limits (see glossary) are unchanged. High-heat-flux components clad by tungsten that meet the severe normal operation thermal load requirements of the divertor have also been developed and successfully tested, though the response to off-normal events, such as disruptions, remains a concern (Sects. 2.4 and 2.5).

A key decision for a next-step device is the choice of plasma-facing materials. Historically, carbon has been favoured as a plasma-facing material as it has excellent thermal properties and carbon impurities in the plasma lead to only small increases in radiated power. Carbon is currently chosen to clad the ITER divertor target, near the strike-points, because of its greater resilience to excessive heat loads during ELMs and plasma disruptions (see glossary and Sects. 2.4 and 2.5). However, the operation of a next-step device with carbon PFCs will be severely impacted by the divertor erosion and tritium retention through co-deposition of

G. Federici, C.H. Skinner, et al.

T with C. For the latter efficient in-situ methods of mitigation and retrieval are required to avoid frequent interruptions imposed by precautionary operating limits set by safety considerations or necessitated by fuel economy. These issues become even more challenging in the design of a commercially attractive fusion reactor.



Review: Plasma-material interactions

Table 1: Major toroidal confinement devices, giving their location, approximate years of operation, limiter material, divertor plate material (if applicable), plasma-facing wall material and gettering technique.

Name	Location	Operation	Limiter	Divertor	Wall	Getter
<b>TOKAMAKS</b>						
Alcator A	MIT, USA	1972-1979	Mo, C	N/A	StSt	Ti
Alcator C	MIT, USA	1978-1983	Mo, C	N/A	StSt	
Alcator C-Mod	MIT, USA	1993-	Mo	Mo	StSt	B
ASDEX	Garching, Germany	1980-1990	StSt, C, Cu	Ti, Cu	StSt	C, B, Ti
ASDEX-Upgrade	Garching, Germany	1991-	C	C, W	StSt	B
ATC	Princeton, USA	1972-1978	StSt	N/A	StSt	Ti
Compass	Culham, UK	1990-	C	C	StSt	
DITE	Culham, UK	1976-1992	Mo, Ti, C	C, Mo	StSt	Ti, Cr
DIVA	Naka, Japan	1974-1979	Au	Ti	Au	Ti, C
Doublet II	GA, USA	1969-1973	W, SiC	N/A	StSt	Ti
Doublet III	GA, USA	1978-1984	StSt, W, C	StSt, C	StSt	
DIID-D	GA, USA	1986-	C	C	StSt, C	C, B
ISX-A	Oak Ridge, USA	1977-1979	StSt, C	N/A		
ISX-B	Oak Ridge, USA	1980-1987	StSt, Be, TiB <sub>2</sub> , TiC, B, C	N/A	StSt	Cr
JET	Euratom/Culham, UK	1983-	Inconel, C, Be	C, Be	Inconel	C, Be
JFT	JAERI, Japan	1972-	Mo, C, SiC, TiC, TiN	N/A		Ti
JT-60	JAERI, Japan	1985-1991	TiC, C,	TiC, C,	Inconel	-
JT-60U	JAERI, Japan	1991-	C	C	Inconel	B
FT	Frascati, Italy	1978-1989	StSt	N/A	StSt	-

FTU	Frascati, Italy	1990-	StSt, Inconel, Mo, W	N/A	StSt	Si
NSTX	Princeton, USA	1999-	C	C	StSt	B
ORMAK	Oak Ridge, USA	1973-1977	W	N/A	Au, StSt	
PBX	Princeton, USA	1984-1998	C	C	StSt	B
PDX	Princeton, USA	1978-1983	Ti	Ti		Ti
PLT	Princeton, USA	1976-1985	W, StSt, C	N/A		Ti
ST	Princeton, USA	1971-1976	Al, Mo	N/A		Al
START	Culham, UK	1990-1998	C	C		B, Ti
TCV	Lausanne, Switzerland	1993-	C	C	C	B
TdeV	Montreal, Canada	1987-1998	C	C	StSt	B, Li
TEXT	Austin, USA	1980-1992	StSt	N/A	StSt	
TEXTOR	Julich, Ger- many	1980-	StSt, C	N/A	IN	C, B, Si
TFTR	Princeton, USA	1982-1997	TiC, C	N/A	StSt	Cr, Li
TFR	Fontenay- Aux-Roses, France	1973-1986	C, W, Mo, BC	N/A	StSt	
Tore Supra	Cadarache, France	1988-	C and CFC	Ergodic divertor	StSt	B
T-10	Kurchatov, Russia	1976-	C, StSt	N/A		B
<b>STELLARATORS</b>						
ATF	Oak Ridge, USA	1988-1992	StSt, C	N/A	StSt	Cr, Ti
LHD	NIFS, Japan	1998-	StSt, C	StSt, C	StSt	Ti
W7AS	Garching, Germany	1988-	TiC, B/C	TiC, B/C	StSt	B

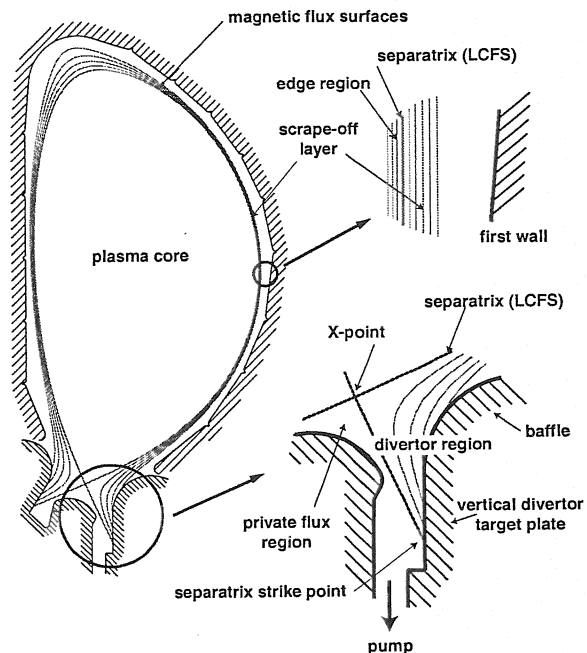

**Figure 1.** Poloidal cross-section of a tokamak plasma (with a single magnetic null divertor configuration), illustrating the regions of the plasma and the boundary walls where important PMIs and atomic physics processes take place. The characteristic regions are: (i) the plasma core, (ii) the edge region just inside the separatrix, (iii) the scrape-off-layer (SOL) plasma outside the separatrix, and (iv) the divertor plasma region, which is an extension of the SOL plasma along field lines into the divertor chamber. The baffle structure is designed to prevent neutrals from leaving the divertor. In the private flux region below the 'X' point, the magnetic field surfaces are isolated from the rest of the plasma.

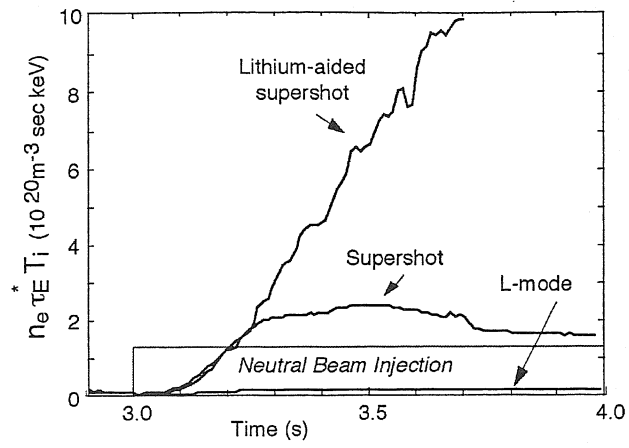

Figure 2. Showing the dramatic 64 x increase in the fusion triple product  $n_e \tau_E T_i$  in TFTR with wall conditioning.

## 2. PLASMA-EDGE AND PLASMA-MATERIAL INTERACTION ISSUES IN NEXT-STEP TOKAMAKS

### 2.1. Introduction

In this Section, we discuss several important aspects of the PMIs that are expected to occur in a next-step fusion facility. We point to significant differences with present experiments that open new design, operation and safety issues. The physical processes and underlying theory that support the understanding of these areas will be reviewed in Sect. 3, and the present experimental database and modelling of effects expected in a next-step reactor presented in Sects. 4 and 5, respectively.

Very often, the design features and parameters of the 1998 ITER design [117], or of the most recent reduced-size and reduced-cost option called the ITER-FEAT [118], are presented and used in the context of this article to exemplify issues that are generic to any reactor-scale next-step tokamak facility.

### 2.2. Progress Towards a Next-Step Fusion Device

#### 2.2.1. Advances in today's fusion devices and prospects

Much of the significant progress in magnetic fusion science has centred around the tokamak concept, which has represented the main approach to magnetic confinement fusion since its inception almost 50 years ago [119]. This concept also offers much promise of future performance enhancement. Ref. [13] summarises the qualitative and quantitative aspects of the most recent advances in tokamak physics and provides recommended extrapolation methodologies, together with uncertainty estimates and physics design specifications for use by the designers of the ITER facility.

In current tokamaks, with discharge durations of a few seconds, heat transport within the plasma has been reduced by suppressing turbulence, plasma pressure limits have been increased, the potential for steady-state operation by bootstrap (see glossary) and external non-inductive currents has been demonstrated, and concerns about handling exhaust heat and helium ash have been allayed. Progress in the development of regimes of operation, which have both good confinement and are magneto-hydrodynamically stable has enabled the production of significant bursts of fusion power from deuterium-tritium plasmas in TFTR ( $\approx 11$  MW) [120] and JET ( $\approx 16$  MW) [121–123] and, more importantly, opened the study of the physics of burning magnetically-confined plasmas. Improvements of plasma performance and control have occurred due to remarkable advances in various areas of physics and engineering. As an example, magnetic coil systems and their associated feedback control systems have been developed for stable confinement of the plasma, and produce many variations of plasma shape for optimisation of plasma performance. Superconducting coils (see glossary) have been used in magnetic confinement systems, and as a result very long discharges have been produced in the superconducting tokamaks Tore-Supra [124] and TRIAM-1M. The latter holds the world record in pulse duration (2 h) using non-inductive current drive (see glossary) by lower hybrid waves, albeit in low-density, low-power discharges [125]. This

clearly shows the potential for steady-state operation. Plasma heating technologies have been developed and deployed at the tens of megawatt level. Non inductive methods to drive the plasma current in low-to-moderate density plasmas have been successfully employed. The theoretically predicted self-driven or bootstrap current has been confirmed, and has significantly enhanced prospects for steady-state operation. Plasma diagnostic techniques have improved with higher temporal resolution and more extensive spatial coverage. New techniques to measure the plasma current profile and rotation have enabled deeper insights into plasma transport (see [126–129]). Tritium fuelling systems have been implemented and safely operated.

Integrating and extending these advances towards long pulses or steady-state burning plasmas is now the focus of international tokamak research, which aims to proceed to the construction of a physics and technology integration step [19, 130].

Such a device will encompass two parallel objectives, the creation and study of burning plasmas and the development and demonstration of the fusion technology required to make fusion a practical source of energy. The physics goals include: *(i)* explore the physics of burning plasmas in a plasma of sufficient duration that all plasma physics processes and plasma wall interactions have reached steady state; *(ii)* sustain plasma purity sufficient to maintain fusion gain; *(iii)* explore the physics of a radiative divertor designed to handle high-power flows at a reactor relevant scale; and *(iv)* develop robust techniques to mitigate and avoid disruptions at energies not accessible in present machines. The technology goals encompass *(i)* demonstrate key first-generation technologies needed to engineer future magnetic fusion reactor systems such as superconducting magnets, divertor systems to exhaust the power and particles from the plasma, remote handling systems for the remote installation and repair of device components and sub-components; *(ii)* provide a test bed for plasma-facing materials exposed to long duration power and particle fluxes; *(iii)* demonstrate an efficient tritium fuel cycle, including rapid removal of co-deposited tritium; and *(iv)* test tritium breeding blanked concepts. While some aspects of the relevant individual physics phenomena could be studied separately on somewhat smaller existing or new devices, the integration of long-pulse reactor-scale burning plasmas together with the relevant enabling technologies is the key mission of a next-step device.

Several issues such as plasma control, the handling of large plasma power and particle fluxes, and the associated intense PMIs, go beyond a specific device configuration and are generic to all approaches to magnetic fusion reactors. Much of what will be learned from a next-step experimental tokamak facility such as ITER will be directly applicable to any “alternate” magnetic-confinement concept, especially those utilising a toroidal configuration.

For the past decade, it has been the international view that burning-plasma physics is the next frontier of fusion plasma physics. The importance of moving to reactor-scale devices motivated the governments of the European Union, Japan, the Russian Federation (the former USSR), and the United States to initiate in 1987 the ITER Conceptual Design Activities (ITER/CDA). The promise of the ITER/CDA design, which was completed in 1990 [131], led in 1992 to the ITER Engineering Design Activities (ITER/EDA) agreement [132], aimed at developing a detailed engineering design for a reactor-scale tokamak facility that

would achieve controlled ignition and extended burn. As envisioned by the ITER agreement, the ITER device would be the central element of an international "one-step-to-a-reactor" strategy. The resulting overall design concept and the designs for the various systems and subsystem are documented in the 1998 ITER design report [117]. Despite the achievement of the ITER/EDA objectives, concerns over the cost of the program, and the advances in physics and technology made during the ITER/EDA period, have increased the incentive and opportunity to seek a lower-cost design by modifying the technical objectives. Currently under consideration is a fusion device, called ITER-FEAT, with a reduced physics and testing mission (e.g., energy amplification factor (see glossary),  $Q \approx 10$ , moderate pulse length of about 400 seconds up to steady-state, a minimum fusion power of  $\approx 400$  MW, and neutron wall loadings (see glossary) of  $\approx 0.5$  MW·m<sup>-2</sup>) [19, 118, 133, 134]. In an enhanced physics performance mode, such a device has the potential to demonstrate ignition. In addition, a strong emphasis is given to the goal of achieving steady-state operation (i.e., non-inductive operation with  $Q=5$  and with a pulse length of the order of 3000 s).

To overcome some of the remaining uncertainties, the next-step fusion device must be designed with sufficient flexibility to operate under a variety of experimental scenarios and to allow modifications during operation that would take advantage of results from earlier phases. It is expected that after construction, an experimental fusion reactor would operate for about 20 years as an experimental facility. The early phase of the experimental program would emphasise physics explorations. The intermediate phase would concentrate on the achievement of reliable quasi-steady-state operation with moderate neutron flux. Later phases would emphasise the accumulation of neutron fluence and operating time for fusion nuclear and materials science studies and for integrated component testing. Making design choices that are consistent with nuclear technology and remote-maintenance requirements is imperative.

A major objective of the next-step device is to provide a test facility for nuclear component technology development. The superconducting magnet, heating, fuelling, tritium handling, and most other systems will be based on technology that can be extrapolated to a prototypical fusion reactor. Future fusion reactors must be capable of replenishing the tritium fuel they consume and provide a start-up tritium inventory for subsequent reactors. However, it is expected that this technology will not be sufficiently developed for incorporation into a next-step machine at the outset. The nuclear testing role of a facility such as ITER is fulfilled mainly through the installation of tritium-breeding-blanket test modules (see glossary), introduced through ports specifically designed for this purpose. The tests foreseen on modules include the demonstration of a breeding capability that would lead to tritium self-sufficiency in a reactor, the extraction of high-grade heat, and electricity generation. It is anticipated that in parallel with this activity, advanced structural materials, capable of handling higher heat fluxes, higher neutron fluences, and with better waste disposal qualities, would be developed for use in future devices. Such materials are not yet ready for use as the main structures of a next-step tokamak. After the next-step device, a fusion demonstration reactor (DEMO) is envisaged to establish the technological reliability and economic feasibility of fusion power generation.

### 2.2.2. Distinctive features of a next-step tokamak

There are some essential differences between today's tokamak research facilities and viable design options for a next-step device. They are summarised in Table 2 together with the related primary issues. The increase in pulse duration and cumulative run time, together with the increase of the plasma energy content, will represent the largest changes in operation conditions in future fusion devices such as ITER. These will have by far the greatest consequences, giving rise to important PMIs, which are only partially observed and accessible in present-day experiments, and will open new design, operation and safety issues. Table 3 compares some of the characteristic design and operation parameters of today's divertor tokamaks and ITER. For the latter, parameters of the 1998 ITER design are included along with parameters of ITER-FEAT [118, 133, 134], where available.

*Insert table 2*

*Insert table 3*

Present-day machines operate in short pulse mode, with plasmas maintained for periods of the order of seconds, between which pause times of 5-30 minutes are typical. The power and particle loads are sufficiently small that they can be handled by making the PFCs, e.g., limiter modules or the divertor plates (see Fig. 1), of materials such as graphite, and cooling between discharges. In present-day tokamak devices, erosion of the main chamber wall and divertor strike-plates acts as a source of impurities in the discharge, but has no impact on the component lifetime mainly due to the very low duty-cycle ( $\approx 10^{-4}$ ). Erosion effects are on the scale of microns for a typical run campaign ( $\approx 1000-5000$  s/operation year) [63]. Similarly, fuel economy has never been an issue in deuterium-fuelled experiments and only recently have the limitations associated with the use of tritium, and its incomplete recovery in recent experiments in TFTR [120] and JET [123], brought the issue of fuel retention under closer scrutiny.

In contrast, long plasma duration and high duty-cycle operation in a next-step device such as ITER, will lead to a magnitude of erosion/re-deposition and tritium co-deposition that will impact operational availability due to the necessity of tritium removal and/or divertor plate replacement. Also, divertor heat loading caused by disruptions and so-called Type-I ELMs (see glossary) [135] would imply melting/ablation for *any* material in the divertor wetted by the plasma (Sect. 5.4). Considering this prospect, in ITER, the present design of the divertor near the strike-points (which bear the majority of disruption and ELM heat loadings) calls for C cladding to ensure resistance to damage caused by disruptions. However, trapping of tritium in carbon-containing co-deposited layers, particularly on cold regions hidden from direct contact with the plasma, represents a very serious problem for a next-step device. Efficient in-situ methods of reducing and retrieving the co-deposited tritium are required to avoid extended outages and for fuel economy reasons [3].



### 2.3. Most Prominent Plasma-Material Interaction Issues for a Next-Step Fusion Device

The most serious PMIs in a next-step device are anticipated to be in the divertor. This is primarily due to the concentration of power and particles onto relatively small areas of the divertor structure (Sect. 1.2). The most serious issues include power and particle control, response to off-normal events, tritium inventory and dust control [136]. These are the subjects of the following sections.

#### 2.3.1. Power dispersal and density control

##### 2.3.1.1. *Power dispersal and removal*

The thermal power, consisting of fusion alpha particle heating power (20% of the total fusion power for a DT reacting plasma), auxiliary heating power, ohmic heating power (see glossary), and the helium ash, must be exhausted from a thermonuclear plasma. This strongly influences several aspects of reactor design (impurity control, material selection, safety, etc.), and has an impact on reactor engineering.

As noted in Sect. 1.2.1, the peak power load on the divertor plates, in the absence of divertor radiation, is determined by the competition between parallel and perpendicular transport in the SOL, resulting in very small radial decay lengths, of the order of a few centimetres. Typical values of the parallel power density flowing in the SOL of a device like ITER, and today's tokamaks are shown in Table 3. For ITER the typical peak heat flux on the  $\approx 10 \text{ m}^2$  SOL-intercepted divertor area could be as high as  $20\text{-}30 \text{ MW}\cdot\text{m}^{-2}$ , without radiative cooling, and these values are near or beyond the limit that can be handled by conventional materials and cooling technologies.

The combination of surface heat flux and pulse length required to vaporise the surface of an uncooled "thermally-thick" material is shown in Fig. 3. It can be seen that for heat fluxes in the range of  $0.1\text{-}1 \text{ MW}\cdot\text{m}^{-2}$  (expected for example on the tokamak first-wall) passive cooling is sufficient for existing devices, but is not sufficient for next-step devices with pulse lengths greater than 100 s. For heat fluxes in the range of  $1 \text{ to } 10 \text{ MW}\cdot\text{m}^{-2}$  (i.e., on the limiters, divertor collector plates, etc.), passive cooling becomes marginal even in existing machines, and active cooling is required for any device with pulse length greater than a few seconds. A typical compromise for present devices involves the use of a robust refractory material like graphite, coupled to cooling only between discharges (although some have demonstrated full active cooling, e.g., Tore Supra [137]). Fig. 4 shows the dependence of the surface heat flux that produces melting of beryllium and tungsten and sublimation of carbon on the pulse length, for cases with passive cooling and active cooling. Finally, under heat fluxes experienced during Type-I ELMs (e.g., up to  $1 \text{ GW}\cdot\text{m}^{-2}$  lasting for up to about 1 ms) and plasma disruptions (e.g., up to several  $\text{GW}\cdot\text{m}^{-2}$  lasting for about 1-10 ms), active cooling will not be able to prevent surface ablation or melting, since the thermal diffusion time (i.e., time for heat transfer through the materials of the PFCs) is much longer (i.e., typically seconds) than the duration of the event [138].

*Insert Fig. 3*

*Insert Fig. 4*

The high-power density expected to be flowing in the SOL of a next-step device calls for means of dispersing this power in order to reduce it to acceptable levels for steady-state heat removal, i.e., about  $5\text{--}10\text{ MW}\cdot\text{m}^{-2}$ . The current strategy is to convert most of the flowing heat flux to impurity radiation in the outer periphery of the core plasma (see Fig. 1), as well as from the SOL and divertor plasmas, and redistributing that heat flux over the very large side-wall area of the divertor region in ITER [139–142]. Such a scenario can lead to the so-called “detached divertor” state [9]. This could be achieved, for example, by introducing noble gas ions, such as neon, argon, or krypton (via controlled feedback loops for either pellet injection into the core plasma or gas puff into the SOL). However, the amount of radiation is constrained by the requirement to maintain the power flow through the separatrix above the H-mode threshold (see Chapter 4 of Ref. [13]). Power dispersal by impurity radiation has been successfully implemented in today’s tokamak experiments and present machines have produced discharges where essentially 100% of the power is radiated in the main chamber boundary and divertor [13]. More recently, experimental and computational work has examined the radiation from carbon impurities intrinsic in all tokamaks [143]. Carbon is known to radiate effectively at low temperatures in the divertor plasma and is the dominant radiation source in the many detached plasma experiments that have used only deuterium puffing.

Two-dimensional plasma fluid and neutral transport codes, such as those discussed in Sect. 5.2, have been successfully applied to study SOL and divertor plasma experiments, and in many cases are reasonably successful in describing the observed phenomena. The results are in satisfactory agreement with observations of divertor detachment [144]. In these models, it is seen that carbon impurities, sputtered physically and chemically from the graphite divertor strike-plates, radiate as part of an uncontrolled but self-regulating loop. To date, these codes are important design tools for divertor layouts and/or for assessing the divertor performance of a given design under different operating conditions.

### 2.3.1.2. *Density control and helium exhaust*

Density control and helium exhaust are also aspects of tokamak operation that are important for any fusion reactor. Fusion power production depends sensitively on the core deuterium and tritium density, which is controlled via a combination of pumping and fuelling. Fuelling in the main chamber (and possibly in the divertor) is required to establish an initial plasma, to replenish the DT consumed during burn, and to replenish the DT pumped out with the helium. External pumping is required to remove the helium ash and to provide density control. The two primary methods of fuelling the core plasma in existing tokamaks are injection of fuel gas at the vessel wall (at the edge of the plasma) and injection of frozen  $\text{D}_2$  pellets at high velocities directly into the core [145]. For reactor-like conditions (large plasmas and high plasma pressures) the pellet cannot penetrate very far and fuel deposited near the edge can be quickly lost due to edge instabilities such as ELMs [146]. Recently, ASDEX-Upgrade [147] and DIII-D [148] have shown that pellet launch from the high-field

side of the plasma allows deeper pellet penetration and greater fuelling efficiency. This is the fuelling scenario favoured for a device like ITER.

Maintaining the He ash concentration below  $\approx 5\text{-}10\%$  is required in a burning plasma to avoid excessive fuel dilution. The He must be able to diffuse out of the core, and once out of the core, it must be efficiently pumped away to prevent its return [13, 149]. A pumpout time for He,  $\tau_{He}$ , that is less than 10 times the energy confinement time,  $\tau_E$ , is sufficient for a reactor [119]. Studies in current tokamaks [13, 150, 151], and code predictions for next-step conditions [152], have confirmed that for ELMy H-mode plasmas the thermal power and the He-ash can be exhausted at the rates required for ITER. At the same time, good quality confinement and sufficiently high density and plasma beta (see glossary) can be maintained to produce the requisite fusion power. A disadvantage of operation in ELMy H-mode is the relatively large (pulsed) ELM thermal energy loading on the divertor that represents a critical design challenge (Sect. 2.3.2).

#### 2.3.1.3. Erosion lifetime

Erosion/re-deposition in next-step devices will impact operation availability due to the necessity of divertor plate replacement and remote handling procedures to accomplish this are incorporated in the present design. High energy density disruptions ( $10\text{-}100 \text{ MJ}\cdot\text{m}^{-2}$  in 1-10 ms) and Type-I ELMs ( $\leq 1 \text{ MJ}\cdot\text{m}^{-2}$  in 0.1-1 ms) (Sect. 2.3.2) will cause melting/ablation for *any* material in the divertor. While details of the damage caused by such disruptions is somewhat uncertain, calculations also show severe heating of nearby divertor components not directly wetted by the plasma (Sect. 5.4).

The erosion lifetime of the ITER divertor plates, near the strike-points is dependent on the type and thickness of the armour material, the erosion rate (material loss rate) due to sputtering, disruption vaporisation and melting, and the plasma-edge conditions (Sects. 5.3 and 5.4) [153, 154]. ELMs are expected to strongly affect the lifetime of the divertor target in a next-step device and their predicted effects are discussed in Sect. 5.4.3. The general trends are illustrated in Fig. 5, for fully-detached plasma conditions, with three wall armour materials: 40 mm thick carbon, 20 mm thick W, and 10 mm thick Be [154]. It can be seen that the lifetime of a Be divertor target is relatively short (i.e., 120-320 shots depending on the fraction of melt loss) and is dominated by slow transients (e.g., due to loss of control of detachment when the full power of the SOL strikes the target for several seconds, and the heat flux reaches  $20 \text{ MW}\cdot\text{m}^{-2}$ ). On the other hand, the lifetime of a carbon-fibre composite (CFC) armoured divertor target is dominated by sputtering, disruptions and slow-power transients. The lifetime of a 40 mm thick CFC is estimated to be 5800-8200 shots and depends on the incident power and the temperature-dependence of chemical sputtering. For tungsten armours, the lifetime is dominated by disruptions and is 2400-7700 shots, depending on the melt-layer loss. In partially-detached plasma operation (see glossary), the edge plasma temperature and heat flux ( $\approx 10 \text{ MW}\cdot\text{m}^{-2}$ ) is higher than in detached plasmas, and therefore, to avoid overheating of the divertor plate, the thickness between the surface and cooling channels for CFC must be reduced to 20 mm. The sputtering rate is higher in partially-detached plasma operation since both the particle flux and particle energy are

increased. On the other hand, high-power transients become relatively less important since the difference between transient and normal operation becomes smaller. Whereas the lifetime of a beryllium divertor drops below 100 shots at  $10 \text{ MW}\cdot\text{m}^{-2}$ , more than 2000 shots for the CFC, and 1500-4000 shots for the W are predicted. While significant uncertainties exist in these estimates, the results are nevertheless sufficiently valid to illustrate trends and to guide the current material selection for a next-step device (Sect. 2.4).

*Insert Fig. 5*

#### 2.3.1.4. Plasma contamination and wall conditioning

Impurity production (i.e., erosion) is not the only factor in plasma contamination. Equally important is the efficiency of impurity transport into the core plasma, and this depends critically on location (limiter versus divertor), plasma-edge parameters, and wall surface material. Local divertor impurity sources strongly affect the radiation in the divertor. However, impurities produced in the main chamber are more efficient at contaminating the core plasma [9], especially those from first-wall surfaces that are physically closest to the core (e.g., protection limiters, antennas and other protruding parts) and that receive considerable ion fluxes [155]. In ITER, modelling shows that the core plasma conditions are highly sensitive to neutral influx, and therefore, the divertor is designed in such a way that maximum isolation is achieved between the highly radiating divertor with its high neutral density and the main plasma chamber. In contrast to the divertor, erosion rates at the wall are predicted to be low enough that the tiles do not need replacement [156, 157], but because of the large wall area, the total amount of eroded material is significant. This material will most likely end up in the divertor, affecting the composition of materials surfaces, and consequently changing the divertor performance. Also, there is some concern on the effects resulting from the impact of energetic particles (charge-exchange neutrals and ions) on the first-wall surfaces such as mechanical degradation of materials and production of dust. However, for metals such as beryllium and possibly tungsten, such micro-damage was found to have a favourable effect in reducing the implanted tritium inventory (Sects. 3.5 and 5.6).

The first-wall in several divertor tokamaks is an area that experiences net erosion, while the inner divertor is a region of net re-deposition and the outer strikepoint undergoes net erosion. The mechanisms for the redistribution of carbon from areas of erosion to areas of re-deposition are not all clear, and there is no satisfactory explanation for the extent to which interactions at the divertor and main chamber contribute to the observed re-deposition (Sects. 4.3 and 5.3).

It is difficult in general to compare the impurity control capabilities of different tokamaks. The  $Z_{eff}$  (see glossary) of the core plasma is certainly a measure of the core cleanliness, however, the primary deficiency in this benchmark is that it does not tell us the shielding capability of a given operational scenario and how it varies with the  $Z$  of the impurity. Even so, there have been several comparisons of the different operational scenarios in a single tokamak. For example, in ASDEX it was found that the core  $Z_{eff}$  was 2-3 for limiter operation, and 1-2 for divertor operation [13]. Similar comparisons have been made in C-Mod

with a smaller variation but similar trends [13]. In general, the  $Z_{eff}$  in diverted tokamaks tends to be lower than in limiter tokamaks.

Carbon and tungsten are the present candidates for use in the ITER divertor (Sect. 2.4). The plasma compatibility of carbon and tungsten impurities in a burning plasma experiment has to be assessed from two different points of view. The tolerable amount of carbon (concentration  $< 1.5\%$ ) in the plasma is limited by the dilution of the fuel (dilution limited) while that for tungsten (concentration  $< 2 \times 10^{-5}$ ) is limited by radiation losses in the plasma core. Carbon has a relatively high chemical sputtering yield (1 to 2%) at hydrogen (H,D,T) fluxes  $< 10^{22} \text{ m}^{-2}\text{s}^{-1}$  (Sect. 3.2). This large source term of carbon could pollute the plasma beyond the above-mentioned limit even when considering the relatively good impurity retention in a divertor. This implies that designs of next-step tokamaks should minimise surfaces clad by carbon. Due to the low concentration limit for tungsten, a large source would be intolerable. Experience in modern divertor tokamaks [114, 116], indicates that for plasma-edge conditions similar to those anticipated in a next-step tokamak, most of the sputtered tungsten would be locally re-deposited within one gyro-radius. In addition, due to the high sputtering threshold, W is predominantly sputtered by impurity ions, and thus the total sputtered flux is relatively low. This combination of a low source term and high impurity retention in the divertor makes W a candidate plasma-facing material in the divertor of a next-step tokamak. However, melt-layer issues remain (Sect. 2.4). There is a need to gain more operational experience with tungsten in present-day tokamaks, and experiments are ongoing in ASDEX-Upgrade [116] to determine its suitability in areas of the main chamber.

A wide variety of wall conditioning techniques have been developed and applied in tokamaks (Sect. 4.6.2) over the past two decades, and wall conditioning in a next-step device is projected to also involve a variety of different methods [13]. However, extrapolation of wall and surface conditioning methods to a device like ITER, and to reactor tokamaks in general, is not straightforward. Specific design-related features e.g., superconducting magnets, combined use of different wall materials, and operational limitations, will preclude or limit utilisation of some of the most extensively used current surface conditioning techniques. The increased duty-factor (see glossary) will result in a substantially different wall conditioning situation than present tokamaks. The permanent presence of the toroidal field will preclude glow discharge cleaning (GDC) - see glossary. Applicability of standard pulse or Taylor discharge cleaning methods [158] is likely to be very limited. Therefore, electron cyclotron resonance (ECR) and/or ion cyclotron resonance (ICR) conditioning (see glossary) are envisioned for between-pulse cleaning. The feasibility of these methods for conditioning in present tokamaks is under investigation and promising results have been already obtained [40, 41, 159, 160].

The uses of other wall conditioning techniques are more speculative. Diborane "flushing" [161, 162], i.e., chemical "passivation" of oxygen by the injection of  $\text{B}_2\text{D}_6$  gas, is not affected by magnetic fields and may be a useful technique between pulses. The effect of periodic thin film deposition such as boron will be, at most, transient. Such transient deposition could be important for discharge initiation or real-time erosion control. However, a new technique

for lithium wall coating by a laser generated aerosol [163] operates during the discharge and has the potential to sustain a Li coating in long pulse machines. The use of beryllium as first-wall material in ITER should provide oxygen control, since some of this wall material will be sputtered and re-deposited elsewhere in the machine where it could act as a natural getter.

Finally, appropriately modified wall conditioning techniques (e.g., He/O discharges or baking in an oxygen atmosphere) are also being studied as a means of removing the co-deposited tritium inventory in ITER (Sects. 2.3.3 and 4.7.3). The detailed operational requirements for baking the PFCs in ITER will be determined both by the basic plasma operation requirements, and by the PFC materials and the conditions under which they are used. Mixed-material effects resulting from the use of different armour materials in different regions of the machine (Sect. 2.4) add significant uncertainties in this respect. However, it is quite clear that the introduction of oxygen to remove tritium will compromise the surface conditions needed for plasma operation.

### 2.3.2. Effects of disruptions and other plasma disturbances

#### 2.3.2.1. *General remarks*

All existing tokamaks are subject to occasional rapid plasma termination events, called "disruptions." In the early years, disruptions were mainly regarded as a nuisance and the limited time and spatial resolution of the diagnostics prevented much progress in their understanding [164]. In present-day large-size machines, like JET, TFTR and JT-60U, disruptions have already caused significant machine damage e.g., melting or erosion of PFCs, short circuits in external supplies, and deformation of in-vessel structures [13]. The situation is predicted to be more severe in future fusion devices, like ITER, where heat loads and forces will be up to two orders of magnitude larger (Table 3). The underlying disruption erosion mechanisms are described in Sect. 3.4. The experimental database, mainly from disruption simulation facilities, is presented in Sect. 4.5, whereas the erosion effects projected in a next-step device are discussed in Sect. 5.4.

Disruptions can generally be divided into one of two basic categories: major disruptions and vertical displacement events (VDEs) (see glossary) that lead to a disruption. These differ in the sequence of events. In a major disruption, the plasma first becomes unstable due to reaching an operational limit, in density or beta, which leads to the growth of a large magneto-hydrodynamic (MHD) mode (see glossary). In present devices this is sometimes initiated by a small piece of material falling into the plasma. The resulting rapid cooling of the plasma periphery can result in an unstable plasma. The large MHD activity causes a loss of nested confinement (magnetic field) surfaces. The thermal energy is rapidly lost (thermal quench) and the current profile flattens, causing a drop in the plasma inductance (see glossary) and a corresponding upward spike in the current. Finally, the high resistivity of the cold plasma results in a rapid decay of the plasma current (current quench). The plasma radial and vertical position are frequently lost after the thermal quench as a consequence of the change in the current profile. In a VDE, the results are similar but the sequence is

different. The first event is a loss of the vertical position, and the plasma moves vertically with the cross-section and the edge safety factor,  $q$  (see glossary), decreasing as the plasma scrapes off against the first-wall. The plasma then disrupts: the thermal quench occurs (typically, there is no current spike), followed by the current quench.

2.3.2.2. *Effects of disruptions and design considerations*

Extensive progress has been made in understanding and quantifying the impact of disruptions on an ITER-scale device [13]. Disruptions will have the same underlying causes as those in present-day tokamaks, however, their consequences will be much more severe [165]. First, the plasma thermal energy in ITER will be 10-100 times larger than in JET and up to a 1000 times than in Alcator C-Mod [166]; see Fig. 6. More importantly, the "specific energy" during the thermal quench of an ITER disruption (i.e., the plasma thermal energy divided by the surface area of the PFCs wetted by the plasma), which provides a measure of the severity of the PMI in disruptions, will be about 10-100 MJ·m<sup>-2</sup> in a time of the order of 1-10 ms. Thus, the specific energy in ITER will be 10 times larger than in JET and JT-60U, and about 40 times larger than in Alcator C-Mod.

*Insert Fig. 6*

*Refs. [165, 167] appear in the caption of Fig. 6. They are reported here to maintain consistent reference sequential numbering while appending the figures at the end of the section.*

Although the time-scale for energy deposition in the rapid "thermal quench" phase of a disruption will be somewhat longer in ITER than in present-day tokamaks, it will still be insufficient for heat transfer through the material of PFCs. Thus, disruptions in ITER will cause ablation and melting of surface material of the divertor target area, and possibly a good fraction of the divertor walls [168, 858]. Calculations and experiments show that a vapour shield should form in front of the divertor targets, dispersing the majority of the incident energy flux to the divertor chamber walls via radiation. This, in turn, could cause thin melt and vaporisation layers to form over nearby components (Sects. 3.4 and 5.4). This wall ablation, which is expected to dominate the PMIs during disruptions in ITER, is not energetically possible in present-day tokamaks.

Second, VDEs will produce much larger forces on vessel components in ITER than in present-day tokamaks. As the plasma column moves during a VDE, a substantial fraction of the plasma current is transferred to a "halo" region around the main plasma. Since the halo intersects the vessel wall, the return path for this "halo current" (see glossary) passes through conducting components of the vessel structures. The flow of this return current will be perpendicular to the main magnetic field, thus exerting a large mechanical force on these structures. The ITER design allows for halo currents that are approximately the same fraction of the total plasma current as is observed in present-day experiments [13]. In addition, plasmas with strongly shaped cross-sections, such as in ITER, are also subject to a particular kind of disruption, in which the entire plasma column moves vertically (e.g., due to a fault in the vertical position feedback control system) without a disruption thermal quench. The main difference between this type of event and a thermal-quench-initiated

'vertical disruption' is that in the latter the thermal energy loss is essentially complete before appreciable vertical motion develops. The VDE will lead to intense PMIs such as impurity release and wall melting and vaporisation. Because of the longer duration, deleterious effects may result at the armour/heat-sink interface in the regions of the first-wall where the plasma intersects the PFC wall surfaces. These effects are not present or appreciable in present experiments, whereas in ITER they are expected to deposit several tens of  $\text{MJ}\cdot\text{m}^{-2}$  over times of the order of a fraction of a second (Sect. 5.4).

Third, the high electric fields produced by disruptions can also give rise to production of runaway electrons (see glossary) with multi-MeV energy (Sect. 4.5.2.3). Although, in recent years, there has been significant progress made in characterising the major elements involved in runaway generation (see for example [13]), there are still substantial uncertainties related to the quantification of material damage effects and the database from tokamaks is somewhat limited in this respect. Table 4 summarises the main types of transient plasma events expected in a device like ITER, as well as their characteristics and major consequences.

*Insert table 4*

The thermal quench duration is estimated to be 1-10 ms; the range reflects uncertainty in extrapolation of data to ITER size and plasma temperature, and also the observation that thermal quenches are sometimes single-step and sometimes multi-step. The location of the thermal quench deposition is expected to be within the divertor. Since a SOL-widening of up to 10-x is sometimes seen in present experiments, a part of SOL and, therefore, of the energy may be deposited on the wall region near the divertor entrance and/or the first-wall. Partitioning of the energy between the inner and outer divertor is relatively uncertain; however, data typically show more energy to the inside divertor. Dissipation (80-100%) of the magnetic energy in the current quench phase will be primarily by radiation to the first-wall, with a poloidal peaking factor  $\leq 2$ .

VDEs and runaway electron events during the current quench phase will result in more localised energy deposition on the first-wall. See for further details Refs. [13, 169, 170]. Misalignment of the first-wall tiles will increase local heat deposition.

#### 2.3.2.3. *Other plasma disturbances, e.g., ELMs*

Other plasma disturbances such as sawteeth (see glossary), ELMs, and other recurring bursts of MHD activity are routine aspects of normal plasma operation and will continue during the entire pulse. The main characteristics and the resulting consequences of these events are summarised in Table 4. A detailed discussion of these processes is beyond the scope of this review and the interested reader is referred to Refs. [2, 13, 171]. ELMs [135] produce a periodic very rapid expulsion of thermal energy and particles from the edge region into the SOL and finally to the surfaces of the divertor and/or first-wall, which must be designed to withstand these types of events. ELMs transiently reduce the temperature and density at the top of the H-mode transport barrier and thereby affect the core confinement. In addition, they can lead to increased transient peak heat loads on the divertor plates and increase erosion of first-wall materials [172]. Although ELMs are instabilities localised



to the periphery of the core plasma, scaling studies from current tokamaks indicate that 3-10% of the thermal energy of the core plasma can be quickly ( $\approx 0.1-1$  ms) lost to the divertor [171, 173]. This represents energy densities that surpass the most severe disruptions in current tokamaks, and ELMs occur every second or so! The predicted material damage, by evaporation and melting represent critical design issues for a next-step tokamak device [2] (Sects. 2.3.1.3 and 5.4.3).

#### 2.3.2.4. *Disruption and ELM mitigation*

Disruption avoidance would conserve the operational lifetime of in-vessel components, and avoid loss of operational time for wall reconditioning. However, despite these significant incentives, disruption avoidance remains to be a goal to be achieved, particularly in regimes close to known operation limits. Therefore, when designing PFCs, it is important to distinguish between events that will be handled by avoidance from events that must be included in the design. At present, the ITER divertor is being designed to accommodate disruptions for lengthy operating periods before replacement will be required. For this reason carbon has been selected near the strike-points to withstand the power loads of disruptions without melting. As an alternative, during the early phase of ITER special limiters could be used to handle VDEs, runaway electrons, etc. Such limiters, however, may not be suitable during the later phase of ITER where long lifetime, tritium inventory, etc., become important issues.

There has been some experience with disruption mitigation in existing tokamaks using large gas puffs or pellet injection of noble gases (He, Ne, Ar), which tend to dissipate the stored kinetic energy through impurity line radiation. These techniques reduce power loading on the divertor plate by a factor of 2-3, as well as vessel forces due to poloidal halo currents (e.g., see [174]). The injection of a solid impurity pellet (commonly termed a 'killer pellet') into a tokamak plasma is capable of effecting a rapid non-disruptive shut-down of plasma energy and current. These pellets are typically composed of moderate-Z or high-Z materials, and the pellet size and velocity are chosen such that the pellet can penetrate deep into the plasma core. Impurity pellet shutdown experiments demonstrating non-disruptive dissipation of the plasma thermal and/or magnetic energies have been performed in JT-60U [175-177], ASDEX-Upgrade [178, 179], DIII-D [174, 180, 181], Alcator C-Mod [182], JET [183] and TFTR [184, 185]. The efficacy of killer pellet shutdown clearly depends on having sufficient penetration of the pellet into the plasma, such that the resulting impurities are deposited more-or-less uniformly throughout the plasma cross-section. Rapid anomalous inward transport of the injected radiating impurities has been observed [186]. This tends to cause effective radiation cooling over the entire plasma radius, with 90-100% of the stored kinetic and magnetic energy being radiated.

Effective shutdown also depends on selecting an impurity that radiates strongly at the moderate plasma temperatures (typically a few hundred eV) that arise following the initial adiabatic cooling produced by the pellet. In present experiments, these features are obtained by tailoring the pellet species and mass (see e.g., [178]), and to a more limited extent, the injection velocity are tailored to provide strong radiative cooling. However, injection of high-Z impurities leads to the generation of potentially damaging large runaway currents

[174, 187]. In DIII-D [174], signatures from runaway electrons have been observed on all the argon pellet discharges, and many of the neon pellet discharges. Deuterium injection avoids, in principle, this problem but the amount of injected material required is very large. Recently, massive bursts of helium gas have been used to mitigate the deleterious effect of VDEs and density limit disruptions in the DIII-D tokamak [174, 188]. Due to the high plasma densities achieved, no runaway electron production was expected and none was observed. Most of the energy flowing toward the divertor is seen to be dissipated as radiation in the main chamber. The simplicity and expected reliability of this technique makes it a strong candidate for disruption mitigation in large-scale devices. The injection of hydrogen or helium liquid jets has also been proposed as a new concept for disruption mitigation and fast shutdown in tokamaks [189]. Liquid jets can rapidly cool the plasma to reduce divertor heat loads and large halo current forces, while simultaneously raising the density sufficiently to prevent runaway electron generation [190]. Another novel method for the fast shutdown of a large, ignited tokamak consists of the injection of 30-45 (6 mm) deuterium pellets doped with a small (0.0005%) concentration of krypton, and the simultaneous ramp-down of the plasma current and shaping fields over a period of several seconds using the poloidal field system [191].

Unlike disruptions, which must be practically eliminated in a working reactor, ELMs will continue to be present in order to provide particle and impurity control. Transient peak loads during ELMs in future devices are relatively uncertain, due to the uncertainty on the thermal energy loss from the core plasma during an ELM, the fraction of energy deposited on the target plates, the deposition profile on the divertor target, and the duration of ELM energy deposition. However, it is quite clear that Type-I and giant ELMs pose a significant problem for ITER [2]. Encouragingly, high confinement modes with small ELM amplitudes (often classified as Type-II ELMs, although it has not been verified whether all of these modes correspond to the same phenomenon) have been observed in several devices, e.g., grassy ELMs in DIII-D [13], 'minute' ELMs in JT-60U [13], and the enhanced  $D_\alpha$  (EDA) mode in Alcator C-MOD [192]. Recent experience at JET has shown that discharges with only radio-frequency (RF) heating had low amplitude ELMs, and that it may be possible to use shallow pellets to trigger ELMs, thereby lowering their amplitudes. Measurements from ASDEX-Upgrade [193], as well as new experiments with gentle gas puffing in DIII-D [194], show a much lower normalised ELM energy loss (typically a factor of 4) than the results in [171], with only a modest degradation of confinement. Near the H-mode threshold, Type-III ELMs (whose amplitude is much smaller than Type-I ELMs) have been observed [135].

### 2.3.3. Control of the in-vessel tritium inventory

#### 2.3.3.1. *In-vessel tritium inventory in plasma-facing components*

Safe management and accounting of tritium will be crucial for the acceptance of fusion as an environmentally benign power source. Tritium retention in plasma-facing materials has emerged as a primary concern for next-step fusion devices fuelled with mixtures of D and T, with strong implications for in-vessel component design, material selection, operational

schedule and safety. Special controls imposed on the handling of tritium [195–197] require that the quantity of tritium retained in the torus be accounted for and the inventory limited [198, 199] in order to permit continued operation within the licensed site inventory limit. An excessive tritium inventory in the torus would present a safety hazard in the form of a potential tritium release to the atmosphere in case of a loss of vacuum accident. For example, in TFTR, the quantity of tritium permitted in the vessel was restricted to  $< 7.4 \times 10^{14}$  Bq (2 g) to limit release to the environment in the event of a major vacuum leak and simultaneous failure of tritium containment systems. Besides tritium inventory control, tritium removal from the wall is required to control plasma fuelling by tritium implanted in the wall and to reduce the tritium out-gassing and thus minimise personnel exposure during venting of the torus for maintenance. Independent of safety limits, control of the in-vessel tritium inventory is also necessary to avoid exhausting the available tritium supply. Tritium retention mechanisms are reviewed in Sect. 3.5.

Hydrogen and deuterium retention has been measured in several tokamaks, and recently, the large tokamaks, TFTR and JET, have provided precise measurements of tritium accounting (Sect. 4.7.2) and have expanded the technical knowledge base for tritium issues in fusion reactors [200]. Table 5 provides a list of key quantities related to tritium in existing tokamaks and a next-step device [201–204].

*Insert table 5*

Tritium retention and the control of the tritium inventory in ITER and future reactors strongly depends on the choice of plasma-facing materials and their operational conditions (e.g., temperature of PFCs, flux density of impinging particles, plasma-edge conditions), and geometry effects (e.g., gaps, shaded regions, etc.). Recent experimental results (Sect. 4.7) and modelling (Sects. 5.3 and 5.6), show that as long as some carbon is used in the machine to clad the divertor plates, the dominant mechanism for hydrogenic retention will be co-deposition with carbon and there will be a need to mitigate/control tritium co-deposition and accumulation in the torus. Retention by other mechanisms such as implantation and surface adsorption, which may be significant for small short-pulse machines, are expected to rapidly reach saturation in ITER.

Laboratory measurements have shown that co-deposited films start to decompose when exposed to air at temperatures  $> 520$  K, releasing tritium (Sect. 4.7.3.1) [205–209], so they are considered at risk under ITER accident conditions, and their accumulation need to be strictly controlled on safety grounds. The released hydrogen is mainly in the form of water [210]. A precautionary operating limit of 1000 g was set for mobilisable in-vessel tritium in the 1998 ITER design, based on safety considerations due to the release from postulated accident sequences (more than a factor of two lower, i.e., about 350 g, is set for the design of the smaller ITER-FEAT). Upon reaching this limit, operation will be discontinued and dedicated cleaning techniques/procedures (discussed below) applied to reduce the torus tritium inventory. The frequency of cleaning intervention will strongly depend on the rate of co-deposition.

It is clear that the rate of tritium build-up observed in JET and TFTR (Sect. 4.7.2.2) is

much too high for a next-generation fusion device. However, there are still large uncertainties in quantifying the in-vessel tritium inventory in next-step devices. The tritium retention fractions in terms of throughput experienced in existing machines cannot be simply applied to ITER. The fraction of tritium retained in a tokamak depends on the amount of eroded carbon, which in turn depends on the machine geometry, plasma-edge conditions, wall material and temperature, fuelling and heating methods, etc. Thus, detailed modelling, including these effects and validated in existing tokamaks is necessary to confidently predict tritium retention in ITER. Modelling has been performed for typical plasma-edge scenarios (Sect. 5.3) [3, 153, 157, 211] to predict the tritium inventory in ITER. The estimated tritium co-deposition rates are relatively high (i.e., in the range of 2-20 g/pulse), although the projected retention fraction is lower than that observed in present-day tokamaks (TFTR, JET [201, 204]). The uncertainties of these estimates arise mainly from the uncertainties of the plasma-edge physics parameters, which strongly affect the erosion, deposition and co-deposition patterns and rates. Moreover, mixed-material surfaces, arising from the simultaneous use of different plasma-facing materials to protect the in-vessel components, introduce significant uncertainties.

#### 2.3.3.2. *Tritium removal from co-deposited layers*

Interruptions of plasma operations, as often as weekly, to remove tritium will be necessary in a next-step device with carbon PFCs. In JET and TFTR (Sect. 4.7.2) tritium removal took place over several weeks, i.e., considerably longer than the approximately 1000 s cumulative total time of high-power DT discharges [202, 204]. This would not be adequate in a fusion facility like ITER where the tritium removal rate will need to be orders of magnitude faster to support the reactor's operational schedule.

Although several alternatives are being considered for the removal of the T-rich co-deposited layers, their removal from a next-step machine remains a major unsolved problem. Techniques involving exposure to oxygen (e.g., thermo-oxidative erosion at temperatures above 570 K, or oxygen plasma discharges) have been found to be most effective in laboratory experiments to remove tritium from tritium-containing films (Sect. 4.7.3). Major drawbacks of techniques using oxygen, especially at elevated temperature, include potential damage of other in-vessel components, and wall conditioning recovery time for normal plasma operation. No practical method of localising the oxidation to the area required (and avoiding oxygen exposure elsewhere) has been developed, although various ideas are being explored. In addition, processing of the DTO exhaust generated is costly. Alternatively, high temperature baking (> 900 K) under vacuum is sufficient to remove the trapped tritium, but is technically very difficult to achieve in the torus. Finally, solutions to mechanically move T-bearing flakes to an ex-vessel reclamation facility (e.g., by using a conveyor [212]) are also being investigated.

Further development and optimisation of the divertor design, based on information provided by future experiments in existing tokamaks, would be useful to control and to mitigate the extent of the co-deposition problem. From design perspectives, initial considerations are being given to solutions that could mitigate co-deposition in critical areas of the divertor

(Sect. 2.5).

If carbon-based materials were to be eliminated from the divertor of a next-step device, the situation as far as tritium inventory is concerned would be radically different and the control of the tritium inventory much more manageable (see, for example, the experience of Alcator C-Mod (Sect. 4.7.1) [213]). New design solutions using tungsten instead of carbon for high-heat-flux regions are being explored (Sect. 2.5). However, the ability of tungsten to withstand high-heat-flux transients without suffering damage through melting is unclear and may make disruption mitigation a necessity (Sect. 6.6).

#### 2.3.3.3. *Fuel Isotopic tailoring*

Efficient plasma fuelling is very important to any DT fusion device as the tritium supply is limited and expensive. Only a fraction of the tritium is 'burnt' in the plasma, and minimising the tritium throughput reduces the cost of reprocessing of the plasma exhaust and the potential for losses into the environment [31].

The tritium fractional burn-up (see glossary) in JET and TFTR was low (i.e.,  $10^{-4}$  in TFTR). However, in a device like ITER, the tritium burn-up fraction is expected to be  $\approx 1\%$  [31], and up to 30% under very optimistic conditions in future reactors (ARIES-RS [214] - see glossary). The high tritium burn-up fraction in ARIES-RS is due to the anticipated higher power density; basically more tritium is burnt before it can be transported from the plasma core. A tritium fuelling rate of at least 0.1-0.2 g/s will be needed to fuel a 1000 MW reactor with a burn-up fraction of 1%.

Tritium-rich pellets could fuel an optimal 50:50 D:T mix in the core plasma, while deuterium-rich gas puffing would lead to a reduced tritium fraction in the edge plasma [215]. Because of the improved particle confinement associated with the deeper tritium core fuelling component, comparable core densities of deuterium and tritium can be maintained even when the edge deuterium fuel source is much larger than the core tritium fuel source. This isotopic tailoring of the deuterium and tritium density profiles can lead to reduction in the tritium inventory accumulating in PFCs. Modelling with the DIFFUSE code [215] showed that the tritium inventory retained in the torus could be decreased by about a factor of two by isotopic tailoring of the fuel sources, reducing the time needed for tritium removal (Sect. 2.3.3.2).

#### 2.3.3.4. *DT neutron effects and tritium self-sufficiency*

Although not usually considered in the context of PMI phenomena, the production of energetic (14 MeV) DT neutrons generated in a reactor-scale plasma raises important issues concerning the design and operation of PFCs [216]. The neutrons activate PFCs, and shielding is necessary to limit neutron damage and exposure to personnel and the public. A dedicated volume neutron source is envisioned in the future to research DT neutron effects on materials and qualify materials for a commercial fusion reactor [217, 218] and these issues will not be further discussed here. On the positive side, neutrons enable the breeding of tritium fuel, a prerequisite for DT fusion power. However, the margin of tritium breeding is low and tritium self-sufficiency issues bear directly on the choice of plasma-facing materials

in future DT reactors and pose stringent limits on the maximum permissible retention of tritium.

In a tritium self-sufficient reactor, neutrons are used to breed the tritium to replace that consumed in the DT reaction. The tritium burn-up rate in a reactor of fusion power  $P_F$  (MW), fuelled with a 50-50 DT mixture is:

$$\dot{A}_T(g/s) = 1.77 \cdot 10^{-6} \times P_F (MW) \quad (1)$$

A 1000 MW device will burn  $\approx 6.5$  g of tritium per hour of continuous operation. For a typical duty-cycle of 0.3, the tritium consumption will be  $\approx 46$  g/day. The tritium consumption and fuelling requirement for the 1500 MW 1998 ITER design have been quantified in [117]. During the Basic Performance Phase, that was expected to last  $\approx 10$  years, approximately 27 kg would have been burned (averaging about 5 kg/yr in the last five years of operation when operation was anticipated to become more oriented towards technology testing). These tritium requirements were derived from an operational plan, which specified a total number of  $\approx 9000$  DT pulses with a typical pulse length of  $\approx 1000$  s, corresponding to a neutron fluence of about  $0.3 \text{ MW}\cdot\text{yr}\cdot\text{m}^{-2}$ . A subsequent ten-year Engineering Performance Phase was planned with a primary objective of raising the neutron fluence to about  $1.0 \text{ MW}\cdot\text{yr}\cdot\text{m}^{-2}$ . In this phase, tritium would have been partially produced in the reactor using a breeding blanket with a breeding ratio of 0.8. The remaining  $1.7 \text{ kg}\cdot\text{yr}^{-1}$  would have come from external sources. The reduced-size ITER-FEAT design, currently under consideration, would have a lower total tritium consumption (e.g.,  $\approx 22$  kg of tritium for a fusion power of about 500 MW, and neutron wall loading of  $\approx 0.5 \text{ MW}/\text{m}^2$ , with a total fluence of  $\approx 0.3 \text{ MW}\cdot\text{yr}\cdot\text{m}^{-2}$ ). However, it will probably not have a breeding blanket, so that all of its tritium will have to be provided from external sources.

Present supplies of tritium are generated by neutron irradiation of deuterium in heavy water reactors, but the availability of the tritium supply, and hence the time window for fusion energy development, is not unlimited [219]. Tritium production from the Canadian CANDU reactors is expected to decrease to near-zero in the early 2030's. Delays in the advance to a DT next-step device such as ITER, would risk a significant penalty in the additional cost of developing alternate supplies of tritium, once the CANDU supply is exhausted or lost by radioactive decay.

The supply of tritium will determine the future introduction of fusion power reactors. In power reactors, the tritium fuel will be bred via nuclear reactions in blankets containing lithium breeder materials surrounding the burning plasma.



One can see the possibility for energy gain in reaction (2) and net tritium breeding through secondary neutrons produced in reaction (3). Neutron multiplication is also possible through nuclear reactions in beryllium. The margin for tritium breeding is relatively low. Lithium provides the highest local tritium breeding ratio of 1.86 and a neutron energy multiplier of 1.27 [220]. Tritium production, via breeding reactions (2) and (3), in liquid and

ceramic lithium-based breeder materials, and tritium extraction have been demonstrated through capsule irradiation in fission reactors [221–223]. In practice only a fraction of neutrons produced can be used to breed tritium. The net tritium breeding ratio (TBR) (see glossary), which is the product of the local breeding ratio times the blanket coverage, is estimated by 3D neutronics codes [224, 225] and needs to be at least 1.07 [226]. An implicit benefit of efficient isotopic tailoring (sect. 2.3.3.3) is the reduction of the required tritium breeding ratio due to the increase in tritium burn-fraction. As shown in Ref. [225], a factor of two increase in the tritium burn-fraction can have a significant effect on the tritium breeding ratio required for tritium self-sufficiency, reducing it from values of  $\approx 1.15$  to about 1.05. This will benefit an engineering test facility like ITER by reducing costly tritium start-up inventories, and it also has significant implications for an electricity grid based on fusion power reactors.

To convert a significant fraction of electricity generation to fusion power, it is anticipated that the number of fusion reactors would have to be doubled every 1–5 years. Each new reactor would need a startup tritium inventory [227]; furthermore, the tritium inventory radiologically decays at the rate of 5%/year, requiring replacement. For these reasons, there is a premium on minimising the tritium inventory in a DT reactor. The development work in this area [228] has made significant progress in this direction by reducing the required site inventory for ITER to about 4 kg. The maximum tolerable tritium loss rate (including both the tokamak and the tritium plant) depends on both the fuel burn-up fraction and the fuelling efficiency. Continuous retention or loss as low as 1% of the fuelling rate would imperil tritium self-sufficiency because of the relatively low tritium breeding ratio [229]. Carbon PFCs, which might be required in the ITER divertor design to survive disruption erosion, will not be usable in commercial fusion power reactors due to erosion lifetime and tritium co-deposition considerations (Sects. 3.5.3, 4.3, 4.7, and 5.3). Metal (e.g., tungsten) PFCs are not expected to continuously retain tritium once an initial inventory has been built-up in the implantation layer, and so are likely to be preferred. Elimination or mitigation of disruptions to permit the use of metal divertor and first-wall components is a *necessary* condition for practical fusion reactors.

#### 2.3.4. Control of the in-vessel dust inventory

Dust is produced inside the vacuum vessel of a tokamak by interaction of the plasma with the components of the first-wall and the divertor. In the past this has received little attention within the fusion community, mainly because dust is neither a safety nor an operational problem in existing tokamaks. However, the ITER design has highlighted the fundamental need to deepen understanding of the production of dust in tokamaks, since this may impact directly on the safe operation of a next-step device. The safety issues associated with tokamak dust [230–233] include radiological hazard (tritium and activation products) (see glossary), toxicity, and chemical reactivity with steam and air.

A variety of “undesired” products result from PMIs (e.g., films, flakes, debris, dust) and it is not clear how many of these should be considered as a “dust” hazard. Small amounts of dust have been collected in various tokamaks during scheduled vacuum vessel

vents [234, 235] and have been analysed (Sect. 4.8). Flaking and break-up of films, resulting from re-deposition of eroded and vaporised material, is expected to be the primary source of dust in a device like ITER. Arcing, which tends to release micron-size particulates, may also play an important role, but investigations are needed to better quantify the effects (Sects. 3.3 and 4.4). If re-deposited carbon layers are susceptible to arcing, the release of particulates will be saturated with deuterium-tritium presenting safety and operational issues (Sect. 4.8).

The radiological hazard and/or toxicity of the dust depends on the specific dust material, on how much is produced and how well the dust is confined. Confinement depends on the dust particle size (e.g., particles larger than  $\approx 100 \mu\text{m}$  will not be transported to the environment). The activation products of tungsten are radiologically hazardous, while the radiological hazard of beryllium and graphite comes not from activation products, but rather from the tritium present in the dust.

Dust can also chemically react with steam and air, and materials like beryllium, tungsten and carbon oxide, producing hydrogen. In particular, accident scenarios that result in water or steam exposure of hot plasma-facing materials (e.g., during loss-of coolant accidents) are of concern for fusion reactor designs such as ITER, that include beryllium as the first-wall material. Steam interactions with hot beryllium can produce significant quantities of hydrogen [236], and hydrogen in the presence of air, can lead to explosion. The amount of hydrogen produced depends on the specific material, temperature, exposure time, and especially the effective surface area. The large surface area associated with dust can greatly amplify its chemical reactivity [237].

For the above reasons, it is envisaged that the dust inventory should be limited in a device, such as ITER: (a) to ensure that chemical reactivity is adequately controlled to avoid the hazard of hydrogen or dust explosions [238, 239], and (b) to be coherent with the given radioactivity confinement requirements based on environmental release limits [240]. The location where the dust settles will determine its temperature, and consequently, its chemical reactivity.

Dust limits in the ITER design for carbon and beryllium stem primarily from chemical reactivity concerns. The tungsten dust limit is determined by both chemical reactivity and activation hazards. Two different dust limits are currently considered. First, a restrictive limit, on potential chemical reactions for beryllium dust residing mainly in the grooves of the tungsten armour of the divertor PFCs (e.g., dome and baffle); (Sect. 2.5). These grooves or castellations in the tungsten armour are an essential feature of the design and must remain in order to relieve stresses during cyclic loading with high heat flux, thus maximising the fatigue lifetime of the armour to heat-sink joint. This dust can be subject to overheating and steam exposure during long-term decay heat driven and short-term non-decay heat driven incidents. The administrative limit for the inventory of particles in the grooves (typically  $\ll 10 \mu\text{m}$ , that are highly reactive because of their relatively large surface area), is in the range 10-20 kg. The second limit is the overall amount of dust that can be mobilised during an accident and, hence, escape into the environment causing a radiological hazard. This is set at a few hundred kg. Within a machine the scale of ITER, these limits represent values that will be difficult to diagnose or guarantee.



The present design of the ITER PFCs is being optimised to minimise dust accumulation by decreasing the number and dimensions of the grooves on the plasma-facing surfaces in the critical areas. The rest of the dust and flakes, is expected to collect in and beneath the divertor, where sufficient space is available for introducing dust handling systems that can either remove dust on-line or during intervals between pulses.

Simply measuring the in-vessel dust inventory was demonstrated to be a challenge in existing machines and there are still large uncertainties associated with dust production mechanisms and rates and extrapolation from present machines to next generation of tokamaks. Research into dust production mechanisms and rates and the appropriate dosimetric limits for personnel exposure has just begun [241–243] (Sect. 4.8).

#### 2.4. Selection Criteria for Plasma-Facing Materials

Operation experience in existing fusion devices has centred around the use of carbon, mainly because of its high thermal shock resistance and tolerance to off-normal events (ELMs, disruptions) without melting, thereby avoiding surface irregularities (Sect. 1.3.2). A notable exception is the use of Be in JET, both at the wall [100] and at the divertor (Mk-I) [244]. Experiments in ASDEX-Upgrade [245] with tungsten in the divertor, and more recently at the inner wall [116], and the use of molybdenum in Alcator C-Mod [155, 246, 247], have also shown that high-Z materials might be acceptable in fusion devices with divertors that can produce low plasma-edge temperatures ( $\approx 10$  eV or less).

The selection of the armour materials for the PFCs of a next-step experimental fusion reactor, is a compromise between multiple requirements derived from the unique features of a burning fusion plasma environment. The factors that affect the selection come primarily from the requirements of plasma performance (e.g., need to minimise impurity contamination and the resulting radiation losses in the confined plasma), engineering integrity, component lifetime (e.g., need to withstand thermal stresses, acceptable erosion, etc.), and safety (e.g., need to minimise tritium and radioactive dust inventories). In this respect, erosion/re-deposition and tritium retention are a major factor in the choice of plasma-facing materials for a next-step reactor.

In the ITER design, beryllium is the primary candidate material for the first-wall, whereas tungsten is the preferred material for the divertor, except for the area near the strike-points. Each of these three candidate materials has some inherent advantages and disadvantages (see Table 6), and their application depends on the specific operational requirements. The rationale for this selection is thoroughly discussed elsewhere [17–19]. The choice of carbon for the parts of the divertor where the SOL strikes the vertical target and energy deposition from disruptions and ELMs will occur, is mainly due to its good power handling and thermal shock resistance; it does not melt (but sublimates) and preserves its shape even under extreme temperature excursions. In this region, beryllium would have an inadequate lifetime (Sect. 2.3.1.3) and tungsten would vaporise during high power transients and could pollute the plasma. Furthermore, with a full tungsten target there are concerns regarding the formation and the properties of a thick melt layer (up to few hundred  $\mu\text{m}$  thick) during a thermal quench and Type-I ELMs (Sect. 5.4), and the generation of surface irregularities

that might later form hot spots in normal steady heat flux operation. Because of its low physical sputtering yield and high threshold energy for physical sputtering, W is foreseen in regions where the significant flux of hydrogen neutrals, predominantly of low energy, can lead to large sputtering and unacceptably short lifetimes for materials such as carbon and beryllium. However, with the above material selection the co-deposition of tritium with carbon remains a primary concern. The Fusion Ignition Research Experiment (FIRE) design study [248] (see glossary) has forgone the use carbon PFCs for this reason, the first-wall is covered with Be tiles and divertor uses W rods on a Cu backing plate.

*Insert table 6*

An extensive research and development (R&D) program has been conducted on cooling technology [249] and on the development of joining technologies between armour (beryllium, tungsten and CFCs) and copper-alloys/stainless steel [250–252]. Robust engineering solutions of actively cooled high heat-flux components clad with CFCs have been developed and tested successfully for up to several thousand cycles at heat fluxes of the order of  $20 \text{ MW}\cdot\text{m}^{-2}$  [253, 254]. Recently, substantial progress has also been made on the development and testing of water-cooled high heat-flux components clad with beryllium and with tungsten [250]. Fig. 7 shows the ranges of operational requirements for first-wall and divertor components, and the results of high-heat-flux tests with water-cooled Be/Cu and W/Cu components. W-armoured prototypes already promise to be as reliable, at similar heat fluxes, as their carbon armoured counterparts [253–255]. This requires, particularly for materials like tungsten, the use of “discrete” structures (e.g., castellated, brush-type, etc.) of the type portrayed in Fig. 8. However, there are some remaining concerns of possible PMI effects resulting from the use of such geometrical configurations. These include the interaction of the sharp edges with the plasma, resulting in possible enhanced erosion, arc initiation from the corners, and plasma contamination. Other effects include: the formation of “bridges” across the gaps in case of melting; change of thermomechanical behaviour; the accumulation of large amounts of erosion products (dust, tritium co-deposits) in cold regions where it may be difficult to remove them; and possible copper substrate erosion due to the presence of gaps.

The primary shortcomings of W that should be addressed in the coming years are the lack of operational experience and the dearth of experimental data regarding formation of melt layers (and their properties) during disruptions (Sect. 6).

The present strategy in ITER is to initially install carbon as armour on the targets, and to maintain the option to switch to more reactor relevant all-tungsten armoured targets prior to DT operation, when tritium inventory becomes an issue. The decision to make this change will depend the progress made in controlling the plasma, in particular, on the frequency and severity of disruptions, and on the other hand, the success achieved in mitigating the effects of tritium co-deposition. Removal and exchange of divertor cassettes will require remote handling capabilities, as discussed in Sect. 2.5.

*Insert Fig. 7*

*Ref. [256] appear in the caption of Fig. 7 and is reported here to maintain consistent reference sequential numbering while appending the figures at the end of the section.*

Insert Fig. 8

## 2.5. Overview of Design Features of Plasma-Facing Components for Next-Step Tokamaks

A cross-section showing the in-vessel components of the 1998 ITER design [117, 257] is illustrated in Fig. 9 and used here as an example to point out some of the characteristic features of the design of a reactor-scale experimental facility. The operation parameters and heat, particle, and neutron fluxes on the PFCs are summarised in Table 7. Design and engineering considerations of the reduced-size lower cost option, ITER-FEAT, are discussed in Refs. [133, 258]. The in-vessel components are cooled by pressurised water at  $\approx 370$  K. The maximum water baking temperature of the PFCs is limited to  $\approx 510$  K because of the 4 MPa maximum pressure that can be allowed in the water cooling pipes. There may be a possibility of baking the divertor to higher temperatures with hot gas (e.g., He), but the time required to completely remove water, introduce gas, and then reintroduce water will limit such enhanced temperature baking to major commissioning and decommissioning periods.

Insert Fig. 9

Insert table 7

*Vacuum vessel and blanket:* The ITER vacuum boundary is formed by a double-walled vacuum vessel made of stainless-steel SS 316L(N)-IG, ITER Grade: 0.06 to 0.08% nitrogen (60 mm plates for the outer and inner shells, and 40 mm stiffening ribs), which is supported against gravity by the toroidal field coil structure, and which contains the blanket and divertor systems [259, 260]. The basic functions of the vacuum vessel are to provide a suitable vacuum in the plasma chamber, to support the in-vessel components, to assist in the nuclear shielding of the coils and to constitute the first safety boundary. To this end, the vessel cooling system has to provide radioactive decay heat removal by natural convection even when the vacuum vessel and the blanket cooling loops are not functioning (no pumping action). The shielding in particular from neutron radiation has to be sufficient to stay below critical nuclear heating levels in the coils and to allow limited *hands-on* maintenance inside the cryostat.

The shielding blanket is composed of modules, which are attached to a thick backplate in the case of the 1998 ITER design, and in the ITER-FEAT design are instead directly supported by the vacuum vessel. The shielding modules are water-cooled steel blocks, which are effective in moderating the 14 MeV neutrons, with a water-cooled copper mat bonded to the surface of the modules on the plasma side, and protected from interaction with the plasma by an armour material. In order to limit the thermal stresses in the vacuum vessel and to provide sufficient shielding, i.e., keep the He production in the vacuum vessel inner shell below 1 appm, the blanket modules have a minimum thickness of 450 mm and consist on average of  $\approx 80\%$  steel and 20% water (cooling channels). During later phases of operation, some of the blanket shielding modules may be replaced by tritium breeding modules with a design similar to the one described in Ref. [117].

*First-wall:* The first-wall design is generally less demanding than the design of the divertor high-heat flux components (see below) due to lower steady-state heat loads, originating mostly from radiation. However, a longer lifetime is required ( $\approx 40000$  discharges) than for the divertor components. This results in a significantly larger total neutron fluence for the first-wall than for the divertor, favouring the choice of stainless steel for the first-wall structure and the associated cooling tubes. The first-wall design is based on 1 mm thick 10 mm diameter SS cooling tubes with a pitch of  $\approx 20$  mm, embedded in a Cu alloy layer of  $\approx 15$  mm thickness (DS-Cu or CuCrZr). The plasma-facing material is a 10 mm thick Be layer [259, 260]. The first-wall incorporates the two start-up limiters [261], which need to absorb several MW of power (up to  $\approx 8 \text{ MWm}^{-2}$ ) during the limiter phases of each discharge (i.e.,  $\approx 100$  s during plasma start-up and  $\approx 100$  s during plasma current ramp-down). The limiters are located in two ports at the equatorial plane of the machine. The main loading conditions for these components are summarised in Table 7.

With the aim to reduce cost and nuclear waste, design options are currently being investigated for a modular and separable first-wall. This new design approach would allow damaged or eroded blanket modules to be repaired inside the Hot-Cell either by replacement of first-wall panels or plasma spraying.

*Divertor:* During the past few years, progress towards the understanding of divertor physics, through experiments, modelling (Sect. 5.2) and model validation in existing divertor machines, has been significant. Based on the available knowledge base, the currently proposed divertor for ITER [13] utilises a “vertical target” geometry. A key potential advantage of the vertical target configuration is enhanced recycling. The neutrals recycling in the outer part of the SOL are reflected toward the separatrix near the strike-point rather than away from the separatrix (see Fig. 1), thus increasing the level of recycling. Detached or partially-detached plasma regimes can accomplish the required peak heat flux reduction by spreading the power over a larger surface area of the divertor chamber walls and the first-wall by enhanced radiation from the plasma edge. The access to such regimes depends on the divertor configuration, the level of heating power, the impurity level, the edge confinement mode, and the edge density (Sect. 2.3.1 and glossary). Although the techniques employed for power handling in the present ITER design are based on validated scaling laws and models, the design allows for some flexibility to accommodate unforeseen effects. For this reason, the ITER divertor is being designed to be very versatile, with components mounted onto removable and reusable (to minimise activated waste) cassettes so that they can be easily replaced.

The divertor is installed in the vacuum vessel in segments or cassettes (e.g., 54 in ITER-FEAT), where they are supported on a pair of concentric toroidal rails that form part of the vacuum vessel (see Fig. 10). The main PFCs of the divertor system are the inner and outer vertical targets, which are the high-heat-flux component, which in their lower part (Area 1 in Fig. 10) interact directly with the SOL plasma and in their upper part (Area 2 in Fig. 10) act as baffles for the neutrals. The private flux region PFC (Area 2 in Fig. 10), consists of: a dome, located below the separatrix X-point, that baffles neutrals, and is exposed mainly to radiation and charge-exchange neutrals, and a semi-transparent liner that protects the

cassette body from direct line-of-sight of the plasma, while allowing He and other impurities to be pumped away. The design operation parameters and material selected are summarised in Table 7.

The divertor design is being further developed and optimised, based on information provided by modelling and dedicated operation experience in existing tokamaks and laboratory simulations (focussed on understanding the chemistry of hydrocarbon deposition [262, 263]), with the scope to eliminate or at least to mitigate the problem of co-deposition. Several design options are currently being investigated to minimise the formation of films in specific areas (e.g., by ensuring that regions of probable deposition are kept "hot" during operation, leading to reduced tritium retention [264]), or by enhancing deposition in specially designed 'cold traps' for the hydrocarbon ( $70\text{ K}$ ) [265], which could be periodically heated to recover the tritium in the form of stable gas molecules. Detailed evaluations of this design are on-going, however, the complexity of including such a system is to be avoided if at all possible.

The solution shown in Fig. 10, for example, achieves high operating temperatures on the surface of divertor in the private flux region (see glossary), by using the radiated power from the divertor channel to heat radiatively-cooled tungsten tiles [264]. The tiles are shaped in such a way as to prevent or minimise line-of-sight from the plasma to the cassette body and to create a labyrinth through which the helium ash, hydrogen-isotopes, and other impurities are pumped from the divertor channels, while providing sufficient length for the hydrocarbons entrained in the gas stream to undergo many collisions with the hot surface of the liner. This could minimise the co-deposition of tritium with carbon by de-hydrogenating the carbon and/or recombining most of the active radicals to convert them into stable volatile molecules, which are pumped away without residual deposits. Although this promises to reduce the amount of co-deposited T, maintaining the divertor exhaust pumping capability is not compatible with providing enough hot wall collisions to transform enough of the active radical species to stable compounds that can be pumped. Also, concerns remain for the remaining fraction of the radicals with relatively low sticking coefficient, that passes through the liner form thin, soft, hydrogenated films on the relatively cold ( $< 420\text{ K}$ ) large structures behind the liner. In this case, an ancillary 'cold' catcher plate, strategically located, could be used to condense the remaining hydrocarbons. The tritium trapped on this plate could be reclaimed by occasional heating.

*Insert Fig. 10*

Table 2. Distinctive features of a next-step device and related PMI issues.

- 1) **High energy content** (*several hundreds MJ vs. few MJ in current devices*) and **power flow** (*several hundred MW in the SOL vs. few MW in current devices*):
  - more intense disruptions and disruption-related damage effects (e.g., material ablation and melting) resulting in local damage and in a substantial influx of impurities into the plasma;
  - plasma power densities in the divertor will be larger than in present-day experiments and require an effective reliable way to disperse the power on the divertor surfaces.
- 2) **Long pulse duration** (*few hundreds s vs. few s in current devices*):
  - requires active cooling of PFCs and vessel structures and techniques to pump helium ash during each pulse;
  - requires effective control of plasma purity and PMIs to achieve high plasma performance.
- 3) **High duty factor (3%-10%) or pulse repetition rate**:
  - high-performance plasma operation with limited shut-down times for wall conditioning and tritium recovery from co-deposited films;
  - remote maintenance with acceptable shut-down times.
- 4) **Long cumulative run time** (*several thousands of hours of operation over several calendar years*):
  - the erosion lifetime of PFCs may be sufficiently short that several replacements will be required during the lifetime of the device;
  - large-scale erosion also raises tritium retention and dust (safety) issues that may determine feasibility of reactor design;
  - neutron damage effects in the bulk of surrounding materials and structures (e.g., loss of thermal conductivity of CFC, swelling, embrittlement, etc.);
  - plasma-facing surfaces will be modified in situ by the plasma, which will mix the plasma-facing materials. The composition, physical structure and properties of deposited materials will be different to manufactured materials.
- 5) **Routine operation with large amount of tritium** (*10-100 g/pulse vs. fractions of g in current devices*):
  - this requires a closed fuel cycle with efficient reprocessing of the exhaust stream (e.g., limited but successful operation experience of TFTR and JET);
  - requires adequate tritium supply, minimisation of the inventory of tritium retained on in-vessel components and efficient methods of recovery;
  - address safety concerns of any vulnerable tritium inventory.
- 6) **Superconducting magnet technology** (*if adopted*):
  - a thick neutron shield is required to protect the toroidal and poloidal coils, thereby increasing the major radius and the overall size of the device; neutron and gamma irradiation destroy organic insulators and superconductors, and also increase the resistivity of the stabilising Cu (typical limit is  $<10^3$  rad);
  - since the superconducting magnets will remain energised during the interval between pulses, certain techniques used in tokamaks for between-pulse wall preparation/conditioning will not be feasible;
  - long-pulse devices have to be "self-conditioned" during normal operation due to plasma/wall equilibration and wall saturation on a time scale of 100-1000 s.
- 7) **Fast remote maintenance for repair/refurbishment of the in-vessel and some of the ex-vessel components**:
  - viability of remote methods of maintenance, repair and upgrading of fusion devices, is a key technology for development of fusion reactors (e.g., limited but very successful experience at JET);
  - requires a specific system, component and sub-component design philosophy to minimise shut-down times (fast remote maintenance and repair), and to meet stringent constraints imposed by a radioactive environment.
- 8) **Safety**:
  - Requires stringent and detailed safety assessments and safety-related procedures and controls;
  - Stringent worker and public radiation protection measures;
  - Public education to establish safety and risk in context.

Table 3. Comparison of parameters\* of contemporary divertor tokamak research facilities and ITER.

Parameters	Moderate-size tokamaks <sup>(a)</sup>	Large-size tokamaks <sup>(b)</sup>	ITER <sup>(c)</sup> 1998 design; <sup>(d)</sup> ITER-FEAT
major/minor radius, (m)	1.65/0.5 (AUG)	3.25/1 (JT-60U)	8.14/2.80 (6.2/2)
aspect-ratio, (A=R/a)	3.3 (AUG)	3.2 (JT-60U)	2.9 (3.1)
vertical elongation, (k=b/a)	1.9 (DIII-D)	1.8 (JET)	1.6 (1.7)
triangularity, (at 95% poloidal flux)	0.3 (AUG)	0.1-0.4 (JET)	0.24 (0.35)
plasma volume/area, (m <sup>3</sup> /m <sup>2</sup> )	14/44 (AUG)	82/150 (JET)	2000/1200 (840/680)
wall/divertor plate areas, (m <sup>2</sup> )	307-9 (AUG)	200/30 (JET)	1200/200 (680/80)
plasma current, (MA)	2-3 (DIII-D)	6 (JET)	21 (15)
toroidal field on axis/at the coil, (T)	8.0/17.3 (C-Mod)	3.8/6 (JET)	5.68/12.5 (5.3/10)
material of toroidal field coils	Cu	Cu	Nb <sub>3</sub> Sn and NbTi (NbTi)
Q=P <sub>out</sub> /P <sub>heating</sub>	0	0.2-5s, 0.62 <sup>(e)</sup> (JET)	∞ (10)
type-I ELM energy range (MJ)	0.02-0.04 (DIII-D)	0.1-0.6 (JET)	25-80 (8-25)
ELM deposition time (ms)	1 (DIII-D)	0.1 (JET)	-1
plasma thermal energy, (MJ)	1.2 (AUG)	15 (JET)	>1000 (350)
disruption thermal quench time, (ms)	0.1-1 (C-Mod)	1-10 (JET)	1-10
disruption surface energy density, (MJ-m <sup>-2</sup> )	0.03 (AUG)	0.1 (JET)	10-100
disruption magnetic energy, (MJ)	-1 (AUG)	10-15 (JET)	-1100 (310)
disruption current quench time, (ms)	10 (AUG)	-10 (JET)	50 (25)
max. halo current in VDEs, (MA)	0.4 (C-Mod/AUG)	0.8 (JET)	10 (6)
potential for runaway avalanche	No	No	Yes
Z <sub>eff</sub>	1.3-3 (AUG)	1-3 (JET)	<1.9 (1.65)
available volt-seconds, (V-s)	10 (AUG)	15 (JET)	≤80 (≤50)
energy confinement time, (s) ELMy H-mode	≥0.2 (AUG)	0.1-1 (JET)	6 (3.7)
fusion power - P <sub>DT</sub> , (MW)	-	16.1 (JET) <sup>(f)</sup>	1500 (>400)
max. auxiliary heating power, (MW)	20 (AUG)	<32 (JET)	100 (50)
max. radiation from plasma core, (MW)	8 (AUG)	5-10 (JET)	-120 (≤30)
power entering the SOL, (MW)	15 (AUG)	10-15 (JET)	400 (120)
parallel power flux in the SOL, (MW-m <sup>-2</sup> )	>150 (AUG)	100-200 (JET)	2100
radial power e-folding distance, (m)	3-5x10 <sup>-3</sup> (AUG)	(1-1.2)x10 <sup>-2</sup>	-9 x10 <sup>-3</sup>
upstream plasma density, (m <sup>-3</sup> )	0.5-1.5x10 <sup>20</sup> (AUG)	-0.9x10 <sup>20</sup> (JET)	1x10 <sup>20</sup>
peak div. power loads w. and w/o rad., (MW-m <sup>-2</sup> )	≥1-2 (5-10)	≥1-2 (5-10)	5-10/(20-30)
active cooling of PFCs	no	Only divertor (JET)	Yes
baking temperature, (K)	420 (AUG)	>570 (JET/JT-60U)	510
divertor pumping, (m <sup>3</sup> -s <sup>-1</sup> )	-80 (AUG)	130 (JET)	200 (70)
pulse duration (inductive), (s)	<10	<25 (10div) JET	≥ 1000 (300-500)
typical number of pulses per day	20 (AUG)	20-30 (JET)	≥10
cumulative run time, (s/operation year)	-7000 (AUG)	-20000- 30000 (JET)	> 1x10 <sup>6</sup>
duty cycle	≤10 <sup>-3</sup>	≤3x10 <sup>-3</sup>	-10%
peak (net) divertor erosion rate, (nm/s)	3-10 (DIII-D)	1-10	16 (7)
D (T) quantity introduced per pulse, (g)	0.03 (AUG)	-0.2 (JET)	300 (120)
D/T wall retention, (% fuelling rate)	10-40 (AUG)	10-40 (JET)	2-10 g/pulse
tritium removal from co-deposited films	not required	required	Required
authorised on-site tritium inventory, (g)	-	5 (TFTR)-90 (JET)	≥4000
authorised in-vessel tritium inventory, (g)	-	2 (TFTR)-20 (JET)	≤1000 (450)
peak DT (14 MeV) neutron rate, (n/s)	-	1.2x10 <sup>17</sup> (JET)	5.3x10 <sup>18</sup>
peak 14 MeV neutron flux, (neutrons-m <sup>-2</sup> -s <sup>-1</sup> )	-	-6x10 <sup>16</sup> (JET)	-4.4x10 <sup>17</sup> (-2x10 <sup>17</sup> )
lifetime neutron fluence, (MW-yr-m <sup>-2</sup> )	-	-0.001 (JET)	-1.0 (-0.3)
remote handling maintenance	no	Yes	Yes

\* denotes maximum values;

(a) examples: Alcator C-Mod, DIII-D, ASDEX-U (AUG), etc.;

(b) examples: JET, TFTR, JT-60U;

(c) refers to the 1998 ITER design option (see text);

(d) range of parameters (shown in brackets) are also given, where available, for the design of ITER-FEAT (see text);

(e) Q of 0.62 was achieved transiently;

(f) >10 MW for 0.7 s; > 4MW for 3.5 s.

Table 4. Type, range of parameters and major consequences of plasma transient events in the ITER design. The numbers refer to the 1998 ITER design and where available (in parenthesis) to the ITER-FEAT design.

Event	Key Characteristics	Major Consequence(s) and/or comment(s)
Disruptions	frequency: ~10-30%; thermal energy=1GJ (0.35GJ); thermal quench time:1-10 ms; magnetic energy=1GJ (0.31GJ); current quench time: 50-1000 ms; max. current decay rate: 500 MA/s.	- vaporisation (and also melting for metals) of divertor targets, and nearby surfaces; - during the thermal quench, 80-100% of the thermal energy ( $W_{th}$ ) is transported by conduction to divertor; $\leq 30\%$ by radiation to first-wall or baffle; - during the ensuing current quench phase, 80-100 % of the energy is transferred to the first-wall by radiation, with a poloidal peaking factor of ~2; $\leq 20\%$ by conduction and localised radiation during VDEs; - initiates VDE and runaway conversion.
VDEs	duration = plasma quench; direction = up or down (depending on changes of plasma current and inductance); halo current $\leq 40\%$ .	- follows each disruption; - slow current quench -> worst VDE; - part of the magnetic energy ( $W_{mag}$ ) is lost to the first-wall; - produces in-vessel halo currents and forces on in-vessel components.
Loss-of-equilibrium-control VDE	frequency: 1% of pulses drift = 1-5 s to wall contact onset; first-wall contact initiates H-mode loss, $W_{th}$ loss, melting, rapid current quench or disruption	- initiated by poloidal field control failure; - electromagnetic effects (halo current/vertical force); - major thermal effects on first-wall; - affected first-wall region: upper/inside or divertor entrance baffles.
Runaway current conversion	knock-on avalanche, $E = 10-15$ MeV, up to 15 MA, $W_{th} = 500$ MJ ( $W_{th} = 60$ MJ for ITER FEAT)	- many uncertainties (see text); - toroidal localisation depends on first-wall alignment; - shutdown species will influence runaway electrons current.
Fast shutdown (active control)	$\tau_{th}, \tau_{mag} \leq 1$ s; by impurity or H/D injection.	- fast plasma power and current shutdown means for thermal protection of the first-wall and divertor targets; - by impurity or D injection; D favoured to minimize runaway conversion.
ELMs Type-I or Giant ELMs	frequency: 2-0.5 Hz, $\Delta W_{th}/W_{th} \sim 2-6\%$ deposition time: 0.1-1 ms; Type-I (giant ELM) longer duration, higher energy content, $\Delta W_{th}/W_{th} > 3\%$	- Type-I and Type-III ELMs are frequently observed; - ~50-80% of the energy lost from the core plasma is observed to strike the divertor target (e.g., in DIII-D, ASDEX-U); - JET, DIII-D, AUG reported inboard energies, 2-4 times that on outer divertor (see text for further details).
ELMs Type-II	frequency: high; amplitude: small	- associated with high triangularity plasma configurations; - database for Type-II ELMs is too small for use in ITER design.
ELMs Type-III	$\Delta W_{th}/W_{th}$ is a factor 5-10 less than for Type-I ELMs.	- Type-III are fairly universally observed; - prevalent in regimes associated with detached divertor operation and at heating power near the H-mode threshold power, both of which are relevant to ITER operation; - have a small amplitude and should not be a concern for erosion.



Review: Plasma-material interactions

Table 5. Tritium in current facilities and future devices.

Parameters	TFTR			JET		Next-Step <sup>(a)</sup>
	1993-95	1996	1997	1991	1997	
Year	1993-95	1996	1997	1991	1997	
Peak fusion power, MW	10.7	8.5	7.8	1.8	-16	500-1500
Total discharge duration, s	8	4.2	6.5	10-30	20-30	300-1000
Total number of discharges	14724	5324	3619	2	~593	>104
Discharges with NBI	6134	2167	1609	2	>50%	—
Discharges with tritium NBI	500	124	107	2	~134	—
Typical # of tritium pulses per day	0 - 5	0 - 5	0 - 5	—	10	10-20
T processed by facility (g)	73	17	15	0.1	100	—
T introduced in the torus and NBIs (g)	3.3	0.84	1.1	0.005	35(b)	—
T introduced per pulse (g/pulse)	<0.048	<0.01	<0.014	—	<0.25	50-200
T inventory in the torus and NBIs (g)	1.7	1.6	1.8	0.004	11.5(e)	—
Avg. retention (excluding clean-up)	51%(d)	51%(d)	51%(d)	—	40%	<10%
Increment of tritium inventory (g)	1.7	0.81	0.76	0.004	11.5(e)	<20 g/pulse
T removed during clean-up period (g)	0.96	0.49	0.98	0.0045	5.5(e)	90%(f)
T remaining at end of clean-up period (g)	0.74	1.06	0.85	—	-6(e)	—
T permitted in the vessel (g)	2			20 (first-wall) 11 (cryopumps)		~1000(g)
T permitted on site (g)	5			90		~4000(g)
Fuel cycle	closed			closed		closed
Exhaust processing	batch			batch		semicontinuous
Breeding blanket	N/A			N/A		Test modules(h)

(a) Estimated values.

(b) 0.6 g by NBI and the rest by gas puffing.

(c) This was the tritium inventory in all systems outside the active gas handling system (AGHS) (i.e., NBIs, torus), but individual analysis of batches of gas from the different subsystems indicate that the torus contributes >90% of the inventory (see Sect. 4.7).

(d) This is an average value over the period 93-97, excluding dedicated tritium removal campaigns.

(e) Some clean-up was also done in the middle of DTE1, in order to repair a small water leak in the fast shutter of the neutral beam. At that time 11.4g of T<sub>2</sub> had been introduced into the torus and about 4.6 g of tritium was retained on the walls. The wall load was reduced to 2.3g in a four-day period with ~120 pulses.

(f) Design target.

(g) Significant uncertainties still exist.

(h) It is expected that installation of a tritium breeding blanket capable of replenishing at least in part the tritium that is consumed will not be required in a next-step experimental fusion facility, at least at the outset. Required breeding blanket technology development will be carried out in a next-step device mainly through installation of breeding blanket test modules, introduced through vessel ports specifically allocated and instrumented for this purpose.

Table 6. Identified advantages and shortcomings of candidate armour materials that are considered for the design of the ITER reactor.

Advantages	Shortcomings	Required R&D
<b>Carbon-Fibre Composites (CFCs)</b>		
<ul style="list-style-type: none"> <li>• good power handling, good thermal shock and thermal fatigue resistance (low crack propagation);</li> <li>• does not melt (but sublimes) and preserves its shape even under extreme temperature excursions;</li> <li>• low radiative power losses with influx to plasma due to low Z;</li> <li>• well established joining technology;</li> <li>• broad tokamak operation experience;</li> <li>• in existing tokamaks, C erosion plays a beneficial role because of the reduction of the target power by radiation cooling of the divertor plasma. C radiates efficiently for temperatures down to <math>-5eV</math>.</li> </ul>	<ul style="list-style-type: none"> <li>• requires conditioning;</li> <li>• chemical erosion leads to reduction of erosion lifetimes;</li> <li>• chemical erosion leads to co-deposition of tritium with eroded carbon;</li> <li>• possible high erosion under disruption loads due to brittle destruction;</li> <li>• generates dust;</li> </ul>	<ul style="list-style-type: none"> <li>• in-situ removal of tritium from co-deposited films on plasma-facing surfaces with minimal impact on machine availability;</li> <li>• C-mixed materials effects;</li> <li>• chemical erosion yield of carbon at relevant plasma edge conditions;</li> <li>• investigation of 'brittle destruction' under relevant disruption loads.</li> </ul>
<b>Beryllium</b>		
<ul style="list-style-type: none"> <li>• good oxygen gettering ability;</li> <li>• limited tokamak practice (mainly JET);</li> <li>• because of low Z, low risk of plasma contamination due to impurities and low radiative power losses;</li> <li>• reparability by plasma-spraying;</li> <li>• well established joining technology;</li> <li>• low tritium inventory.</li> </ul>	<ul style="list-style-type: none"> <li>• reduced power-handling capability and resistance to disruptions because of the low melting temperature and high vapour pressure;</li> <li>• high physical sputtering yield;</li> <li>• toxic - requires controlled handling procedures;</li> <li>• co-deposition of tritium with beryllium could be significant if the fraction of co-deposited O impurities is large or in the presence of carbon-mixing effects;</li> <li>• Properties of thick BeO layers (from gettering) are not known.</li> </ul>	<ul style="list-style-type: none"> <li>• removal of tritium from thick oxidised layers;</li> <li>• C-Be mixed materials effects;</li> <li>• demonstration of in-situ reparability;</li> <li>• saturation of gettering capability due to the build up of thick oxide layers;</li> <li>• continue dedicated experiments with Be-clad PFCs in tokamaks (e.g., Be first-wall experiment in JET).</li> </ul>
<b>Tungsten</b>		
<ul style="list-style-type: none"> <li>• low physical sputtering yield and high sputtering threshold energy;</li> <li>• no chemical sputtering in H-plasma;</li> <li>• the tritium inventory of tungsten is expected to be small. W does not co-deposit with H-isotopes;</li> <li>• reparability by plasma-spraying;</li> <li>• well established joining technology.</li> </ul>	<ul style="list-style-type: none"> <li>• low limit for plasma contamination due to high radiative losses;</li> <li>• chemical erosion due to oxygen impurity;</li> <li>• limited but promising recent tokamak experience (see Sect. 4);</li> <li>• melts under anticipated thermal quench disruption loads and Type-I ELMs at divertor plate;</li> <li>• unknown behaviour of melt layer under disruption loads;</li> <li>• re-crystallises (embrittles) at temperatures <math>&gt; 1500K</math>;</li> <li>• low edge temperatures required for low sputtering;</li> <li>• generates radioactive waste.</li> </ul>	<ul style="list-style-type: none"> <li>• stability/loss of melt layer under ITER disruption loads.</li> <li>• continue development/testing of W target featuring high heat flux capability;</li> <li>• C-W mixed materials effects;</li> <li>• expand coverage of W-clad PFCs in tokamaks;</li> <li>• study chemical erosion due to O in combination with H.</li> </ul>

Table 7. Estimated operation parameters used for the design of the ITER PFCs, as documented in the 1998 ITER design [117]. Where available, parameters of the reduced-size ITER-FEAT design [118, 133] are also included in parenthesis. Design specifications for off-normal events are summarised in Table 4.

Component/armour material/area/main design loads	Peak heat Flux <sup>(a)</sup> (MW·m <sup>-2</sup> )	Particle flux <sup>(a)</sup> (DT·m <sup>-2</sup> ·s <sup>-1</sup> )	Energy (eV)	Fast neutron flux <sup>(b)</sup> (n·m <sup>-2</sup> ·s <sup>-1</sup> )
First-wall/Be ~1000 {680} (m <sup>2</sup> ) – charge-exchange neutrals (E <sub>e</sub> < 100 eV); – radiative power from bremsstrahlung; – localised thermal, particle and electromagnetic loads during disruptions, VDE, runaway electrons <sup>††</sup> .	0.5	10 <sup>19</sup> –10 <sup>20</sup>	100–500	≤ 2.3 × 10 <sup>18</sup> { ≤ 1.3 × 10 <sup>18</sup> }
Start-up limiter/Be ~10 (m <sup>2</sup> ) – direct plasma interaction and high thermal during plasma-startup and shut-down.	– 8 <sup>(c)</sup>	10 <sup>21</sup> –10 <sup>22</sup>	“”	≤ 2.3 × 10 <sup>18</sup> { ≤ 1.3 × 10 <sup>18</sup> }
Divertor target (strike-points)/C ~75 {55} (m <sup>2</sup> ) – high thermal power and flux of particles; – deposition of energy during disruption, ELMs; – electromagnetic loads during disruptions.	< 10 <sup>(d)</sup> –20 <sup>(e)</sup>	< 10 <sup>(d)</sup>	1–30 (plasma temp.)	4–6 × 10 <sup>17</sup> { 2–3 × 10 <sup>17</sup> }
Divertor side-wall (baffle)/W ~200 {50} (m <sup>2</sup> ) – charge-exchange neutrals (E <sub>e</sub> < 100 eV); – direct interaction with SOL plasma; – radiative power from X-point (e.g., MARFES); – possible deposition of energy during ELMs; – reradiated energy during disruptions; – electromagnetic loads during disruptions.	3	10 <sup>20</sup> –10 <sup>22</sup>	> 30 (plasma temp.)	≤ 2 × 10 <sup>18</sup> { 1 × 10 <sup>18</sup> }
Divertor dome/W 85 {30} (m <sup>2</sup> ) – charge-exchange neutrals (E <sub>e</sub> < 100 eV); – radiative power from X-point (e.g., MARFES); – deposition of energy during VDE; – electromagnetic loads during disruptions.	3	10 <sup>21</sup> –10 <sup>22</sup>	> 30 (plasma temp.)	≤ 1.1 × 10 <sup>18</sup> { 9 × 10 <sup>17</sup> }
Divertor private region (liner)/W 90 {60} (m <sup>2</sup> ) – radiative power dissipated in the divertor; – reradiated energy during disruptions; – electromagnetic loads during disruptions.	< 1	< 10 <sup>(d)</sup>	< 1	– 4 × 10 <sup>17</sup> { 2 × 10 <sup>17</sup> }

The pulse duration in the 1998 ITER design was 1000 s while in the ITER-FEAT design is 400 s. For the first-wall no replacement is anticipated during operation (~30000 pulses) and up to 8 replacements for the divertor.

(a) Design values.

(b) E < 0.1 MeV.

(c) During start-up. During flat-top burn the limiter will experience the same load as the primary first-wall.

(d) Peak load expected during normal semi-detached conditions.

(e) Peak load expected during off-normal transients (10% frequency, ~10 s duration).

†† Protection of the first-wall against VDEs and runaway electrons could also be achieved by introducing a series of poloidal protection limiter.

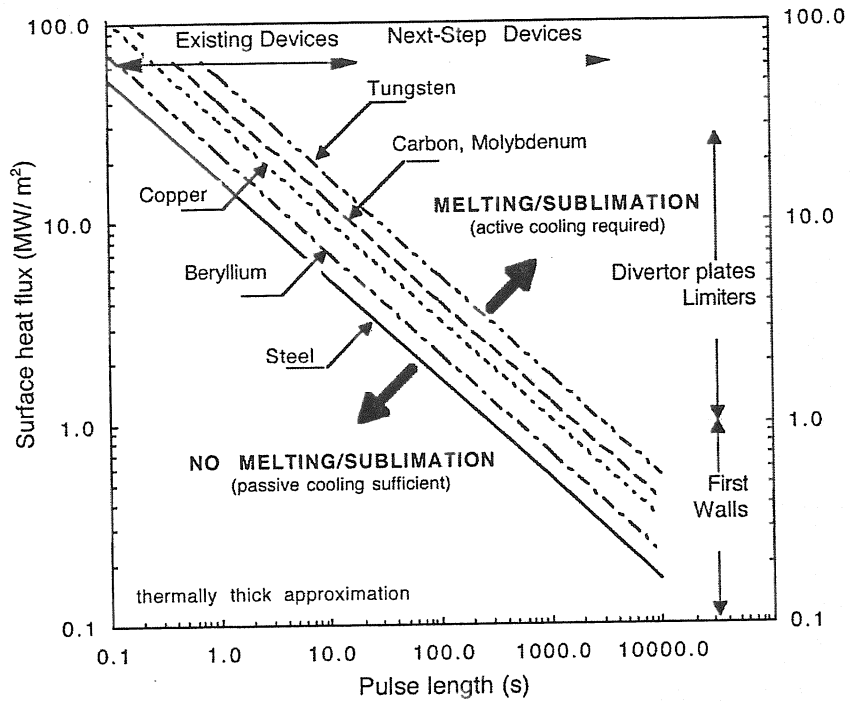

Figure 3. Combination of surface heat flux and pulse length required to vaporise the surface of an uncooled "thermally-thick" material.

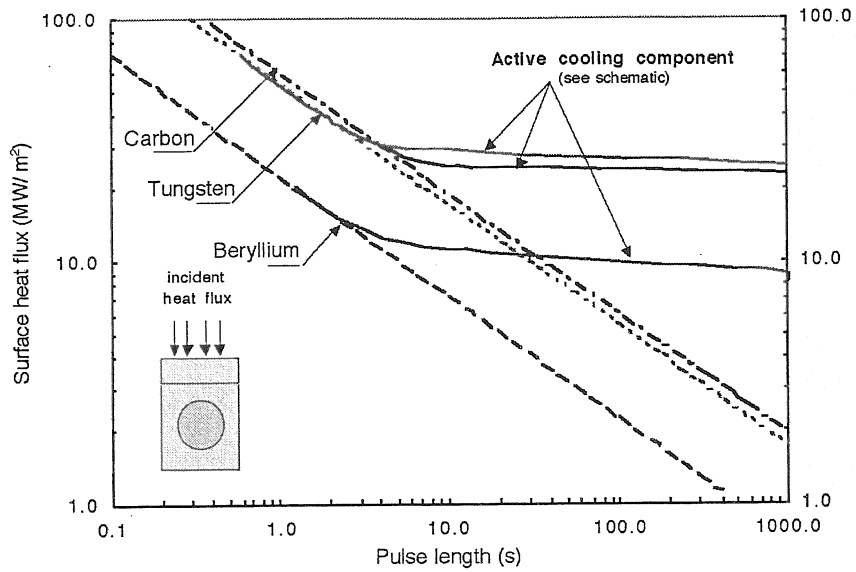

Figure 4. Dependence of the surface heat flux that produces melting of Be, and W and sublimation of C, on the pulse length, for case (a) with dashed lines of an uncooled "thermally-thick" material, and (b) with continuous lines of a typical actively cooled divertor component.

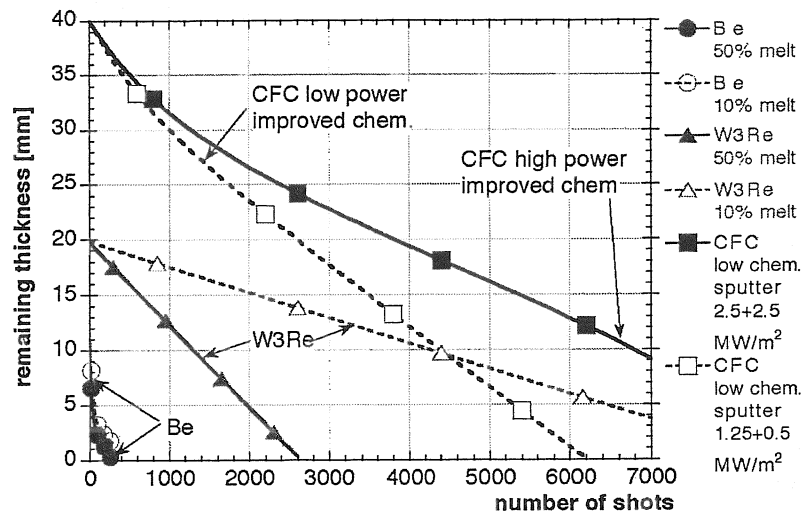

Figure 5. Remaining thickness vs. shots for Be, CFC, and W alloy (W3Re used here) at a nominal power of  $5 \text{ MW}\cdot\text{m}^{-2}$  (90% re-deposition). The curves for CFC refer to two cases: high-power -  $Q_{ion}=2.5 \text{ MW}\cdot\text{m}^{-2}$  and  $Q_{rad}=2.5 \text{ MW}\cdot\text{m}^{-2}$ ; and low-power -  $Q_{ion}=1.25 \text{ MW}\cdot\text{m}^{-2}$  and  $Q_{rad}=0.5 \text{ MW}\cdot\text{m}^{-2}$ . Melt loss varied for metals and two cases were analysed with 10% and 50% melt loss, respectively. See text for assumptions on initial thickness; (reproduced with permission from [154]).

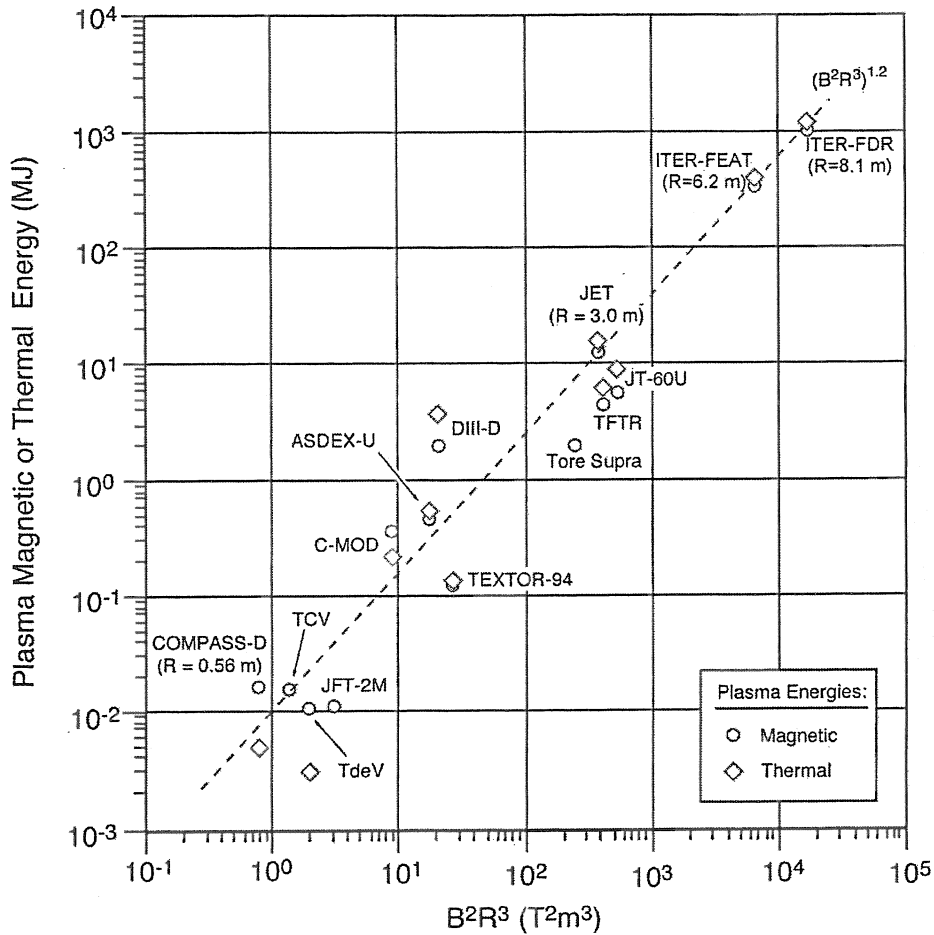

Figure 6. Plasma magnetic and thermal energies in tokamaks. Magnetic and thermal data are not necessarily simultaneous. Magnetic energies are estimated from major radius,  $R$ , minor radius,  $a$ , plasma elongation,  $k$  (see glossary), and toroidal field,  $B_T$ , and assume a safety factor,  $q_{95} \approx 3$ . Energy shown is only internal plasma energy: magnetic energy outside the plasma is not included. Thermal energies are derived from Refs. [165, 167]. Relative auxiliary heating, and hence plasma energy capabilities, vary among experiments. The  $(B^2R^3)^{1.2}$  'scaling' fit is empirical and has been drawn by eye. Data are for the 1998 ITER design (labelled as ITER-FDR) and the most recent ITER-FEAT design parameters. The increase in  $W_{mag}/R^2$  and  $W_{th}/R^2$  from COMPASS-D to the 1998 ITER design is about 70. This applies for the scaling of radiation of thermal energy to the first-wall. For divertor thermal energy deposition, if one assumes a fixed SOL width, then the increase in energy loading per unit area from JT-60U and JET to the 1998 ITER design scales as  $W_{th}/R$  and increases by about 40; (figure provided by J. Wesley of General Atomics).

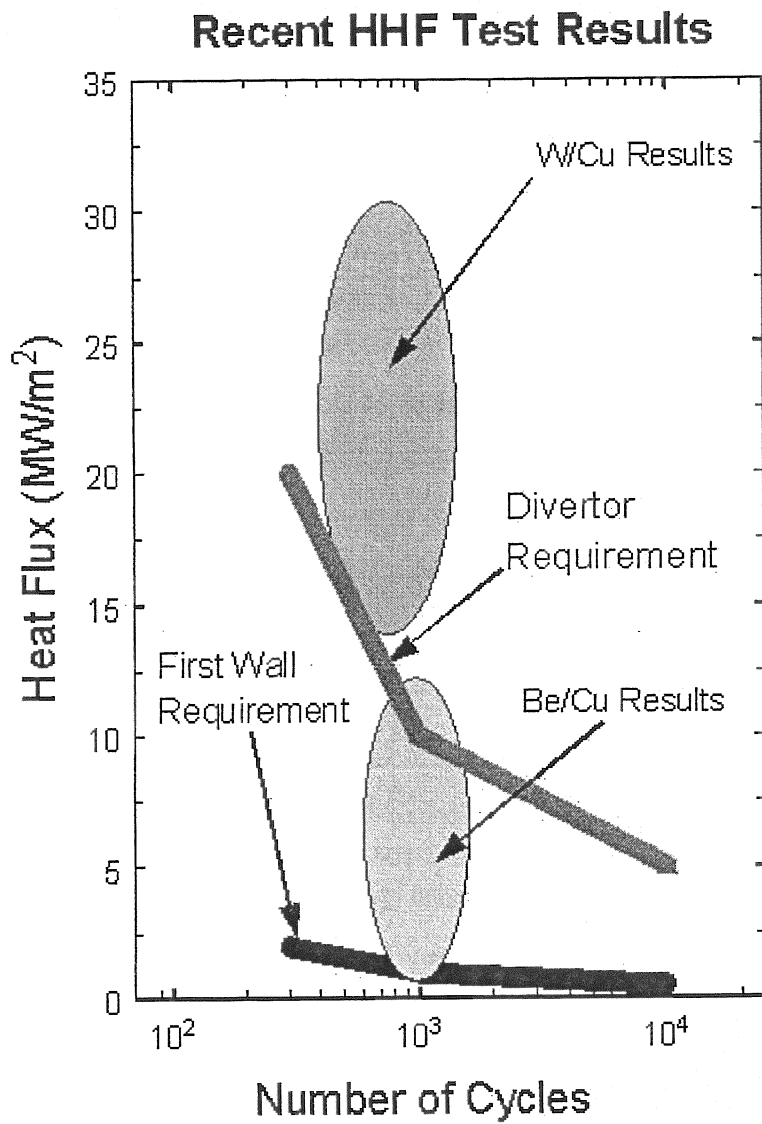

Figure 7. High-heat-flux test results: Heat flux vs. number of cycles for prototypical W/Cu and Be/Cu high-heat-flux components; (figure provided by M. Ulrickson Sandia National Laboratory [256].)



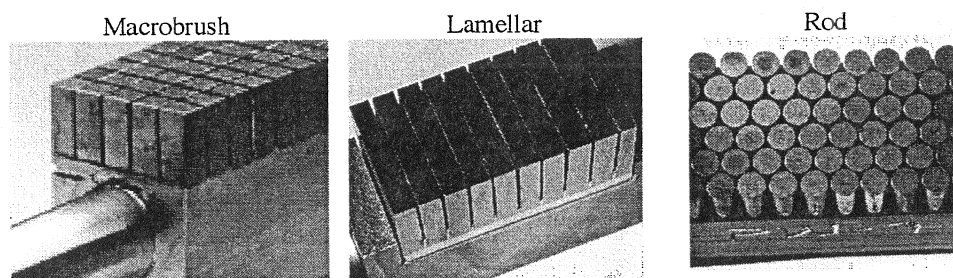

Figure 8. Castellated armour concepts for tungsten-armoured high heat flux components; (figure provided by Vladimir Barabash, ITER JCT.)

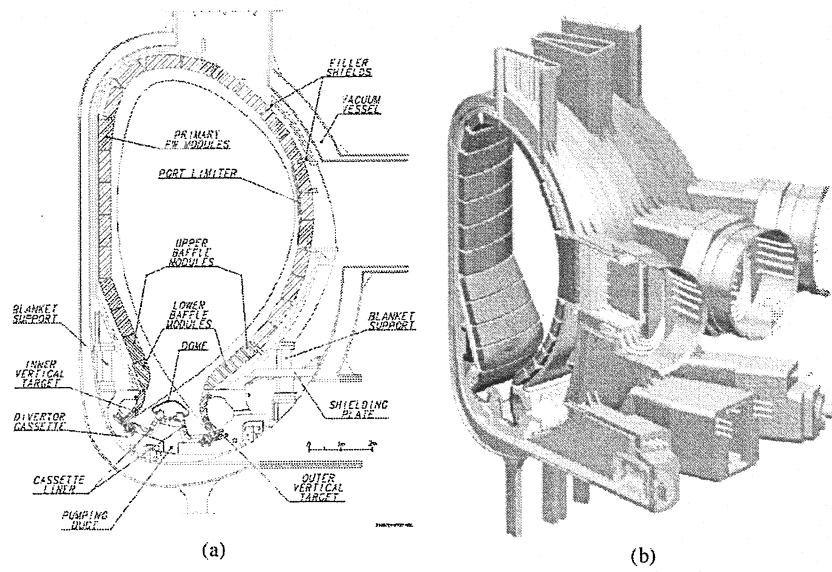
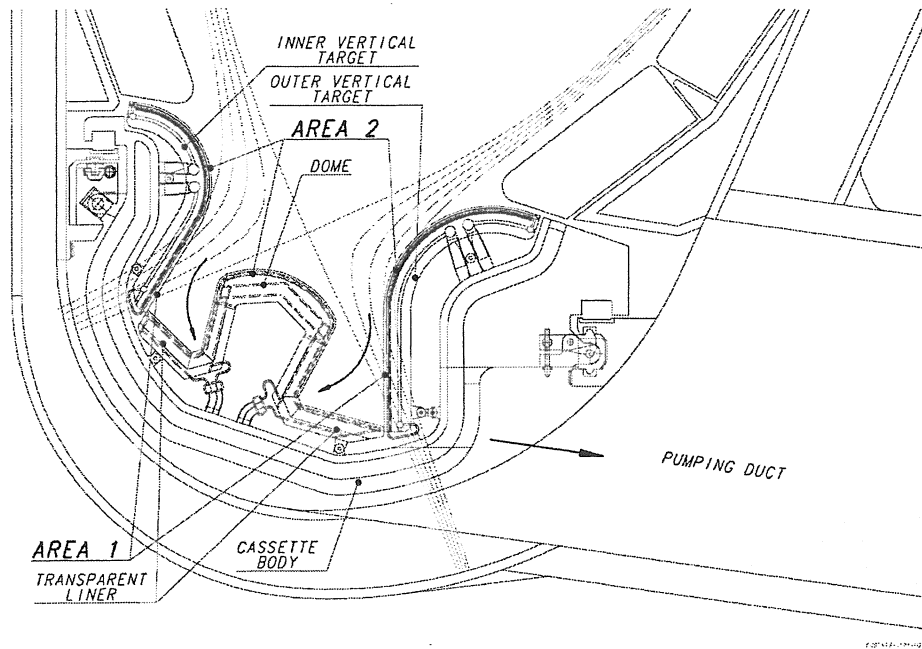

Figure 9. (a) Cross-sectional view and (b) isometric view of the vessel of the 1998 ITER design showing blanket and divertor.



**Figure 10.** Poloidal cross-section through the divertor of the ITER-Feat design. Area (1) at the divertor strike-zones receives high thermal power and flux of particles, deposition of energy during ELMs, high thermal (direct plasma impact) and electromagnetic loads during disruptions. Area (2), which consists of the baffle, the dome, and the liner in the private flux region, receives low heat flux and high charge-exchange neutral fluxes. Some parts are subject to direct interaction with the SOL plasma, radiative power from X-point, and possible deposition of re-radiated energy during disruptions and mechanical loads due to eddy and halo currents (see glossary).

### 3. REVIEW OF PHYSICAL PROCESSES AND UNDERLYING THEORY

#### 3.1. Introduction

Controlling PMIs in current tokamaks and predicting their effects in next-step fusion reactors requires detailed understanding of physical mechanisms involved. Many of the underlying physical processes such as sputtering, implantation, diffusion and trapping of hydrogen have been studied for many years and are fairly well understood. However, the development and validation of reliable models to simulate the effects of PMIs in tokamaks is still in progress. This section introduces the main physical processes involved in PMIs and the plasma-material models describing these processes. Sect. 5 describes how these models are used together with plasma-edge models to simulate the effects of PMIs on the plasma, and on PFCs, in present tokamaks and next-step fusion reactors. Selected data are presented to illustrate some of the processes and models discussed.

#### 3.2. Sputtering Erosion/Re-deposition Processes

Erosion due to energetic particle bombardment depends on the mass ratio of incident particles to surface atoms, the particle energy and flux density, the surface temperature, and other factors. The physical understanding of erosion mechanisms in fusion devices, together with supporting data from laboratory experiments, is presented below.

##### 3.2.1. Physical sputtering

Physical sputtering results from elastic energy transfer from incident particles to target atoms. Surface atoms can be ejected if they receive enough energy to overcome the surface binding energy  $E_s$ , be it directly from bombarding ions or through a collision cascade involving other target atoms. The sputtering yield is proportional to the energy deposited in elastic collisions within a near-surface layer. At low ion energies, where the transferred energy to surface atoms is comparable with the surface binding energy, the sputtering yield decreases strongly and becomes zero below a threshold energy. For plasma-facing materials, such as Be, C, and W, erosion data exist for H, D and He in the energy range from 10 eV up to 10 keV [266, 267]. The data are extended to higher energies and to T by computer simulation [267, 268].

Physical sputtering is a well-understood erosion process and a sound physical theory exists for it [269, 271]. For light ions incident on heavy materials, the threshold energy,  $E_{th}$ , is determined by the energy which can be transferred to target atoms and can be analytically approximated by:

$$E_{th} = \frac{(M_1 + M_2)^4}{4M_1M_2(M_1 - M_2)^2} E_s \quad (4)$$

where  $M_1$  and  $M_2$  are the incident particle mass and target mass respectively, and  $E_s$  is the surface binding energy [268].

The energy dependence of the yield,  $Y$ , at normal incidence can be described by the following expression:

$$Y = QS_n(E) \left(1 - \frac{E_{th}}{E}\right)^2 \left(1 - \left(\frac{E_{th}}{E}\right)^{\frac{2}{3}}\right) \quad (5)$$

where  $S_n(E)$  is the function for the energy dependence of the energy deposited in elastic collisions [270]. Values for the fitting parameters  $Q$  and  $E_{th}$  are tabulated for many ion-target combinations [267]. At grazing incidence the erosion yield is enhanced relative to the yield at normal incidence, as more energy is deposited within the near-surface layer. The dependence on angle of incidence is well described theoretically for light ions [272], and parameter fits exist for light and heavy ions [267]. Surface roughness tends to reduce the pronounced dependence of the sputtering yield on angle of incidence. This has been demonstrated and interpreted in Monte-Carlo simulations for different kinds of graphite materials [273] and beryllium [274]. Physical sputtering does not depend on surface temperature [275].

For Be and W, experimental data and the fit for the sputtering yield at normal incidence are shown in Fig. 11 for D ions as a function of incident particle energy. Physical sputtering data are available for both materials from energies close to the threshold energy (9 eV for D on Be and 200 eV for D on W) up to the high keV range [267, 276, 277]. Similar data exist for H and He ion bombardment. All data shown were obtained from the weight loss of polished samples after ion bombardment. In the case of Be, clean surfaces could only be obtained at temperatures above 900 K where Be diffuses through the surface oxide layer [278]; at lower temperatures, oxidation from the residual gas reduced the erosion yield [267]. For carbon-based materials, physical sputtering is only dominant for non-reactive ion bombardment, e.g.,  $\text{He}^+$  or  $\text{C}^+$ . For reactive species such as hydrogen and oxygen, the formation of hydrocarbons, CO and  $\text{CO}_2$  lead to enhanced erosion yields, even at room temperature (Sects. 3.2.3 and 3.2.4). The high threshold energy for sputtering of W reduces the yields drastically at energies below 1000 eV. Ion energies in the divertor are expected to be in the 20 to 100 eV range, and charge-exchange neutrals have their maximum below 20 eV. Even for the low- $Z$  elements carbon and beryllium, the threshold energy is high enough to strongly reduce physical sputtering by deuterium.

*Insert Fig. 11*

However, the situation is different for heavier incident ions, such as Be, C, O or W that can transfer almost all their energy onto target atoms. In this case, the threshold energy is determined by the energy loss in inelastic stopping of atoms inside the target [271] and is about 30 eV for carbon, of the order of the surface binding energy  $E_s$ .

Additionally, the incident impurity ions in a fusion device will be multiply charged, e.g., a charge-state of 4 can be assumed for Be, C, O, and even higher for W ions. The increased acceleration of these ions in the sheath potential of a divertor plasma with  $T_e=10$  eV will result in incident energies around 200 eV, well above the threshold energy.

Data for the sputtering yield of impurity ions, such as C, O, Be, and W ions, for C-based materials are shown in Fig. 12 from TRIM-SP calculations [279]. No experimental

data are available for Be and W bombardment. The erosion processes for  $C^+$ ,  $Be^+$  and  $W^+$  are predominantly due to physical sputtering. Chemical effects may contribute through the reaction with oxygen. In the case of carbon, CO formation enhances the erosion yield (Sect. 3.2.4).

Carbon bombardment, in general, leads to the deposition of protective surface layers (Sect. 4.3.4). Only in conditions where carbon self-sputtering exceeds unity, i.e., at grazing incidence or at temperatures above  $\approx 1800$  K, could a few yield data points be obtained for clean W surfaces.

*Insert Fig. 12*

*Refs. [279–281] appear in the caption of Fig. 12 They are reported here to maintain consistent reference sequential numbering while appending the figures at the end of the section.*

### 3.2.2. Non-recycling impurities

At high fluences, metal and carbon impurity ions can form a solid layer on top of the substrate, protecting it from further erosion. While for low coverage the sputtering yield of the deposited atoms is influenced by the substrate material, the conditions for steady-state erosion or deposition depend on the self-sputtering yield of the incident ions. At ion energies or angles of incidence, where the self-sputtering yield increases above unity, this protecting effect disappears and erosion continues, being only partially reduced due to dilution in the implanted layer [282, 283]. For the case of sputtering of W by C ions, Fig. 13 shows the weight change of the sample, as a function of fluence, for different angles of incidence. While after an initial weight loss a continuous weight increase is observed for normal incidence, at angles of incidence larger than  $40^\circ$  a continuous erosion occurs [283]. This angle of  $40^\circ$  is just the angle of incidence where the self-sputtering of carbon increases above unity [281]. The conditions where net erosion turns into net deposition may further be complicated by changes of surface temperature and hence self-sputtering yield, by RES or by the diffusion and surface segregation of implanted impurities. In a tokamak, particles incident on a divertor plate, for example, have ranges of incident angles and energies, and this complicates predictions of erosion/net deposition (Sect. 3.2.6).

The erosion properties of layers formed during bombardment with non-recycling ions and effects due to simultaneous bombardment with different ions will be discussed in Sects. 3.2.6.2 and 3.2.6.3.

*Insert Fig. 13*

### 3.2.3. Chemical erosion due to hydrogen isotopes

For carbon, chemical reactions with incident hydrogen ions lead to the formation of volatile hydrocarbon molecules or to loosely bound hydrocarbon precursors which can be sputtered with a much lower threshold energy. Chemical erosion is a complicated multi-step process that depends on particle energy and flux, surface temperature and material properties such as crystalline structure, and may be influenced by impurity atoms in the lattice.

Chemical erosion with hydrogen isotope ions dominates at low ion energies, i.e., below 100 eV, and at elevated temperatures. It is also found during simultaneous bombardment with inert gas or self-ions and thermal atomic hydrogen atoms. The process has been reviewed recently [280, 284, 285], and only a short discussion will be presented here. Chemical erosion data have been compiled recently in a comprehensive report [286].

Carbon interacts with thermal atomic hydrogen over a broad temperature range, extending down to room temperature [287]. Surface atoms not embedded in a perfect crystal lattice will be hydrogenated up to  $\text{CH}_3$  with one remaining bond to the graphitic lattice. At room temperature, no further reaction occurs with thermal atomic hydrogen, but sputtering of this fully hydrogenated surface by low-energy ions proceeds with a much reduced threshold energy of about 2 eV [285, 288]. Increasing the surface temperature above 400 K results in a thermal release of hydrocarbons, especially  $\text{CH}_4$ , but heavier hydrocarbons are also observed.  $\text{CH}_3$  hydrocarbon precursors neighbouring a free carbon atom may be emitted by simultaneously reforming a graphitic carbon-carbon bond [287]. At temperatures above 600 K, hydrogen molecular recombination occurs before complete hydrogenation of the surface, thus reducing the chemical erosion reaction. The combined processes lead to the pronounced maximum of the thermal chemical erosion with surface temperature.

Fig. 14 shows a typical temperature dependence of the total chemical erosion yield, measured via weight loss, of pyrolytic graphite for energies ranging from 15 eV to 300 eV [289]. Similar plots have been obtained for the various hydrocarbon yields [288]. Upon comparison of the mass-loss data [289] and the mass-spectroscopic data (sum of hydrocarbons measured in the residual gas) [288], we note two key differences. (i) At energies below  $\approx 100$  eV, the mass-loss data are generally higher, possibly due to sticking of emitted hydrocarbon radicals to the analysis chamber wall before they can be measured (RGA signals are reduced [289]). For 15 eV  $\text{D}^+$  impact at 300 K graphite temperature, the difference is about a factor of 4 (see Fig. 15) and is probably due to this effect. (ii) The total chemical erosion yields due to  $\text{H}^+$  and  $\text{D}^+$ , measured by mass spectroscopy, differ by less than a factor of 2, while mass-loss measurements, show a factor of 4-5 difference, with  $\text{D}^+$  being higher in both cases [288]. The question remains why more D-containing radicals are produced and why the D-containing molecules stick more efficiently to the chamber walls.

Chemical erosion by thermal atomic hydrogen, with a maximum yield around 600-800 K, is strongly dependent on the crystalline structure of the surface. The erosion yield ranges from  $10^{-3}$  for pyrolytic graphite to  $10^{-1}$  for amorphous hydrogenated carbon layers, a-C:H [290, 291]. This dependence on the surface structure vanishes for ion energies above 30 eV where radiation damage (see glossary) amorphises the graphite lattice and enhances the yield [288]. The combined effect of thermal atomic hydrogen and energetic inert ions can lead to chemical erosion yields equivalent to energetic hydrogen bombardment [280, 292].

*Insert Fig. 14*

The chemical erosion yield has been described by analytic equations, with the full parameter dependence taken into account [293, 294]. This work has recently been improved by new data on low ion energy [288] and high flux yields [285]. The models developed for energetic

ion impact on carbon [293, 294] are extensions of the thermal atom impact model of Horn et al. [287]. Experimental erosion yields for D ions from weight loss and mass spectroscopy are compared to the calculated energy dependence at room temperature and at the temperature where chemical erosion is a maximum,  $T_{max}$ , in Fig. 15. The room temperature data show a much lower threshold energy than for physical sputtering, possibly due to the sputtering of loosely bound hydrocarbon precursors.

*Insert Fig. 15*

During the past two years, chemical erosion studies have concentrated on the investigation of the dependence of chemical erosion on hydrogen flux, which ranges from about  $10^{20} \text{ m}^{-2}\cdot\text{s}^{-1}$ , for charge-exchange neutrals at the wall, to  $10^{24} \text{ m}^{-2}\cdot\text{s}^{-1}$  at the divertor plate. The mechanism involving hydrogenation of carbon atoms, thermal release of hydrocarbon radicals and hydrogen molecule recombination [287] inherently shows a pronounced shift of the temperature of maximum yield,  $T_{max}$ , with ion flux [293], but no strong decrease of the yield at  $T_{max}$ . However, as the flux exceeds  $10^{22} \text{ m}^{-2}\cdot\text{s}^{-1}$  and  $T_{max}$  reaches 900 K, no further increase of  $T_{max}$  occurs and an apparent decrease in  $Y_{max}$  is observed. Several mechanisms have been proposed for this flux dependence [285, 293]. While the available models provide insight into the mechanisms leading to hydrocarbon formation, a major shortcoming at present is their inability to predict the flux dependence. Attempts have been made, however, to incorporate flux dependence by adding a flux-sensitive term as discussed in [285]. This will be discussed in more detail in Sect. 4.3. For many years, only scattered yield data were available from tokamaks or plasma simulators [280], where the emission of hydrocarbons were observed spectroscopically from the C-D band intensity, always showing much smaller yields than for low flux ion-beam irradiation. However, remaining uncertainties in the determination of the incident hydrogen flux and energy, as well as the uncertainties in the emitted hydrocarbon flux, made firm conclusions impossible. In particular, the complicated ionisation-dissociation chain in the break-up of hydrocarbon molecules to the finally detected CD radicals led to large uncertainties of the excitation to dissociation ratio, D/XB.

Systematic studies of the flux effect of the chemical erosion yield have only recently been undertaken in plasma simulators [295, 296] and in the tokamak edge plasma [297–299]. Also, new attempts have been made to measure and calculate D/XB values as a function of plasma electron temperature [299, 300] and electron density [296]. Still, considerable systematic errors may exist, as the variation of ion flux often correlates with variations in plasma-edge temperatures and ion energies [297]. The extent to which parameters other than flux (e.g., energy, re-deposition, photon efficiency and viewing geometry in spectroscopic measurements, etc.) affect the observed erosion rates needs to be determined. However, these new data (Fig. 16) constitute a new quality in precision, and in particular, the relative error within one particular set of data (given, where available, by the error bars in Fig. 16) are small enough to make the interpretation in terms of a flux dependence possible. In Fig. 16, the erosion yield data, as a function of ion flux, are collected for room temperature (Fig. 16a) and for a temperature close to the maximum of the temperature dependence curve,  $T_{max}$  (Fig. 16b). Included in Fig. 16 are curves giving the predictions of an analytical model based



on low flux ion-beam data [293], and a refined model taking a possible flux dependence at high fluxes into account [285]. While most of the data show a decreasing trend with flux at high fluxes, this is not the case for the PISCES results [296]. It is also important to note that most of the spectroscopic yield data from tokamaks and laboratory plasma devices are based on the assumption that the methane photon efficiency for the CD band emission also applies to heavy hydrocarbons (i.e.,  $C_xH_y$  with  $x \geq 2$ ). It is anticipated that in-situ photon efficiency calibration for heavy hydrocarbon might affect the derived yields [301]. Therefore, the flux dependence of the chemical erosion yield of graphite at high fluxes is still an open question.

In Fig. 16a, spectroscopic data from ASDEX-Upgrade [298] are shown for temperatures near room temperature in comparison with ion-beam data measured by weight loss and mass spectroscopy [288, 289, 302, 303]. Under low energy and room temperature conditions, the previous modelling [293] of chemical sputtering did not predict any flux dependence. In contrast, the high flux data clearly show an apparent erosion yield decrease at fluxes above  $10^{22} \text{ m}^{-2}\cdot\text{s}^{-1}$ . Within the error bars of the data a flux dependence close to  $\Gamma^{-1}$  can be deduced.

Fig. 16b shows a similar comparison of ion-beam data [288, 289, 302, 303] with high flux results from the plasma simulators PSI-1 [295, 304] and PISCES [296, 305] (see glossary) for elevated temperatures close to  $T_{max}$ . Again, the data appear to be relatively insensitive to the ion flux up to a flux of  $10^{22} \text{ m}^{-2}\cdot\text{s}^{-1}$ , in accordance with the weak flux dependence from the previous model [293]. At higher fluxes, the yield appears to decrease steeply (except for the PISCES mass-loss data), reaching values below  $10^{-2}$  at  $2 \times 10^{23} \text{ m}^{-2}\cdot\text{s}^{-1}$ . The fact that both the room temperature and high temperature data show the same apparent yield decrease with flux, indicates that rehydration of the surface atoms after the release of a hydrocarbon molecule is the rate-limiting process, as both the low and the high temperature processes rely on a fast re-hydration of the surface [284]. The fact that the onset appears at about  $10^{22} \text{ m}^{-2}\cdot\text{s}^{-1}$  suggests a reaction time constant of the order of 1 ms [285]. Time constants for hydration of surface atoms of this order are actually deduced from the dependence of the hydrogen incorporation in the deposition rate during the growth of a-C:H layers [306].

*Insert Fig. 16*

#### 3.2.4. Chemical erosion due to oxygen

The oxygen impurity concentration in today's tokamaks is typically reduced to levels below 1% by beryllium evaporation and boronisation. If Be is used to protect the first-wall of a next-step device, such as in the ITER design, it can be expected that the large Be surface area will getter oxygen effectively, resulting in a relatively low oxygen concentration.

Oxygen ions will interact chemically with the divertor surfaces clad with C-based materials. CO and CO<sub>2</sub> formation, and total C-removal yields of the order of unity, without strong energy or temperature dependence, have been reported [280, 284, 307, 308]. The energy dependence of the O<sup>+</sup>-induced C erosion yield (collected in Ref. [280]) is presented

in Fig. 12 for comparison with the physical sputtering yields of other impurity ions. In the case of simultaneous  $H^+$  and  $O^+$  impact on carbon, a small amount of water is also produced, with a temperature dependence similar to that of  $CH_4$  formation, with peak yield at  $\approx 800$  K [309]. The total yield was reported to be in good agreement with the sum of the yields due to individual  $O^+$  and  $H^+$  impact.

For Be, an increase of surface binding energy occurs under oxygen bombardment, leading both to a decrease of the sputtering yield and to a shift of the threshold energy for sputtering to higher energies according to eq. (4). The data for deuterium sputtering of a fully oxidised BeO surface are given in Refs. [310, 311].

For W, the formation of oxides with high vapour pressure and consequently low surface binding energy, such as  $WO_3$ , is well known. However, the enhanced erosion due to  $WO_3$  appears to be a small effect that could not be observed during oxygen ion sputtering even at temperatures of up to 1900 K [312]. Sputtering by hydrogen isotopes near the sputtering threshold energy results in such small yield values, that the additional release of oxide molecules during simultaneous impact of hydrogen and oxygen can be observed [313]. This effect results in measurable erosion yields even below the threshold energy for sputtering of clean tungsten.

### 3.2.5. Radiation-enhanced sublimation (RES)

Another erosion process, unique for carbon - radiation-enhanced sublimation (RES) - has been observed in ion-beam experiments [314, 315]. RES results in the release of carbon atoms with a thermal velocity distribution [316] under ion irradiation. RES has recently been reviewed in Ref. [317].

During ion irradiation, not only surface atoms are displaced from their lattice sites but atom displacements also occur throughout the ion range when energies larger than about 25 eV are transferred in elastic collisions. In graphite, carbon atoms are very mobile between graphitic planes and atoms that escape recombination with vacancies can reach the surface and evaporate freely. A detailed analytic model taking defect production, diffusion, recombination and evaporation into account accurately reproduces the observed temperature dependence of the erosion yield [318]. Although RES exists already at room temperature [319], its yield is smaller than the physical sputtering yield below about 1500 K. At higher temperature, radiation-induced vacancies become mobile and an increasing number of displaced carbon atoms escape recombination and reach the surface. The erosion yield increases monotonically with surface temperature until above 2000 K normal sublimation dominates the erosion. Fig. 17 shows a collection of erosion data in the RES temperature regime. Attempts to reduce RES by doping the carbon material with impurities showed a shift of RES to higher temperature but, in general, no complete suppression has been achieved [320, 321]. Only in the one case, of Ti-doped carbons, has complete suppression of RES been reported (e.g., [322]), but independent confirmation of this finding is required.

The theoretical model of this process predicts a  $\Gamma^{-0.25}$  decrease with increasing flux [318, 319, 323, 324], somewhat steeper than ion-beam data suggest [318, 325, 326]. Carbon influx measurements in tokamaks, such as TFTR, JET [107] and Tore Supra [327], have

been interpreted as RES. The observation that the RES process could not be observed in a spectroscopic investigation at the TEXTOR test limiter [328] up to temperatures where thermal sublimation sets in, may be due to a possible decrease of RES with ion flux. Recent data from a high-flux plasma source [329] indicate a stronger flux dependence,  $\approx \Gamma^{-0.27}$ , than observed in ion-beam experiments, giving some support to the validity of the model.

*Insert Fig. 17*

*Ref. [330] appears in the caption of Fig. 17 and it is reported here to maintain consistent reference sequential numbering while appending the figures at the end of the section.*

### 3.2.6. Erosion under tokamak conditions

Energetic particle bombardment in fusion devices will not be monoenergetic as in laboratory simulations, but have a broad energy distribution. For example, in the case of charge-exchange neutrals impinging onto the vessel wall with energies ranging from below 20 eV to keV's, an estimate of the effective sputtering yield can be obtained by integrating over the whole energy distribution. Also, it is rare that only one ion species will impinge onto a wall component, and therefore, the effect of multi-particle bombardment has to be taken into account. Erosion properties of deposited layers and mixed-material layers also have to be considered.

#### 3.2.6.1. Erosion due to charge-exchange neutrals at the main chamber wall

Physical sputtering by energetic hydrogen isotopes dominates the erosion of metal PFCs (e.g., Be, W) at the main chamber wall and divertor baffle of a device like ITER. Re-deposition on these surfaces is negligible.

In order to evaluate the erosion by charge-exchange neutrals, an effective sputtering yield has to be calculated which takes the energy distribution of the charge-exchange neutrals into account [156, 331–333]. The energy distribution will differ strongly for different wall areas. The charge-exchange neutral energy distribution has been measured at a few locations in some tokamaks. Erosion by charge-exchange neutrals at other locations and for other plasma conditions can be estimated using charge-exchange neutral energy distributions from plasma-edge simulation codes such as B2/EIRENE (see for example Ref. [156]). In Fig. 18 the calculated energy distributions are shown for the charge-exchange neutral particles incident on the inner vessel wall and the baffle region in ASDEX-Upgrade. Typically, the energy distribution of charge-exchange neutrals peaks at low energies and decreases monotonically with increasing energy. Clearly, the high sputtering threshold energy of about 200 eV for W, compared to 9 eV for Be, will result in a drastically reduced effective erosion yield as most of the charge-exchange neutrals have energies below 200 eV and only the high energetic tail contributes to sputtering of W. On the other hand, for Be the effective erosion yield is determined mainly by the large flux of low-energy neutrals, and the high-energy tail does not contribute strongly. In ASDEX-Upgrade, a large variety of charge-exchange neutral energy distributions have been measured for different plasma conditions. Fig. 19 shows the

effective sputtering yields for C, Be and W, calculated by integrating over the whole energy distribution, plotted versus the average energy. For W, the yield increases strongly with increasing average energy, while for Be and C, the low energies dominate and the effective yield becomes insensitive to average energy. Chemical erosion of carbon tiles used in today's tokamaks as cladding of the main plasma chamber by charge-exchange neutrals, together with sputtering by edge plasma ions is the origin of a large carbon influx into the plasma [156, 334]. For conditions of low average energies, such as at the divertor baffle or in the divertor chamber, high-Z materials show erosion yields orders of magnitude lower than that seen for low-Z materials. For the high average energies at the main vessel walls, this erosion advantage of high-Z materials is reduced (Sect. 1.3.2).

Insert Fig. 18

Insert Fig. 19

### 3.2.6.2. Synergy between incident impurity and plasma ions

A further complication arises from consideration of the simultaneous impact of plasma ions together with small amounts (few %) of impurities. Both an increase and a decrease of the erosion yield is possible.

In the case of W erosion, the threshold energy for deuterium sputtering is about 200 eV. At plasma temperatures of 10 eV, typical for divertor conditions, no sputtering by deuterium occurs. However, at the same plasma temperatures, carbon ions, especially those multiply charged, do lead to W sputtering. At high carbon concentrations, carbon will form a protective layer on the W surface, while at low carbon concentrations, the simultaneously impinging deuterons can remove carbon from the surface, leaving W exposed for sputtering by carbon ions. The transition between erosion and re-deposition now depends not only on ion energy, i.e., plasma temperature, but very sensitively also on the concentration of C in the incident plasma flux. Fig. 20a shows the transition of erosion to deposition as a function of plasma fluence with different carbon concentrations as the parameter for a fixed plasma temperature of  $T_e = 20$  eV [335] calculated by the dynamic Monte-Carlo Code TRIDYN. In Fig. 20b this transition boundary is shown in the plasma temperature vs. carbon concentration plane. The calculation for the divertor conditions during the ASDEX-Upgrade W experiment [336], with a typical  $T_e = 10$  eV, predicts a transition for about 1% C ions. This prediction will be compared to spectroscopic measurements of W erosion in Sect. 4.3.1.

The balance of erosion/re-deposition is obviously a complex multi-parameter process. For the system Be-C-W, Hirooka [337] made predictions of flux ratios and ion energies at which sputtering or deposition will occur on the basis of calculated sputtering yields and reflection coefficients of the pure materials. The analysis, performed only in terms of energy dependent yields, neglects the process of implantation and surface modification. The qualitative findings are, however, in good agreement with experimental evidence at PISCES (see 4.3.1).

Insert Fig. 20

3.2.6.3. *Erosion data of mixed-materials*

The database for erosion processes on mixed-materials is still small, although investigations are in progress.

Studies of binary systems include the erosion due to non-recycling or only partially recycling ions previously presented in Fig. 12 for C, and in Fig. 13 for W. In the case of O and C bombardment, the surface will change its composition and oxides or carbides may form. For O bombardment, saturation will eventually be reached in the stoichiometric oxide. No protective oxygen layers can be built-up, and erosion, although reduced, prevails. Continued carbon irradiation, however, will lead to the build-up of carbon layers and a change from erosion to deposition.

Ternary systems cover the simultaneous sputtering by different impurity ions or the erosion by deuterium with simultaneous impurity ion bombardment. The systems  $C^+$  and  $CO^+$  on Be [338] and  $C^+$  and  $CH_3^+$  on W [339] have been investigated in some detail. Fig. 21 shows the fluence dependence of deposition and erosion for both systems. In Fig. 21a, the influence of the simultaneous impact of oxygen together with carbon is demonstrated for Be. The deposition of carbon was measured as a function of the fluence of  $C^+$  and  $CO^+$  ions. While for pure carbon bombardment a continuous increase of the deposition occurs, the simultaneous impact of oxygen prevents the build-up of a protective layer and deposition reaches a saturation [338]. Actually, weight change measurements show a continuous loss of material, implying that Be erosion continues in steady-state. In similar experiments investigating the formation of surface layers on Be, the transition from erosion to deposition was documented as a function of carbon concentration in a deuterium plasma beam [340].

A similar behaviour was demonstrated for simultaneous bombardment of W with carbon and hydrogen (see Fig. 21b).  $CH_3^+$  bombardment at 3 keV ion energy simulates the simultaneous impact of 2.4 keV  $C^+$  ions (25%) and 200 eV  $H^+$  ions (75%). While the hydrogen ions with energies below the threshold energy cannot sputter W atoms, they can remove carbon atoms and prevent the build-up of a protective layer. Incident carbon ions continue to sputter W; weight loss occurs in steady-state. The effect is more pronounced at elevated temperatures as shown in Fig. 21c, either due to the diffusion of carbon into W [339] or by the enhanced chemical erosion of carbon by hydrogen ions [341], both effects leaving the W surface unprotected to sputtering.

One important parameter is certainly the carbon concentration in the incident ion flux [335]. The transition from erosion to deposition occurs at lower ion energies as the carbon concentration decreases (Sect. 3.2.6.2). This transition concentration has recently been investigated for the conditions in PISCES for W erosion as a function of surface temperature [342]. For ion energies around 100 eV, the transition for both  $C^+$  and  $H^+$  occurs at concentrations of about 5% in good agreement with estimates from TRIM.SP calculations [335]. A weak decrease of the transition concentration was found with increasing temperature.

The parameter space for erosion/deposition in ternary systems is large and only a few laboratory results are available. More experiments are needed to validate computer code calculations, especially as additional thermal effects, such as diffusion, phase formation or surface segregation may occur.

#### 3.2.6.4. *Properties of deposited layers*

Re-deposited material is often considered to be similar to the bulk substrate material as far as erosion and hydrogen retention properties are concerned. However, especially in the case of re-deposited carbon materials, these properties may depend strongly on the deposition conditions. Depending on local plasma temperature influencing the incident ion energies, the deposits may vary from hard coatings with an H/C ratio near 0.4 to more polymer-like layers with H/C ratios near unity (Sect. 4.3). There is evidence from laboratory experiments that chemical erosion of hydrogenated co-deposits due to thermal hydrogen atoms is drastically enhanced compared to bulk graphite [291]. The thermal desorption of hydrocarbon molecules from co-deposited layers is strongly dependent on film structure [343].

In the case of polymer-like films, the release of H<sub>2</sub>, CH<sub>4</sub> and C<sub>2</sub>H<sub>4</sub> commences at a temperature of  $\approx 500$  K, whereas for 'hard' a-C:H films, only H<sub>2</sub> and CH<sub>4</sub> desorb, and this occurs at temperatures above 700 K. Moreover, thermal decomposition of polymer-like films leads to the release of a large amount of C<sub>x</sub>H<sub>y</sub> species with  $x \geq 2$ . Indeed, molecular fragments containing up to 7 C atoms have been detected [344]. On the other hand, simultaneously deposited metal atoms may reduce the chemical erosion rate [345]. Chemical erosion reduction has been observed in laboratory experiments for doped graphites [346, 347].

### 3.3. Erosion by Arcing

Electrical arcs are short duration ( $< 1$  ms), high current density ( $\approx 10^{12}$  A·m<sup>-2</sup>) localised "discharges" that can occur between the plasma and a PFC. The PFC material is evaporated and eroded quickly ( $> 1$   $\mu$ m) due to the significant local heating by the arc. The signatures of electrical arcing between the plasma and the first-wall have been seen since the first tokamak experiments were performed (e.g., T-2 [348]). Plasma-exposed components show tracks, scratches or pits caused by the intense local arc erosion that are visible to the naked eye (Sect. 4.4). The macroscopic nature of the arcing phenomena has made it a natural candidate for PMI investigation. The resemblance of the arc erosion on a PFC to the spots observed on the cathodes of vacuum arcs has been long recognised and has provided a large part of the understanding of arcing in tokamaks [73, 349–351]. The most basic condition that must be met to initiate an arc is that the driving potential at the material surface must surpass the arc voltage threshold,  $U_{arc} \approx 10$ –30 V. This is typically achieved in the laboratory by placing a potential between two probes or plates. In a plasma, a sheath potential arises between the plasma and the material surface to equalise ion and electron fluxes. A temperature  $T_e > 3$ –10 eV provides sufficient sheath potential to initiate an arc, a condition easily met in tokamak edge plasmas. These arcs are called "unipolar" since they have one solid "electrode", namely the wall that acts as cathode, while the plasma performs the function of anode.

The other key to arc initiation is the presence of small surface protrusions (see Fig. 22) that provide a localised emission source or "hot spot". Several factors at the spot reinforce the "seed" arc current formation. Large electric fields reside there, tending to enhance local

heat flux to the surface and electron emission. Also, the spot heats up quickly because of its reduced thermal conductivity to the bulk material. It has also been suggested that ionisation of the material within the sheath, which allows additional electron emission into the sheath, can play an important role in initiating the arc [352]. Eventually, these self-reinforcing, current-forming and heating mechanisms make the tip evaporate, providing the needed material and current to sustain the fully formed arc. Emitted electrons are accelerated towards the plasma, reducing the local sheath potential, while the return path of the current is through energetic electrons returning to an area much larger than and adjacent to the cathode spot. The current channel of the arc contracts due to its self magnetic field, resulting in a small cathode spot ( $\approx 10 \mu\text{m}$ ) and large current densities ( $\approx 10^{12} \text{ A}\cdot\text{m}^{-2}$ ). The cathode spot is heated via ion impact and cooled by melting and evaporation, the source of the material erosion.

In the presence of an external magnetic field,  $B$  (typically parallel to the PFC surface), an arc with current  $J$  (normal, into the surface) is acted upon by the Lorentz force,  $J \times B$ . However, the arc's retrograde motion (i.e., in the opposite  $B \times J$  direction) is well established experimentally in both laboratories and tokamaks [353]. This is apparently due to the enhancement of arc density and heating from the alignment of the external and arc-caused magnetic field on the retrograde side of the arc [354]. This favours the creation of a new arc on the lip of the initial crater. Thus, the arc appears to hop from one spot to another in the  $B \times J$  direction, causing the common scratch-like signature of arcing (typically several mm in length). The motion of the arc across the surface greatly extends the effective area over which the arc erodes material (as compared to a stationary arc that only affects a region several  $\mu\text{m}$  in diameter.)

The erosion rate of arcing is characterised by the amount of material per coulomb of arc charge and ranges from 10-100  $\mu\text{g}/\text{C}$ . Most elements (including carbon and tungsten) show a remarkably similar ratio of eroded ion current to total arc current ( $\approx 10\%$ ) [351]. Erosion losses from neutrals can enhance this by up to a factor of 2 over a wide range of arc currents. Neutral eroded material is typically via particles on the order of a  $\mu\text{m}$  in size, ejected by high-pressure vapour produced by the arc. These particles may vaporise and contaminate the plasma or remain as dust in the vessel (Sects. 2.3.4 and 4.8).

Fig. 22 follows the typical arc cycle seen in tokamaks. The shallow angles of incidence of the heat and particle flux incident on a tokamak first-wall make even very small protrusions prone to excess heating. The initial arc is established (through the mechanisms described above), erodes the cathode spot and jumps to a 'fresh' location in the retrograde direction. Typical arc tracks from limiters and divertors have dimensions of 10  $\mu\text{m}$  in depth, 10-100  $\mu\text{m}$  in width, and 5-10 mm in length, resulting in  $10^{17}$ - $10^{18}$  atoms of eroded material per arc event.

Uncertainties in characterising the nature and quantity of surface protrusions makes predictive modelling of arcs quite difficult. In contrast to sputtering, which occurs constantly over the surface wetted by the plasma, arcing happens discretely. Arcs are initiated by ever-changing surface conditions such as surface roughness, gas loading [355] and thin film formation. The implications of these dependencies will be further discussed in Sect. 4.4.

### 3.4. Erosion during Off-Normal Plasma Events

Here we provide a brief overview of the physical processes involved in the deposition of intense energy delivered to PFCs during off-normal plasma transients in tokamaks (e.g., disruptions, etc.). Experimental data for disruption erosion, mainly from disruption simulators, are discussed in Sect. 4.5. Modelling of disruption erosion and the design implications for a next-step device are discussed in Sect. 5.4.

#### 3.4.1. Physical processes

Plasma-facing surfaces are rapidly heated during plasma instabilities (e.g., disruptions) by the direct impact of energetic plasma particles and radiation. Energy deposition in the target material is calculated using models that include physics of energy loss by plasma ions and electrons. The deposited energy flux can be high enough to rapidly melt and vaporise the surface material. The thermal response of the material is calculated by solving a time-dependent heat-conduction equation, with moving boundaries, i.e., the receding eroded surface and the solid-liquid interface, with boundary conditions including heats of melting and vaporisation as described by Hassanein [356].

Initially, the neutral vapour emitted from a solid or liquid target surface expands freely across magnetic field lines in the direction normal to the surface. As the cold vapour is heated by incident plasma particles, it becomes ionised and expands following the direction of the oblique magnetic field lines. The parameters and the dynamics of the target plasma depend on the energy flux and the type of target material. A low-Z target plasma (e.g., C, Be, etc.) expands to larger distances from the surface, whereas vapour shields formed from higher-Z materials (e.g., W, Mo, etc.) stay closer to the surface. The incoming plasma particles are completely stopped in the vapour plasma and the plasma energy flux is converted to photon radiation. Although reduced from its original value, the net energy flux to the target surface (dominated by photon radiation) is large enough to cause melting and further erosion of metallic components.

Fig. 23 from Ref. [357] is a schematic illustration of the various interaction zones that are currently included in the models to simulate the effects of the thermal quench of a disruption on a PFC.

The melt layer developed during a disruption, is exposed to various forces such as electromagnetism, gravitation, mechanical vibration, plasma momentum, surface tension, and ablation recoil [358]. For metallic components such as beryllium and tungsten, the erosion lifetime due to these off-normal events will be controlled and dominated by the evolution and the hydrodynamics of the melt layer during disruption, and the resulting loss of liquid material from the surface. In contrast, C-based materials do not melt and, therefore, do not erode by these processes. This is a major motivation for the choice of graphite and carbon-fibre-composites for some PFCs in existing fusion machines and in the ITER design (Sects.



1.2.3 and 2.4). However, C-based materials can suffer from different erosion mechanisms, as will be discussed later.

The detailed vapour motion above the exposed surface is calculated by solving the vapour magneto-hydrodynamic equations for the conservation of mass, momentum, and energy under the influence of a magnetic field [359]. The vapour cloud, if well confined, is predicted to greatly reduce the net energy flux to the surface, resulting in a reduction in erosion by evaporation of one to two orders of magnitude [360, 361]. The magnetic field lines are initially frozen into the surface of the liquid metal layer because of the liquid's high conductivity. However, as more vapour is emitted from the surface, the expanding dense ionised vapour will sweep and distort the oblique magnetic field lines. Near the upper vapour boundary, the magnetic field lines become almost parallel to the vapour surface. Such a situation of distorted magnetic field distribution results in a flute-type MHD instability (see glossary) in the vapour plasma [362]. As a consequence of the loss of vapour confinement, the turbulent diffusing hot vapour may then deposit its energy on nearby-components, causing more erosion. The overall net erosion rate and resulting damage will depend on the disrupting plasma parameters, the size of disruption spot, the design configuration, and the type of plasma-facing material [363].

In addition, hot plasma incident onto the cold plasma of the vapour shield gives rise to electric fields [364]. The electric field may cause lateral ExB drifts which can result in significant deflection of either the vapour shield plasma [365] or the incident plasma [366], or both, but these effects have not yet been demonstrated experimentally.

Photon radiation transport in a vapour plasma is an important part of predicting disruption erosion of PFCs. Opacity and emissivity parameters vary significantly in the developed vapour plasma since it contains very cold and dense plasma regions near the target surface and very hot and less dense plasma regions where the disrupting plasma ions and electrons deposit their energy. The models contained in the HEIGHTS package, developed by Hassanein et. al. [363], allow for the treatment of non-local thermodynamic equilibrium (non-LTE) of the vapour-cloud-generated plasma, multi-group and multidimensional analysis of the produced photon spectra, as well as self-consistent kinetic models for both the continuum and line radiation generated in the vapour cloud.

#### 3.4.2. Erosion of metallic plasma-facing materials

Surface vaporisation losses of metallic plasma-facing materials are generally small (only a few microns) over a wide range of plasma conditions during short (i.e.,  $<<1s$ ) plasma instabilities [367]. The thickness of the melt layer on metallic components can be one to two orders of magnitude higher than surface vaporisation losses [368, 369]. This is illustrated in Fig. 24 (taken from Ref. [363]) that shows the time evolution of a tungsten surface temperature, melt-layer thickness (see glossary), and vaporisation losses during a disruption for an incident plasma energy of  $10 \text{ MJ}\cdot\text{m}^{-2}$  deposited in a disruption time of 1 ms as predicted by the A\*THERMAL-S code (part of the HEIGHTS package) [363]. An initial magnetic field strength of 5 T with an incident angle of 2 degrees is used in this calculation. The sharp initial rise in surface temperature is due to the direct energy deposition of incident plasma

particles at the material's surface. The subsequent decrease in the surface temperature was caused by the reduction in absorbed heat flux due to the vapour shield and conduction of heat into the material. The subsequent behaviour is mainly determined by the energy flux from the emitted photon radiation in the vapour cloud, as discussed above, and by vapour-electron heat conduction.

*Insert Fig. 24*

Two mechanisms of melt-layer loss have been observed experimentally [370]. These are melt splashing due to the formation of vapour bubbles inside the liquid layer, and growth of hydrodynamic instabilities due to plasma impact momentum ("plasma wind") at the liquid surface and forces generated by current decay in the liquid metal layer. As a result, hydrodynamic instabilities such as the Kelvin-Helmholtz instability will arise and form liquid droplets that will be carried away by the plasma wind.

The amount and rate of melt-layer loss is difficult to predict and is expected to depend on many parameters, such as heat flux, impurity and gas content, material properties, and disrupting plasma parameters.

#### 3.4.3. Erosion of carbon-based materials

Because of the shielding layer effect discussed above, erosion by vaporisation of carbon is limited to  $<10 \mu\text{m}$  for a wide range of disrupting plasma conditions. This is about one to two orders of magnitude lower than it would be if no vapour shielding exists [368].

However, in many cases, graphite and C-based materials have also shown large erosion losses significantly exceeding that from surface vaporisation. A phenomenon, called 'brittle destruction' has been observed in various disruption simulation facilities (Sect. 4.5). Physical mechanisms causing brittle destruction of C-based materials are not yet clear. One potential reason is cracking caused by thermo-mechanical stresses that develop during the process [371–373]. Another proposed scenario, is that material is ejected by the sharp rise in pressure of gas trapped in the network of pores between intergranular and intercrystallite boundaries [370]. These processes are likely to depend on the material microstructure.

The macroscopic erosion of C-based materials depends on three main parameters: net power flux to the surface, exposure time, and the threshold energy required for brittle destruction [363]. The required energy is critical in determining the net erosion rate of C-based materials and is currently estimated from disruption simulation experiments (Sect. 4.5). More experimental data and additional detailed modelling are needed to evaluate the erosion of carbon-based materials, e.g., the role of brittle destruction (Sect. 6.1).

### 3.5. Hydrogen Interactions with Plasma-Facing Materials

Retention and recycling of hydrogen from PFCs affects fuelling efficiency, plasma density control and the density of neutral hydrogen in the plasma boundary. This in turn impacts particle and energy confinement (Sect. 1.2.3) [374–377]. Tritium inventory and permeation of tritium through the wall or into coolant channels are also concerns for reactors. This

section reviews the underlying physical mechanisms for these processes that provide the basis for models of hydrogen retention and recycling discussed in Sect. 5. The implantation of energetic hydrogen into plasma-facing materials and its subsequent diffusion, release, or immobilisation by trapping or precipitation within the material are discussed here. Hydrogen retention via co-deposition is also discussed.

Some laboratory data are included in this section, mainly to illustrate how the various processes influence hydrogen retention in carbon, beryllium and tungsten. The term “hydrogen” or “H” is used in this section generically to refer to protium, deuterium and tritium.

### 3.5.1. Implantation

Implantation of energetic particles into solids is fairly well understood [378]. In tokamaks, plasma-facing materials are bombarded by energetic ions and neutrals from the plasma with energies of up to a few keV. As these energetic particles penetrate into a solid they lose their kinetic energy, mainly to electrons, and are deflected by collisions with atoms thereby transferring kinetic energy to atoms in the solid (see also Sect. 3.2.1). Some of the incident particles scatter back out of the material with a significant fraction of their initial energy, leaving the surface mainly as neutrals. The fraction of particles which backscatter is higher for lower incident energies and higher-Z target materials and can exceed 50% [379]. Particles that do not backscatter eventually reach thermal energies within the material and settle into an atomic configuration, which has a local energy minimum. The depth distribution of these implanted particles depends on the energy and atomic number of the incident particles and on the target material.

Atomic collisions displace atoms from their equilibrium lattice sites. If the transferred energy is less than a few tens of eV a metal lattice will relax back to its original atomic configuration. Collisions transferring more energy than this can produce lattice vacancies and interstitials. The maximum energy transferred in a collision is:

$$E_t = E_o 4M_1 M_2 / (M_1 + M_2)^2 \quad (6)$$

where  $E_o$  is the incident particle energy and  $M_1$  and  $M_2$  are the incident and target atom masses. Light projectiles, therefore, transfer a larger fraction of their energy to light target atoms than to heavy target atoms. Thus, in a plasma-wall environment, such displacement defects are more likely to be produced in low-Z materials than in high-Z materials. In metals, a vacancy/interstitial pair is dynamically unstable and will recombine if their separation is less than a few lattice spacings. This limits the concentration of displacement defects to less than about 1 atomic percent, even in the absence of long range mobility [380]. Vacancies and interstitials also migrate by thermally activated diffusion and disappear at surfaces and dislocations. They are annihilated by recombining with each other or agglomerating into less mobile defect clusters. Defect mobility depends on the material and on temperature. Interstitial atoms are mobile above about 100 K in most metals [374]. Vacancies become mobile at an absolute temperature that is roughly a quarter of the melting temperature. Vacancies may also capture hydrogen, as will be discussed later in this section, which may reduce their mobility. The extent to which atomic displacements by energetic hydrogen influence PMIs

is not well understood, but these defects are more likely to have a significant effect for low-Z materials than for high-Z materials. Monte-Carlo computer simulations of implantation have been developed which are widely used to calculate depth profiles of implanted atoms and displaced lattice atoms, and the energy and angular distributions of backscattered particles [268, 381].

Hydrogenic ions from a plasma typically have energies in the range from tens to hundreds of eV after acceleration through a sheath potential (Sects. 1.2.4 and 3.2). The energy distribution of charge-exchange neutrals depends on the density and ion temperature profile in the plasma edge and can extend up to a few keV for hot low-density plasmas (see Fig. 18). In low-Z materials such as C or Be, the depth of implantation of hydrogen with energies of 0.1 to 1 keV is about 3 to 30 nm [382]. At a given energy, the depth of implantation of hydrogen into high-Z materials is less than in low-Z materials.

### 3.5.2. Hydrogen behaviour in metals

#### 3.5.2.1. Hydrogen diffusion in metals

Hydrogen implanted into metals will predominantly come to rest at interstitial solution sites. From there the hydrogen may hop to neighbouring solution sites thus undergoing thermally activated diffusion. The fate of implanted hydrogen strongly depends on its mobility through the lattice, hence on the temperature. In most metals, hydrogen diffuses at room temperature and above [383, 384]. In this case, the time-dependent distribution of hydrogen in the material can be described by the diffusion equation:

$$\frac{\partial C_s(x,t)}{\partial t} = D \frac{\partial^2 C_s}{\partial x^2} + \Phi P(x) - \sum_i S_i \quad (7)$$

where  $C_s(x,t)$  is the concentration of hydrogen in solution per host atom (i.e., atom fraction) and  $D$  is the diffusion coefficient for hydrogen in solution. The second term on the right-hand side is the source term for implanted hydrogen where  $\Phi$  is the flux and  $P(x)$  is the depth distribution. Source/sink terms  $S_i$  describe other processes, which add to or subtract from the concentration of hydrogen in solution. Such processes include trapping and internal precipitation into gas or hydride phases. In addition, a boundary condition at the surface is required. Release of hydrogen from a metal surface normally occurs by the desorption of hydrogen molecules. The direct thermal desorption of atomic hydrogen from the surface normally occurs at a slower rate due to the larger energy barrier for this process, but can be significant at high temperatures. For release by molecular recombination at the surface, the outgoing flux (atoms per unit area and time) is

$$\Phi_o = -D[\partial C_s/\partial x]_{x \rightarrow 0} = 2K_r[NC_s(x \rightarrow 0)]^2 \quad (8)$$

where  $C_s(x \rightarrow 0)$  and  $[\partial C_s/\partial x]_{x \rightarrow 0}$  indicate the value and the gradient, respectively of the concentration of hydrogen in solution just beneath the surface,  $N$  is the atomic density of the host and  $K_r$  is a rate coefficient for molecular recombination.  $K_r$  can be determined in experiments which simultaneously measure hydrogen concentration and release rate [385], and theoretical models exist which give  $K_r$  values from first principles for bare metal surfaces

[385–387]. A schematic diagram illustrating the main mechanisms for hydrogen transport and release at the surface of a metal is shown in Fig. 25. Monolayer coverage of surfaces by contaminants such as oxygen can reduce  $K_r$  by orders of magnitude [385, 388]. Dissociative absorption of hydrogen from gas phase into solution in metals is similarly hindered by surface impurities [388]. This sensitivity of hydrogen uptake and release to surface contaminants often strongly affects permeation and thermal desorption experiments. Controlled experimental permeation studies of the effects of the surface state on  $K_r$  [385, 388–391] and the deposition of thin metal films on permeating substrates [392–394] to control  $K_r$  have been performed and results are available for palladium, iron, tantalum and copper. Models for permeation of hydrogen in metals are also discussed in Ref. [377].

*Insert Fig. 25*

Analytical solutions to the hydrogen transport equation have been developed [395, 396] for evaluating the hydrogen inventory, recycle and permeation rate and recycle time, under steady-state conditions where hydrogen is being implanted at flux  $\Phi$  to a depth  $R_p$  and release is controlled by diffusion and surface recombination. The flux of implanted hydrogen creates a concentration of hydrogen in solution at depth  $R_p$  given by  $\Phi = -D \partial C_s / \partial x = -DC_s/R_p$  for diffusion-limited release or by  $C_s = (\Phi/K_r)^{1/2}$  for surface-recombination limited release. In each case, a near-surface concentration of mobile hydrogen is established from which hydrogen may diffuse beyond the implantation depth. The steady-state flux of hydrogen permeating through a slab is

$$W = (R_p/D)(K_r/\Phi)^{1/2} \quad (9)$$

when release is diffusion limited at both the front and back surfaces and the depth of implantation  $R_p$  is much less than the thickness of the slab  $x$ . When release is recombination limited at both front and back surfaces with recombination coefficients  $K_f$  and  $K_b$  respectively, the steady-state permeating flux is

$$\Phi_p \cong \frac{\Phi}{1 + K_f/K_b} \quad (10)$$

Diffusing hydrogen can become bound at traps. The concentration of trapped hydrogen can be determined from the concentration of mobile hydrogen, i.e., hydrogen in solution, as will be discussed below. The diffusing hydrogen may also precipitate into gas or hydride phases. Trapping and precipitation can be described by appropriate source/sink terms  $S_i$  in the transport equation as described below. The amount of hydrogen in solution, trapped and precipitated states will depend on the incident flux of hydrogen. This can lead to dynamic pumping effects where hydrogen accumulates in the material during implantation and is released after the implantation ceases. Modelling of hydrogen recycling effects is discussed in Sect. 5.5.

### 3.5.2.2. Hydrogen trapping in metals

Trapping of hydrogen at lattice defects can strongly affect the behaviour of hydrogen in materials. Here we define traps as sites where hydrogen is atomically bound, which do

not interact with each other, and where the hydrogen is in a lower energy state relative to a solution site. Examples of such sites are lattice vacancies, adsorption onto internal (i.e., void) surfaces, and interfaces with embedded particles such as oxides. Fig. 26 illustrates the relative energies of hydrogen in various states in a metal host and the barriers for thermally activated transitions between states.

*Insert Fig. 26*

The condition for thermodynamic equilibrium between hydrogen in traps and hydrogen in solution is obtained by equating the chemical potentials of hydrogen in these two states. For static traps, in which one hydrogen atom can be accommodated in each trap, statistical mechanics gives the equilibrium condition

$$C_s/z = C_t/(C_T - C_t)\exp(-Q_t/kT) \quad (11)$$

between the concentration of hydrogen in solution,  $C_s$ , and the concentration of hydrogen in traps  $C_t(x,t)$ , where  $C_T(x)$  is the concentration of traps,  $Q_t$  is the difference in enthalpy between hydrogen in a trap and at a solution site,  $k$  is Boltzmann's constant,  $T$  is temperature and  $z$  is the number of solution sites per host lattice atom. This expression assumes that the fraction of solution sites occupied by hydrogen is small and that the non-configurational or vibrational part of the entropy difference between trapped and un-trapped hydrogen is small. The source/sink term,  $S_t$ , describing the effect of static traps on hydrogen transport can then be formulated as

$$S_t = \partial C_t/\partial t = \Gamma [C_s(C_T(x) - C_t) - zC_t\exp(-Q_t/kT)] \quad (12)$$

where  $\Gamma$  is the rate at which local equilibrium between hydrogen in traps and solution is approached. The first and second terms on the right-hand side are the trapping and detrapping rates respectively. In equilibrium, these terms are equal and  $\partial C_t/\partial t = 0$ . The rate coefficient can be expressed as

$$\Gamma = 4\pi NDR \quad (13)$$

where  $R$  is the reaction radius, i.e., hydrogen-trap separation at which reaction occurs, which is about one lattice constant [397]. Solutions to the transport equation usually depend only weakly on the value of the equilibration rate  $\Gamma$ . More critical is the condition for thermodynamic equilibrium (eq. (11)). This is because features of interest usually involve longer-range transport occurring over time scales long compared to the time to reach local thermodynamic equilibrium.

The case where a material contains more than one type of static trap can be described by including additional source/sink terms as given by eq. (12), each with its own trap concentration and binding enthalpy. If multiple states or types of traps with different  $H$  binding enthalpies are present, and the  $H$  can exchange among them so that the various states are in thermodynamic equilibrium, then the states with the lowest energy will be occupied first. As more  $H$  is added to the system (increasing its chemical potential), the lowest energy

states eventually will be filled and the higher energy states can become occupied. Generally, in transition metals H adsorbed on a surface is one of the most strongly bound states. Adsorbed H will therefore tend to saturate the surfaces of internal voids if these are present, before gas begins to precipitate within the voids and before H begins to occupy other weaker traps.

Appropriate source terms for eq. (7) have also been derived for situations where each trap may accommodate multiple hydrogen atoms, for example, adsorption sites on the surface of internal cavities or multiple hydrogen atoms in a vacancy [376]. This formalism has also been extended to include the case where multiple types of traps are themselves diffusing and interacting with each other to describe hydrogen interacting with mobile displacement defects in nickel [398].

Here, we briefly discuss two special cases of trapping in a material with a uniform concentration of traps, where the concentration of mobile hydrogen in solution near the surface is fixed at a value  $C_{ss}$ . In the first case, the concentration of traps is larger than the concentration of H in solution ( $C_T \gg C_{ss}$ ) and trapping is strong such that the concentration of hydrogen in solution in equilibrium with the traps  $C_{eq} \ll C_{ss}$  until the traps are nearly full. In this case, the traps will be full at depths less than  $x = (2DtC_{ss}/C_T)^{1/2}$  and empty at greater depths. H uptake in this case proceeds through the increase in thickness of a layer in which the H concentration equals the trap concentration. This gives a delay before the onset of permeation through a slab. Secondly, consider the case where the trapping is weaker such that the fraction of occupied traps is still small in equilibrium with hydrogen in solution at concentration  $C_{ss}$ . In this case, the traps may be considered as another type of solution site and the flux of diffusing hydrogen can be expressed as

$$J = -D\partial C_s/\partial x = -D^*\partial C_s^*/\partial x \quad (14)$$

with an effective diffusivity

$$D^* = D/[1 + C_T/zexp(-Q_t/kT)] \quad (15)$$

and effective concentration

$$C_s^* = C_s + C_t = C_s[1 + C_T/zexp(-Q_t/kT)] \quad (16)$$

In both of these cases, the steady-state rate of permeation of hydrogen through a slab of material is not affected by traps; however, the time to reach steady-state and the inventory of hydrogen in the material does depend on the trapping.

Trapping of hydrogen at vacancies and on surfaces of internal cavities has been extensively studied in many metals, both theoretically and experimentally, by several methods. Experimental methods include studies of internal redistribution of deuterium between traps at different depths, equilibration of trapped deuterium with gas phase deuterium with known chemical potential, thermal desorption, positron annihilation and perturbed angular correlation gamma emission. Much of this work for metals is reviewed in Ref. [376]. A critical parameter for describing hydrogen trapping is the binding enthalpy of hydrogen to the traps.

Table 8 gives values of binding enthalpy of H to vacancies relative to a solution site ( $Q_t$  shown in Fig. 26) at low occupancy in several metals obtained both from experiments and from first principles calculations.

*Insert table 8*

*Refs. [376, 399-402] appear at the bottom of Table 8 and are reported here just to maintain consistent reference sequential numbering while appending the tables at the end of the section.*

Trapping of hydrogen at helium bubbles produced by implantation of helium into metals has also been studied extensively. This is relevant to fusion plasma environments where helium bubbles may be formed by implantation of fusion alpha particles, by tritium decay or by neutron-induced transmutation, e.g., in materials like beryllium. These studies show that helium bubbles in metals trap hydrogen even more strongly than vacancies. Table 9 summarises binding enthalpies of D to helium bubbles relative to a solution site, in several metals obtained from experiments and theory.

*Insert table 9*

*Refs. [376, 399, 403-405] appear at the bottom of Table 9 and are reported here just to maintain consistent reference sequential numbering while appending the tables at the end of the section.*

Trapping of hydrogen at helium bubbles is essentially the same mechanism as chemisorption onto a surface as can be seen from the fact that binding enthalpy of hydrogen to helium bubbles is similar to measured enthalpy of chemisorption onto external surfaces relative to hydrogen in a solution site. The high density of helium in the small cavities does not significantly influence hydrogen trapping on the cavity surfaces.

As shown by table 8 and table 9, the binding enthalpies of hydrogen to vacancies and helium bubbles calculated by the "effective medium" theory are generally in good agreement with experimental values. The central concept behind the effective medium theory is an embedding function which gives the energy to insert an initially isolated atom, for example, hydrogen or helium, at a particular site in terms of the unperturbed local electron density at that site before inserting the atom [406, 407]. This function depends on the type of embedded atom but is independent of the host. The approximate energy obtained from the embedding function is then refined by incorporating host-specific perturbation terms. Fig. 27 shows the embedding functions for hydrogen and helium. A significant feature for hydrogen is the energy minimum at finite electron density which reflects its chemical reactivity, whereas the embedding function for helium, which is chemically inert, has no such minimum. For most metals the local electron density at the interstitial hydrogen solution site lies well above the minimum, hence any local dilation of the lattice will produce a trap for hydrogen by lowering the local electron density. Furthermore, the more open the defect the greater the binding enthalpy, with large voids and external surfaces providing the asymptotic limit. For example, mono-vacancies trap hydrogen substantially more strongly than dislocation strain fields or stacking faults, but somewhat less strongly than voids [376]. Trapping of hydrogen at substitutional impurities in metals is observed to be weak ( $Q_t \leq 0.1$  eV typically) [408] as expected, since these do not create open volume. Metals with large endothermic heats



of solution (i.e., low solubility), should have large values of  $Q_t$  for trapping at vacancies and surfaces, since the enthalpy difference between solution and trap sites will be larger, as illustrated in Fig. 26. For example, molybdenum and tungsten have large endothermic heats of solution (0.68 and 1.04 eV, respectively [403, 409]) and large binding enthalpies (1.03 and 1.1 eV respectively [400, 401, 410]) for hydrogen trapped at vacancies. The combination of low solubility and strong trapping means that small defect concentrations can strongly influence hydrogen content and mobility which makes measurements of hydrogen solubility and diffusivity susceptible to errors due to trapping.

Because of its high atomic density, beryllium has one of the highest interstitial electron densities of any metal [411], and thus might be expected to represent an extreme case of low solubility and strong trapping for hydrogen. Density functional theory calculations predict a large endothermic heat of solution (0.8 eV) and strong binding of hydrogen to vacancies (1.62 eV) in beryllium [402, 412]. Experiments to measure hydrogen solubility in Be have found low concentrations of hydrogen in solution but often also small endothermic heats of solution [413], (also see Sect. 3.5.2.4). This combination suggests that these solubility studies might be measuring occupation of hydrogen sites other than bulk solution in Be metal. The powder metallurgy process normally used to fabricate beryllium leaves many small beryllium oxide inclusions, typically at volume fractions of 1%, which could provide trap sites at the metal/oxide interface or lower energy solution sites within the BeO particles. Although trapping of H at BeO inclusions in Be has not been studied, H is observed to be strongly trapped by such oxide inclusions in aluminium [414].

*Insert Fig. 27*

### 3.5.2.3. Hydrogen precipitation in metals

If hydrogen in solution encounters an internal void it will precipitate as molecular hydrogen. If the void volume is connected to an external surface the gas will escape the material. Otherwise, the gas pressure in the void will increase as hydrogen flows into it. Net flow ceases when thermodynamic equilibrium between solution and gas phases is reached, i.e., when the chemical potentials of the two phases are equal. This gives

$$C_s/C(P_o) = (P^*/P_o)^{1/2} \quad (17)$$

when the fraction of solution sites occupied by hydrogen is small, where  $C_s$  is the concentration in solution.  $P^*$  is the fugacity of the gas, which for an ideal gas equals the gas pressure. The solubility

$$C(P_o) = C_{s_o} \exp(-Q_s/kT) \quad (18)$$

is the concentration of hydrogen in solution in equilibrium with gas at some reference pressure  $P_o$ , small enough for the gas to behave ideally,  $Q_s$  is the enthalpy of solution and  $C_{s_o}$  is a solubility pre-factor. Implantation of hydrogen into materials may produce concentrations of hydrogen in solution, for which the equilibrium gas pressure is very high.

The fugacity and chemical potential  $\mu$  can be obtained from the equation of state [415] relating the gas pressure  $P$  to the molar volume  $V_m$  by integrating

$$\ln(P^*/P_o) = (\mu - \mu_o) / kT = (kT)^{-1} \int_{P_o}^P V_m(P) dP \quad (19)$$

Precipitation of hydrogen into static cavities can be included in the transport equation through a source/sink term of the form

$$S_g = \partial C_g / \partial t = \Gamma_g [C_s - C_{eq}(C_g, V_c, T)] \quad (20)$$

where

$$C_{eq} = (P^*/P_o)^{1/2} C_{so} \exp(-Q_s/kT) \quad (21)$$

$C_{eq}$  is the concentration of hydrogen in solution in equilibrium with the gas in the cavities, which depends on temperature and molar volume of gas in the cavities, and therefore on  $C_g$ , the quantity of hydrogen in the cavities and on  $V_c$ , the volume of cavities per unit volume of material since

$$C_g = 2V_c/V_m \quad (22)$$

The rate coefficient is

$$\Gamma_g = 4\pi DR_c N_c \quad (23)$$

where  $R_c$  is the cavity radius and  $N_c$  is the number of cavities per unit volume.

The flow of hydrogen into cavities may lead to gas pressures high enough to cause the cavity volume to increase. The two principal mechanisms for growth of small cavities are absorption of vacancies and production of dislocations. Growth by emission of single interstitial atoms is energetically unfavoured, compared to the collective process of dislocation production, except possibly for very small cavities approaching atomic dimensions. Absorption of vacancies produced by atomic collisions during implantation can contribute to cavity growth, although absorption of interstitial atoms that are simultaneously produced will have the opposite effect. At high temperatures, mobile vacancies are present in metals in thermal equilibrium. In this case the cavities will absorb and emit vacancies until the internal gas pressure balances the surface energy of the cavity:

$$P_{eq} dv = \gamma da \quad \text{or} \quad P_{eq} = 2\gamma/R_c \quad (24)$$

where  $v$  and  $a$  are the volume and surface area of a cavity, and the surface tension  $\gamma$  is the energy per unit area to create a new surface. This condition gives higher gas pressure and concentration of hydrogen in solution at smaller cavities than at larger cavities, leading to a net flow of hydrogen from smaller to larger cavities, i.e., to a coarsening of the cavity size distribution. The equilibrium gas pressure given by eq. (24), which is the minimum for cavity growth, can be very high for small cavities. For example, a surface tension typical

for metals of  $\gamma=1 \text{ joule}\cdot\text{m}^{-2}$ , gives  $P = 0.4 \text{ GPa}$  (4 kilobar) for 10 nm diameter cavities. At this pressure, the molar volume of hydrogen gas approaches that of solid materials and the equation of state departs significantly from ideal gas behaviour [415]. When the gas pressure has the equilibrium value given by eq. ( 24), the forces on the cavity surface due to internal pressure and surface tension balance each other and there is no net stress in the lattice around the cavity. In the absence of mobile vacancies, the gas pressure in the cavities can rise above the equilibrium value given by eq. ( 24), as H flows into the cavity, producing a stress field localised around each cavity. The internal gas pressure required for bubble growth by dislocation loop production is

$$P = (2\gamma + \mu b) / R_c \quad (25)$$

where  $\mu$  is the shear modulus of the material and  $b$  is the dislocation Burgers vector [416]. Typically, this occurs when the internal gas pressure is about an order of magnitude higher than the equilibrium value given by eq. ( 24). When bubbles grow by dislocation production the gas pressures are higher when the bubbles are smaller.

The microstructure that results from precipitation of implanted hydrogen depends on the nucleation of cavities. If the implanted hydrogen and displacement defects are very mobile, their concentrations will remain low, the hydrogen chemical potential will be low, and hydrogen precipitation is likely to occur only at pre-existing open volume sites such as grain boundaries or foreign inclusions. In this case, for low energy, i.e., shallow implantation, most of the hydrogen will escape from the surface and the fraction retained by precipitation into cavities will be small. If it is less mobile, the implanted hydrogen may build up to higher concentrations in solution in the implanted layer, giving a higher chemical potential which will eventually induce cavity nucleation. The production of displacement vacancies could assist initial nucleation and growth of cavities since agglomeration of vacancies along with trapping of hydrogen in them could create nuclei for gas precipitation. In this case a dense dispersion of very small cavities may develop in the implanted layer and the fraction of implanted hydrogen retained in the material may be close to 100% initially. As the implanted dose increases, the content of hydrogen and volume fraction of cavities increases. When the volume fraction of cavities is high enough, typically about 0.3, they become interconnected. Hydrogen implanted in beryllium at temperatures below 500 K [417] and in stainless steel below 150 K [418, 419] behave this way. If the implantation profile ( $P(x)$  in eq. ( 7)) peaks beneath the surface, cavity coalescence will lead to blistering and exfoliation of the overlying layer. In a plasma-wall environment, the broad distribution of energies and angles of incidence are likely to produce a hydrogen implantation profile that is highest at or very close to the surface. In this case, metals in which implanted hydrogen has low mobility and solubility will develop a surface layer with interconnecting porosity connected to the surface. This results in H retention that increases with fluence until the near-surface porosity develops, after which H retention saturates. This opening of porosity at the surface results in an enhancement of recombination and re-emission of particles back to the plasma and reduced uptake.

Hydrogen dissolves exothermically in some metals, and in this case high concentrations of hydrogen in solution can have low chemical potential and hence low equilibrium gas pressure. In such metals, hydrogen precipitates as an ordered metal-hydride phase rather than as gas bubbles. In many cases, the concentration of hydrogen in solution in thermodynamic equilibrium with the hydride phase can be approximated by

$$C_{eq} = C_{ho} \exp(-Q_h/kT) \quad (26)$$

where  $Q_h$  is the enthalpy of formation of hydride from the solution phase, and  $C_{ho}$  is a temperature-independent pre-factor. Hydride precipitation can be included in the transport eq. ( 7) through a source/sink term which incorporates the equilibrium concentration in solution (eq. ( 26)) and which stops the hydride dissolution and formation reactions when the local volume fraction of hydride reaches 0 or 1, respectively [376].

The system of coupled partial differential equations given by eqs. ( 7), ( 12), and ( 20) can readily be solved in most cases by discretising the spatial co-ordinate and then propagating the resulting system of ordinary differential equations forward in time from a specified initial condition using an integrating algorithm for stiff problems [420]. Several computer codes implementing numerical solutions to the hydrogen transport equation have been developed [376, 421–425]. Some of these are discussed further in Sect. 5.6.

#### 3.5.2.4. *Hydrogen retention in Be and W*

The use of tungsten and beryllium as plasma-facing materials in tokamaks has prompted many experimental studies of retention and emission of hydrogen implanted into these metals from ion-beams or plasmas. References and discussions of these studies can be found in reviews [375, 426–428]. Here we present selected highlights from these studies which are relevant to H retention in Be and W in a fusion plasma environment.

Two basic parameters for understanding H retention are the hydrogen diffusivity and solubility. Studies of solubility and diffusivity are reviewed in [428, 429]. Fig. 28 and Fig. 29 show experimental values for hydrogen solubility and diffusivity in W and Be. For Be there are significant differences between results from various studies. These differences may be due to effects of traps and surface oxide layers. The presence of bulk traps tend to increase measured values of solubility and decrease measured values of diffusivity as discussed above (see eqs. ( 15) and ( 16)), especially under conditions where the concentration of hydrogen in solution is smaller than the concentration of traps. For this reason, studies done on materials of higher purity and crystalline perfection, and at higher temperatures, and with higher concentrations of hydrogen in solution, tend to give more reliable results. The porosity and oxide inclusions present in beryllium produced by powder metallurgy are also likely to lead to inconsistent results in measurements of hydrogen solubility and diffusivity. The values of solubility and diffusivity reported for W [403] exclude effects of traps. In the Be experiments, the effects of traps were not characterised and may be dominant. One firm conclusion is that the solubility of hydrogen is very low in both Be and W.

*Insert Fig. 28*

*Refs. [403, 413, 430, 431] appear in the caption of Fig. 28 and are reported here just to maintain consistent reference sequential numbering while appending the figures at the end of the section.*

Insert Fig. 29

*Refs. [403, 430, 432, 433] appear in the caption of Fig. 29 and are reported here just to maintain consistent reference sequential numbering while appending the figures at the end of the section.*

Many studies have been done of the retention and emission of H implanted into materials to provide data needed to predict H retention in fusion reactor environments. Fig. 30 shows the retention of 1 keV deuterium implanted into Be at 300 K versus incident fluence, measured by thermal desorption [434]. D retention in Be was close to 100% at low fluences but saturated at high fluences. Earlier nuclear reaction analysis (NRA) measurements of D retained in Be within  $\approx 1 \mu\text{m}$  of the surface gave very similar results [435]. This saturation behaviour indicates that D implanted into Be at 300 K does not diffuse, but accumulates to a saturation concentration of  $\approx 0.3$  to  $0.4$  D/Be within the implantation zone. At high fluences the implanted zone becomes porous allowing additional implanted D to escape. This saturation mechanism is confirmed by electron microscopy which shows bubbles and porosity in the implantation zone after high fluence H implantation [417]. Saturation of retention by the same mechanism is observed for D implanted into stainless steel at 150 K where the D is not mobile [418]. H retention in Be increases with increasing ion energy and decreases with increasing sample temperature [427, 436]. The retention of 1 keV deuterium implanted into W at 300 K (shown in Fig. 30) also saturates at high fluence. At high fluences deuterium retention in W is higher at 500 K than at 300 K [437]. Comparison between total retention measured by thermal desorption spectroscopy (TDS) and near-surface retention measured by NRA indicates that in W much of the D is retained beyond the range of implantation [426, 438]. Retention of H implanted in W is due to trapping at defects and precipitation into bubbles.

Insert Fig. 30

Fig. 31 shows retention of deuterium and tritium as a function of incident particle fluence from a set of high-fluence experiments in which Be specimens were exposed to laboratory ion-beams (INEEL, UTIAS), linear plasma devices (SNL/LANL-TPE, UCSD-PISCES-B), a tokamak divertor plasma (DIII-D-DiMES), and a neutral beam (NB-JET). In some of these studies carbon deposition or formation of carbide or oxide surface layers occurred which is likely to affect D retention. The figure shows the D retention in Be observed under a wide range of exposure conditions. The high-fluence saturated retention tends to be lower at higher temperatures.

Insert Fig. 31

Fusion neutrons will create vacancies and interstitials in plasma-facing materials. For metals at reactor wall temperatures, these defects will be mobile and will annihilate at sinks (e.g., surfaces or grain boundaries), recombine, or agglomerate into defect clusters.

Vacancy agglomeration may also lead to formation of voids. In beryllium, neutron-induced nuclear reactions produce helium and tritium (Sect. 5.6.1) which may be trapped at defects or precipitate as gas bubbles. These defects, resulting from neutron irradiation, will increase the retention of hydrogen from the plasma, by increasing the concentration of sites where diffusing hydrogen can precipitate as gas or become trapped as atoms. The effect of neutron irradiation on hydrogen retention in metals is complex, but, in principle, this can be modelled by the formalism described above, providing the material parameters are known, such as hydrogen diffusivity, solubility, trap binding energy and defect microstructure produced by the neutron irradiation. For many metals, most of these parameters are known well enough to attempt such modelling. For beryllium, however, uncertainty in solubility, diffusivity and trapping of hydrogen make such modelling of hydrogen retention difficult.

Tungsten might be especially susceptible to hydrogen retention at lattice defects due to neutron irradiation. However, there have been few experimental studies of this because of the intense radio-activation of tungsten upon neutron exposure. The activation energy for diffusion of H in W is low enough (0.39 eV [403]) for H to diffuse to the defects at temperatures where the defects themselves are immobile [439]. Furthermore, due to its low solubility in W, diffusing H will precipitate or be strongly trapped if it encounters open volume defects (see Table 8, Table 9 and Fig. 26). Retention of H at lattice damage in W will depend strongly on the temperatures of neutron irradiation and H exposure. H retention in W should decrease at temperatures above  $\approx 600$  K where H is thermally released from vacancies and vacancies become mobile [439].

### 3.5.3. Hydrogen retention in carbon

Carbon differs from metals in the behaviour of implanted hydrogen, mainly due to the C-H chemical reactivity. Implantation of hydrogen into carbon creates broken carbon bonds where hydrogen can be strongly bound through the formation of C-H chemical bonds. At low doses, hydrogen implanted into carbon is nearly all retained near the end of its implantation range. As the dose increases, the local hydrogen concentration increases until it reaches a saturation value that is about 0.4-0.5 H/C for carbon at room temperature and for incident H energy more than a few tens of eV. The saturation level decreases with increasing temperature [440, 441]. Additional hydrogen, implanted into a region already saturated, will either be released or transported further into the bulk via 'surface diffusion' of H atoms along internal porosity [442] as illustrated in Fig. 32. Fig. 33 shows an example of the saturation behaviour in the implantation zone [443]. The areal density of implanted hydrogen retained in the carbon therefore depends on the dose and energy as shown in Fig. 34 and Fig. 35, as observed by NRA and TDS measurements, respectively [443-445]. At low doses, the non-reflected hydrogen is all retained. At high doses, the H retention saturates at a value determined by the saturation concentration and the thickness of the saturated layer, and therefore on the incident energy of the hydrogen.

Saturation of hydrogen retention also occurs in other materials which form strong covalent bonds with hydrogen, for example boron and silicon [446]. Similar saturation of hydrogen retention is also observed in metals at low temperatures where the implanted hydrogen

cannot diffuse [418, 419]. Retention of hydrogen isotopes from tokamak plasmas implanted into carbon components typically saturates at coverages near  $10^{21}$  atoms·m<sup>-2</sup>.

Insert Fig. 32

*Ref. [207] appears in the caption of Fig. 32 and it is reported here just to maintain consistent reference sequential numbering while appending the figure at the end of the section.*

Insert Fig. 33

Insert Fig. 34

Insert Fig. 35

### 3.5.3.1. Bulk transport of hydrogen in carbon

The issues of bulk trapping of hydrogen and permeation of hydrogen into graphite beyond the range of implantation have also been examined. The permeation depends strongly on the microstructure of the graphite [207, 447–449]; (see Fig. 35). In high-density monocrystal graphite, there is essentially no permeation of hydrogen beyond the implantation zone and the fluence dependence of H retention is essentially flat once the implantation zone is saturated [207, 449]. In high density pyrolytic graphite, some increase in H retention with increasing incident fluence beyond the saturation fluence is observed, which indicates hydrogen transport further into the bulk [207, 447, 449]. As the graphite density decreases and porosity increases, bulk trapping increases [207, 447, 449, 450]; (see for example EK98 in Fig. 35). Long-range diffusion - beyond the implantation zone - due to bulk concentration gradients, is unlikely to occur in porous graphites such as EK98 [449] and POCO AXF-5Q [447], because the H will encounter micro-porosity or crystallite boundaries where it will exit the graphite lattice before it can diffuse very far. The observed uptake of hydrogen into porous nuclear graphites from low energy plasmas, can be accounted for by thermally activated atomic diffusion along internal surfaces of pores and grains within the material which gives retained concentrations on the order of 10 atomic parts per million (appm) [447, 450] and may extend millimeters into the material [451].

Some studies conclude that short-range atomic diffusion of hydrogen through the graphite lattice occurs at high temperatures (>1270 K) mainly along the basal planes [447, 452]. Recent measurements of CFC tiles from the JET divertor showed surprisingly large fractions of tritium in the bulk [453].

### 3.5.3.2. Trapping of hydrogen in carbon

In a reactor, fusion neutrons will cause atomic displacements in graphite, which may create traps for tritium. Trapping of hydrogen at lattice defects in graphite was therefore investigated in a series of experiments in which graphite was first irradiated with carbon ions to create traps, and then exposed to deuterium gas at 1470 K to load the traps with deuterium [448, 454–457]. Irradiation produced strong traps, with binding energies consistent

with C-H bond formation ( $\approx 4.5$  eV), and whose concentration saturated at about 1000 appm at damage levels above about 1 displacement per carbon atom (dpa). For comparison, the concentration of strong traps in graphites as manufactured, i.e., before ion irradiation, was typically in the range from 10 to 20 appm. An H451 graphite sample damaged by neutron irradiation had about the same D retention as graphite damaged by carbon ion irradiation, demonstrating that lattice damage by ion or neutron irradiation has similar effects on H trapping. Irradiation of graphite by fusion neutrons can thus be expected to produce strong traps that bind hydrogen even at high temperatures. However, the quantity of H retained in such traps in a fusion reactor will depend on whether the H is able to reach the traps. In general, more H will be trapped in graphites in which open porosity provides easier access of H to traps. Furthermore, for H to reach traps within the graphite lattice, it must diffuse into the graphite grains which can only occur at high temperatures ( $>1270$  K).

### 3.5.3.3. *Thermal release of hydrogen from carbon*

The concentration at which H retention saturates decreases when the carbon is at higher temperatures during the implantation [207, 440, 458] as shown in Fig. 36. This figure also shows the thermal release, due to isochronal annealing (see glossary), of deuterium implanted into carbon at room temperature [440, 459]. H implanted in graphite is thermally released at temperatures above about 800 K. The temperature at which hydrogen is thermally released from carbon films deposited by plasmas may be lower depending on the incident ion energy during deposition. For low energy deposition (ion energy less than tens of eV) the films contain more hydrogen and the hydrogen is thermally released at lower temperature, compared to films deposited with ion energies of a few hundred eV or more [460] (Sect. 3.2.6.4). Measurements of D retention by NRA and by TDS show similar deuterium retention levels at low fluences (Fig. 36) on temperature of implantation [207], confirming that the fraction of D retained beyond the range of the NRA analysis ( $\approx 1 \mu\text{m}$ ) is small for the fluences shown in the Fig. 36. This is consistent with localised D retention in the implanted region as shown in Fig. 33. For fluences  $> 10^{22} \text{ D}\cdot\text{m}^{-2}$ , TDS measurements may be higher than the NRA integrated measurement in the near-surface (Fig. 35) depending on the type of graphite.

*Insert Fig. 36*

### 3.5.3.4. *Isotope-exchange of hydrogen in carbon*

Experiments have shown that one isotope of hydrogen implanted to saturation into carbon can be displaced by subsequent implantation with another isotope [440, 446, 461, 462]. The implanted hydrogen competes locally with other hydrogen atoms already present for the limited sites. In saturation, the total incoming and outgoing fluxes are equal, but the isotopic mixture of the outflux is determined by the hydrogen isotopic composition of the saturated layer, not by that of the influx. This isotope-exchange has been modelled by local-mixing [446] or local-recombination [450, 458] models. In tokamaks with large areas of carbon facing the plasma, this isotope-exchange process strongly impacts plasma composition when the injected isotope is abruptly switched, for example from deuterium to tritium. Initially, tri-



tium injected into the plasma is implanted into deuterium-saturated carbon surfaces where it exchanges with deuterium which flows back into the plasma. Since the inventory of deuterium in the wall is much larger than the amount in the plasma, it takes many discharges for the plasma to become mainly tritium (Sect. 5.5). Similarly, tritium in saturated layers on plasma-facing surfaces may be replaced with deuterium by deuterium-fuelled plasma operation.

#### 3.5.3.5. *Ion-induced release of hydrogen from carbon*

Energetic particle bombardment also causes release of hydrogen from carbon by processes other than isotope-exchange (Sects. 4.6.3 and 5.5 for discussion on wall recycling). Carbon implanted to saturation with hydrogen releases hydrogen when bombarded by non-hydrogenic ions such as helium or carbon, even when the ions are sufficiently energetic to pass through the saturated layer [450, 463–465]. Fundamental mechanisms involved in ion-induced release are not well understood, but the process can be modelled by a transport equation with a fixed concentration of traps. The model includes terms for trapping, thermal de-trapping, and an ion-induced de-trapping rate that depends on the energy deposited into atomic collisions by the bombarding particles. This release process appears to occur via local (i.e., internal) molecular recombination followed by rapid escape of the molecules possibly via interconnected micro-porosity [450, 458, 464, 466, 467]. In metals at temperatures where H can diffuse through the lattice, ion-induced release of H by internal recombination is unlikely, since molecular recombination would only occur at the external surface. In the metal case, however, ion-induced desorption of H adsorbed on the surface might occur, through a process closely related to sputtering.

Helium discharge conditioning or high-power low-density helium fuelled plasmas remove hydrogen from tokamak walls by ion-induced release [465]. After such conditioning, the hydrogen content of the wall is below saturation and the wall has capacity to retain or pump incident energetic hydrogen until it again becomes saturated. Retention of charge-exchange neutrals over large areas by this mechanism reduces neutral density at the plasma edge. The wall pumping capacity can be large and persist for many shots since moderate particle fluxes over large areas are involved.

#### 3.5.3.6. *Co-deposition*

In a tokamak, physical and chemical sputtering will produce an outgoing flux of carbon atoms and C/H-containing molecules/radicals from carbon plasma-facing surfaces. In general, there will also be an incoming flux of carbon atoms. If the outgoing carbon flux exceeds the incoming carbon flux, the surface will undergo net erosion. In tokamaks, the flux of energetic hydrogen onto such surfaces is usually high enough that the surface remains saturated with hydrogen as it erodes. In this case, the hydrogen coverage remains constant. However, if the outgoing carbon flux is less than the incoming flux, net deposition of carbon occurs. The deposited carbon becomes part of the hydrogen-saturated layer, which now increases in thickness with time. This leads to a hydrogen coverage, which increases linearly with exposure time. This process, often referred to as 'co-deposition', is the dominant process

for long-term retention of hydrogen isotopes in tokamaks with carbon PFCs (Sects. 4.7 and 5.6). The H content of the co-deposited material depends on the energy of the incident particles and on the substrate temperature during the deposition. Near room temperature hard films with  $H/C \approx 0.4$  form if the incident particle energy is high ( $\geq 100\text{eV}$ ) that are similar to carbon implanted to saturation by energetic H. Deposition from low temperature plasmas where the incident particle energies are low ( $\ll 100\text{eV}$ ) gives softer low density polymer-like films with higher H content  $H/C \approx 0.8-1$  [460]. In tokamaks, such low density films may be deposited from low temperature detached plasmas in the divertor. Compared to the hard films, the soft films are less stable and decompose at lower temperatures and under energetic particle bombardment [450, 468]. A key difference between hydrogen retention by implantation and co-deposition is the thickness of the hydrogen containing layer, which is unlimited for co-deposition but is limited to the ion range (tens of nm, depending on ion energy) for implantation.

Co-deposition of hydrogen with re-deposited metal atoms has also been examined. Fig. 37 shows deuterium retained in re-deposited beryllium films, produced by collecting sputtered Be from plasma and ion-beam exposed Be targets [469, 470]. The collecting surfaces were exposed to energetic deuterium at fluxes sufficient to saturate D retention in the deposited material. D concentrations were measured using NRA, and impurity concentrations were measured using proton back-scattering analyses. In Be with low oxygen content, the retained D concentration is much lower than in co-deposited carbon films. However, in Be with higher oxygen and carbon content, the concentration of retained D is relatively higher and approaches that of carbon.

*Insert Fig. 37*

Table 8: Values of binding enthalpy (eV) of H to vacancies relative to a solution site ( $Q_i$  shown in Fig. 26) at low occupancy in several metals obtained both from experiments and from first principles calculations.

<i>Metal</i>	Experiment		Effective medium theory
	Internal Redistribution	Positron Annihilation	
Al	0.52	0.53	0.52
Fe	0.63		0.83
Ni	0.44	0.58, 0.44	0.52
Cu	0.42	0.4	0.37
Zr	0.28		
Mo	1.03	1.4	0.96
Pd	0.23		0.16
Ta	0.42	1.2	
W	1.04 (a)	1.16 (b)	1.15 (c)
Be			1.65 (d)

(a) Thermal desorption [400]

(b) Perturbed angular correlation [401]

(c) [399]

(d) Density functional theory [402]

Sources for values not referenced here are given in Ref. [376].

G. Federici, C.H. Skinner, et al.

Table 9: Binding enthalpies (eV) of hydrogen to helium bubbles in metals.

Metal	Experiment			
	Internal Redistribution	Gas phase equilibration		
Al	0.52		0.52	
Fe	0.78	0.81	0.91	0.73
Ni	0.55	0.52	0.66	0.6
Mo	1.15		0.98	1.3
Pd	0.29		0.35	0.35-0.43
Ta	0.53		0.69	
stainless steel	0.42			
Inconel	0.45			
W			1.15 (a)	1.8 (b)

(a) [403]

(b) [399, 404, 405]

Sources for values not referenced here are given in Ref. [376]

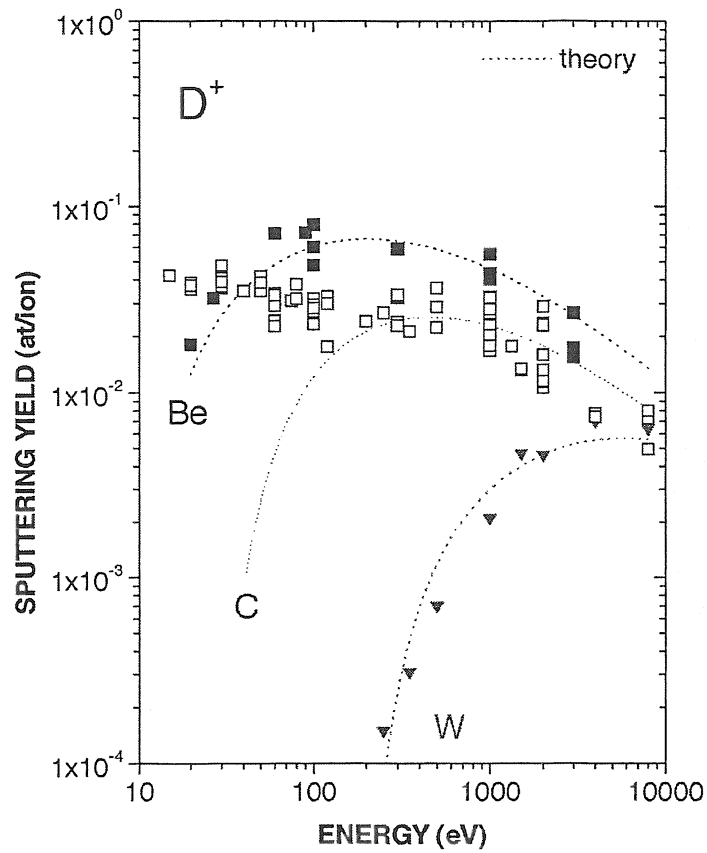

Figure 11. Comparison of measured values for the sputtering yield at normalised incidence for Be (closed squares), C (open squares), and W (closed triangles) by deuterium ions with results from analytic modelling of physical sputtering [267] (dotted lines). The experimental data were obtained from the weight loss of polished samples after ion bombardment. The divergence between experimental points and modelling for carbon at low energies is due to chemical effects not included in the model.

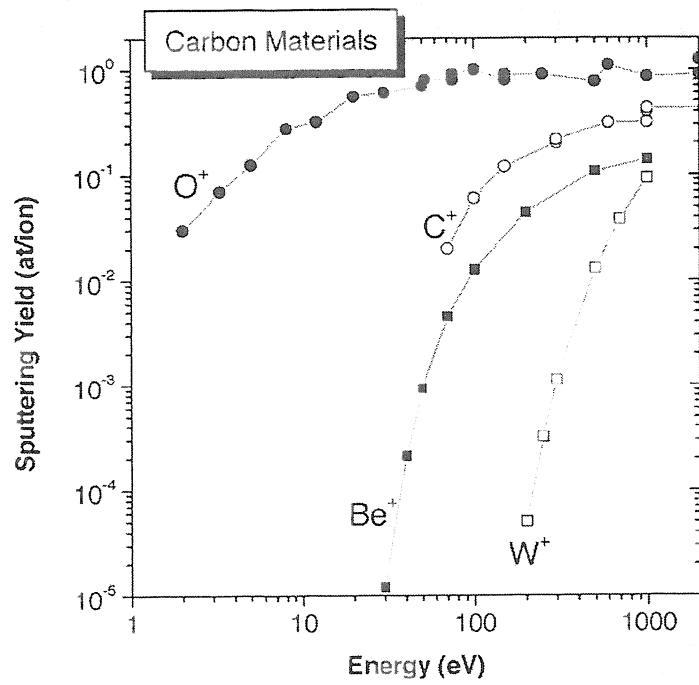
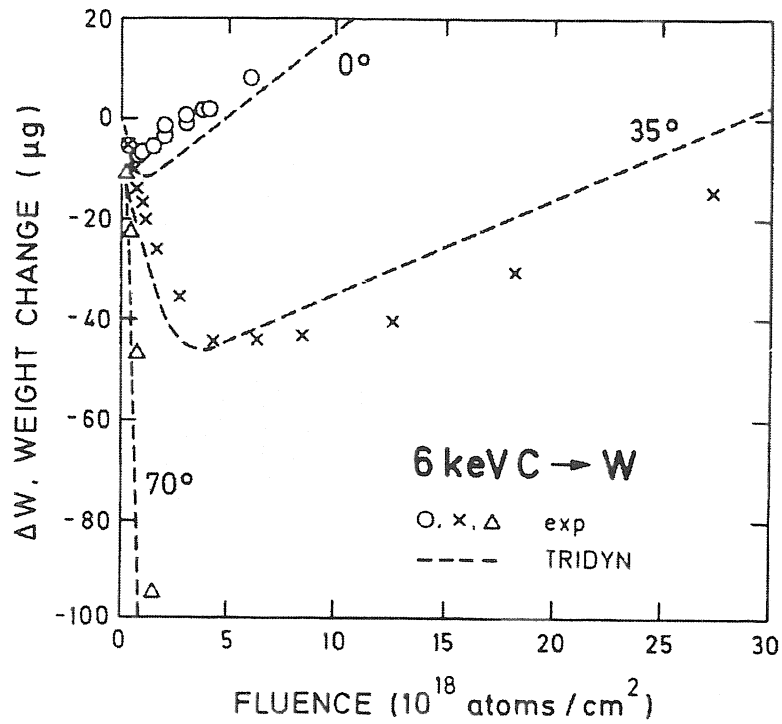

Figure 12. Sputtering yields of carbon materials by typical impurity ions: Measured values for  $O^+$  [280] and  $C^+$  [281] and TRIM-SP computer simulations for  $Be^+$  and  $W^+$  [279].



**Figure 13.** Fluence dependence of the weight loss of a W sample bombarded by 6 keV C<sup>+</sup> at different angles of incidence. The dashed lines are the predictions of a Monte-Carlo code, TRIDYN; (reproduced with permission from [283].)

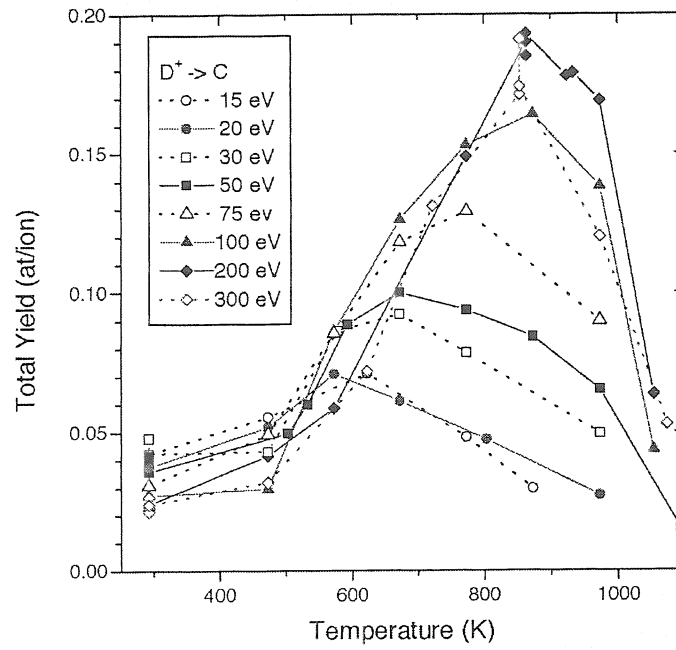
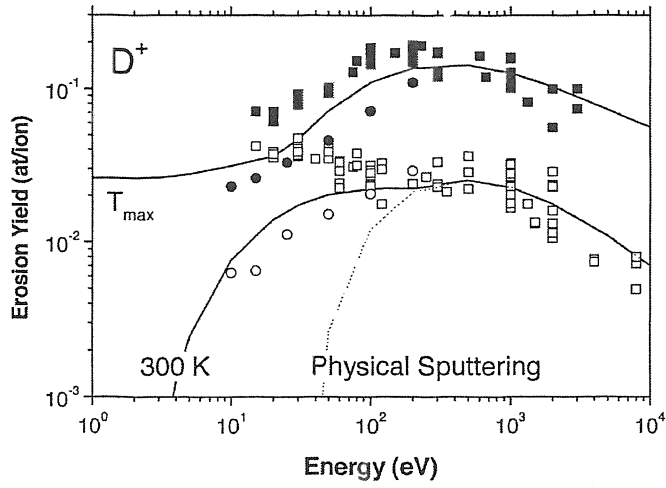
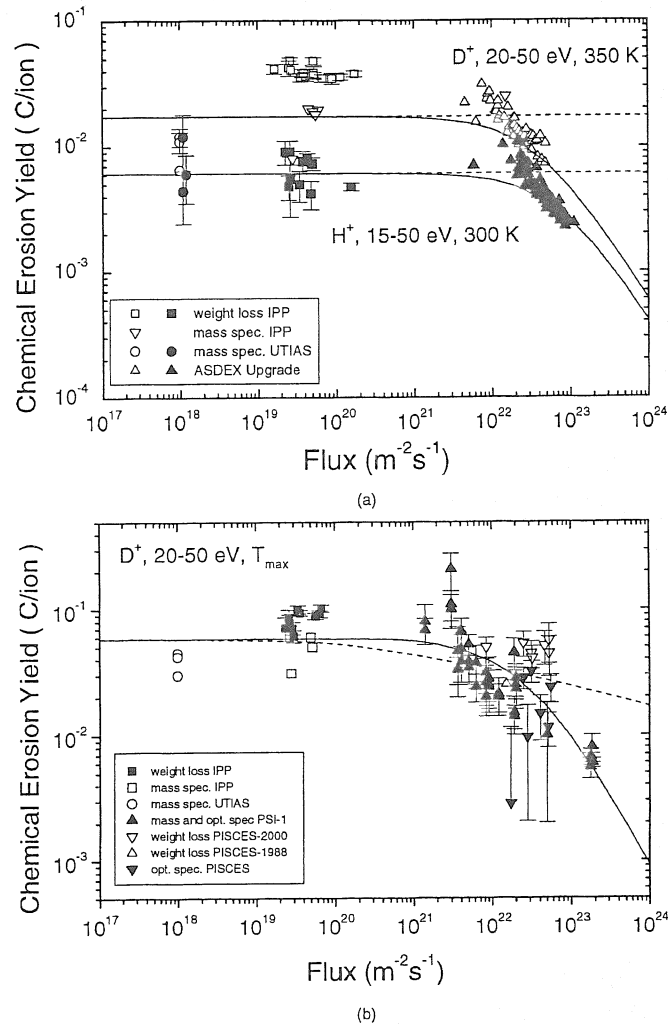

Figure 14. Temperature dependence of the erosion yield of pyrolytic graphite by deuterium ions at different ion energies as measured by weight loss [289].





**Figure 15.** Energy dependence of the erosion yield of carbon by deuterium ions at room temperature (open symbols) and at the maximum temperature for chemical erosion,  $T_{max}$ , (solid symbols) (see Fig. 14). Squares are weight loss data collected in [289], circles are total erosion data from mass spectroscopy [288]. Solid curves are from an analytic model [285]. Physical sputtering is also shown (dotted line.)



**Figure 16.** Flux dependence of the chemical erosion yield of carbon with deuterium ions near (a) room temperature and (b)  $T_{max}$ . The data combine weight loss and spectroscopic measurements from ion-beam experiments [288, 289, 302, 303], spectroscopic measurements from plasma simulators [295, 296, 304, 305] and from the ASDEX-Upgrade divertor [298]. The curves are fits to the data using the models described in [285, 293].

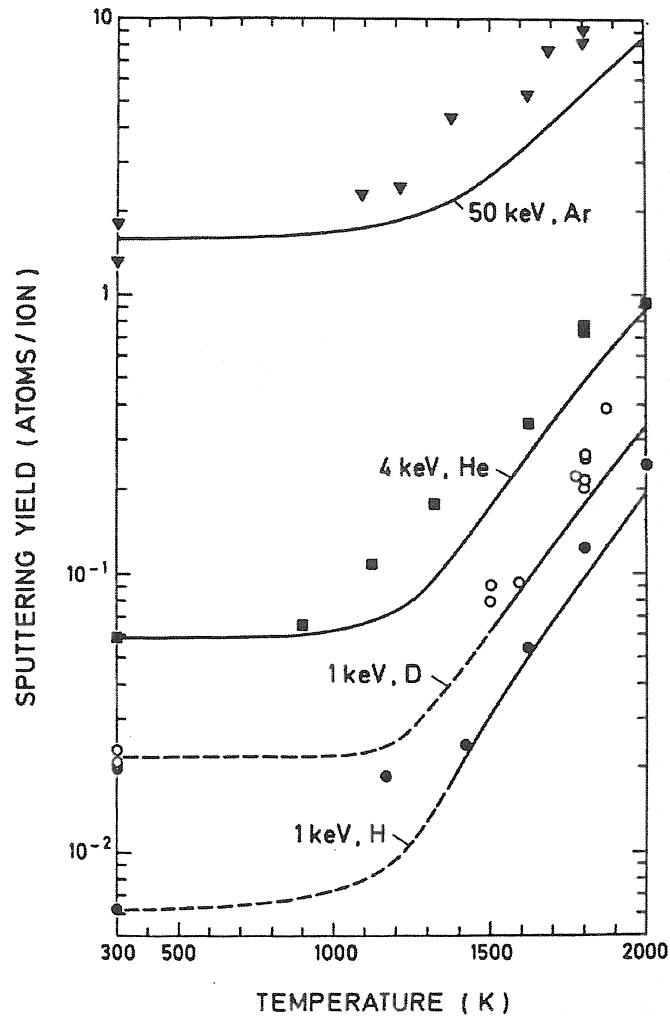

Figure 17. Temperature dependence of the sputtering yield of pyrolytic graphite by  $H^+$ ,  $D^+$ ,  $He^+$ , and  $Ar^+$  in the temperature range of RES. Solid curves are from the model described in Ref. [330]; (reproduced with permission from [330].)

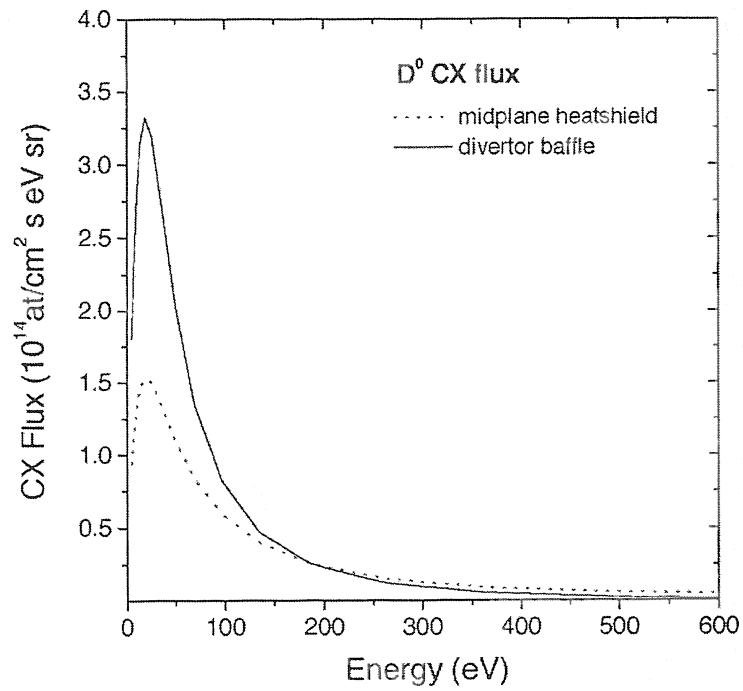

Figure 18. Energy distribution of the charge-exchange neutral flux to the inner heat-shield and the divertor baffle of ASDEX-Upgrade as calculated using the B2/EIRENE code [156].

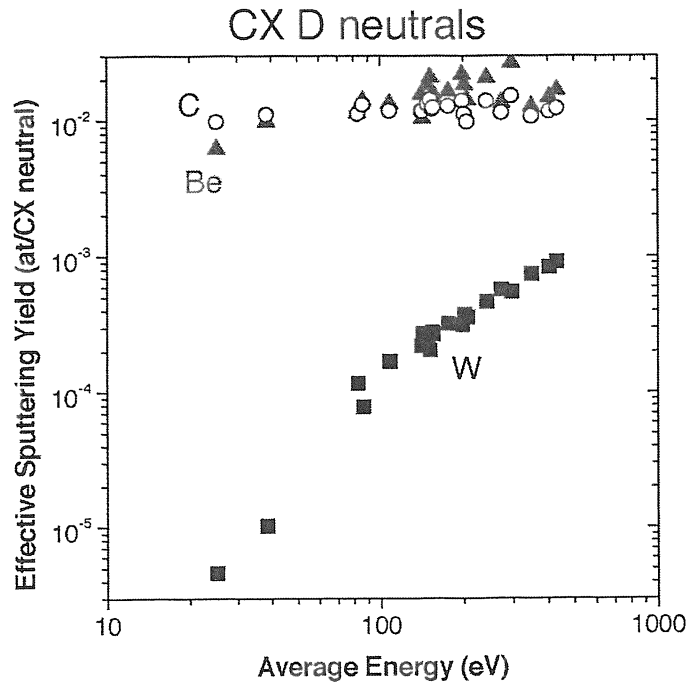
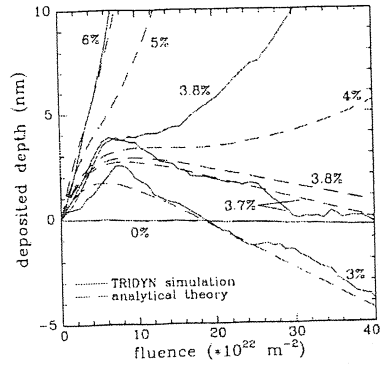
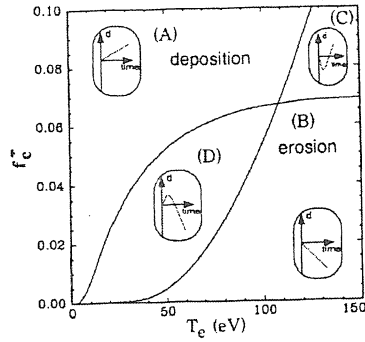

Figure 19. Dependence of the effective sputtering yield of Be, C, and W by deuterium charge-exchange neutrals on the average energy of the neutrals [156].



(a)



(b)

Figure 20. (a) Fluence dependence of the deposited depth for W bombarded with deuterium ions from a 20 eV divertor plasma with various levels of carbon impurities; (reproduced with permission from [335]). (b) Boundaries of erosion and deposition conditions for W bombarded with deuterium ions depending on plasma electron temperature,  $T_e$ , and carbon impurity content,  $f_c$ . The four possible time developments (A-D) are schematically indicated in the figure in their region of validity; (reproduced with permission from [335].)

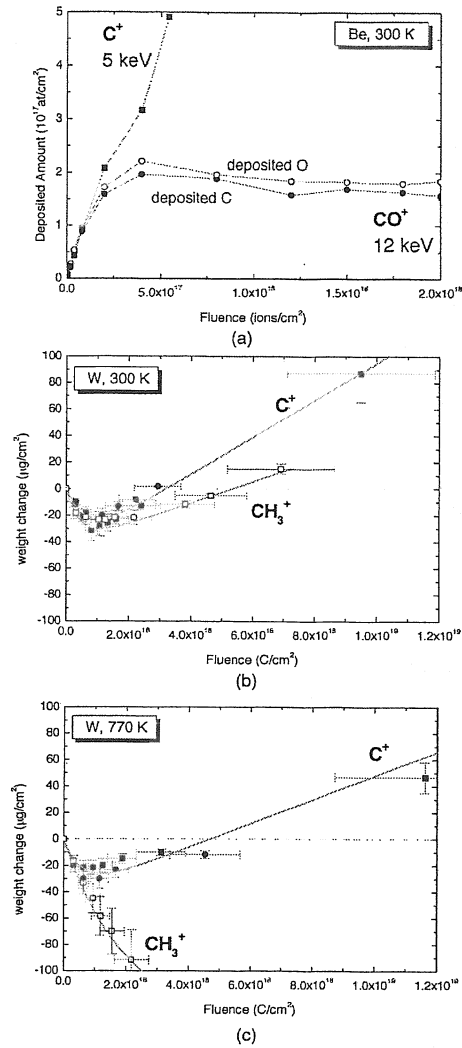

Figure 21. (a) Fluence dependence of the deposited amount of atoms during the bombardment of Be with 5 keV  $C^+$  or 13 keV  $CO^+$  [338]; (b) Fluence dependence of the weight loss during the bombardment of W with 3 keV  $C^+$  or 3 keV  $CH_3^+$  [339] at 300 K; and (c) same as (b) but at 770 K.

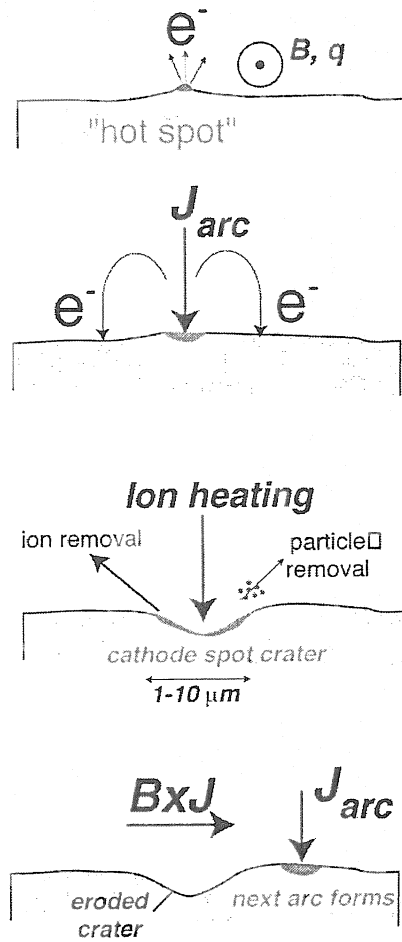

Figure 22. Schematic of typical arc history at the plasma-facing wall of a tokamak.



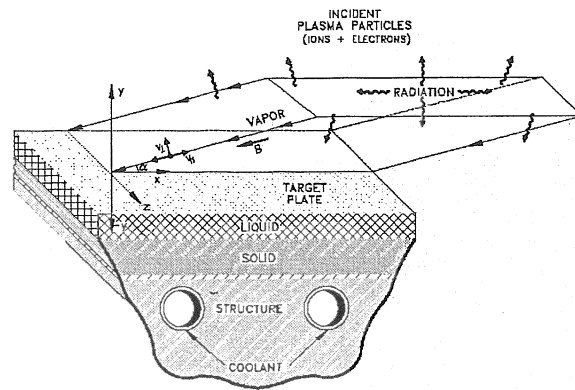

Figure 23. Schematic illustration of different interaction zones during a plasma disruption; (reproduced with permission from [357].)

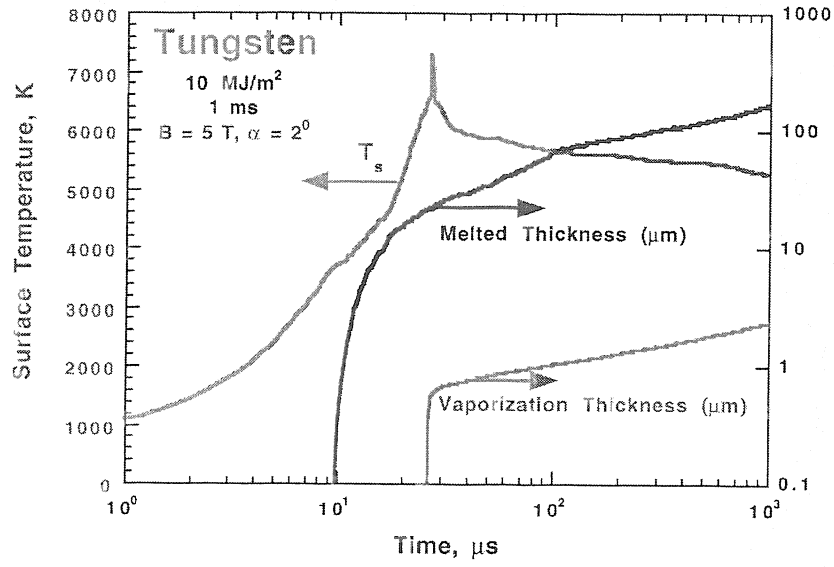

Figure 24. Time evolution of tungsten surface temperature, melt layer, and eroded thickness following a plasma disruption [363].

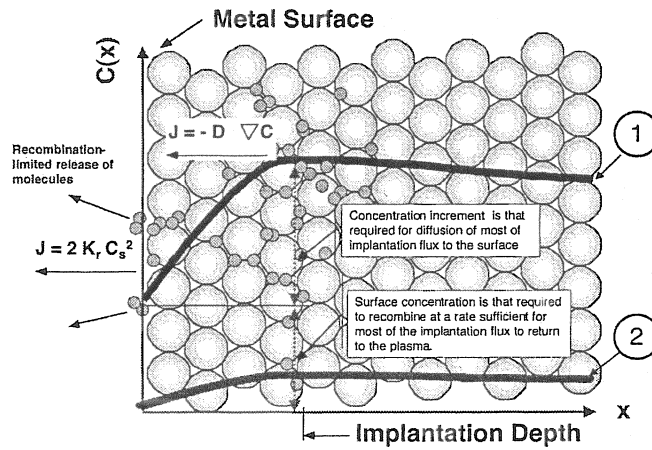

Figure 25. Schematic diagram showing main transport mechanisms for hydrogen migration and release at a surface of a metal subject to implantation of energetic particles. The concentration profile is also shown for two cases: (1) with a high near-surface concentration resulting from a sluggish re-emission from the surface, and (2) with a lower near-surface concentration resulting from an enhanced re-emission of implanted flux to the plasma. This, in turn, means a reduced driving potential for diffusion into the bulk; (figure provided by G. Longhurst, INEEL, Idaho Falls.)

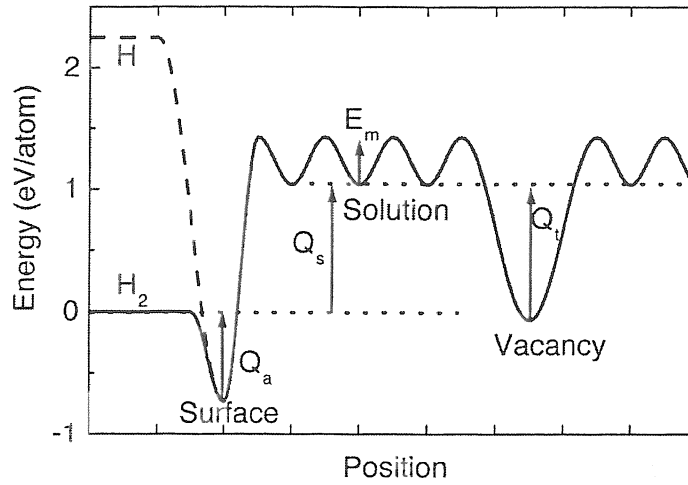

Figure 26. Potential energy diagram for hydrogen in tungsten. Enthalpy of solution  $Q_s=1.04$  eV [403], activation energy for diffusion  $E_m=0.39$  eV [403], binding enthalpy of hydrogen to a vacancy  $Q_t=1.1$  eV [400, 401], enthalpy of adsorption  $Q_a=0.7$  eV [404, 405]. The activation energy for detrapping is  $Q_t+E_m$ .

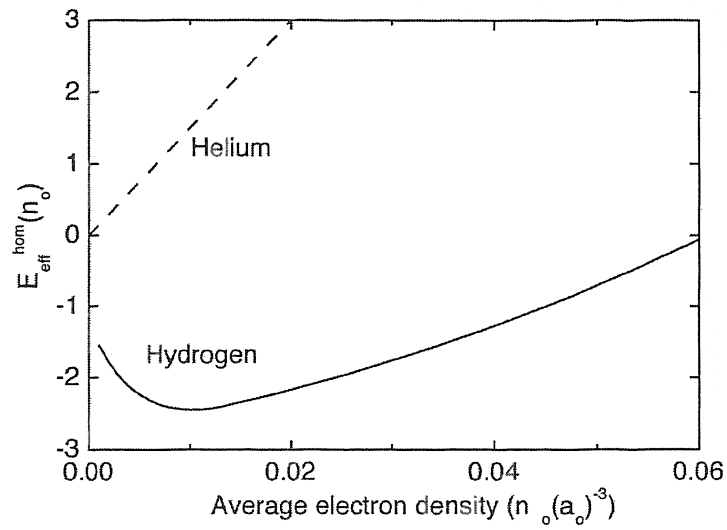

Figure 27. The binding energy of a hydrogen or helium atom in a homogeneous electron gas as a function of average electron density in units of electrons/ $a_0^3$ , where  $a_0$  is the Bohr radius.

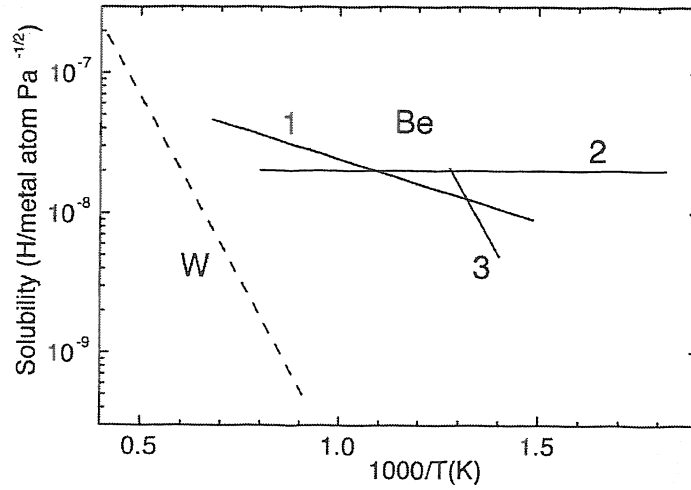

Figure 28. Measured solubility of hydrogen in tungsten (dashed line [403]) and beryllium (solid lines 1 [413], 2 [430] and 3 [431].)

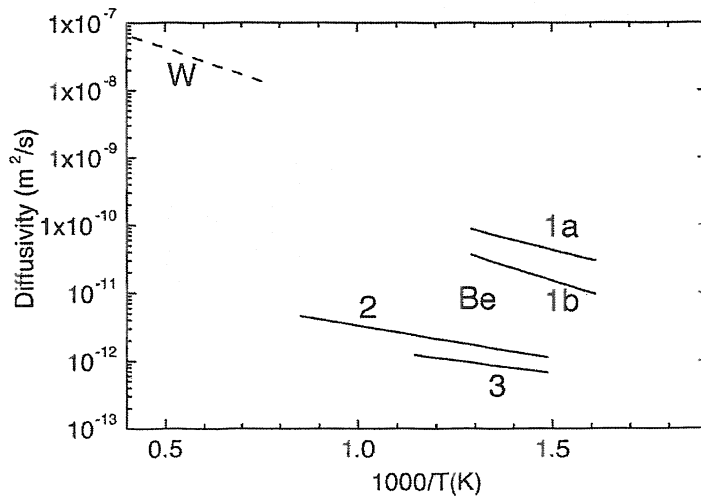

Figure 29. Measured diffusivity of hydrogen in tungsten (dashed line [403]) and beryllium (solid lines 1a&b [432], 2 [430] and 3 [433].)

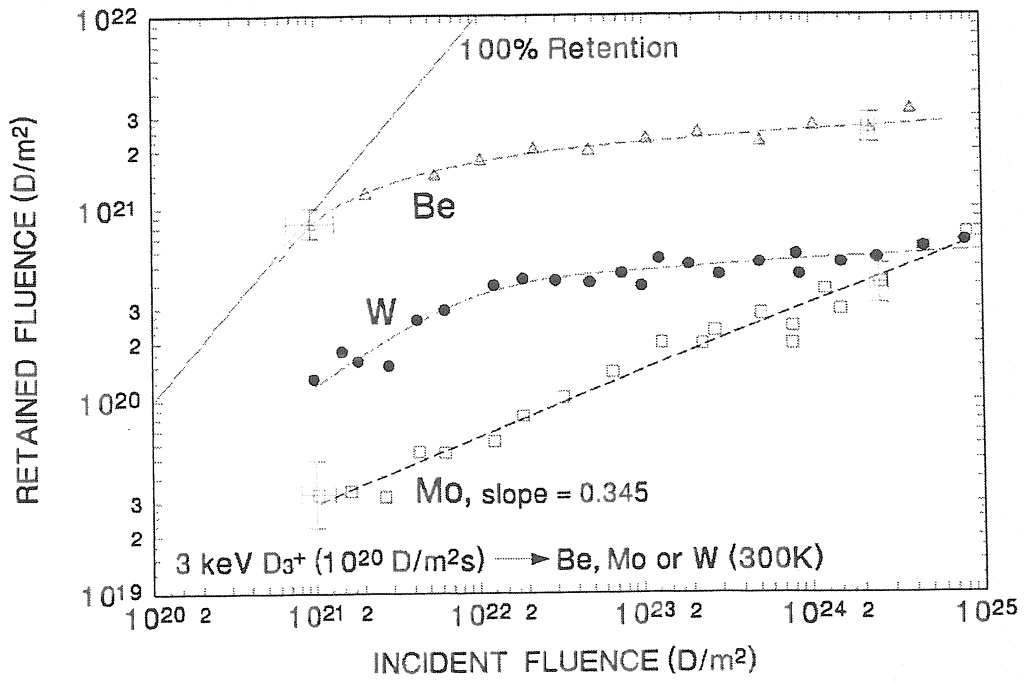
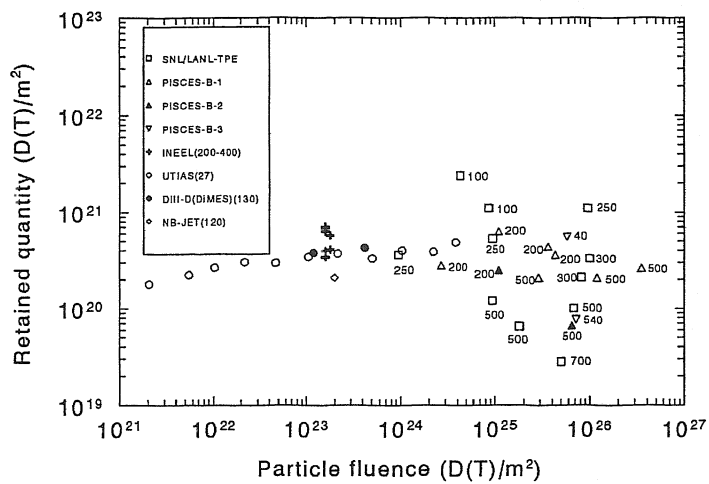

Figure 30. Retention of 1 keV deuterium implanted into Be and W, at 300 K versus incident fluence, measured by thermal desorption; (reproduced with permission from [434].)





**Figure 31.** Retention of deuterium and tritium in Be as a function of incident particle fluence [427]. For purposes of comparing results from different experiments using different ion energies, the data have been scaled to correspond to an equivalent 100-eV deuterium ion energy. Numerical values next to the symbols and in the legend are specimen exposure temperatures, in degrees Celsius; (reproduced with permission from [427].)

G. Federici, C.H. Skinner, et al.

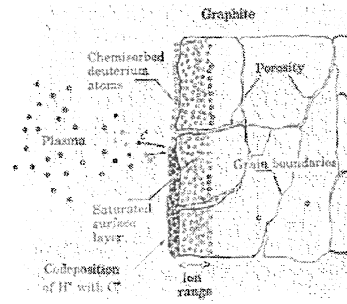

Figure 32. Illustration of hydrogen retention and transport in graphite; (reproduced with permission from [207].)

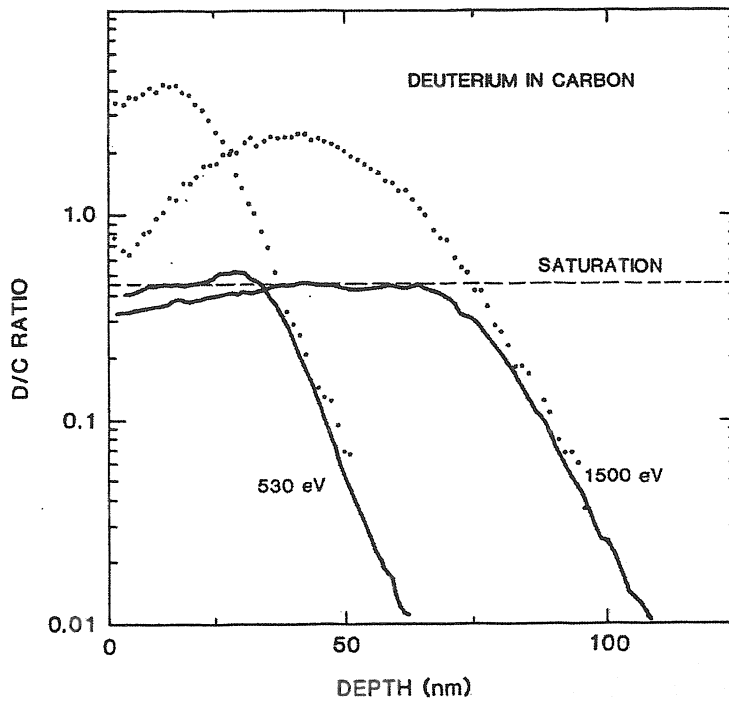

Figure 33. Depth profiles measured by secondary ion mass spectroscopy (SIMS) of deuterium implanted at 530 and 1500 eV into carbon at room temperature at fluences of  $10^{22} \text{ D}\cdot\text{m}^{-2}$  (solid lines) and  $10^{20} \text{ D}\cdot\text{m}^{-2}$  (dotted curves). For comparison, the low dose curves are scaled up by a factor of 100; (reproduced with permission from [443].)

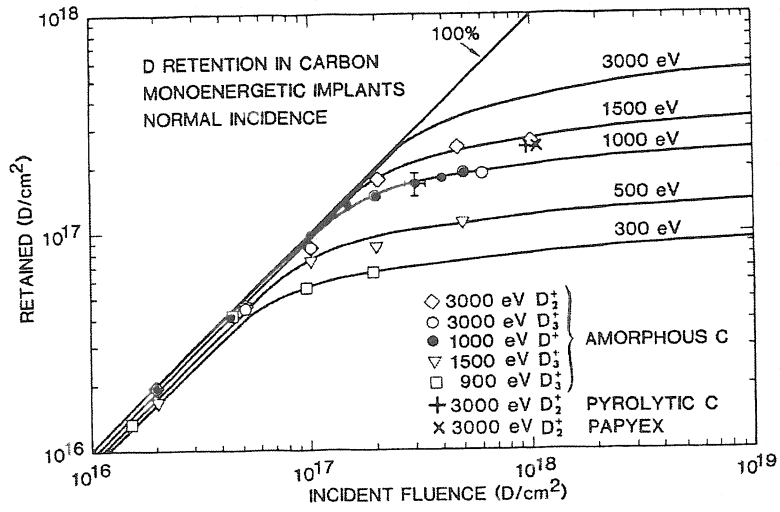

Figure 34. Areal density of implanted deuterium retained in carbon versus incident fluence for different energies, measured by NRA (symbols) and calculated (curves) using implantation profiles and a saturation concentration of  $D/C=0.44$ ; (reproduced with permission from [443].)

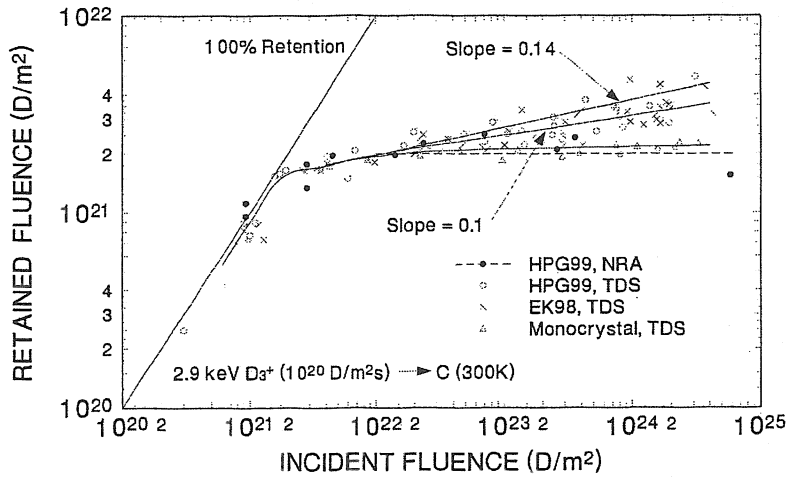
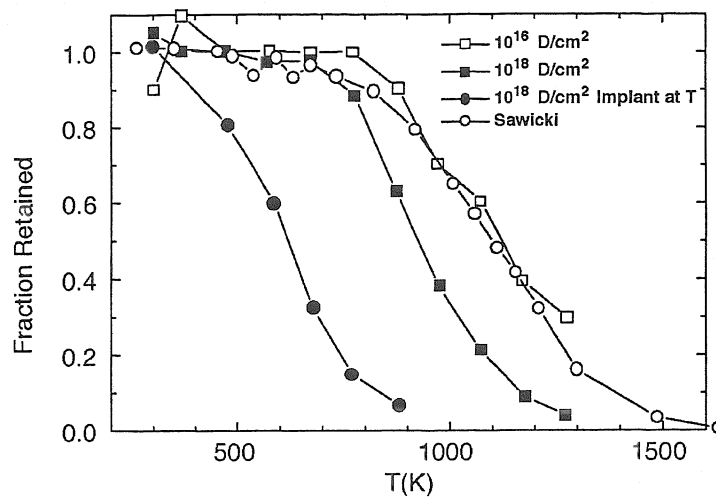
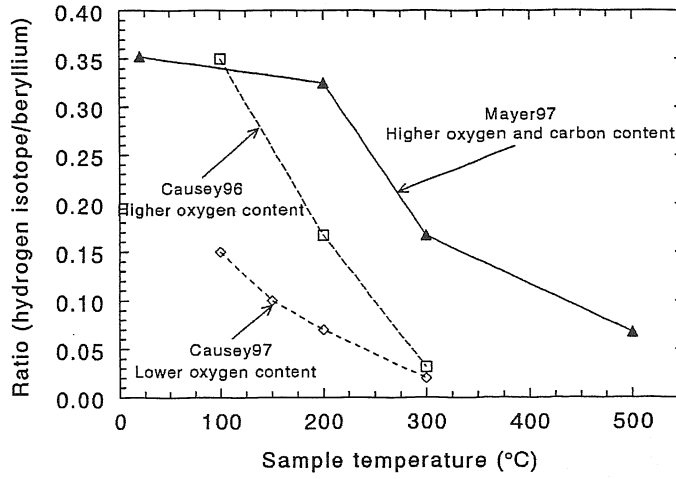

Figure 35. Retention of deuterium implanted in various types of graphite versus incident fluence; (reproduced with permission from [445].)



**Figure 36.** Relative D retention in carbon versus temperature measured by NRA [440]. Squares show D retained after implantation at room temperature to doses of  $10^{20} \text{ D}\cdot\text{m}^{-2}$  (open) and  $10^{22} \text{ D}\cdot\text{m}^{-2}\cdot\text{s}^{-1}$  (filled) followed by five minute anneals at each temperature. The dots show relative retention of D implanted to saturation at the indicated temperature. The open circles show release of implanted tritium during isochronal annealing reported by Sawicki et. al. [459]; (reproduced with permission from [440].)



**Figure 37.** Comparison of hydrogen isotope retention in beryllium films produced by collecting sputtered Be from plasma and ion-beam exposed Be targets. Data correspond to experiments with the TPE simulator (Causey [469]), and experiments with an ion-beam (Mayer [470]); (reproduced with permission from [427].)

## 4. EXISTING EXPERIMENTAL DATABASE ON PLASMA-MATERIAL INTERACTIONS IN TOKAMAKS

### 4.1. Introduction

This section is devoted to reviewing the rich experience of PMIs gained in present and past tokamaks and other devices. A brief survey of the diagnostic tools (Sect. 4.2) used to provide data on PMIs begins the section. Erosion of the wall material due to plasma flux, arcing and disruptions is the primary driver for PFC lifetime and for the influx of impurities into the plasma and is the subject of the following three sections. Recycling of hydrogen isotopes between the plasma and the wall has a major influence on plasma behaviour and is reviewed in Sect. 4.6. Co-deposition of hydrogen isotopes with eroded carbon, tritium retention and removal issues are the subject of Sect. 4.7. Flaking of co-deposited layers and dust generation issues are discussed in Sect. 4.8.

### 4.2. Measurements of Plasma-Material Interactions

Boundary plasma diagnostics are highly developed and have been reviewed in numerous books and articles (e.g., [471–473]). However, diagnostics to characterise the surface of PFCs during a discharge have not received the same attention by the plasma physics community, in spite of the powerful effect the wall condition has on plasma performance [474].

Diagnosing the full range of PMIs in tokamaks presents a formidable challenge. The physical processes under examination cover several orders of magnitude in time (e.g.,  $10^{-3}$ s for an ELM, to  $>10^8$  s of exposure in an operating reactor) and scale length ( $10^{-10}$  m per monolayer, to  $10^{-2}$  m thick target plates). This range has provided a clear division in current tokamak PMI studies between *instantaneous* interactions (e.g., sputtering) and long-term, effects (e.g., net erosion of target plates). From the point of view of the plasma physicist, the instantaneous effects are of greatest interest since they determine the local and global plasma performance via impurity radiation losses and core fuel dilution. Conversely, the engineer's primary interest is the macroscopic viability of the PFCs against net erosion or neutron damage. There has been greater focus on in-situ instantaneous measurements, since these yield the most vital information for current operating tokamaks. However, any substantial advances by tokamaks toward power production will necessitate the inclusion and integration of both fields of study.

The two most common methods to assess instantaneous PMIs are optical emission spectroscopy and mass spectroscopy. Optical emission spectroscopy involves measurement of neutral and low ionisation states of atoms and molecules entering the plasma after being sputtered from the wall. This has the benefit of being a remote, non-intrusive method that only needs a line-of-sight to the area of interest. It also provides unambiguous discrimination between atomic and/or molecular species. At its simplest, it provides a relative measure of particle loss from the surface. By including the particulars of the atomic physics (ionisation, excitation, etc.), it can provide in-situ impurity densities or efflux from surfaces [475, 476] and an evaluation of sputtering yield when combined with simultaneous measurements of incident flux. CD molecular band emission is related to hydrocarbon efflux from surfaces,



however, uncertainties over photon efficiencies of CD band emission as a function of plasma density and temperature have hampered efforts to obtain unambiguous data (Sect. 3.2.3) [301, 477, 478]. Spectroscopy is also used to assess the core plasma's impurity contamination [479].

Mass spectroscopy is universally used to assess vacuum wall "conditioning" (i.e., hydrogenic wall loading, leak rates, etc.), but is usually accomplished "off-line" (without plasma or during low density discharge cleaning). Sniffer probes [480] provide localised mass spectroscopy at limiting surfaces and have been used to measure the instantaneous chemical erosion yield (Fig. 38), while recently developed Penning gauge spectroscopy allows real-time monitoring of tritium release from the walls [481].

*Insert Fig. 38*

Almost all PMI measurements need simultaneous high quality edge plasma diagnosis in order to obtain reliable, quantitative results. This is indeed the greatest limitation to PMI studies, since unlike the toroidally and poloidally symmetric core plasma, the edge plasma conditions vary considerably poloidally (and even toroidally). Little quantitative data are available from experiments for the species composition and energy distribution of the particle flux impacting on surfaces [482], despite the existence of suitable instruments for some time (e.g., [483, 484, 474]). Measurements of the total flux by Langmuir probes are open to interpretative difficulties due to the lack of knowledge of the average charge state of the impacting ions. The assumptions about the edge plasma (uniformity, quiescence, etc.) that are used to simplify interpretation are often too restrictive. For example, the transient effects of ELMs are usually ignored, although ELMs may represent a substantial portion of the heat flux incident at the wall (Sect. 2.3.2.3). Rapid events, like ELMs, and short plasma scale-lengths at regions of intense PMI (e.g.,  $\approx 1\text{-}5$  cm at the divertor strike-points) further complicate complete diagnosis by the standard edge measurements, such as Langmuir probes [485]. Also, the experimental nature of present tokamaks leads to large variations in plasma shape, power density and heating scenarios, while little experimental time is dedicated to PMIs exclusively. Hence, data from PMI diagnostics, such as an element's atomic line intensity or partial pressure, are usually interpreted with little knowledge of the specific plasma-wall conditions that caused them. This qualitative interpretation of PMI data has led to each tokamak dealing with their PMI issues in an anecdotal fashion, increasing the difficulty of extracting a consistent physical picture of PMI from the collection of tokamak experiments. Ironically, many of the dramatic improvement of tokamak performance are linked to improvements in PFC conditioning (e.g., H-mode, VH-mode, supershots, see Sects. 1.2.3 and 4.6). This clearly points out the need for dedicated PMI studies in existing tokamaks.

The most common method of measuring net PMI changes in current tokamaks is an *archaeological* one. A material component is inserted at the wall and removed for study at the next vacuum break, which is typically several months of calendar time and hours of plasma exposure (e.g., [486-489]). Sophisticated surface analysis tools are brought to bear and detailed and important information on the composition and physical structure of

the components is gained. However, the wide variety of conditions experienced during a typical campaign makes it difficult to link such archaeological data to plasma performance. As with the instantaneous PMI measurements, this technique suffers greatly from a lack of experimental control and plasma diagnosis. This makes direct extrapolation of archaeology results (e.g., tritium retention, erosion rates) to reactor-class tokamaks very doubtful.

Remote manipulation systems for material samples have been used to obtain better controlled net PMI data in both limiter (TEXTOR [490]) and divertor plasmas (JET [491], DIII-D [109, 492], ASDEX-Upgrade [493]). These usually involve controlled exposures to well-diagnosed plasmas for short durations. Exposed materials are designed such that post-exposure analysis provides details about small net changes to the material (e.g., depth markers can provide  $< 1$  nm resolution).

Both archaeological and retractable samples rely heavily on ex-situ ion-beam analysis techniques to measure the net changes in the surface properties. For example, Rutherford Back-scattering Spectroscopy (RBS) of implanted depth-markers can provide  $< 10$  nm resolution for net changes in sample thickness and  $< 1$  monolayer sensitivity of high-Z deposited elements [494]. NRA can measure the near-surface ( $< 10 \mu\text{m}$ ) quantity of co-deposited hydrogenic fuel species. There are two principal limitations for the use of retractable probes. The first is the limited geometric access and coverage available for the probes. The second is the very temporary nature of the sample materials in the vessel (which provides in some sense the temporal resolution) means that they do not exactly reflect the material properties of intrinsic wall components. This is especially important in a device with multi-species PFCs, such as in the ITER design, where the surface composition can be substantially altered by material mixing.

Measurements of erosion and deposition are nevertheless becoming more sophisticated. Several optical techniques, offering the promise of remote, real-time monitoring of net erosion/re-deposition, have been recently developed (see Table 10: colorimetry, ellipsometry, speckle interferometry). However, colorimetry and ellipsometry are limited to measuring small net changes ( $< 1 \mu\text{m}$ ) and are dependent on the optical properties of the eroding/depositing material, making interpretation of multi-species components difficult.

In-situ diagnosis for the quantity of co-deposited/trapped hydrogenic species in wall components is complicated by the need to invoke the release of the trapped gas from the material. This involves some bulk or surface heating of the material, making the techniques complicated mechanically.

Of all the PMI diagnostic techniques listed in Table 10, only emission spectroscopy and infrared thermography are universally used in existing tokamaks. Most tokamaks contain a small subset, or have only temporarily installed, these "dedicated" diagnostics. This situation has necessarily hindered the maturation of PMI diagnostic techniques. Embedded thermocouples, although used for decades in tokamaks, have been recently used to provide measurements of incident power flux in regions of co-deposition [495], overcoming problems associated with IR thermography in these areas and helping to determine the power split between ion and electron channels (as derived from target probes). Solid-state microsensors have been used [483, 484] to determine the fluence and energy distribution of the hydrogenic

particle flux to surfaces but further improvements, such as measurements of the species composition of the impacting flux, will require development of new diagnostics.

*Insert table 10*

*Refs. (a [475], b [476], c [496], d [480], e [497], f [498], g [499], h [500], i [501], j [502], k [503], l [504], m [505], n [506], o [353], p [507], q [508], r [509], s [510], t [511], u [109], v [492], w [493], x [486], y [512], z [112], aa [513], ab [514], ac [515], ad [516], ae [517], af [518], ag [110], ah [519], ai [520], aj [521], ak [522], al [523], am [524], an [525], ao [526], ap [527], aq [204], ar [528], as [529], at [355]) appear in the caption of the Table 10. They are reported here to maintain consistent reference sequential numbering while appending the tables at the end of the section.*

Remote sensing of net PMI changes holds perhaps the greatest promise for future devices, but these have been rarely implemented in tokamaks as “routine” diagnostics [474]. Optical methods of assessing the net change of PFCs in-situ could in principle be used for real-time assessment of net erosion/re-deposition. Also included in this category are remote electronic devices such as the quartz electronic deposition monitor that can assess the net gain or loss from a PFC. The use of quartz crystal microbalances to monitor deposition/erosion in tokamaks was pioneered at TdeV [522] and have recently been installed on ASDEX-Upgrade [523]. These devices are capable of measuring the growth of co-deposited films on a shot by shot basis. Several other new diagnostic techniques, providing data complementary to that of microbalances, are also receiving attention at the moment [474]. High-power pulsed lasers are being targeted at regions of film growth in JET to desorb and study co-deposited material [527]. Similar laser ablation experiments were done at the ASDEX-Upgrade central column for spectroscopic measurement of erosion and of penetration probabilities [116]. So called ‘sticking probes’ are also being tested on JET and other devices [512]. Although technically a long-term sample, this diagnostic has the unique ability to discriminate between the efflux to the wall of different hydrocarbon radicals, providing information on the production, transport and re-deposition of hydrocarbon molecules.

Although in general, much tokamak PMI diagnosis remains qualitative, reliable quantitative results have been obtained when several methods have been focussed on a single issue of interest to the fusion community. One such example is measurements of the rate of net erosion at the carbon divertor plates near the divertor strike-points of DIII-D and JET (Fig. 39). This was a topic of interest due to the selection of carbon for the divertor plates of ITER. Net erosion of attached ( $T_e > 10\text{eV}$ ) plasmas was found to increase with incident heat flux and good agreement was obtained between the various measurement techniques (colorimetry, insertable probes and archaeological measurements of tile thickness changes). Not only does this result show the possible severity of divertor erosion in a long-pulse device, but it also accentuates the need for further collaborative efforts in obtaining high quality PMI diagnostic results in current tokamaks.

*Insert Fig. 39*

*Refs. [110, 480, 491, 521, 530], appear in the caption of Fig. 39. They are reported here to maintain consistent reference sequential numbering while appending the figures at the end of the section.*

The implementation of PMI diagnostics in a next-step device faces several challenges due to very difficult access and the harsh radiation environment [13]. New techniques such as laser range-finding [531] have been developed to measure sub-mm scale erosion. Diagnostics to detect disruption precursors such as locked modes will be important to avoid off-normal events that will reduce the lifetime of PFCs. The cumulative flux of charge-exchange neutrals and debris from the plasma will limit the useful lifetime of optical mirrors and windows and innovative solutions will be needed to preserve key diagnostic capabilities such as spectroscopic impurity monitoring. Techniques to measure the dust inventory, particularly in hidden areas, will need to be developed to assure compliance with regulatory limits (Sects. 2.3.4 and 4.8). A potential technique based on infrared thermography was recently identified in Tore Supra [532]. The infrared spectral emission of dust particles from blackbody behaviour because their size is the same order as the wavelength. Flakes were identified by their fast cool down times.

### 4.3. Review of Tokamak Erosion/Re-deposition Experience

#### 4.3.1. Divertor erosion/deposition

In ITER-type divertor machines the most intense interaction of the plasma will occur at the strike-point of the separatrix with the divertor target plate. The plasma power crossing the separatrix in the main plasma vessel will be guided by the magnetic field onto the divertor plate, thus concentrating the power onto an area of about 10-20 m<sup>2</sup>, resulting in ion fluxes up to 10<sup>24</sup> m<sup>-2</sup>.s<sup>-1</sup>. In this section, the tokamak divertor experience will be discussed in terms of various plasma regimes. In particular, we shall consider the dependence of erosion/re-deposition on electron temperature and density in the divertor plasma, for cases of a high-recycling divertor (see glossary) with T<sub>e</sub> between 10 and 50 eV and for a partially-detached divertor with T<sub>e</sub> < 10 eV [153]. Erosion due to vaporisation and melting during disruptions and ELMs is discussed in Sects. 4.5 and 5.4.

The high-recycling divertor, with moderate electron densities and electron temperatures up to 50 eV, has been investigated in a large number of tokamaks, such as ASDEX, ASDEX-Upgrade, DIII-D, JET, Alcator C-Mod and JT-60U. Due to the high electron temperatures, the ion energies range above the threshold for physical sputtering for most candidate divertor materials. Chemical erosion for carbon-based materials is also high, especially at elevated surface temperatures.

Erosion studies have been performed using marker experiments in ASDEX-Upgrade [493, 533, 534] and DIII-D [109, 494, 535] to evaluate the most useful divertor materials. The measured erosion rates for materials with different atomic number, are shown in Fig. 40, together with Mo erosion in Alcator C-Mod [112]. In spite of the differences in divertor plasma parameters and the comparison of long-term exposure [112, 533, 534], with single discharge erosion [109, 493, 494, 110, 535], the data are in good agreement, showing a strong decrease of the erosion rate with the atomic mass of the target material. The erosion rate decreases by more than an order of magnitude from Be to W, in general agreement with expectations from physical sputtering. However, melting and evaporation increased the Be

erosion rate at high-power loads in JET [536]. The large scatter of results for carbon divertor materials can be attributed to different divertor plasma conditions due to different central plasma densities and auxiliary heating power. The net erosion rate for carbon increases with the incident heat flux for the attached plasma conditions of Fig. 39 [493, 530]. At heat fluxes  $> 5 \text{ MW}\cdot\text{m}^{-2}$ , the erosion rates of  $20 \text{ nm}\cdot\text{s}^{-1}$  would correspond to about 1 cm peak erosion after 1000 ITER discharges lasting 400 s each.

*Insert Fig. 40*

A similar scatter of data exists for W erosion but here no correlation with the heat flux is evident. The contribution of H and D ions to W erosion is negligible in the temperature range  $T_e < 50 \text{ eV}$  since the incident energies are at or below the threshold for physical sputtering. In contrast, low-Z impurity ions with charge-state of 3 and more are accelerated to higher energies in the sheath potential and dominate the sputtering of high-Z materials: in Alcator C-Mod, predominantly B after boronisation [112]; in the ASDEX-Upgrade W-divertor experiment, C from vessel wall erosion [114]. However, impacting C-ions will be implanted into the W surface leading to a gradual decrease of the W sputtering yield until a stationary level is reached where the carbon deposition is balanced by erosion. For a given carbon impurity concentration, this balance is strongly dependent on plasma temperature (Sects. 3.2.2 and 3.2.6.2), and below a threshold temperature of the order of 10 eV, there will be net deposition of carbon protecting the W surface from erosion. Fig. 41 shows the measured erosion yield of W in the ASDEX-Upgrade divertor, as a function of divertor electron temperature compared to calculated sputtering yields for  $\text{D}^+$ , 1%  $\text{C}^{4+}$ , and both ion species including C deposition [114]. It can be seen that  $\text{D}^+$  sputtering is negligible and the erosion rates are well explained by taking the erosion due to 1%  $\text{C}^{4+}$  into account.

This situation is different for low-Z divertor materials. The low sputtering threshold and, in the case of carbon, chemical erosion effects lead to a high yield due to deuterium ion impact (Fig. 11) already at divertor temperatures around 10 eV. This high yield is slightly increased, especially at high divertor density and electron temperatures below 10 eV by taking self-sputtering into account for carbon impurity concentrations in the percent range. Oxygen impurity ions with an effective sputtering yield near unity (Sect. 3.2.4) contribute according to their concentration in the divertor plasma [537]. Data for eroded C fluxes in ASDEX-Upgrade are included in Fig. 41 as a function of divertor temperature and agree well with estimates from sputtering calculations [114].

*Insert Fig. 41*

The chemical erosion for carbon under divertor conditions is a topic of investigation in most current divertor tokamaks. Although it is often stated that the carbon erosion, as determined from spectroscopically measured  $\text{C}^{2+}$  fluxes (see glossary), can be essentially accounted for by physical sputtering [110, 493, 537], the spectroscopic observation of CD bands (see glossary) in all tokamaks indicates the presence of chemical erosion [299, 477, 530, 538]. Also, the increase of carbon plasma impurity content for different surface temperatures, such as observed in JET in going from the Mk-I to Mk-II divertor,

was attributed to the temperature dependence of chemical sputtering [110]. The reason for the large uncertainty [284] in the contribution of chemical erosion of carbon to the observed erosion rates in tokamaks appears to result from difficulties in de-coupling the energy and flux dependence of the chemical erosion yield, as well as uncertainties in the derived hydrogen and hydrocarbon fluxes. Experiments specifically aimed at studying the flux dependence of chemical erosion at high fluxes ( $> 10^{21} \text{ D}\cdot\text{m}^{-2}\cdot\text{s}^{-1}$ ) have also been performed in plasma simulators (Sect. 3.2.3), where the parameters can be independently controlled. In Fig. 42 the dependence of the chemical erosion yield on ion flux obtained from plasma simulator experiments [295, 296, 304] is compared with data from high flux conditions in different tokamaks [297, 299, 477, 480, 539–543], for cases of elevated surface temperatures, near the temperature where chemical erosion is maximum,  $T_{max}$ , and different plasma electron temperatures. In Fig. 42a data are collected for incident ion energy between 20 and 50 eV and in Fig. 42b between 200–300 eV.

*Insert Fig. 42*

*Refs. [285, 295–297, 299, 480, 304, 539, 540, 305, 541–543] appear in the caption of the Fig. 42. They are reported here to maintain consistent reference sequential numbering while appending the figures at the end of the section.*

The large scatter of the data may be due to a number of causes, including: (i) different ion energies due to different plasma parameters, (ii) experimental uncertainties in the determination of the incident hydrogen and CD fluxes, (iii) uncertainties in translating the CD intensities into  $\text{CD}_4$  or  $\text{C}_n\text{D}_m$  fluxes using the ionisation/dissociation sequence [544], (iv) ionisation length, which is determined by the ionisation cross-section, (v) the use of different carbon-based materials with different surface conditioning, and (vi) different surface contaminations from deposited impurities. In spite of all these uncertainties, the trend in the data for ion fluxes  $> 10^{22} \text{ D}\cdot\text{m}^{-2}\cdot\text{s}^{-1}$  indicates a decreasing chemical erosion yield and absolute yields at  $T_{max}$  well below  $10^{-2}$ . Taking into account that physical sputtering of carbon has a threshold around 30 eV, in low temperature divertor applications the total carbon erosion yield will be controlled by chemical erosion. In view of the above uncertainties, further studies are needed to clearly establish the flux dependence of the chemical erosion at high fluxes (Sect. 6.1).

Net erosion rates, as shown in Fig. 39 and Fig. 40, are not only determined by erosion yields as given in Fig. 41 and Fig. 42 for W and C, but also by the extent of re-deposition. Erosion yields multiplied by ion fluxes result in ‘gross erosion rates,’ which may be considerably reduced due to the re-deposition of the eroded material, leading to the observed ‘net erosion rates.’ Sputtered atoms will penetrate into the divertor plasma, become ionised and some will re-deposit on the divertor plate together with the plasma flux (Sect. 5.3). For cases where the ionisation length of sputtered atoms is smaller or comparable to the gyro-radius of the ions in the local magnetic field, re-deposition occurs within the first gyration and the gross erosion rates are drastically reduced [534]. As the energy of sputtered atoms does not vary much for different materials, the atomic velocity, and therefore the ionisation length, decreases with increasing atomic mass. For heavy target materials, such as W, the

prompt re-deposition within the first gyration is partly responsible for the very small net erosion rates observed, reducing the gross erosion by factors of up to 10, especially under high density conditions with short ionisation lengths [114]. Direct evidence of the prompt re-deposition was obtained in marker experiments in ASDEX-Upgrade [533] and DIII-D [109, 494, 535]. The combined action of magnetic field and electrostatic sheath potential leads to a large transport of eroded materials toroidally, in the direction of the magnetic field. In this direction, the decay length of light materials, such as Be and V, was found to be of the order of centimetres, while for W, decay lengths were consistently a factor of 3-4 shorter. One exception from this general tendency is the light impurity Li, which has a high ionisation cross-section at low energy and is likely to be ionised and re-deposited more easily than carbon (ionisation potential=11.26 eV) [545]. Fig. 43 shows a comparison of the marker re-deposition in DIII-D [494] for Be and W, showing clearly the increasing contribution of prompt local re-deposition. Modelling of re-deposition (including prompt re-deposition) gave good agreement with the measured deposition profiles [534, 548].

*Insert Fig. 43*

For the case of carbon-based materials, chemical erosion contributes to the gross erosion rates and leads to new channels of re-deposition. Firstly, the chemically eroded hydrocarbon molecules [288] are assumed to have kinetic energies only of the order of the temperature of the target plate, and subsequently very short ionisation lengths. Secondly, within the complex ionisation/dissociation chain from  $\text{CD}_4$  to  $\text{C}^+$  [544], several neutral radical states occur, especially at low  $T_e$ , and neutral radicals are not confined by the magnetic field. Both effects lead to a relatively efficient local re-deposition. A typical example for the comparison of measured net erosion and deposition in the JET Mk-I divertor with calculated gross erosion and re-deposition is shown in Fig. 44.

*Insert Fig. 44*

The erosion/re-deposition rates at the divertor target have been measured in-situ, between two discharges [110, 546], using the method of colorimetry [547] during the JET Mk-I campaign. The erosion rates are strongly dependent on the power deposition on the targets. For an ELMy H-mode discharge with 10 MW of neutral beam heating at moderate density, a net erosion of  $\approx 5 \text{ nm}\cdot\text{s}^{-1}$  was measured. At high power, much higher erosion rates have been observed (Fig. 39). For a typical ELM-free hot ion H-mode discharge with 22 MW heating for a duration of 1 s, the net erosion rate reaches about  $20 \text{ nm}\cdot\text{s}^{-1}$  near the strike-point (Fig. 44). The detailed simulations using the DIVIMP/NIMBUS (Sect 5.2) codes suggest that the net erosion is predominantly caused by physical sputtering. The codes predict that the gross erosion resulting from chemical sputtering is comparable to that from physical sputtering. However, the chemically produced carbon has lower energy, so re-deposits promptly back to the target, thus showing little contribution to the net erosion. A very similar conclusion was reached in the modelling of carbon erosion using the DIII-D divertor probe [548].

To reproduce the net erosion rates and the carbon profiles along the target, a yield reduction factor of 30-50% had to be used over the low-flux chemical sputtering yields

[288, 549]. This could be due to the break-up efficiency of hydrocarbons, which is not taken into account in the simulation, or due to the flux dependence of chemical yields (Sect. 3.2.2).

The balance between carbon erosion and re-deposition depends strongly on the divertor plasma temperature and geometry. For most of the current divertor experiments, the electron temperature at the inner divertor strike-point is lower than at the outer divertor strike-point. This frequently leads to detachment in the inner divertor, and results in deposition at the inner strike-point and erosion at the outer strike-point. Fig. 45 shows a comparison of the D-retention due to co-deposition with low-Z impurities for different divertor experiments [334]. The long-term erosion/re-deposition pattern integrated over a whole discharge period is very similar for the DIII-D divertor, the JET Mk-I divertor and the ASDEX-Upgrade Div. I divertor and shows that erosion dominates in the outer divertor. A very similar erosion/deposition pattern has been reported from both JT-60U [550], and Alcator C-Mod [112] with thick deposits of low-Z elements at the inner divertor; on Alcator C-Mod macroscopic erosion in the outer divertor was also observed. However, this delicate balance between erosion and re-deposition has been altered by the changes in the divertor geometry of the ASDEX-Upgrade divertor. In the new LYRA divertor with vertical targets, the outer divertor is also fully deposition-dominated as can be seen from the comparison in Fig. 45 [551]. In this geometry, the outer divertor plasma temperature, averaged over a whole discharge period, has decreased to 7 eV (from 17 eV in the Div. I geometry). For a typical carbon impurity concentration of 1% this decrease in electron temperature leads to a transition from erosion to deposition conditions as was discussed in Sect. 3.2 (Fig. 20b). Similarly, in DIII-D the outer divertor changed from a region with net erosion to net deposition in discharges with partially detached divertor plasmas [530]. In these cases, the whole divertor is deposition dominated, indicating that the erosion-dominated areas must lie outside the divertor, most probably at the vessel walls or protection limiters.

*Insert Fig. 45*

The re-deposition of carbon will strongly depend on the sticking of the hydrocarbon radicals to the target surface. The radicals that lead to surface deposition may be synthesised in ion-molecule reactions in the divertor plasma, or alternatively, may also be produced by chemical reaction on the surface, or via thermal release from deposited polymer-like a-C:H films [343, 344, 535]. These species and their fragments after dissociation in the plasma [153, 552] may be deposited as neutrals with just the energy received during break up or as ions accelerated in the sheath potential in front of the surface. The majority will have energies between 1 and 10 eV and have a high probability of surviving the impact with surface atoms without break-up.

A plausible scheme for the observed carbon deposition in current divertor experiments (JET [235], ASDEX-Upgrade [523]) is erosion of carbon from the vessel walls followed by deposition as polymer-like films on the target plate. This polymeric structure is the stable form of C:H layers if the ion energy is low ( $< 30$  eV) or a high flux of atomic hydrogen leads to a continuous hydrogenation of the  $sp^2$  carbon groups in the film [460, 553]. Both conditions hold for many plasma-exposed surfaces inside a fusion reactor. At elevated tem-



peratures, during plasma exposure,  $C_2H_x$  molecules/radicals are released. The deposition of such molecules/radicals on cooler surfaces ( $T < 500$  K) can lead to the formation of thick hydrogenated layers.

A striking feature, which is seen in many tokamaks, is the intense co-deposition of carbon and deuterium in regions, which are shaded from ion flux but are near carbon surfaces receiving high ion flux (Sect. 4.7). Examples of this are surfaces facing the inner pumping port in the JET Mk-IIA divertor and regions shaded by adjacent tiles (JET and ASDEX-Upgrade), and on the sides of tiles (TFTR and DIII-D). Since ions cannot reach these shaded surfaces, this carbon deposition can only be due to neutral carbon atoms or molecules. Sputtered atoms are unlikely to return to the surface as neutrals, instead, they will be ionised and return to surfaces intersecting field lines. However, hydrocarbon molecules leaving the surface can dissociate yielding energetic neutral fragments, including hydrocarbon radicals and atoms. Cross-sections for production of  $CH_3$  and  $CH_2$ , by electron bombardment of methane, peak at electron energies between 20-30 eV [554]. In this energy range, dissociation into neutrals, rather than dissociative ionisation, is mainly responsible for the production of molecular radicals [555]. Furthermore, erosion of graphite from hydrogen impact occurs mainly through production of methane and heavier hydrocarbons for hydrogen energies below 100 eV [288]. Therefore, it is likely that carbon surfaces exposed to high fluxes of hydrogenic ions, such as divertor strike-points, will be a strong source of hydrocarbon molecules into the plasma. A large fraction of this carbon will promptly return to nearby surfaces as energetic neutral carbon or hydrocarbon radicals. Chemical erosion followed by molecular dissociation will, therefore, result in intense recycling of neutral carbon and hydrogen back and forth between the plasma and the surface. This flux of neutral carbon can deposit on surfaces shaded from the plasma. In contrast, the same mechanism would not occur for metal atoms since metals are eroded by physical sputtering as atoms, not as molecules. The eroded metal atoms will be ionised and re-deposit on surfaces intersecting field lines. The ability of carbon, but not metal atoms, to re-deposit in shaded regions is consistent with the observation in JET that on the Mk-I beryllium divertor the heavy deposits were predominantly carbon and not beryllium, and that the regions exposed to ion flux, i.e., of net erosion, consisted of mainly beryllium with little carbon. Beryllium and carbon would both be eroded from the plasma-contacting regions, but only the carbon would be deposited as neutrals into the shaded regions. This process might be used to advantage, to localise deposition of carbon in regions where it can be removed or heated to thermally release tritium (Sect. 2.3.3).

#### 4.3.2. Limiter erosion/deposition

Investigations in divertor tokamaks such as ASDEX-Upgrade [556] and Alcator C-Mod [557] have shown that, even at several decay lengths outside the separatrix, moderate ion fluxes can reach limiter structures and lead to characteristic erosion/deposition patterns (see for example [213]). Originally, JET was built as a limiter machine with discrete outboard rail limiters and a large area inner bumper limiter. Net erosion/deposition at the discrete limiters that JET used during the 1986 campaign was determined by measuring the tiles with a Coordinate Measuring Machine before and after the campaign, (Fig. 46) [558, 559]. Additional

implanted  $^{13}\text{C}$  markers served as quantitative erosion/deposition indicators. Maximum net erosion of  $200\ \mu\text{m}$  was observed at either side of the tangency point, with deposition of up to  $120\ \mu\text{m}$  found on the flanks of the tile, deeper into the SOL. The erosion corresponds to an average of  $60\ \text{nm}$  per pulse over the 3200 discharges in the campaign. In the same campaign, a special erosion probe was inserted into the SOL to within  $10\ \text{mm}$  of the LCFS for two 20 s discharges with flat-tops of  $5\ \text{MA}$  for  $4\ \text{s}$ . The erosion rate in the SOL varied from  $60$  to  $2000\ \text{nm}$  per  $20\ \text{s}$  pulse, while the deposition rate was factors of 25 greater [559, 560].

*Insert Fig. 46*

Erosion/deposition processes at large area bumper limiters were investigated in detail in TFTR [488]. Measurements of the TFTR bumper limiter, by in-situ beta back-scattering [483], showed areas of net deposition of material (metals and D) at the lower left and upper right and at the mid-plane of each sector of the limiter. Relatively clean areas appear to correspond to regions of high plasma flux and net erosion. The deposited material was mainly carbon with 20 at.% D, 6 at.% oxygen and 1 at.% metal atoms with a depth of several  $\mu\text{m}$ . The main mechanism for D retention was co-deposition rather than implantation. The TFTR bumper limiter was lined with graphite tiles having  $\sim 3\ \text{mm}$  gaps. Removed tiles showed thick (up to several  $\mu\text{m}$ ) carbon deposits  $\sim 2\ \text{cm}$  down the side faces of the gaps. Theoretical and experimental simulations indicate that sputtered carbon can be transported deep into the gap by multiple reflections off the faces of the gap [561]. Scans along the side edges of removed limiter tiles indicate that the edges retain high levels of deuterium [562]. Deposition in the gaps was more pronounced on the tiles which were erosion dominated on their plasma-facing surfaces, indicating local re-deposition. More information on deuterium and tritium retention in TFTR and JET is in Sect. 4.7.

Erosion/re-deposition modelling in TFTR [563] yielded results that are consistent with the above experimental measurements. Flaking of co-deposits after termination of operations was observed [564, 565]. Analysis of tiles that experienced DT plasmas showed relatively high concentrations of tritium at the top and bottom of the bumper limiter [566], as predicted by earlier BBQ modelling [201].

In TEXTOR, a well-diagnosed mushroom-type test limiter was used to investigate erosion processes such as RES and chemical erosion (Sect. 3.2), the behaviour of different limiter materials, and erosion/re-deposition transport issues. Under typical limiter conditions, the electron temperatures are high enough ( $T_e \approx 30\text{-}80\ \text{eV}$ ) that even incident hydrogenic ions have energies above the threshold for physical sputtering for high-Z materials. However, under the plasma boundary conditions of TEXTOR with about 2%  $\text{C}^{4+}$  and 1%  $\text{O}^{4+}$ , the observed emission of W or Mo from limiters made of these materials, respectively, is predominantly due to impurity sputtering [567, 568]. The transition from carbon erosion at the limiter tip to carbon deposition at the limiter rim is very sharp, indicating the change from erosion- to deposition-dominated areas as the electron temperature decreases below a critical limit (Fig. 20b)

## 4.3.3. Main chamber wall erosion

When erosion in the divertor is suppressed, for example during operation with detached divertor plasmas, the main-chamber wall can become the dominant source of impurities to the plasma. The first-wall in general is not a homogeneous surface. Typically, the inner wall is covered by well-aligned carbon tiles (ASDEX-Upgrade, DIII-D, JET, JT-60U, TFTR, TEXTOR, Tore Supra) or molybdenum tiles (Alcator C), while the outer wall houses components such as ion cyclotron resonance heating (ICRH) and lower hybrid (LH) antennas, passive stabilisation coils, protection limiters and has ports and openings for diagnostics and NBI. Often, large areas of the unprotected metal walls have direct line-of-sight to the core plasma. This complicated structure with a variety of surface materials, is often protected by periodic coating with low- $Z$  elements, such as boron (ASDEX-Upgrade, TEXTOR, Alcator C, Tore Supra, JT-60U, MAST, NSTX), silicon (ASDEX-Upgrade, TEXTOR), beryllium (JET), or lithium (TFTR) (Sect. 1.3.2). The fluxes to the first-wall components are poorly diagnosed (Sect. 6.4). Protection limiters, positioned several decay lengths behind the separatrix, are subject to ion fluxes, but at much lower intensity than divertors. The large area of the vessel wall behind protection limiters receives charge-exchange neutral fluxes. Charge-exchange diagnostics typically only measure neutrals with energies above 1 keV. However, the charge-exchange neutral fluxes responsible for impurity production are mainly below 300 eV [332] (Sect. 3.2), and are difficult to measure. Charge-exchange neutral fluxes were measured in ASDEX [569] using the change in resistance of thin carbon films calibrated in ion-beam experiments [570, 571]. It could be shown that the fluxes were of the order of  $10^{20}\text{m}^{-2}\cdot\text{s}^{-1}$  and the estimated sputtering rate correlated with the impurity influx determined from central impurity concentrations [569] for different plasma parameters. For some cases, the energy distributions between 20 eV and 2 keV were measured using a time-of-flight method [156, 572–575], and were used for the estimation of sputtering rates. As the direct measurement can only be done at a few special locations around the plasma vessel, the available data have to be extrapolated to the rest of the vessel wall by code simulations. This has been done using the B2/EIRENE code (Sect. 5.2) at ASDEX-Upgrade [156] and Fig. 47 shows the distribution of the sputtered atom fluxes for a W and C first-wall due to charge-exchange neutral sputtering. The neutral fluxes range from  $10^{18}$ – $10^{20}\text{m}^{-2}\cdot\text{s}^{-1}$  and are more than three orders of magnitude smaller than the maximum ion fluxes to the divertor plates. The calculations consider only recycling from the divertor as the main neutral gas source (and do not consider main vessel sources due to cross-field diffusion [576] of plasma to protection limiters, ICRH antennae or gas puffs), which lead to a toroidally non-uniform charge-exchange neutral distribution [577]. Due to the high fraction of neutrals at low energies, high- $Z$  materials with high threshold energies for sputtering show a strongly reduced erosion rate compared to low- $Z$  materials, especially for high density plasmas with low edge temperatures. The prediction that carbon influxes result predominantly from the lower part of the inner heat shield was corroborated directly by quantitative spectroscopic measurements of the CD band intensity [334] (Fig. 47).

*Insert Fig. 47*

Measurements were also made of the energy and flux of charge-exchange neutrals to the wall at the outer midplane in TFTR using carbon resistance probes, which sense neutrals with energies above 30 eV [483]. The mean charge-exchange neutral energies were compared for ohmically heated and neutral beam heated portions of discharges. Low density helium fuelled plasmas were used in TFTR to remove deuterium from the limiter and wall to reduce fuel recycling at the plasma edge. The resistance probe study showed that this conditioning dramatically reduced the flux of charge-exchange neutrals to the wall but had little effect on their energy, and that neutral beam heating increased both the energy and flux of the charge-exchange neutrals (Table 11).

*Insert table 11*

In general, direct spectroscopic determination of the sputtered fluxes from the vessel walls is difficult due to the small erosion rate per unit area, while the total impurity influx is important due to the large area of the vessel wall. Therefore, direct determination of the wall erosion has to be done by long-term surface probes integrating over several discharges or whole campaigns. Erosion probes used in ASDEX collected the eroded Ni atoms on Si collectors and could be analysed sensitively using electron induced X-ray spectroscopy [578]. In JET, long-term probes with evaporated films or implanted depth markers were installed and analysed before and after the exposure for full experimental campaigns [579, 580]. Erosion/deposition at the JET vessel walls was investigated in 1985 by means of 12 long-term samples distributed poloidally around the wall and into which  $^{13}\text{C}$  had been implanted at depths of 30 and 450 nm [579]. The overall erosion was much greater than the implantation depths, and was not consistent with sputtering by expected the charge-exchange neutral flux. Either the flux was larger, or there was an additional ion flux to the walls [579].

Erosion/deposition at the vessel walls was investigated during the Mk-I divertor phase of JET [580, 581] (April 1994 to June 1995.) During this period, the vessel walls (made of Inconel 600 - see glossary) were protected from direct contact with ions by poloidal rings of carbon (graphite and CFC tiles), but were exposed to charge-exchange neutral fluxes. The inner wall was coated periodically with Be evaporated from 4 heads close to the outer wall at the mid-plane; parts of the outer wall were also coated with thicker Be layers, while other areas were shielded from the evaporation by the poloidal limiters. Long-term samples of different materials were attached to the walls. Detailed measurements of spatial- and energy-distributions for charge-exchange neutrals in JET are not available, however, scaling charge-exchange neutral measurements in ASDEX-Upgrade to JET led to reasonable agreement with the erosion rates of the different materials by the likely charge-exchange fluxes (Fig. 18) [156]. The net erosion for the Ni sample at the JET inner wall was  $\approx 0.8 \times 10^{19}$  at. $\cdot\text{m}^{-2}$ . Assuming toroidal symmetry, this indicates that about 70 g Ni+Cr+Fe was eroded from the inner wall, in addition to the sputtering of the evaporated Be; about 55 g Be was sputtered from the outer wall. In JET and ASDEX-Upgrade, deposition was found to be minimal, and in most cases this deposition was due to the periodic wall conditioning by coating with beryllium.

Although eroded atoms from protruding components with direct sight to the vessel wall have a chance to be deposited at the wall without being ionised in the plasma edge [582], the majority are ionised in the SOL, and are transported along field lines to limiters or divertor plates [583]. In contrast, the outer stainless steel vessel wall of TFTR experienced net co-deposition. Approximately, half of the deuterium and tritium inventory was found to be deposited on the outer wall (Sect. 4.7.1.1.) [566]

#### 4.3.4. Impurity flow pattern in divertor tokamaks

As a result of the detailed investigations of erosion and re-deposition in tokamaks, a schematic flow diagram of impurities can be constructed. This has been done in ASDEX [584] for the case of Cu divertor plates and a carbon vessel wall, for ASDEX-Upgrade [585] with W as divertor plate material, and for JET [581] using the Mk-I carbon divertor, a carbon inner heat shield and beryllium coated outer walls. As an example, the impurity flow pattern for ASDEX-Upgrade is shown in Fig. 48 for the W divertor. The first-wall is the erosion-dominated zone, with chemical sputtering of carbon being the dominant erosion process. Sputtering is mostly due to charge-exchange neutral fluxes, but there is an indication that ion fluxes to the inner heat shield also contribute to erosion. About  $10^{20}$  C atoms/s are eroded, depending on the main plasma density, and deposited onto a wetted divertor area of less than  $1 \text{ m}^2$  (Fig. 48a.) Deposition rates are in the several  $\text{nm}\cdot\text{s}^{-1}$  range. In the W divertor, the electron temperature at the inner divertor was typically lower than 10 eV, leading to net deposition, while at the outer divertor, at slightly higher temperatures, erosion dominated [586]. Erosion is due to highly charged impurity ions, such as  $\text{C}^{4+}$ . The energy of the deuterium ions is too low to sputter W from the divertor plates [114].

W sputtered from the outer divertor plate in ASDEX-Upgrade has a high probability ( $\approx 85\%$ ) to be promptly re-deposited (Fig. 48b, right insert). Another fraction ( $\approx 15\%$ ) will be re-deposited without ever entering the confined central plasma. Only a fraction of about 0.2% escapes the divertor and SOL and enters the confined plasma (Fig. 48b, left insert). In relation to the originally sputtered amount at the outer divertor plate a fraction of  $1.15 \cdot 10^{-3}$  is deposited on the inner divertor plate, a fraction of  $6 \cdot 10^{-4}$  returns to the outer divertor, and a fraction of  $2.5 \cdot 10^{-4}$  is deposited at limiter-like structures in the SOL. No deposition at the vessel wall could be measured. In ASDEX-Upgrade, W atom concentrations in the central plasma reached levels above  $2 \cdot 10^5$  W/D only in a few exceptional cases, where the disappearance of sawteeth led to impurity accumulation [114]. In the new ASDEX-Upgrade LYRA divertor even the outer divertor is deposition dominated [551].

In JET, coverage of the cold inner Be divertor with carbon was found [487] and partially-detached divertor conditions led to the elimination of gross erosion in DIII-D [530]. The low temperature, high density divertor conditions can lead to deposition of a polymer-like hydrogenated carbon film, which is unstable at temperatures above 500 K and decomposes to heavy hydrocarbons and radicals [512]. During plasma exposure at elevated temperatures, the deposited layer will, through chemical sputtering, and/or thermal decomposition, lead to the release of hydrocarbons/radicals, which could be transported and deposited onto cooler areas where the deposited layer is stable - such as the inner louvres of the JET divertor

(Sects. 4.3.1 and 5.3.1) [235], or the ASDEX-Upgrade divertor bottom [523]. CH<sub>3</sub> radicals have a very low sticking coefficient [587] and may be uniformly deposited on cool areas of the vessel wall and deep into the pump duct.

*Insert Fig. 48*

#### 4.4. Experimental Evidence for Arcing in Tokamaks

The underlying physical processes of arcing are presented in Sect. 3.3. The occurrence of arcs and arc traces on PFCs have been reported by tokamaks throughout the past 25 years [301, 349, 508, 588]. However, their relative importance is uncertain, primarily due to the difficulties of measuring the effects of such highly localized and transient events. Arcing, like sputtering, has two possible consequences for tokamak operations: introduction of impurities into the plasma, and damage to PFCs (e.g., net erosion).

One obvious feature is the discrete temporal nature of arcs compared to the continuous release of wall particles from sputtering. To make a comparison, one must know the average number of released particles per arc,  $N_{arc}$ , ( $10^{17}$ - $10^{18}$ ) and the steady-state arc frequency per unit area of PFC ( $f_{arc}$ , in units of  $s^{-1}m^{-2}$ ). The relative flux from arcing,  $\Gamma_{arc}$ , to sputtering,  $\Gamma_{sputter}$ , of released materials is then simply given by,

$$\frac{\Gamma_{arc}}{\Gamma_{sputt}} = \frac{N_{arc}f_{arc}}{Y_{sputt}\Gamma_{inc}} \quad (27)$$

$Y_{sputter}$  is the sputtering (physical + chemical) yield for the incident plasma flux,  $\Gamma_{incident}$ . This formulation is useful since the quantities ( $N_{arc}$ ,  $f_{arc}$ ) can be deduced from post-exposure analysis of the arc tracks that have occurred on a PFC over a given operational period. Note that there is an implicit assumption that both the plasma and surface criteria for arcing are met (Sect. 3.3). Although the underlying plasma-material physics is the same, arcing at limiter and divertor surfaces will be addressed separately in the following sections. In summary, the effect of arcing on next-step devices should be small at limiter surfaces. Arcing may be important in the divertor, but insufficient data from current tokamaks exist to reliably extrapolate to an ITER-class device.

##### 4.4.1. Arcing at limiter surfaces

Arcing from limiter surfaces was initially viewed as a leading candidate to explain the impurity content of the plasma [589]. This arose primarily from the visual observation of material loss from arc traces. Although there appeared to be some link of arcing with the type of limiter material and its conditioning, the principal correlation for the presence of arcs was the plasma parameters at the limiter. Time-resolved arc measurements (using coincident spectroscopy and current measurements) in several tokamaks (DITE, ISX, PLT and T10) in the late 1970's showed that arcing at limiters occurs predominately during the initial phases of the discharge [349]. On both DITE [509] and JFT-2 [590], this was clearly correlated with disruptive-like MHD activity as rational q-surfaces passed the limiter during the current ramp-up. Significant arcing was also found during plasma disruptions.

The enhanced loss of particle and energy flux to the limiters during these events meet the criterion for arc initiation (Sect. 3.3), while quiescent periods do not. It was also found that, although the impurity content of the plasma was increased during arcs, this had little effect on the impurity concentrations during the quiescent, steady-state portion of the discharge.

The possibility of arcs at the limiter is more likely during non-quiescent phases such as VDEs when the main plasma moves suddenly into the main wall or limiter (Sect. 2.3.2). The large energy densities associated with the direct contact of a burning plasma with the limiter surface will certainly meet the criteria for arcing. However, it is difficult in this case to separate arcing from other ablative/melt losses as the principal culprit in damaging the limiter materials.

#### 4.4.2. Arcing at divertor surfaces

Despite the observation of arc traces in the divertor of many current tokamaks (e.g., ASDEX-Upgrade [355], DIII-D [109]), little effort has been devoted to their impact on tokamak operation. The divertor geometry intentionally concentrates heat and particle flux on small regions of the vessel surface. Divertor electron densities and particle flux are typically 5-10 times larger than those found at a limiter, while  $T_e$  is usually  $>10$  eV for non-detached divertor plasma regimes. Hence, the plasma conditions necessary for arc formation can be constantly present in the divertor, as opposed to being transiently present at limiter surfaces.

A detailed analysis on the effects of arcing in the divertor has taken place on ASDEX-Upgrade [355, 508]. Post-exposure surface analysis of outer divertor graphite tiles showed a localised arc density  $f_{arc} \approx 5 \times 10^3 \text{ arcs} \cdot \text{m}^{-2} \cdot \text{s}^{-1}$  during the  $\approx 100$  seconds of discharges with neutral beam auxiliary heating ( $\approx 6$  MW). The typical dimensions of the arcs (depth  $\approx 10 \mu\text{m}$ , width  $\approx 50 \mu\text{m}$  and trace length  $\approx 4$  mm) indicated that  $N_{arc} \approx 2 \times 10^{17}$  carbon atoms per arc were eroded (Fig. 49). Therefore, the estimated carbon efflux  $\Gamma_{arc} \approx 1.1 \pm 0.4 \times 10^{21} \text{ m}^{-2} \cdot \text{s}^{-1}$  (eq. (27)) is comparable to the carbon efflux expected from sputtering,  $\Gamma_{sputter} \approx 1.4 \pm 0.7 \times 10^{21} \text{ m}^{-2} \cdot \text{s}^{-1}$ ,  $\Gamma_{incident} \approx 5 \times 10^{22}$ ,  $Y_{sputter} \approx 2-3\%$ . Time-resolved measurements of the arcing were unavailable. Therefore, it is highly uncertain whether this short exposure reflects the expected steady-state arcing frequency or the initial conditioning of the tiles. Significant arc traces have also been observed on DIII-D inner divertor tiles, where the arc traces have removed portions of the deposited carbon layer formed during plasma operations. Arcing was also prevalent at the re-deposition-dominated inner divertor tiles of ASDEX-Upgrade [355]. Conversely, recent exposures of polished graphite samples to ELMy H-mode outer divertor plasmas in DIII-D [109] and ASDEX-Upgrade [493] have shown no signs of arc traces. These results point to the complex role played by the surface conditions in arcing.

Fig. 50 illustrates an example of arcing on a  $0.1 \mu\text{m}$  thick film of tungsten on a carbon DiMES probe (see glossary) exposed to ELMy H-mode divertor plasmas on DIII-D [109]. In the arc tracks the entire thickness of the tungsten film was removed. Several arcs were initiated at a small defect and then moved in a retrograde direction. At the boundary of the tungsten film, the arcs continued onto the graphite substrate for a short distance. An adjacent beryllium film on this sample had no arc tracks. In contrast, no arc tracks were seen on similar probes exposed at the outer strike-point of detached plasmas [591].

Detached plasmas are characterised by  $T_e < 2$  eV; therefore, the local electric field falls below the critical potential necessary for arcing. Despite the diagnosis difficulties, these results raise valid concerns that arcing can play an important role in erosion (at least transiently) in portions of the divertor.

*Insert Fig. 49*

*Insert Fig. 50*

#### 4.5. Disruption Erosion in Simulation Devices and Tokamaks

##### 4.5.1. Disruption simulation experiments

Disruption conditions in next-step devices cannot be achieved in existing tokamaks due to the large difference in stored energy (Sect. 2.3.2). Laboratory experiments (e.g., laser and electron beams, open plasma traps and plasma guns) are therefore used to study and simulate disruption erosion effects [592]. This section briefly reviews the measurements of erosion in disruption simulators and some effects partially observed during off-normal events in today's tokamak experiments. These experiments are used to validate the theories and the models discussed in Sect. 3.4, which predict disruption effects in next-step devices (Sect. 5.4).

Table 12 lists the main operation parameters of several disruption simulators, which have been primarily used during the last decade.

*Insert table 12*

##### 4.5.1.1. *Experiments with lasers and high-energy electron beams*

Laser [593–598] and high-energy electron beam facilities [599–606] have been widely used to test divertor materials, primarily graphite and C-based materials. These experiments were mainly carried out in facilities without an applied magnetic field and have typically shown very high erosion (hundreds of  $\mu\text{m}$ ). A magnetic field can confine the vapour-plasma and shield the material surface (Sect. 3.4). In laser beams the beam size is generally very small ( $\leq 2\text{--}4$  mm), and penetrates the expanding cloud of vaporised material with little attenuation. Similarly, in electron beams, because of the high kinetic energy (100–150 keV), electrons penetrate the vapour and the target material more deeply than laser or plasma gun devices. As a result the vapour cloud is heated to lower temperatures than in plasma gun experiments, and the fraction of incident energy dissipated via radiation in the vapour is much lower [607].

Ejection of macroscopic carbon particles, from carbon-based samples, has been observed both in electron beam [595, 604, 608, 609] and laser experiments [610]. The GOL-3 facility of Novosibirsk in Russia [605, 606] combines a combined hot electron beam (low MeV range) and low-temperature plasmas ( $\approx 3\text{--}5$  eV) and showed an explosive-type erosion of graphite materials [608, 611]. About  $500 \mu\text{m}\cdot\text{shot}^{-1}$  of graphite were eroded at an energy density of  $30 \text{ MJ}\cdot\text{m}^{-2}$  [592]. This high graphite erosion is believed to be due to bulk damage by



volumetric energy deposition and the eroded graphite is emitted in the forms of grains of size ranging between 1 and 40  $\mu\text{m}$ . The conditions in this facility, however, may not be fully relevant to disruption conditions in tokamaks.

#### 4.5.1.2. *Experiments with plasma gun devices*

Plasma gun devices [612–619] typically produce low temperature plasmas ( $T < 1 \text{ keV}$ ) and a high energy flux (up to  $10\text{--}20 \text{ MJ}\cdot\text{m}^{-2}$  deposited in a pulsed duration of  $< 1 \text{ ms}$ ). They are believed to be more suitable than electron or laser beams for simulating reactor relevant disruption conditions [620]. These facilities are now primarily used to study the underlying physics of the PMIs during disruptions and to quantify the resulting material target erosion. For example, the MK-200UG (Table 12) can produce hydrogen and deuterium plasma streams with a total energy of 50 kJ and ion kinetic energy above 1 keV, in a magnetic field of 2–3 T. Target materials can be tested at perpendicular as well as in an oblique plasma incidence. The main limitation of this facility is its very short pulse duration, i.e.,  $t \approx 40\text{--}50 \mu\text{s}$ , which makes it possible to only simulate the early stages of a disruption in a next-step tokamak. Quasi-stationary plasma guns such as VIKA, QSPA, QSPA-Kh 50 and PLADIS (Table 12) generate plasma streams with a long-pulse duration ( $> 100 \mu\text{s}$ ). However, because of the relatively low kinetic energy of the ions ( $E_i \approx 100\text{--}300 \text{ eV}$ ), and large plasma densities ( $> 10^{22} \text{ m}^{-3}$ ), a shock wave could arise during plasma deposition. This would lead to a deceleration of the plasma stream and to a ‘self-shielding’ effect that mitigates the energy flux reaching the material surface and results in an underestimation of erosion compared to actual tokamak conditions [618].

Several experiments have been performed in various plasma gun facilities primarily to study physical properties and shielding efficiency of plasma vapour shields and the resulting material erosion. In these experiments the plasma temperature and density distributions in the vapour shield are measured together with the lateral leakage of radiation [592, 613, 621–623]. Material damage is generally measured by means of surface profilometry, and mass-loss. Vapour shielding is seen to reduce erosion, at least to some extent, in all disruption simulation facilities. The dependence of the density and the temperature of plasma vapour on the incoming plasma flow and the target material are found to be generally in good agreement with theory (Sect. 3.4).

The incident plasma flows along the magnetic field lines. For perpendicular incidence the target plasma expands upstream along the magnetic field lines and transverse motion is inhibited by the strong magnetic field. At oblique incidence, the vapour shield of carbon material was found to drift along the target surface in the direction of the magnetic field lines [613]. This mechanism was found to deplete the shielding properties and increase the erosion of a graphite target by about  $\approx 50\%$  in agreement with modelling predictions [362].

Recent experiments in MK-200UG [592] have shown collateral damage of nearby-surfaces resulting from radiation emitted from the outermost regions in the confined vapour cloud. Graphite erosion of  $0.35 \mu\text{m}\cdot\text{shot}^{-1}$  was caused by a  $\approx 1 \text{ MJ}\cdot\text{m}^{-2}$  radiation flux from a plasma vapour forming in front of a tungsten target. This erosion is similar to that observed for direct plasma impact ( $0.4 \mu\text{m}\cdot\text{shot}^{-1}$ ) at much higher heat flux ( $\approx 15 \text{ MJ}\cdot\text{m}^{-2}$ ). Modelling

[363] confirms that the shielding efficiency under radiation heat loads is lower than under direct plasma impact. The secondary radiation is therefore an important consideration for the choice of divertor materials and geometry in future tokamak devices (Sects. 2.4 and 2.5).

For C-based materials, high erosion with mass losses that exceed those from surface vaporisation have been also observed in plasma-gun devices. Experiments in the MKT facility have shown emission of macroscopic particles [624]. Recently, experiments performed in MK-200 UG and QSPA [625, 592] have also revealed macroscopic erosion mechanisms.

Several studies have been also carried out in recent years to investigate macroscopic erosion of metals under disruption conditions. Several mechanisms of metal erosion were described in Sect. 3.4.2.

Preliminary analysis of the microstructure of the exposed metal surfaces has clearly shown, the formation of high volume bubble densities [626] with traces of melted metal droplets of light-Z materials (e.g., aluminium) up to a few meters away from the target area. Bubble formation was also found in electron-beam experiments [608]. Careful analysis of the irradiated samples has also suggested the possibility of hydrodynamic instability to be a melt-layer erosion mechanism, in addition to volume bubble vaporisation. Near central areas, where the velocity of the incident plasma stream along the sample surface is close to zero, the bubbles are clearly seen. Near the sample peripheral areas, however, one can see liquid droplets with long tracks formed because of the high velocity of the plasma stream [368].

Melt-layer erosion of much heavier materials, such as tungsten, was shown to be very low in plasma gun experiments [618] but is more likely to be greater for longer ( $> 1\text{ms}$ ) heat pulse duration. In experiments conducted in the VIKA facility [627], it was found that for an incident power of  $\approx 100\text{GW}\cdot\text{m}^{-2}$ , an appreciable contribution of melt-layer loss to the total mass loss of the tested metals (Al, Cu, SS) appears only when the pulse duration exceeds 0.18 ms.

Recently, specimens made of several grades of tungsten (e.g., recrystallized W, W-Re, W-Mo cast alloys, single crystal W, etc.) were subjected to a number of disruption simulation pulses in MK-200UG (energy density up to  $30\text{MJ}\cdot\text{m}^{-2}$  and pulse duration of less than  $50\mu\text{s}$ ), and then to thermal cycling under steady-state heat fluxes up to  $45\text{MW}\cdot\text{m}^{-2}$  [628]. Thermal erosion, crack formation, and shallow melting were observed. Crack formation was observed for all studied W grades except single crystal W of proper orientation.

#### 4.5.2. Off-normal events in tokamaks

Erosion data during off-normal events in current tokamaks are scarce and difficult to interpret. We describe below a limited number of cases of interest.

##### 4.5.2.1. *JET Be-target melting experiment*

A dedicated experiment was performed to assess the behaviour of a beryllium target in JET at power fluxes high enough to cause surface melting [244, 629, 630]. These experiments were designed to test the hypothesis that in ITER a beryllium divertor target would self-protect against excessive, off normal, heat fluxes (i.e.,  $> 20\text{MW}\cdot\text{m}^{-2}$ ) as might occur

when radiative divertor operation fails. In this scenario, a highly radiating region produced by evaporating beryllium would reduce the heat flux to the target, preventing significant melting. In a series of JET discharges, the heat fluence to the divertor target was gradually increased, by extending the neutral beam heating duration (to  $\approx 25 \text{ MW}\cdot\text{m}^{-2}$  for  $\approx 6 \text{ s}$ ). Beryllium influxes were seen to rise significantly with target temperature above 1470 K and significant melting of the target was observed with a CCD viewing camera (Fig. 51). No transition between evaporation of beryllium from the solid surface and influxes from the melt-layer could be distinguished. Nevertheless, the radiated power did not exceed 50% of the input power and ELMy H-mode operation was retained. In a further series of discharges, without additional gas puffing, but a similar heat flux and heating duration, the radiated power fraction was observed to increase to  $\approx 70\%$  over several seconds. This increase in radiated power fraction is evidence that the evaporated Be flux helped reradiate the incident plasma energy away from the damaged area and may be a sign of self-protection in these experiments. Nevertheless, in this phase of the experiment, melting was observed on both the inner and outer strike-points. The total exposure time of the target to the high heat flux was  $\approx 20 \text{ s}$  and no disruptions occurred during the sequence of pulses which melted the target.

After melting, reference plasma scenarios were repeated with strike-points on the annuli of the melted beryllium. The discharges were only marginally worse than the pre-melt experience. Finally, two long-pulse, high-power discharges with sweeping were performed on a different annulus of the target. Beryllium melting was observed, but the radiated power fraction remained moderate ( $<40\%$ ), indicating that self-protection had not occurred. Post-mortem examination of the target revealed significant droplet formation in the exposed areas, with droplets forming bridges across the toroidal gap between the tiles. In the most severely melted regions, an annulus approximately 40 mm wide at the outer strike-point tiles were eroded to a depth of  $\approx 3 \text{ mm}$ . It can be concluded, therefore, that at heat fluxes  $> 25 \text{ MW}\cdot\text{m}^{-2}$ , severe melting of beryllium occurs. While a certain degree of self-protection may have occurred, this was insufficient to protect the tile from melt damage. Melt-layer loss may be more severe in a 'vertical' target such as envisioned in ITER compared to the horizontal JET divertor (see also oblique magnetic field effects observed in simulators (Sect. 4.5.1.2)). The damage did not prohibit subsequent plasma operation at JET, but would seriously limit the lifetime of Be PFCs in long-pulse ITER-like devices.

*Insert Fig. 51*

*Ref. [631] appear in the caption of the Fig. 51. It is reported here to maintain consistent reference sequential numbering while appending the tables at the end of the section.*

#### 4.5.2.2. DIII-D/DIMES observations on disruptions

Fast scanning infrared thermography of disruption experiments on DIII-D shows that divertor heat loads for major disruptions and VDE can be significant [174, 632]. For instance, in a triggered VDE disruption,  $\approx 80\%$  of the stored kinetic energy of the core plasma (1-2 MJ) can be lost in about 2 ms due to heat convection/conduction to the divertor floor in a

5-10 cm footprint ( $0.5\text{-}1\text{ m}^2$  total area,  $2\pi R \approx 10\text{ m}$  for DIII-D). This results in heat loading up to  $1\text{ GW}\cdot\text{m}^{-2}$  at the divertor floor, with average values  $\approx 0.5\text{ GW}\cdot\text{m}^{-2}$ . Simultaneous measurements of net carbon erosion/re-deposition were made using the DiMES probe [492]. The footprint of the VDE was displaced from the DiMES radial location by about 5-10 cm. It was found that  $\approx 10\text{ nm}$  of carbon deposition arose from each VDE, indicating significant interactions during the 1-2 ms disruption [633].

An in-situ experiment was carried out on the DiMES probe to directly measure the effect of very high heat and particle fluxes on a leading edge of a graphite sample [530, 634]. A DiMES sample with a 0.7 mm vertical lip above the aligned surface ( $\approx 30\text{ mm}$  radial extent) was exposed to the outer strike-point of an ELMing H-mode plasma ( $P_{inj} \approx 7\text{ MW}$ ,  $T_e \approx 30\text{ eV}$ ,  $n_e \approx 5 \times 10^{19}\text{ m}^{-3}$ ,  $q \approx 2\text{ MW}\cdot\text{m}^{-2}$ , incident field line angle  $\approx 2^\circ$ ) for 0.5 s. A parallel heat flux  $\approx 50\text{ MW}\cdot\text{m}^{-2}$  was incident on an area of  $14\text{ mm}^2$ , which reached a temperature  $> 2800\text{ K}$ . The graphite part of the sample was seriously eroded after one shot exposure. Localised erosion (pits) depth was as much as  $134\text{ }\mu\text{m}$ . Re-deposition layers of different structure were formed on the plasma-facing surfaces, depending on the impacting heat fluxes and proximity to the erosion region. This experiment was recently repeated to further investigate erosion and dust production from a similar geometry and a parallel heat flux of  $\approx 100\text{ MW}\cdot\text{m}^{-2}$ . Under these conditions, several  $\text{mm}^3$  of material ablated and production of films and dust in the surrounding areas were observed [633].

#### 4.5.2.3. Runaway electrons

The generation of significant levels of super-thermal multi-MeV runaway electrons following the onset of plasma disruption is a well-known effect in tokamak devices. These runaway electrons persist during current quench disruptions and can produce a current of up to about half of the pre-disruption plasma current in many present experiments, especially at low plasma densities, (e.g., TFTR [635], Tore Supra [636], JET [637, 638] and JT-60U [175]). In present experiments, the magnitude of runaway electron generation varies, from none detectable to up to  $\approx 50\%$  of the initial plasma current. Appreciable conversion of the plasma current to runaway electrons is not generally seen in VDEs in divertor tokamaks with non-circular cross-sections (Sect. 2.3.2.2). In contrast, major conversion is seen in limiter tokamaks with circular cross-sections, in which the post-disruption plasma is vertically stable [13]. Data obtained in JT-60U divertor plasmas show that MHD fluctuations [175] and vertical instabilities play key roles in determining the magnitude of runaway electron generation. Disruptions with high levels of fluctuation and vertical instability are essentially runaway-free, apparently because the fluctuations produce prompt runaway losses that obviate the build-up of appreciable runaway current. Disruptions or disruption phases with vertical stability and/or lower fluctuation levels produce runaways because current is still inside the core plasma. The level of fluctuation appears to be the factor that determines whether or not runaway electrons develop: vertical instability apparently enhances the fluctuation level. However, the exact mechanism for how vertical instability affects the fluctuation level is not yet clear.

Theoretical considerations suggest that the runaway electrons conversion mechanism -

the so-called knock-on avalanche - may lead to potentially worrisome levels of runaway energy deposition in a high-current disruption or loss-of-control VDE, or a pellet-injection-initiated fast plasma shutdown (Sect. 2.3.2.4). The impact of runaway electrons with wall components will give rise to localised high heat deposition, leading to significant damage. Although, in recent years significant progress has been made in characterising runaway electrons generation [13, 638], there are still uncertainties in the quantification of material damage.

Present experiments [170] show that runaway deposition is very sensitive to toroidal alignment and that the thermal load deposition is localised. Runaway electrons generated in the current decay following a disruption in Tore Supra [170], pierced the leading edge of an in-vessel tube and caused a water leak. This general vulnerability of modular limiters to runaway electrons was one factor in the move at Tore Supra toward a toroidal "floor" limiter, which eliminates any leading edge.

In a recent investigation of the runaways generated in disruptions in JET [638], detailed time and space resolved X-ray images of the runaway beam in flight were obtained for the first time using radiation protected soft-X ray cameras. These allowed a detailed diagnosis and analysis of the production and movement of the runaways. The runaways were generated at the vessel centre in a region with small minor radius and they then move to interact with the wall. The interaction zone of the runaways was a small region with a poloidal width of less than 10 cm of the upper or lower vessel depending on the direction of the vertical movement of the beam. The runaway-wall interaction varied very rapidly with time and showed a series of very fast spikes. The diameter of the runaway beam at the moment of impact with the wall was 0.8 m. The centre of the beam has a minor radial velocity of 190 m/s, and the runaways would therefore all hit the wall in 2.1 ms, in good agreement with the value measured of 2 ms.

In the Frascati Tokamak Upgrade (FTU), the energy content of a high density discharge is relatively high compared to the material area that receives the power released during the thermal and magnetic quenches. This results in very high disruption heat loads on PFCs. This is particularly true in discharges limited by a poloidal limiter. Power loads as high as  $500 \text{ MW}\cdot\text{m}^{-2}$  during the thermal quench and  $200 \text{ MW}\cdot\text{m}^{-2}$  during the current quench were recorded by using a single spot infrared detector [639], viewing a limiter zone far from the equatorial plane. Large overall heat loads are expected, due to the plasma column movement during the current quench and/or the runaway electron losses. A power load in excess of  $1 \text{ GW}\cdot\text{m}^{-2}$  was estimated from the amount of molten material found on a tungsten-coated molybdenum limiter [640]. A large contribution to the inboard limiter damage was attributed to the electron runaways generated during the fast rise of the loop voltage at the end of the thermal quench. In Fig. 52a tungsten-coated TZM (see glossary) mushroom of the inner half of the FTU poloidal limiter is shown. Severe melting and deep cracks can be observed on the mushroom surface. Recently, the runaway losses during disruptions were investigated by monitoring the photo-neutron production [641]. Results suggest that the Dreicer mechanism [119] is the primary source of runaway electrons during FTU disruptions and that in high-density clean discharges, this production is reduced to a negligible level. Samples of W+1%

La<sub>2</sub>O<sub>3</sub> exposed to disruptive discharges with negligible runaway production exhibited no evident damage or erosion [642].

Heat pulses due to the thermal quenches accompanying disruptions and ELMs represent a formidable design challenge for a next-step reactor. The very high transient heat loads (GW/m<sup>2</sup>), can vaporise the material and, for metals, lead to the formation of melt layers. Transient heat loads impact the PFC erosion lifetime and cause the influx of impurities into the plasma. Long reconditioning of plasma-facing surfaces after a severe disruption might be required. There are major incentives to avoid the occurrence of disruptions and to reduce or mitigate the direct and consequential effects (Sect. 2.3.2.4).

*Insert Fig. 52*

#### 4.6. Control of Plasma-Material Interactions

##### 4.6.1. Introduction

The surfaces of PFCs have a profound effect on the plasma. The number of hydrogenic atoms in the surface that interact with the plasma typically exceeds the total number of plasma ions by at least two orders of magnitude. Small changes in wall conditions can strongly affect the influx of hydrogenic atoms or impurities to the plasma edge and thereby determine the boundary conditions imposed on the hot plasma in the core. In turn, the plasma can change the atomic composition of the wall surface, leading to a complex coupled system that is difficult to diagnose and control. However, experience from the earliest days of fusion research has shown that such control is essential for the production of high performance plasmas. Impurity densities must be kept below approximately 1% for low-Z elements and as low as 10<sup>-5</sup> for high-Z elements such as tungsten to avoid serious radiative losses. In a burning plasma, impurity influx will reduce plasma performance by dilution of the deuteron and triton density. Available wall conditioning tools are (i) baking and/or discharge cleaning to deplete the wall surface of hydrogen isotopes and potential impurities, (ii) film deposition to cover up the wall surface with a more favourable element, and (iii) an in-vessel divertor cryopump to pump hydrogen and volatile impurities.

The currently available database from particle balance experiments in tokamaks reveals marked differences in wall pumping (see glossary) and release behaviour, due to factors such as limiter or divertor configuration, wall material, wall temperature, active pumping by in-vessel cryopumps, etc. [643, 644]. Uncovering the relevant physical processes is arguably more challenging than understanding core plasma physics, because of the large variety of phenomena that are coupled (from solid-state physics to plasma transport), and the complex geometry for which simplifying assumptions, such as radial symmetry, are not possible. Spatially-resolved diagnostic coverage of the wall/plasma-edge region is rather limited or completely lacking. Tokamak operators develop intuitive working hypotheses of recycling phenomena based on their experience of the factors most conducive to optimal performance. This is an area where unambiguous identification of the specific reasons for the different behaviour in different tokamaks is often impossible and anecdotal information on plasma performance is all that is available. The lack of a predictive understanding adds significantly

to uncertainty in projections of performance of next-step long-pulse devices.

In the sections that follow, we discuss the tools available for wall conditioning, the state of the wall surface, and the effects of the wall on the plasma, including density control in long (> 60 s) pulses. Wall conditioning requirements in long-pulse next-step devices are briefly discussed in Sect. 2.3.1.4 and in Ref. [13]. The physics of hydrogen trapping in materials, including ion-induced release of hydrogen from carbon, is treated in Sect. 3.5. Section 5.5 is devoted to models of recycling, including predictive analysis for next-step devices. Wall conditioning techniques aimed at controlling the tritium inventory in a future DT device are discussed in Sect. 4.7.3. Earlier reviews of hydrogen and helium recycling in tokamaks are in Refs. [645, 646].

#### 4.6.2. Wall conditioning

Baking and plasma-assisted cleaning are the main methods to remove the “adsorbates” from the surfaces before or in-between plasma operation. Many contemporary fusion devices have the capability of vacuum baking to temperatures in excess of 470 K, including DIII-D, TEXTOR, JT-60U, JET, and reductions in both recycling and impurity influxes are obtained when baking is used. In TFTR direct heating above 423 K was not possible, but the limiter could be heated with intentional disruptive discharges to 573 K [647]. Baking is greatly enhanced by simultaneous or subsequent plasma-assisted conditioning. This is done, for example, by running low energy conditioning plasmas such as GDC [36, 37], but various other methods based on RF techniques [38] at the electron-cyclotron resonance (ECR) [39, 40, 160] and ion-cyclotron resonance (ICR) [41] have been employed. The Large Helical Device (LHD) is limited to wall temperature below 368 K and relies on mild baking combined with ECR discharge cleaning and GDC [40].

Oxygen is present at the material walls in the form of adsorbed hydroxides, water and various metal oxide compounds, and oxygen influx must be controlled. The original sources of the oxygen contamination are air and water leaks, water vapour that has been adsorbed on the surfaces during vacuum vessel openings, as well as long-term diffusion from the bulk to the surface of the in-vessel materials. The cleaning by the plasma is due to the formation of volatile compounds, which are either formed chemically upon the impact of atomic hydrogen or which are released by ion-induced desorption due to collisional energy transfer from the impinging particles. Hydrogen plasma impact can reduce metal oxides by forming metal-hydroxide surface complexes and finally water molecules, which can be pumped [42, 648]. In addition, adsorbed oxygen can be released in the form of CO and CO<sub>2</sub> molecules by collision-induced desorption in helium conditioning plasmas [649] and also, in hydrogen plasmas, by the chemical reaction of hydrogen with carbon (via a hydrocarbon precursor), and the release of the stored oxygen in the form of CO and CO<sub>2</sub> [309]. The volatile products have to be pumped out and it is essential that the re-ionisation of the reaction products be small so that they are not re-deposited on the surfaces. This latter important condition requires a sufficient gas throughput and a low operating pressure of the conditioning plasma. Often, hydrogen GDC is followed by helium GDC to remove hydrogen from plasma-facing surfaces [650].

Baking and discharge cleaning are applied routinely in present-day fusion experiments, after openings, vacuum or water leaks. They are also of importance after off-normal events like VDEs or disruptions that can release loosely bound adsorbates from hidden areas, which then are adsorbed on the plasma-facing surfaces. As a general trend, low wall temperatures aggravate the consequences of disruptions compared to operation at elevated wall temperatures [650].

In several devices discharge-cleaning methods are also used in between plasma pulses. Besides removing impurities, helium glow discharges also induce release of hydrogen trapped in the wall (Sect. 4.6.3) aiding plasma density control and reducing the frequency of disruptions [649]. In general, oxygen impurities become increasingly deleterious as the density limit of the machine is approached. This is a consequence of the fact that the oxygen sources are located on the entire wall surface. Oxygen can easily be released by either particle impact or by photon-induced desorption [651]. Incident photons produce charge recombination in the bulk, which in turn leads to interaction with adsorbates that are bound to the surface by charge transfer, and the release of CO and CO<sub>2</sub>. Since this latter mechanism is proportional to the amount of radiation, an increased oxygen level will lead to even more oxygen influx in a non-linear way. The density rise shown in Fig. 53 is attributed to water desorption induced by wall heating due to the high radiated energy of the plasma ([652] and Sect. 4.6.3).

*Insert Fig. 53*

One complication in long-pulse devices is that the magnetic field is generated by superconducting coils with a limited number of on/off cycles, so conditioning needs to be done in the presence of the field. While it was possible to generate a glow discharge in the presence of a magnetic field, little release of hydrogenic atoms was achieved [653]. Therefore, new ICRH conditioning techniques have been developed for superconducting devices [41, 654] (Fig. 54.)

*Insert Fig. 54*

Deposition of thin films of various materials on the entire plasma-facing wall is a more direct way to modify the composition and surface properties of the plasma-facing surfaces. Films have been deposited by chemical vapour deposition (CVD), solid target erosion and deposition, and pellet injection, but the technique mostly used is coating by plasma deposition [651, 655, 656]. H<sub>2</sub>O, CO and CO<sub>2</sub> partial pressures between discharges, and plasma contamination in subsequent discharges was greatly reduced by titanium evaporation over a large fraction of the vessel surface in ATC [657]. The technique was easy, effective and reliable, but titanium stores large amounts of hydrogen, and after some time the layers of titanium would flake and enter the plasma, sometimes abruptly terminating discharges [658]. Other evaporative getters used include aluminium [83], chromium [659], beryllium [660, 661] and lithium [662] (Table 1). All of these elements are able to reduce oxygen and carbon impurity contamination by chemically binding these species to the wall. The JET tokamak has used beryllium as a getter both by using solid beryllium targets and by frequent evaporation of beryllium onto the inner wall surface. This has reduced the oxygen contamination



of the JET plasmas to negligibly small values and has also led to a good control of the plasma density by wall pumping [663] (Sect. 4.6.3).

In the mid-1980's, work began at the TEXTOR tokamak investigating the effect of a number of plasma-deposited surface coatings, including carbonisation, boronisation and siliconisation [655, 664]. All of these techniques involve the use of low temperature discharges (e.g., DC or RF glow discharges) in D<sub>2</sub> or He to dissociate C-, B- and Si-containing gases, (typically, methane, borane and silane, respectively). The treatment usually requires one to a few days, and results in a coating of approximately 100 nm thickness, consisting of a mixture of the respective material, plus deuterium and impurities such as carbon and oxygen. This is highly desirable, since unlike metals, these elements radiate only at the plasma edge [656, 665]. Carbonisation, indeed, decreased the concentration of metal impurities in the plasmas significantly and the process is usually repeated when the metal impurities reappear. In the 1990's, this 'covering up' of metal surfaces has been taken to an extreme in DIII-D [105] and other tokamaks (e.g., TCV, JT-60U), where >80% of the plasma-facing surfaces are now graphite tiles, whether plasma-contacting or not. However, carbonisation of the walls has proven to be less effective in controlling the level of oxygen. The use of boron films (boronisation), on the other hand, has been found to be much more effective at providing simultaneous control of the metal and oxygen influxes [48, 666–668]. Boronisation is now the primary gettering technique in current tokamaks. It is able to keep the oxygen level low for a substantial time and allows rapid recovery from air venting. The boron layers do not react significantly with molecular oxygen up to temperatures as high as 620 K, and their gettering action is due to co-deposition of eroded boron along with oxygen in the SOL regions of the device and the strong bonding of the oxygen in these layers. Thick boron carbide coatings have been proposed for high-heat-flux areas such as tokamak divertors [669].

Boronisation has significantly widened the operational regime towards high-density on TEXTOR and other tokamaks (Fig. 55). Siliconised wall conditions were most effective for reaching very high densities in TEXTOR-94, with maximum values of nearly twice the Greenwald density limit (see glossary) [670] and efficient suppression of oxygen impurities [47]. In DIII-D, boronisation has led to a very high confinement mode (VH-mode) [44]. Boronisation in the Mo-walled Alcator C-Mod tokamak leads to a considerable decrease of the molybdenum core radiation and better H-mode performance [43]. The reduction in radiated power leads to a lower H-mode power threshold. However, an improvement in confinement has not been observed after boronisation of TEXTOR, ASDEX-Upgrade and JT-60U. This different behaviour is not fully understood and demonstrates the complex link between the properties of the wall, the plasma edge, and confinement.

*Insert Fig. 55*

*Refs. [670, 671] appear in the caption of Fig. 55. They are reported here to maintain consistent reference sequential numbering while appending the tables at the end of the section.*

Lithium has been introduced into plasmas by pellet injection [51, 672–674], evaporation [662, 675, 676], lithium borohydride discharge [677], and by laser-assisted lithium aerosol injection [163]. It has had dramatic effects on the performance of TFTR (Fig. 2 and Sect.

1.2.3), greatly increasing the fusion triple product ( $n_e \tau_E T_i$ ) and energy confinement time [52]. However, mixed results have been obtained on other machines (DIII-D, Alcator C-Mod, TdeV, JIPP, TII-U, Heliotron E), in contrast to boronization, which has given similar effects on all machines [678]. Careful preparation is necessary to ensure that the number of free lithium atoms available is equal to the hydrogen fluence to the wall during the discharge. Prior depletion of deuterium in the wall by ohmic conditioning discharges was an essential step in TFTR. Cases where lithium did not make an improvement may be due to existing impurities that consumed the limited quantity of lithium introduced leaving no *free* lithium available to the plasma [545]. Laboratory studies show that chemical reactions with lithium suppress hydrogen and oxygen impurity influxes [545]. Lithium was found to reduce chemical sputtering of carbon by 25%. Physical sputtering was also reduced. Intercalation (mixing) of lithium into graphite was evident and lithium was preferentially sputtered over carbon, leading to an order of magnitude reduction in net carbon sputtering yield. Materials mixing in the carbon and lithium systems appears to be a key process to successful lithium wall conditioning [679]. Renewed interest in liquid lithium as a plasma-facing material [54] makes these low-recycling regimes relevant to fusion reactor studies.

In-vessel cryopumps may be used to control recycling by pumping part of the flux recycled from the wall before it reaches the core plasma. This leads to a decrease of electron density and an increase of electron temperature at the plasma edge. The implantation depth is then changed and deeper wall implantation occurs leading to an increase in particle pumping by the walls. Only with active pumping has it been possible for JET to obtain ELMy H-mode plasmas of density near or at the Greenwald density limit with acceptable energy confinement time [680]. A pumped limiter or divertor can also be used to control the wall hydrogenic inventory [681–684].

In DIII-D, a cryopump allows pumping of the lower divertor region during discharges [685, 686]. Assessment of the particle balance with the cryopump operating indicated that the wall could actually be unloaded during the course of the discharge, i.e., under certain conditions more particles could be pumped than had been injected into the plasma. The cryopump was found to pump/unload the wall even without helium GDC, resulting in excellent density control and good plasma performance [687].

#### 4.6.3. Hydrogen isotope recycling

Carbon plasma-facing surfaces retain hydrogen (H, D, or T) energetically implanted from the plasma (Sect. 3.5.3) and can subsequently release it, affecting plasma density and performance [645, 688, 689]. The capacity of the wall to retain H depends on incident ion energy and wall conditions [646]. The wall conditioning procedures described in Sect. 4.6.2. can change the hydrogen content and increase particle recovery after a discharge [34, 689, 690]. In the absence of gas fuelling or external active pumping, the wall alone can fuel a low-density plasma [688]. If higher densities are needed, gas injection is used to drive the plasma-wall equilibrium to a higher density. In the presence of carbon walls, the fuelling efficiency of gas injection is low (1–20%) [31] as most of the injected gas is trapped directly in the walls. With the introduction of Be in JET strong pumping was observed which increased the fuelling

required by a factor of 4 [691, 692] and allowed the attainment of a very high ion temperature [100]. A comparison of wall deuterium retention and plasma fuelling requirements in the ASDEX-Upgrade, DIII-D and TdeV tokamaks is reported in Ref. [693].

Recycling fluxes are composed of particles coming out from the wall reservoir and particles from the plasma that are back-scattered or reflected directly by the wall (about 20% of impinging particles in the case of carbon [379]). The recycled flux raises the neutral density in the plasma edge and the flux of energetic charge-exchange neutrals to the wall. These neutrals carry energy out of the plasma edge, thereby cooling it.

In many cases the highest plasma confinement and DD neutron production has been obtained in low-density discharges with low hydrogenic recycling such as negative central shear, supershot, hot-ion H-mode and VH-mode discharges [694–696]. All these regimes rely on wall-conditioning procedures (Sect. 4.6.2), to reduce recycling. In axisymmetric divertor machines, the H-mode transition is also strongly related to the control of particle influxes, although the causal linkage is not entirely understood [697–699]. Low-recycling fluxes are also needed to obtain reproducible start-up conditions and obtain a good plasma current ramp-up.

A major handicap to a detailed understanding of recycling processes is the difficulty of directly measuring the atomic ratio of H/C on the plasma-facing surfaces during a plasma discharge. In TFTR the ratio of  $D_\alpha$  to C-II emission (see glossary) was used during supershot conditioning as a convenient measure of wall conditions [108] (Fig. 56). A sensitive characterisation of the wall was obtained by measuring the tritium concentration in the JET sub-divertor during the DTE1 experiments [511]. A pre-discharge estimation of wall saturation status of Tore Supra was derived from the small plasma currents during the initial phase of the discharge when the poloidal coils are energised [700]

In the absence of measurements of H/C in the wall, we can consider only the balance between the particles added to the vessel and those removed, the difference being the number of particles retained in the vessel walls [646, 701, 702]. Such empirical reservoir models are described in Sect. 5.5.

*Insert Fig. 56*

Recent tritium experiments offered new opportunities to track hydrogen isotopes. Fuelling of the plasma core by recycled deuterium was derived from the DT neutron rate in TFTR plasmas with tritium-only NBI [33]. The DTE1 campaign at JET in 1997 allowed a detailed study of hydrogenic isotope recycling and retention in a pumped divertor configuration relevant to ITER. There appear to be two distinct inventories of retained tritium: dynamic inventory and inventory controlled by co-deposition.

The dynamic inventory, i.e., hydrogen (deuterium and tritium) recycling, is governed by implantation and isotopic-exchange of charge-exchange neutrals in a thin layer over the whole vessel surface area [204]. Because a relatively low particle flux over a large area is involved and the hydrogen content of the wall is large compared to the content of the plasma, modest reductions in the wall inventory produce large wall pumping effects which persist for many discharges. In some materials the implanted hydrogen may diffuse beyond the implantation

depth during the discharge, and this may also contribute to the observed wall pumping [703]. The high tritium retention fraction (>90%) observed in L-mode experiments in TFTR was due to isotope-exchange with deuterium in the wall (Sect. 4.7.2.2.2).

In the second category, co-deposition of hydrogen leads to a continually growing inventory, trapped in co-deposited layers (Sect. 3.5.3.6). The inventory of co-deposited hydrogen plays a small role in the particle balance of a single discharge, but continually grows and ultimately dominates the hydrogenic inventory. Fuel balance studies of wall pumping in TEXTOR-94 also show these two components to hydrogen retention [704, 705].

From the PMI point of view, long discharges permit us to explore conditions close to a reactor. Control of recycling is important as the current drive efficiency decreases when plasma density increases [652]. Also, control of the radial density profile and, therefore, of the recycling sources is essential for generating non-inductive bootstrap currents, another way to achieve long-pulse operation. Today, only two machines have achieved long-pulse operation at relatively high plasma density. In JET, 60 s duration discharges showed an uncontrolled increase in density [643]. Discharges of up to 120 s duration were realised on Tore Supra with the help of lower hybrid current drive [124]. The Tore Supra vessel is maintained with a wall temperature higher than 420 K by means of a 3 MPa water loop system. However, an increase of plasma density (which accelerates in time) was observed (Fig. 53). The higher the injected and radiated powers, the sooner the increase of density appeared. This behaviour was not due to exhaustion of the pumping capacity of the wall. No evidence of wall saturation during these long discharge pulses was found, probably due to the low-density operation which is needed to get good current drive efficiency [124, 652, 706]. Instead, the behaviour was correlated with an increase of the oxygen and hydrogen (protium) plasma density. It is attributed to water desorption induced by wall heating due to the power radiated from the plasma. The water originates from surfaces that are far from the plasma and are not baked during the conditioning procedures usually used at Tore Supra [652].

Apart from the limitation on the heat exhaust capability on Tore Supra, the observed increase of the electron density during long-pulse discharges is a barrier to achieving steady-state operation. This underlines the importance of having an effective steady-state particle exhaust scheme for long-pulse operation. The Tore Supra Upgrade project 'CIEL' (see glossary) [707] will address this issue by the installation of a toroidal pumped limiter in the year 2000. It is designed to sustain a conducted heat flux of up to  $10 \text{ MW}\cdot\text{m}^{-2}$  and remove a total convective power of 15 MW for a pulse duration of 1000 s. The calculated pumping efficiency of this limiter is of the order of 12%, which corresponds to an extracted flux of  $4 \text{ Pa}\cdot\text{m}^3\cdot\text{s}^{-1}$ . This capability is designed to be sufficient to ensure a good density control. Around the vessel, stainless steel actively-cooled wafer panels will remove radiated power (up to 15 MW), to control water de-trapping, and therefore, to avoid any density excursion due to impurity release.

#### 4.7. Database on H-isotope Retention and Removal

Mechanisms of hydrogen retention in metals and carbon have been discussed in Sect. 3.5. Here, we review experience gained from retention of hydrogen isotopes in various operat-

ing tokamaks, with emphasis on the two tritium-fuelled devices, TFTR and JET. We also review controlled laboratory and tokamak experiments on the removal of co-deposited H-C layers. The experience gained from studies of hydrogen isotope retention and removal in tokamaks, particularly tritium removal in TFTR and JET, is of paramount importance for understanding underlying mechanisms and for assessing the impact of tritium retention on design and operation of next-step devices.

#### 4.7.1. Deuterium retention in tokamaks

The long-term accumulation of deuterium has been examined in several tokamaks through measurements of deuterium on PFCs. The observed magnitude and distribution of deuterium retention in different tokamaks shows that co-deposition with carbon is the dominant long-term fuel retention mechanism in tokamaks with carbon PFCs. This co-deposition often results in the retention of a large fraction of deuterium used to fuel plasmas. Here, we review the database for deuterium retention in tokamaks, with emphasis on TFTR and JET where the extensive D operation provided the prelude for subsequent DT campaigns. Relevant data from other machines will be briefly highlighted. Tritium retention in tokamaks will be discussed in Sect. 4.7.2 while the closely related topic of erosion/re-deposition in tokamaks was presented in Sect. 4.3.

##### 4.7.1.1. Deuterium retention in TFTR

Prior to tritium-fuelled plasma operation there was an extensive evaluation of the anticipated in-vessel tritium inventory and the constraints this would impose on the TFTR DT experimental program. To establish a basis for predicting future tritium inventory, the in-vessel inventory of deuterium was followed from 1986 through 1991.

An initial comprehensive study of D retention was made following the operational period from November 1985 to July 1987 [488, 708]. During this period TFTR produced 9922 high-power plasmas with nearly circular cross section. The plasma boundary was defined by contact with a limiter of graphite tiles on the inner wall subtending poloidal angles from  $60^\circ$  below to  $60^\circ$  above the mid-plane with a total area of  $22 \text{ m}^2$ . The base temperature of first-wall components in TFTR was normally about 320 K. However, the surface temperature rose during the discharge, with hot spots up to 1070 K or higher. Following this period, in-vessel measurements of metal deposition on the limiter were made using beta back-scattering [709], which provided a global deposition pattern over the entire limiter (Fig. 57). The map reveals regions of low metal deposition at the lower right and upper left, corresponding to regions of net erosion, and areas of high metal deposition in the upper right and lower left. Proton-induced X-ray emission analysis of removed tiles confirmed this finding. The connection length (see glossary) of a field line launched from the limiter surface varies strongly with spatial position and influences the balance between erosion and co-deposition [563]. The regions undergoing net erosion were also observed to be the regions receiving the highest heat and ion fluxes [710-712]. Beta back-scattering showed net erosion occurring over approximately one third of the limiter area and net deposition over the remaining two thirds.

Areal density of deuterium on the removed limiter tiles and wall coupons was measured by NRA, with a depth range of about 10  $\mu\text{m}$  in fully dense graphite, which in most cases was sufficient to reach through the deposited layer. On the plasma-facing surfaces of the limiter tiles, there was a close correlation between the areal densities of deuterium and metal atoms. This correlation is due to the fact that regions undergoing net erosion have the least metal and deuterium coverage, whereas in regions of net deposition the metal and deuterium coverage both increase as the thickness of the deposited layer increases. Optical and electron microscopy on limiter tiles showed a layer of deposited material up to tens of  $\mu\text{m}$  thick, with a large volume fraction of open porosity on regions of net deposition, [709]. Ion-beam analysis showed this deposited material to consist of mainly carbon and deuterium, with small amounts of other elements (several atomic percent of oxygen and about 1 at.% of metal atoms (Cr, Fe, Ni)).

*Insert Fig. 57*

Thick layers of deposited material were also found on the sides of the limiter tiles, i.e., in the gaps between tiles [488, 708], especially on tiles where net erosion of the plasma-facing surface was high (Fig. 58). This pattern of deposition shows that even on tiles undergoing net erosion, there is a large flux of carbon onto nearby regions shaded from erosion by direct ion flux, such as the gaps between tiles. In TFTR, the deuterium deposited in the gaps between limiter tiles was a significant fraction of the total in-vessel inventory of deuterium. The deuterium concentration was also measured (by NRA) in the bulk of the graphite far beyond the range of energetic implantation, and was less than 0.5 atomic ppm at a depth of 2  $\mu\text{m}$  beneath the plasma-facing surface of a tile from the TFTR limiter near the mid-plane. This measurement shows that diffusion deep into the bulk did not contribute significantly to the in-vessel inventory of deuterium in TFTR [488, 708].

Ex-situ ion-beam analysis of wall coupons gave a detailed picture of deuterium and carbon deposition on the vessel wall. Carbon atom areal density ranged from about  $4 \times 10^{21}$  to  $4 \times 10^{22}$  atoms- $\text{m}^{-2}$  with an average D/C ratio of 0.33, close to the room-temperature saturation value of 0.4 for D implanted into carbon. This high D/C ratio indicates that the rate of D accumulation on the wall may be determined by the carbon deposition rate rather than by the flux of deuterium onto the wall. Deposition was fairly uniform toroidally but was several times higher at the top and bottom of the vessel than at the outer mid-plane. This pattern of deposition is reasonable since the carbon deposition should be higher closer to the source of the carbon, which is the graphite limiter on the inner wall.

*Insert Fig. 58*

The D retention in TFTR was also followed from 1987 through 1991 [708]. Each year, a standard set of limiter tiles and wall coupons were removed and analysed for deuterium accumulated during the preceding run period. Beta back-scattering and ion-beam analysis showed that regions of net erosion and deposition on the limiter remained similar from year to year.

Table 13 summarises the deuterium inventory in TFTR determined from these studies and the corresponding plasma fuelling during each run period. This data shows the range of variation in D retention observed over several years with changing machine operating conditions. Over the 5-year period, a total of 33.6 g of deuterium was retained in the vessel and a total of 83 g of deuterium was used to fuel plasmas. Therefore, during this 5 year period, 40% of the deuterium used to fuel plasmas remained inside the vessel. Of this retained deuterium, 47% was on the plasma-facing surface of the limiter, 15% was in the gaps between limiter tiles and 38% was on the remaining vessel wall; (Fig. 59).

*Insert table 13*

*Insert Fig. 59*

It was also observed that the fraction of D retained increased with increasing neutral beam heating power [202]; (Fig. 60). Higher power input to the plasma appears to cause greater carbon erosion and thus more co-deposition. Also, the C-II emission increased with NBI power, indicating a more intense interaction of the plasma with the limiter.

Deuterium retention in TFTR was also examined by fuel balance methods in which the quantity of deuterium injected into the plasmas as gas or neutral beams was compared with the quantity of deuterium recovered by the vessel pumping system [713]. These studies showed that after many similar ohmic deuterium plasmas, a steady-state condition was reached in which about 75% of the D input was retained by the vessel. In deuterium neutral beam heated plasmas the fraction of D retained increased from 25% to 65% with increasing neutral beam power (Fig. 60). Although the short-term D retention from fuel balance varied depending on recent operating history, on average, the fraction of D retained was large, consistent with the D inventory estimated from component analysis. In contrast, fuel balance measurements on plasmas, fuelled with helium showed that the fraction of helium recovered was very close to 100%. Energetically implanted helium is retained in carbon, but at lower concentrations than D and the retained He is thermally released at lower temperatures since it is not chemically bound to the C, i.e., it is less strongly bound than D [714, 715]. The weaker binding of helium in carbon is due to the absence of chemical binding, which makes co-deposition ineffective at retaining helium.

In summary, the primary physical mechanism for long-term D retention was co-deposition of D together with carbon eroded from the limiter by the plasma. In the period from 1985 to 1991, a total of 33.6 g of D was retained in the vessel, which was about 40% of the D used to fuel plasmas. This D retention was consistent with results from fuel balance studies [713] and accurately predicted the long-term tritium retention observed during subsequent tritium plasma operation [528, 716] (Sect. 4.7.2.2.2).

*Insert Fig. 60*

#### 4.7.1.2. Deuterium retention in JET

Long-term deuterium retention has been closely followed in JET since 1985 by analysis of components removed after each operational campaign [487, 691, 717–719]. These studies

include periods of operation with limiter and with divertor plasma configurations, and with both carbon and beryllium first-wall materials. By 1988, 55% of the geometric surface area of the wall was covered with graphite or CFC tiles, including all surfaces exposed to ions traveling along field lines. The carbon components included tiles covering the inner wall, two toroidal belt limiters on the outer wall, and 40 poloidal rings of carbon tiles. After the "all-carbon" campaign completed in May 1988, the total long-term D retention in the vessel from about 2500 plasmas was estimated, from hundreds of measurements of D on tiles and long-term samples, to be 3.6 g or about 17% of the D input during the campaign [718, 719]. About 1000 of these discharges were with the "X-point" open divertor configuration in which the upper X-point is positioned just inside the poloidal rings of tiles at the top of the vessel. On belt limiter tiles and X-point tiles, regions of net erosion, with D coverage of  $\approx 10^{21}$  atoms·m<sup>-2</sup>, were seen at locations of highest incident power flux. On nearby surfaces, with lower power flux, there was net deposition of D with carbon. Most of the D inventory was associated with relatively small regions of deposited material. During this campaign, the mean daily retention of D in the vessel was estimated from fuel balance to be about 40% of the gas input [692]. The difference in retained fraction from fuel balance and component analysis is largely due to D removed during venting and He glow-discharge cleaning, which was not included in the fuel balance analysis. Considering this, the D retention estimated by these two methods is in good agreement.

In 1989, beryllium was introduced into JET in two stages. First, Be was evaporated onto the entire inner wall, typically about 10 nm each night prior to plasma operations the following day, then a few months later the graphite toroidal limiter tiles were replaced with Be tiles. The introduction of Be did not significantly change the long-term average quantity of D retained per pulse. Also, the distribution of long-term D retention within the vessel after operation with Be was similar to that for the "all-carbon" phase of 1988 [719]. However, during operation with Be, the amount of D required to fuel the plasmas increased by about a factor of 4 compared to fuelling for "all-carbon" operation [691, 719] (Sect. 4.6.3). This increased fuelling is due to a larger dynamic wall inventory, as mentioned in the previous section, i.e., D which is absorbed by the wall during discharges and then released between discharges. The presence of Be on, or mixed with C, at a significant proportion of the in-vessel surfaces clearly affects the adsorption properties. The observations are consistent with the model [204] that the dynamic inventory is controlled by implantation of charge-exchange neutrals into a thin surface layer over the entire vessel surface area, whereas long-term D retention is dominated by co-deposition of D with material eroded by the plasma from localized regions of high-power flux (see the discussion of dynamic wall loading in Sect. 5.5). However, the thin evaporated Be film is quickly removed from regions undergoing net erosion at locations of highest heat flux, leaving erosion and re-deposition of the carbon, and hence long-term D retention, little affected by the Be evaporation.

To improve upper X-point open divertor operation, the top of the vessel was fully covered by carbon tiles early in 1992 and modifications to improve power loading were made in August 1992. The tile shapes provided shaded regions on adjacent tiles, so that no edges would be exposed to excessive heat flux due to imperfect tile alignment. While in the vessel,



these tiles were frequently coated with thin Be films of fairly uniform thickness from the sublimation sources. Analysis of D and Be coverage on these X-point tiles after the run campaign [691, 718, 719] revealed regions of net erosion, with low D and Be coverage, at locations of highest power flux at the inner and outer strike-points. Areas of heavy net deposition with high coverage of D and Be were present on nearby regions of lower power flux, particularly near the inner strike-zone and in the private flux region. Also, heavy deposition on shaded surfaces in the strike-zones show there was local re-deposition of carbon from the plasma onto surfaces shaded from ion flux.

JET operated with a toroidal divertor in the bottom of the vessel with CFC tiles from April 1994 to March 1995, and with Be tiles from April to June 1995. A cross-section of this Mk-I divertor is illustrated in Fig. 61. Tiles were attached to a water-cooled support so their ambient temperature was  $\approx 320$  K. In contrast, all PFCs had ambient temperatures of at least 570 K prior to installation of the Mk-I divertor. Each divertor tile was inclined along the toroidal direction to shade the edge and some of the surface (typically 15 to 50 %) of the adjacent tile to protect tile edges from excessive heat flux. Subsequent to these two campaigns, tiles were examined by NRA for near-surface D, Be and C [487].

*Insert Fig. 61*

The most striking feature of the distribution of D on the carbon tiles is the heavy accumulation of D in the shaded areas at the strike and SOL regions, i.e., on shaded surfaces adjacent to regions of net erosion (Sect. 4.3.1). Regions exposed to ion flux had low D coverage, indicating net erosion. Also, the D coverage was much higher on the inner leg of the divertor than on the outer leg. Similar patterns of heavy deposition in shaded areas were seen on the inner side-wall tiles as well as on the inner floor tiles, but the outer side-wall tiles had low coverage of D. Within the private flux zone, D coverage was low both inside and outside the shaded regions.

The amount and distribution of D on the Be tiles in the inner half of the divertor was similar to that for the graphite tiles, however, on the outer half of the divertor there was much less D retained on the Be than on the carbon tiles. Ion-beam analysis showed that the heavy deposits on the Be tiles were predominantly carbon and not beryllium and that the regions exposed to ion flux, i.e., of net erosion, were mainly beryllium with little carbon. This leads to the conclusion that even with a Be divertor, D retention is largely due to co-deposition with carbon transported into the divertor from the main chamber. For most of the discharges with the Be divertor, the main plasma impurity was carbon, not Be. Furthermore, carbon must be redistributed by local recycling within the divertor until it reaches shaded areas, which act as sinks. The fact that these deposits are predominately carbon indicates that local recycling transports carbon more efficiently than Be. This may be due to molecular effects, present in carbon but not for Be (Sect. 4.3.1).

Long-term samples exposed at the wall of the JET main plasma chamber to  $\approx 940$  discharges between April and June 1995 revealed net erosion of the surface [720], in contrast to TFTR where the wall is an area of net deposition. This difference is probably due to different impurity transport in the SOL for limiter and divertor configurations. Co-deposition and

long-term retention of D on the JET main chamber wall is restricted to the sides of poloidal limiters. The majority of the main chamber wall is a source of impurities due to erosion by charge-exchange neutrals. Graphite components in the main plasma chamber could thus be the source of carbon deposited onto the Be divertor.

The Mk-IIA divertor (Fig. 61) was installed in JET for operation from April 1996 to February 1998. It was designed to be more closed than the Mk-I divertor, which it replaced, and to exhaust particles through gaps between the floor and side-wall modules at the inner and outer corners making it more like the ITER divertor design. Deuterium coverage was measured by NRA over a set of Mk-IIA graphite floor tiles removed in October 1996, after  $\approx 2000$  pulses. The D coverage was quite uniform toroidally and was low ( $<10^{22}\cdot\text{m}^{-2}$ ) in the private flux region. The ends of tile 7, where D coverage was low ( $<10^{22}\cdot\text{m}^{-2}$ ) and tile 4 where D coverage was high ( $>3\times 10^{22}\cdot\text{m}^{-2}$ ) were shaded from ion flux by the side-wall tiles 8 and 3, respectively (Fig. 61). There was also heavy deposition on the water-cooled louvres beyond the inner corner and on the bottom end of side-wall tile 3. In contrast, the shaded region of tile 7 and the louvre surfaces beyond the outer corner appear pristine. The outer side-wall tiles also appear clean with D coverage of  $\approx 3\times 10^{21}\cdot\text{m}^{-2}$ , compared with an order of magnitude higher D coverage on the inner side-wall. D retention in the Mk-IIA divertor was dominated by co-deposition with carbon beyond the inner corner of the divertor on the louvres and the tile surfaces adjacent to the pumping gap. The pattern of deposition indicated mainly line-of-sight transport from the strike-zone or pumping gap many centimetres into regions shielded from ion flux. This indicates that the carbon is transported as neutral atoms or C-containing molecules (Sect. 4.3.1). The films on surfaces facing the inner pumping gap were measured to be  $\approx 40\ \mu\text{m}$  thick and were seen to flake-off from metal surfaces such as the louvres, probably on venting the vessel. Ion-beam analysis of the flakes gave D/C ratios as high as 0.8 [235]. It was estimated that this heavy co-deposition inside the inner pumping gap resulted in additional long-term retention of at least 6% of the gas fuelling, and this also resulted in higher than expected retention of tritium during subsequent tritium fuelled plasma experiments (Sect. 4.7.2.3).

#### 4.7.1.3. Deuterium retention in other tokamaks

##### *DIII-D*

Several sets of graphite tiles from the lower divertor of the DIII-D tokamak were analysed for retained deuterium in the period from 1987 to 1990 after exposures ranging from 1000 to 5500 high-power plasmas [486]. The pattern of long-term D retention was consistent with measured long-term erosion/deposition on the divertor as shown in Fig. 62. The long-term net erosion at the outer strike-point is also consistent with erosion from short-term exposures to well defined plasma conditions measured using the DiMES facility on DIII-D [721] (Sect. 4.3.1). The picture which emerges from these studies is that net carbon erosion occurs from plasma-facing surfaces near the outer strike-point where the fluxes of power and energetic particles are highest. D coverage remains relatively low on surfaces undergoing net erosion. The eroded carbon is re-deposited in the gaps between tiles and onto plasma-facing surfaces near the inner strike-point where the plasma is often detached and the power

flux and particle energies are lower than at the outer strike-point. The re-deposited carbon incorporates deuterium at concentrations of  $\approx 0.2$  to  $0.4$  D/C. In regions of net deposition the areal density of deuterium, therefore, just depends on the thickness of the deposited layer. Similar patterns of net erosion at the outer strike-point and deposition at the inner strike-point are observed on DIII-D, ASDEX-Upgrade and JET [63]. Reasons for this asymmetry are discussed in Sect. 4.3.1.

*Insert Fig. 62*

#### *Alcator C-Mod*

In Alcator C-Mod, the plasma-contacting surfaces are molybdenum tiles. Erosion and deuterium retention is expected to be much lower than in tokamaks which have graphite as the main plasma-contacting material. Measurements were made of erosion and deuterium coverage on the plasma-facing surfaces of a set of Mo tiles exposed to 1090 plasmas in Alcator C-Mod between November 1995 and March 1996 [112, 213]. The average D coverage on tiles outside the divertor was  $1.8 \pm 0.4 \times 10^{21} \text{ D} \cdot \text{m}^{-2}$ . The average D coverage on tiles inside the divertor was  $1 \times 10^{21} \text{ D} \cdot \text{m}^{-2}$  on the inner strike-plate,  $5 \times 10^{20} \text{ D} \cdot \text{m}^{-2}$  on the outer strike-plate, and  $6 \times 10^{20} \text{ D} \cdot \text{m}^{-2}$  in the private flux region. Assuming the D coverage is toroidally symmetric these data give an in-vessel deuterium inventory of  $0.10 \text{ g}$  outside the divertor and  $0.0025 \text{ g}$  inside the divertor. These D coverages are much smaller than those found on graphite limiter and divertor tiles in TFTR and DIII-D.

Boronisation is periodically applied in Alcator C-Mod [43]. The boron thickness is much greater than the range of energetic D from the plasma; therefore, the measured D retention is likely to be mainly due to implantation of D into the boron layer rather than into Mo. Retention of D implanted into boron is similar to that of D implanted into carbon. D is retained in the implanted layer until a saturation concentration is reached. The areal density of D retained after saturation depends on the thickness of the implanted layer, and hence on the energy of the D. In tokamaks, D retention by this mechanism should quickly saturate at an areal density in the range from about  $1\text{--}3 \times 10^{21} \text{ D} \cdot \text{m}^{-2}$ . The main difference between D retention in Alcator C-Mod and tokamaks with graphite divertors or limiters is that in Alcator C-Mod there was no significant accumulation of material re-deposited by the plasma. The only region of net Mo erosion in Alcator C-Mod was near the outer strike-point where  $\approx 0.15 \mu\text{m}$  of net Mo erosion was measured and the surface boron layer was absent. Thus, the quantity of eroded material is small. D measured by NRA on one of the outer strike-point tiles ( $\approx 6 \times 10^{19} \text{ D} \cdot \text{m}^{-2}$ , mainly within  $0.1 \mu\text{m}$  of the surface) shows that diffusion of D into the Mo gives bulk concentrations of less than  $5 \times 10^{-5}$  atom fraction which would not give a large in-vessel D inventory. Measurements of D depth profiles on tiles from the inner wall showed the D to be within the boron film.

#### *ASDEX-Upgrade*

In the period between March 1991 to July 1995, ASDEX-Upgrade operated with a lower single-null plasma configuration with a divertor consisting of graphite tiles. During this time, the divertor tiles were exposed to about 1900 plasma discharges. Subsequently, tungsten-coated graphite tiles ( $500 \mu\text{m}$  plasma-sprayed W layer with nearly full toroidal coverage

of a region 160 mm wide at both the inner and outer strike-point) were installed in the divertor. From December 1995 to July 1996, the W-coated tiles were exposed to about 800 plasma discharges. At the end of this W divertor campaign, divertor tiles and components from the main plasma chamber were removed and analysed. These two campaigns provide a unique comparison of low-Z versus high-Z divertor material with similar geometry (ASDEX-Upgrade Div I in Fig. 45) and plasma conditions.

A wide array of analysis methods were used to determine the elemental composition of the near-surface region of the components. In particular, the deuterium content was examined using TDS, NRA, and SIMS [525, 586, 722, 723].

For the graphite divertor tiles removed in 1995, the peak deuterium areal density was about  $3 \times 10^{23} \text{ D} \cdot \text{m}^{-2}$  on the inner divertor and about a factor of 2 lower on the outer divertor [525, 722]. The deuterium was observed to be present in deposited material consisting mainly of carbon, boron, H and D of non-uniform thickness due to the roughness of the substrate [722]. The total amount of H and D in the graphite divertor tiles was estimated to be about  $7 \times 10^{23}$  atoms or about 2 g [525].

On the W divertor tiles, the highest D areal density ( $\approx 5 \times 10^{22} \text{ D} \cdot \text{m}^{-2}$ ) was measured in the shaded region of the inner divertor, outside the separatrix. The D areal densities on the W inner divertor plate were several times lower on the unshaded regions than on the shaded regions. On the outer W divertor plate, the D areal densities were about ten times less than on the inner W divertor and were about the same in shaded and unshaded regions. In the case of the W divertor experiment, more than 50% of the total in-vessel D inventory was on the inner divertor while less than 10% was on the outer divertor [586]. The total amount of D retained on divertor tiles during the W divertor experiment was  $1 \times 10^{23}$  atoms (0.3 g) [723] which is 7 times less, or about 3 times less per shot than during previous operation with a graphite divertor. Comparison with the quantity of D used to fuel the plasma during these periods, predominantly by gas injection, shows that with the W divertor, about 2% of the D input was retained [723], whereas during previous operation with a graphite divertor, a major part of the hydrogen and deuterium puffed into the plasma chamber was retained in the divertor [525].

With both the graphite and W divertors, the inner divertor was found to be completely covered by a layer of low-Z material a few  $\mu\text{m}$  thick. On the outer divertor the deposition was discontinuous on the scale of the surface roughness [586, 722], and the deposited low-Z material was found in microdepressions of the rough surface, which are shielded from re-erosion, whereas adjacent protruding parts of the rough surface undergo net erosion and were not covered by low-Z material. The areal density of deposited low-Z atoms was about five times less on the outer divertor than on the inner divertor [586], which is sufficient to account for the much lower areal density of retained D by co-deposition. The similar distributions of deuterium and low-Z deposition shows that for both the graphite and W divertors the dominant mechanism for deuterium retention is co-deposition of D with low-Z elements, mainly carbon and boron, onto the surface. Also, in general, deposition dominates on the inner divertor, while erosion prevails on the outer divertor (see Fig. 45).

Hydrogen may also penetrate into porosity common in nuclear graphites, but the retained

concentration from this mechanism is small and does not contribute significantly to total hydrogen retention. This was shown in a recent study which examined near-surface D retention by NRA, total D retention by TDS and the spatial distribution of D and deposited material, in graphite tiles from the ASDEX-Upgrade divertor [722]. Earlier work [525] concluding that diffusion dominates D retention in ASDEX-Upgrade divertor tiles misinterpreted the large effect of surface roughness on the depth distribution of co-deposited deuterium. The D coverage was also measured on graphite PFCs from the main plasma chamber following the W divertor experiment. These surfaces, which do not have direct plasma contact, had areal densities of  $1\text{-}2 \times 10^{21} \text{ D}\cdot\text{m}^{-2}$ . The observed magnitude and poloidal distribution of this retained D is consistent with a model based on implantation of charge-exchange neutrals from the plasma [586]. Even though the area is large, this mechanism does not dominate long-term D retention, because retention by this mechanism saturates at a relatively low coverage due to the small thickness ( $< 0.1 \mu\text{m}$ ) of the implanted layer.

The observations that the average quantity of D retained per shot, or fraction of D input retained, is about three times less with the W divertor than with the graphite divertor, and that the D is mainly in regions of net deposition on the inner divertor, indicate that with the graphite divertor, D retention is mainly due to co-deposition of D with carbon eroded from the outer divertor. Removing this major source of carbon erosion (with the use of the W divertor) greatly decreased D retention with no adverse effects on plasma conditions.

In 1997, ASDEX-Upgrade began operation with a new divertor geometry (illustrated in Fig. 45 AUG Div II LYRA), which used CFC tiles. In this new geometry, the strike-points are on nearly vertical tile surfaces and the pumping slots are between the strike-points, i.e., in the private flux region. Local maxima in D coverage were observed at both the inner and outer strike-points, as shown in Fig. 45. Plasma-edge modelling indicates that for the Div I geometry the plasma electron temperature is high enough to cause erosion at the outer strike-point but not at the inner strike-point, whereas for the Div II geometry the electron temperature is below the threshold for erosion at both the inner and outer strike-points [551]. In this case, the source of carbon deposition in the divertor is thought to be due to wall erosion [114].

#### *JT-60U*

In JT-60U, the wall is covered with tiles of graphite or CFC, some of which are coated with  $\text{B}_4\text{C}$ . JT-60U operates with a single lower X-point divertor. Deuterium retention was examined (using NRA) on tiles which were exposed to 3170 plasma discharges between March 1991 and October 1992 [724]. About 70% of these plasmas were deuterium fuelled, the remainder, including the last 146 plasmas in this period, were hydrogen fuelled. The analysed tiles included a set spanning the divertor region. The location of the tiles relative to the strike-points and the areal D coverage are shown in Fig. 63 [725]. The lowest D coverage ( $\approx 3 \times 10^{20} \text{ D}\cdot\text{m}^{-2}$ ) is on tile (f) at the outer strike-point, while the highest D coverage ( $\approx 6 \times 10^{21} \text{ D}\cdot\text{m}^{-2}$ ) is on tiles (c) & (d) near the inner strike-point. This is consistent with net erosion of carbon at the outer strike-point and net co-deposition of D with carbon near the inner strike-point. The very low D coverage on tile (f) may also, in part, be due to the

operation with H plasmas at the end of the run period.

*Insert Fig. 63*

#### 4.7.2. Tritium retention and removal in large tokamaks

##### 4.7.2.1. Tritium resulting from DD operations

Tokamaks fuelled solely with deuterium provide T-related experience since the transmutation of D in the plasma produces equal numbers of 1 MeV tritons and 2.4 MeV neutrons. The probability of the DD fusion reaction is about one-three-hundredth of the DT rate, so the quantity of T produced is quite small. For example, the integrated neutron production during the 1986 JET campaign, which was exclusively deuterium-fuelled, was  $2.7 \times 10^{18}$ . Assuming the majority of the tritons are thermalised by the plasma [726], then the  $2.7 \times 10^{18}$  tritium atoms produced are a small fraction of the other hydrogenic ions in the vessel, since the D fuelling during the period was  $\approx 8.8 \times 10^{24}$  atoms [727]. Tritium is thus present in the exhaust gas, retained in the dynamic wall inventory and incorporated in the deposited layers at a ratio of T:D of  $1:10^6 - 10^7$ .

During maintenance periods in between deuterium operations at both JET and TFTR, tritium was released from the PFCs by isotopic-exchange with water molecules [728-730]. Tritium has been found in the exhaust gases from deuterium plasma operations. The percentage of tritium retained (i.e., not recovered in the exhaust) was higher than that of D in both JET [692] and JT-60U [731, 732]. Analysis of tritium in PFCs and exhaust gases shows that 50% or more of tritium produced by D(D,p)T nuclear reactions in JT-60U, during the period between July 1991 and October 1993, remained inside the vessel [733].

Tritium on the first-wall of JET was surveyed after the 1986 campaign, and on some components from 1987 [735]. Graphite tiles from the limiters, inner wall and upper X-point region were removed from the vessel and analysed, together with graphite coupons bolted to several locations on the inner surface of the vessel wall. Samples were cut, fully combusted, and the T measured by scintillation counting. It was thus possible to map the poloidal distribution of T and estimate the total T retained in the vessel. The majority of the T retained in the vessel is found in the graphite PFCs. Overall, the largest amount of T remaining in the vessel was present in the inner wall tiles, although the highest concentrations were found locally at the limiters ( $10^{12}$  tritons·m<sup>-2</sup>). The T distributions on the tiles match more closely the patterns of retained D, and the overall T inventory indicated a fraction of the T generated in the campaign was retained [735], similar to that of the D fuelling retained [727].

The retention of T within TFTR has also been shown to be consistent with the D retention, at about 50% of the T produced from DD reactions [488, 734]. In JT-60U,  $\approx 80\%$  of the retained T was in the first-wall, and 20% in the divertor region [733], as determined by tile analysis. The T content of DIII-D first-wall tiles has been measured by collecting DT gas released by baking tiles outside of the vessel at 1270 K [736]. From this measurement, the fraction of T retained was estimated to be 10% or more. The T content of DIII-D divertor tiles was also measured by beta emission that detects tritium within the beta escape

depth which is about  $1\ \mu\text{m}$ . Measured tritium areal densities near the outer strike-point on the upper and lower divertor strike-plates were in the range from  $2\text{--}15 \times 10^{14}$  tritons $\cdot\text{m}^{-2}$ . Measured ratios of T/D were in the range from  $10^{-7}$  to  $10^{-6}$  [737].

Tritium retention in the molybdenum lined C-Mod was dramatically lower than that in carbon machines. Highly sensitive measurements of beta emission from tiles exposed to 1090 deuterium plasmas in C-Mod were compared to the corresponding neutron fluence. The fraction of DD tritium retained was less than 0.2% [213].

A depth profile for the T in a JET inner wall tile was derived by removing  $\approx 3\ \mu\text{m}$  slices at the surface using a fine emery paper, and progressively thicker slices into the bulk. The majority ( $\approx 98\%$ ) of the T was present within the first  $25\ \mu\text{m}$ , for which the profile is shown in Fig. 64 [735], however, this is less localised than the D, which is almost exclusively in a  $3\ \mu\text{m}$  film at the surface. T profiles into the surface of tiles from ASDEX-Upgrade were obtained by Accelerator Mass Spectroscopy (AMS) [738]. The maximum T level was located  $3\text{--}5\ \mu\text{m}$  from the surface, with some evidence of diffusion (together with D) into the bulk. These data, together with the relative fractions of D and T released on venting or to the pumps, suggest that the T has a greater mean energy distribution at the wall, and is implanted more deeply into the surface. All tritons are born in the plasma core at an energy of 1 MeV. Some may be thermalised before reaching the wall, and will be co-deposited or implanted at surfaces in an analogous manner to deuterons. However, it seems likely that the energy distribution of tritons arriving at the first-wall has a residual high-energy tail, despite the evidence of Carruthers et al. [726].

*Insert Fig. 64*

#### 4.7.2.2. Tritium resulting from DT operations

4.7.2.2.1 *The JET Preliminary Tritium Experiment (PTE) in 1991.* Tokamak operations with DT fuelling have been carried out at JET in 1991 and 1997, and at TFTR from 1993-97. In the first experiment at JET in 1991, tritium was introduced into two pulses by injection from two of the sixteen neutral beam sources. This followed a series of discharges when the two sources were fed with a mixture of 1% T in D to check operational procedures, diagnostics, and transport codes for T in D plasmas [739]; the total T entering the torus during these trace tritium experiments was  $\approx 3 \times 10^{19}$  atoms. The JET machine at this time was fitted with two belt limiters, but the plasma contacted specially shaped tiles at the top of the vessel, which were used as an open divertor (the so-called "X-point" configuration). A total of  $\approx 2 \times 10^{22}$  atoms ( $\approx 0.1\ \text{g}$ ) of T were introduced into the NBI system, but only a total of  $(1.10 \pm 0.09) \times 10^{21}$  T atoms were injected into the torus over the two pulses; each source injected  $0.75 \times 10^{20}$  atoms $\cdot\text{s}^{-1}$  at 78 keV. The T beams corresponded to 13% of the total beam fuelling, as the remaining 14 sources operated in D, and were on for 3.5 s during a 25 s discharge. The T was injected into a plasma fuelled with D, and although the T concentration in the plasma reached  $\approx 10\%$ , the proportion of the total T gas input for each pulse was only 1.3% [740]. The peak fusion power generated during each pulse was 2 MW [727].

Over the weekend following the two high yield PTE pulses,  $(3.7 \pm 0.6) \times 10^{20}$  T atoms were recovered by the Gas Collection System (GCS). Thus, including a small residual amount of T from the setting-up experiments, the remaining torus inventory was  $(7.4 \pm 1.1) \times 10^{20}$  T atoms. Following the next two weeks of clean-up experiments, this retained inventory was reduced to  $(1.5 \pm 1.4) \times 10^{20}$  T atoms. Analysis of a collector probe exposed during the PTE and removed at this time gave an estimate of the retention in the vessel of  $1.8 \times 10^{20}$  atoms, in excellent agreement with the value from the GCS [740]. By the end of operations, three months later (which included an accidental venting to air when  $4 \times 10^{18}$  atoms were released), the retained inventory was reduced to  $(1.0 \pm 1.4) \times 10^{20}$ . Fig. 65 shows the gas sample measurements, and the fit to a recycling model described in [739].

During the shutdown, three months after the PTE, a representative selection of tiles were removed from all parts of the first-wall. The tritium content of the tiles was determined by out-gassing pieces of the tiles, combusting to form HTO and scintillation counting [741]. The T was distributed round the vessel in a reasonably uniform manner, except for a higher concentration in the tiles protecting the inner wall from neutral beam shine-through. The majority of the T remaining on the X-point target tiles was contained within deposited layers. From the measurements, the total T remaining in the vessel was estimated to be  $(3.4 \pm 1.7) \times 10^{19}$  atoms, or about 3% of the T fuelling.

*Insert Fig. 65*

*4.7.2.2.2 The TFTR DT phase 1993-97.* TFTR operated with DT fuelling in three separate campaigns in the period 1993-97 [120]. After each campaign there were extensive clean-up programmes to remove tritium retained in the vessel. Over the 3.5 years, a total of 100 g of tritium were processed, 3.1 g of tritium injected into the plasma via NBI and 2.1 g by gas puffs. Deuterium discharges were used to optimize particular plasma conditions before tritium was injected and the overall isotopic fuelling was 3% T/D.

Tritium exhaust was pumped by the liquid helium cooled cryopanel in the neutral beam boxes and/or by turbopumps in the torus vacuum pumping system. The tritium inventory recovered from the turbopumps and cryopanel was measured by parallel plate ion chambers in the gas holding tanks to an accuracy of typically 5%-7% [528]. However, much of the torus fuelling was by NBI, and only 4% of the T supplied to the neutral beam boxes enters the torus, the rest being pumped directly by the cryopanel. Thus the error in the measurement of the exhaust is comparable to the amount of T entering the torus, which makes a shot-by-shot estimate of the retained T difficult.

At the beginning of the DT campaign in TFTR,  $7.47 \times 10^{21}$  T atoms (360 Ci) was injected into the torus by 21 DT neutral beam heated discharges (most of which only used one T beam source) in two batches, interspersed with 55 DD pulses. The maximum T concentration seen from the Balmer-alpha profiles in these experiments was 7.5% [742-745]. In the absence of further tritium fuelling, tritium decreased with an initial decay constant of 7.5 discharges, which then slowed to a decay constant of 404 discharges, as shown in Fig. 66 [745].

*Insert Fig. 66*



In September 1995, experiments were performed in L-mode plasmas on the isotope scaling of transport and on the efficiency of RF heating. These experiments required for the first time significant amounts of T gas puffing. An accurate measurement of the short term retention was made possible by closing off the torus pumping system and reserving one of the four beamlines solely as a pump for the exhaust. The total torus tritium exhaust was estimated as four times that recovered from the reserved beamline. With strong tritium gas puffing the short term retention rose to above 90% and the  $T\alpha/T\alpha+D\alpha$  fraction observed in the Balmer-alpha spectrum increased to 75%. In contrast,  $T\alpha$  was relatively slow to appear in T-NBI fuelled discharges, the maximum  $T\alpha/T\alpha+D\alpha$  fraction was only 11% after 8 T-only NBI discharges [746]. The Balmer-alpha spectrum reflects the isotopic composition of hydrogen recycled from the limiter [747] and clearly much of the tritium gas puff went to the limiter. A subsequent D fuelled conditioning phase restored the limiter to a low-recycling state for 'supershot' [695] operations (Fig. 67).

During the three periods of high temperature plasma operations (excluding periods dedicated to tritium removal), approximately 51% of the tritium supplied to the plasma was retained in the vacuum vessel [201, 748]. Active tritium removal during maintenance periods was successful in removing substantial amounts of tritium and kept the tritium inventory below the 2 g administrative limit [749, 750]. Removal techniques are listed in Table 14. Air ventilation was found to be the simplest and most effective method of T removal. Generally, relatively more T was released as the vessel temperature and/or air pressure was increased. Some T was tenaciously held and not released, an important consideration in assessing consequences of potential accident scenarios (Sect. 2.3.3). With these techniques, the in-vessel tritium inventory was reduced to 0.85 g by April 1998 i.e., the long term retention (including clean-up) was  $\approx 16\%$  of the tritium input. The out-gassing rate was less than  $\approx 0.1 \text{ mg}\cdot\text{day}^{-1}$ , and the radiological decay rate was  $\approx 0.2 \text{ mg}\cdot\text{day}^{-1}$  [748].

*Insert Fig. 67*

Tritium in the outermost  $\approx 1 \mu\text{m}$  of the in-vessel surfaces was detected by configuring the vacuum vessel as an ionisation chamber and measuring the secondary electron current resulting from the tritium beta decay [751]. This was performed during the tritium removal phase following the 1997 operations and the technique calibrated by noting the current rise after injecting a known quantity of T as a gas. The current measured prior to the injection corresponded to 1600 Ci (0.16 g-T) about  $\approx 10\%$  of the in-vessel inventory at that time. During the clean-up it appeared that all the near-surface T was removed, as the collected current fell almost to zero. This was paralleled by a fall of  $\approx 3500 \text{ Ci}$  (0.35 g) in the inventory, after which the inventory was  $\approx 14700 \text{ Ci}$  (1.5 g), all of which is perhaps more than  $1 \mu\text{m}$  from the surface. Even though it can only detect T close to the surface, beta decay, has potential for providing an in-situ monitor of the near-surface inventory in a tokamak, and this technique may well be useful in future machines [564].

Flaking of co-deposited layers has been observed [565, 752]. This phenomenon was unexpected and occurred after the termination of plasma operations (Sect. 4.8). Tiles, flakes, wall coupons, a stainless steel shutter and dust samples have been retrieved from the TFTR vessel

for analysis [566]. Selected samples have been baked to release tritium and assay the tritium content. The in-vessel tritium inventory is estimated to be 0.56 g and is consistent with the 0.64 g in-vessel tritium inventory derived from the difference between tritium fuelling and tritium exhaust. TFTR experiences co-deposition on the outboard stainless steel vessel wall because of the large carbon source from the TFTR bumper limiter. The average tritium areal density in co-deposits on the outboard wall was  $32 \text{ Ci}\cdot\text{m}^{-2}$ , compared to the average density on the bumper limiter of  $87 \text{ Ci}\cdot\text{m}^{-2}$ . The outboard area is five times larger however, and co-deposits on the outboard wall account for  $2/3$  of the total tritium inventory. Relatively high concentrations of tritium were found at the top and bottom of the bumper limiter, as predicted by earlier modelling (Sect. 4.3.2) [201].

*4.7.2.2.3 The JET DT Experiment (DTE1) in 1997.* During 1997, JET was operated for an extensive period using deuterium-tritium plasmas. This experimental campaign was known as "DTE1" and the main physics results are reported in Refs. [121, 122, 753]. The Active Gas Handling System (AGHS) delivered tritium to both the torus as gas fuelling and the NBI systems, and was able to make accurate measurements of the amount of tritium supplied to each system [754]. All the gas exhausted from the torus was returned to the AGHS where the T was separated from other elements and returned to the uranium beds where it was stored. The AGHS thus operates as a complete closed cycle, and since the T inventory is always measured in the same way, the amount retained in the torus is accurately known.

The main difference to the JET in-vessel configuration since the time of the 1991 Preliminary Tritium Experiment (PTE) [739–741, 755] is the presence of the pumped divertor, together with a toroidal cryopump, a cross-section of which is shown in Fig. 61 (Mk-IIA). Pumping slots in both corners of the divertor allow neutral particles to be pumped by the cryopump. The divertor support structure is water cooled, and as a result, the base temperature of the divertor tiles is 470 K, significantly cooler than the ambient temperature of the rest of the torus (590 K). Water-cooled louvres, located in the pumping slots, shield the divertor cryopump and divertor coils from direct line-of-sight with hot surfaces and particles, while allowing the transmission of particles to the cryopump. Conditioning of the vessel is maintained by occasional evaporations of Be from four sources near the outer mid-plane.

The T fuelling during the DTE1 campaign is shown in Fig. 68. The campaign was interrupted in order to repair the NBI system, and this necessitated a clean-up campaign. The tritium fraction was reduced to  $T/(T+D) \approx 0.01$  in about four days of pulsing in deuterium. Of the deuterium techniques, only tokamak pulses were found to be effective in reducing the T content of subsequent plasmas. Other techniques that were tried are listed in Table 14. While it was possible to reduce the plasma tritium fraction to  $< 1\%$  in about four days (and ultimately to reach a level where the DD neutron rate was larger than the DT rate within a few weeks), it was not possible to reduce the tritium inventory to below  $\approx 17\%$  of the tritium input to the torus [203].

Operation resumed after the NBI repair with about one month of deuterium operation. The plasma tritium fraction during this time fell very slowly and was in the  $10^{-3}$  range. Then, tritium operation resumed, this time with both NBI and gas fuelling of the tritium.

After the last tritium pulse, operation with pure deuterium plasmas reduced the tritium fraction to about  $T/(T+D) \approx 10^{-2}$ . At this level, approximately 25% of the total neutron production is due to DT neutrons [203, 204].

*Insert Fig. 68*

Also shown in Fig. 68 is an empirical estimate of the plasma tritium fraction based on the tritium fuelling history of the DTE1 campaign, and the tritium fraction observed in the exhaust gas following injection of 5mg of tritium during the PTE campaign. The number of pulses to change over from one isotope to another is very similar to the PTE-based prediction, despite the absence of an in-vessel cryopump during PTE.

During DTE1, a total of 100 g of tritium was delivered by the AGHS, of which 65% went to the NBI system at Octant 8. 35 grams of tritium was introduced into the torus: 0.6 g by NBI (which has an overall efficiency of  $\approx 1\%$ ), and the remainder by gas puffing. Fig. 69 shows the torus tritium inventory [719] for the same pulse range as given in Fig. 68. The maximum tritium inventory in the torus during DTE1 (just after the last T-fuelled pulse) was  $\approx 11.5$  g, i.e., more than half of the 20 g of tritium on site.

*Insert Fig. 69*

Also shown in Fig. 69 is the in-vessel inventory calculated by scaling the PTE data. Unlike the plasma tritium fraction, the inventory is very different in DTE1 compared to the expectation based on the PTE. The tritium inventory in DTE1 could only be reduced by a factor of about 2 by pulsing in deuterium, whereas in the PTE a much more complete recovery was achieved. By the end of the Mk-IIA divertor campaign, about 6 g of tritium remained in the torus, i.e., 17% of the 35 g input, and this amount was being reduced by only  $10 \text{ mg}\cdot\text{day}^{-1}$ . The tritium inventory is also shown in Fig. 70, but as a function of the cumulative tritium input to the torus [203]. Total gas balance measurements indicate that about 85% of the input gas is recovered, and approximately 15% of the total input is retained [719]. This is consistent with the lowest levels of tritium retention.

*Insert Fig. 70*

The greater long-term retention in DTE1 compared with PTE is due to deposition in regions which are not in contact with the plasma, and hence which cannot be cleaned-up by subsequent plasma operation. Following a period of operations with the Mk-IIA divertor prior to DTE1, heavy deposition was found on the water-cooled louvres through the pumping slot at the corner of the inner divertor (Sects. 4.3.1 and 4.7.1.2) [235, 719, 756]. This deposition appeared to be an extra mode of retention since the time of the PTE (when there were neither water-cooled surfaces nor a cryo-pumped divertor in the vessel). Fig. 69 also shows predictions if an additional 10 or 20% of the fuelling is retained (for example in deposits not accessible to the plasma). Good agreement with the data is obtained assuming such an additional retention of  $\approx 15\%$ . This is also consistent with the measurements of gas balance referred to in the previous paragraph.

Three months after the DTE1 campaign, the vessel was vented to change the divertor tiles remotely. Firstly, the water was removed from the divertor support structure with the vessel at a (reduced) temperature of  $\approx 470$  K and the structure was allowed to warm up, reaching  $\approx 410$  K. This did not result in a significant release of T (e.g., from the louvres) [203]. The vessel was then vented in a series of five gas purges of increasing pressure, pumping out the torus after each purge. The first two purges were done with nitrogen at 350 Pa pressure, while the vessel was at 420 K, and each lasted four hours. This was followed by three air purges with the vessel at 390 K, at pressures of 10, 25 and finally 90 kPa, for periods of 7, 12 and 4 hours, respectively. The total amount of tritium recovered by this procedure was estimated to be  $\approx 0.6$  g, i.e., 10% of the inventory at the end of plasma operations.

The vessel was then cooled to room temperature, and air was drawn continuously through the torus for the next four months. During this period (the 'Remote Tile Exchange (RTE) shutdown') tiles were removed from the torus, and the tile storage units were also purged with air. The total tritium emanation rate decreased over the course of the shutdown, down to about  $10 \text{ mg}\cdot\text{day}^{-1}$ . At the end of the shutdown, the total amount of tritium collected, including the above purges, was 2.0 g, i.e., approximately 1/3 of the tritium inventory at the end of plasma operation.

Prior to venting the vessel, the rate of tritium release was estimated by extrapolating tritium release results from previous campaigns. Release of fusion product tritium [477] and retained tritium from the PTE indicated an initial release of about 10% of the inventory, and a chronic evolution rate of about 0.01% of the initial inventory per day. While the initial release upon venting agreed with the extrapolation, the chronic release rate was  $\approx 20\times$  higher [203, 204]. Fig. 71 shows the source rate of tritium release during air exposure normalised to the initial tritium inventory for the initial vent following DTE1 compared to the other campaigns [203].

Bakeout of the JET vessel following the RTE, and venting in Summer 1999 and subsequent bakeout, released another 1.25 g of T. In total, tritium release by these "active" methods (3.25 g) thus reduced the inventory by more than one-half, as was also the case for TFTR. The various techniques to reduce the T inventory in the torus used by JET and TFTR and their effectiveness are summarised in Table 14.

Analysis programs have been carried out to provide mapping of the T levels around the vessel, and particularly in the divertor, and the results are shown in Fig. 72. Also, a photograph of a section of the louvres with flakes is reproduced in Fig. 72 [511]. The total retention in the divertor tiles (which were removed in the RTE) was only  $\approx 0.1$  g-T, with a similar amount remaining in the limiter tiles in the main chamber. Depth profiling showed surprisingly large fractions of tritium in the bulk of CFC tiles [453]. Flaking deposits (154 g) were removed from the vicinity of the inner louvres, containing 0.52 g tritium (measured by calorimetry) (Sect. 4.8.3) [757]. Taking into account the 3.25 g released by venting and baking, this means there are  $\approx 2$  g T unaccounted for in the vessel. This T is believed to be present in the large quantities of flakes that have been seen by remote inspection under the divertor structure, having fallen from the inner louvres [758]. A programme to estimate the quantity of these flakes and collect samples for examination is scheduled for the JET

shutdown in 2001.

The enhanced T release fraction upon ventilation is probably due to the nature of the dominant part of the in-vessel inventory, the flaking deposits at, or fallen from, the louvres. These deposits have a high D/C ratio [756, 757] and have not been exposed to plasma ion bombardment: these films may thus be less resistant to detritiation by exposure to humid air. Tiles from the inner divertor were found to have out-gassing rates per unit area more than 10× higher than tiles from other parts of the vessel, which may also be due to the deposits on the shaded edge of tile 3 that are similar to those on the louvres (Sect. 4.7.1.2).

*Insert table 14*

*Insert Fig. 71*

*Insert Fig. 72*

A comparison of tritium retention in TFTR and JET shows striking similarities and contrasts (Table 4.6). The plasma environment in the TFTR SOL and JET divertor spans 2 orders of magnitude. TFTR edge temperatures are typically 200-600 eV while the JET divertor is less than 30 eV. The TFTR SOL electron density is in the  $1 \times 10^{18}$  -  $1 \times 10^{19}$   $\text{m}^{-3}$  range compared to  $1 \times 10^{20}$   $\text{m}^{-3}$  in the JET divertor. In TFTR, 5 g of tritium were injected into circular plasmas over a 3.5 year period, mostly by neutral beam injection. In JET, 35 g were injected into divertor plasmas over a campaign of 6 months, mostly by gas puffing. The beginning of tritium gas puffing lead to close to 100% retention in both machines due to isotope-exchange with deuterium (though this quickly settled to about 40% in JET) (Fig. 67 and Ref. [204]). In JET the T to D isotope-exchange did not saturate during the DTE1 campaign. In TFTR hydrogenic recycling remained dominantly deuterium (except for the September 1995 T gas puffing period) [716]. TFTR had a large source of eroded carbon from the limiter leading to retention by co-deposition with a major part of tritium co-deposited on the TFTR vessel wall and little tritium inventory in flakes. In JET the wall experiences net erosion. We compare co-deposition in the two machines by including the D campaign in JET following DTE1 which reversed the T/D isotope-exchange contribution. During the three run periods TFTR retained 51% of the tritium fuel. Over the DTE1 period and subsequent D campaign (20 May 97 - 31 Jan 98) JET retained 17% of the input tritium. The long term retention in TFTR was 0.6 g (12%) on 3 May 2000 and in JET 2.1 g (6%) on 31 December 1999.

*Insert table 15*

#### 4.7.3. H-isotope removal from C-based co-deposited layers

Tritium removal from amorphous tritiated carbon layers, a-C:T, co-deposits in next-generation tokamaks, such as ITER, has an important impact on machine operation. If in-situ co-deposit removal techniques are quick and effective, both in terms of T removal and plasma performance recovery after clean-up, then the long-term T retention/inventory problem could be mitigated.

In principle, tritium could be removed from materials via thermal desorption or ion-induced desorption. However, the temperature requirement for thermal desorption from C-based materials is much higher (typically > 900 K) [450] than the design temperatures for PFCs (typically 500 K) [3, 211]. Ion-induced desorption at room temperature, or ion isotope-exchange in the case of H, D, and T, is limited to depths corresponding to the ion range, typically a few nm for plasma discharges, and therefore, will not reach the trapped T in the tens of  $\mu\text{m}$  thick co-deposits. Thus, the removal of T from thick a-C:T co-deposits may require the removal of the co-deposits themselves. This can be done by chemical and/or plasma-assisted oxidizing reactions in the presence of oxygen, or alternatively, via abrasive/mechanical techniques.

Oxygen-free techniques for tritium removal have been proposed but need further development.  $\text{CO}_2$  pellet blast cleaning is widely used in the semiconductor and nuclear industries [211]. Preliminary tests using existing equipment at the Sandia National Laboratories [759] did remove the surface layer from a graphite tile from the DIII-D tokamak but also severely eroded the tile. Laser surface heating was proposed as an alternative technique [760]. This takes advantage of advances in laser technology to rapidly heat co-deposited layers with a high-power scanning laser beam delivered via optical fibres. Experimental tests are in progress.

Another possible cleaning technique for use in fusion reactors is cathodic-arc cleaning (also known as transferred-arc cleaning) [761, 762]. Transferred-arc cleaning utilises a DC plasma torch and a secondary power supply attached between the torch (anode) and the part to be cleaned (cathode). The torch produces a plasma which becomes the electrical conduction path for the cleaning arc. The arc attachment to the cathode is influenced by the surface shape, the surface roughness and surface contaminant layers (oxide, organic and/or metal film). The cathode contaminant layers are preferential sites for arc attachment. This is caused by ion charge build-up on the contaminants producing an enhanced electric field that increases in strength until break down of the film occurs resulting in arcing to the cathode [763]. Joule heating of the cathode causes erosion of the contaminant layer and the bulk cathode material beneath. As the contaminant is removed, electron emission ceases and the arc is displaced to another area with remaining contaminant. This process continues until the contaminants are removed.

Here, we shall review attempts and available results obtained for co-deposit removal using thermo-oxidative and plasma discharge techniques. The merits and shortcomings are summarised in Table 16.

*Insert table 16*

#### 4.7.3.1. *Laboratory studies on co-deposit removal via high temperature oxidation*

Extensive laboratory studies of hydrogen isotope removal rates on exposing co-deposited films and D-implanted graphite to air or oxygen have concluded: (i) the release of D occurs in conjunction with C erosion [207–210, 468, 764] and (ii) the D-removal and C-erosion rates depend strongly on film structure.

The D-release rate during oxidation is a critical function of the annealing temperature, and is significant even below 900 K, the temperature needed for thermal desorption in vacuum [450]. At a fixed temperature of 650 K the erosion of an a-C:D film was measured as a function of the annealing time in air; (Fig. 73). Initially, D was released and the thickness of the deuterium-depleted and oxygen-saturated layer increased with annealing time until it finally extended throughout the whole remaining co-deposit layer [468]. Further annealing lead to a thickness decrease until the complete layer was removed.

*Insert Fig. 73*

From an analysis of the reaction products formed by exposing a laboratory-produced a-C:D film to  $^{18}\text{O}_2$  at 470 K, it was concluded [468] that essentially all of the D is removed via  $\text{D}_2\text{O}$  formation, and C is removed by the formation of  $\text{C}^{18}\text{O}$  and  $\text{C}^{18}\text{O}_2$ ; (Fig. 74). No  $\text{D}_2$  and no methane were observed. Surface analysis of such a-C:D films after  $^{18}\text{O}_2$  exposure using X-ray photoelectron spectroscopy (XPS) and secondary ion mass spectroscopy (SIMS) revealed the appearance of carbonyl groups and an increase of hydroxyl groups due to surface oxidation [468]. Thermal oxidation of hydrocarbon polymers provides a plausible reaction mechanism leading to the emission of  $\text{D}_2\text{O}$ ,  $\text{CO}_2$  and  $\text{CO}$ . This mechanism is consistent with the observed surface complexes [468]. Reaction product analysis performed by Alberici et al. [764] of a laboratory-produced a-C:D film exposed to oxygen also showed that  $\text{CO}_2$  dominates the C release, and water, not  $\text{D}_2$ , is the dominant D-containing reaction product.

*Insert Fig. 74*

Mixed-material effects can be important. The threshold temperature for removal of D and C from carbon silicon layers (a-C:Si:D) by heating in air varies with the fraction of Si. For a-C:D layers the removal rate increases strongly above 550 K. With Si concentrations larger than 0.2 Si/(Si+C) the temperature threshold increases to above 650 K [765]. The C removal rate is always lower than the D removal rate and Si is not removed by this method.

D removal from hydrogenated films was also studied under exposure to other atmospheric gases. Nitrogen exposure and heating in vacuum at or below 570 K did not lead to deuterium release from D-implanted layers [207]. On the other hand, exposure of D-implanted layers [207], as well as TFTR co-deposits [209], to water vapour did result in D removal, but with no evidence of C erosion. It is suggested that D is removed via isotope-exchange between the impacting  $\text{H}_2\text{O}$  and the trapped D in the film [207]. Comparing the effectiveness of oxygen and water, oxygen was seen to be considerably more effective in removing the trapped D [207, 209]. While isotopic-exchange and reaction of the water with the carbon may occur, the reaction of oxygen directly with the hydrogen and carbon has the greater effect on the release of hydrogen. In the case of the TFTR co-deposit, initial D removal rates in water vapour were down by factors of 4-8, compared with oxygen under similar conditions (16 Torr and 520-620 K). After about 1 h, no further D removal was observed with water, and a considerable amount of D was still left in the specimen [209]; (Fig. 75). D removal data obtained in oxygen and air are similar (Fig. 75a), indicating that it is the oxygen in air that dominates the film removal process [209].

Insert Fig. 75

Based on available results, it is evident that the D-removal and C-erosion rates depend on film structure, and differ greatly for laboratory-produced films and co-deposits produced in tokamaks. C-erosion rates from laboratory films and D-implanted layers are very similar and are of the order of a few to tens of  $\text{nm}\cdot\text{h}^{-1}$  at temperatures  $< 700\text{ K}$  [210, 208]. In contrast, measured C-erosion rates for tokamak co-deposits are 2-3 orders of magnitude higher under similar conditions [208, 209]. In Table 17, we show derived C-erosion rates and measured D-removal rates during oxygen exposure for several co-deposits obtained from major tokamak devices: TFTR, JET and DIII-D. Table 18 contains several measurements for TFTR and ASDEX-Upgrade specimens during water and/or air exposure. We note that C-erosion rates in oxygen or air (16 Torr) range from  $\approx 0.1\text{-}1\ \mu\text{m}\cdot\text{h}^{-1}$  at 523 K to tens of  $\mu\text{m}\cdot\text{h}^{-1}$  at 623 K. The high removal rate for co-deposited films is in part due to their porosity [708] and resulting large surface area available for reaction.

Insert table 17

Insert table 18

It is evident that tritium can be removed from thick co-deposits of carbon and tritium by heating them in air or oxygen. According to the data in Table 17 and Table 18, if a reactor could be heated to approximately 620 K in air, T-containing co-deposits of tens of  $\mu\text{m}$  thickness could be removed within hours. Based on these rates, thermo-oxidative removal of co-deposits via air exposure is an option for ITER. Also, the limited experience gained from the controlled oxidation experiments in TEXTOR (see below) and the accidental loss-of-vacuum in JET [766] shows promising results for post-oxidation plasma performance recovery.

It is important to note that two key features of tokamak co-deposits make the thermo-oxidation technique viable for T removal. First, the dominant fraction of retained T in the torus is in co-deposits, and second, the co-deposits erode at rates 2-3 order of magnitude higher than the 'bare graphite' tiles not covered by co-deposits [767], e.g., walls of current tokamaks and part of the divertor in ITER. Hence, while the co-deposits are eroded - and the trapped T is released - the thickness of the bare graphite is negligibly affected. Further differentiation in the co-deposit and bare graphite erosion rates could be achieved by local heating of the co-deposit regions. Notwithstanding the differences in erosion rates, the bare graphite will also contribute to the overall CO and CO<sub>2</sub> formation in proportion to surface areas and relative erosion rates, impacting on pumping requirements.

Although the thermo-oxidation technique looks promising, its impact on plasma performance recovery, the effects of impurities and mixed-materials on co-deposit erosion rates, and the collateral effects of oxidation on other in-vessel components need to be investigated. From an engineering standpoint, the pumping and processing of large quantities of DTO in the torus exhaust would significantly increase the cost of the tritium processing plant.



4.7.3.2. *Oxidation experiments in TEXTOR*

In order to gain confidence in projecting laboratory results for T removal from tokamak co-deposits to ITER, the T-removal techniques need to be tested in current fusion devices. First experiments in a tokamak using oxygen with hot walls (620 K) to remove co-deposits have been performed in TEXTOR [768]. In the initial tests, the external pumps were closed and the vessel was filled with  $^{16}\text{O}_2$  or with  $^{18}\text{O}_2$  isotopes to pressures ranging from 0.005 to  $\approx 0.2$  Torr. At a filling pressure of  $<0.01$  Torr, most of the oxygen was adsorbed on the wall and the remaining 10-20% oxidised the deposits - and C impurities on other wall surfaces - to form CO and  $\text{CO}_2$  which were then released. At higher filling pressures ( $\approx 0.2$  Torr), the fraction of oxygen adsorbed decreased by 20-30%, whereas the fraction of CO formation was about constant and the formation of  $\text{CO}_2$  increased. This behaviour of the  $\text{CO}_2/\text{CO}$  ratio is in agreement with laboratory observations [468]. It has been found that the adsorption of oxygen  $^{18}\text{O}$  on the walls leads to the release of  $\text{C}^{16}\text{O}$  and  $\text{C}^{16}\text{O}_2$ ,  $\text{C}^{16}\text{O}^{18}\text{O}$  molecules by isotopic-exchange processes. A significant increase of water partial pressures has been observed by the differentially pumped quadrupole mass spectrometers, but the available experimental results are not sufficient to separate the contributions to the observed reaction products originating from the co-deposits and other internal vessel wall surfaces. A more sophisticated analysis to interpret the signals in terms of hydrogen release from the a-C:D co-deposits is in progress.

Encouragingly, TEXTOR did not experience any long-term adverse consequences after the use of oxygen to remove deuterium, and high performance plasma operation could be recovered after 15-30 minutes of GDC in helium and deuterium. The oxygen impurity content was initially 2-3 times higher than prior to oxidation, but was seen to decrease shot after shot, indicating a self cleaning process during plasma operation [768]. Further experiments are planned.

4.7.3.3. *Co-deposit removal via plasma discharges**- Glow discharge cleaning (GDC)*

One of the most widely used wall conditioning techniques in tokamaks is GDC (Sect. 4.6.2). It cannot be applied however to machines with superconducting magnets. In the absence of magnetic fields, laboratory experiments using He/O glow discharges have produced rapid, controlled co-deposit removal with minimal O-contamination. Erosion rates of about  $1 \mu\text{m}\cdot\text{h}^{-1}$  have been observed for co-deposit specimens removed from TFTR [769]. By comparison, He/O GDC performed inside the TFTR vessel resulted in much lower T removal rates [202, 749], possibly due to the re-deposition of the reaction products before being pumped out of the tokamak. Laboratory studies have determined this erosion to be a 2-step process: oxidation, followed by particle-induced desorption, with the maximum erosion rate limited by the latter. Temperatures in excess of 500 K are required for rapid thermal desorption of CO from carbon surfaces [769]. Helium ions of a few hundred eV have a high CO desorption yield, typically much higher than for electrons or photons. Rapid, efficient evacuation of the desorbed impurities from the system is also important. Dissociation - which

can lead to re-deposition - is primarily caused by energetic electrons; thus, electron densities and energies should be kept as low as possible (low electron densities imply low ion flux to surfaces). Conditioning studies with Taylor discharges and ECR support this conclusion. In both cases desorbed impurities were efficiently evacuated only after the discharge was terminated. Physical sputtering due to the high incident ion energies during GDC, may cause undesired deposition of high-Z impurities onto lower-Z components. As with other discharge methods (see below), tritium removal due to ion impact is limited to line-of-sight surfaces.

*- Ion cyclotron resonance discharge cleaning*

Tritium removal techniques capable of operating in the presence of magnetic fields are desirable due to the permanent toroidal magnetic field in ITER. Such techniques include ICR and ECR discharges. Co-deposit removal experience with ICR and ECR in tokamaks is rather limited. High hydrogen removal rates have been reported in ICR experiments in Tore Supra with He and D [653] and TEXTOR with He [41]. H removal in these discharges occurs via a combination of processes: chemical erosion due to H/D, physical sputtering, ion-induced desorption, and isotope-exchange. The first two processes lead to erosion of the co-deposit, while the latter two lead to removal and replacement of hydrogen within the range of ion/charge-exchange neutrals. In the Tore Supra experiment the C-removal rate was estimated to be  $\approx 4 \times 10^{22} \text{ C}\cdot\text{m}^{-2}\cdot\text{h}^{-1}$  [653]. This corresponds to  $\approx 1 \mu\text{m}\cdot\text{h}^{-1}$  for a TFTR-type co-deposit. Although this erosion rate is about an order of magnitude lower than the rate due to thermo-oxidation at 623 K, the fact that this is achieved without oxygen is promising. However, two key limitations remain: no access to shaded areas, and sputtering (due to energetic ions and charge-exchange neutrals) of components where no co-deposits exist.

It might be possible to mitigate and possibly overcome these limitations by establishing discharge conditions that suppress ion and charge-exchange neutrals-induced sputtering and at the same time create reactive neutral atoms that could access shaded areas. Laboratory experiments have been performed at the Sandia National Laboratories to assess the potential of ICR for tritium removal and to evaluate the erosion rate for TFTR-like co-deposits using He/O ICR plasmas [770]. Initial results show very efficient formation of atomic O, with little residual O<sub>2</sub> to permeate into and contaminate graphite pores; O<sub>2</sub> is readily dissociated in the mixed He-O discharge. C and H removal can occur via CO formation and via desorption of reacted surface CHO species due to energetic He neutrals. As in the case of thermo-oxidation via O<sub>2</sub>, atomic oxygen is expected to preferentially erode the co-deposits compared to 'bare graphite.'

*- Electron cyclotron resonance discharge cleaning*

ECR hydrogen discharges yield low-energy and high-density plasmas [571, 771]. Early experiments of ECR discharge conditioning in tokamaks date back to the 1980s. The cleaning effect of hydrogen ECR plasmas in JFT-2 [772] and JIPP T-II [773] was found to be similar to that obtained with Taylor discharge cleaning.

More recently, ECR discharges were used in JET to remove tritium from the torus after the DTE1 campaign. No significant tritium removal was detected after 2.5 hours of low-pressure deuterium ( $\approx 6 \times 10^{-4} \text{ Pa}$ ) discharges [203]. Controlled experiments in C-Mod using

deuterium ECR discharges removed a diamond-like carbon coating from a stainless steel specimen at a rate of  $\approx 3 \text{ nm}\cdot\text{h}^{-1}$  [160], however, this material is not representative of what is expected in ITER. The effectiveness of the ECR technique to remove tritium from tokamak co-deposits remains to be further assessed.

Co-deposit removal with ECR discharges has also been investigated in laboratory experiments [774, 775]. The erosion rate was found to depend critically on the film structure at the surface. Among the gases studied, oxygen shows always the highest erosion rates; the relative rates behave as  $\text{O}_2:\text{D}_2:\text{H}_2 \approx 10:2:1$  [344, 460, 774, 775]. The erosion rates increase with substrate temperature, ion energy, and ion flux. These correlations are true for soft and hard C:H films, although the absolute rates differ significantly. Erosion rates of  $1.7 \mu\text{m}\cdot\text{h}^{-1}$  and  $3.6 \mu\text{m}\cdot\text{h}^{-1}$  were measured at 300 K and 620 K, respectively, for hard a-C:H films in oxygen ECR plasmas with surfaces maintained at floating potential. The rates for soft C:H films are roughly a factor of two higher. For discharges in pure oxygen, no large oxygen inventories were found in ex-situ analyses of a-C:H samples after plasma treatment. The dominant erosion products, as measured by mass spectrometry, are  $\text{H}_2$ , CO,  $\text{CO}_2$ , and  $\text{H}_2\text{O}$ . Etching by neutral species (most probably atomic oxygen) was demonstrated to occur, but the underlying processes remain unclear [774]. A key question is how much CH is removed by ions and neutral species and whether the ECR discharge needs to be localised in a tokamak (e.g., in the divertor) by localising the RF power absorption close to the surface to be cleaned. The neutrals may be important to access shaded, non-line-of-sight areas. ECR plasmas should cause little or no physical sputtering because ion energies are below the threshold for sputtering.

In summary, the thermo-oxidation and plasma discharge techniques discussed above have the potential for tritium removal. While oxygen is necessary for thermo-oxidation, it appears that the discharge removal techniques will also require the presence of oxygen to achieve sufficient erosion and tritium release rates. The presence of neutral oxygen atoms is necessary to reach shaded areas, while the energy of ions needs to be minimised in order to prevent sputtering of other in-vessel components. Localising the discharges in the divertor region may be required. The introduction of oxygen into the torus requires further investigations on plasma recovery, the collateral effects of oxygen in the torus, and processing of DTO.

## 4.8. Dust and Flake Experience

### 4.8.1. Introduction

Particulates in tokamaks are produced by plasma erosion of plasma-facing materials, by plasma disruptions, or by assembly, machining, welding, and operations inside the tokamak. Dust generation in next-step fusion devices will increase with the increase in duty-cycle and this has important safety implications. Tokamak dust may be toxic, radioactive and/or chemically reactive. The hazard of dust depends on the dust composition, how much dust is produced, and how well the dust is confined [230] (Sect. 2.3.4). Research into dust production mechanisms and their biological interactions has just begun and the dust production mechanisms and rates are not adequately known at present [241, 242, 776] (Sect. 6.5). Little

is known about dust generation from mixed-materials.

Appropriate limits for occupational exposure to tritiated graphite dust need to be established. The micron size typical of tokamak dust will allow it to be trapped in lung alveoli. While the annual limit of intake (ALI) and derived air concentration (DAC) for  $T_2$  and  $T_2O$  are well known, there are little data at present on the biological lifetime of tritiated tokamak dust in the lungs. Expected limits are much lower than for  $T_2O$ , posing a challenge for real-time monitoring of airborne tritiated dust. Some data are available on the biokinetics and dosimetry of titanium tritide particles in the lung [117]. Recent studies from JET showed that the dosimetric properties of tritiated dust are quite different to those of HT/HTO [777]. More studies on tritiated graphite dust are needed to provide a technical basis for safety limits, both for occupational exposure and for the general population under accident scenarios.

Although the structural materials for the vacuum vessel, internal cooling systems, etc., are shielded from the confined plasma ions by cladding, such components may be affected by off-normal events such as arcing (Sect. 4.4) and disruptions (Sect. 4.5). In a survey of TEXTOR [241], 15% of the dust collected was ferromagnetic even though TEXTOR was an "all-carbon" machine (see glossary), in the sense that all ion interaction was with carbon-based PFCs. Much of the ferromagnetic material appeared as sections of almost perfect iron-rich spheres, suggesting surface melting with the ejection of droplets, which solidify before landing elsewhere in the tokamak.

#### 4.8.2. Dust found in tokamaks

Measurements of dust concentration, diameter, surface area, porosity, chemical composition and activity have been carried out during the maintenance periods of several tokamaks. The results are diverse and reflect PFC configuration, materials, alignment, plasma conditions and disruption history. Studies were made of dust removed from TFTR in 1987 [728]. Vacuum cleaning of the vessel yielded less than  $25 \text{ cm}^3$  of particulates. The typical size of particles collected on a filter was  $\approx 100 \mu\text{m}$ . Analysis of the volatile tritium component (HTO) showed a concentration of  $\approx 8 \times 10^{12} \text{ T-atoms}\cdot\text{g}^{-1}$ ; this results from DD reactions, so the D content of the particles is probably  $10^6 - 10^7$  greater (Sect. 4.7.2.1). A similar result was obtained from JT-60U in 1994, with a T activity of the dust of  $3 \times 10^{13} \text{ T-atoms}\cdot\text{g}^{-1}$ . Studies were also made in the period 1987 to 1992 of dust collected from JET. Smears taken from in-vessel surfaces showed that the graphite surfaces are friable as a result of damage by plasma interaction. When JET was vented following the PTE campaign in 1991, the ventilation air exiting the vessel was also filtered to measure the re-suspended fraction of the dust. An high efficiency particulate (HEPA) filter was used to collect the airborne particles from 97% of the airflow through the vessel over a twelve-hour period in which time  $600 \text{ m}^3$  of air was sampled (three times the vessel volume) [778]. The suspended particles had a total mass of 2.29 mg, and the median-mass aerodynamic diameter was about  $4 \mu\text{m}$ , with a geometric standard deviation of  $1.9 \mu\text{m}$ . The composition of the particle matrix was 80.3% C, 16.7% Fe, 1.3% Cr, 1.2% Ni, 0.02% Co and 0.03-0.7% Be (H isotopes and oxygen not included). Dust was also collected by swabbing surfaces inside JET with pads of tissue humidified with

ethanol [778]. The largest amount of dust was found on the lower (graphite) toroidal limiter, at almost  $4 \text{ g}\cdot\text{m}^{-2}$  of which 85% was C and 11% was Be. Elsewhere, Be was normally the main contribution to the composition, with C and the components of inconel making up the rest, the largest sample (of  $0.7 \text{ g}\cdot\text{m}^{-2}$ ) coming from the lower part of the inner wall.  $^7\text{Be}$  was found in all dust and aerosol samples, and in debris collected by vacuum cleaner from the vessel floor. Dust samples contained a  $^7\text{Be}$  mass activity of  $2 \times 10^5 \text{ Bq}\cdot\text{g}^{-1}$ , but the activity of the debris was  $509 \text{ Bq}\cdot\text{g}^{-1}$ , and in each case the other radionuclides detected came from activated inconel.

During the operational campaigns up to 1992, both JET and TFTR were operating as “all-carbon” machines. Both machines were developing high-power regimes, which resulted in high-power densities in the SOL. Both JET and TFTR experienced tile alignment problems which resulted in pulses terminating in “carbon blooms,” wherein erosion from tile edges increased the carbon concentration in the plasma beyond the stability limit [712, 779]. In JET, many millimetres were eroded from some tile edges by the plasma, and probably this was mostly responsible for the light dusting of carbon-based material observed over the interiors of both JET and TFTR at this time. The interior of JET was changed in 1992-94 to incorporate a divertor, and great care was taken with the design of the power-handling surfaces to avoid exposed tile edges. As a result, discharges could be run with high-power levels for longer periods without impurity problems, and the amount of dust observed in JET since 1994 had been greatly reduced. Similarly, attention was paid to the alignment and shaping of target tiles in TFTR [106], and the amount of dust collected in this machine also decreased. A specific experiment to demonstrate that dust can be formed as a result of plasma impact at tile edges has more recently been carried out on DIII-D [780] (Sect. 4.5.2.2). In this case, it was shown that the leading edges erode rapidly and form difficult-to-clean diamond-like films in shaded regions. In the area of intense re-deposition, the formation of  $5\text{-}10 \mu\text{m}$  “globules” was also observed.

More recent surveys on dust have been conducted on several tokamaks. The INEEL Fusion Safety Program has collected dust from major tokamaks (DIII-D, Alcator C-Mod, Tore Supra, ASDEX-Upgrade and TFTR) following typical run periods, and extensively analysed the collected dust to determine the composition, particle size distribution, and specific surface area [231, 234, 781–786]. The tokamak dust is generally sub-micron to micron in size. The data can be fitted to a log-normal distribution, similar to many industrial aerosols [787]. Fig. 76 contains the results of all the particle size data used to establish the conservative value used in the ITER safety analysis. The data points in the figure represent the count median diameters (CMDs) of the particulates (see glossary) that were measured, and the uncertainty bars in the figure represent the geometric standard deviation (GSD) of the size distributions. The horizontal lines indicate the size range for the  $0.5 \mu\text{m}$  CMD and a GSD of 2.0 used for the ITER safety case.

The mass concentration of dust varies throughout a tokamak, dependent upon the location. In DIII-D, it ranged from  $1\text{-}10 \text{ mg}\cdot\text{m}^{-2}$  on vertical surfaces and  $0.1\text{-}1 \text{ g}\cdot\text{m}^{-2}$  on the floor and lower horizontal surfaces. The ranges of mass concentration in the Alcator C-Mod tokamak collected during the March 1998 were an order of magnitude greater, while the

dust vacuumed from a 0.1 m x 0.1 m area of the TFTR vacuum vessel floor had a concentration of  $20 \text{ g}\cdot\text{m}^{-2}$  [788]. Additional samples were collected in the vessel entry with a hand vacuum cleaner fitted with a slotted nozzle and  $0.2 \mu\text{m}$  pore size filter [566]. Particles and debris were evident on the floor of the vessel, including flake fragments and debris from a laser-assisted lithium conditioning aerosol device 'DOLLOP' [163]. Bay J was particularly dusty and collection from a 10 cm x 10 cm area yielded 0.46 g. In contrast, the bottom of a neutral beam duct yielded only 0.06 g from a 20 cm x 60 cm area. The gap between the bumper limiter and poloidal limiter, at Bay K, yielded 0.07 g.

*Insert Fig. 76*

The specific surface area of tokamak dust is important from a chemical reactivity standpoint. High specific surface areas indicate large surface areas that could react with air or steam during an ingress event. The specific surface area of carbon dust samples retrieved from diagnostic viewing pipes and from the floor of TFTR has been measured by the BET (see glossary) method [788-790] and ranges from  $7 \text{ m}^2\cdot\text{g}^{-1}$  to  $27 \text{ m}^2\cdot\text{g}^{-1}$ . The specific surface areas of various tokamak dust samples are plotted versus the mean volume-surface diameter in Fig. 77. Also shown in the plot are the corresponding theoretical lines for pure fully dense graphite and molybdenum mono-disperse spheres and data on crushed POCO graphite.

*Insert Fig. 77*

The Alcator C-Mod 1998 sample is fairly close to the theoretical line, indicating that the metal is not based on small agglomerated particles or has limited porosity. (The Alcator C-Mod 1997 sample contained 80% by weight boron, which biased the measurement high relative to the theoretical line for Mo). The carbon-based tokamak dust samples show surface areas well in excess of the theoretical values, indicating either significant agglomeration or surface-connected porosity [791].

Dust composition is measured quantitatively using inductively coupled plasma mass spectroscopy and qualitatively using environmental scanning electron mass spectroscopy. The composition of the dust consists primarily of the first-wall material used in the machine, e.g., carbon in DIII-D and TFTR and molybdenum in Alcator C-Mod. Carbon dust samples were retrieved from diagnostic viewing pipes and from the floor of TFTR [788]. Millimetre-size flakes were observed in samples collected from the diagnostic pipes; while by mass, these large flakes are significant, by count they are not, since they are few in number, compared to the smaller particles (Sect. 4.8.3). The hydrogenic concentration was relatively low with atomic ratios in the range D/C of 0.006 and T/C in the range of 0.0003. The 20:1 D/T ratio is similar to the 30:1 D/T fuelling ratio during the DT campaign in TFTR. In general, dust will also contain material used for conditioning, instrumentation, insulation, and diagnostics in the tokamaks. Such materials include boron, stainless steel, aluminium and silicon oxides.

Detailed surveys of dust and other debris in JET were carried out during a break in the Mk-IIA divertor phase in October 1996. JET had operated with the Mk-IIA divertor for 6 months during which there had been 2000 discharges and about  $9 \times 10^{25}$  D atoms were injected. Swab samples were taken from the divertor and also the poloidal limiters and

analysed for T activity, gamma activity, particle size, specific surface area and composition [235]. High Be concentrations were measured at areas of the outer wall close to the Be evaporators; elsewhere, the Be was uniformly low at  $\approx 10 \text{ mg}\cdot\text{m}^{-2}$ . One sample contained 40% Ni by weight, but otherwise the swabs gave average concentrations of particulates of  $1.2 \text{ g m}^{-2}$ , comprising 97% C, 2% Be and 1% metals by weight (not including H isotopes or oxygen). The radioactivity of the samples comprised T (varying from  $8 \times 10^4$  to  $4.6 \times 10^6 \text{ Bq}\cdot\text{m}^{-2}$ ) (i.e.,  $4 \times 10^{13}$  to  $2.6 \times 10^{15}$  tritons  $\text{m}^{-2}$ ) and  ${}^7\text{Be}$  ( $\approx 1 \times 10^4 \text{ Bq}\cdot\text{m}^{-2}$ ). The median-diameter was  $27 \mu\text{m}$ , with a geometric standard deviation of 2  $\mu\text{m}$ . Specific surface area was measured for only the largest size fraction:  $4 \text{ m}^2\cdot\text{g}^{-1}$ .

In a recent survey of dust collected in TEXTOR [241], three categories of large particles were collected, apart from the ferro-magnetic material referred to above. These were pieces of a Si-based composition, probably originating from the siliconisation [792] of the machine, pieces of graphite, and flakes of co-deposited films (see below). Small particles were also collected, many of which were sub-micron in size, which themselves were agglomerates of particles of about 100-300 nm in diameter. The size and structure of these small particles suggests growth in the edge of the plasma or during wall conditioning processes, similar to the nanoparticles formed in process plasmas [793, 794]. Under the conditions of a detached plasma with electron densities of the order of  $10^{18} \text{ m}^{-3}$ , temperatures  $< 5 \text{ eV}$  and hydrogen flux densities of  $\approx 2 \times 10^{22} \text{ m}^{-2}\cdot\text{s}^{-1}$ , the local hydrocarbon concentration near the target surface is  $\approx 10^{18} \text{ m}^{-3}$ . These conditions are close to those of the process plasma where dust formation has been observed by multiple ion-molecule reactions and agglomeration processes.

In addition to collection from operational tokamaks, an experimental system has been developed to study disruption-induced particulate formation using the SIRENS high-heat-flux facility at North Carolina State University [795–797]. Results from the SIRENS experiment are used to understand the basic particle generation and formation mechanisms in tokamaks having high disruption energies as expected in future fusion power plants (Sect. 4.5). Results of size measurements on particles produced in SIRENS are not significantly different than the dust found in tokamaks. A variety of materials have been tested in SIRENS, including stainless steel, copper, tungsten, carbon, aluminium, and mixtures thereof; photographs of stainless steel and graphite are shown in Fig. 78.

*Insert Fig. 78*

#### 4.8.3. Flakes in tokamaks

Thick layers of eroded first-wall material are deposited at points in the SOL, such as at the sides of the limiters, in machines where the limiters are the primary plasma boundary. In many tokamaks, such as JET (pre-1992), TFTR and TEXTOR, these layers may reach  $\approx 100 \mu\text{m}$  in some areas. The typical appearance of films flaking from the sides of limiters in TEXTOR [798] is shown in Fig. 79.

The thick films on the discrete limiters used until 1986 in JET had a fine layer structure, were highly stressed, and did break up on occasions, particularly following venting to air. The analysis of the outermost one or two  $\mu\text{m}$  showed D concentrations of  $\approx 0.1 \text{ D/C}$ , but

thick film analysis techniques showed average D concentrations for the film as a whole to be almost two orders of magnitude lower [799]. The surface temperature of the central region of the JET limiters regularly reached over 1300 K, and temperatures at the flanks where these thick deposits were located must also have reached temperatures at which co-deposited films start to degas ( $\geq 700$  K).

*Insert Fig. 79*

Recent analysis of poloidal limiters and RF antenna protection tiles from TEXTOR show similar results [489, 800]. As in the case of the JET limiters, these PFCs are normally at 540-570 K, and can reach much higher temperatures during plasma pulses. Films of up to 170  $\mu\text{m}$  thickness were observed, which were loosely bound and tended to peel-off as flakes. Flakes of up to 10 mm in diameter were observed, but they were brittle and very easily disintegrated to form much smaller agglomerates of dust particles [489]; scanning electron spectroscopy (SEM) imaging showed that the outer regions of the films consisted of fine granules of up to 5  $\mu\text{m}$  diameter [800]. An SEM section of such a film is shown in Fig. 80. Films of only  $\approx 10$   $\mu\text{m}$  thickness are seen to blister and peel in other parts of TEXTOR. During the period the tiles were in use in TEXTOR, the mean growth rate for the thicker films corresponded to 4.5  $\text{nm}\cdot\text{s}^{-1}$  [800]. Thermal desorption spectroscopy of the flakes showed the *average* D:C ratio to be  $4 \times 10^{-4}$ , again similar to the films on the JET limiters (see above).

*Insert Fig. 80*

Thick films (tens of  $\mu\text{m}$ ) are also deposited on the inner bumper limiter of TFTR (see Fig. 81.) Following the conclusion of the DT phase in April 1997, TFTR has been held in air at slightly below atmospheric pressure. No spalling of these layers was observed until 18 months after the machine was vented to air; by two years after the venting, approximately 15% of the inner wall showed some flaking [565, 752] (Sect. 4.7.2.1). TFTR was operated with the wall at room temperature, and although tiles on which the films are seen were heated during discharges, stresses (and D concentrations) may be different from those at the discrete JET and TEXTOR limiters. Values of D:C at the surface are typically 0.1 -0.2 [488]. A 0.24 g sample of the TFTR flakes has been heated in air to 773 K for 1 hour which released 0.72 Ci ( $1.5 \times 10^{19}$  atoms T). This amount confirms that the flakes are detached co-deposited layers that contain most of the retained tritium. Rutherford backscattering analysis of a TFTR flake showed a D/C ratio of 0.13 on the plasma-facing surface, 6 times lower than the D/C of 0.7 found in JET co-deposits.

*Insert Fig. 81*

When tiles were removed from the JET Mk-IIA divertor in October 1996, a much greater potential dust problem for large tokamaks was discovered. Flaking deposits were found on water-cooled louvres beyond the inner corner of the divertor (Sect. 4.7.2.2.3). These deposits were 40  $\mu\text{m}$  thick, and because they are not exposed to the plasma (and are on cooled surfaces) their D:C ratio is approximately 0.7 [756]. The films exhibit a layer structure



(Fig. 82) similar to the films seen on the JET and TEXTOR limiters. The T activity of these flakes (from DD operations only) was  $9 \text{ M Bq}\cdot\text{g}^{-1}$  ( $5 \times 10^{15} \text{ tritons}\cdot\text{g}^{-1}$ ), so that activity from full DT operation is predicted to be  $\approx 2 \times 10^{13} \text{ Bq}\cdot\text{g}^{-1}$  ( $\approx 10^{22} \text{ tritons}\cdot\text{g}^{-1}$ ). The flakes comprised 99% C, 0.6% Be and 0.5% metals (disregarding the H isotopes and traces of oxygen). The total amount of D trapped in the films on the louvres corresponded to 4% of the total D fuelling. Since the flakes had been exposed to air prior to analysis, there may have been considerably more D present in the flakes during operation; following the JET DT campaign in 1997, one-third (2g) of the retained T was released to the air during the shutdown (Sect. 4.7.2.2.3). Much of the T retained in the JET vessel at the end of DTE1 was believed to be present in the flakes that formed at the louvres. Over 150g of flakes were recovered from the vicinity of the inner louvres containing 0.52 g of T [757], and it is known (from inspection with a camera linked to a fibre optic probe) that many more flakes have fallen from the louvres onto the floor of the vessel beneath the divertor structure, which was inaccessible.

*Insert Fig. 82*

Films of up to  $2 \mu\text{m}$  thickness have been found in the ASDEX-Upgrade divertor region, on the vacuum vessel near divertor slits, and on the structure of the roof baffle [523] (see Fig. 83). From the position of the films and shading by structures, it is clear that the deposition is of charged particles following field lines. Much more symmetric deposition between inner and outer divertor structures is found than in JET. The films, which have a tendency to detach to form flakes, are carbon-based with  $\approx 40 \text{ at}\%$  D,  $10 \text{ at}\%$  O and  $5 \text{ at}\%$  B (from boronising the main chamber); an estimated 5 g resulted from 3000 s of plasma discharges. The implications of these results for next-step devices are discussed in Sect. 6.5.

*Insert Fig. 83*

Table 10. Summary of tokamak PMI diagnostics (Symbols: t: time resolution or cw (continuous operation). Scale: \* signifies spatial resolution, otherwise depth resolution).

Diagnostic	Technique	t (s)	Scale (m)	Advantages	Limitations
<b>Instantaneous measurements</b>					
<i>Sputtering rate and/or yield</i>	Emission spectroscopy of atoms/molecules released into plasma [a,b,c];	> 10 <sup>3</sup>	*>10 <sup>2</sup>	Optical access; Element discrimination;	Depends on plasma parameters/uniformity & atomic rates;
	Sniffer probe molecular spectroscopy [d,e,f];	cw	*10 <sup>3</sup>	Element discrimination;	Access for probe;
	Laser-induced fluorescence of sputtered atoms [g,h,i,j];	0.1-1	*10 <sup>3</sup>	Spatial resolution; Known excitation rates;	Laser access; Choice of transitions;
<i>Power loading</i>	Infrared thermography [k,l];	> 10 <sup>4</sup>	*10 <sup>2</sup>	Optical access; Toroidal/poloidal resolution;	Depends on material emissivity and heat conduction;
	Thermocouples [m,n];	> 10 <sup>2</sup>	---	Material independent;	Spatial resolution; Time response;
<i>Arcing</i>	Arc photography [o,p,q];	> 10 <sup>4</sup>	*>10 <sup>3</sup>	Arc movement;	No arc quantification;
	Electrical probes [r,s];	10 <sup>6</sup>	*~10 <sup>2</sup>	Measures arc current; Time resolution;	Probe access;
<i>Fuel wall loading</i>	Mass spectroscopy and particle balance [t];	>1	---	Ease of implementation;	No spatial resolution; Sensitive to first few monolayers;
	Penning gauge spectroscopy [u];	0.2	---	Time resolution;	
<b>Net measurements</b>					
<i>Net erosion/deposition rate</i>	Retracting sample probes [u,v,w];	>10	>10 <sup>9</sup>	Controlled short duration exposure to plasma;	Probe access; Needs nm resolution for depth marking;
	PFC height change and sticking probes [x,v,y];	> 10 <sup>5</sup>	>10 <sup>6</sup>	Direct measurement;	Access limited to vacuum breaks; No exposure control;
	Material coupons [z,aa];	> 10 <sup>5</sup>	>10 <sup>9</sup>	Material selection;	Access limited to vacuum breaks; No exposure control;
	Speckle interferometry [ab,ac,ad];	cw	>10 <sup>6</sup>	Remote access;	Laser and optical access; Never implemented;
	Ellipsometry [ae,af];	cw	>10 <sup>9</sup>	Remote access; Very sensitive;	Laser access; Sensitive to material's optical properties and vibrations;
	Colorimetry [ag,ah,ai,aj];	cw	10 <sup>4</sup> - 10 <sup>6</sup>	Remote access; Sensitivity;	Depends on material's optical properties; Limited to ~1 μm;
	Quartz crystal deposition monitor [ak,al];	cw	10 <sup>2</sup> - 10 <sup>7</sup>	Sensitive to small changes in thickness; Remote access;	No species discrimination; Temperature sensitive; Limited range;
Spectroscopy markers [am];	cw	~10 <sup>6</sup>	Remote access;	Erosion only; Depends on sputtering yield of marker vs E;	
<i>Fuel (DT) wall inventory</i>	Thermal desorption spectroscopy [an];	> 10 <sup>5</sup>	-	Complete inventory measured;	Need > 1270 K baking for in-situ measurement; Poor depth resolution;
	Laser desorption spectroscopy [ao,ap];	> 10	<10 <sup>4</sup>	Controlled release of DT;	Limited to near surface; Laser access;
	Gas balance [aq,ar];	> 10	-	"On-line" monitoring;	Difference of two large numbers;
<i>PFC activation and/or neutron damage</i>	In-situ sample exposure and activation measurement [as];	> 10 <sup>3</sup>	-	Integrated measurement;	Limited neutron fluence; No time resolution;
<i>Arcing</i>	Profilometry [at].	> 10 <sup>5</sup>	~10 <sup>4</sup>	Shows net effects;	Needs vacuum break;

references in the table:

a [475], b [476], c [496], d [480], e [497], f [498], g [499], h [500], i [501], j [502], k [503], l [504], m [505], n [506], o [353], p [507], q [508], r [509], s [509] t [511], u [109], v [492], w [493], x [486], y [474], z [112], aa [513], ab [514], ac [515], ad [516], ae [517], af [518], ag [110], ah [519], ai [520], aj [521], ak [522], al [523], am [524], an [525], ao [526], ap [527], aq [204], ar [528], as [529], at [355].

Table 11: The mean energy and flux of charge-exchange neutrals at the outer midplane of TFTR during ohmically heated (OH) and neutral beam heated portions of the discharge, with the wall saturated with deuterium and unsaturated by “supershot” conditioning [483].

	Mean Energy (keV)		Flux ( $10^{20} \cdot \text{m}^{-2} \cdot \text{s}^{-1}$ )	
	OH	NB	OH	NB
Deuterium saturated	0.4	1.5	0.7	1.4
Supershot conditioned	0.3	2	0.06	0.3

Table 12. Some examples of disruption simulators that were primarily used in the experiments.

Facility	Energy density	Pulse length	Power density	Parameter	Part. Energy	Plasma density	B field	Plasma stream size	Can provide useful data on the following
	MJ·m <sup>-2</sup>	ms	GW·m <sup>-2</sup>	MJ·m <sup>-2</sup> ·s <sup>-1/2</sup>	keV	m <sup>-3</sup>	T	m	
Next-step device	10-150	1-10	10-150	≥1000 ~ 50-200 (ELMs)	20 ions + electrons	1x10 <sup>20</sup>	5	0.2	
MK-200UG <sup>(1)</sup> Pulsed plasma gun with long drift tube	15	0.04-0.05	300-400	~ 70	1.5 (ion) <sup>(4)</sup> 0.15 <sup>(3)</sup>	2x10 <sup>21(2)</sup>	2	0.065 diam.	(a), (b), (c), (d), (e)
MK-200CUSP <sup>(1)</sup> Long CUSP trap	2	0.015-0.020	150-200	~ 15	0.8 (ion) 0.15 <sup>(3)</sup>	1.5-2x10 <sup>22</sup>	2-3	0.005	(a), (b), (c)
MKT-U <sup>(1)</sup> Pulsed plasma gun with 3m drift tube	1-2	0.03	30-60	> 6	1.2(ion) <sup>(1)</sup>	6x10 <sup>20</sup>	2	~0.07 diam	(d), (e)
QSPA <sup>(1)</sup> Upgraded quasi-stationary plasma accelerator	5-10	0.25-0.6	10-50	6-20	0.1	<1x10 <sup>22</sup>	0-1	0.05 diam.	(d), (e)
QSPA-Kh-50 <sup>(1)(2)</sup> Quasi-stationary plasma accelerator	10-40	0.2	37-80	22-90	0.3 (ion)	(2-8)x10 <sup>21</sup>	0-2	~0.04 diam	(d), (e)
PLADIS <sup>(1)</sup> Plasma gun	0.5-20	0.08-0.5	-	~ 15	0.1 (ion)	n/a	-	0.02 diam.	(d), (e)
VIKA <sup>(1)</sup> Quasi-stationary plasma accelerator	2-30	0.09-0.36	20-84	<20	0.2	>1x10 <sup>22</sup>	0-3	0.06 diam.	(c), (d), (e)
ELDIS <sup>(1)</sup> Electron beam	<50	0.05-0.06	2	>100	120 <sup>(4)</sup>	(2-4)x10 <sup>22</sup>	0-4	-	(e)
JEBIS <sup>(1)</sup> Electron beam	2.5	1.5-2	2	~ 2	70 <sup>(4)</sup>	n/a	0	>0.005 diam.	(e)
JUDITH <sup>(1)</sup> Electron beam	5-10	1-5	2-6	2-10	120 <sup>(4)</sup>	-	0	~0.004 diam	(e)
GOL-3 <sup>(1)(2)</sup> Long mirror trap	8-10	0.01-0.02	1000-1300	>50	1-3 <sup>(5)</sup> (thermal) 20-10 <sup>2</sup> (fast)	10 <sup>21</sup>	2-5	0.06 diam.	(b), (d), (e)

<sup>(1)</sup> TRINITI, Troisk, Moscow, Russian Federation;<sup>(2)</sup> Efremov Institute, St. Petersburg, Russian Federation;<sup>(3)</sup> Institute of Plasma Physics, NSC KIPT, Kharkov, Ukraine;<sup>(4)</sup> University of New-Mexico, Albuquerque, USA;<sup>(5)</sup> Japan Atomic Energy Research Institute, Naka, Japan;<sup>(6)</sup> Forschungszentrum, Juelich, Germany;<sup>(7)</sup> Budker Institute, Novosibirsk, Russian Federation;

(1) it decreases to 300eV at the end of the pulse;

(2) it increases up to 5x10<sup>21</sup> at the end of the pulse;

(3) electron temperature;

(4) electrons;

(5) non-maxwellian distribution function with great contribution of 800keV electrons.

(a) vapour dynamics in strong magnetic field at inclined target;

(b) production of secondary radiation and its interaction with nearby surfaces;

(c) Net radiation power to target surface;

(d) Erosion measurement (vaporisation and ablation);

(e) Ablation data (energy of destruction, size and velocity distribution of droplets and macroscopic pieces of graphite.)

n/a. not available.

Review: Plasma-material interactions

Table 13: Deuterium retention and fuelling in TFTR.

Year	D Retained				D Fuelling total (g)	%Retained
	total (g)	% BL Face	% BL gap	% Wall		
1987	5.3	50	11	39	24	22
1988	5.7	40	33	27	9	63
1989	7.3	57	13	30	18	41
1990	11	55	12	33	22	50
1991	4.3	18	8	74	10	43
Total	33.6	47	15	38	83	40

Table 14: Summary of tritium removal techniques used in TFTR and JET.

Machine operation:	Comments	
	TFTR	JET
D tokamak pulses	Ineffective	Tokamak pulses in deuterium reduced the in-vessel inventory at end of DTE1 by a factor of 2; T removal by pulsing $\approx 10 \text{ mg}\cdot\text{day}^{-1}$ .
He-GDC	Ineffective	Ineffective
D-GDC	Initial removal rate high ( $>18 \text{ mg}\cdot\text{h}^{-1}$ ), falling to $1 \text{ mg}\cdot\text{h}^{-1}$ , from exposed areas. Average removal rate: 1 to $30 \text{ mg}\cdot\text{h}^{-1}$ .	Ineffective. Rarely used in DTE1 because of large gas processing load on AGHS. Amount of T released negligible ( $\approx 40 \text{ mg}$ .)
D2 gas soaks	Ineffective	Ineffective.
Out-gas	Ineffective	Ineffective
ICRF	not applied	Pulses with RF heating (ICRF) used in June 1997 prior to repairs of beam box. Removed more tritium than ohmic pulses; 'sweeping' strike-point also increased T release. Wall inventory reduced from 4.4 to $\approx 2.9\text{g}$ in $\approx 120$ pulses.
ECRH plasma discharges	not applied	Gas load on AGHS much smaller but negligible T removal, and no reduction in T fraction.
He/O-GDC	Rate: $\approx 5 \text{ mg/h}$ - constant with time.	not applied
N <sub>2</sub> vents	not applied	Ineffective
Disruptions	Can release T by flash heating of surface. 0.014 g recovered after one major disruption; other times no release seen.	not quantified

Review: Plasma-material interactions

Pulse Discharge Cleaning (PDC)	Heats limiter to $\approx 520$ K. 100 mg T removed over 23 hours. Average removal rate: 4 mg/h.	not applied
Boronization	Little tritium released; most near-surface tritium previously removed.	not applied
Baking divertor surfaces normally cooled	not applied	Prior to venting, divertor support structure (normally $\approx 310$ K) heated to $\approx 410$ K. Small amount (6 mg T) desorbed at high T/D ( $\approx 1.8\%$ )
Vessel venting	Air at 718 torr released 220 mg of T in $< 1$ h; $\approx 24$ h to process the air.	2g T released in four months air ventilation of torus for post-DTE1 shutdown
Remote tile exchange	not applied	Divertor tiles, carriers and flakes physically removed (containing $\approx 0.6$ g T)

Table 15. Comparison of retention in TFTR and JET.

	TFTR	JET
Edge $N_e$ ( $m^{-3}$ )	$10^{18}$ - $10^{19}$	$10^{20}$
Edge $T_e$ (eV)	200-600	<30
Total T injected, NBI	3.1 g	0.6 g
gas puff	2.1 g	34.4 g
Initial retention during T gas puff fuelling (mostly isotope exchange)	$\approx 90\%$	$\approx 80\%$
T retained during DT ops. (exc. cleanup)	2.6 g (51%)	11.5 g (40%)
Longer term retention (mostly co-deposition)	51%	17%
T remaining in torus	0.6 g May '00	2.1 g Dec '99
Long term retention	12%	6%



## Review: Plasma-material interactions

Table 16. Thermo-oxidative and plasma discharge techniques for a-C:T co-deposit removal<sup>†</sup>.

Technique	Merits	Shortcomings	Required R&D
Air/O <sub>2</sub> exposure with hot walls	<ul style="list-style-type: none"> <li>- Good removal efficiency and short cleaning time is expected at wall temperature &gt; 520 K;</li> <li>- accessibility of non-line-of-sight and shaded regions, gaps, etc.</li> </ul>	<ul style="list-style-type: none"> <li>- Needs partial venting;</li> <li>- ratcheting effects could limit cleaning at 510K (max temperature in ITER);</li> <li>- limited tokamak practice (air in TFTR; new results with O<sub>2</sub> from TEXTOR).</li> </ul>	Further R&D is needed (e.g., effects from mixing of materials).
ECR + oxygen	<ul style="list-style-type: none"> <li>- Does not require vent or opening of the vacuum vessel;</li> <li>- some tokamak conditioning experience exists (e.g., JFT-2);</li> <li>- can be applied in the presence of strong magnetic fields.</li> </ul>	<ul style="list-style-type: none"> <li>- erosion is line-of-sight (shaded areas are eroded by neutrals but at much lower rates);</li> <li>- expected low erosion rates;</li> <li>- very limited tokamak practice (Alcator C-Mod; ECR was ineffective in JET).</li> </ul>	Significant R&D is needed.
ICR + oxygen	<ul style="list-style-type: none"> <li>- Does not require vent or opening of the vacuum vessel;</li> <li>- some limited R&amp;D for ITER is in progress in the US;</li> <li>- some tokamak conditioning experience (TEXTOR, Tore Supra);</li> <li>- can be applied in the presence of strong magnetic fields.</li> </ul>	<ul style="list-style-type: none"> <li>- Erosion is line-of-sight;</li> <li>- mechanisms are not well understood.</li> </ul>	Significant R&D is needed.
GDC + oxygen	<ul style="list-style-type: none"> <li>- Well established tokamak practice;</li> <li>- does not require vent or opening of the vacuum vessel.</li> </ul>	<ul style="list-style-type: none"> <li>- TF needs to be off; long shut-down;</li> <li>- low film removal efficiency for ITER;</li> <li>- limited access to shaded areas.</li> </ul>	

<sup>†</sup> All of these techniques require the introduction of oxygen into the torus, and thus will require conditioning to remove the residual oxygen and water to recover plasma operation. Further work with all of these techniques is also required to determine the effects of collateral damage.

Table 17. C-erosion and D-removal rates for tokamak co-deposits during oxygen exposure.

Temp [K]	TFTR/N3-15 [a,b] ~ 5 $\mu\text{m}$ thick ( $\rho \sim 1900 \text{ kg}\cdot\text{m}^{-3}$ ; D/C~0.35) 16 Torr $\text{O}_2$			TFTR/N3-24 [b] ~ 0.15 $\mu\text{m}$ thick 16 Torr $\text{O}_2$	
	Erosion [ $\mu\text{m}\cdot\text{h}^{-1}$ ] <sup>(e)</sup>	[C·m <sup>-2</sup> ·h <sup>-1</sup> ] <sup>(d)</sup>	D-removal [D·m <sup>-2</sup> ·h <sup>-1</sup> ]	Erosion [ $\mu\text{m}\cdot\text{h}^{-1}$ ] <sup>(e)</sup>	D-removal [D·m <sup>-2</sup> ·h <sup>-1</sup> ]
523	0.8	$5.7 \times 10^{22}$	$2 \times 10^{22}$	0.07	$0.2 \times 10^{22}$
573	3.5	$29 \times 10^{22}$	$10 \times 10^{22}$		
623	> 10	$> 70 \times 10^{22}$	$> 25 \times 10^{22}$	> 0.5	$1.5 \times 10^{22}$
Temp [K]	DIII-D#B [b] ~ 2 $\mu\text{m}$ thick ( $\rho \sim 1300 \text{ kg}\cdot\text{m}^{-3}$ ; D/C~0.185) 16 Torr $\text{O}_2$			JET divertor 6A [b] ~ 2 $\mu\text{m}$ thick 16 Torr $\text{O}_2$	
	Erosion [ $\mu\text{m}\cdot\text{h}^{-1}$ ] <sup>(e)</sup>	[C·m <sup>-2</sup> ·h <sup>-1</sup> ] <sup>(d)</sup>	D-removal [D·m <sup>-2</sup> ·h <sup>-1</sup> ]	Erosion [ $\mu\text{m}\cdot\text{h}^{-1}$ ] <sup>(e)</sup>	D-removal [D·m <sup>-2</sup> ·h <sup>-1</sup> ]
523	0.23	$1.5 \times 10^{22}$	$0.27 \times 10^{22}$	0.5	$1 \times 10^{22}$
573					
623	3.5	$22 \times 10^{22}$	$4.1 \times 10^{22}$	3.3	$7 \times 10^{22}$

<sup>(e)</sup> Erosion rate is estimated from measured D content and SEM photos of film thickness, assuming constant D/C.

<sup>(d)</sup> C-erosion rate is estimated from measured D content and D/C ratio based on mass-loss measurement.

<sup>(e)</sup> Erosion rate is estimated from measured D content and an assumed D/C ratio and density based on the TFTR/N3-15 value.

n/a not available.

references in the table: a [208], b [209].

Table 18. C-erosion and D-removal rates for tokamak co-deposits during air and H<sub>2</sub>O exposure.

Temp [K]	ASDEX-Upgrade [a] ~ 0.75 μm thick (ρ~1900 kg·m <sup>-3</sup> ; D/C~0.43) 760 Torr air			TFTR tile edge [b,c] ~ 50 μm thick 760 Torr air	
	Erosion [μm·h <sup>-1</sup> ]		D-removal [D·m <sup>-2</sup> ·h <sup>-1</sup> ] <sup>(e)</sup>	Erosion [μm·h <sup>-1</sup> ] <sup>(b)</sup>	D-removal [D·m <sup>-2</sup> ·h <sup>-1</sup> ]
523					
623				>50	n/a
650	n/a	3.7x10 <sup>22</sup>	1.3x10 <sup>22</sup>		
Temp [K]	TFTR/N3-24 [d] ~ 0.15 μm thick 76 Torr air (P <sub>O<sub>2</sub></sub> = 16 Torr, P <sub>H<sub>2</sub>O</sub> = 2 Torr)			TFTR/N3-24 [d] ~ 0.15 μm thick 16 Torr H <sub>2</sub> O vapour	
	Erosion [μm·h <sup>-1</sup> ] <sup>(a)</sup>		D-removal [D·m <sup>-2</sup> ·h <sup>-1</sup> ]	Erosion [μm·h <sup>-1</sup> ] <sup>(b)</sup>	D-removal [D·m <sup>-2</sup> ·h <sup>-1</sup> ]
523	0.035		0.1x10 <sup>22</sup>	n/a	0.05x10 <sup>22</sup>
623				n/a	
650					0.15x10 <sup>22</sup>

<sup>(a)</sup> Thickness recession and C-erosion rates are estimated from measured NRA depth profiles of C and D.

<sup>(b)</sup> Erosion rate is estimated from measured D content and SEM photos of film thickness, assuming constant D/C.

<sup>(c)</sup> Erosion rate is estimated from measured D content and an assumed D/C ratio and density based on the TFTR/N3-15 value in Table 4.8.

<sup>(d)</sup> It is postulated that H<sub>2</sub>O exposure leads to isotopic exchange of H and D, without significant carbon removal.

n/a not available.

references in the table:

a [468], b[206], c [205], d [209].

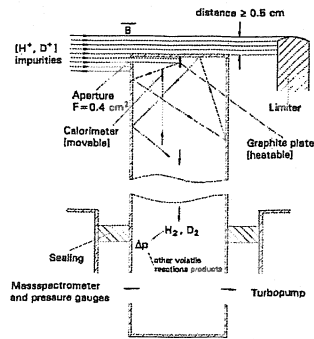

(a)

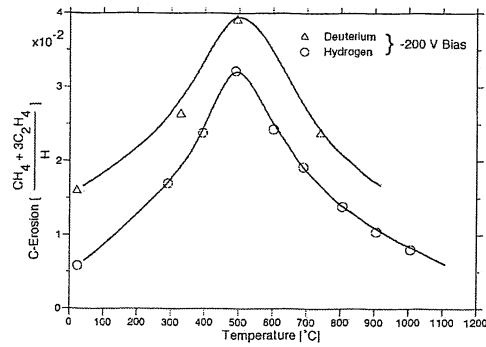

(b)

**Figure 38.** (a) Schematic of sniffer probe used on TEXTOR. (b) Measured chemical erosion yield in TEXTOR for deuterium and hydrogen vs. sample temperature; (reproduced with permission from [480].)

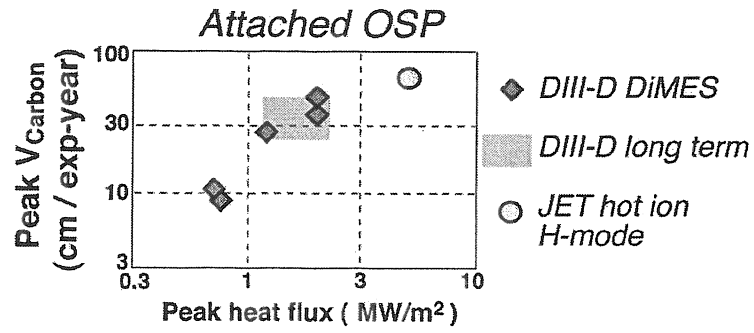

Figure 39. Net carbon erosion rate at the divertor strike-point vs. strike-point heat flux on JET and DIII-D. JET data [110] and DiMES at  $1.5 \text{ MW}\cdot\text{m}^{-2}$  [521] were obtained with colorimetry. All other DiMES data come from depth-marked insertable probes [480, 530]. The DIII-D long-term results are from net changes in divertor tile height after 9 months of operation [491]. (OSP in the figure means outer-strike-point.); (reproduced with permission from [530].)

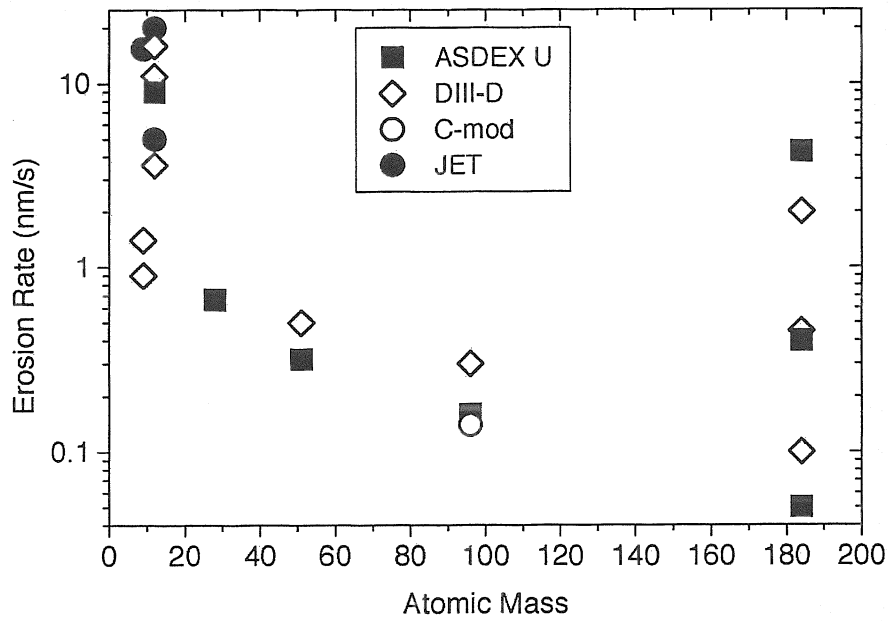

Figure 40. Erosion rate of different divertor materials as a function of atomic mass. While most of the data were obtained from marker erosion experiments, Be, C and W have been used as bulk materials in widely differing divertor conditions [109, 112, 493, 494, 533-535].

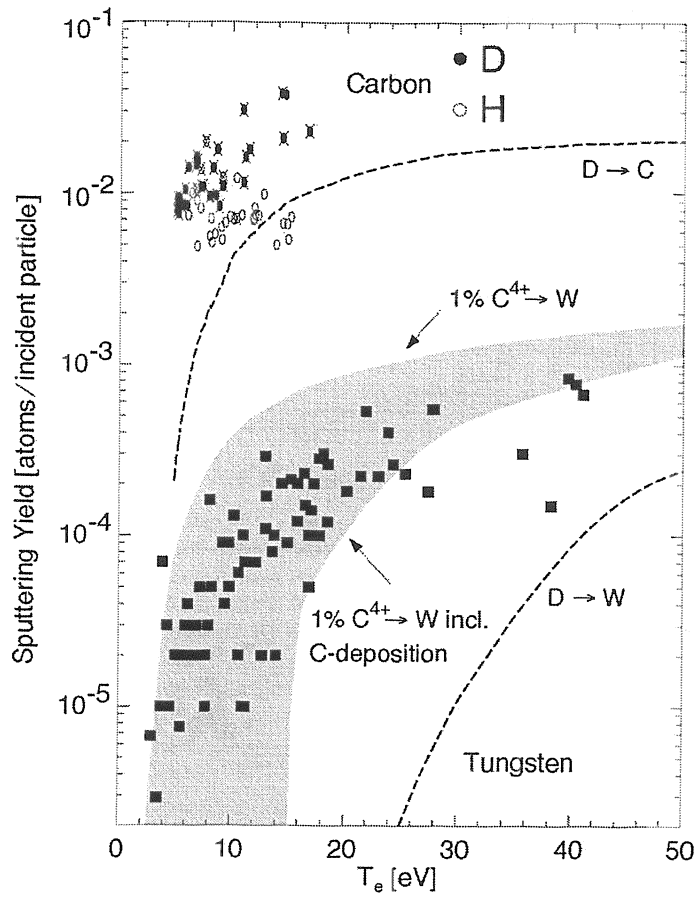

Figure 41. Sputtering yield of C and W as divertor materials in ASDEX-Upgrade, as a function of the divertor electron temperature as measured spectroscopically. The data are compared with computer calculations (shown as dashed lines) for physical sputtering. For the case of W, sputtering due to 1%  $C^{4+}$  impurity ions is included. The grey region indicates variations of the sputtering yield due to different degrees of surface coating by carbon deposition [114, 477]; (figure provided by K. Krieger - IPP Garching.)

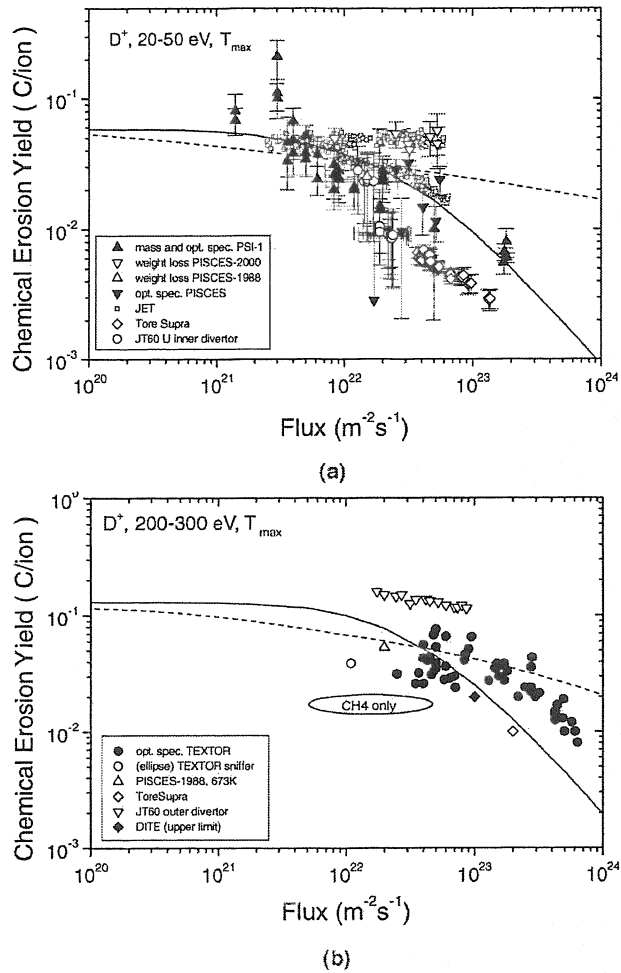

Figure 42. Comparison of the flux dependence of the chemical erosion yield of carbon at  $T_{max}$  measured in plasma simulators and in tokamaks for (a) incident ion energy between 20-50 eV [295, 296, 299, 304, 541, 542] and (b) between 200-300 eV [297, 305, 480, 539, 540, 543]. The curves are analytic fits to the data using the analytic model [285] (see also Fig. 16).



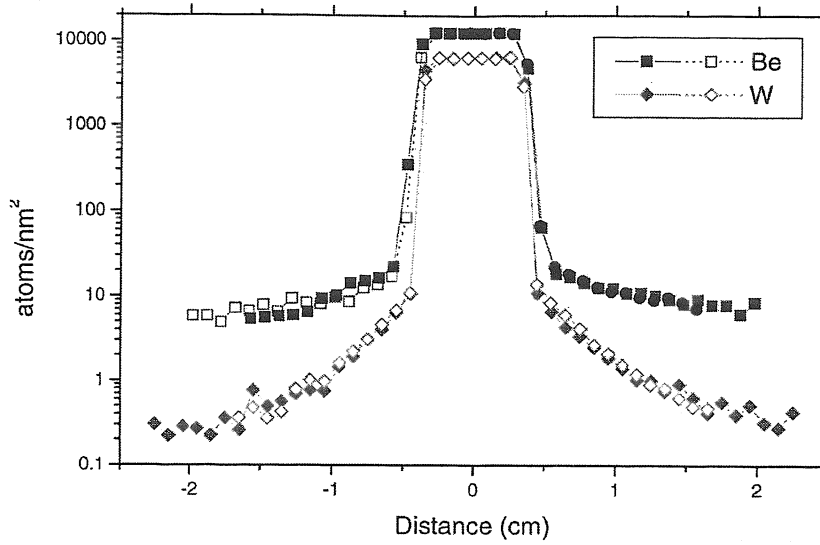

Figure 43. Deposition pattern of local re-deposition of eroded material from Be and W markers in the DIII-D divertor [494]. Two sets of data are shown for each material at slightly different positions on the same divertor probe. The magnetic field direction is from left to right. (Plasma parameters:  $n_e = 4 \cdot 10^{19} \text{ m}^{-3}$ ,  $T_e = 70 \text{ eV}$ ,  $\text{power} = 7 \cdot 10^5 \text{ W} \cdot \text{m}^{-2}$ , ion fluence  $8 \cdot 10^{22} \text{ m}^{-2}$ ).

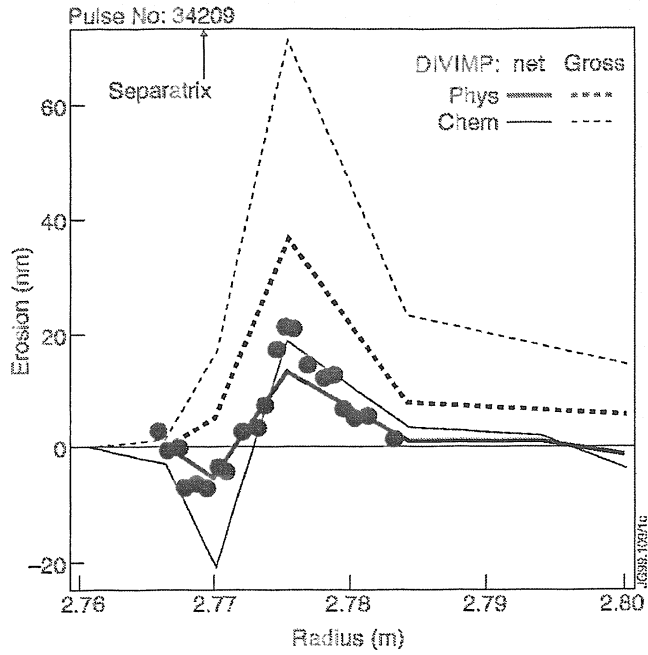
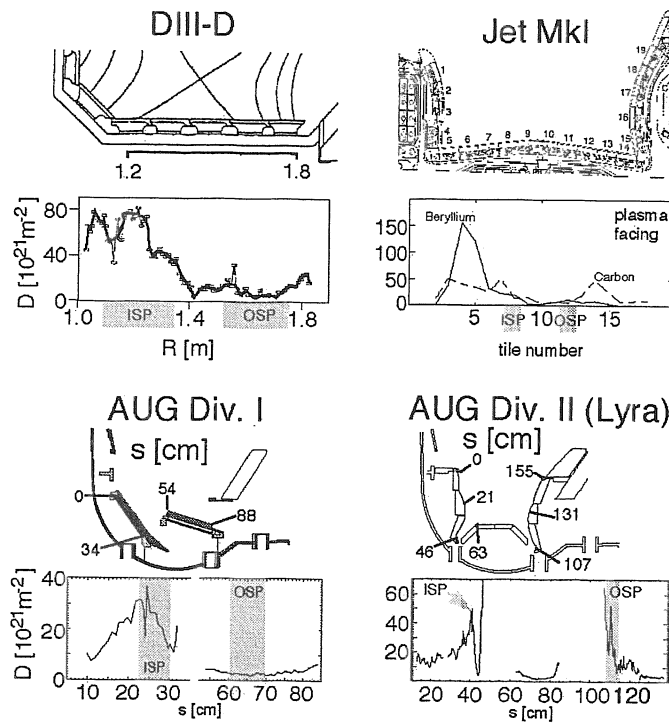

Figure 44. Radial distribution of erosion of a deposited carbon layer and re-deposition onto the JET divertor plate as measured from colorimetry measurements (solid points) and DIVIMP calculations of net and gross erosion (solid and dashed lines respectively); (reproduced with permission from [110].)



**Figure 45.** Re-deposition pattern of carbon onto the divertor plates of DIII-D, JET Mk-I, ASDEX-Uprade Div. I and Div. II LYRA, as documented by the D co-deposition pattern [63]. The inserts show the different divertor geometries.

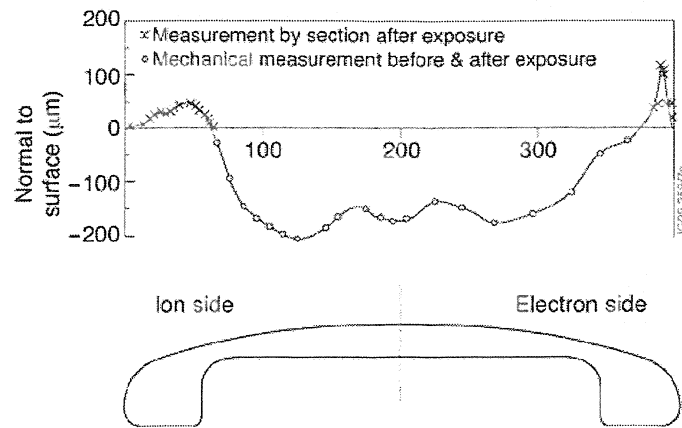
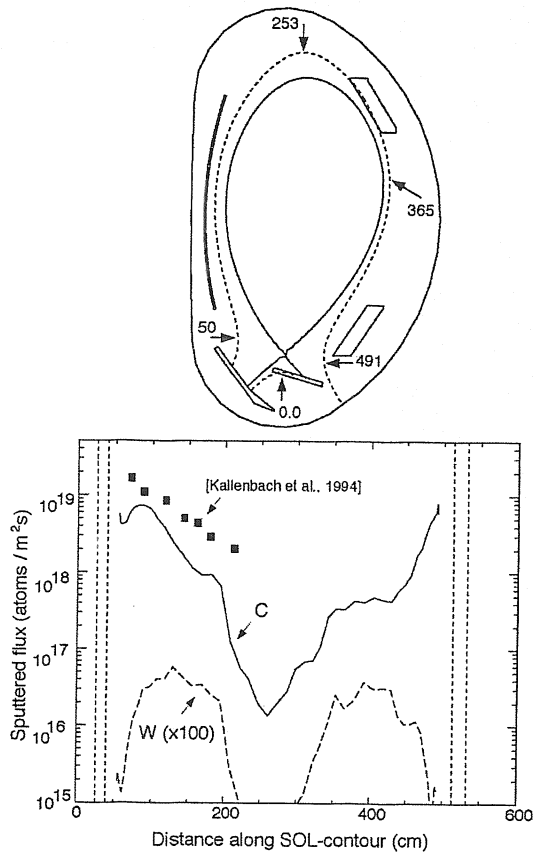

Figure 46. Erosion and re-deposition pattern (over a campaign of many discharges) across the carbon JET rail limiter; (reproduced with permission from [559].)



**Figure 47.** Distribution of the sputtered atom flux from the ASDEX-Upgrade vessel wall for carbon and tungsten wall material due to charge-exchange neutral sputtering as calculated from B2/EIRENE code calculations [156]. The carbon values can be compared to spectroscopically measured fluxes from the inner heat shield shown as solid squares [334]. The conditions in the divertor during erosion are: experiment:  $\langle n_e \rangle = 3 \cdot 10^{19} \cdot \text{m}^{-3}$ , calculations:  $n_e^{sep} = 5.2 \cdot 10^{19} \cdot \text{m}^{-3}$ .

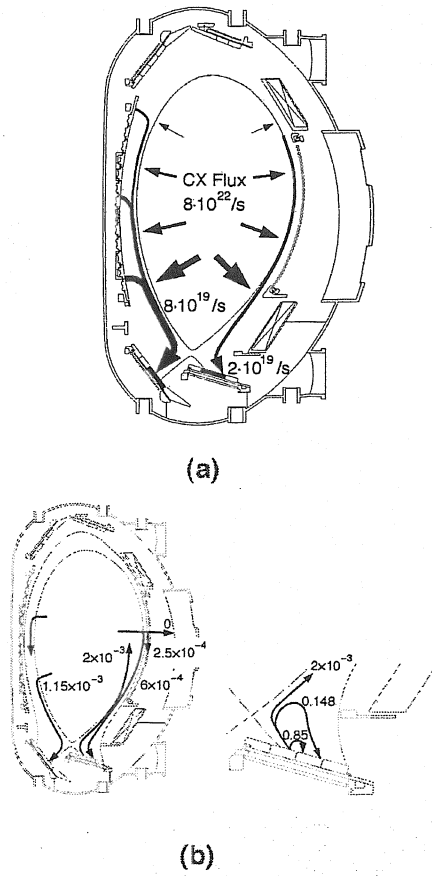

Figure 48. (a) Schematic erosion/re-deposition pattern of carbon wall material in the ASDEX-Upgrade divertor tokamak. For a total charge-exchange neutral flux of  $8 \times 10^{22}$  D/s, the calculated C-impurity flux is of  $8 \times 10^{19}$  C/s at the inner divertor and  $2 \times 10^{19}$  C/s at the outer divertor. (b) Schematic of the erosion/re-deposition pattern of divertor material in a divertor tokamak as obtained from the ASDEX-Upgrade W divertor experiment; (reproduced with permission from [585].)

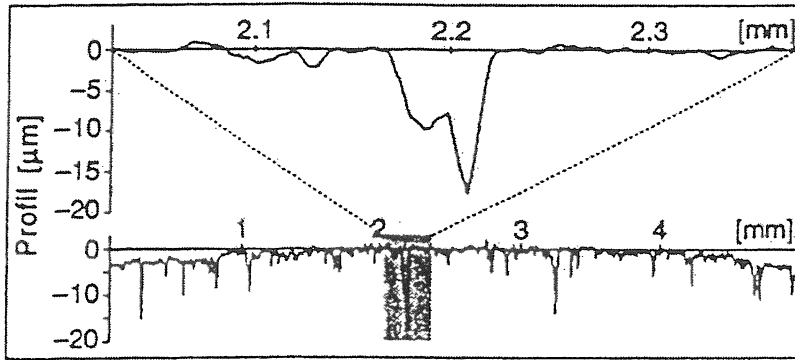

Figure 49. Surface profile showing arc traces on a polished graphite tile from the outer divertor of ASDEX-Upgrade exposed to 57 neutral beam heated 1.5 s discharges. Direction of scan is parallel to the magnetic field and therefore perpendicular to the direction of the arc traces; (reproduced with permission from [355].)

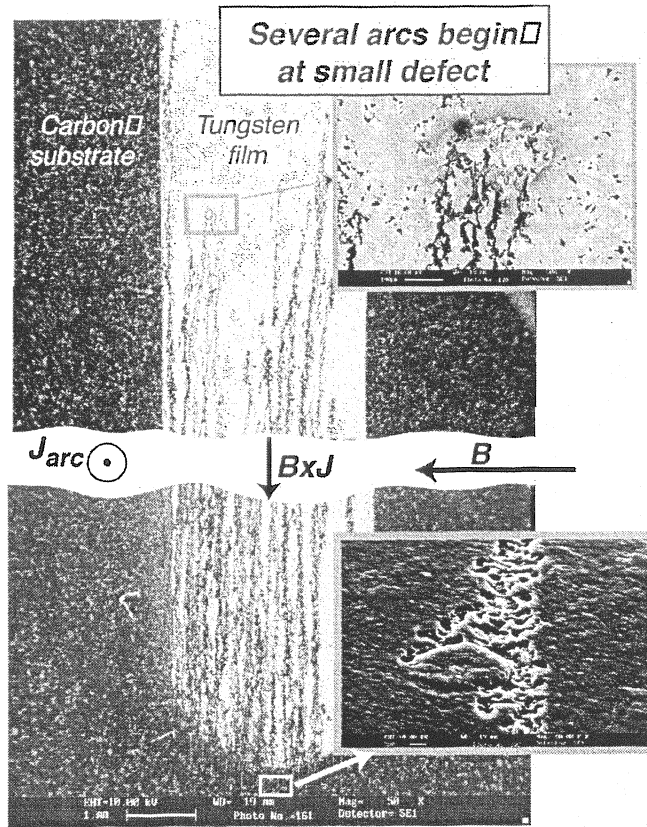
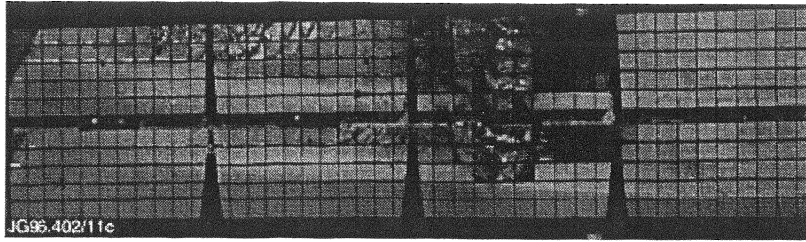
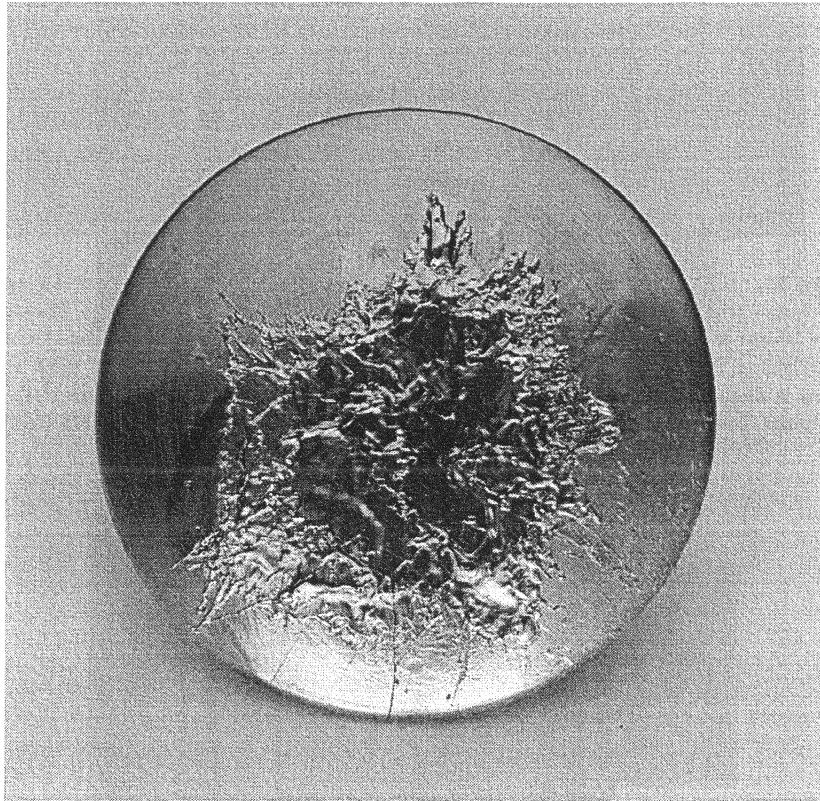

Figure 50. Example of arc traces on a  $0.1 \mu\text{m}$  W film on a graphite substrate exposed to a divertor plasma in DIII-D.





**Figure 51.** JET Mk-I Beryllium target plate tiles after plasma operation. A poloidal set of pairs of Be target tiles at the outer strike region are shown at the end of the Be phase. Shown are tiles in row 10 just outboard of the divertor centre line (left of the figure), to tiles in row 13 in the outer SOL (right of figure). The deliberate melting is seen on the tiles in row 12. A small amount of melting is also seen on the tiles in rows 10 and 11, resulting from giant ELMs prior to the melting experiment. Each tile is  $\approx 75 \times 40$  mm in size; (reproduced with permission from JET [631].)



**Figure 52.** Frascati Tokamak limiter of a tungsten-coated TzM mushroom type (60 mm in diameter) after plasma transient events. (Figure provided by G. Maddaluno - ENEA, Frascati.)

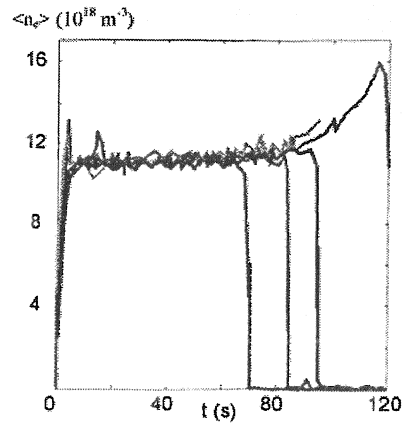

Figure 53. Volume average density evolution for very long discharges in Tore Supra; (reproduced with permission from [652].)

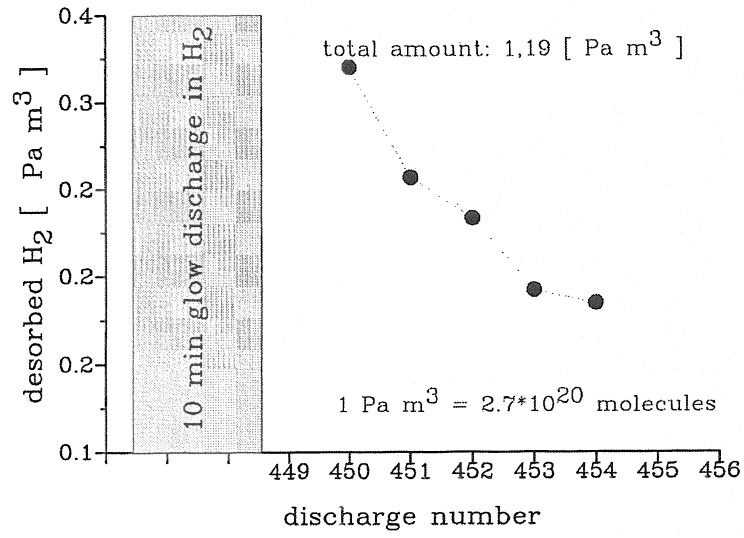
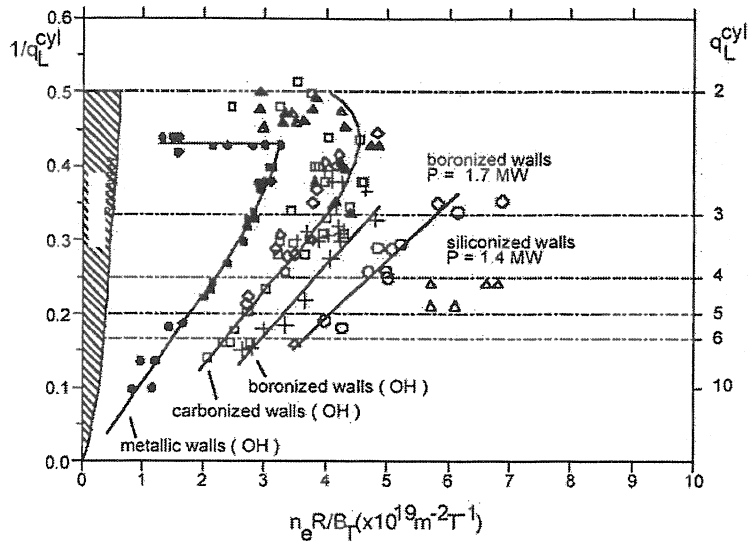

Figure 54. Removal of H<sub>2</sub> by ICRH plasmas from the first-wall of TEXTOR. 1 Pa·m<sup>3</sup> = 2.7x10<sup>20</sup> molecules; (reproduced with permission from [41].)



**Figure 55.** Operational density limits for TEXTOR for ohmic (OH) and beam heated plasmas for different surface conditions. Data for metallic walls are for hydrogen operation; all others are for deuterium. Data for carbonised walls include carbonised steel limiters and liners (squares and crosses) or graphite limiters and carbonised liner (other labels); (reproduced with permission from [671]). Triangles are data points measured recently with siliconised wall conditions [670].

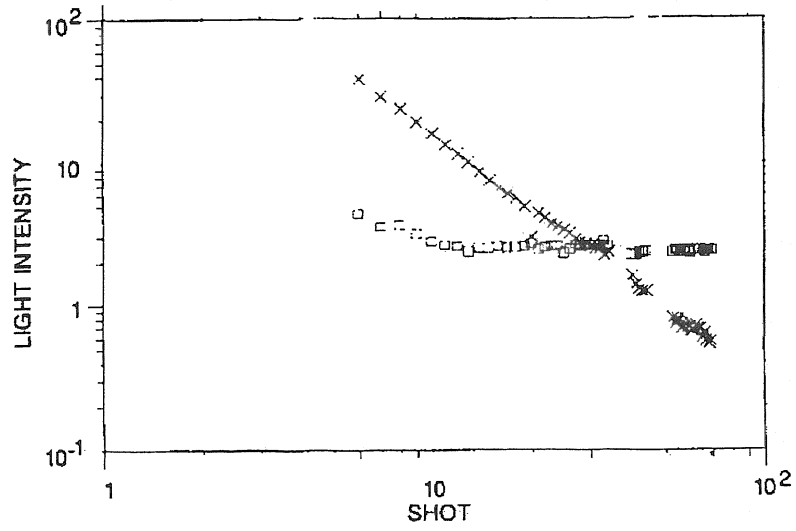

Figure 56. Deuterium (x) and carbon (o) influx in helium discharge cleaning pulses following a 1 MA ohmic disruption in TFTR; (reproduced with permission from [108].)

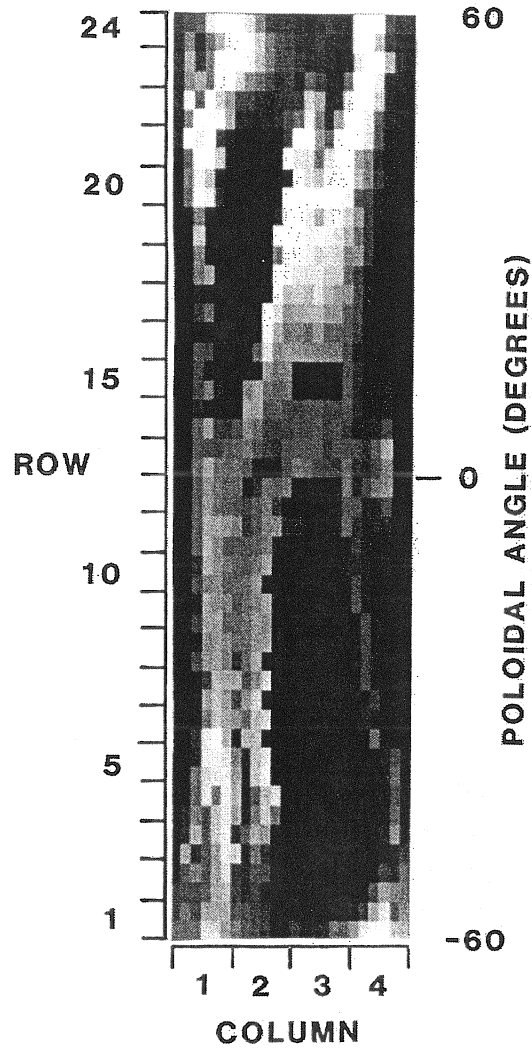

Figure 57. The areal density of metal atoms on one sector of the TFTR limiter measured by beta back-scattering. The highest metal atom deposition (lightest region in the figure) is  $\approx 10^{22}$  atoms-m<sup>-2</sup>; (reproduced with permission from [488].)

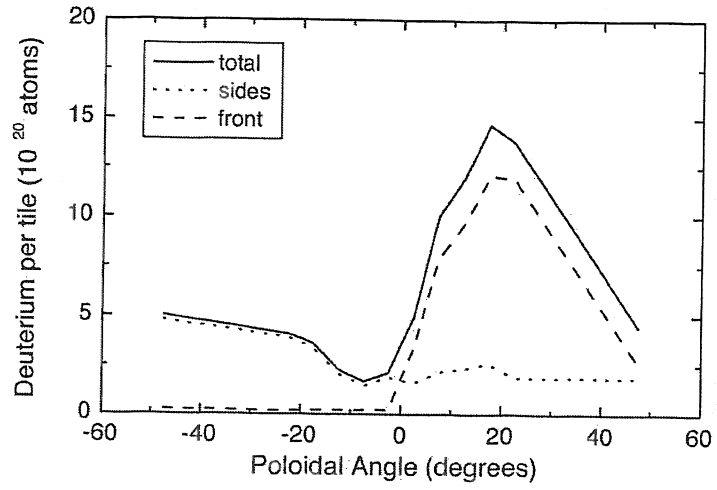
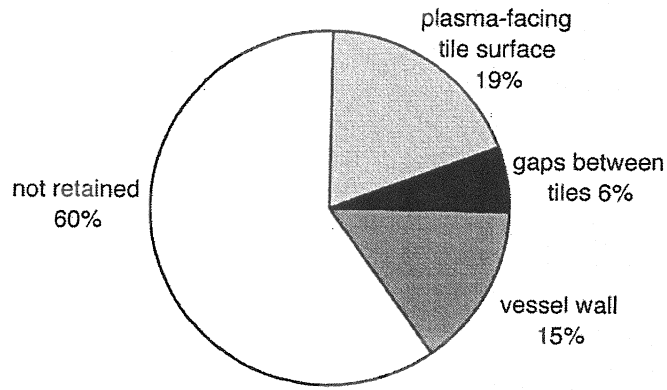

Figure 58. Retained deuterium on tiles from the TFTR bumper limiter.





**Figure 59.** Fraction of D fuelling retained in various regions of TFTR averaged over period from 1985 to 1991.

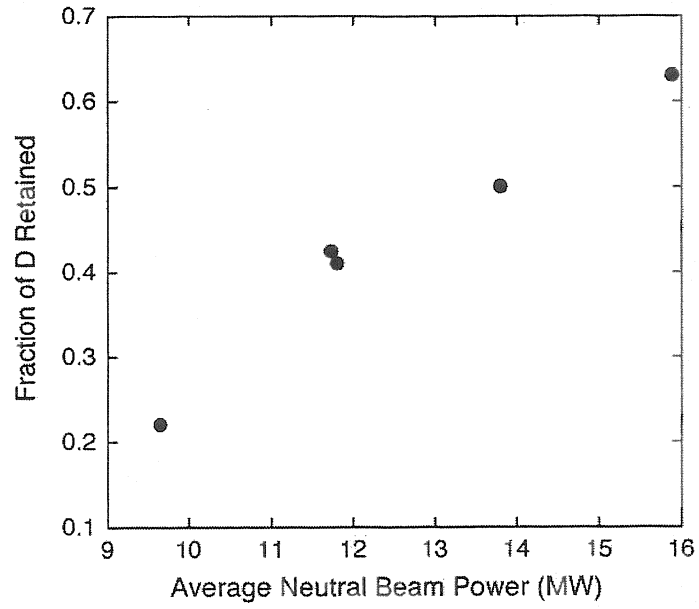

Figure 60. Fraction of deuterium retained in TFTR versus average neutral beam power.

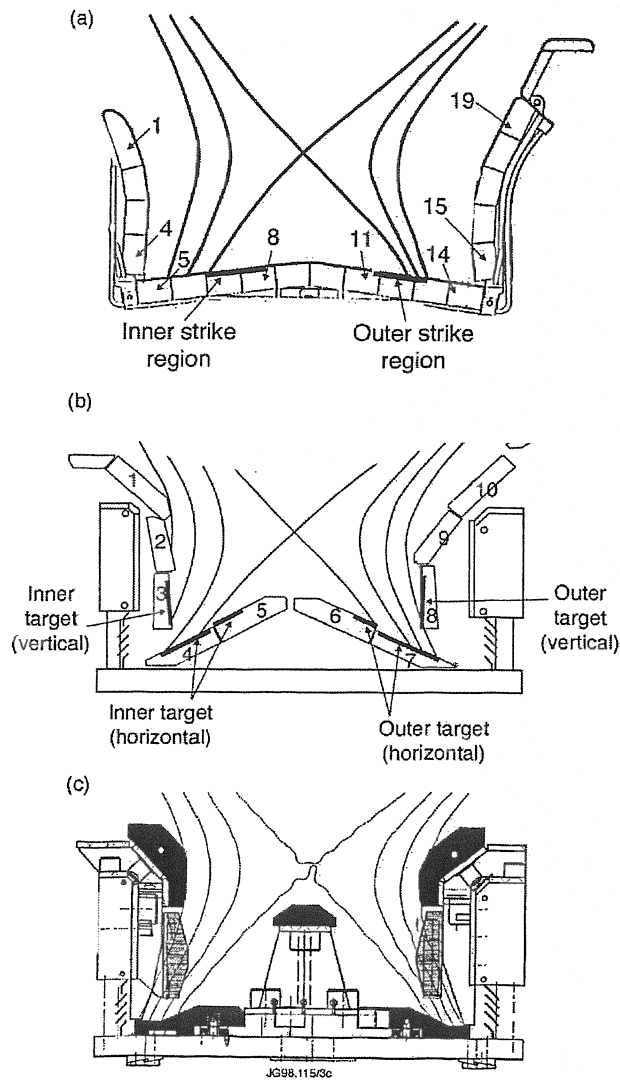

Figure 61. Geometry of (a) Mk-I, (b) Mk-IIA, and (c) Mk-II Gas-Box JET divertors; (reproduced with permission from JET.)

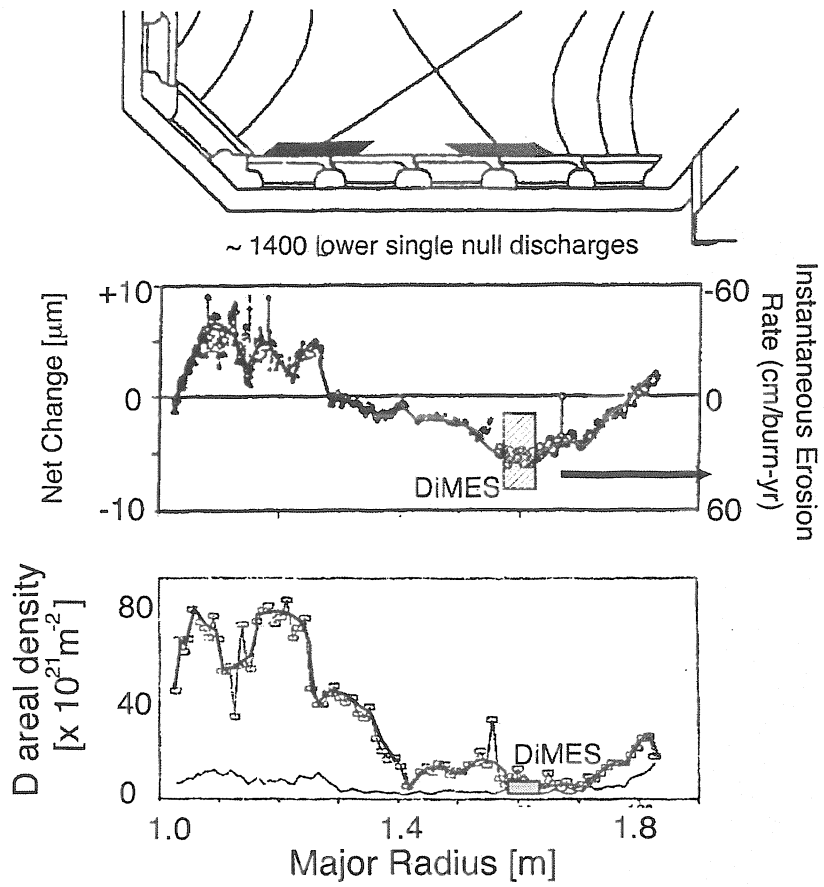

Figure 62. Retained deuterium and net erosion on tiles from the DIII-D divertor; (reproduced with permission from [721].)

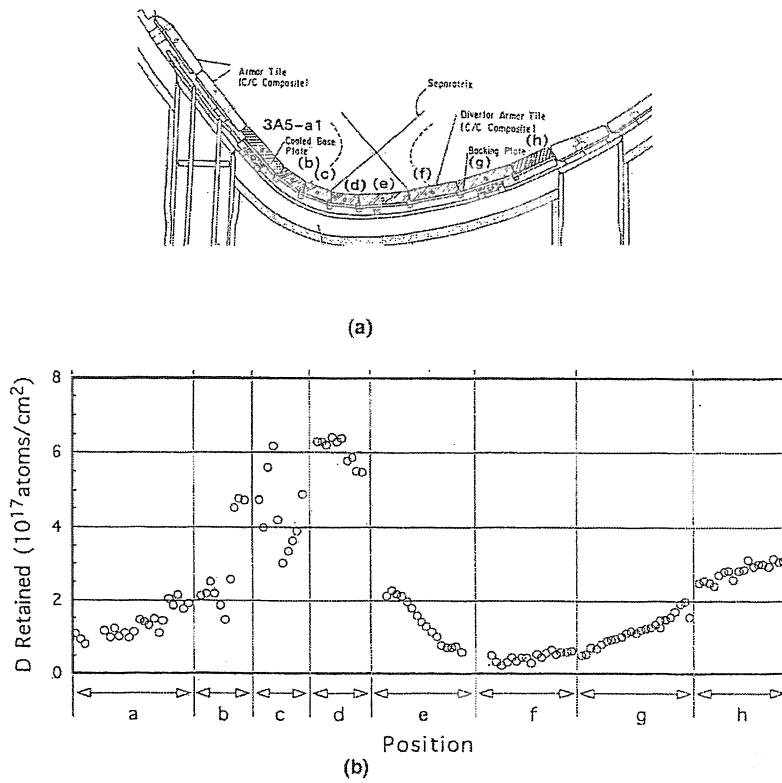

Figure 63. (a) Poloidal cross-section of the JT-60U divertor; (reproduced with permission from [724].) (b) Retained deuterium on divertor tiles in JT-60U; (figure provided by K. Masaki - JAERI.)

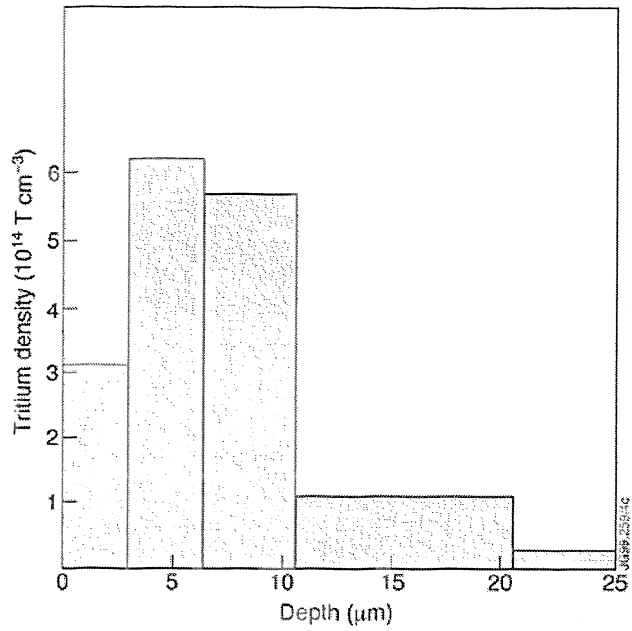
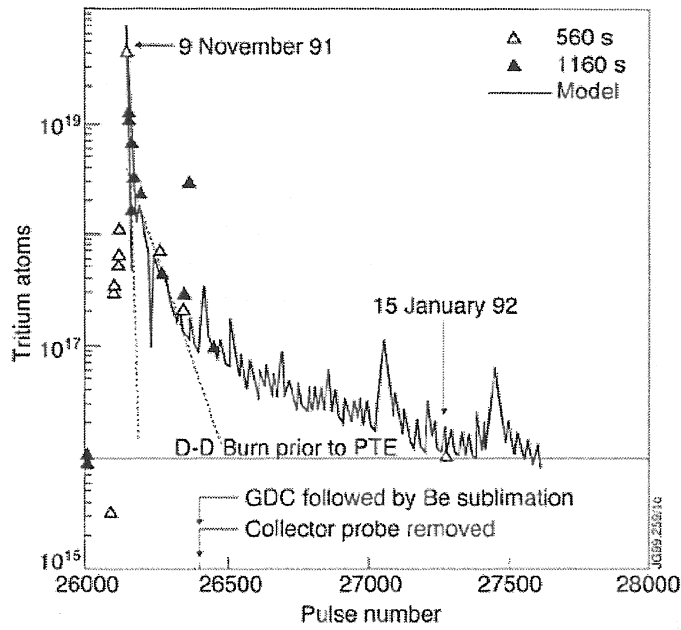
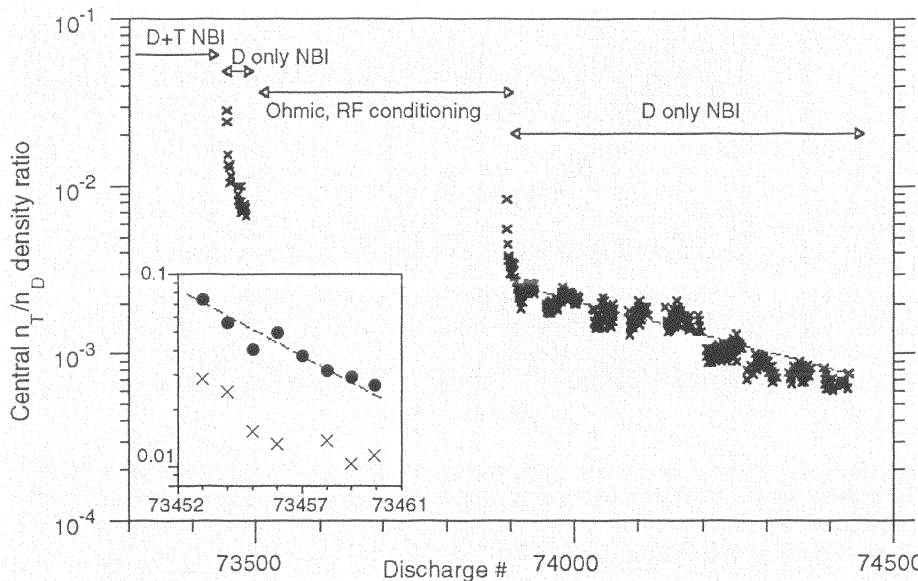

Figure 64. The tritium depth profile for the near-surface region of the JET mid-plane inner wall graphite tile; (reproduced with permission from [735].)



**Figure 65.** The number of tritium gas atoms released from the JET vacuum vessel as a function of pulse number for the PTE campaign and subsequent clean-up. The data are integrated for the first 560 s (open triangles) or 1160 s (closed triangles), and the solid curve is the prediction of a model; (reproduced with permission from [739].)



**Figure 66.** The decay, in between periods of tritium injection, of the central ( $r/a < 0.2$ ) T/D density ratio, as derived from the DT/DD neutron ratio. The long-term decay (starting at discharge #73950) followed a time constant of 404 discharges. The short-term decay is shown in the inset: (●) is the  $T\alpha/(H\alpha+D\alpha+T\alpha)$  ratio showing the T influx from the limiter and (x) the central T/D density over 9 deuterium discharges following a sequence of tritium NBI discharges; (reproduced with permission from [745].)



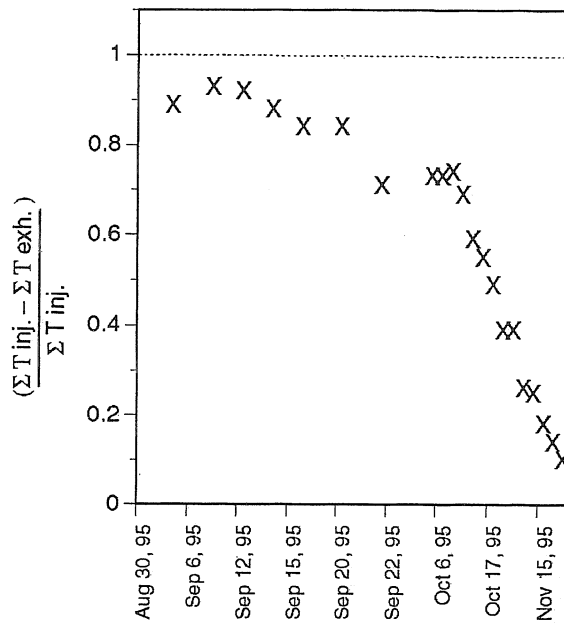

Figure 67. High retention during tritium gas puffing into TFTR during September-November 1995. The fractional retention is defined as the ratio of the cumulative tritium injected less the cumulative exhaust, divided by the cumulative tritium injected; (reproduced with permission from [528].)

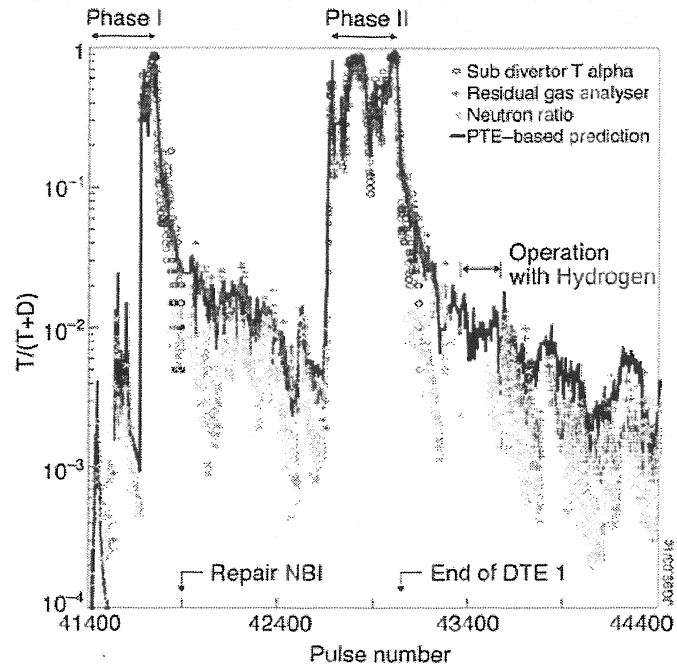
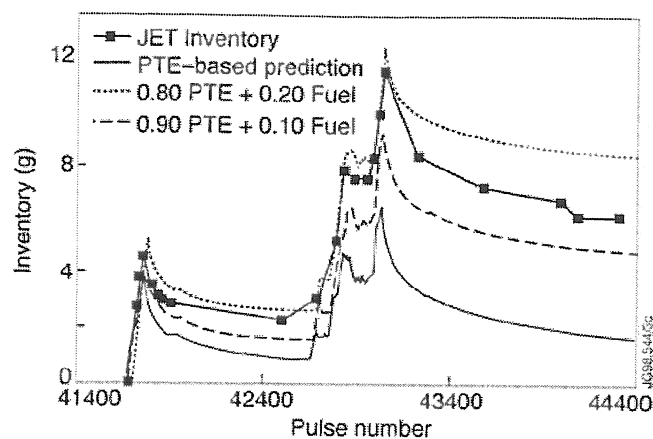

Figure 68. Tritium fraction measured in JET throughout the DTE by different diagnostics, compared to expectation based on the PTE; (reproduced with permission from [204].)



**Figure 69.** The tritium inventory in the JET vessel (measured as the difference between the tritium fuelling and the amount recovered from the vessel) plotted against pulse number for the 1997 DTE1 campaign. Also plotted are predictions of the inventory based on the behaviour during the PTE campaign of 1991, made by (i) merely scaling up the amount of T fuelling, (ii) adding an extra retention equal to 10% of the fuelling, and (iii) adding an extra retention equal to 20% of the fuelling; (reproduced with permission from [719].)

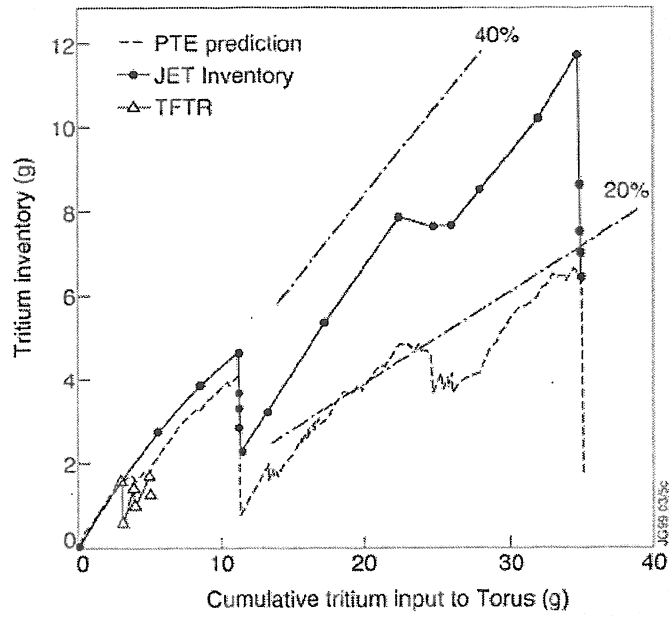

Figure 70. Tritium inventory in the torus versus cumulative tritium input during the JET DTE1 campaign; (reproduced with permission from [203].)

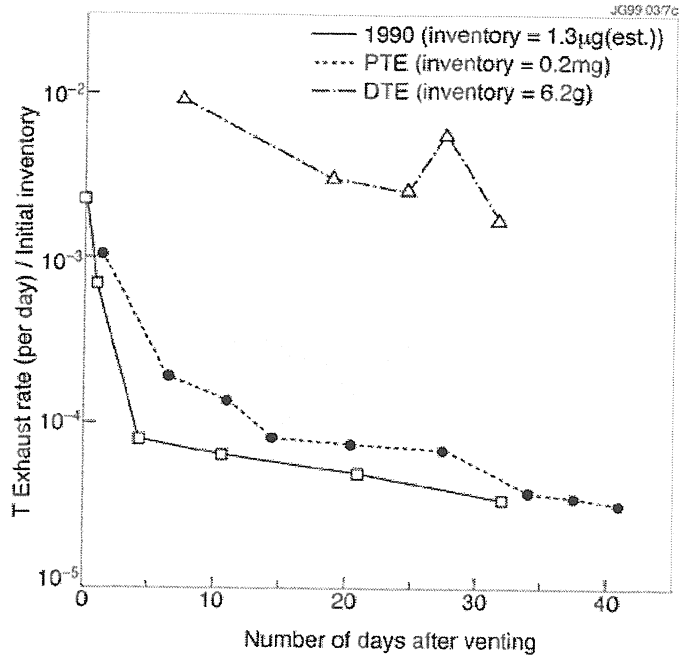

Figure 71. Rate of tritium release during air exposure of the torus at ambient temperature following the JET DTE1 campaign; (reproduced with permission from [203].)

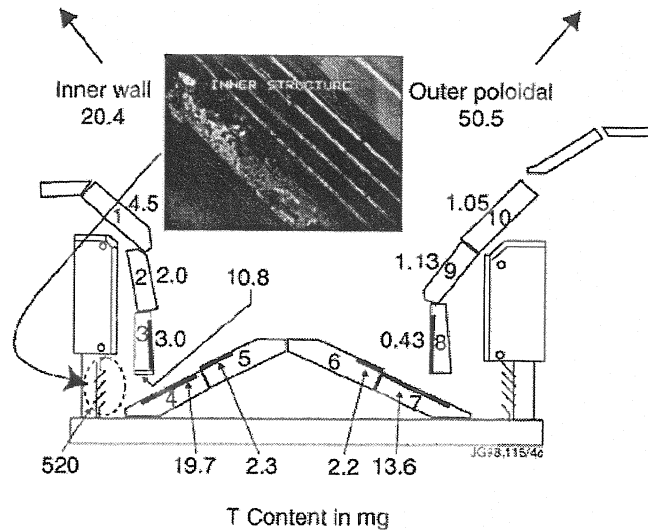
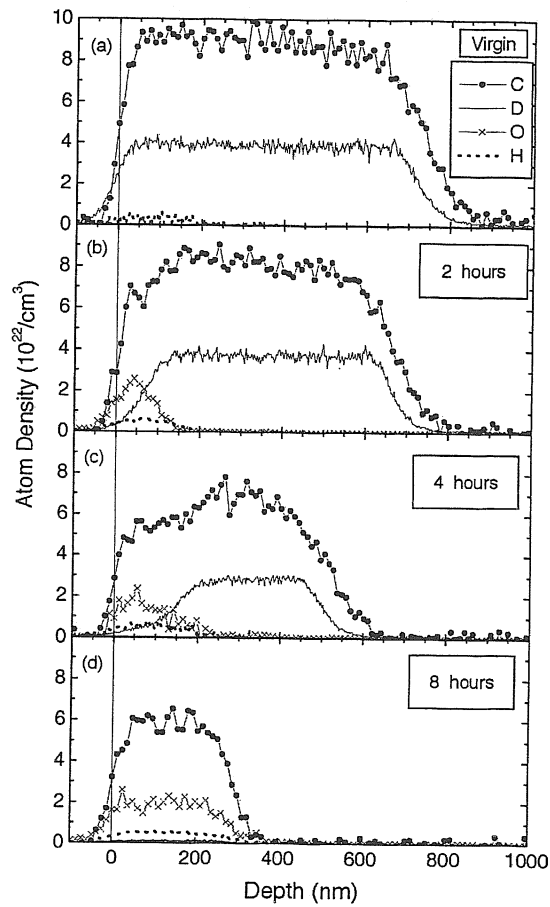

Figure 72. Distribution of tritium in the JET vessel in the shutdown following DTE1. The amounts at each location are integrated around the torus; (reproduced with permission from [758].). The photograph in the inset shows a typical region of the flaking deposition on the louvres at the inner corner of the JET Mk-IIA divertor; (reproduced with permission from JET.)



**Figure 73.** Depth profile changes in carbon, deuterium, oxygen, and hydrogen in a-C:D films due to air exposure at 650 K: (a) before annealing, (b) after annealing for 2 h, (c) after annealing for 4 h, and (d) after annealing for 8 h. The original film thickness was 730 nm. For each temperature step a fresh sample was used; (reproduced with permission from [468].)

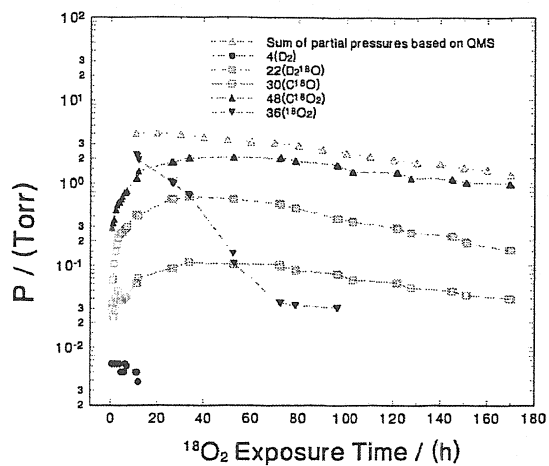

Figure 74. Partial pressure of reaction products formed during  $^{18}\text{O}_2$  exposure of an a-C:D film at 470 K; (reproduced with permission from [210].)



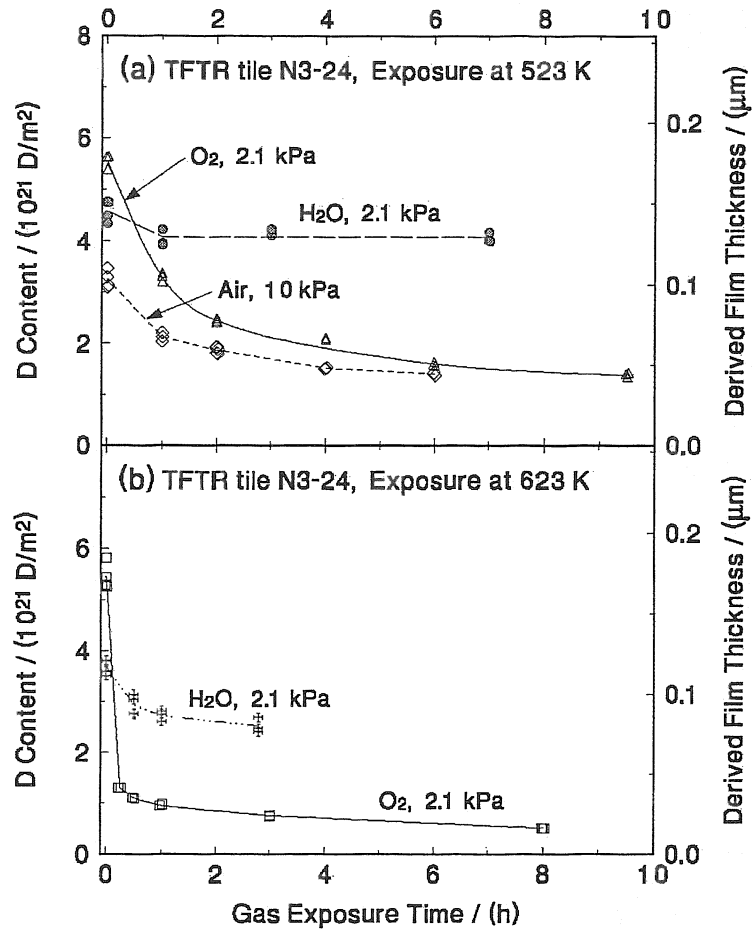

Figure 75. D content of TFTR co-deposit as a function of gas (O<sub>2</sub>, H<sub>2</sub>O, air) exposure time at (a) 523 K and (b) 623 K; (reproduced with permission from [209].)

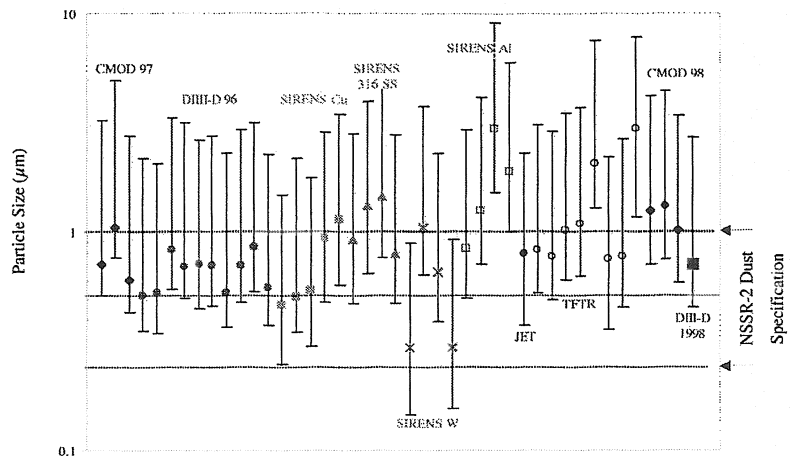

Figure 76. Tokamak and plasma gun particulate data used to specify values used in ITER safety analysis; (figure provided by K. McCarthy and D. Petti - INEEL, Idaho Falls.)

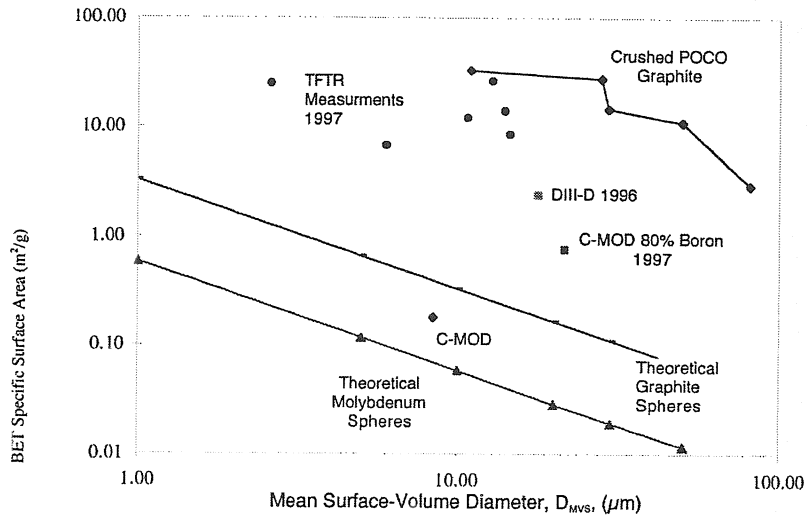

Figure 77. BET specific surface area of tokamak dust compared to theoretical carbon and molybdenum spheres; (figure provided by K. McCarthy and D. Petti - INEEL, Idaho Falls.)

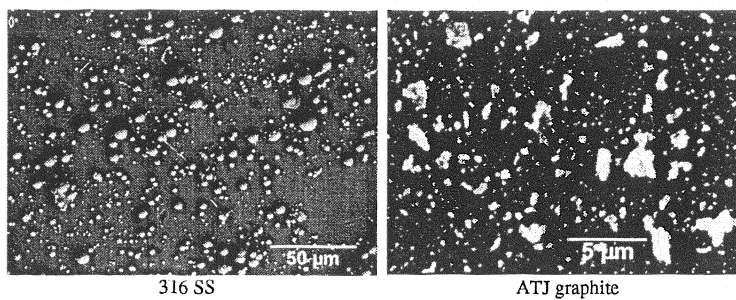
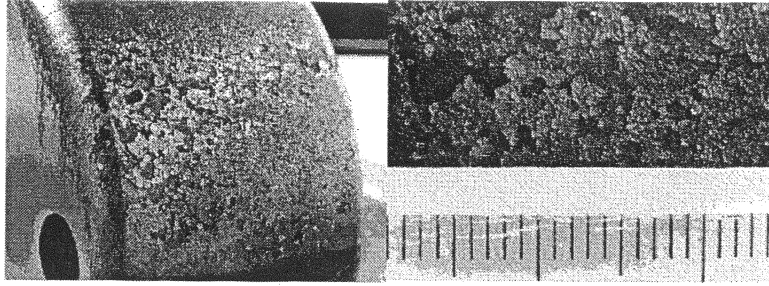

Figure 78. SEM photographs of particulates generated from the SIRENS plasma gun; (figure provided by K. McCarthy and D. Petti - INEEL, Idaho Falls.)



**Figure 79.** Photograph of the heavy deposition at the side of a TEXTOR limiter. The scale is in mm (visible are 23 mm) and refers to the detail of the flaking region shown on the upper right part of the figure; (reproduced with permission from TEXTOR.)

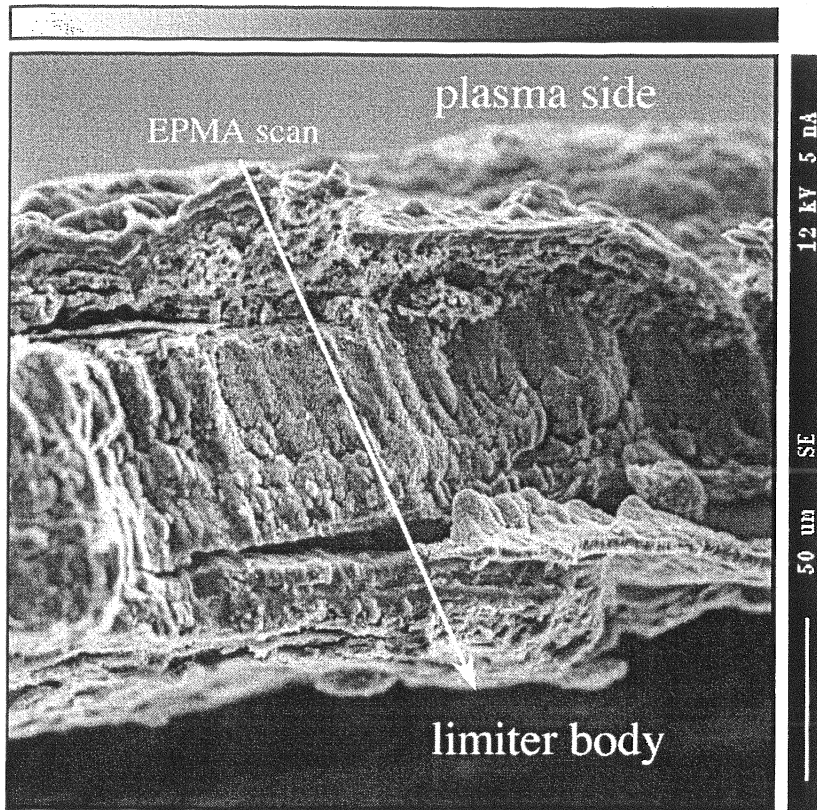

Figure 80. An SEM image of a piece of film that has flaked from the side of a TEXTOR limiter. (EPMA = Electron Probe Microanalysis;) (reproduced with permission from [800].)

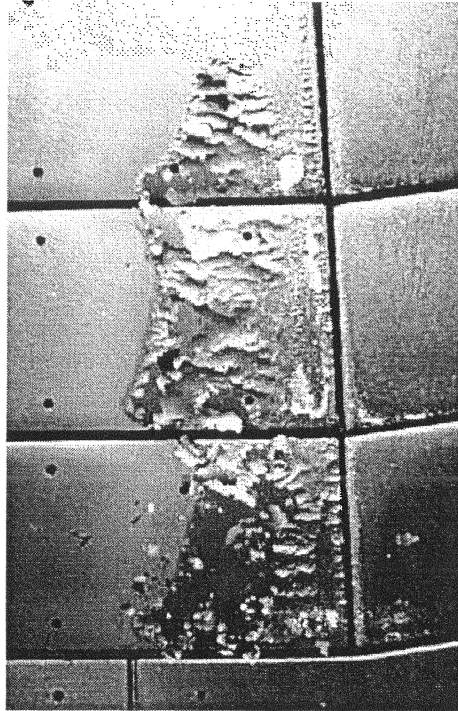

Figure 81. Blistering and flake detachment on TFTR graphite tiles at Bay H on February 25th 2000. The vertical height of a tile is 81 mm; (reproduced with permission from TFTR.)

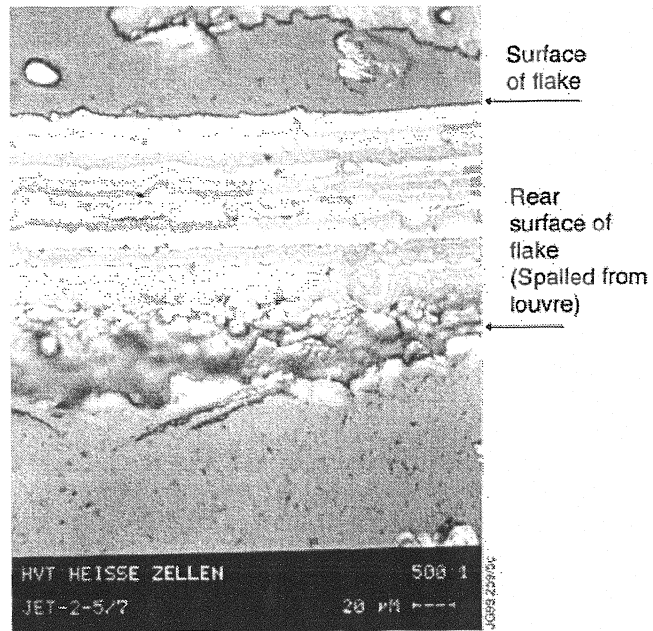
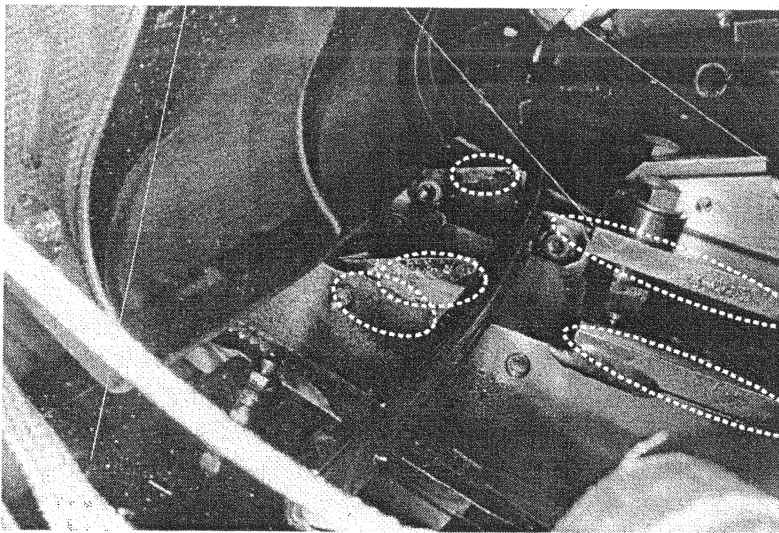
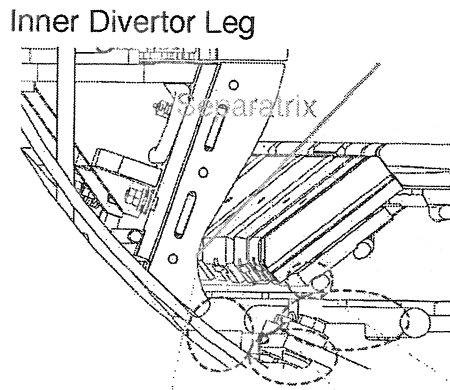

Figure 82. Polished cross-section of a flake from the JET Mk-IIA divertor, showing the layer structure. The scale marker on the figure is 20  $\mu\text{m}$ , which makes the film thickness  $\approx 100 \mu\text{m}$ ; (reproduced with permission from JET.)





**Figure 83.** Location of flakes and films of carbon in ASDEX-Upgrade. The flakes were found below the divertor, whereas carbon films were found on the divertor structure. They are located at surfaces perpendicular to the magnetic field. The direction on the inner and outer divertor are reversed; (figure provided by V. Rohde - ASDEX-Upgrade, Garching.)

## 5. APPLICATION OF MODELS AND PREDICTIONS FOR NEXT-STEP TOKAMAKS

### 5.1. Introduction

The conditions expected in next-step tokamaks are far removed from those attained in present and past devices and thus the extrapolation of current experience requires detailed models. Years of close interplay between experiment and modelling have resulted in models that can reproduce many features of plasma behaviour. Rapid progress in multi-teraflop computational resources continues to facilitate more detailed and comprehensive coverage of plasma and wall interaction phenomena. The next-step fusion experiment will require a large capital investment and modelling plays an essential role in finding optimal configurations and reducing the uncertainty in projections of the performance.

The diversity of phenomena has made it difficult to create integrated models of plasmas and wall boundary effects. Experimentally, the powerful effect of the wall conditions on plasma performance is very clear. However, the actual conditions on the wall surface during a discharge are hard to diagnose and the complexities of wall physics are not consistently incorporated into predictive plasma codes used by machine designers. Databases used to predict machine performance are based on experience in short-pulse machines with preconditioned walls, but it is likely that new phenomena will occur as the physical and chemical state of the wall changes in a long plasma pulse. Some work to link the state of the wall to plasma phenomena has begun. For example, the global tritium retention in TFTR has been linked to detailed Monte-Carlo models [201, 566]. Quantitative models connecting the dynamic exchange between recycling and the edge/pedestal region (see glossary) have been compared to experimental data in the JET DTE1 experiment [511]. Non-linear simulations of the stabilising effect of radial electric field shear have uncovered a link between enhanced confinement in TFTR and lithium conditioned low edge densities [60].

The continuing advances in available computational resources clearly lend themselves to constructing and linking codes of increasing complexity. However, one must be careful that the addition of free variables leads to codes that are thoroughly grounded in experimental data. The breadth and depth of diagnostic data from the wall/edge must increase commensurately with the complexity of the modelling. Experimental data on sputtering, reflection, and re-deposition under high flux conditions must guide and benchmark integrated models of the edge before a predictive capability can be confidently established. An emerging area with significant safety implications is the modelling and benchmarking of tritium co-deposition and dust generation.

Modelling of PMI effects and the interpretation of the available data are often hampered by the lack of detailed time-resolved diagnostics of the edge plasma and wall conditions, and lack of time-resolved measurements of erosion/deposition/H-retention. To make further progress in this critical area, real-time in-vessel diagnostics need to be further developed and more widely implemented with dedicated run time [474] (Sects 4.2 and 6.4). The detailed data generated will challenge models, lead to a better understanding of the many interacting plasma, atomic and surface phenomena involved, and generate more confident predictions

in future devices.

General principles of plasma-edge modelling by one-dimensional analytic modelling and two-dimensional fluid modelling are presented in Sect. 5.2 and illustrated with comparisons to tokamak measurements. A detailed discussion on this subject can be found in Ref. [13]. Two-dimensional Monte-Carlo impurity modelling is discussed in Sect. 5.3, which addresses modelling of erosion of and deposition on the PFCs, tritium co-deposition in growing-re-deposited surface layers, and the contamination of the core plasma from surface materials. Modelling of erosion of plasma-facing materials subject to off-normal events such as disruptions is discussed in Sect. 5.4. Sect. 5.5 is devoted to modelling of wall recycling and plasma particle balance. Finally, Sect. 5.6 discusses models of retention, permeation, and re-emission of hydrogen-isotopes in materials exposed to reactor plasmas. The physical processes and underlying theory behind these models were described in Sect. 3.

## 5.2. Plasma-Edge Modelling

Next-step designs, as typified by ITER, call for a device of significantly greater size and power than any earlier machine. To extrapolate to an ITER-class device, one must use several models to cover various aspects of edge/surface/boundary physics. Many such models have been developed over the last 20 years, and some have been validated to a certain degree by comparison with experimental data. In general, the plasma models simulate the parallel transport of particles, momentum and energy according to classical prescriptions, but still rely on empirical values for the cross-field transport rates. The inability to predict from first principles the absolute level of cross-field transport is the biggest weakness in modelling work. The relative level of cross-field transport, in comparison with the parallel transport, will determine the width of the SOL, and thus, the power density on the divertor plates (Sect. 1.2). Codes, for example, typically assume that cross-field transport coefficients are spatially-uniform (or vary with the strength of the poloidal magnetic field), something, which is almost certainly not correct [27, 801].

Modelling follows three basic approaches: (1) one-dimensional analytic modelling; (2) two-dimensional fluid modelling; and (3) two or three-dimensional, kinetic, Monte-Carlo impurity modelling (Sect. 5.3). The neutral hydrogenic behaviour is modelled separately. Each is dealt with separately below.

### 5.2.1. Simple one-dimensional modelling

In most cases, quick and reasonably accurate estimates of the basic plasma conditions in the SOL can be obtained from simple analytic expressions. Such modelling is often called in the literature "Two-Point Modelling" - "Two-Point", because one usually solves the transport equations at two locations, the divertor plate and some upstream location, typically the outside mid-plane (see Refs. [9, 10]). Basically the SOL problem is separated into two one-dimensional heat transport problems, one for cross-field transport and one for parallel field transport. The following is usually assumed in such modelling: (1) the divertor is opaque to recycling neutrals (Sect. 1.2.1); (2) the transport of heat along the SOL to the divertor is, therefore, through parallel heat conduction (primarily by electrons); (3) plasma pressure

is conserved along field lines in the SOL. An exception to the last may be close to the divertor plate, where plasma pressure may be lost by ion-neutral interactions and/or volume recombination when the divertor plasma temperature is low ( $< 3$  eV).

Under the above assumptions, simple expressions can be derived for many SOL parameters [9, 10]. Fig. 84 gives an example of such modelling, where experimental data from the Alcator C-Mod tokamak is compared against results from the two-point model with an extension for the neutral particle behaviour [802]. In this case, data are presented for the outer divertor plate, for a flux surface, which is 1 mm outside of the separatrix (outside mid-plane equivalent) - this is assumed to be representative of the SOL (which has a power width of  $\lambda_P \approx 3$  mm). The upstream parallel power density,  $q_u$ , is observed in experiment to be fixed at  $q_u \approx 75 \text{ MW}\cdot\text{m}^{-2}$ . Given in the figure is: (a) the relative level of radiation in the divertor  $P_{rad,div}/P_{SOL}$ , (b) the upstream density  $n_u$ , (c) the target plate density  $n_t$ , (d) the upstream and target plate temperatures  $T_u, T_t$  (ion temperature is assumed equal to electron temperature), (e) the electron pressure upstream and at the plate  $p_u, p_t$ , and (f) the molecular flux density of the  $D_2$  gas in the divertor plenum. Two fitting parameters are used in this modelling: the radiated power in the divertor is taken from experiment, and the relation between the upstream density and line-average discharge density  $\bar{n}_e$ , where we make the approximation  $n_u \approx \bar{n}_e/3$ . Thus, the ‘‘good fit’’ between model and experiment in Fig. 84(a) and Fig. 84(b) is artificial.

*Insert Fig. 84*

The analytic modelling readily identifies three regimes of SOL operation (indicated in Fig. 84), which depend on the collisionality of the SOL, or in other words, the ability of the SOL to sustain temperature gradients along field lines for a given density and power flow. In terms of engineering parameters, the SOL can sustain significant gradients if,

$$\frac{n_u^2 L^{\frac{6}{7}}}{q_u^{\frac{6}{5}}} > 2 \times 10^{31}, \text{ in MKS units} \quad (28)$$

where  $L$  is the connection length (see glossary). A similar criterion in terms of plasma density and temperature appears in [803].

At low values of collisionality, e.g., at low density or high power, the SOL is isothermal, with relatively high values of temperature,  $T_u \approx T_t > 60$  eV. This is known as the ‘‘linear’’ or ‘‘sheath-limited’’ regime. ‘‘Linear’’ because the divertor plate density increases in proportion to the upstream and average discharge density, and ‘‘sheath-limited’’ because parallel heat flow is limited by the sheath transmission of electron energy at the divertor plate.

At moderate levels of collisionality, i.e., moderate levels of density and power flow, significant gradients along field lines can develop. This regime, known as the ‘‘high-recycling’’ (see glossary) or ‘‘conduction-limited’’ regime, has low divertor plate temperature and high divertor plate density. In this case, the heat flow along the field lines is limited throughout most of the SOL by electron heat conduction. Close to the divertor plate, where strong particle recycling occurs and where electron temperatures and their gradients are low, parallel particle convection dominates the heat flow. It is assumed that the total plasma pressure

adjacent to the plate is approximately equal to the upstream plasma pressure, i.e.,  $n_u \cdot T_u \approx n_t \cdot T_t$ , which is usually the case with  $T_t > 5$  eV.

At still higher values of collisionality, the target plate temperature falls below 3 eV and the ionisation reaction rate for recycling neutral particles in the divertor becomes small in comparison with the rate of ion-neutral charge-exchange and elastic scattering. Under these conditions, first pointed out in [804], significant plasma pressure loss can occur next to the plate, concomitant with a drop in ion particle flux and plasma density (Fig. 84(e)). The ion flux to the plate can be reduced still further by volume recombination of the ions [805].

This last regime, the “detached” regime, is very desirable from the point of view of power handling at the divertor plate. The parallel power density  $a_t$  the divertor plate is given by,

$$q_t = n_t c_{st} \cdot (\gamma T_t + \epsilon_{pot}) \quad (29)$$

where  $c_{st}$  is the ion acoustic speed,  $\gamma = 7$  and  $\epsilon_{pot}$  is the potential energy associated with each ion reaching the plate, including the atomic and molecular recombination energies ( $\epsilon_{pot} \approx 16$  eV) [9]. At low plate temperatures, the heat flux is dominated by the last term associated with the potential energy. This can only be reduced to low levels (e.g.,  $q_t/q_u < 0.05$ ), for a reasonable level of upstream plasma pressure, if pressure loss due to friction and possibly recombination is present [139, 806, 807], as observed in the experimental data from Alcator C-Mod (Fig. 84(e)) and similar data from several other machines [142, 808, 809].

The neutral molecular flux density,  $f_{mol}$ , adjacent to the divertor plasma is given by Fig. 84(f). One can see that this increases monotonically with discharge density, basically following the divertor plasma density in the linear and high recycling regimes. It continues to increase with discharge density even in the detached regime, and this is expected from simple particle balance given by the extended two-point model [9].

### 5.2.2. Two or three-dimensional fluid modelling

The two-dimensional nature of the SOL led to the development of two-dimensional fluid models based on the finite difference numerical technique. Typically, the SOL and the outer regions of the confined plasma are mapped out using a curvilinear grid, where one dimension lies along magnetic flux surfaces, and the other, i.e., the radial direction, is orthogonal. In the parallel direction, as with two-point modelling, the transport of particles, momentum and energy is assumed classical, although in this case the full set of Braginskii equations are used [810]. In the cross-field direction, again, spatially uniform anomalous transport coefficients are used, with typical values for the particle and heat diffusivity ( $D_{\perp}$  and  $\chi_{\perp}$ ) being of order  $\approx 1 \text{ m}^2 \cdot \text{s}^{-1}$ . The inner boundary of the problem corresponds to a magnetic flux surface inside the plasma, normally in the region of  $r/a \approx 0.9$ . At this boundary, one might specify the heat flux crossing the surface from the confined plasma, the density and temperature. There are now several large plasma fluid codes used to model the edge, with the major ones being B2 [811–813], UEDGE [814–816], EDGE2D [817, 818], PLANET [819], and UEDA [820].

The volume source of ions via neutral particle ionisation is a critical quantity in any modelling of the boundary. This determines the plasma flow patterns, the level of heat convection,

the transport of impurities, etc. Usually, fluid codes rely on a partner code to model the neutral particle distribution in the boundary. These partner codes attempt to model the transport of neutral particles from their point of entry into the plasma to their eventual ionisation. Thus, surface properties such as particle reflection and molecular re-emission must be considered, as well as a large variety of atomic and molecular processes, the most important of which are molecular dissociation, ionisation and charge-exchange (see review [821]). These neutral particle codes use either a Monte Carlo technique (e.g., DEGAS [747, 822], DEGAS 2 [823], EIRENE [824, 825], NIMBUS [826]) or a fluid prescription [827]. The Monte-Carlo technique, essentially a kinetic calculation, is technically more appropriate for tokamak boundaries, but can be computationally demanding in comparison to fluid calculations. Fluid calculations tend to be more valid in the divertor than in the main chamber, particularly in high-density divertors as in C-Mod [827] and expected for ITER because the collisional mean free path (see glossary) of neutral particles becomes much shorter than the typical divertor or grid dimensions.

It is important that plasma-edge models include effects of neutral hydrogen on energy and particle transport. The DT neutron rate was used to provide a measure of the deuterium influx into the core of TFTR. Modelling with the DEGAS code was able to relate the deuterium influx to the probability of incoming neutral deuterium penetrating the SOL [33]. A recent study [828] shows that density and temperature gradients in the plasma edge depend strongly on local neutral hydrogen density due to effects of charge-exchange and ionisation on the anomalous inward drift velocity.

In addition to handling neutrals, sophisticated plasma fluid codes can model a large number of plasma species including all the charge-states of wall impurities and helium ash. A model for the generation of impurities by physical and chemical sputtering is required. Physical sputtering can be represented by a sputtering yield as a function of incident ion energy and angle of incidence. Although the validity of physical sputtering models can be uncertain due to lack of confirming available data at, for example, near-threshold energies, and oblique angles of incidence, the models are nevertheless relatively straightforward [111]. Chemical sputtering can be an important process for carbon surfaces and there is considerable uncertainty in the appropriate sputtering yield, its dependence on surface temperature, particle energy and flux density (Sects. 3.2, 4.3 and 5.3). Further, it is not clear how the hydrocarbon molecules that are released are broken down in the boundary plasma, ultimately resulting in a source of carbon ions. These uncertainties emphasise the importance of rigorous comparisons between modelling and experiments (Sects. 6.3). Such hydrocarbon modelling has been in a continual state of development for over 10 years.

Fig. 85 gives an example of B2/EIRENE modelling of the 1998 ITER design, where the radial profiles of density  $n_e$ ,  $T_e$  and total plasma pressure,  $p$ , at the upstream and target plate are presented [829]. The radial co-ordinate corresponds to the outside mid-plane location. In this case, 200 MW of power enters the inner boundary of the grid from the core plasma. Approximately 120 MW of this is radiated in the boundary and SOL by impurities, where He, Ne (seeded at 0.2% at the inner boundary) and carbon (primarily chemically sputtered from the divertor plates) are all present and modelled. The assumed cross-field transport

coefficients are  $D_{\perp} = 0.3 \text{ m}^2 \cdot \text{s}^{-1}$  and  $\chi_{\perp} = 1 \text{ m}^2 \cdot \text{s}^{-1}$ . The radial e-folding widths for density, temperature and pressure at the outside mid-plane are approximately 2 cm, 2 cm and 1 cm, respectively. In the divertor, the radial temperature profile shows a cold region close to the separatrix, with a flat temperature profile further out in the SOL. The divertor is significantly colder than the mid-plane, and consequently the density is much higher in the divertor, rising above  $10^{21} \text{ m}^{-3}$ , and the plasma pressure drops in a radial region close to the separatrix (and below the X-point). This so-called "partial detachment" is frequently observed in present experiments [9, 142, 808, 809].

*Insert Fig. 85*

An alternative approach to the modelling of impurities in the boundary is to start from a background plasma given, either from detailed experimental measurements or from some other modelling source, i.e., two-point or fluid modelling. Impurities are then injected into a 2-D grid of the boundary and their trajectories followed by the Monte-Carlo method. Such a technique has numerous advantages over running a full-scale multi-fluid code - it is typically easier to write, is numerically stable and in many respects handles the detailed impurity transport better, particularly during the time period before an impurity is ionised and fully thermalised/coupled to the background plasma.

The Monte-Carlo approach is ideally suited to handling chemical sputtering (Sect. 5.3). Carbon enters the plasma 'grid' in the form of a hydrocarbon molecule, e.g.,  $\text{CH}_4$ , that, through interaction with the plasma is dissociated through a long list of daughter products, some neutral and some ionised. During this process, the fragments are heated and collisionally coupled to the plasma. These processes are not handled in fluid codes, since they are of a kinetic nature, yet may be critically important in ultimately determining where the fragments are transported. A Monte-Carlo handling of this problem, in contrast, is relatively straightforward (although perhaps tedious). There are a number of impurity transport codes using the Monte-Carlo technique. These include WBC [830], DIVIMP [831], IMPMC [820] MCI [832] and BBQ [327, 833].

### 5.3. Sputtering Erosion and Co-deposition Modelling

#### 5.3.1. Modelling approaches and validation

The flux of energetic ions and neutrals onto plasma-facing surfaces results in sputtering by physical and chemical processes as described in sections 3.2 and 4.3. At the same time, impurities flow onto these surfaces from the plasma. The net result of these two competing processes can be either removal or accumulation of material at the surface. A significant portion of sputtered material is promptly ionised and returned to the surface near its point of origin, greatly reducing the net compared to gross erosion rate. The magnitude and spatial distribution of the net erosion depend on the material properties, and on near-surface, SOL, and core plasma transport processes. Quantifying these effects in erosion/re-deposition/co-deposition models is essential to help select surface materials and plasma edge regimes, to predict the lifetime of divertor and wall components, to evaluate the sources of impurities

and the resulting plasma contamination, and to calculate the accumulation of tritium in co-deposited layers (Sect. 2.4).

Due to gradients in plasma density, temperature, and flux, impinging energy, sputter yield energy dependence, etc., there can be a rapid change in net erosion rate along a surface, particularly near a strike-point. Erosion on one side of the strike-point, for example, can give way to deposition on the other side. This has been clearly demonstrated for divertor machines, and at the limiters of tokamaks without divertors, where deposition occurs further out in the SOL, especially at the sides of the limiters (e.g., [559, 566].) This process also occurs, during plasma start-up, at the poloidal limiters in the main chamber of machines with a divertor configuration. Deposition can also occur away from the divertor or limiter, i.e., on the first-wall, or adjacent surfaces. The amount and location of the re-deposited material is crucial for future devices using carbon, because tritium will be trapped within these deposits by the co-deposition process (Sect. 3.5.3.6). Co-deposition is important too for beryllium, but less so than for carbon due to lower H/Be trapping fractions, and is much less important for tungsten and other high-Z materials due to both lower trapping fractions and low erosion rates.

The ITER project has chosen carbon for the divertor target, due primarily to perceived advantages in disruption response (Sect. 2.4). Also, the reference ITER divertor plasma is partially-detached, with moderate plasma temperature ( $T_e \approx 30$  eV) away from the strike-point, and detachment ( $T_e \approx 1-5$  eV) near the strike-point. These choices have led to a co-ordinated effort in the fusion community to improve models for low plasma temperature carbon erosion analysis. Ironically, this is by far the most difficult plasma/material combination to analyse, due to the need to model low impingement energy chemical sputtering yields, multi-species hydrocarbon transport, rapidly varying atomic and molecular processes in low temperature plasmas, and low-energy carbon/hydrocarbon sticking/reflection at the surface. Other next-step fusion designs, notably the FIRE design study [248], have chosen a tungsten divertor surface, in part to avoid problems with high carbon erosion rates. In this section we review erosion/re-deposition modelling for surface materials in general, but with a strong focus on carbon.

Experimental investigations of re-deposition and net erosion in fusion devices have gained importance in recent years, however, data is limited by restricted access to machines and the lack of experimental methods giving real time erosion information (Sects. 4.2 and 6.4). Furthermore, comparison between data and models is sometimes difficult because erosion/deposition processes depend strongly on local plasma conditions that in most cases are not known very well. However, dedicated experiments, notably in DIII-D, with good near-surface plasma diagnostics, and in-situ and ex-situ erosion measurements have verified erosion/deposition models, for several materials and plasma regimes. In certain cases, notably carbon in a detached plasma regime, the present database on net erosion is still in a preliminary state and much more experimental work is needed (Sect. 6.1). Thus, the low plasma temperature carbon case suffers both from highly uncertain models and insufficient data.

The general feature of the models/codes is that they use a given background plasma



solution, calculate the sputtering rate for the given material (using, e.g., the material erosion properties data described in Sect. 4.3), and follow the paths of the particles through the plasma until they are re-deposited onto the originating surface or another surface, or enter the SOL/main plasma region. A description of the general modelling techniques can be found in Refs. [490, 830, 834–837]. In most cases, boundary plasma conditions are not strongly influenced by impurities coming from the surface. An exception would be in cases where near runaway self-sputtering occurs. The ultimate goal is to model all effects self-consistently, but this capability is not yet available.

Inputs to the erosion/re-deposition codes are the measured, or derived by plasma codes, plasma density, temperature, deuterium-tritium ion flux, charge-exchange neutral flux, magnetic field profiles and strike-point variation with time over the exposure periods. These codes incorporate numerous models and sub-codes for sputtering and reflection coefficients, atomic and molecular processes, plasma-impurity collisions, surface temperature and temperature-dependent hydrogen isotope trapping ratios, and sheath parameters. Critical sub-models for detached plasma conditions discussed here include carbon chemical sputtering coefficients at low energies (5–15 eV), rate coefficients for hydrocarbon molecular impact processes with plasma ions and electrons, hydrocarbon sticking coefficients, and the effects of mixed-materials, e.g., beryllium and carbon, on sputtering and tritium trapping. Some details of these critical models are given in Sect. 3.2 and Refs. [552, 838].

The REDEP/WBC code package developed by Brooks [834, 835] is a prime example of a current state-of-the-art erosion code package. The WBC Monte-Carlo code [830] computes the details of the impurity atom and ion transport at the kinetic description level. This code is relatively time consuming being Monte-Carlo, and since it follows, in principle, all relevant details of the impurity transport (e.g., charge-changing and velocity-changing impurity-plasma collisions), with sub-gyro motion detail. The re-deposition parameters computed by WBC can be used as input to REDEP, a finite difference code that is numerically optimised to treat the entire plasma-facing surface. With the availability of fast, inexpensive work stations, there is increased use of Monte-Carlo codes alone.

To assess the reliability of erosion/deposition predictions for a next-step device many comparisons of code predictions and observations of erosion/deposition have been performed in current tokamaks, for example TFTR [201, 563, 710, 839], DIII-D [153, 530, 548, 721, 840], ASDEX-Upgrade [534], TEXTOR [837] and JET [110, 841] and on laboratory plasma linear devices such as the PISCES [842] and the PSI-1 [295] facilities.

An extensive effort at code validation has been done using measurements of erosion/deposition in the DIII-D divertor using the DiMES facility [153, 530, 548, 721, 840]. Probes containing carbon, beryllium, vanadium, molybdenum, and tungsten were exposed at the strike-point to various divertor plasma conditions. Post exposure ion-beam analysis determined net erosion/deposition of material resulting from short exposures to steady-state divertor plasmas. The plasma conditions needed for modelling erosion/deposition were well characterised by Langmuir probes, Thompson scattering, spectroscopy and neutral pressure diagnostics. The observed erosion/deposition of carbon at the outer strike-point with attached H-mode plasmas agrees well with the Brooks and Whyte REDEP/WBC modelling

[530, 548]. In general, comparison of code with experimental results for attached plasmas in DIII-D, shows good agreement for erosion profiles, photon emission, and core plasma contamination by sputtering.

Results from a long-term exposure ( $\approx 1400$  discharges) of DIII-D divertor tiles [721] show a carbon erosion rate at the attached outer strike-point of  $\approx 9.5 \text{ nm}\cdot\text{s}^{-1}$  ( $\approx 30 \text{ cm}\cdot\text{burn}\cdot\text{year}^{-1}$ ) with an equivalent rate of deposition at the inner strike-point (where the plasma is usually detached). This erosion rate is the same as was measured during short exposures at the outer strike-point in DiMES experiments [721].

The modelling work of Brooks and Whyte for DIII-D described above also included the effect of ELMs on erosion by sputtering. This was modelled for an attached plasma regime in DIII-D [548]. The near-surface plasma temperature during the ELM was estimated to be similar to the period between ELMs, but the plasma density, particle flux and hence gross erosion rate, are about 20 times larger during the ELM. However, the very high electron density during the ELM decreases the mean free path for ionisation of the sputtered carbon atoms by an order of magnitude, causing prompt local re-deposition of carbon to approach 100%. Furthermore, the ELM period constitutes only about 3% of the total exposure time. The contribution of the ELM period to the total net erosion is therefore negligible, and it is the quiescent period that determines the net erosion rate. This prediction was verified experimentally on DIII-D from DiMES net erosion experiments with and without ELMs [548]. Unlike DIII-D, ELMs in ITER will cause erosion by thermal ablation (discussed in Sects. 2.3.2.3 and 5.4.3) in addition to erosion by sputtering discussed here.

The erosion/re-deposition patterns of sputtered metal atoms deposited onto a graphite DiMES sample, as described above, (see Fig. 43) [109, 494, 548] and on similar probes inserted into the SOL plasma of JET [836] and TEXTOR [490] have been successfully modelled by Brooks et al., and Naujoks et al., using sub gyro-orbit transport codes (WBC [834], ERO [792]), with generally good agreement. Thus, there is reasonably good confidence in the predictive value of the erosion codes for metal surfaces. In general, beryllium and carbon exhibit longer transport distances compared with those of high-Z metals. The DiMES and TEXTOR results indicate that the near-surface transport of the sputtered high-Z metals is highly determined by ionisation lengths and sheath acceleration of the ions. In addition, local radial electric fields have to be considered, which can tilt significantly the re-deposition pattern with respect to the magnetic field lines due to ExB forces [490].

Preliminary comparisons of model predictions with experimental tritium retention measurements in TFTR and JET, with a carbon limiter and divertor, respectively, were made to determine the retention mechanisms during the discharge. The step from single-shot erosion/deposition calculations to the net global re-deposition is a complex issue that requires knowledge about the relative frequency of characteristic discharge regimes and the effect of off-normal events. For TFTR a set of representative high-power discharges of known frequency, were analysed, and the BBQ Monte-Carlo code of Hogan [327, 833, 843] used to extrapolate to the global retention. These calculations suggested that known erosion mechanisms (e.g., physical sputtering, chemical erosion and RES), were sufficient to account for the order of magnitude of retention due to co-deposition [201] and predicted that 'when detailed

analysis of TFTR tiles from the tritium campaign is made, significant concentrations of co-deposited tritium will be found near the upper and lower leading edges of the bumper limiter.' This pattern was not expected from previous deuterium measurements [488] or earlier modelling [563]. These predictions were borne out by subsequent observations [566].

As mentioned, much less net-erosion data and model validation exist for carbon in detached and partially-detached regimes, where plasma temperatures are below 10 eV. This is critical for carbon where the principal sputtering mechanism changes from physical to chemical erosion via emitted hydrocarbon molecules, and their dissociation, ionisation and transport are strongly changed since electron temperatures are near or below the critical values for ionisation. In this regime dissociation of hydrocarbon molecules into neutral fragments (Sect. 4.3.1) may contribute significantly to local re-deposition. Using a newly developed atomic and molecular data set for methane and higher sputtered hydrocarbons, REDEP/WBC modelling [552, 838] predicts that prompt re-deposition efficiencies will decrease significantly (e.g., from near 100% to about 90%) for fully-detached plasma conditions. This would result in increased net chemical erosion and associated co-deposition, depending, however, on the magnitude of the chemical sputter yields to begin with.

Detached plasma carbon chemical erosion data appear to yield contradictory results. Experiments on JET with detached plasma conditions show very little C-II emission, less than calculated with carbon emissions from chemical sources during detachment [110]. Also, detached divertor plasmas in DIII-D caused no net erosion and the observed intensity of CD molecular optical emission was weak [591]. These data suggest that local re-deposition might remain efficient, and/or boron affected the results, or other possibilities. However, there were very large carbon deposits on the inner louver region of the JET divertor, and a correspondingly high amount of trapped tritium, such data tending to imply much higher erosion of carbon than expected. This is discussed further below.

Most divertor experiments show greater deposition at the inner target than at the outer target (as discussed in Sects. 4.3 and 4.7) [63]. This asymmetric erosion/deposition is in part due to a lower plasma temperature at the inner target, and a tendency for detachment to occur first at the inner target. An extreme example of this asymmetry is in JET with the Mk-IIA divertor, where, as mentioned, heavy deposition was found at cold louvers beyond the inner divertor corner (Sect. 4.7) with no such effects at the outer divertor.

The peak net erosion rate obtained for the CFC plate of the outer (attached) divertor leg on JET [110] was  $\approx 24 \text{ nm}\cdot\text{s}^{-1}$  ( $75 \text{ cm}\cdot\text{burn}\cdot\text{year}^{-1}$ ) at  $5 \text{ MW}\cdot\text{m}^{-2}$ . This erosion rate (strike-zone) was modelled using the two-dimensional Monte-Carlo impurity modelling code of Stangeby et al., DIVIMP [831], and a good match to JET data is obtained if chemical sputtering is included [844].

This JET asymmetry and the absolute magnitude of the carbon deposition ( $\approx 4\%$  of the total ion fluence to the inner divertor leg) is not correctly modelled by DIVIMP or REDEP/WBC using "conventional" values of low-energy chemical sputter yield ( $\approx 1\%$  C/D), sticking probabilities and other parameters. Agreement between observed deposition and DIVIMP modelling was achieved by including three additional mechanisms, which alter deposition patterns in JET by more than an order of magnitude [841]. These mechanisms

are: (i) drift in the SOL as has been observed in JET, (ii) additional interaction with the main chamber wall, and (iii) enhanced erosion of the re-deposited carbon films at the inner target.

The first required mechanism, drift in the  $\nabla B$  direction in the SOL, has been observed in JET [28, 29, 845] and in JT-60U [30]. Drifts peaking at velocities of half the sound speed have been measured in JET, as shown in Fig. 86. Some possible mechanisms have been proposed for these large drifts [29], but these do not fully explain the data, particularly the reversal of the flow direction when  $\nabla B$  is reversed. Regarding enhanced erosion of the re-deposited carbon films, there is speculation that sputtering rates for re-deposited carbon in tokamaks may be an order of magnitude greater than laboratory measurements of carbon chemical sputtering yields [291] (see also Sect. 3.2.6.4). On the other hand, as discussed in Sects. 3.2.1 and 4.3.1, there is speculation that a flux dependence could lower chemical sputtering yields.

*Insert Fig. 86*

Another key issue is sticking/reflection coefficients of re-deposited carbon/hydrocarbons. High sticking coefficients will obviously tend to minimise erosion, whereas high reflection will have the opposite effect. The key impingement energy range of interest is from about 1-10 eV. There is unfortunately both very limited data and theory for this range. Laboratory data of Von Keudell et al. [512] has shown low sticking probabilities for some hydrocarbons, but these measurements are at thermal energies only. The extrapolation or relevance of thermal data to 1 eV or higher impingement energies is uncertain. Deposition probabilities for injected  $^{13}\text{C}$  labelled methane through a TEXTOR limiter into a 35 eV plasma at  $2 \times 10^{18} \text{ m}^{-3}$  appeared to be only about 5%. This value is significantly smaller than the 60% predicted at these conditions by Kirschner et al., using the Monte-Carlo impurity transport model ERO-TEXTOR [490, 837], based originally on the Naujoks ERO code. The reason for the discrepancy is unclear, but it may, for example, be due to low sticking of deposited carbon, and/or enhanced chemical sputtering.

Von Keudell [512] has also demonstrated high break-up rates for certain hydrocarbon molecules (especially of the form  $\text{C}_2\text{H}_x$ ) in some temperature regions relevant to tokamaks. These species can be transported large distances away from the reaction zone, as is necessary to reach the louvres in JET. This process may also account in part for the formation of deposits under the divertor structure in ASDEX-Upgrade [551, 523]. There is currently underway modelling work using, for example, molecular dynamic simulations, to study the carbon/hydrocarbon reflection issue. Overall erosion modelling work is continuing using, e.g., REDEP/WBC to examine above mentioned mechanisms and additional mechanisms to further explain JET data.

### 5.3.2. Erosion lifetime and tritium co-deposition inventory analysis for ITER

The erosion lifetime and tritium co-deposition for the divertor target of the ITER device has been modelled by Brooks and colleagues, over many years, for various divertor materials, using two-dimensional profiles of plasma parameters for various regimes, and

temperature-dependent hydrogen retention data. A summary of the results obtained with the REDEP/WBC code is shown in Table 19.

*Insert table 19*

For these studies, details of the analysis for a “high-recycling” plasma solution are given in Refs. [153, 552, 846], and references therein. Because of the resulting high heat loads on the divertor plates, this regime of operation was not deemed desirable for ITER. However, for other devices and possibly ITER as well, high-recycling regimes with lower heat loads could possibly be achieved, e.g., by enhancing core radiation. Trends shown in Table 19 should apply to most devices. These trends, for the high-recycling, and radiative (with enhanced SOL radiation but without full detachment) regimes, are high net erosion rates for the low-Z materials, and low rates for tungsten.

Of primary interest for ITER, as mentioned, are the results of erosion/co-deposition analysis for partially-detached conditions. Plasma parameters and fluxes along the outer divertor plate for the plasma solution calculated for the 1998 ITER design [3, 153] are shown in Fig. 87. The plasma density, temperature, heat flux, and various particle fluxes along the outer divertor plate of the ITER carbon divertor vertical-target are shown. The partially-detached plasma is in part created using a  $\approx 1\%$  neon impurity to radiate much of the incoming power from the plasma core to the boundary. This radiated power is much less spatially peaked than power flowing to the divertor by particle transport. As shown in Fig. 87 there is a rough division between an attached plasma zone of width  $\approx 70$  cm with temperatures  $\approx 3\text{-}30$  eV, and a  $\approx 20$  cm detached zone of  $\leq 3$  eV with high density near the separatrix. Similar conditions are also found for ITER-FEAT [157]. Due to the high density, particle fluxes - including a non-thermal (“fast”) molecular flux - are high in the detached portion. The divertor geometry and the corresponding plasma solution and detailed neutral flux calculation results [153] are incorporated into the REDEP and WBC codes to compute gross and net erosion rates along the divertor, core plasma contamination, and tritium co-deposited with carbon both on the plates and adjacent regions.

*Insert Fig. 87*

From these studies, it was found that: (1) carbon chemical sputtering in the detached region along each plate is the main source of net carbon erosion and tritium co-deposition, (2) physical sputtering of the entire plate contributes about 20% to the co-deposition, (3) chemical sputtering in the attached regions has essentially no contribution to net erosion (due to  $\approx 100\%$  re-deposition), (4)  $\approx 75\%$  of growth/co-deposition occurs on the bottom of the divertor vertical target, and  $\approx 25\%$  occurs in the private flux region. Various plasma parameter sensitivity studies were performed for the co-deposition calculations, as discussed further in Refs. [153, 157]. Both beryllium and tungsten sputtering occur primarily or entirely along the attached part of the target. The predicted divertor net erosion rates for partially-detached conditions are very low for tungsten, and high but marginally acceptable for beryllium and carbon.

Tritium co-deposition with sputtered carbon represents a formidable challenge for ITER (Sect. 2.3.3). Unless this retention can be drastically reduced without significant interruptions in operation, then it is not practical to use carbon as the divertor material in ITER. A further review of tritium co-deposition modelling is given in Ref. [847].

Erosion and tritium co-deposition in beryllium sputtered from the wall and re-deposited on the wall and/or divertor has been computed by several authors (see for example Refs. [153, 157, 848]). Using worst-case (coldest) surface temperatures for the critical beryllium deposition zones of  $\approx 500$  K, tritium co-deposition rates for beryllium are estimated by Brooks et al. to be  $\approx 0.1$  g/pulse, using low-oxygen-content Causey et al. H/Be trapping data [469], or  $\approx 0.6$  g/pulse, using "carbon-corrected" Mayer et al. data [470]. In either case the wall-derived T/Be co-deposition is less than that from carbon sputtering in the divertor. The reason for this is (1) the quantity of beryllium eroded from the first-wall by the charge-exchange flux is less than the carbon eroded at the divertor (as predicted for the partially-detached regime), and (2) the hydrogen trapping fraction in Be is less than in carbon.

#### 5.4. Modelling Erosion during Off-Normal Events

Erosion damage of PFCs in a next-step device during ELMs and off-normal events (e.g., disruptions, VDEs, runaway electrons, etc.) represents a major concern for component survivability and lifetime. These events are anticipated to cause surface damage and high erosion losses due to surface vaporisation, cracking and spallation, and melt-layer loss. Besides surface damage effects, plasma instabilities of longer duration such as VDEs, or those that deposit energy more deeply (e.g., runaway electrons) can produce significant bulk effects. These include large temperature increases in the armour and heat-sink/structural materials and at their interface, causing high thermal stresses, possible structure melting, and material fatigue and failure and high-heat-flux levels in coolant tubes. The result may be coolant burn-out of the tubes (see glossary), leading to significant down times for repair and maintenance. The characteristics of ELMs and off-normal events expected in a next-step device are described in Sect. 2.3.2, while the underlying physical erosion processes are described in Sect. 3.4.

##### 5.4.1. Modelling approach and validation

To correctly study the aspects of plasma disruption damage and disruption simulator physics, self-consistent models are needed that integrate the thermal evolution of a PFC, as well as the physics of plasma-vapour interactions in a strong magnetic field, and multidimensional magneto-hydrodynamic and photon radiation transport. Several models of disruption plasma/vapour/material interactions have been reported [356, 361, 362, 368, 620, 623, 849–859]. The models included in the HEIGHTS package by Hassanein et al., [363] integrate several models self-consistently. These include a model for the SOL behaviour during a disruption, a model for plasma interaction with the target material and the developed vapour cloud, and a model for heat transport within the material and mass losses due to various erosion mechanisms. The HEIGHTS package [860] is used to predict the erosion lifetime

of PFCs for next-step devices (discussed below). The lifetime predictions largely depend on the uncertainties in the duration of the thermal and magnetic energy quenches and the distribution of the deposited energies onto the divertor and first-wall surfaces, and in the magnitude of melt-layer loss, and for carbon, the role of brittle destruction.

These codes are being validated against well-diagnosed experiments in disruption simulation facilities (Sect. 4.5). In general, although good agreement is found for some of the cases analysed, there are cases where the discrepancies are still significant and need to be resolved (Sect. 6.1).

#### 5.4.2. Erosion during a disruption thermal quench

In ITER device, about  $10\text{--}100\text{ MJ}\cdot\text{m}^{-2}$  will be deposited on the divertor plates, during the disruption thermal quench, in a time of the order of 1 to 10 ms (Sect. 2.3.2). This corresponds to a heat flux greater than  $10\text{ GW}\cdot\text{m}^{-2}$ . These thermal loads are an order of magnitude larger than in present tokamaks and prediction of effects must therefore proceed via codes validated against dedicated simulation experiments.

The above models predict for ITER that of the order of several  $\mu\text{m}$  per disruption could be lost from carbon and tungsten due to vaporisation, and that melt layers up to few hundreds of  $\mu\text{m}$  would form for metals (see Table 20).

Fig. 24 in Sect. 3.4 shows the typical time evolution of a tungsten surface temperature, melt-layer thickness, and vaporisation losses during a disruption for an incident plasma energy of  $10\text{ MJ}\cdot\text{m}^{-2}$  deposited in a disruption time of 1 ms as predicted by the A\**THERMAL-S* code [363]. Based on these results, for a disruption energy density of  $\approx 10\text{ MJ}\cdot\text{m}^{-2}$  and a disruption time of 1 ms, the calculated vaporisation and melting thickness for a tungsten plate are about  $2\ \mu\text{m}$  and  $180\ \mu\text{m}$ , respectively. The lifetime for a metal target strongly depends upon the fraction of melt layer lost per event. A sacrificial depth of 20 mm of C would then lead to a lifetime of  $>500$  disruptions, due to vaporisation alone (i.e., without including erosion from brittle-destruction, whose quantification is uncertain), or a lifetime of 130 to 430 disruptions for W if 50% or 10% of the melt layer is lost for W, for the above disruption energy density and duration. Table 20 gives calculated thickness of vaporised or melted layers for W, Be and C.

*Insert table 20*

*Ref. [861] appears in the caption of Table 20 and is included here for keeping a consistent sequential numbering of references in the text, while leaving figures and tables at the end of the section.*

It has also been found that, depending on the divertor configuration and design, the transport and deposition of the radiation, generated from the primary vapour cloud, can be high enough to cause severe melting and erosion of nearby components. The vapour cloud developing on the front of the surface of the nearby component may not be as effective as the primary cloud in protecting adjacent components due to strong vapour diffusion losses, vapour-cloud optical properties, and geometrical effects [168].

#### 5.4.3. Erosion during ELMs

ELMs deposit a few percent of the core plasma total thermal energy onto the divertor plate in a time of 0.1-1 ms. The energy density of an ELM in current tokamaks is too low to cause damage. However, in ITER the energy density deposited by ELMs will be an order of magnitude higher, and surpass the most severe disruption in current tokamaks. ELMs are expected to occur at a frequency of about one per second during high confinement plasmas in ITER (see 2.3.2.3, Table 4 and Table 5). Damage to the divertor plate due to ELMs is therefore a serious concern for ITER.

Material response calculations shown in Fig. 88 give the number of ELMs that will erode a 20 mm thick carbon target and a 10 mm thick tungsten target (assuming no loss of melt layer). The ELM frequency varies inversely as the ELM energy. Assuming that Type-I ELMs transport about 20% [13, 171] of the power crossing the separatrix, that the resulting 18 MW is deposited on 7 m<sup>2</sup>, and that the plates are to withstand 2000 plasma pulses each lasting 400 s, the product of ELM number and energy,  $N^*E$ , is at least  $2 \times 10^6$  MJ·m<sup>-2</sup>. For 0.1 ms to 1 ms duration, the resulting maximum allowable ELM energy density (see intersection of  $N^*E$  with ELM erosion in Fig. 88) is 0.22 to 0.64 MJ·m<sup>-2</sup> for carbon and 0.54 to 1.6 MJ·m<sup>-2</sup> for tungsten. To avoid melting of tungsten the ELM energy density must be less than 0.37 to 1.17 MJ·m<sup>-2</sup> for tungsten. The expected ELM amplitude according to one Type-I ELM scaling [13] is 2% of the stored energy, yielding 1.1 MJ·m<sup>-2</sup> in ITER. Therefore, tungsten divertor target plates are unlikely to survive a large number of shots for ELM duration shorter than 1 ms. Methods to lower deposited energy density from ELMs are therefore essential for the divertor target plate to survive a large number of shots.

*Insert Fig. 88*

*Ref. [154] appears in the caption of Fig. 88 and is included here for keeping a consistent sequential numbering of references in the text, while leaving figures and tables at the end of the section.*

#### 5.4.4. Effects of longer plasma instabilities and runaway electrons

Because of their short duration (< 10 ms), ELMs, and disruptions have no significant thermal effects on structural materials and coolant channels. In contrast, plasma instabilities such as VDEs (duration 100-300 ms), and runaway electrons, in addition to causing severe surface melting and erosion, can result in substantial bulk damage to these components. Elevated temperatures and high thermal stresses in the structure can seriously degrade the integrity of the interface bonding, and burn-out the coolant channels. Runaway electrons (up to many MeV) penetrate many centimetres of graphite and directly heat underlying metal structures [862-865]. Disruption mitigation techniques that address the runaway electron issue are described in Sect. 2.3.2.4.

The erosion due to VDEs in a device like ITER has been modelled by various authors, [138, 361, 866, 867], whereas the results of analysis done to quantify the effects on PFCs resulting from runaway electrons can be found in Ref. [868]. As an example, Fig. 89 shows the temperature of a copper surface at its interface with tungsten, beryllium and carbon



tiles of 10 mm thickness, over the 5 mm copper substrate during a typical VDE releasing to the surface about  $60 \text{ MJ}\cdot\text{m}^{-2}$  in 300 ms [361, 866]. For ITER conditions, the tile thickness is determined by the surface temperature limitations during normal operation. Tungsten and carbon armours of similar thickness usually result in similar and higher copper surface temperature than that of beryllium armour of the same thickness. This is because most of the incident plasma energy is removed by the beryllium's higher surface vaporisation rate, which leaves little energy to be conducted through the structural material [361]. In order to reduce the temperature at the copper interface, thicker tiles would be required. Only beryllium tiles of reasonable thickness (<5-10 mm) or very thick carbon or W tiles (>20 mm) can withstand the acceptable temperature rise in the copper structure for the conditions shown.

*Insert table 21*

*Insert Fig. 89*

## 5.5. Modelling of Particle-Wall Recycling

### 5.5.1. Modelling approaches

In this section we consider models of particle-wall recycling in tokamaks. The detailed processes involved and the effects of hydrogen recycling at the walls are discussed in Sect. 3.5 and 4.6.3, respectively. We will discuss three categories of particle wall recycling models: (i) global models - these lack a detailed description of the plasma and wall, but can be written in analytic terms and are particularly useful in dealing (in an empirical way) with time-dependent phenomena; (ii) refined plasma-edge models - these use a sophisticated treatment of the edge plasma and simple descriptions of the wall properties; and (iii) refined wall models - these take the opposite tack, with a sophisticated treatment of the wall, and a somewhat simplified description of the plasma.

#### 5.5.1.1. Global modelling

This approach links the plasma density response to the wall uptake under external fuelling. The method lacks a detailed description of the plasma, and a number of complex physical processes are described by simplified model parameters. However, the calculations become analytically tractable, and this approach is particularly suitable for dealing with time-dependent plasma discharge phenomena. The results of these calculations provide some insight into the governing processes involved, and also quantitative results on global parameters such as the global particle recycling coefficient (see glossary), the fuelling efficiency, and also specific material-related properties. Examples and applications of this approach can be found in Refs. [645, 646, 869, 870] and are described in Sect. 4.6.3.

Global modelling of recycling is usually based on particle-balance models, in which the particles are assumed to be distributed between different regions. A *multi-reservoir* model distinguishes between several regions, or reservoirs, i.e., (i) the plasma core, bounded by the LCFS, (ii) the plasma SOL, and (iii) the material surfaces surrounding the plasma. The

evolution of the particle distribution in each reservoir is governed by the physics of particle-exchange processes, which are in turn affected by particle transport in the plasma and in the materials, respectively.

The basic elements of the global model are described in Ref. [646]. In the model, the particles leave the plasma and encounter the material surfaces of the first-wall after an average confinement time,  $\tau_P$ . The particle-balance model can be written in its simplest form for a closed system (after fuelling and pumping has been switched off) as:

$$\frac{dN_p(t)}{dt} = -\frac{N_p(t)}{\tau_p} + R(t) \cdot \frac{N_p(t)}{\tau_p} \quad (30)$$

where  $N_p$  is the total plasma particle (electron) inventory and  $\tau_P$  is the global particle confinement time.  $\tau_p$  depends on plasma transport and the particle source distribution in the plasma. The quantity  $N_p/\tau_P$  represents the total plasma particle flux from the plasma to the surfaces and  $R \cdot N_p/\tau_P$  is the total particle flux from the surfaces back to the plasma.  $R$  is termed the global particle recycling coefficient and includes different kinds of particle release from the surface (re-emission, reflection, etc. [646]). The global recycling coefficient is an average over many recycling processes at various surfaces inside a tokamak. In particular, if the wall pumping capability is very small,  $R$  is close to 1 and the particle flux from the plasma is almost all recycled. For a non-recycling species,  $R$  is not precisely known and depends on the wall particle-trapping physics. For a more detailed analysis, the effect of the different surfaces in the tokamaks (limiter, divertor, wall) have to be taken into account individually.

A straightforward improvement of eq. (30) is to introduce a wall reservoir interacting with the plasma [869]:

$$\frac{dN_p(t)}{dt} = -\frac{N_p(t)}{\tau_p} + f_r \cdot \frac{N_p(t)}{\tau_p} + \frac{N_w(t)}{\tau_w} \quad (31)$$

$N_p$  and  $\tau_P$  are defined above;  $N_w$  represents the total hydrogen content in the wall surface,  $\tau_W$  is the global particle confinement time in the wall. In this model, the flux out of the wall back into the plasma consists of two terms. The prompt term,  $f_r N_p/\tau_P$  is the recycling flux, and is proportional to the plasma efflux, which is kinematically reflected and desorbed. The slow term,  $N_w/\tau_W$ , represents diffusion/recombination in the wall (Sects. 3.5 and 5.6). The essence of the slow part is embodied in the global residence time in the wall,  $\tau_W$ , defined in the same way as the global plasma particle confinement time is defined; thus,  $\Gamma_W A_w = N_w/\tau_W$ , where  $\Gamma_W$  is the spatially averaged flux out of the wall into the plasma, and  $A_w$  the wall area. One difficulty here is to define clearly what walls are involved.

More sophisticated treatments of the wall reservoir, which include multiple reflection and screening (non-fuelling) processes, are available [646, 870]. In Ref. [871], fast and slow reservoirs are used to explain the two different time constants observed in the rate of change-over from one isotope to another. However, increasing the number of reservoirs leads to a greater number of independent parameters whose experimental characterisation is often difficult. In this case, the simplicity of the original model disappears.

5.5.1.2. *Refined plasma-edge modelling*

In these models the interaction between the plasma and the neutrals recycled from the wall is described by a combination of plasma fluid models (described in Sect. 5.2) or *ad-hoc* simplifications to describe plasma transport in the core and edge regions, together with a multi-species Monte-Carlo neutral transport code. The models calculate the spatial distribution of charge-exchange neutral fluxes and energies spectra to the wall.

These models treat the main working gas, (i.e., hydrogen species such as D, T, D<sub>2</sub>, DT, T<sub>2</sub>), as well as the prominent intrinsic or extrinsic impurities. They give information on the density and temperature distribution of the edge plasma, which affect plasma processes such as the production of energetic charge-exchange neutrals, the plasma power deposition at the divertor target plates, the impurity generation and retention in the divertor plasma. However, in these models the interaction between particles and material surfaces is not explicitly calculated, and an *albedo* parameter is often simply assumed to describe the phenomena at the surface (e.g., recycling coefficient, sticking probability, external pumping, etc.) [872]. These *ad-hoc* coefficients have a significant effect on model predictions, and in some cases can only be derived from other quantitative and testable models (see below). An albedo parameter of this kind will depend on the type of material and its temperature, on the H content of the material, and hence on location in the machine and history of operation, and on the energy spectrum of the incident H species.

5.5.1.3. *Refined wall modelling*

In this case, the interaction between material surfaces and the plasma is based on detailed validated models for the dynamic exchange between recycling surfaces and the edge plasma. A predictive model must treat the strongly coupled interaction between the edge plasma and the surfaces of wall regions that comprise the active exchange surfaces. This is very difficult, although initial steps have begun [201, 511]. Most of the models are based on established laboratory values for fundamental wall process rate coefficients, but they often have a somewhat simplified treatment of the plasma [706, 873, 874]. In some cases, the study of the interaction with the wall is solved in isolation from the plasma, for characteristic phases of the discharge. This latter approach has been followed to describe features of wall release in tokamaks after a single or a sequence of discharges; see, for example, Refs. [643, 644, 689, 703, 739, 875].

It has become increasingly clear that recycling phenomena in tokamaks are strongly dependent not only upon several material properties (e.g., temperature, hydrogen content), but also upon the conditions in the SOL (plasma temperature and density, neutral density). A detailed treatment of charge-exchange reactions in the SOL has become an essential component of recent modelling [574, 876]. Indeed, charge-exchange particles determine the saturation characteristics of the wall, because they can access the large wall surface area away from the divertor strike-points [689]. In addition, energetic particles can be deposited deeply in an unsaturated region and be retained in the wall for times much longer than the plasma particle confinement time, before recycling back into the plasma.

Various approaches have been followed to model the interaction of charge-exchange neutrals with the wall and divertor. For example, a model for the implantation range, derived from TRIM [877] is used in the code WDIFFUSE, [873] to relate the mean energies from an EIRENE [824] analysis to the implantation range for each surface element. In Ref. [873], the one-dimensional SPUDNUT code has been used [878] to calculate the energy distribution of charge-exchange neutrals, based on measured radial plasma density profiles. In the model described in Refs. [706, 879], the time evolution of the plasma density in the core region is calculated by solving self-consistently a plasma transport equation, where the charge-exchange implantation source is estimated separately from detailed Monte-Carlo calculations [149, 880].

At the wall, deposition, diffusion and emission from the surface can be treated with coupled equations describing the concentrations of trapped and mobile particles [703, 739, 876, 881]. The basic equations for the concentration of mobile,  $C_s$ , and trapped,  $C_t$ , species in the wall can be written as follows:

$$\frac{\partial C_s}{\partial t} = D \left( \frac{\partial^2 C_s}{\partial x^2} \right) + \phi U(0, \Delta_i) / \Delta_i - \gamma C_s^2 - \frac{\partial C_t}{\partial t} \quad (32)$$

$$\frac{\partial C_t}{\partial t} = \frac{1}{\tau_a} C_s \left( 1 - \frac{C_t}{C_{max0}} \right) - \frac{1}{\tau_a} \beta C_t - \sigma \phi U(0, \Delta_i) C_t \quad (33)$$

where  $D$ ,  $\gamma$ ,  $\beta$ ,  $\sigma$  are the diffusion, volume recombination, thermal de-trapping coefficients and particle-induced de-trapping cross-section, respectively.  $\tau_a$  and  $C_{max0}$  are the time constant for the trapping and de-trapping process and the maximum trapped concentration in the wall, respectively. Characteristic numerical values of these constants and coefficients can be found in Refs. [149, 703, 739], where a detailed explanation of these terms is also given. In order to estimate the wall deposition distribution, the energy spectrum of charge-exchange particles is required. Indeed, the estimation of the penetration depth,  $\Delta_i$ , requires the knowledge of the incident energy of the particles, which can be obtained by solving the plasma energy equation. Alternatively, estimates of  $\Delta_i$  can be made from detailed Monte-Carlo calculation of the charge-exchange implantation source [149] for the specific experiments to be analysed. This approach has been followed in Ref. [706].

### 5.5.2. Status of model validation

Tritium experiments on JET and TFTR provided an interesting opportunity to check wall/edge models because the initial tritium fuel was easy to distinguish from the existing deuterium wall inventory. Examples of the use of modelling for data interpretation are given for JET [204, 511, 643–646, 688, 689, 739, 871, 875, 882–884], Tore Supra [688, 703], DIII-D [874, 876], TFTR [33, 201, 566], JT-60 [879], and ASDEX-Upgrade [885]. The Doppler broadened Balmer-alpha spectral line profile was measured on TFTR and compared to Monte-Carlo calculations of neutral hydrogenic velocities. Good agreement was obtained under a range of conditions, validating the treatment of charge-exchange, molecular dissociation, surface reflection and sputtering in the neutral gas code DEGAS [747] although a residual deficiency in  $H_2^+$  dissociation was noted. Out-gassing in JET with all-carbon

walls was successfully modelled by assuming a controlled release of trapped particles from a hydrogen-saturated layer over a large surface of the first-wall, well beyond the main limiter or divertor [689]. A sensitive characterisation of the wall saturation status was obtained by measuring the tritium concentration in the JET sub-divertor during the DTE1 experiments [511]. Wall rate coefficients from the Ehrenberg semi-empirical model [646] were found to give good agreement with the observed tritium recycling. This 'first principles' description of the tritium pathways in JET coupling the wall, divertor and core/wall transport, offers an exciting prospect of a predictive transport model. This work has recently been extended to hydrogen (protium) [886].

Plasma discharges in tokamaks usually start-up in limiter configuration, then, by applying a different current distribution to the poloidal field coils, one achieves a transition to a divertor configuration. This transition often causes a strong decrease of the plasma density, due to the large absorption of particles by the wall, independent of the material of the target plates. Fig. 90 shows the results of experiments in JT-60 where the plasma was moved from the inboard limiter to the outer TiC-coated divertor [887]. A gas puff of  $2 \text{ Pa}\cdot\text{m}^3\cdot\text{s}^{-1}$  was constantly injected up to 7 seconds. During the transition, the plasma density decreases very rapidly due to strong pumping by the divertor plate and side-wall. Further modelling details can be found in Ref. [879].

*Insert Fig. 90*

Similarly, in a large device like ITER, due to the large absorption of particles by the wall, the density drop can be very large and this can cause low density locked-mode disruptions, so that rapid fuelling is needed for proper density control. The requirements for the 1998 ITER design were analysed with the model described in Ref. [706], with feedback control of the fuelling rate. The results are illustrated in Fig. 91 and show that during the transition phase, a fuelling rate of about  $500 \text{ Pa}\cdot\text{m}^3\cdot\text{s}^{-1}$ , as specified in the design, allowed an adequate recovery rate of the density.

*Insert Fig. 91*

Wall models have also been extensively used to interpret/describe out-gassing of hydrogen from the first-wall after discharges. Several studies in tokamaks have shown that the deuterium release rate, as a function of time after a discharge,  $t$ , can be described by a power law proportional to  $t^{-n}$  with  $n \approx 0.5-1.0$  [644, 689, 888-891]. Ref [689] shows how such a relation may be derived from eqs. ( 32) and ( 33) for trapped and solute atoms and how the out-gassing rate can decrease by orders of magnitude while the concentration in the material only varies by a factor of 2.

Hydrogen transport/retention processes in graphite have also received a great deal of attention (see for example [892]) and a large number of models have been proposed, based for the most part on laboratory scale experiments for basic rates. However, wall recycling data are scarce for other materials like Be, W, Mo, which are used to a much lesser extent than carbon in existing tokamaks, but are being considered as promising candidates for wall protection in a next-step device. The increased wall pumping effect observed in JET,

upon incorporation of beryllium, is understood to be due to a larger number of empty traps becoming available before the next discharge due to an enhanced out-gassing between discharges. However, that model [689] does not explain quantitatively the pumping behaviour of the JET walls during discharges. To explain the long-term build up of hydrogen isotopes in the first-wall and divertor, it is necessary to include the effects of diffusion of hydrogen into the bulk of the material, and co-deposition. An interesting observation is that the more the discharges load up the wall with particles, the higher the out-gassing rate becomes, particularly at longer times ( $>100$  s). As suggested by earlier studies [893–896], the long-term (more than one discharge) depletion or saturation characteristics can be explained in terms of saturation of surfaces, which are irradiated by energetic neutral particles away from the strike-points. This is caused by outward diffusion of more and more particles that have penetrated into greater depths of the material during the course of the previous plasma discharges.

Because of their particular relevance to next-step tokamak operation, a set of typical long-pulse discharges in Tore Supra [124] were analysed in Ref. [706] to identify the dominant wall pumping mechanisms. This discharge used lower hybrid current drive with a boronised first-wall. The plasma density was maintained almost constant for  $\approx 60$  s even under continuous gas fuelling without external pumping, so that the walls absorbed all of the fuelled particles. Two plausible mechanisms of enhanced particle absorption were included in the model: (i) diffusion with adsorption along the inner surfaces of the wall, and (ii) co-deposition. The former mechanism had been suggested for the case of a boronised wall to explain the enhanced particle release after the shot [888]. Co-deposition was considered only for the limiter. Fig. 92 shows the results of the calculations. The effective diffusion coefficient for the regions of the limiter and first-wall and the initial particle concentration in the wall were selected to reproduce the experimental observations. Although the results of the calculations are close to the experimental data, further quantitative examination of the role of diffusion/co-deposition is necessary to draw firmer conclusions on the actual loss mechanisms (Sect. 6.3).

*Insert Fig. 92*

## 5.6. Modelling of Long-Term Implanted Tritium Inventory/Permeation

Accurate estimates of the long-term accumulation of tritium on the surfaces and in the bulk of the materials of the PFCs in a next-step devices are required for determining the tritium supply requirements, for assessing the radiological hazards from routine operation and from potential accidents. The degree of tritium permeation to the coolant is also important for the design of the water detritiation system.

### 5.6.1. Modelling approaches

This section describes models for estimating permeation, retention, and re-emission of hydrogen-isotopes from materials exposed to fusion plasmas. The underlying mechanisms of transport and retention of hydrogenic species in plasma-facing materials currently considered

as primary candidates for ITER are reviewed in Sect. 3.5. The modelling of co-deposition is discussed in Sect. 5.3. The modelling of recycling of hydrogenic species at the wall of tokamaks is discussed in Sect. 5.5.

Models for the retention of hydrogen isotopes in the implantation layer of graphite and C-based materials (Sect. 3.5 and Fig. 32) have shown a good fit with experimental data (see Fig. 34 and Fig. 35 and Refs. [440, 444, 450, 462, 881, 897]). However, while this saturated region contributes very strongly to recycling and plasma density control in tokamaks (Sect. 4.6), its hydrogen retention capacity and contribution to the overall inventory is rather small. Modelling of mechanisms of tritium retention inside the geometrical surface of graphite and C-based materials, e.g., on pore surfaces and bulk is still meagre. The models described in Refs. [450, 898], for example, analyse the kinetics associated with the migration of hydrogen isotopes diffusing along the pores and adsorption onto pore surfaces. Much like the saturated layer, the tritium retention on graphite pore surfaces is fairly limited and the overall effect of the porosity on the tritium retention in a device of the size of ITER is expected to be fairly small compared to co-deposition.

Although tritium migrates in the bulk of carbon only at elevated temperature ( $T \geq 1270$  K), the presence of pores allows the tritium gas to rapidly enter the graphite, effectively exposing all of the inner porosity to an equal gas pressure, and, therefore, is not necessary for the tritium to diffuse from the geometrical boundary inward. Success in modelling the uptake of tritium in the bulk of graphite has been obtained [447] assuming each of the graphite grains to be surrounded by the gas.

Models for estimating hydrogen diffusion, retention, and re-emission for metals follow similar approaches and are based on physical mechanisms, which are described in Sect. 3.5 and Refs. [374–377, 899]. The main physical processes are illustrated in Fig. 25. Hydrogen atoms in solution diffuse through the metal lattice and can be bound at traps within the matrix. These traps are characterised by a concentration and a binding energy of hydrogen to the trap. At interfaces between the host structure and gas or vacuum regions, most models assume recombination takes place either with other diffusing atoms (second order) or with other populations of atoms (other hydrogen, oxygen, etc., first order). A solution law such as Sieverts' law or Henry's law may also be invoked if the hydrogen in solution and gas phases are in thermodynamic equilibrium. Implantation is usually treated as a localised or distributed volumetric source. Retention of implanted hydrogen saturates when the hydrogen mobility is low, causing accumulation of high hydrogen concentrations. This occurs in carbon and in metals at low temperatures (Sect. 3.5). In metals, the hydrogen eventually precipitates into bubbles, and the bubbles grow and interconnect to form channels for rapid release. This limits the driving potential for diffusion deeper into the layer, restricting the total inventory and permeation rate (see curve (2) Fig. 25).

Codes that follow this approach include PERI [900], DIFFUSE [422], PIDAT [423], and TMAP4 [901]. TMAP4 also includes heat transfer, fluid flows, and chemical reactions in other than the solid state. Other codes such as BETTY [902] and ANFIBE [425, 903], were developed for beryllium. While using the same solid-state transport equations, they include bubble formation, which has recently been recognised as a significant process for many

materials at high plasma flux densities.

The codes used for modelling the interaction of hydrogen isotopes with materials often do not adequately include the phenomenon of saturation. TMAP4 uses temperature dependent expressions for hydrogen diffusivity, saturation concentration and surface recombination parameters, which reproduce the observed saturation behaviour for hydrogen retention in metals [427, 904].

A further consideration, at least for beryllium in tokamak applications, is the production of helium and tritium by neutronic transmutations in the beryllium itself. This has been observed experimentally in thermal and fast fission reactor testing, and fairly reliable calculations have been made for representative fusion applications [905, 906]. A major outstanding issue for most materials, especially Be, is the influence of neutron damage on trapping. The ANFIBE code [903] has addressed this issue with some success. Tritium production is a concern for safety reasons, and helium is important because it can influence the retention of tritium and it causes swelling of the material. There are two important pathways for gas production. One is the  $(n,2n)$  reaction in which the  $^9\text{Be}$  is reduced to  $^8\text{Be}$ , which then splits into two  $^4\text{He}$  atoms. The second is the  $(n,\alpha)$  reaction where the  $^9\text{Be}$  absorbs a neutron and then splits to a  $^4\text{He}$  and a  $^6\text{He}$ . The  $^6\text{He}$  rapidly undergoes a  $\beta^-$  decay to become  $^6\text{Li}$ . The  $^6\text{Li}$  then reacts with a thermal neutron to produce  $^4\text{He}$  and  $^3\text{H}$ . These processes are incorporated into the FISPACT code [907], which was used by Forty et al. [905, 908] to estimate gas and other reaction product generation rates in a typical tokamak.

#### 5.6.2. Status of model validation

The computer codes cited above have been used to model several kinds of experiments designed to measure H retention, release and permeation under controlled conditions. There are numerous publications citing instances where the codes and fit parameters have been used to simulate experiments. References [875, 889, 901, 904, 909–917] are representative. Experiments have been performed and modelled on a wide range of potential plasma-facing materials including Be [875, 902–904, 912, 913], C [909], Cu [450, 910], stainless-steel [901], V alloy [910], and W [910, 915–917]. In many cases, a good fit between modelling and data from several experiments is obtained, lending confidence to predictions of the performance of plasma-facing structures in next step devices.

The TMAP4 code with saturation and erosion effects has been used to successfully model a number of past and recent experiments in beryllium [904]. These include Hsu's glow discharge and vacuum out-gassing experiments [918] from which the currently-accepted recombination coefficient for hydrogen on beryllium was derived, implantation experiments with beryllium at elevated temperatures at the INEEL [913], experiments to simulate hydrogen recycling in JET [882], and experiments with beryllium using the Tritium Plasma Experiment (TPE) at Los Alamos National Laboratory [919] (see glossary). Of these, only the INEEL and TPE experiments were at fluences high enough to encounter saturation effects. Fig. 93 shows the results of calculations that were performed with the TMAP4 code to match the results of implantation experiments in beryllium performed in TPE [919]. An expression for Be was found that was successful in replicating laboratory experiments that did not fit other



models [427, 904]. These expressions approach the classical solution (diffusion with surface recombination) in the limit of low fluxes.

*Insert Fig. 93*

When modelling early experiments on tungsten at low implantation fluxes, the classical description was found to be adequate to give reasonable agreement with the experimental results if trapping was properly taken into account. However, in more recent studies at higher fluxes, the classical models do not fit the experimental data and the saturation effect needs to be taken into account in the more refractory materials. As an example, the TMAP4 code has also been used to simulate experiments performed on pure tungsten and on tungsten doped with about 1% of  $\text{La}_2\text{O}_3$  (added to improve fabrication properties) that were exposed to deuterium and tritium plasmas in the TPE and to ion-beam implantation-driven permeation experiments at INEEL [920]. In each case, there was a break point in temperature, above which classical recombination-limited re-emission of implanted ions to the surface, based on literature values for trapping and transport parameters, appeared to be valid [920], and below which classical concepts proved inadequate to model the measured retention. The temperature at which that break point occurred was higher for higher ion flux densities. Analyses [917, 921] showed that these retention profiles, together with deuterium concentration profiles measured by NRA [922], could be reproduced by simply enhancing transport of implanted atoms from the implantation depth back to the surface, a process that appears to be characteristic of saturation and development of near-surface interconnected cracks or porosity. Further work remains to establish the mechanism(s) for this enhanced transport.

### 5.6.3. Implanted tritium inventory analysis for next-step devices

The retention and permeation of implanted tritium in ITER PFCs have been widely studied in the past (see for example [3, 923, 924]). Table 22 summarises the results of T-inventory and permeation calculations conducted with the TMAP4 code for the 1998 ITER design, which are discussed in Ref. [3]. Results for ITER-FEAT are similar and are described elsewhere [924].

*Insert table 22*

Based on the results of these calculations, it can be concluded that the inventory of tritium in the beryllium first-wall of a device like ITER, due to implantation, diffusion, trapping and neutron-induced transmutation, will be on the order of 100 grams rather than the kilogram quantities estimated previously [925, 926], and most of that will result from neutron-induced transmutations in the Be itself and from trapping in neutron-induced traps. As was discussed in Sect. 5.3.2, co-deposition remains the major tritium repository for ITER. A comparison of the rate of tritium accumulation in the beryllium first-wall (with and without neutron effects) and divertor co-deposition, is shown in Fig. 94 for two indicative tritium co-deposition rates of 1 and 10 g/1000 s. In addition, permeation is very low, see Table 22.

*Insert Fig. 94*

**Table 19.** Summary of selected results of divertor erosion and tritium co-deposition analysis of various evolving ITER divertor designs. From analysis of J.N. Brooks et al. (Reference in the table: (1) [846], (2) [552], (3) [153], (4) [157].)

Divertor target material	Design concept/ year	Strike point electron temperature (eV)	Peak gross erosion rate (nm/s)	Peak net erosion rate (nm/s)	Tritium co-deposition rate (mg/s)	References/ Comments
Carbon	"high-recycling" (1989)	150 60 60	61.5 <sup>(a)</sup> 104 <sup>(a)</sup> 317 <sup>(b)</sup>	8.6 <sup>(a)</sup> 7.3 <sup>(a)</sup> 16.5 <sup>(b)</sup>	4.9 <sup>(a)</sup> 2.8 <sup>(a)</sup> 4 <sup>(b)</sup>	(1)
	"high recycling" (1997)	~ 30	346	14.6 <sup>(b)</sup>	2.6 <sup>(b)</sup>	(2)
	"Radiative" (1997)	8 <sup>(b)</sup>	240 <sup>(b)</sup>	5.7 <sup>(b)</sup>	1.3 <sup>(b)</sup>	(2)
	"Fully-detached" (1997)	~1.5	(51-305) <sup>(c)</sup>	(4.4-37.8) <sup>(c)</sup>	(12-106) <sup>(c)</sup>	(2)
	"Semi-detached" (1998)	< 3	158 <sup>(b)</sup>	2.85 <sup>(a)</sup> ~16 <sup>(b)</sup>	2 <sup>(a)</sup> 14 <sup>(b)</sup>	(3)
Tungsten	"Semi-detached" (2000)	< 3	65 <sup>(b)</sup>	6.4 <sup>(b)</sup>	1 <sup>(a)</sup> 5 <sup>(b)</sup>	(4) smaller device
	"high-recycling" (1989)	40	1.3	<0.03	-0	(1)
	"high-recycling" (1997)	~ 30	1.6	<0.003	-0	(2)
	"Radiative" (1997)	~8	<0.2	<0.003	-0	(2)
Beryllium	"Semi-detached" (1998)	<3		<0.0005	-0	(3) sputtering due to trace O content
	"high-recycling" (1989)	60	374	23.1	1	(1)
	"high-recycling" (1997)	~ 30	475	18.7	3	(2)
	"Radiative" (1997)	~8	217	10.1	(2-4) <sup>d</sup>	(2)
	"Fully-detached" (1997)	~1.5 <sup>(b)</sup>	(0-4.4) <sup>d</sup>	(0-4.4) <sup>d</sup>	(0-0.4) <sup>d</sup>	(2)
"Semi-detached" (1998)	<3		9.5	2	(3)	

(a) with physical sputtering only;  
 (b) includes chemical sputtering;  
 (c) range of values computed for possible variations in non-thermal D-T molecule chemical sputtering coefficient;  
 (d) range shown is for variations in He/Be sputter yield and H/Be trapping rate.

Table 20. Vaporisation and melting thickness ( $\mu\text{m}$ ) per disruption event [861].

Material	Tungsten				Beryllium				Carbon			
	10		100		10		100		10		100	
Energy Density $\text{MJ}\cdot\text{m}^{-2}$												
Disruption Time (ms)	vap	melt <sup>(a)</sup>	vap	melt <sup>(a)</sup>	vap	melt <sup>(a)</sup>	vap	melt <sup>(a)</sup>	vap <sup>(b)</sup>	melt <sup>(c)</sup>	vap <sup>(b)</sup>	melt <sup>(c)</sup>
0.1	1.2	63	2.2	68	1.9	28	3.1	35	6.	—	10.	—
1	2.5	186	4.5	212	7.4	80	12.	91	nc <sup>(d)</sup>	—	nc	—

- (a) Only stationary melt-layer thickness (without splashing).  
 (b) Carbon surface vaporisation only - no erosion due to brittle destruction is assumed.  
 (c) Carbon does not melt.  
 (d) Not calculated.

Table 21. Vaporisation and melting thickness ( $\mu\text{m}$ ) per VDE (without any vapour shielding effect) [861].

Material/thick.(mm)	Tungsten/10				Beryllium/10				Carbon/10			
	20		60		20		60		20		60	
Energy Density $\text{MJ}\cdot\text{m}^{-2}$												
Disruption Time (ms)	vap	melt <sup>(a)</sup>	vap	melt <sup>(a)</sup>	vap	melt <sup>(a)</sup>	vap	melt <sup>(a)</sup>	vap <sup>(b)</sup>	melt <sup>(c)</sup>	vap <sup>(b)</sup>	melt <sup>(c)</sup>
100	0.2	450	nc <sup>(d)</sup>	nc <sup>(d)</sup>	140	520	nc <sup>(d)</sup>	nc <sup>(d)</sup>	98	—	nc <sup>(d)</sup>	—
300	-0	-0	105	1370	70	770	530	800	-0	—	150	—

(a) Only stationary melt-layer thickness (without splashing).

(b) Carbon surface vaporisation only - no erosion due to brittle destruction is assumed.

(c) Carbon does not melt.

(d) Not calculated.

Table 22. Summary of tritium inventory and permeation calculated by the TMAP4 code [901] through the PFCs of the 1998 ITER design for the Basic Performance Phase. This does not include tritium inventory due to co-deposition; (Table reproduced from [3].)

Component	Tritium Inventory (g)	Tritium Permeation Rate (g/day) <sup>(a)</sup>
First-wall (impl.+breeding)	106 <sup>(b)</sup>	7.0 x 10 <sup>-4</sup>
First-wall (incl. n-effect)	194 <sup>(c)</sup>	3.4 x 10 <sup>-11</sup>
Startup limiter	9.2 x 10 <sup>-3</sup>	4.7 x 10 <sup>-7</sup>
Upper baffle	0.78	4.4 x 10 <sup>-5</sup>
Lower baffle	0.12	6.5 x 10 <sup>-7</sup>
Upper vertical target	31	8.1 x 10 <sup>-9</sup>
Dome	2.0	1.5 x 10 <sup>-6</sup>
<b>Totals</b>	140 <sup>(b)</sup> /228 <sup>(c)</sup>	7.5 X 10 <sup>-4</sup>

(a) It is assumed that ~10000 pulses are distributed uniformly over 10 years.  
 (b) Breeding is assumed on the basis of 14-MeV neutron current of 1.15 MW·m<sup>-2</sup>, a peak value, as compared with 0.94 MW·m<sup>-2</sup> poloidal average, and calculated production rates for the first-wall; trapping characteristics were those of unirradiated beryllium (0.0005 atom fraction, 0.8 eV trap energy).  
 (c) In addition to breeding, this calculation included neutron-induced traps taken to be 2% atom fraction and 1.4 eV trap energy.  
 Note: Inventory in the bulk of carbon was estimated using the DIFFUSE code and was found to be small ( $\leq 1$  g·m<sup>-3</sup>).

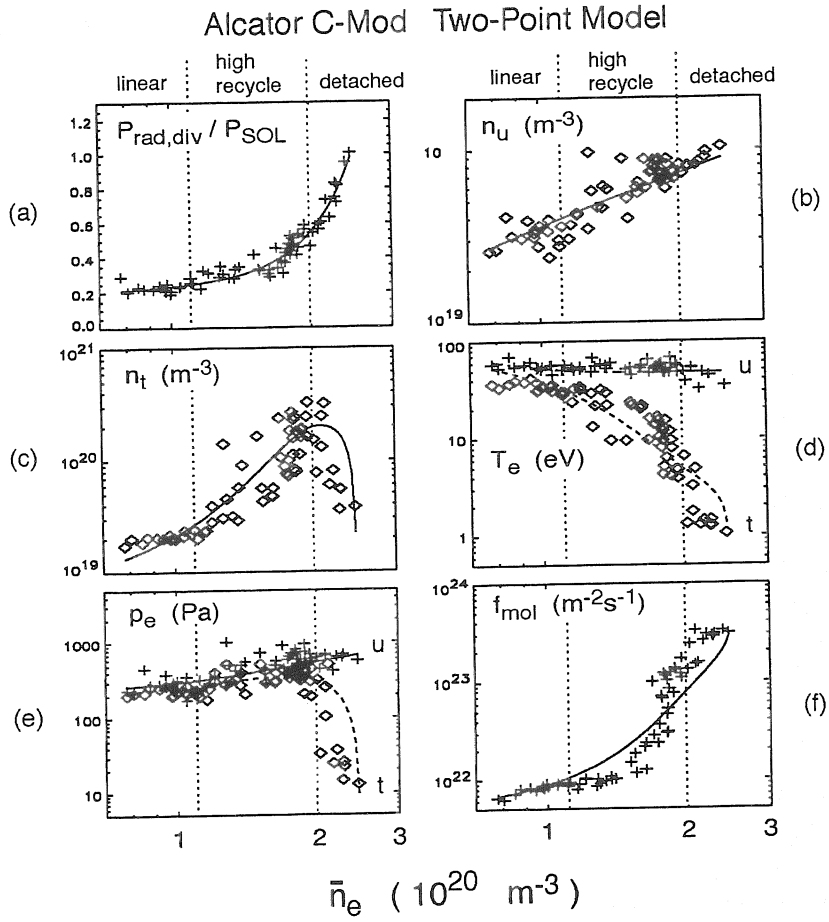

Figure 84. Comparison between SOL conditions as measured on Alcator C-Mod (discrete points) with results from the Two-Point Model with extensions (lines). In the figure 'u' refers to upstream parameters and 't' refers to parameters at the target plate; (reproduced with permission from [802].)

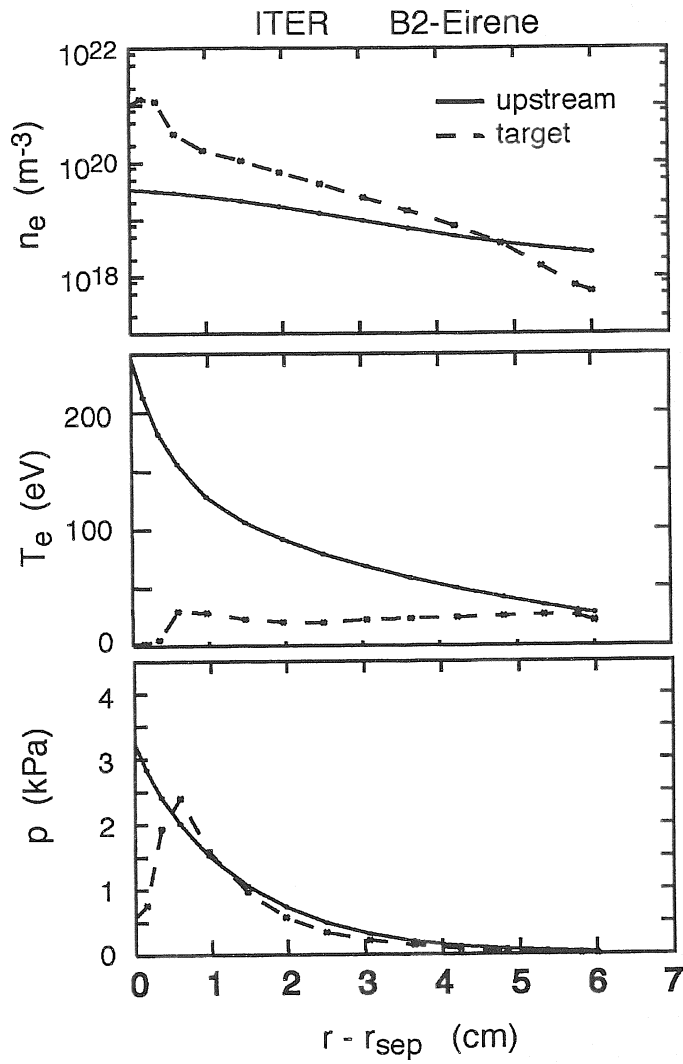

Figure 85. Results from a B2/EIRENE simulation of the ITER edge plasma [829].  $r-r_{sep}$  is the distance from the last closed flux surface (outside mid-plane equivalent); (figure provided by A. Kukushkin, ITER.)

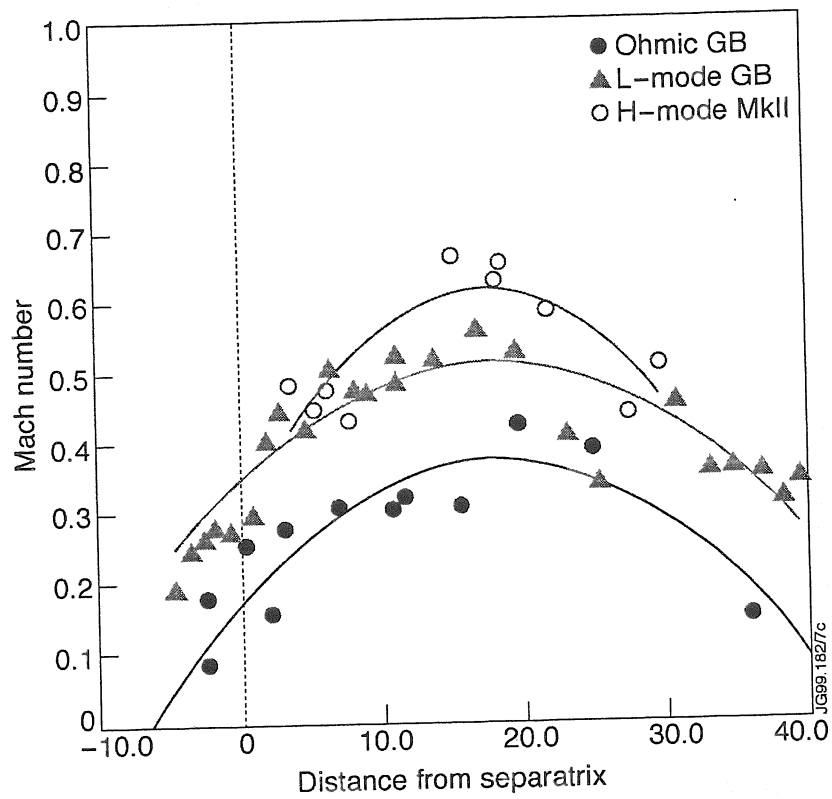

Figure 86. Flow in the JET SOL measured for different types of plasma. Using a Mach Probe on the Reciprocating Probe inserted near the top of the torus; (reproduced with permission from [841].)



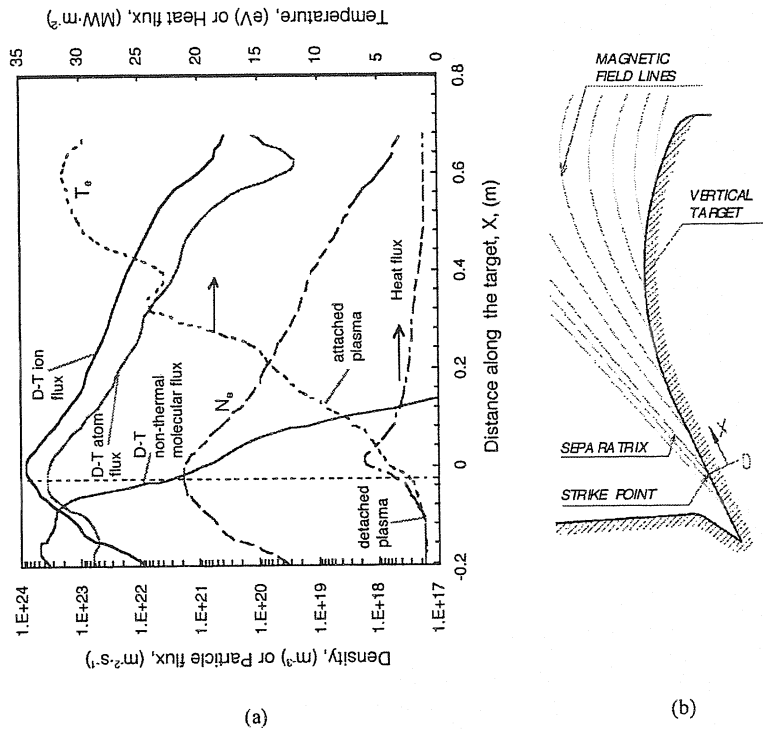

Figure 87. (a) Plasma parameters/fluxes along the ITER divertor outer vertical for so-called 'partially-detached' plasma conditions (see text); (b) ITER divertor outer vertical target. (Part (a) of the figure reproduced with permission from [153].)

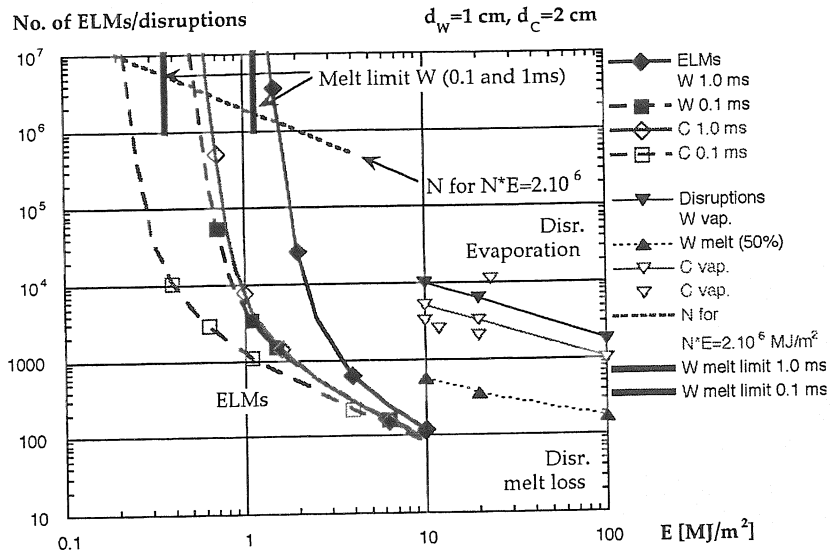

Figure 88. Number of ELMs  $N$  to erode 1 cm of W (solid symbols) or 2 cm of C (hollow symbols) vs. Elm energy per unit area  $E$ , for ELM duration of 0.1 (diamonds) and 1 ms (squares). Melt limit for W is also shown. Disruption evaporation and melt loss numbers with vapour shield (see references in [154]) are shown for comparison. Product  $N \cdot E = 2.10^6 \text{ MJ} \cdot \text{m}^{-2}$  (expected ELM energy deposited in 2000 shots, see text) is also indicated.

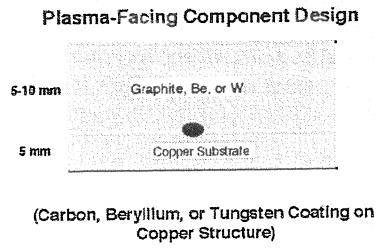
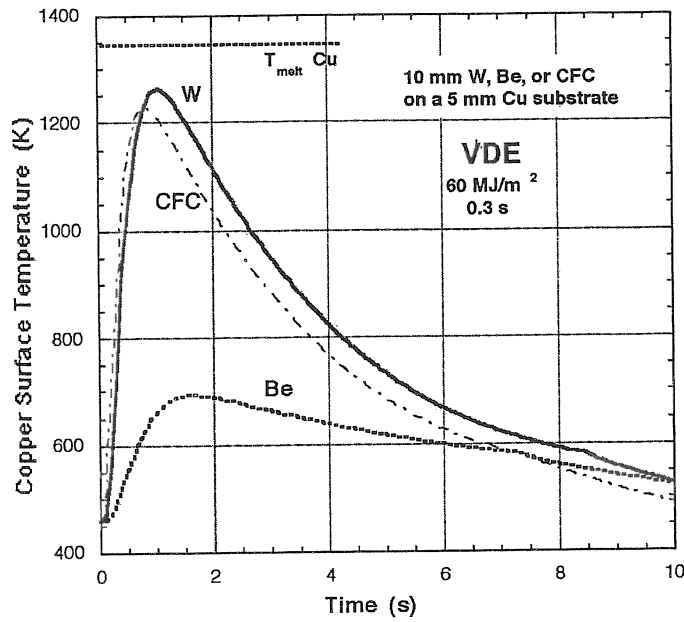

Figure 89. Interface copper surface temperature rise during a VDE for different surface coating materials.

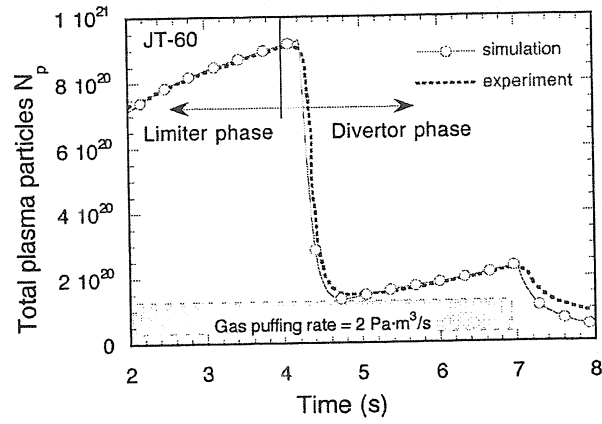

Figure 90. Experiments (solid line) and simulation results (closed circles) for the density behaviour during limiter transition and divertor phases in JT-60; (reproduced with permission from [879].)

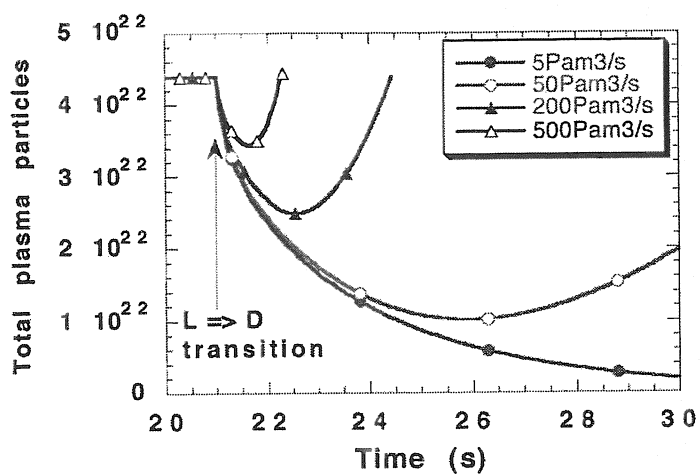
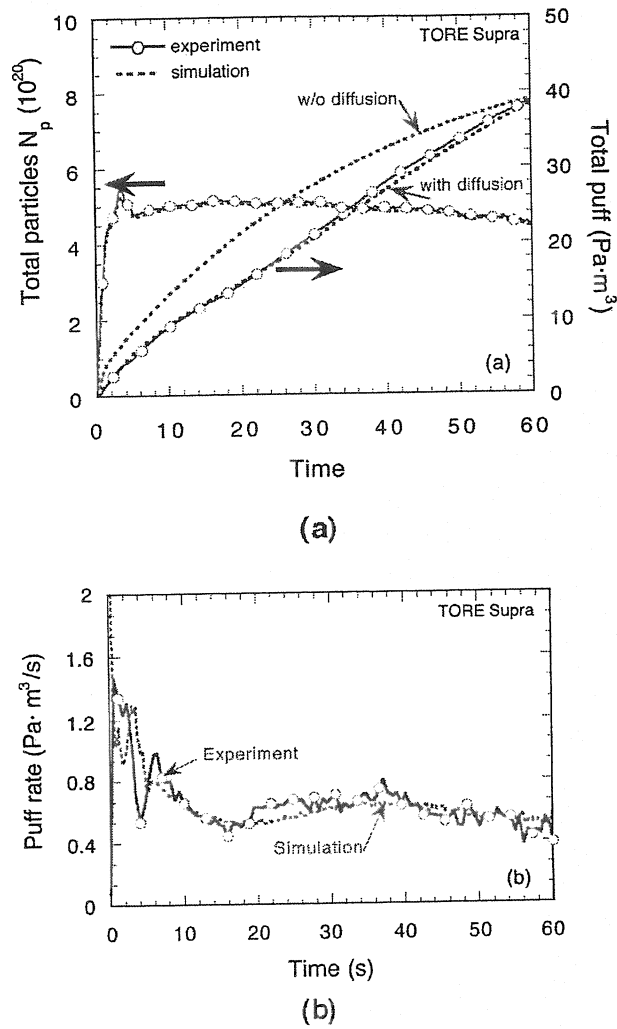
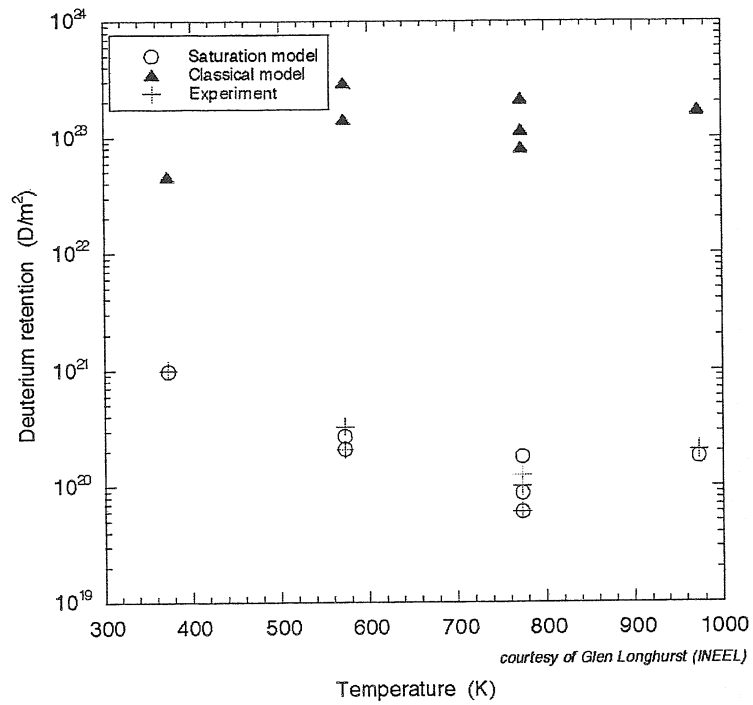

Figure 91. Density behaviour of deuterium during a typical limiter to divertor transition in the 1998 ITER design for various values of the fuelling rate; (figure provided by M. Sugihara, ITER.)



**Figure 92.** (a) Time evolution of the total puffed particles calculated to match the time behaviour of measured density for a long-pulse Tore Supra discharge (shot 9016). Experimental results are represented with a solid line with open circles, whereas the results of the simulation are represented with a dotted line for a case with and a case without enhanced diffusion. The initial wall concentration was adjusted to match the total puffed particles at  $t=60$  s with the experimental value (solid line with open circles). (b) Time behaviour of gas puff rate calculated with enhanced diffusion (dotted line) and the experimental value (solid line with open circles); (reproduced with permission from [706].)



**Figure 93.** Comparison of measured deuterium retention in beryllium with that calculated by the saturation model and the classical model in the TMAP4 code for experiments in TPE [919]; (figure provided by G. Longhurst, INEEL, Idaho Falls.)

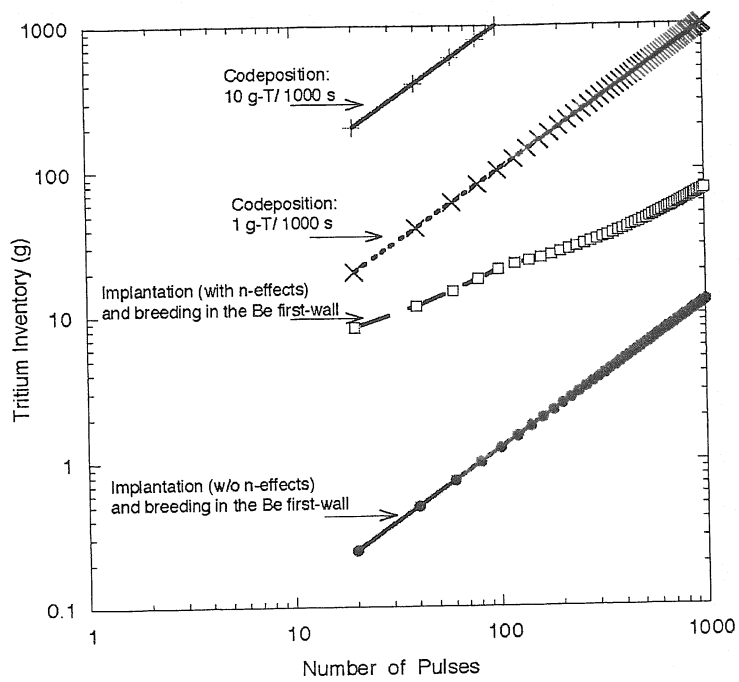

Figure 94. Comparison of the rate of tritium accumulation in the beryllium first-wall (with and without n-effects) and divertor co-deposition for two indicative tritium co-deposition rates of 1 and 10 g/1000 s.



## 6. CONCLUSIONS AND FUTURE R&D PRIORITIES

Our knowledge of PMI processes in a fusion environment has greatly expanded during the past two decades as a result of extensive experimental and modelling efforts. These advances have provided a bridge to designing a next-step device, and predicting and optimising its performance. The ITER Design Activities have focussed attention on an integrated solution to all design issues and have stimulated much PMI-related research. Although the field is rapidly evolving and the present review is one of work in progress, some key conclusions relevant to a next-step device are presented below, together with some recommendations for future work. References to the section(s) of the review where the subject is discussed in detail are given.

### 6.1. Erosion and Co-deposition Effects

Summary of key findings:

(a) Net erosion rates of low- $Z$  materials in today's tokamaks are  $\approx 10 \text{ nm}\cdot\text{s}^{-1}$  for typical attached divertor plasmas ( $T_e \approx 20 \text{ eV}$ ), at target plate power densities of a few  $\text{MW}\cdot\text{m}^{-2}$ . Such power densities are similar to that expected in a next-step long-pulse machine, and these erosion rates will lead to unacceptably frequent replacements of PFCs (Sect. 5.3). The net erosion rates for hydrogen sputtering decreases with increasing atomic number of the plate material due to threshold effects for physical sputtering (Sect. 3.2.1).

(b) Detached plasmas allow a large heat flux reduction at the divertor plate, sufficient helium exhaust, and greatly reduce the incident particle energy at the divertor ( $T_e < 5 \text{ eV}$ ), reducing or eliminating physical sputtering of even low- $Z$  materials. However, carbon will still erode by chemical processes. The peak net erosion rate due to chemical sputtering at the ITER divertor target will be of the order of  $10 \text{ nm}\cdot\text{s}^{-1}$  and will require frequent replacements of the PFCs (Sect. 5.3).

(c) In divertor tokamaks, the main chamber wall is an area of net erosion, while both erosion and deposition occur in the divertor (Sect. 4.3). Co-deposition of carbon with deuterium or tritium occurs mainly in the divertor region even when the divertor material is not carbon, as other carbon PFCs provide a source of carbon for co-deposition. This has been observed with the JET Mk-I beryllium and the ASDEX-Upgrade tungsten divertors (Sect. 4.7). Additionally, thick films accumulate in areas shaded from the plasma, and in gaps between tiles, e.g., as seen in TFTR (Sect. 4.7.1.1) and in JET (Sect. 4.7.1.2).

(d) In several tokamaks, the net erosion/deposition and associated H-isotope retention is asymmetric with respect to the inner and outer strike-points. This is, for example, the case in JET, DIII-D, ASDEX-Upgrade (for the case with Div-I only) and Alcator C-Mod (Sect. 4.3.1). The outer strike-point is generally a region of net erosion, whereas net deposition of carbon is seen on the inner divertor. The asymmetry is particularly apparent in JET, where in the Mk IIA phase, heavy (flaking) deposition occurs on the water-cooled louvres at the corner of the inner divertor, shaded from the plasma (Sect. 4.7.2.2.3).

(e) Intense co-deposition of carbon and deuterium is found in many tokamaks in regions which are shaded from ion flux but are near carbon surfaces receiving high ion flux. Since

ions cannot reach these shaded surfaces, this carbon deposition must be due to neutral carbon atoms or molecules/radicals resulting from dissociation of hydrocarbons released from carbon-surfaces. In JET,  $D/C \approx 0.7$  was seen in co-deposits on the louvre surfaces (Sects. 4.3.1 and 4.7.1.2).

(f) Erosion by arcing in current divertors warrants more detailed study of their effect. The principal limitation in the current understanding of arcing on divertor surfaces is the lack of diagnostic capabilities. Post-exposure analysis of arc traces can be misleading. Detection of arcing in the divertor using electrical or optical methods, correlated with surface measurements, is needed to assess the impact of arcing in next-step divertors.

Recommendations for further work:

(g) Some aspects of carbon sputtering and transport processes require clarification. Firstly, detailed dedicated experiments in plasma simulators and in tokamaks have shown, in some cases, a decreasing trend in the 'derived chemical erosion yield' of carbon/graphite for hydrogen fluxes above  $10^{22} \text{m}^{-2} \cdot \text{s}^{-1}$  (Sects. 3.2.3 and 4.3.1). Fluxes of this order of magnitude and higher are expected for next-step devices, so any reduction would be beneficial. However, the derivation of yields from such plasma experiments is complicated by uncontrolled changes in other plasma parameters and diagnostic limitations. Therefore, the flux dependence of the chemical erosion yield of carbon-based materials at high fluxes is still an open question.

In tokamaks some hydrocarbon molecules formed by erosion travel into shaded areas, with important consequences for tritium retention and recovery (Sect. 4.7). The complex role of molecular neutral and radical states and their transport/interactions with the plasma is posing a substantial challenge to PMI modelling. Experiments on this transport, and whether it can be used to advantage in a next-step machine, are at an early stage. More research is needed to establish the absolute values of the sticking coefficients of such radicals.

(h) "Soft" and "hard" re-deposited layers in tokamaks with carbon-based targets have different properties (e.g., chemical sputtering yields (Sect. 3.2.6.4) and erosion by oxidation (Sect. 4.7.3.1)), and both are markedly different from the original material. Even in areas of net erosion, the plasma modifies the surface. Since erosion rates at these surfaces are crucial in modelling re-deposition (and hence T-retention) in next-step devices, further measurements are essential.

(i) Estimates of erosion and tritium retention in next-step devices depend on plasma-edge modelling, but at present the models do not adequately explain the deposition seen in JET (Sect. 5.3). There are clearly additional processes occurring in the plasma boundary which require explanation and inclusion in the models. These include drifts in the SOL and interactions with the main chamber wall. A complete model of transport in the plasma boundary must be developed, and validated against deposition data from a range of tokamaks.

(j) Laboratory measurements on sputtering, hydrogen isotope retention and removal, etc., are generally performed on materials comprising a single element, for example, graphite or beryllium. However, the first-wall of a next-step device is likely to use multiple materials, for example, the ITER design includes areas of graphite, tungsten and beryllium. Erosion/deposition involves synergistic effects associated with these materials, requiring further

exploration. Bench-top experiments have a useful role to probe the synergistic effects at a fundamental level, but they cannot alone provide the level of understanding required for prediction of all of the complex interactions in a fusion device environment. Tests are required on tokamaks with the appropriate impurities and wall materials to help answer questions, such as the magnitudes of erosion and tritium co-deposition, dust formation in the vessel, and the ease of tritium removal from mixed-materials.

(k) The plasma thermal energy divided by the surface area contacted by the plasma provides a measure of the severity of the PMIs in disruptions. This factor will be more than an order of magnitude greater in ITER than in existing large fusion machines. Major disruptions and VDEs in ITER will cause ablation and melting of surface material in the divertor target area, and possibly at other parts of the divertor and at the first-wall (Sect. 5.4). Calculations and experiments in plasma simulators predict that a vapour shield forms in front of the divertor targets, dispersing the majority (>90%) of the incident energy flux to the divertor chamber walls via radiation that, in turn, causes shallow melting or sublimation on the nearby-surfaces (Sects. 3.4, 4.5 and 5.4). However, there are still large uncertainties in determining the erosion associated with disruptions, in particular, the behaviour of the melt layer, and the effectiveness of the vapour shield to control the power on the surfaces. Vapour shielding has yet to be demonstrated in a tokamak. More work is needed to study erosion of metallic materials during an intense deposition of energy. Experiments and modelling are required to establish the role of brittle destruction of carbon-based materials at these energies. Modelling must be further developed and tested against experimental results from disruption simulators to better understand the complex interactions at work.

(l) The past decade of divertor research has seen a return of interest to metals, which had been in the previous decade largely put aside in favour of carbon. This renewed interest is mainly due to the concerns about the chemical sputtering of carbon, even at the low energies present in the divertor (Sect. 3.2 and 4.3) and the consequent large hydrogenic retention in films forming primarily on cold surfaces (Sects. 3.5 and 4.7). JET has experimented extensively with Be, as a low-Z alternative to carbon. Operation with a relatively clean core plasma has been demonstrated for Alcator C-Mod with a high-Z all-Mo wall; in TEXTOR, with W-clad limiters; and in ASDEX-Upgrade, with W-coated divertor plates, and more recently, with a partially W clad central column. Impurity ion sputtering dominates the erosion rate. It is now realised that the proper selection and location of the PFCs, combined with the most recent plasma control capabilities, allow us to take advantage of the low sputtering yields of these materials. Encouragingly, high-heat-flux components, clad with carbon-fibre materials or tungsten 'brush' materials have been developed and successfully tested up to  $20 \text{ MW}\cdot\text{m}^{-2}$  in steady-state (Sect. 2.4), though more data and modelling of the response to off-normal events are needed. It is clear that advances in materials technology alone are unlikely to resolve these issues, and improved plasma control, leading to reduction and mitigation of off-normal events such as disruptions and ELMs, will be an essential part of the long-term solution (Sect. 2.3.2.4).

## 6.2. Tritium Retention and Control of the In-Vessel Tritium Inventory

Summary of key findings:

(a) Deuterium is retained in limiter machines with carbon PFCs at about 50% of the input (TFTR and JET pre-1989), and at around 5-15% (of a much greater input) in JET operating with a divertor and cryopump (Sects. 4.7.1.2 and 4.7.2.2.3). Tritium retention in the torus of carbon-containing reactors will be dominated by co-deposition of carbon and tritium. Modelling predictions for ITER indicate several grams of retained tritium per pulse with pulse duration of several hundred seconds. The large in-vessel tritium inventory resulting from this high rate of retention has serious implications for the design, operation and safety of ITER, and may lead to the exclusion of carbon PFCs in future DT fusion reactors.

(b) Running discharges in D (or H) is an effective way to remove tritium from top surface of carbon PFCs without venting the machine (or exposing the surfaces to oxygen), so that no tritium enters the plasma in subsequent discharges (Sect. 4.7.2.2). However, the tritium retained in JET following DTE1 and subsequent D(H) discharges was only reduced by about a factor of two (to 17% of input T), because plasma operation could not reduce the retention in shaded areas (e.g., at the JET louvres) or tritium buried in co-deposits (e.g., at the TFTR limiters); (Sect. 4.7.2.2.3).

(c) Carbon can retain H isotopes to an atomic ratio of H:C > 1 (Sect. 3.5.3), while retention in beryllium at low temperature is limited to an H:C ratio of  $\approx 0.3$  (Sect. 3.5.2.4). However, out-gassing from Be occurs at lower temperatures ( $\approx 600$  K) compared to carbon-based materials (>800 K; see Sect. 3.5.3.3). Contamination of Be with C and/or O can greatly increase its retention capability. Recent experiments showed that hydrogen implantation at low energies and high fluxes in beryllium results in little increase in inventory with dose at high fluence (Sect. 3.5.2.4), in part due to surface-connected porosity that provides a rapid return path back to the plasma. This process is very favourable in a next-step device lined with Be because it limits the tritium inventory and permeation rate in surfaces exposed to high particle fluxes (Sect. 5.6).

(d) Laboratory experiments involving thermo-oxidative erosion at temperatures above 570 K, or oxygen plasma discharges have been found to be effective in removing T-containing films from carbon surfaces (Sect. 4.7.3). Erosion rates depend strongly on the microstructure of the co-deposited layers. Air ventilation (which entails oxidation) was found to be a simple and effective method of tritium removal, and, with other techniques, enabled the fraction of tritium retained to be reduced to 16% of input T in TFTR (Sect. 4.7.2.2.2), and to 6% in JET (sect. 4.7.2.2.3). In TFTR, relatively more T was released with increasing temperature and/or air pressure, consistent with laboratory findings. Major drawbacks of techniques using oxygen, especially at elevated temperatures, include collateral effects on other reactor vessel components, and recovery time for normal plasma operation. Additionally, the handling of large quantities of HTO that would be produced in a next-step DT device would require a large-scale tritium processing plant (Sect. 2.3.3).

(e) Hydrogen retention on the main chamber wall of divertor tokamaks is limited to implantation by energetic charge-exchange neutrals from the plasma. This inventory is not

a significant part of the long-term hydrogen inventory because the thickness of the implanted layer is small ( $<0.1 \mu\text{m}$ ). However, even this quantity of hydrogen in the main chamber wall is much larger than the quantity of H in a plasma, and the dynamic variations of this wall inventory dramatically affect fuelling of individual discharges (Sect. 4.6).

Recommendations for further work:

(f) As long as carbon is used, even on limited areas of a next-step device, operation requirements (due to safe operation limits and fuel economy considerations) will necessitate the frequent removal of the tritium from the co-deposited layers, or perhaps the removal of the layers altogether (Sect. 2.3.3). Alternatively, surfaces where co-deposition is expected to occur could be kept "hot" (i.e.,  $\geq 770 \text{ K}$ ) to prevent the accumulation of tritium, or very cold (i.e.,  $<273 \text{ K}$ ) to enhance film deposition in localised areas, which could be periodically heated, or mechanically cleaned, to remove the tritium. However, both solutions are technically very difficult to implement in a reactor and, although several alternatives are being considered for the removal of the T-rich co-deposited layers, their removal from a next-step machine using carbon is an outstanding challenge. Prototypes of most promising schemes should be demonstrated.

(g) Neutral atoms and molecules play a particularly important role in the high-density, low-temperature, detached-plasma regimes currently favoured for next-step devices. Data on atomic and molecular processes, especially reaction pathways and reaction rates for heavy hydrocarbon molecules (i.e.,  $\text{C}_x\text{H}_y$  with  $x \geq 2$ ) as a function of plasma conditions, are needed (Sects. 3.2.3 and 4.3.1).

(h) Further work is also needed to better understand the effects of neutrons on creating traps in PFC materials and their effects on tritium retention. Further, the present techniques for accommodating the effects of surface saturation in the models are not very satisfactory. More detailed experiments/diagnostics are needed to test more detailed physics hypotheses leading to a deeper understanding from which improved models can then be drawn.

### 6.3. Requirements for Modelling and Interpretation of Tokamak Data

Predictive numerical codes are now available to simulate various aspects of PMIs and are recognised to be a vital tool in designing next-step tokamaks (Sect. 5). Some of these codes have been successfully benchmarked against results from dedicated PMI experiments in current tokamaks. However, the comparison between data and models is sometimes difficult because some of the physical effects are still poorly understood and not included in the models. In addition, erosion/re-deposition processes depend strongly on local plasma conditions that in most cases are not known very well. In general, the breadth and depth of diagnostic data from the wall/edge has generally lagged behind the sophistication of the computational resources. More time- and space-resolved wall diagnostic measurements are critically needed to match the computational opportunities and make progress toward integrated understanding of the complex relationship between the plasma edge and the wall (Sect. 6.4).

Nevertheless, dedicated measurements of in-situ and ex-situ erosion, with good near-surface plasma diagnostics, have verified erosion/deposition models, for several materials

and plasma regimes. In general, there is reasonably good confidence in the predictive value of the erosion/re-deposition models for metals in all plasma regimes, and for carbon in attached regimes, given the validity of the input code-computed plasma background solution. There has been considerable progress made in modelling detached-plasma carbon erosion, but the codes are not yet validated for these conditions. Unlike existing machines where some measurements of near-surface plasma conditions are often available, code-computed plasma solutions of varying degrees of speculation must be used for ITER-type reactor design analysis. Detached and/or partially-detached plasma regimes involve highly uncertain physics, and analysis of these regimes needs further work. Moreover, there is highly conflicting experimental data on carbon chemical erosion (Sect. 6.1) and accordingly high uncertainty in modelling results. More work is needed in this area to develop reliable design information. Critical sub-models for detached plasma conditions include carbon chemical sputtering coefficients at low energies ( $\approx 5\text{--}15$  eV), rate coefficients for hydrocarbon molecular impact processes with plasma ions and electrons, hydrocarbon sticking coefficients, and the effects of mixed-materials, e.g., beryllium and carbon, on sputtering and tritium trapping.

There are several critical issues resulting from particle recycling phenomena in a next-step tokamak and we are still far from having fully predictive models that could be extrapolated with confidence to future fusion devices. They include: (i) sustaining density control during a long pulse; (ii) sustaining beneficial wall conditions during a long pulse; (iii) role of co-deposition and surface trapping/diffusion; and (iv) efficient, sustained fuelling of the core of a large ignited plasma. Present tokamaks have pulse lengths typically of the order of 10 seconds, and changes in recycling behaviour can often be observed even on this time scale. Pulse lengths in next-step devices will be measured in thousands of seconds, so it is important to increase the pulse lengths in existing tokamaks, and operate simulation devices, to determine whether active control of recycling (e.g., by divertor cryopumps), will be required for next-step devices (Sects. 2.3 and 4.6).

Modelling work with the next generation of faster computers will likely involve kinetic-model computation of mixed-material surface evolution, and more use of molecular dynamic simulations for computing surface material properties. More integrated coupling of these simulations and codes for sheath dynamics, plasma core, SOL parameters, wall conditions etc., will lead to a better overall understanding of plasma-surface behaviour. Additional model development, particularly for the near-surface plasma, is required. The models should include erosion/deposition, retention and recycling of hydrogen in wall materials (Sect. 3.5), the energy and flux of H to the wall, and variations of these processes/parameters with space and time. The effects of the wall (e.g., recycled H) on plasma-edge conditions also need to be considered.

Finally, understanding the physics of material response during off-normal heating has improved and now complex modelling tools are available. However, extrapolation to reactor conditions remains somewhat uncertain, and the modelling of the effect of vapour shielding, the stability of the melt layer and the role of brittle destruction in carbon must be further explored and tested against experimental results, particularly in tokamaks, to better

understand the complex interactions at work.

#### 6.4. Need for Improved Wall Diagnostics

There are a large number of issues regarding the processes occurring at the plasma boundary and wall regions that require active investigation. The complex and varied discharge history in tokamaks makes archaeological comparisons of post-campaign in-vessel components with erosion/deposition and retention models of limited utility. This shortfall in our knowledge represents one of the largest uncertainties in the validation of existing codes. Measurements of erosion/deposition and H-retention under different operational conditions such as start-up/shut-down, disruptions, attached/detached-plasma divertor, high-power operations, etc., are required, e.g., by using film thickness monitors. There is a strong incentive to develop novel diagnostics in this area, and to devote more dedicated run time to those that already exist (Sect. 4.2).

#### 6.5. Dust Effects

Dust has not been a significant problem so far in magnetic fusion devices. Thus, the subject has received little attention within the fusion community. However, the amount of dust that will be generated in a next-step device is likely to scale up by 2-3 orders of magnitude along with the erosion and discharge duration. In accident scenarios, chemical reactions of fine dust with steam and air create potential explosion and dispersal of radioactivity hazards. There is a need to couple models for erosion/sputtering and disruption to film and dust formation (e.g., physical adsorption, nucleation and condensation) and compare the results to tokamak experience and disruption simulations. This knowledge is vital for making reliable predictions of dust inventory for a next-step device (Sects. 2.3.4 and 4.8). Techniques for reliable measurement of dust inventory, particularly in hidden areas, are in their infancy, but are essential to assure compliance with regulatory limits. Even more critical is the development of reliable methods to remove dust.

Thick films of re-deposited material found in present-day tokamaks have been shown to break-up into flakes (Section 4.8.3). This material is potentially hazardous, since the T content may be very high, as in the flaking films observed at the JET louvres (Sects. 2.3.3 4.7.2, and 4.8.3).

#### 6.6. A Next-Step Fusion Reactor without Carbon Plasma-Facing-Components

If carbon were eliminated from the divertor of a next-step device, the situation as far as tritium inventory is concerned would be radically different and the control of tritium inventory much more manageable. The FIRE design study (Sect. 5.3.1) has forgone the use carbon PFCs for this reason. The primary candidate in lieu of carbon for high-heat-flux regions is tungsten. In anticipation of positive developments in disruption and ELM mitigation, a high-heat-flux tungsten vertical target is being considered as a possible alternative in ITER. However, the primary shortcomings of W that should be addressed in the coming years are the lack of operational experience and the dearth of experimental data regarding

formation of melt layers (and their properties) during disruptions. Operation at higher edge temperatures and lower densities in 'advanced plasma scenarios' (see glossary) results in more severe erosion by sputtering. Dust generation from beryllium and tungsten is still an outstanding issue (Sect. 6.5).

It is important to recognise that the plan to use carbon PFCs (and the consequent allocation of a significant fraction of the operational schedule for de-tritiation) follows directly from the projected levels of thermal loads expected during attached-plasma transients, ELMs and disruptions. Efforts to reduce transients and to mitigate disruptions must continue at the highest priority. Operation near beta limit will require identification of disruption precursors and development of feedback control to avoid beta limits.

### 6.7. Concluding Remarks

Designing a robust interface between a thermonuclear plasma and the material world remains a major challenge. The extensive data from existing tokamaks and simulators have enabled great strides to be made in our understanding of the processes involved in PMIs. However, there are many unresolved issues relating to a next-step machine. Much more information can be learned from the existing facilities, particularly in areas such as mixed-material effects, alternatives to the use of carbon targets (including disruption/ELM avoidance), transport effects in the plasma edge, and longer-term retention and release of hydrogen isotopes. The consequences of a continuously-burning plasma cannot be duplicated in existing devices. Predictive modelling is therefore essential. Unfortunately, the plasma-edge region in a next-step tokamak has a more complex geometry and a greater variety of interacting processes than the core plasma on which most effort has so far been concentrated in the fusion community. Much work remains to be done in this area and more machine operational time and diagnostics dedicated to PMI issues are required. Initiatives on these fronts, together with modelling of the results, are essential to advance the understanding of PMIs.

Dependence on external energy supplies and the threat of climate change lends urgency to quest for new energy sources such as nuclear fusion. A next-step fusion reactor is a vital step that will accelerate the necessary technical solutions. A sustained and vigorous R&D program in PMI issues focussed on the key uncertainties identified in this review is vital for fusion to meet its promise as an attractive long-term energy source for mankind.



## 7. GLOSSARY OF TERMS AND ACRONYMS

This glossary provides an explanation of some specific terms, which are used in this paper (e.g., some of the scientific vocabulary, the names of various research machines and devices used, the names of the various research laboratories, the mathematical symbols used, and the acronyms frequently used as shorthand for some of the above). A good reference source for most of the common terms used in fusion science can be found on the World Wide Web (<http://FusEdWeb.pppl.gov/Glossary/glossary.html>).

(in alphabetical order)

### **a-C:H:**

'Amorphous hydrogenated carbon' (normally as a deposited film).

### **Activation:**

Activation occurs when a particle interacts with an atomic nucleus, shifting the nucleus into an unstable state, and causing it to become radioactive.

### **'Advanced-regimes' or 'advanced-scenarios':**

Modes of operating a tokamak with improved plasma confinement and/or enhanced potential for continuous operation, have been discovered in recent years and are studied in present tokamaks. Their study is an important part of the experimental programme foreseen for the next-step fusion device. If proven to be of full reactor relevance, they would make it possible to construct a fusion power plant that is less costly than existing designs. See also entry for internal transport barriers.

### **AGHS:**

Acronym for Advanced Gas Handling System.

### **Alcator C-Mod (usually referred to as C-Mod):**

The name Alcator was given to a class of tokamaks designed and built at MIT; these machines are distinguished by high magnetic fields with relatively small diameters. The high magnetic field helps create plasmas with relatively high current and particle densities. The present incarnation is Alcator C-Mod (<http://cmod2.psfc.mit.edu/cmod/home.html>).

### **"All-carbon" machine:**

A tokamak wherein all particles travelling along field-lines can only intersect with carbon components protecting the wall of the machine. However, much of the vessel wall may still be uncovered, so neutrals travelling radially from the plasma may still impinge upon non-carbon materials.

### **ARIES:**

Acronym for the Advanced Reactor Innovation and Evaluation Studies. Set of fusion reactor design studies, which investigated the safety, economic, and environmental implications of various advances in fusion reactor science and technology.

### **ASDEX:**

Acronym for Axially Symmetric Divertor Experiment. The original ASDEX, located in Garching, Germany and decommissioned in  $\approx 1990$ , would qualify today as a medium-sized tokamak. It was designed for the study of impurities and their control by a magnetic divertor. The H-mode or high mode of operation with neutral beam injection was first observed on ASDEX. Its successor, *ASDEX-Upgrade* (a completely new machine, not really an "upgrade"), is larger and more flexible (<http://www.ipp.mpg.de/aug.eng/>).

### **Aspect ratio:**

In toroidal geometry, the ratio of the major diameter (total diameter of the torus) to the minor diameter.

### **ATF:**

Acronym for Advanced Toroidal Facility.

**Baffle:**

Plates at the entrance to the divertor providing a transition between the divertor and the first-wall, which also contribute to the retention of neutrals in the divertor.

**BET method:**

A gas adsorption technique devised by Brunauer, Emmett, and Teller (BET) to measure the specific surface area of materials.

**Beta, or beta-value:**

Ratio of plasma pressure to magnetic-field pressure; proportional to the ratio of plasma thermal energy density to magnetic field energy density.

**Beta limit:**

It is also called *Troyon Limit*, and is the limit at which the plasma pressure in a tokamak becomes too high, so that so-called ballooning modes become unstable and lead to a loss of confinement.

**Blanket:**

It is the region surrounding the fusion reactor core. The blanket of a fusion reactor has the threefold purpose of breeding the tritium by interactions of the neutrons with lithium, of converting the energy of the neutrons to high-grade heat for electricity generation and of shielding the superconducting magnets from energy deposition and radiation damage.

**Bohr radius:**

It is the atomic unit of length  $a_0=0.052918$  nm.

**Bootstrap current:**

Currents driven in toroidal devices by neo-classical diffusion. They may amount to a substantial fraction of the net current in a tokamak reactor, thus lengthening the pulse time or decreasing the power needed for current drive.

**Breakeven (scientific):**

When the fusion power equals the input power, i.e.,  $Q=1$ . See also entry for fusion power gain.

**Bremsstrahlung :**

German for "Braking Radiation". Electromagnetic radiation from a charged particle as it slows down (decelerates), or as it changes direction due to near collisions with other particles.

**Burning plasma:**

It is the plasma in which the heating is solely or primarily by alpha particles created by the fusion reaction itself. As an example, at  $Q=10$  (see entry for  $Q$ ), the power from the alpha particles would be two-thirds of the total heating power. If all the heating is by alpha particles, this is termed an "ignited" plasma.

**C-II emission:**

Line emission due to electronic transitions in singly ionised carbon.

**CD band emission:**

Radiation emitted by a C-D molecule (CH band emission similarly comes from a C-H molecule).

**Charge-exchange:**

Phenomenon in which an ion colliding with a molecule (or an atom) neutralises itself by capturing an electron from the molecule/atom (becoming a *charge-exchange* neutral), and transforming the molecule/atom into a positive radical/ion.

**CFC(s):**

Acronym for Carbon-Fibre-Composite(s).

**Composants internes et limiteur (CIEL):**

Major upgrade of Tore Supra in-vessel components, which plans to use a flat toroidal limiter to

sustain 15 MW of convective power in steady-state conditions.

**Confinement times ( $\tau_E$ ,  $\tau_P$ ):**

$\tau_E$ ,  $\tau_P$  are the times the plasma is contained (e.g., by magnetic fields) before energy (E), or particles (P) are lost from the plasma.

**Connection length:**

Half the distance along the magnetic field in the SOL between two points of contact with the solid surface.

**Coolant burn-out:**

see entry for critical heat flux.

**Core plasma:**

Hot plasma at the centre of a fusion reactor.

**Count median diameter (CMD):**

50% of the particles in a distribution have diameters that are smaller than this.

**Critical heat flux (CHF):**

The heat flux that leads to the loss of liquid layer at the wall of the coolant channel and can result in a so-called "coolant burn-out".

**Current drive:**

A technique used to cause current flow in a plasma. See also entry for *bootstrap current*.

**Current quench time of disruptions:**

Is the characteristic time of the rapid current decay that follows the thermal quench. During this phase, the plasma magnetic energy is also dissipated, mostly by impurity radiation to the torus vessel or first-wall surface; 100-1000 ms expected in ITER-class tokamaks. See also thermal quench time entry.

**Cyclotron resonance:**

Charged particles in a magnetic field resonate with (and absorb energy from) an electric field (perpendicular to the magnetic field), which oscillates at the particles' cyclotron frequency, or at a harmonic (multiple) of that frequency. See also electron cyclotron heating.

**DIII-D:**

A medium-sized tokamak, but the largest tokamak still operational in the USA. Operated by General Atomics in San Diego (<http://fusion.gat.com/diii-d/>).

**D-alpha:**

Spectroscopic emission line at 6561 Å from the  $n=3 \rightarrow n=2$  transition in deuterium. The most intense line in the visible wavelength range from deuterium plasmas, and the primary indicator of the influx of recycled deuterium into the "plasma".

**DEMO:**

Acronym for Demonstration Reactor.

**Detached regime:**

see plasma detachment.

**DiMES:(Divertor Material Evaluation Studies):**

A retractable probe that allows the insertion and retraction of test material samples to the DIII-D divertor floor e.g., for erosion/deposition studies.

**Displacements per atom (dpa):**

This is a measure of the amount of radiation damage in neutron-irradiated materials; e.g., 10 dpa means that each atom in the material has been displaced from its site within the structural lattice of the material an average of 10 times (due to interactions between the atoms and the energetic neutrons irradiating the material).

**Disruption:**

Sudden loss of plasma confinement. The stored energy in the plasma is rapidly dumped into the rest of the plasma system (vacuum vessel walls, magnet coils, etc.) and can cause significant damage if precautions are not taken.

**DITE:**

Acronym for Divertor Injection Tokamak Experiment.

**DIVA:**

Acronym for Axisymmetric Divertor.

**Divertor:**

Component of a magnetically confined toroidal fusion device that diverts charged particles on the outer edge of the plasma into a separate chamber where they strike a barrier and become neutralised. In a reactor, the divertor would incorporate a system for pumping out the neutralised particles as exhaust from the machine. A divertor, like a limiter, prevents the particles (including helium ash) from striking and degrading the chamber walls and dislodging secondary particles that would cool and contaminate the plasma. See also *limiter* entry.

**DTE1:**

Acronym for Deuterium Tritium Experiment number 1 - in JET in 1997.

**Duty-factor (also called duty-cycle):**

Ratio of the duration of time when a system is actually operating to the total time for a complete cycle of the system. For example, if a tokamak experiment runs for 5 seconds and then sits for 500 seconds, while the power supplies are recharged, then the duty factor is about 1%.

**D/XB:**

The ratio of the methane influx to the intensity of the CD band emission at 430 nm.

**Eddy current:**

Electric current induced inside a conductor when the conductor (a) moves through a non-uniform magnetic field, or (b) experiences a change in the magnetic flux through its surface.

**Edge-localised modes (ELMs):**

ELMs are MHD related events that play a key role in mediating the energy and particle transport characteristics of the plasma edge in the regime of enhanced global energy confinement called the high confinement mode (H-mode). They involve the very rapid expulsion of energy and particles from the outer part of a confined plasma into the SOL and can transiently reduce the temperature and density in this region and thereby affect the core confinement. In addition, they can lead to increased peak heat loads on the divertor plates.

**Edge plasma :**

Cooler, less dense plasma away from the centre of a reactor (which includes the SOL); affected by contact with a limiter or divertor.

**Electron cyclotron discharge cleaning (ECDC):**

Using relatively low-power microwaves (at the electron cyclotron frequency) to create a weakly ionised, essentially unconfined hydrogen plasma in the vacuum chamber. The ions react with impurities on the walls of the tokamak and help remove them from the chamber.

**Electron cyclotron heating (ECH or ECRH):**

Radio-frequency (RF) heating scheme that works by injecting electromagnetic wave energy at the electron cyclotron gyration frequency (or higher harmonics). RF energy is absorbed by electrons and then translated into ions through collisions.

**Energy amplification factor:**

See entry for fusion power gain.

***Ergodic divertor:***

It is a high-density, low-temperature, highly recycling and highly radiating region of the plasma formed by randomising the field lines at the plasma edge.

***FIRE:***

FIRE is a design study for a major next step option in magnetic fusion. It aims to produce, understand and optimise alpha particle heated fusion plasmas and to provide a stepping stone toward attractive magnetic fusion reactors. It is a compact (2 m major radius), high field (Cu coil, 10-12 T) design with a pulse duration (burn time) of 18 s. The duty-cycle will be in the same range as present machines and FIRE is not designed to address the long pulse PMI issues that are the subject of this review. However, in response to concerns on tritium accumulation, FIRE will have no carbon PFCs, the first-wall is covered with Be tiles and divertor uses W rods on a Cu backing plate.

***FTU and FT-Upgrade:***

Acronyms for Frascati Tokamak and Tokamak-Upgrade, respectively.

***Fuel burn-up or tritium burn-up:***

See tritium fractional burn-up.

***Fusion power gain, Q:***

The ratio of fusion power to the external power input. When  $Q=1$  (a value transiently approached on JET in 1997), the fusion power is equal to the external power input. In this case the self-heating power of a deuterium-tritium plasma is about 16% of the heating power necessary to maintain the plasma temperature. When  $Q=5$ , the self-heating fraction equals 50%, becoming a significant factor of the plasma behaviour. The self-heating reaches 66% of the total heating power at  $Q=10$  and 100% at an infinite  $Q$  (defining mathematically plasma "ignition", a conceptual limit in magnetic confinement fusion).

***Glow discharge:***

Low-density, low-temperature plasma discharge sustained by current flowing between electrodes immersed in the plasma.

***Glow discharge cleaning (GDC):***

Cleaning in which impurities are removed by sputtering in a glow discharge.

***Greenwald density limit:***

An empirical limit to the density of a tokamak plasma when the line-average electron density ( $10^{20} \text{ m}^{-3}$ ) equals the average plasma current density ( $\text{MA}\cdot\text{m}^{-2}$ ) times the plasma elongation (see entry).

***GSD:***

Acronym for Geometric Standard Deviation.

***Halo currents:***

Halo currents are currents generated during a disruption that flow along open field lines surrounding the plasma, in what is known as the "halo" region, and return poloidally through the vessel. Large forces on the vessel components can result when these poloidal halo currents interact with the toroidal field. Toroidal halo currents do not contribute to forces on the vessel since they do not flow in the vessel wall.

***High-mode or H-mode:***

A regime of operation most easily attained during auxiliary heating of diverted tokamak plasmas when the injected power is sufficiently high. A sudden improvement in particle confinement time leads to increased density and temperature, distinguishing this mode from the normal "low-mode" or "L-mode". H-modes are also possible in tokamaks without divertors, or without auxiliary heating,

and have been observed in stellarators.

**High-recycling:**

Plasma/surface boundary condition where almost all ( $\approx 99\%$ ) impinging particles to the surface (D,T, He, etc., ions and neutrals) come back out (by various processes including reflection and desorption), and only  $\approx 1\%$  is removed (usually by active pumping), thereby tending to create high-density and low-temperature near-surface and SOL plasma conditions.

**IAEA:**

Acronym for the International Atomic Energy Agency. It is an autonomous intergovernmental organisation established in 1956 with the purpose of advancing peaceful uses of atomic energy, with headquarters in Vienna.

**Ignition:**

The point where the confinement of energy released from fusion reactions in the plasma is sufficient to maintain the plasma temperature so that no external heating is needed. See also entry for fusion power gain.

**Impurities:**

Atoms (or ions) of unwanted elements in the plasma, which tend to degrade plasma performance, and in the case of fusion, dilute the plasma so that fusion processes are less probable.

**Impurity screening:**

Impurities leaving the first-wall (or the divertor target) as neutrals travel towards the core plasma, but are likely to be ionised and trapped in the edge of the plasma. From the edge, further inward movement is by cross-field diffusion. Thus, only a small fraction of impurities ever reach the plasma core; this blocking probability is impurity screening.

**Inconel:**

A range of nickel-based alloys containing chromium (Cr) and iron (Fe) with good high-temperature strength and resistance to chemical corrosion. The JET vessel is manufactured from Inconel 600 (composition Ni +Co >72%, Cr 14-17%, Fe 6-10%).

**Internal transport barriers:**

Insulating layer established within the plasma resulting in significantly reduced transport, reduced particle influx, steeper density profiles and improved global energy confinement time. See also entry for advanced regimes.

**Ion cyclotron resonance heating (ICRH):**

Like electron cyclotron heating, but heats ions using waves near the ion cyclotron frequency. See entry for electron cyclotron heating.

**Isochronal annealing:**

A property is measured versus anneal temperature while the sample is heated to successively higher temperatures with constant time intervals at each temperature.

**ISX:**

Acronym for Impurity Study Experiment.

**ITER:**

Acronym for International Thermonuclear Experimental Reactor. Large fusion reactor design project being planned by the governments of the European Union, Japan, the Russian Federation (formerly the USSR), and the United States to develop a detailed engineering design for a reactor-scale tokamak facility that would achieve controlled ignition and extended burn. As envisioned by the ITER Agreement, the ITER device would be the central element of an international, "one-step-to-a-reactor" strategy. Research goals include engineering studies of reactor materials, component designs for steady-state devices, and testing/proving commercial feasibility. Because of the concerns

of costs, and thanks to the advances in physics and technology made during the ITER EDA, there has been both increased incentive and opportunity to seek an attractive lower-cost design by modifying the detailed technical objectives. A reduced-cost and reduced-technical objectives ITER device is currently designed (ITER-FEAT); it is expected to achieve an energy gain,  $Q$ , of at least 10 and explore steady-state operation, at a direct capital cost of approximately 50% of the 1998 ITER design (<http://www.iter.org/>).

**JAERI:**

Acronym for Japan Atomic Energy Research Institute.

**JEBIS:**

Acronym for JAERI Electron Beam Irradiation Experiment.

**JET:**

Acronym for the Joint European Torus, a large tokamak located at the Culham Laboratory in Oxfordshire, England, jointly owned by the European Community. First device to achieve  $> 1$  MW of fusion power, in 1991, and the machine that has most closely approached  $Q=1$  for DT operation ( $Q=0.95$  in 1997). Largest tokamak currently in operation (<http://www.jet.efda.org/>).

**JFT:**

Acronym for JAERI Fusion Torus.

**JT-60 and JT-60U:**

A large Japanese tokamak, located north of Tokyo. JT-60U now in operation is an "upgrade" to JT-60 (<http://www-jt60.naka.jaeri.go.jp>).

**JUDITH:**

Acronym for Juelich Divertor Test Facility in Hot Cells.

**Larmor radius:**

Radius at which an ion gyrates around the field line along which it circuits the torus.

**Last closed flux surface (LCFS):**

The boundary between the core plasma (see entry) in a tokamak (or other device), where the field lines close back on themselves, and the SOL (see entry), where they run into a material wall. See also entry for separatrix.

**LHD:**

Acronym for Large Helical Device.

**Limiters:**

Structures placed in contact with the edge of a confined plasma, which are used to define the shape of the outermost magnetic surface (see entry for LCFS). See also entry for divertor.

**Magnetohydrodynamics (MHD):**

Physical model describing the properties of electrically conducting fluids interacting with magnetic and electric fields. MHD theory is relevant at relatively low frequencies and for distance scales larger than the Larmor radius (see entry).

**Magnetohydrodynamic instability:**

Class of unstable (growing, not damped) waves and other modes of oscillation, which are described by MHD theory.

**MAST:**

Acronym for Mega Amp Spherical Tokamak (<http://www.fusion.org.uk/mast/main.html>).

**Mean Free Path (for a given event, e.g., collisions):**

Average distance a particle travels between occurrences of the given event, e.g., between collisions. For collisions, the mean free path is roughly equal to unity divided by the product of the 'collision cross-section' and the 'particle density'.

*Melt-layer thickness:*

Even in the presence of vapour shielding, the reduced energy flux to the material surface is large enough to cause melting of metallic armours and the resulting melt-layer thickness can be one to two orders of magnitude higher than surface vaporisation losses. Therefore, the dynamic response of liquid metal layers exposed to various forces during the course of a disruption is another serious concern.

*Multi-faceted radiation from the edge (Marfe):*

An occasional toroidally-symmetric, but poloidally localised, region at the plasma edge producing high radiation levels from impurities, self-sustaining at relatively low temperatures.

*Neutron wall loading:*

Energy flux carried by fusion neutrons into the first physical boundary that surrounds the plasma (i.e., the first-wall).

*NBI:*

Acronym for Neutral Beam Injection.

*NRA:*

Acronym for Nuclear Reaction Analysis.

*NSTX:*

Acronym for National Spherical Tokamak eXperiment (<http://nstx.pppl.gov/index.shtml>).

*Ohmic heating:*

Heating that results from the flow of current through a medium with electrical resistance. In ohmically-heated plasmas, ions are heated almost entirely by transfer of energy from the hotter, more mobile electrons.

*ORMAK:*

Early tokamak built at Oak Ridge National Laboratory.

*Partially-detached plasmas:*

see plasma detachment.

*Particle recycling:*

In most tokamaks, the pulse length is at least an order of magnitude larger than the particle confinement time. Thus, on average, each plasma ion goes to the wall or limiter and returns to the plasma many times during the length of the discharge. This process is called "recycling". See also entry for high-recycling.

*Particle recycling coefficient:*

For a well-defined surface, the recycling coefficient ( $R$ ) is the ratio of the returning particle flux from the surface to the plasma to the incident flux to the surface from the plasma. Therefore, for  $R < 1$  the wall absorbs plasma particles,  $R > 1$  the wall fuels the plasma. The *global recycling coefficient* is an average over many local recycling coefficients at various surfaces inside a tokamak.

*PBX:*

Acronym for Princeton Beta eXperiment.

*PDX:*

Acronym for Poloidal Divertor eXperiment.

*Pedestal:*

In an H-mode plasma (see entry), there is a region of high confinement and steep density gradient near the edge of the plasma. This region acts as a platform (or "pedestal") to support the core of the plasma (which has lower confinement).

*Pellet injection/pellet injector:*

This is a device which accelerates (shoots) small (typically few mm diameter) frozen pellets of



hydrogen isotopes (or other elements); these are then launched at high speed (ca. 1000 m/s) into the core plasma. Used mainly for plasma fuelling but also for wall conditioning, plasma diagnostics and disruption control.

**PFC(s):**

Acronym for Plasma-Facing Component(s).

**PISCES:**

Acronym for the Plasma-Interaction with Surface-Components Experimental Station. Plasma simulator, at the University of San Diego in the United States (originally at University of California, Los Angeles), used to test materials and measure sputtering, retention etc. expected in tokamaks (<http://www-pisces.ucsd.edu/pisces/pisces.html>).

**Plasma detachment:**

Low temperature plasma regime where there is significant plasma pressure loss along field lines close to the target plate. This is usually accompanied by a significant decrease in incident power and plasma flux density. One refers to *full detachment* if the plasma is detached from the entire length of the divertor target; and to *partial-detachment*, (or to *semi-attached plasma*) if the plasma is detached over some of the divertor target surface (typically near the separatrix), but still attached elsewhere (see Fig. 88).

**Plasma elongation ( $\kappa$ ):**

Parameter indicating the degree to which the cross-section of a toroidal plasma is non-circular;  $\kappa=b/a$ , where "b" and "a" are the vertical and horizontal minor radii. As  $\kappa$  is increased, the confinement in relation to the total current improves, but the plasma also becomes more unstable to vertical displacements.

**Plasma inductance:**

Parameter relating the magnetic flux generated through the plasma to the current in the plasma.

**PLT:**

Acronym for Princeton Large Torus.

**PMI(s):**

Acronym for Plasma-Material Interaction(s).

**Poloidal direction:**

Around the radial half-section of a torus.

**Private flux region:**

In the divertor (see entry) region between the inner and outer separatrix from the X-point (see entry) to the target plates bound a region wherein the field lines are isolated. An ion formed in this "private region" will likely remain within the region.

**PSI-1:**

Plasma generator located in the Max-Planck-Institut fuer Plasmaphysic in Berlin used for investigation of plasma-boundary.

**PTE:**

Acronym for Preliminary Tritium Experiment - in JET in 1991.

**QSPA:**

Acronym for Quasi-Stationary Plasma Accelerators used for investigation of disruption erosion and damage of plasma-facing materials.

**Radiation damage:**

General term describing changes in physical and/or metallurgical properties of materials caused by atomic displacement and nuclear transmutation events occurring as a result of exposure to a radiation environment (such as the neutrons emitted from a fission or DT fusion reactor).

G. Federici, C.H. Skinner, et al.

**RBS:**

Acronym for Rutherford Backscattering Spectrometry.

**RF:**

Acronym for Radio-Frequency.

**RTE:**

Acronym for Remote Tile Exchange experiment - in JET in 1998.

**Runaway electrons:**

Those electrons in a plasma that gain energy from the toroidal electrical field at a faster rate than they lose it through collisions with other particles. These electrons tend to "run away" in energy (not position) from the cooler remainder of the background plasma, because the collision cross-section decreases as the particle's velocity increases, so that the faster the particle goes, the less likely it is to be stopped.

**Safety factor ( $q$ ):**

The number of times a field line goes around a torus toroidally for each time around poloidally. In a tokamak, this number is typically near unity in the centre of the plasma and between two and 6 or 8 at the edge. So-called because it helps to determine the resilience the plasma has against certain instabilities. The safety factor is the inverse of the rotational transform, and can be expressed mathematically as  $q = (r * B_t) / (R * B_p)$ , where  $r$  and  $R$  are the minor and major radii of the torus, respectively, and  $B_t$  and  $B_p$  are the toroidal and poloidal magnetic fields, respectively.

**Sawtooth:**

When a tokamak operates with enough current to achieve  $q < 1$  on the magnetic axis, the plasma parameters ( $n$ ,  $T$ ,  $B$ ) oscillate with a "sawtooth" waveform. The oscillation is localised to a region roughly within the  $q=1$  surface, and arises from internal MHD effects. Confinement is degraded within the sawtooth region.

**Scrape-off-layer (SOL):**

Outer layer of a plasma, which is affected ("scraped off") by a divertor or limiter. That is, the outer layer of a magnetically confined plasma where the field lines intersect a material surface (limiter or divertor plate) rather than close upon themselves. Plasma crossing into the SOL is rapidly lost since transport along the field is much faster than that across the field.

**SEM:**

Acronym for Scanning Electron Microscopy.

**Separatrix:**

In a divertor tokamak (and some other configurations), the last closed flux surface (see entry) is formed not by inserting an object (limiter) but by manipulating the magnetic field, so that some field lines take a topologically different route (through the divertor, rather than simply around the central plasma). The boundary between the field lines that close back on themselves and those that penetrate a material surface, is called the separatrix.

**SIMS:**

Acronym for Secondary Ion Mass Spectroscopy.

**Sputtering:**

Process by which atoms are ejected from a solid surface by bombardment with energetic particles.

**Sputtering yield:**

Number of target atoms sputtered per incident atoms/ions; varies with target and plasma species and energy.

**START:**

Acronym for the Small Tight Aspect Ratio Tokamak Located at Culham, England. This spherical

tokamak claims the record  $\beta$  value for a tokamak.

**Superconductor:**

A type of electrical conductor that permits a current to flow with zero resistance. Without superconducting coils, a toroidal magnetic-confinement fusion reactor would not be possible, because too much energy would be required to maintain the magnetic fields against resistive energy losses in the coil conductors.

**Supershot:**

A high confinement regime in TFTR beam-heated plasmas that was obtained after wall conditioning had depleted deuterium from the limiter.

**T-3, T-10...:**

A series of tokamaks built at the Kurchatov Institute in Moscow. T-3 was the first machine that demonstrated fusion relevant plasma temperatures and demonstrated the potential of the tokamak concept.

**TCV:**

Acronym for Variable Configuration Tokamak.

**TdeV:**

Acronym for Tokamak de Varennes, i.e., a small tokamak in Quebec, Canada, that has now been closed.

**TDS:**

Acronym for Thermal Desorption Spectroscopy.

**TEXT:**

Acronym for TEXas Tokamak.

**TEXTOR:**

Acronym for the Tokamak EXperiment for Technology Oriented Research. Medium-sized European tokamak located in Juelich, Germany. Research objectives include developing PFCs and studying effects of plasma-wall interactions (<http://www.kfa-juelich.de/ipp/>).

**TFR:**

Acronym for Torus Fontenay-aux-Roses.

**TFTR:**

Acronym for the Tokamak Fusion Test Reactor: Large tokamak at Princeton; first machine to use 50%-50% mix of DT fuel; current record holder for total fusion energy production. TFTR was the largest tokamak in the United States, but ceased operation in 1997 (<http://www.pppl.gov/tftr/>).

**Thermal quench time of disruptions:**

Is the characteristic time in which most of the plasma thermal energy is lost, primarily by conduction to the plasma-defining surfaces (limiter or divertor targets). During a thermal quench, the core plasma temperature typically falls, first to less than several hundred eV, and subsequently to less than 100 eV; 1-10 ms expected in ITER-class tokamaks. See also entry for current quench time.

**Tokamak:**

Acronym created from the Russian words, "TOroidalnaya KAmera ee MAgnitnaya Katushka" or Toroidal Chamber and Magnetic Coil.

**Tore Supra:**

It is the second largest tokamak in Europe, and is located in Cadarache (southern France). It uses superconducting toroidal field magnets. Tore Supra has a circular cross-section, which limits the achievable confinement time and experimental flexibility. In addition to developing superconducting technology, it concentrates on the physics of long pulses (<http://www-cad.cea.fr/r50.htm>).

*Toroidal direction:*

In the horizontal plane, around the vertical axis of the torus.

*TPE:*

Acronym for the Tritium Plasma Experiment, a plasma simulator used primarily for studies of tritium retention and effects in plasma-facing surfaces. TPE is presently being transferred from the Tritium System Test Assembly (TSTA) facility at Los Alamos National Laboratory to the Idaho National Environmental Engineering Laboratory in Idaho Falls, Idaho. TPE is operated by Sandia National Laboratories.

*Tritium-breeding ratio (TBR):*

The amount of tritium generated by the breeding blanket of a DT fusion reactor, divided by the amount of tritium burned in the reactor. A tritium breeding ratio greater than unity is necessary for self-sufficient fuelling.

*Tritium fractional burn-up:*

During normal operation of a DT tokamak, only a small fraction of the fuel will be consumed (i.e., burned by DT fusion reactions), the rest will be retained in the plasma-facing surfaces or pumped out and reprocessed. The tritium fractional burn-up,  $f_b$ , is defined as the ratio of the burn rate to the total rate of fuel loss from the vessel by either burning, pumping or retention. In existing tokamaks (e.g., TFTR and JET) this fraction was of order  $10^{-4}$ . In a next-step device like ITER, the tritium fractional burn-up will be of the order of few %.

*TZM :*

An alloy of molybdenum with 0.5%Ti, 0.1% Zr, which improves high-temperature properties by raising the recrystallisation temperature.

*Unipolar arc:*

Arc between a metal surface and a plasma in contact with it. Such an arc requires only one electrode and is maintained by the thermal energy of the electrons.

*Vapour shielding layer:*

During the initial stage of a plasma disruption, the energy deposited onto the exposed surface will cause ablation of the material and sudden formation of a vapour cloud above the exposed area. This vapour cloud, if well confined, will significantly reduce the subsequent net energy flux to the material surface, thus reducing vaporisation losses, by orders of magnitude.

*VDE:*

Acronym for Vertical Displacement Event. See entry for vertical instability.

*Vertical instability:*

A type of MHD ( $n=0$ ) instability where the plasma drifts vertically upward. Nearly all tokamaks (especially if D-shaped) are vertically unstable. Controlling this instability is possible in many cases, and is an important facet of machine design; control is often lost in the current quench phase of disruptions in D-shaped tokamaks, resulting in what is termed a vertical disruption or *vertical displacement event (VDE)*. Vertical instabilities give rise to halo effects (see entry for halo currents).

*Wall pumping:*

The term "wall pumping" is commonly used for the spontaneously occurring net particle removal by the wall during standard plasma operation, as well as for the induced pump-out effect that occurs when the plasma is suddenly moved to a part of the wall that is able to provide net particle absorption, usually the inboard wall.

*X-point:*

Place where the poloidal magnetic field vanishes in such a way that two flux surfaces appear to cross, e.g., where the main plasma joins the divertor region, or between magnetic islands.

$Z_{eff}$ :

It is the mean ion charge in the plasma

$$Z_{eff} = \frac{\sum n_i Z_i^2}{\sum n_i Z_i}$$

## 8. ACKNOWLEDGEMENTS

The authors gratefully acknowledge the many helpful conversations with many researchers (see names below) within the European Union, Japan, the Russian Federation, the United States, Canada and other countries, that have contributed in expanding on information available in the literature.

In particular, we would like to thank Masato Akiba, Igor Arkhipov, Vladimir Barabash, Rainer Behrisch, Harald Bolt, David Campbell, Rion Causey, Glenn Counsell, Jim Davis, Russell Doerner, Vladimir Filatov, Peter Franzen, Charles Gentile, Alexander Gorodetsky, Yoshi Hirooka, John Hogan, Chris Ibbott, Wolfgang Jacob, Guenter Janeschitz, Charles Kessel, Andre Kukushkin, Christinal Linsmeier, Vladimir Litunovsky, Alberto Loarte, Glen Longhurst, Hans Maier, Rajesh Maingi, Alexey Makhankov, Andrey Markin, Matej Mayer, Igor Mazul, Dennis Mueller, Nobuaki Noda, Richard Nygren, Horst Pacher, Ralf-Dieter Penzhorn, Michael Pick, Marek Rubel, Valeri Safronov, Gabriella Saibene, Roberta Sartori, Peter Stangeby, William Spears, Masayoshi Sugihara, Tetsuo Tanabe, Richard Tivey, Mike Ulrickson, Achim von Keudell, John Wesley, Phil West, Clement Wong, Chung Wu, Hermann Wuerz, Andrey Zakharov, Mardjan Zarrabian, Anatoly Zhitlukhin.

We owe a special thank to Kathy A. McCarthy, Dave A. Petti, W.J. Carmack and John P. Sharpe of the Idaho National Engineering Environmental Laboratory for their kind help in collecting and reviewing the available database on dust; Houyang Guo and Mike Stamp of JET, Volker Rohde, Arne Kallenbach and Karl Krieger of ASDEX-Upgrade, S. Higashijima, H. Kubo and Kei Masaki, of JT-60U, H.G. Esser, Albrecht Pospieszczyk, Egon Vietzke, J. von Seggern and Peter Wienhold of TEXTOR, and Philip Ghendrih of Tore Supra, for providing useful information from their respective machines for use in the review.

Finally, we would like to acknowledge the precious help of David Ignat, Andreas Schott and Ujwal S. Sathyam in the final typesetting of this manuscript.

This paper was prepared by authors from several institutions and was prepared in part as an account of work undertaken within the framework of the ITER EDA Agreement. The views and opinions expressed herein do not necessarily reflect those of the Parties to the ITER Agreement, the IAEA or any agency thereof. Dissemination of the information in this paper is governed by the applicable terms of the ITER EDA Agreement.

## References

- [1] Toschi, R., *Fus. Eng. Des.* **36** (1997) 1.
- [2] Loarte, A., et al., *Predicted ELM Energy Loss and Power loading in ITER-FEAT*, in Proc. 18<sup>th</sup> Conf. Plasma Phys. Contr. Nucl. Fus. Res., (Sorrento, Italy, 2000) Ed. IAEA Vienna, to appear in *Nucl. Fusion*.
- [3] Federici, G., et al., *J. Nucl. Mater.* **266-269** (1999) 14.
- [4] Skinner, C.H., et al., *Nucl. Fusion* **39** (1999) 271.
- [5] *Plasma-Surface Interactions in Controlled Fusion Devices* Elsevier, Amsterdam, published by *J. Nucl. Mater.*
- [6] *Volumes of Atomic and Plasma-Material Interaction Data for Fusion*, published by the International Atomic Energy Agency as supplement of *Nucl. Fusion*.
- [7] Post, D.E., and Behrisch, R., eds. *Physics of Plasma-Wall Interactions in Controlled Fusion*, in NATO ASI Series B: Physics, Plenum Press, New York (1986).
- [8] Stangeby, P.C., McCracken G.M., *Nucl. Fusion* **30** (1990) 1225.
- [9] Pitcher, C.S., Stangeby, P.C., *Plasma Phys. Contr. Fus.* **39** (1997) 779.
- [10] Stangeby, P.C., *The Plasma Boundary of Magnetic Fusion Devices*, April 2000, 712 pp, Institute of Physics Publishing, Bristol, England.
- [11] Behrisch, R., Bolt, H., Causey, R., *Plasma-facing materials*, *Nucl. Fusion*, to be submitted.
- [12] Abdou, M.A., et al., *Fus. Eng. Des.* **45** (1999) 145.
- [13] ITER Physics Basis, *Nucl. Fusion* **39** (1999) 2137.
- [14] Keilhacker, M., *Plasma Phys. Contr. Fus.* **29** (1987) 1401.
- [15] Lipschultz, B., et al., *Phys. Plasmas* **6** (1999) 1907.
- [16] Kukushkin, A.S., et al., *Contr. Plasma Phys.* **38** (1998) 20.
- [17] Parker, R., et al., *J. Nucl. Mater.* **241-243** (1997) 1.
- [18] Barabash, V., Federici, G., Matera, R., Raffray, A.R., and the ITER Home Teams, *Phys. Scripta T81* (1999) 74.
- [19] Janeschitz, G., et al., *Nucl. Fusion* **40** (2000) 1197.
- [20] Meade, D., *Nucl. Fusion* **14** (1974) 289.
- [21] Reiter, D., Wolf, G.H., Kever, H., *Nucl. Fusion* **30** (1990) 2141.
- [22] Behrisch, R., Prozesky V., *Nucl. Fusion* **30** (1990) 2166.
- [23] Wade, M.R., et al., *Nucl. Fusion* **38** (1998) 1839.
- [24] Goetz, J.A., et al., *Phys. Plasmas* **6** (1999) 1899.
- [25] Goetz, J.A., et al., *J. Nucl. Mater.* **266-269** (1999) 354.
- [26] Kallenbach, A., et al., *Nucl. Fusion* **35** (1995) 1231.
- [27] Umansky, M.V., Krasheninnikov, S.I., LaBombard, B., Lipschultz, B., Terry, J.L., *Phys. Plasmas* **6** (1999) 2791.
- [28] Chankin, A.V., et al., *Interpretation of SOL flows in JET using EDGE2D code calculations*, in Proc. 14<sup>th</sup> Int. Conf. Plasma Surf. Interact. in Contr. Fus. Dev., Rosenheim, Germany, May 22-26, 2000, to appear in *J. Nucl. Mater.*
- [29] Erents, S.K., *Plasma Phys. Contr. Fus.* **42** (2000) 905.
- [30] Asakura, N., *Phys. Rev. Lett.* **84** (2000) 3093.
- [31] Gouge, M.J., *Fus. Technol.* **34** (1998) 435.
- [32] Milora, S.L., Houlberg, W.A., Lengyel L.L., Mertens, V., *Nucl. Fusion* **35** (1995).
- [33] Skinner, C.H., et al., *Phys. Plasmas* **5** (1998) 1062.
- [34] Winter, J., *J. Nucl. Mater.* **176-177** (1990) 14.

- [35] Ongena, J., et al., *Confinement in discharges with impurity seeding in TEXTOR-94 and TFTR*, in Proc. 24<sup>th</sup> Eur. Phys. Soc. Conf. on Contr. Fus. and Plasma Phys., (Berchtesgaden, Germany, 1997) edited by the Eur. Phys. Soc., Geneva, Vol. 21A part 4 (1997) 1693.
- [36] Dylla, H.F., Cohen, S.A., Rossnagel, S.M., J. Vac. Sci. Technol. **17** (1980) 286.
- [37] Poschenrieder, W., Staudenmaier, G., Staib, Ph., J. Nucl. Mater. **93-94** (1980) 322.
- [38] Waelbroeck, F., Winter, J., Wienhold, P., J. Vac. Sci. Technol. **A2** (1984) 1521.
- [39] Sakamoto, Y., et al., in Proc. 12<sup>th</sup> Symp. Fus. Technol., (Juelich, Germany, 1982), Vol. 1 (1983) 347.
- [40] Sagara, A., et al., J. Plasma Fus. Res. **75** (1999) 263.
- [41] Esser, H.G., et al., J. Nucl. Mater. **241-243** (1997) 861.
- [42] Dietz, K.J., Walbroeck, F., Wienhold, P., *Origin of impurities in hydrogen plasmas*, KFS Juelich Inst. fur Plasmaphysik (Germany) Report JUEL-1448 (1977).
- [43] Greenwald, M., et al., Nucl. Fusion **37** (1997) 793.
- [44] Jackson, G.L., et al., Phys. Rev. Lett. **67** (1991) 3098.
- [45] Owen, L.W., et al., J. Nucl. Mater. **266-269** (1999) 891.
- [46] Higashijima, S., J. Nucl. Mater. **220-222** (1995) 375.
- [47] Samm, U., et al., J. Nucl. Mater. **220-222** (1995) 25.
- [48] Esser, H.G., et al., J. Nucl. Mater. **186** (1992) 217.
- [49] Sykes, A., et al., *First Results from MAST*, in Proc. 18<sup>th</sup> Conf. Plasma Phys. Contr. Nucl. Fus. Res., (Sorrento, Italy, 2000) Ed. IAEA Vienna, to appear in Nucl. Fusion.
- [50] Skinner, C.H., et al., *Effect of boronisation on ohmic plasmas in NSTX*, to be submitted to Nucl. Fusion.
- [51] Mansfield, D.K., et al. Phys. Plasmas **3** (1996) 1892.
- [52] Mansfield, D.K., et al. Phys. Plasmas **2** (1995) 4252.
- [53] Strachan, J.D., et al., J. Nucl. Mater. **217** (1994) 145.
- [54] Moir, R.W., Nucl. Fusion **37** (1997) 557.
- [55] Zakharov, L., Bull. Am. Phys. Soc. **44** (1999) 313.
- [56] Saibene, G., et al., J. Nucl. Mater. **220-222** (1995) 617.
- [57] Rohde, V., et al., *Comparison of boronisation and siliconisation in ASDEX Upgrade*, in Proc 26<sup>th</sup> Eur. Phys. Soc. Conf. on Contr. Fus. and Plasma Phys., (Maastricht, The Netherlands, 1999), edited by the Eur. Phys. Soc., Geneva, to appear.
- [58] Gauthier, E., et al., J. Nucl. Mater. **196-198** (1992) 637.
- [59] Strachan, J. D., Nucl. Fusion **39** (1999) 1093.
- [60] Ernst, D.R., et al., Phys. Rev. Lett. **81** (1998) 2454.
- [61] Monk, R.D., for the JET Team, Nucl. Fusion **39** (1999) 1751.
- [62] Matthews, G.F., et al., J. Nucl. Mater. **196-198** (1992) 374.
- [63] Whyte, D.G., Coad, J.P., Franzen, P., Maier, H., Nucl. Fusion **39** (1999) 1025.
- [64] Spitzer, L., US Atomic Energy Commission Report NYO-993 (PM-S-1).
- [65] Spitzer, L., Phys. Fluids **1** (1958) 253.
- [66] Burnett, C.R., et al., Phys. Fluids **1** (1958) 438.
- [67] Craston, J.L., et al., *Peaceful Uses of Atomic Energy* (Proc. 2<sup>nd</sup> Int. Conf. Geneva, 1958) Vol. 32, U.N., Geneva (1958) 414.
- [68] Simonov, V.A., et al., in Plasma Phys. Contr. Nucl. Fus. Res. (Proc. Conf. Salzburg, 1961), Nucl. Fusion Supplement part I, IAEA, Vienna (1962) 313.
- [69] Behrisch, R., Nucl. Fusion **12** (1972) 695.
- [70] McCracken, G.M., Stott, P.E., Nucl. Fusion **19** (1979) 889.



## Review: Plasma-material interactions

- [71] Garbunov, E.P., et al., 4<sup>th</sup> European Conf. on Contr. Fus. and Plasma Phys., Rome, Italy, Nat. Nucl. Energy Committee (1970) 19.
- [72] Peacock, N.J., et al., Nature, **224**, No.5218, 1 Nov. (1969) 488.
- [73] Behrisch, R., *Surface erosion by electrical arcs*, in Physics of Plasma-Wall Interactions in Controlled Fusion, Ed. by Post, D.E., and Behrisch, R., in NATO ASI Series B: Physics, Plenum Press, New York (1986) p. 495.
- [74] TFR Group, Nucl. Fusion **16** (1976) 473.
- [75] Ellis, R.A., Nucl. Fusion **25** (1985) 1145.
- [76] Zuhr, R.A., et al., J. Nucl. Mater. **85-86** (1979) 979.
- [77] Ascoli-Bartoli, U., et al., 5<sup>th</sup> Intern. Conf. on Plasma Phys. Contr. Nucl. Fus. Res., IAEA Vienna, Austria, part I (1975) 191.
- [78] TFR Group, in Plasma-Wall Interactions (Proc. Int. Symp., Julich 1976), Pergamon Press, Oxford (1977) 3.
- [79] Dimock, D., et al., 4<sup>th</sup> Conf. on Plasma Phys. and Contr. Thermonucl. Fusion. IAEA Vienna, Austria, part I (1971) 451.
- [80] Bol, K., et al., in Plasma Phys. Contr. Nucl. Fus. Res. (Proc. 7<sup>th</sup> Int. Conf., Innsbruck, 1978), Vol. 1, IAEA, Vienna (1979) 11.
- [81] Meade, D., et al., in Plasma Phys. Contr. Nucl. Fus. Res. (Proc. 8<sup>th</sup> Int. Conf., Brussels, 1980), Vol. 1, IAEA, Vienna (1981) 665.
- [82] DIVA Group, Nucl. Fusion **18** (1978) 1619.
- [83] Meservey, E.B., et al., Nucl. Fusion **16** (1976) 593.
- [84] Bardet, R., et al., Nucl. Fusion Suppl. **2** (1977) 259.
- [85] Stodiek, W., Grove, D.J., Kessler, J.O., in Plasma Phys. Contr. Nucl. Fus. Res. (Int. Conf., Culham 1965), IAEA, Vienna, Vol. 2 (1965) 687.
- [86] Princeton Plasma Physics Laboratory, Annual Report MATT-Q-23 (1965) 73.
- [87] Nagami, M., et al., J. Nucl. Mater. **76-77** (1978) 521.
- [88] Bortnikov, A.V., et al., in Contr. Fus. and Plasma Phys. (Proc. 8<sup>th</sup> Eur. Conf., Prague, 1977), Vol. 1 (1977) 41.
- [89] Stott, P.E., et al., Nucl. Fusion **17** (1977) 481.
- [90] Mahdavi, A.M., et al., Phys. Rev. Lett. **22** (1981) 1602.
- [91] Keilhacker, M., et al., Phys Scripta **T2/2** (1982) 443.
- [92] Kugel, H.W., Ulrickson, M., Nucl. Technol. Fus. **2** (4) (1982) 712.
- [93] Bol, K., Okabayashi, M., Fonck, R., Nucl. Fusion **25** (1985) 1149.
- [94] Samm, U., and the TEXTOR-94 Team, Plasma Phys. Contr. Fus. **41** (1999) B57.
- [95] Chappuis, P., and the Tore-Supra Team, J. Nucl. Mat. **241-243** (1997) 27.
- [96] Gunn, J.P., et al., Plasma Phys. Contr. Fus. **41** (1999) B243.
- [97] Meservey, E.B., et al., J. Nucl. Mater. **93-94** (1980) 267.
- [98] Eubank, H., et al., *PLT neutral beam heating results*, in Proc. 7<sup>th</sup> Conf. on Plasma Phys. Contr. Nucl. Fus. Res. held by the IAEA in Innsbruck (Austria) 1978, IAEA, Vienna Vol. 1 (1979) 167.
- [99] Burchell, T.D., Carbon **34** (1996) 297.
- [100] Thomas, P.R., et al., J. Nucl. Mater. **176-177** (1990) 3.
- [101] Mioduszewski, P.K., Nucl. Fusion **26** (1986) 1171.
- [102] Hackmann, J., Uhlenbusch, J., J. Nucl. Mater. **128-129** (1984) 418.
- [103] Hutchinson, I.H., et al., Phys. Plasmas **1** (1994) 1511.
- [104] Apicella, M.L., Nucl. Fusion **37** (1997) 381.

- [105] Jackson, G.L., et al., J. Nucl. Mater. **220** (1995) 173.
- [106] McSmith, M.D., et al., Fus. Technol. **26** (1994) 498.
- [107] Ulrickson, M., the JET team and TFTR team, J. Nucl. Mater. **176-177** (1990) 44.
- [108] Strachan, J.D., et al., J. Nucl. Mater. **196-198** (1992) 28.
- [109] Whyte, D.G., et al., J. Nucl. Mater. **241-243** (1997) 660.
- [110] Guo, H.Y., et al., J. Nucl. Mater. **241-243** (1997) 385.
- [111] Shimizu, K., Takizuka, T., Sakasai, A., J. Nucl. Mater. **241-243** (1997) 167.
- [112] Wampler, W.R., et al., J. Nucl. Mater. **266-269** (1999) 217.
- [113] Pappas, D., et al., J. Nucl. Mater. **266-269** (1999) 635.
- [114] Krieger, K., Maier, H., Neu, R., and the ASDEX Upgrade Team, J. Nucl. Mater. **266-269** (1999) 207.
- [115] Wada, M., et al., J. Nucl. Mater. **241-243** (1997) 799.
- [116] Neu, R., et al., *Plasma operation with tungsten tiles at the central column of the ASDEX-Upgrade*, in Proc. 14<sup>th</sup> Int. Conf. Plasma Surf. Interact. in Contr. Fus. Dev., Rosenheim, Germany, May 22-26, 2000, to appear in J. Nucl. Mater.
- [117] Technical Basis for the ITER Final Design Report, Cost Review and Safety Analysis, (FDR) ITER EDA Documentation Series No. 16, IAEA, Vienna (1998).
- [118] *Technical Basis for the ITER-FEAT Outline Design*, to be published by IAEA, Vienna (2000).
- [119] Wesson, J., *Tokamaks*, 2<sup>nd</sup> Edition, The Oxford Engineering Science Series, published by Oxford University Press, Oxford, 1997.
- [120] Hawryluk, R.J., Phil. Trans. R. Soc. Lond. A **357** (1999) 443.
- [121] Keilhacker, M., et al., Nucl. Fusion **39** (1999) 209.
- [122] Jacquinet, J., et al., Nucl. Fusion **39** (1999) 235.
- [123] Keilhacker, M., Watkins, M.L., and the JET Team, J. Nucl. Mater. **266-269** (1999) 1.
- [124] Van Houtte, D., and Equipe Tore Supra, Nucl. Fusion **33** (1993) 137.
- [125] Zushi, H., et al., Nucl. Fusion **40** (2000) 1183.
- [126] Levinton, F.M., Bell, R.E., Batha, S.H., Synakowski, E.J., Zarnstorff, M.C., Phys. Rev. Lett. **80** (1998) 4887.
- [127] Levinton, F.M., Batha, S.H., Synakowski, E.J., Zarnstorff, M.C., Rev. Sci. Instr. **68** (1997) 926.
- [128] Bell, R.E., Rev. Sci. Instr. **68** (1997) 1273.
- [129] Bell, R.E., Levinton, F.M., Batha, S.H., Zarnstorff, M.C., Phys. Rev. Lett. **81** (1998) 1429.
- [130] Engelman, F., Conf. Rep. In Nucl. Fusion **40** (2000) 1025.
- [131] Post, D.E. et al., ITER Physics, ITER Documentation Series, No. **21**, IAEA, Vienna, 1991.
- [132] ITER EDA Agreement and Protocol 1, ITER EDA Documentation Series No. **1**, IAEA, Vienna (1992).
- [133] Aymar, R., *The ITER reduced cost design*, to appear in Fus. Eng. and Des.
- [134] Shimada, M., et al., *Physics design of ITER-FEAT*, Toki Conference, Jan. 2000.
- [135] Zohm, H., Plasma Phys. Contr. Fus. **38** (1996) 105.
- [136] Federici, G., et al., J. Nucl. Mat. **283-287** (2000) 110.
- [137] Guilhem, D., et al., J. Nucl. Mater. **241-243** (1997) 542.
- [138] Federici, G., Raffray, A.R., J. Nucl. Mater. **244** (1997) 101.
- [139] Janeschitz, G., et al., J. Nucl. Mater. **220-222** (1995) 73.
- [140] Kukushkin, A.S., et al., *Analysis of ITER divertor performance and ITER tokamak edge parameter database*, in Proc. 16<sup>th</sup> Int. IAEA Conf. on Plasma Phys. Contr. Nucl. Fus. Res. (Montreal, Canada, 1996), Ed. IAEA Vienna, Vol. 2 (1997) 987.

- [141] Mertens, V., et al., *Edge and divertor physics in ASDEX-Upgrade with emphasis on density limit characteristics*, in Proc. 16<sup>th</sup> Int. IAEA Conf. on Plasma Phys. Contr. Nucl. Fus. Res. (Montreal, Canada, 1996), Ed. IAEA Vienna, Vol. 1 (1997) 413.
- [142] Loarte, A., et al., Nucl. Fusion **38** (1998) 331.
- [143] Kallenbach, A., et al., Nucl. Fusion **39** (1999) 901.
- [144] Mahdavi, M.A., et al., *Divertor plasma physics experience on the DIII-D tokamak*, in Proc. 16<sup>th</sup> Int. IAEA Conf. on Plasma Phys. Contr. Nucl. Fus. Res. (Montreal, Canada, 1996), Ed. IAEA Vienna, Vol. 1 (1997) 397.
- [145] Milora, S.L., et al., Nucl. Fusion **35** (1998) 331.
- [146] Baylor, L.R., et al., J. Nucl. Mater. **266-269** (1999) 457.
- [147] Lang, P.T., Phys. Rev. Lett. **79** (1997) 1487.
- [148] Baylor, L.R., et al., Phys. Plasmas **7** (2000) 1878.
- [149] Hogan, J.T., *Wall saturation in Tore Supra*, in Proc. IEA Workshop on Tritium Experience in Large Tokamaks, Application to ITER, (Princeton, USA, 1998). Conf. Rep. in Nucl. Fusion **39** (1999) 271.
- [150] Bosch, H.S., et al., Plasma Phys. Contr. Fus. **41** (1999) A401.
- [151] Sakasai, A., et al., in Proc. 17<sup>th</sup> Conf. Plasma Phys. Contr. Nucl. Fus. Res., (Yokohama, Japan, 1998) Ed. IAEA Vienna, to appear.
- [152] Kukushkin, A.S., et al., *Divertor performance in reduced technical-objectives reduced-cost ITER*, in Proc 26<sup>th</sup> Eur. Phys. Soc. Conf. on Contr. Fus. and Plasma Phys., (Maastricht, The Netherlands, 1999), edited by the Eur. Phys. Soc., Geneva, to appear.
- [153] Brooks, J.N., Alman, D., Federici, G., Ruzic, D.N., Whyte, D.G., J. Nucl. Mater. **266-269** (1999) 58.
- [154] Pacher, H.D., et al., J. Nucl. Mater. **241-243** (1997) 255.
- [155] Lipschultz, B., et al., *Molybdenum sources and transport with ICRF heating in Alcator C-Mod*, in Proc. 14<sup>th</sup> Int. Conf. Plasma Surf. Interact. in Contr. Fus. Dev., Rosenheim, Germany, May 22-26, 2000, to appear in J. Nucl. Mater.
- [156] Verbeek, H., Stober, J., Coster, D.P., Eckstein, W., Schneider, R., Nucl. Fusion **38** (1998) 1789.
- [157] Federici, G., et al., *Assessment of erosion and tritium co-deposition in ITER FEAT*, in Proc. 14<sup>th</sup> Int. Conf. Plasma Surf. Interact. in Contr. Fus. Dev., Rosenheim, Germany, May 22-26, 2000, to appear in J. Nucl. Mater.
- [158] Oren, L., Taylor, R.J., Nucl. Fusion **17** (1977) 1143.
- [159] Esser, H.G., et al., J. Nucl. Mater. **266-269** (1999) 240.
- [160] Nachtrieb, R.T., et al., J. Nucl. Mater. **266-269** (1999) 896.
- [161] Saidoh, M., et al., Jpn. J. Appl. Phys. **32** (1993) 3276.
- [162] Yamage, M., et al., J. Nucl. Mater. **220-222** (1995) 743.
- [163] Mansfield, D., *Observations concerning the injection of a lithium aerosol into the edge of TFTR discharges*, Report PPPL-3526, Princeton Plasma Physics Laboratory, Princeton NJ.
- [164] Schueller, F.C., Plasma Phys. Contr. Fus. **37** (1995) A135.
- [165] Wesley, J., Fujisawa, N., Ortolani, S., Putvinski, S., Rosenbluth, M.N., *Disruption, vertical displacement event and halo current characterisation for ITER*, in Proc. 16<sup>th</sup> Int. IAEA Conf. on Plasma Phys. Contr. Nucl. Fus. Res. (Montreal, Canada, 1996), Ed. IAEA Vienna, Vol. 2 (1997) 971.
- [166] Granetz, R.S., et al., Nucl. Fusion **36** (1996) 545.
- [167] Wesley, J., Fujisawa, N., Putvinski, S., Rosenbluth, M.N., *Assessment of disruption and*

- disruption-related physics basis for ITER*, in Proc. 17<sup>th</sup> IEEE/NPSS Symp. Fus. Eng., (San Diego, USA, 1997) Ed. IEEE, Piscataway New Jersey, IEEE 97CH36131, Vol. 1 (1998) 483.
- [168] Hassanein, A., Konkashbaev, I., *Erosion damage of nearby plasma-facing components during a disruption on the divertor plate*, in Proc. of the 19<sup>th</sup> Symp. Fus. Technol., (Lisbon, Portugal, 1998) Ed. Varandas, C., and Serra, F., Elsevier Science, Vol. 1 (1997) 379.
- [169] Martin, G., *personal communication on localization of photo-neutron activated regions on the Tore Supra inboard limiter* (1997).
- [170] Nygren, R.E., et al., J. Nucl. Mater. **241-243** (1997) 522.
- [171] Leonard, A.W., et al., J. Nucl. Mater. **266-269** (1999) 109.
- [172] Hill, D.N., J. Nucl. Mater. **241-243** (1997) 182.
- [173] Gauthier, E., et al., *Energy and power deposition on divertor during ELMs*, in Proc. 14<sup>th</sup> Int. Conf. Plasma Surf. Interact. in Contr. Fus. Dev., Rosenheim, Germany, May 22-26, 2000, to appear in J. Nucl. Mater.
- [174] Taylor, P.L., et al., Phys. Plasmas **6** (1999) 1872.
- [175] Yoshino, R., et al., Plasma Phys. Contr. Fus. **39** (1997) 313.
- [176] Yoshino, R., et al., *Disruptions amelioration experiments in JT-60 and JET*, in Proc. 15<sup>th</sup> Int. IAEA Conf. on Plasma Phys. Contr. Nucl. Fus. Res., (Seville, Spain, 1994), Ed. IAEA Vienna, Vol. 1 (1995) 685.
- [177] Yoshino, R., Tokuda, S., Kawano, Y., Nucl. Fusion **39** (1999) 151.
- [178] Pautasso, G., et al., Nucl. Fusion **36** (1996) 1291.
- [179] Pautasso, G., et al., *Predictions and mitigation of disruptions in ASDEX-U*, in Proc. 14<sup>th</sup> Int. Conf. Plasma Surf. Interact. in Contr. Fus. Dev., Rosenheim, Germany, May 22-26, 2000, to appear in J. Nucl. Mater.
- [180] Kellman, A.G., et al., *Disruption studies in DIII-D*, in Proc. 16<sup>th</sup> Int. IAEA Conf. on Plasma Phys. Contr. Nucl. Fus. Res. (Montreal, Canada, 1996), Ed. IAEA Vienna, Vol. 1 (1997) 739.
- [181] Whyte, D.G., et al., *Energy balance, radiation and stability during rapid plasma termination via impurity pellet injection on DIII-D*, in Proc. 24<sup>th</sup> Eur. Phys. Soc. Conf. on Contr. Fus. and Plasma Phys., (Berchtesgaden, Germany, 1997), Ed. Eur. Phys. Soc., Geneva, Vol. 21A - part 3. (1997) 1137.
- [182] Granetz, R.S., et al., *Disruptions, halo currents and killer pellets in Alcator C-Mod*, Proc. 16<sup>th</sup> Int. IAEA Conf. on Plasma Phys. Contr. Nucl. Fus. Res. (Montreal, Canada, 1996), Ed. IAEA Vienna, Vol. 1 (1997) 757.
- [183] Schmidt, G.L., *Potential safe termination by injection of polypropylene pellets in JET*, in Proc. 22<sup>nd</sup> Eur. Phys. Soc. Conf. on Contr. Fus. and Plasma Phys., (Bournemouth, UK, 1995), Ed. Eur. Phys. Soc., Geneva, Vol. 19C - part 4 (1995) 21.
- [184] Mueller, D., et al., Fus. Technol. **30** (1996) 251.
- [185] Schmidt, G.L., Frederickson, E., *personal communication on impurity injection on TFTR*, in *U.S. disruption physics R&D report for FY 1997* (U.S. ITER Home Team Report ITER/US/97/PH-14, August 1997.)
- [186] Whyte, D.G., et al., Phys. Rev. Lett. **81** (1998) 4392.
- [187] Putvinski, S., et al., J. Nucl. Mater. **241-243** (1997) 316.
- [188] Jernigan, T.C., et al., Bull. Am. Phys. Soc. **43** (1998) 1890.
- [189] Rosenbluth, M., Putvinski, S.V., Parks, P.B., Nucl. Fusion **37** (1997) 955.
- [190] Parks, P.B., Rosenbluth, M.N., Putvinski, S.V., Evans, T.E., Fus. Technol. **35** (1998) 267.
- [191] Jardin, S.C., et al., Nucl. Fusion **40** (2000) 923.
- [192] Takase, Y., et al., Phys. Plasmas **4** (1997) 1647.

- [193] Suttrop, W., et al., *Plasma Phys. Contr. Fus.* **42** (2000) A97.
- [194] Leonard, A.W., *Tolerable ELMs at High Density in DIII-D*, to appear in *J. Nucl. Mater.*
- [195] La Marche, P.H., et al., *Fus. Technol.* **26** (1994) 427.
- [196] Saville, C., et al., *Fus. Technol.* **28** (1995) 1078.
- [197] Nagy, A., et al., *TFTR tritium accounting system for DT operation*, in Proc. 16<sup>th</sup> IEEE/NPSS Symp. Fus. Eng., (Champaign, USA, 1995) Ed. IEEE, Piscataway New Jersey, IEEE 95CH35852, Vol. 2 (1996) 573.
- [198] Bell, A.C., Wykes, M., Green, B.J., *Fus. Eng. Des.* **19** (1992) 169.
- [199] DeLooper, J., *Fus. Technol.* **26** (1994) 1051.
- [200] Proc. IEA Workshop on Tritium Experience in Large Tokamaks, Application to ITER, (Princeton, USA, 1998). Conf. Rep. in *Nucl. Fusion* **32** (1999) 271.
- [201] Skinner, C.H., et al., *J. Nucl. Mater.* **266-269** (1999) 940.
- [202] Mueller, D., et al., *Tritium retention and removal on TFTR*, in Proc. 17<sup>th</sup> IEEE/NPSS Symp. Fus. Eng., (San Diego, USA, 1997) Ed. IEEE, Piscataway New Jersey, IEEE 97CH36131, Vol. 1 (1998) 279.
- [203] Andrew, P.L., et al., *Fus. Eng. Des.* **47** (1999) 233.
- [204] Andrew, P.L., et al., *J. Nucl. Mater.* **266-269** (1999) 153.
- [205] Causey, R.A., Chrisman, W.L., Hsu, W.L., Anderl, R., A., Wishard, B., *J. Vac. Sci. Technol.* **A7** (1989) 1078.
- [206] Causey, R.A., Wampler, W.R., Walsh, D., *J. Nucl. Mater.* **176-177** (1990) 987.
- [207] Chiu, S., Haasz, A.A., *J. Vac. Sci. Technol.* **A9** (1991) 747.
- [208] Haasz, A.A., Davis, J.W., *J. Nucl. Mater.* **256** (1998) 65.
- [209] Davis, J.W., Haasz, A.A., *J. Nucl. Mater.* **266-269** (1999) 478.
- [210] Haasz, A.A., Chiu, S., Pierre, J.E., Gudimenko, Y.I., *J. Vac. Sci. Technol.* **A14** (1996) 184.
- [211] Federici, G., et al., *Fus. Eng. Des.* **39-40** (1998) 445.
- [212] Counsell, G.F., Wu, C.H., *In-situ detection and removal of carbon debris - a challenge for the next-step fusion device*, to appear in *Phys. Scripta*.
- [213] Wampler, W.R., et al., *Long-term Retention of Deuterium and Tritium in Alcator C-Mod*, in Proc. 18<sup>th</sup> IEEE/NPSS Symp. on Fus. Eng. (Albuquerque, Oct. 6-10, 1999), Ed. IEEE, Piscataway - New Jersey, IEEE 99CH3705 (1999) 267.
- [214] Najmabadi, F., et al., *Fus. Eng. Des.* **38** (1997) 3.
- [215] Gouge, M., et al., *Fus. Technol.* **28** (1995) 1644.
- [216] Barabash, V., Federici, G., Roedig, M., Snead, L.L., Wu, C.H., *J. Nucl. Mat.* **283-287** (2000) 138.
- [217] Ho, S.K., Abdou, M.A., *Fus. Eng. Des.* **31** (1996) 323.
- [218] Cheng, E.T., et al., *Fus. Eng. Des.* **38** (1998) 219.
- [219] Rutherford, P., *personal communication (1998)*.
- [220] El-Guebaly, L.A., and the ARIES Team., *Fus. Eng. Des.* **38** (1997) 139.
- [221] Gruen, M., *The chemistry of fusion technology*, Plenum Press, New York - London, 1992.
- [222] Federici, G., Wu, C.H., Raffray, A.R., Billone, M.C., *J. Nucl. Mater.* **187** (1992) 1.
- [223] Raffray, A.R., Billone, M.C., Federici, G., Tanaka, S., *Fus. Eng. Des.* **28** (1995) 240.
- [224] *Design Technology of Fusion Reactors*, Akiyama, M., Ed., World Scientific, Singapore, 1991.
- [225] Abdou, M.A., Vold, E.L., Gung, C.Y., Youssef, M.Z., Shin, K., *Fus. Technol.* **9** (1986) 250.
- [226] Asaoka, Y., Okano, K., Yoshida, T., Tomabechei, K., *Fus. Technol.* **30** (1996) 853.
- [227] Kuan, W., Abdou, M.A., *Fus. Technol.* **35** (1999) 309.
- [228] Murdoch, D.K., Day, Ch., Gierszewski, P., Penzhorn, R.D., Wu, C.H., *Fus. Eng. Des.* **46**

- (1999) 255.
- [229] Kessel, C. personal communication.
- [230] McCarthy, K.A., Petti, D.A., Carmack, W.J., Smolik, G.R., Fus. Eng. Des. **42** part. C (1998) 45.
- [231] McCarthy, K. A., Petti, D. Fus. Technol. **34** (1998) 390.
- [232] Petti, D.A., et al., J. Nucl. Mater. **233-237** (1996) 37.
- [233] Piet, S.J., Costley, A., Federici, G., Heckendorn, F., Little, R., *ITER tokamak dust-limits, production, removal, surveying*, in Proc. 17<sup>th</sup> IEEE/NPSS Symp. Fus. Eng., (San Diego, USA, 1997) Ed. IEEE, Piscataway New Jersey, IEEE 97CH36131, Vol. 1 (1998) 167.
- [234] Carmack, W.J., Smolik, G.R., Anderl, R.A., Pawelko, R.J., Hembree, P.B., Fus. Technol. **34** (1998) 604.
- [235] Peacock, A.T., et al., J. Nucl. Mater. **266-269** (1999) 423.
- [236] Anderl, R.A., Scaffidi-Argentina, F., Davydov, D., Pawelko, R.J., Smolik, G.R., J. Nucl. Mat. **283-287** (2000) 1463.
- [237] Petti, D.A., Smolik, G.R., Anderl, R.A., J. Nucl. Mat. **283-287** (2000) 1390.
- [238] Gaeta, M.J., *Tokamak dust explosion hazard examination and oxidation database review for ITER*, ITER Report, ITER/US/94/TE/SA-11, Sept. 1, 1994.
- [239] Piet, S.J., Federici, G., *ITER white paper on integrated picture of in-vessel tritium and dust*, ITER Report, S 81 RI 13 96-06-28 W 1.4, July 21, 1996.
- [240] Technical Basis for the ITER Interim Design Report, Cost Review and Safety Analysis, ITER EDA Documentation Series No. 7, IAEA, Vienna (1996).
- [241] Winter, J., Plasma Phys. Contr. Fus. **40** (1998) 1201.
- [242] Winter, J., Gebauser, G., J. Nucl. Mater. **266-269** (1999) 228.
- [243] Cheng, Y.S., et al., Health Physics **76** (1999) 120.
- [244] Campbell, D.J., and the JET Team, J. Nucl. Mater. **241-243** (1997) 379.
- [245] Neu, R., et al., J. Nucl. Mater. **241-243** (1997) 678.
- [246] Kurz, C., et al., J. Nucl. Mater. **220-222** (1995) 963.
- [247] Lipschultz, B., et al., J. Nucl. Mater. **266-269** (1999) 635.
- [248] Meade, D.M., et al., *Mission and design of the Fusion Ignition Research Experiment*, 18<sup>th</sup> IAEA Fusion Energy Conference, Sorrento Italy, 4-10 October, 2000.
- [249] Raffray, A.R., et al., Fus. Eng. Des. **45** (1999) 377.
- [250] Barabash, V., Kalinin, G., Matera, R., *Joining technologies for the plasma-facing components of ITER*, in Proc. 20<sup>th</sup> Symp. Fus. Technol. (Marseille, France, 1998), Ed. Beaumont, B., et al., Vol. 1 (1998) 215.
- [251] Schlosser, J., et al., Fus. Eng. Des. **39-40** (1998) 235.
- [252] Barabash, V., et al., J. Nucl. Mat. **283-287** (2000) 1248.
- [253] Vieider, G., et al., Fus. Eng. Des. **46** (1999) 221.
- [254] Merola, M., et al., J. Nucl. Mat. **283-287** (2000) 1068.
- [255] Nygren, R.E., et al., *High heat flux tests on heat-sinks armoured with tungsten rods*, Fus. Eng. Des. to appear.
- [256] *Opportunities in the Energy Science Program*, prepared by the Fusion Energy Science Advisory Committee for the Office of Science of the U.S. Department of Energy, June 1999.
- [257] Parker, R., Nucl. Fusion **40** No. 3Y (2000) 473.
- [258] Janeschitz, G., *Overview of the divertor design and its integration into RTO/RC-ITER*, Fus. Eng. Des., to appear.
- [259] Ioki, K., et. al., *First wall-blanket and vacuum vessel for RTO/RC-ITER*, to appear in Fus.

- Eng. Des.
- [260] Ioki, K., et al., *J. Nucl. Mat.* **283-287** (2000) 957.
- [261] Cardella, A., et al., *Fus. Eng. Des.* **43** (1998) 75.
- [262] Arkhipov, I., et al., *Laboratory experiments on transport and condensation of hydrogen radicals and its application to tritium assessment in the ITER HOT liner design*, in Proc. 14<sup>th</sup> Int. Conf. Plasma Surf. Interact. in Contr. Fus. Dev., Rosenheim, Germany, May 22-26, 2000, to appear in *J. Nucl. Mater.*
- [263] Keudell, A. von, et al., *Surface reactions of hydrocarbon-radicals: suppression of the re-deposition in fusion experiments via a divertor liner*, in Proc. 14<sup>th</sup> Int. Conf. Plasma Surf. Interact. in Contr. Fus. Dev., Rosenheim, Germany, May 22-26, 2000, to appear in *J. Nucl. Mater.*
- [264] Makhankov, A., et al., *Design of a Radiative Semi-transparent Liner for the ITER Divertor Cassette*, to appear in *Fus. Eng. Des.*
- [265] Ibbott, C., et al., SOFT-2000, Madrid, Spain, to appear in *Fus. Eng. Des.*
- [266] Roth, J., Eckstein, W., Guseva, M., *Fus. Eng. Des.* **37** (1997) 465.
- [267] Eckstein, W., García-Rosales, C., Roth, J., Ottenberger, W., *Sputtering Data*, Max-Planck-Institut für Plasmaphysik, Report IPP 9/82 (1993).
- [268] Eckstein, W., *Computer simulation of ion-solid interaction*, Springer Series in Material Science, Vol. 10, (Springer, Berlin 1991).
- [269] Sigmund, P., *Phys. Rev.* **184** (1969) 383.
- [270] Eckstein, W., Bohdanský, J., Roth, J., *Physical sputtering*, Atomic and Plasma-Material Interaction Data for Fusion, Vol. 1, Supplement to *Nucl. Fusion*, IAEA, Vienna, (1991) p. 51.
- [271] Eckstein, W., García-Rosales, C., Roth, J., László, J., *Nucl. Instr. Meth.* **B83** (1993) 95.
- [272] Yamamura, Y., Bohdanský, J., *Vacuum* **35** (1985) 561.
- [273] Küstner, M., Eckstein, W., Dose, V., Roth, J., *Nucl. Instr. Meth.* **B145** (1998) 320.
- [274] Küstner, M., Eckstein, W., Hecht, E., Roth, J., *J. Nucl. Mater.* **265** (1999) 22.
- [275] Bohdanský, J., Lindner, H., Martinelli, A.P., Roth, J., *Nucl. Instr. Meth.* **B18** (1987) 509.
- [276] Eckstein, W., Stephens, J.A., Clark, R.E.H., Davis, J.W., Haasz, A.A., Vietzke, E., Hirooka, Y., *Particle Induced Erosion of Be, C and W in Fusion Plasmas. Part B: Physical Sputtering and Radiation Enhanced Sublimation*, in Atomic and Plasma-Material Interaction Data for Fusion, Vol. 7B, (IAEA, Vienna, 1999) to appear.
- [277] Matsunami, N., et al., Univ. Nagoya, Inst. of Physics, Report IPPJ-AM-32 (1983).
- [278] Roth, J., Wampler, W.R., Jacob, W., *J. Nucl. Mater.* **250** (1997) 23.
- [279] Eckstein, W., Max-Planck Institut für Plasmaphysik, *personal communication* (1999).
- [280] Vietzke, E., Haasz, A.A., in: *Physical processes of the interaction of fusion plasmas with solids*, eds.: Hofer, W.O., Roth, J., (Academic Press, San Diego, 1996). Section 4: Chemical erosion, p.135.
- [281] Roth, J., Bohdanský, J., Ottenberger, W., *J. Nucl. Mater.* **165** (1989) 193.
- [282] Eckstein, W., Roth, J., Gauthier, E., László, J., *Fus. Tech.* **19** (1991) 2076.
- [283] Eckstein, W., Roth, J., *Nucl. Instr. Meth.* **B53** (1991) 279.
- [284] Davis, J.W., Haasz, A.A., *J. Nucl. Mater.* **241-243** (1997) 37.
- [285] Roth, J., *J. Nucl. Mater.* **266-269** (1999) 51.
- [286] Haasz, A.A., et al., *Atomic and Plasma-Material Interaction Data for Fusion*, Vol. 7A, (IAEA, Vienna, 1998).
- [287] Horn, A., et al., *Chem. Phys. Lett.* **231** (1994) 193.
- [288] Mech, B.V., Haasz, A.A., Davis, J.W., *J. Nucl. Mater.* **255** (1998) 153.

- [289] Balden, M., Roth, J., J. Nucl. Mater. **280** (2000) 39.
- [290] Vietzke, E., et al., J. Nucl. Mater. **145-147** (1987) 443.
- [291] Vietzke, E., Philipps, V., Fus. Technol. **15** (1989) 108.
- [292] Haasz, A.A., et al., J. Nucl. Mater. **145-147** (1987) 412.
- [293] Roth, J., García-Rosales, C., Nucl. Fusion **36** (1996) 1647, with Corrigendum, Nucl. Fusion **37** (1997) 897.
- [294] Mech, B.V., Haasz, A.A., Davis, J.W., J. Appl. Phys. **84** (1998) 1655.
- [295] Grote, H., et al., J. Nucl. Mater. **266-269** (1999) 1059.
- [296] Whyte, D.G., Tynan, G., Doerner, R., Brooks, J.N., *Investigation of carbon chemical erosion with increasing plasma flux & density in PISCES-B*, to appear in Nucl. Fusion.
- [297] Philipps, V., et al., Phys. Scripta **T64** (1996) 71.
- [298] Kallenbach, A., et al., Nucl. Fusion **38** (1998) 1097.
- [299] Monk, R.D., et al., Phys. Scripta **T81** (1999) 54.
- [300] Naujoks, D., Coster, D., Kastelewicz, H., Schneider, R., J. Nucl. Mater. **266-269** (1999) 360.
- [301] Stamp, M., et al., *Chemical erosion yields and photon efficiency measurements in the JET gas box divertor*, in Proc. 14<sup>th</sup> Int. Conf. Plasma Surf. Interact. in Contr. Fus. Dev., Rosenheim, Germany, May 22-26, 2000, to appear in J. Nucl. Mater.
- [302] Roth, J., Bohdansky, J., Nucl. Instr. Meth. **B23** (1987) 549.
- [303] García-Rosales, C., Roth, J., J. Nucl. Mater. **196-198** (1992) 573.
- [304] Kornejew, P., et al., *Chemical erosion of CFC at high ion flux densities*, to appear in Phys. Scripta
- [305] Goebel, D.M., et al., Nucl. Fusion **28** (1988) 1041.
- [306] Gielen, J.W.A.M., van de Sanden, M.C.M., Schramm, D.C., Appl. Phys. Lett. **69** (1996) 152.
- [307] Refke, A., Philipps, V., Vietzke, E., Erdweg, M., von Seggern, M., J. Nucl. Mater. **212-215** (1994) 1255.
- [308] Chen, A.Y.K., Davis, J.W., Haasz, A.A., J. Nucl. Mater. **266-269** (1999) 399.
- [309] Haasz, A.A., Chen, A.Y.K., Davis, J.W., Vietzke, E., J. Nucl. Mater. **248** (1997) 19.
- [310] Roth, J., Bohdansky, J., Blewer, R.S., Ottenberger, W., Borders, J., J. Nucl. Mater. **85-86** (1979) 1077.
- [311] Roth, J., J. Nucl. Mater. **145-147** (1987) 87.
- [312] Hechtel, E., Eckstein, W., Roth, J., László, J., J. Nucl. Mater. **179-181** (1991) 290.
- [313] Roth, J., Bohdansky, J., Ottenberger, W., *Data on Low Energy Light Ion Sputtering*, Max-Planck-Institut für Plasmaphysik, Report IPP 9/26 (1979).
- [314] Roth, J., Bohdansky, J., Wilson, K.L., J. Nucl. Mater. **111-112** (1982) 775.
- [315] Philipps, V., Flaskamp, K., Vietzke, E., J. Nucl. Mater. **111-112** (1982) 781.
- [316] Vietzke, E., Flaskamp, K., Hennes, M., Philipps, V., Nucl. Instr. Meth. **B2** (1984) 617.
- [317] Eckstein, W., Philipps, V., *Physical Sputtering and Radiation-Enhanced Sublimation, in Physical processes of the interaction of fusion plasma with solids*, Ed. by Hofer, W.O., and Roth, J., Academic Press (1996) 93.
- [318] Philipps, V., Vietzke, E., Schorn, R.P., Trinkaus, H., J. Nucl. Mater. **155-157** (1988) 319.
- [319] Franzen, P., Davis, J.W., Haasz, A.A., J. Appl. Phys. **78** (1995) 817.
- [320] Franzen, P., Haasz, A.A., Davis, J.W., J. Nucl. Mater. **226** (1995) 15.
- [321] Gauthier, E., Eckstein, W., László, J., Roth, J., J. Nucl. Mater. **176-177** (1990) 438.
- [322] Begrambekov, L.B., et al., J. Nucl. Mater. **170** (1990) 101.
- [323] Roth, J., Möller, W., Nucl. Instr. Meth. **B7-8** (1985) 788.
- [324] Philipps, V., Vietzke, E., Trinkaus, H., J. Nucl. Mater. **179-181** (1991) 25.



## Review: Plasma-material interactions

- [325] Haasz, A.A., Davis, J.W., J. Nucl. Mater. **151** (1987) 77.
- [326] Haasz, A.A., Davis, J.W., J. Nucl. Mater. **224** (1995) 141.
- [327] Tobin, S.J., et al., Plasma Phys. Contr. Fus. **38** (1996) 251.
- [328] Philipps, V., et al. J. Nucl. Mater. **196-198** (1992) 1106.
- [329] Ueda, Y., et al., J. Nucl. Mater. **227** (1996) 251.
- [330] Roth, J., *Chemical sputtering and radiation enhanced sublimation of carbon*, in Physics of Plasma-Wall Interactions in Controlled Fusion, Ed. by Post, D.E., and Behrisch, R., in NATO ASI Series B: Physics, Plenum Press, New York (1986) p. 389.
- [331] Roth, J., *Physical sputtering of solids at ion bombardment*, in Physics of Plasma-Wall Interactions in Controlled Fusion, Ed. by Post, D.E., and Behrisch, R., in NATO ASI Series B: Physics, Plenum Press, New York (1986) p. 351
- [332] Behrisch, R., Roth, J., Staudenmaier, G., Verbeek, H., Nucl. Instr. Meth. **B18** (1987) 629.
- [333] García-Rosales, C., Roth, J., Behrisch, R., J. Nucl. Mater. **212-215** (1994) 1211.
- [334] Kallenbach, A., et al., Nucl. Fusion **34** (1994) 1557.
- [335] Naujoks, D., Eckstein, W., J. Nucl. Mater. **230** (1996) 93.
- [336] Thoma, A., et al., Plasma Phys. Contr. Fus. **39** (1997) 1487.
- [337] Hirooka, Y., Phys. Scripta **T64** (1996) 84.
- [338] Goldstraß, P., Eckstein, W., Linsmeier, Ch., J. Nucl. Mater. **266-269** (1999) 518.
- [339] Eckstein, W., Krieger, K., Roth, J., J. Nucl. Mater. **258-263** (1998) 912.
- [340] Doerner, R.P., et al., J. Nucl. Mater. **266-269** (1999) 392.
- [341] Krieger, K, Roth, J., *Synergistic effects by simultaneous bombardment of tungsten with hydrogen and carbon*, in Proc. 14<sup>th</sup> Int. Conf. Plasma Surf. Interact. in Contr. Fus. Dev., Rosenheim, Germany, May 22-26, 2000, to appear in J. Nucl. Mater.
- [342] Sze, F.C., et al., J. Nucl. Mater. **246** (1997) 165.
- [343] Bach, F.P., diploma thesis (Univ. Bayreuth 1996, in German); F.P. Bach, W. Jacob, unpublished results.
- [344] Maruyama, K., Jacob, W., Roth, J., J. Nucl. Mater. **264** (1999) 56.
- [345] Doerner, R., et al., Phys. Scripta **T81** (1999) 35.
- [346] Chen, A.Y.K., Haasz, A.A., Davis, J.W., J. Nucl. Mater. **227** (1995) 66.
- [347] Balden, M., et al., *Chemical erosion of carbon doped with different fine-grain carbides*, in Proc. 14<sup>th</sup> Int. Conf. Plasma Surf. Interact. in Contr. Fus. Dev., Rosenheim, Germany, May 22-26, 2000, to appear in J. Nucl. Mater.
- [348] Simonov, V.A., Shvilkin, B.N., Katukov, G.P., Nucl. Fusion, Supplement AEC-No. 5589 (1962) 325.
- [349] McCracken, G.M., J. Nucl. Mater. **93-94** (1980) 3.
- [350] Mioduszewski, P., Comm. Plasma Phys. Contr. Fus. **6** (1980) 7.
- [351] Wolff, H., *Arcing in magnetic fusion devices*, Atomic and Plasma-Material Interaction Data for Fusion, Vol. 1, Supplement to Nucl. Fusion, IAEA, Vienna, (1991) p. 93.
- [352] Schwirzke, F., Taylor, R.J., J. Nucl. Mater. **93-94** (1980) 780.
- [353] Sethuraman, S.K., Barrault, M.R., J. Nucl. Mater. **93-94** (1980) 791.
- [354] Drouet, M.G., Jap. J. Appl. Phys. **20** (1981) 1027.
- [355] García-Rosales, C., et al., *Erosion at the divertor tiles of ASDEX-Upgrade*, in Proc. 21<sup>st</sup> Eur. Phys. Soc. Conf. on Contr. Fus. and Plasma Phys., (Montpellier, France 1994), Ed. Eur. Phys. Soc., Geneva, Vol. 18B - part 2 (1994) 718.
- [356] Hassanein, A., J. Nucl. Mater. **122-123** (1984) 1453.
- [357] Hassanein, A., Konkashbaev, I., J. Nucl. Mater. **233-237** (1996) 713.

- [358] Hassanein, A., *Fus. Technol.* **15** (1989) 513.
- [359] Hassanein, A., Konkashbaev, I., *Fus. Eng. Des.* **28** (1995) 27.
- [360] Hassanein, A., *Response of materials to high heat fluxes during operation in fusion reactors*, ASME, 88-WA/NE-2, 1988.
- [361] Hassanein, A., Federici, G., Konkashbaev, I., Zhitlukhin, A., Litunovsky, V., *Fus. Eng. Des.* **39-40** (1998) 201.
- [362] Hassanein, A., Konkashbaev, I., *Plasma Dev. Oper.* **5** (1998) 297.
- [363] Hassanein, A., Konkashbaev, I., *J. Nucl. Mater.* **273** (1999) 326.
- [364] Lengyel, L.L., et al., *Nucl. Fusion* **36** (1996) 1679.
- [365] Lengyel, L.L., Rozhansky, V.A., Veselova, J.Yu., *Drift motion in the scrape-off-layer during hard disruptions*, in Proc. 24<sup>th</sup> Eur. Phys. Soc. Conf. on Contr. Fus. and Plasma Phys., (Berchtesgaden, Germany, 1997), Ed. Eur. Phys. Soc., Geneva, Vol. 21A - part 4 (1997) 1549.
- [366] Landman, I.S., Wuerz, H., *Electric stopping in hot-plasma-wall interactions*, in Proc. 24<sup>th</sup> Eur. Phys. Soc. Conf. on Contr. Fus. and Plasma Phys., (Berchtesgaden, Germany, 1997), Ed. Eur. Phys. Soc., Geneva, Vol. 21A - part 4 (1997) 1821.
- [367] Hassanein, A., et al., *J. Nucl. Mater.* **241-243** (1997) 288.
- [368] Hassanein, A., *Fus. Technol.* **30** (1996) 713.
- [369] Wuerz, H., et al., *J. Nucl. Mater.* **233-237** (1996) 798.
- [370] Hassanein, A., Konkashbaev, I., *J. Nucl. Mater.* **258-263** (1998) 645.
- [371] Vassen, R., Kaiser, A., Stover, D., *J. Nucl. Mater.* **233-237** (1996) 713.
- [372] Guseva, M., et al., *J. Tech. Phys.* **66** No. 6 (1966) 106.
- [373] Pestchanyi, S.E., Usov, N.A., Wuerz, H., *Numerical simulation of brittle destruction of carbon-based materials due to pulse plasma heating*, in Proc. 20<sup>th</sup> Symp. Fus. Technol., (Marseille, France, 1998), Ed. Beaumont, B., et al., Vol. 1 (1998) 275.
- [374] Moeller, W., Roth, J., *Implantation, retention and release of hydrogen isotopes in solids*, in Physics of Plasma-Wall Interactions in Controlled Fusion, Ed. by Post, D.E., and Behrisch, R., in NATO ASI Series B: Physics, Plenum Press, New York (1986) p. 439.
- [375] Wilson, K.L., et al., *Trapping, de-trapping and release of implanted hydrogen isotopes*, Atomic and Plasma-Material Interaction Data for Fusion, Vol. 1, Supplement to Nucl. Fusion, IAEA, Vienna, (1991) 31.
- [376] Myers, S.M., Richards, P.M., Wampler, W.R., Besenbacher, F., *J. Nucl. Mater.* **165** (1989) 9.
- [377] Andrew, P.L., Haasz, A.A., *J. Appl. Phys.* **72** (1992) 2749.
- [378] Handbook of Ion Implantation Technology, ed. J. Ziegler, North Holland, Amsterdam (1992).
- [379] Eckstein, W., *Reflection*, Atomic and Plasma-Material Interaction Data for Fusion, Vol. 1, Supplement to Nucl. Fusion, IAEA, Vienna, (1991) p. 17.
- [380] Birtcher, R.C., Averbach, R.S., Blewitt, T.H., *J. Nucl. Mater.* **75** (1978) 167.
- [381] Ziegler, J.F., Biersack, J.P., Littmark, U., *The stopping and range of ions in solids*, Pergamon Press, New York, (1985).
- [382] LeBlanc, L., Ross, G.G., *Nucl. Instr. Meth.* **B83** (1993) 15.
- [383] Wipf, H., *Diffusion of hydrogen in metals*, in Hydrogen in Metals III, Springer Topics in Applied Physics Vol. 73, Springer-Verlag, Berlin (1997) p 51.
- [384] Kidson, G.V., *The diffusion of H, D and T in solid metals*, in Landolt-Börnstein Numerical Data and Functional Relationships in Science and Technology Group III: Crystal and Solid-State Physics, Vol. 26 Diffusion in Solid Metals and Alloys, Springer-Verlag, Berlin (1990) 504.
- [385] Wampler, W.R., *J. Appl. Phys.* **69** (1991) 3063.

- [386] Pick, M.A., Sonnenberg, K., *J. Nucl. Mater.* **131** (1985) 208.
- [387] Baskes, M.I., *J. Nucl. Mater.* **92** (1980) 318.
- [388] Wampler, W.R., *J. Appl. Phys.* **65** (1989) 4040.
- [389] Antoniazzi, A.B., Haasz, A.A., Stangeby, P.C., *J. Vac. Sci. Technol.* **5** (1987) 2325.
- [390] Antoniazzi, A.B., Haasz, A.A., Stangeby, P.C., *J. Nucl. Mater.* **162-164** (1989) 1065.
- [391] Andrew, P.L., Haasz, A.A., *J. Vac. Sci. Technol.* **A8** (1990) 1807.
- [392] Haasz, A.A., Andrew, P.L., Antoniazzi, A.B., *J. Vac. Sci. Technol.* **A7** (1989) 1042.
- [393] Andrew, P.L., Haasz, A.A., *J. Less Comm. Met.* **172-174** (1991) 732.
- [394] Andrew, P.L., Haasz, A.A., *J. Appl. Phys.* **70** (1991) 3600.
- [395] Doyle, B.L., Brice, D.K., *Rad. Eff.* **89** (1985) 21.
- [396] Doyle, B.L., *J. Nucl. Mater.* **111-112** (1982) 628.
- [397] Ham, F.S., *J. Phys. Chem. Solids* **6** (1958) 335.
- [398] Myers, S.M., Nordlander, P., Besenbacher, F., Nørskov, J.K., *Phys. Rev.* **B33** (1986) 854.
- [399] Nordlander, P., Nørskov, J.K., Besenbacher, F., *J. Phys. F: Met. Phys.* **16** (1986) 1161.
- [400] Eleveld, H., van Veen, A., *J. Nucl. Mater.* **191-194** (1992) 433.
- [401] Fransens, J.R., Abd El Keriem, M.S., Pleiter, F., *J. Phys. Condens. Matter* **3** (1991) 9871.
- [402] Krimmel, H., Föhnle M., *J. Nucl. Mater.* **255** (1998) 72.
- [403] Frauenfelder, R., *J. Vac. Sci. Technol.* **6** (1969) 388.
- [404] Tamm, P.W., Schmidt, L.D., *J. Chem. Phys.* **54** (1971) 4775.
- [405] Nahm, T.U., Gomer, R., *Surf. Sci.* **375** (1997) 281.
- [406] Nørskov, J.K., *Phys. Rev.* **B26** (1982) 2875.
- [407] Nørskov, J.K., Besenbacher, F., *J. Less Comm. Met.* **130** (1987) 475.
- [408] Myers, S.M., et al., *Rev. Mod. Phys.* **64** (1992) 559.
- [409] Katsuta, H., McLellan, R.B., Furukawa, K., *J. Phys. Chem. Solids* **43** (1982) 533.
- [410] Myers, S.M., Besenbacher, F., *J. Appl. Phys.* **60** (1986) 3499.
- [411] Chou, M.Y., Lam, P.K., Cohen, M.L., *Phys. Rev.* **B28** (1983) 4179.
- [412] Krimmel, H., Föhnle M., *J. Nucl. Mater.* **213** (1996) 159.
- [413] Shapovalov, V.I., Dukel'ski, Yu.M., *Russ. Metall.* **5** (1988) 210.
- [414] Myers, S.M., Follstaedt, D.M., *J. Nucl. Mater.* **145-147** (1987) 322.
- [415] Hemmes, H., Driessen, A., Griessen, R., *J. Phys. C: Solid-State Phys.* **19** (1986) 3571.
- [416] Greenwood, G.W., Foreman, A.J.E., Rimmer, D.E., *J. Nucl. Mater.* **4** (1959) 305.
- [417] Chernikov, V.N., Alimov, K.Kh., Markin A.V., Zakharov, A.P., *J. Nucl. Mater.* **228** (1996) 47.
- [418] Altstetter, C.J., Behrisch, R., Scherzer, B.M.U., *J. Vac. Sci. Technol.* **15** (1978) 706.
- [419] Blewer, R.S., Behrisch, R., Scherzer, B.M.U., Schultz, R., *J. Nucl. Mater.* **76-77** (1978) 305.
- [420] Hindmarsh, A.C., in *Scient. Comp.*, Ed. Stepleman, R.S., (North Holland, Amsterdam 1983) 55.
- [421] Wienhold, P., Profant, M., Waelbroeck, F., Winter, J., *J. Nucl. Mater.* **93-94** (1980) 866.
- [422] Baskes, M.I., *DIFFUSE-83*, Report SAND83-8231, Sandia National Laboratories, (1983).
- [423] Moeller, W., *PIDAT - A computer program for implant diffusion and trapping*, IPP-9-44 (1983) Rep. IPP-9/44, Max-Planck-Institut für Plasmaphysik, Garching (Nov. 1983).
- [424] Holland, D.F., Merrill, B.J., *Analysis of tritium migration and deposition in fusion reactor systems*, in *Eng. Probl. of Fus. Res.*, Proc. 9<sup>th</sup> Symp. Fus. Eng. (Chicago, USA, 1981), IEEE, New York (1981) 1209.
- [425] Scaffidi-Argentina, F., Dalle Donne, M., Ronchi, C., Ferrero, C., *Fus. Technol.* **32** (1997) 179.
- [426] Zakharov, A.P., et al., *J. Nucl. Mater.* **241-243** (1997) 52.

- [427] Anderl, R.A., et al., J. Nucl. Mater. **273** (1999) 1.
- [428] Causey, R.A., Venhaus, T.J., *The use of tungsten in fusion reactors: a review of the hydrogen retention and migration properties*, Hydrogen Isotopes in Solids, Stockholm, Sweden, May 17 - 19, 2000.
- [429] Serra, E., Benanati, G., Ogorodnikova, O.V., J. Nucl. Mater. **255** (1998) 105.
- [430] Jones, P.M.S., Gibson, R., J. Nucl. Mater. **21** (1967) 353.
- [431] Swansiger, W.A., J. Vac. Sci. Technol. **A4** (1988) 1216.
- [432] Abramov, E., Riehm, M.P., Thompson, D.A., J. Nucl. Mater. **175** (1990) 90.
- [433] Tazhibaeva, I.L., et al., *Deuterium permeation through beryllium with surface element composition control*, in Proc. of 18<sup>th</sup> Symp. Fus. Technol., (Karlsruhe, Germany, 1994), Elsevier Science B.V. Amsterdam. Vol. 1 (1994) 427.
- [434] Haasz, A.A., Davis, J.W., J. Nucl. Mater. **241-243** (1997) 1076.
- [435] Wampler, W.R., J. Nucl. Mater. **122-123** (1984) 1598.
- [436] Moeller, W., Scherzer, B.M.U., Bohdansky, J., *Retention and release of deuterium implanted into beryllium*, Final Report - Max-Planck-Institut fuer Plasmaphysik, Garching, IPP-JET-Report-No.26 (1985).
- [437] Haasz, A.A., Davis, J.W., Poon, M., Macaulay-Newcombe, R.G., J. Nucl. Mater. **258-263** (1998) 889.
- [438] Alimov, V.K., Scherzer, B.M.U., J. Nucl. Mater. **240** (1996) 75.
- [439] Eleveld, H., van Veen, A., J. Nucl. Mater. **212-215** (1994) 1421.
- [440] Doyle, B.L., Wampler, W.R., Brice, D.K., J. Nucl. Mater. **103-104** (1981) 513.
- [441] Davis, J.W., Haasz, A.A., Walsh, D.S., J. Nucl. Mater. **176-177** (1990) 992.
- [442] Chiu, S., Haasz, A.A., J. Nucl. Mater. **196-198** (1992) 972.
- [443] Wampler, W.R., Brice, D.K., Magee, C.W., J. Nucl. Mater. **102** (1981) 304.
- [444] Staudenmaier, G., et al., J. Nucl. Mater. **84** (1979) 149.
- [445] Haasz, A.A., Davis, J.W., J. Nucl. Mater. **232** (1996) 219.
- [446] Doyle, B.L., Wampler, W.R., Brice, D.K., Picraux, S.T., J. Nucl. Mater. **93-94** (1980) 551.
- [447] Causey, R.A., J. Nucl. Mater. **162-164** (1989) 151.
- [448] Chernikov, V.N., Wampler, W.R., Zakharov, A.P., Gorodetsky, A.E., J. Nucl. Mater. **264** (1999) 180.
- [449] Haasz, A.A., Davis, J.W., J. Nucl. Mater. **209** (1994) 155.
- [450] Haasz, A.A., Franzen, P., Davis, J.W., Chiu, S., Pitcher, C.S., J. Appl. Phys. **77** (1995) 66.
- [451] Emmoth, B., Nucl. Fusion **30** (1990) 1140.
- [452] Kushita, K.N., Youle, I., Haasz, A.A., Sawicki, J.A., J. Nucl. Mater. **179-181** (1991) 235.
- [453] Penzhorn, R.D., et al., *Tritium Depth Profiles in Graphite and Carbon Fiber Composite Material Exposed to Tokamak Plasmas*, in Proc. 14<sup>th</sup> Int. Conf. Plasma Surf. Interact. in Contr. Fus. Dev., Rosenheim, Germany, May 22-26, 2000, to appear in J. Nucl. Mater.
- [454] Wampler, W.R., Doyle, B.L., Causey, R.A., Wilson, K.L., J. Nucl. Mater. **176-177** (1990) 983.
- [455] Chernikov, V.N., et al., J. Nucl. Mater. **217** (1994) 250.
- [456] Chernikov, V.N., et al., J. Nucl. Mater. **220-222** (1995) 921.
- [457] Kanashenko, S.L., J. Nucl. Mater. **233-237** (1996) 1207.
- [458] Moeller, W., J. Nucl. Mater. **162-164** (1989) 138.
- [459] Sawicki, J.A., Roth, J., Howe, L.M., J. Nucl. Mater. **162-164** (1989) 1019.
- [460] Jacob, W., Thin Solid Films **326** (1998) 1.
- [461] Wampler, W.R., Magee, C.W., J. Nucl. Mater. **103-104** (1981) 509.

- [462] Moeller, W., Borgesen, P., Scherzer, B.M.U., Nucl. Instr. Meth. **B19/20** (1987) 826.
- [463] Roth, J., et al., J. Nucl. Mater. **93-94** (1980) 601.
- [464] Wampler, W.R., Myers, S.M., J. Nucl. Mater. **111-112** (1982) 616.
- [465] Wampler, W.R., Doyle, B.L., J. Nucl. Mater. **162-164** (1989) 1025.
- [466] Langley, R.A., J. Nucl. Mater. **162-164** (1989) 1030.
- [467] Brice, D.K., Nucl. Instr. Meth. **B44** (1990) 302.
- [468] Wang, W., Jacob, W., Roth, J., J. Nucl. Mater. **245** (1997) 66.
- [469] Causey, R.A., Walsh, D.S., J. Nucl. Mater. **254** (1998) 84.
- [470] Mayer, M., J. Nucl. Mater. **240** (1997) 164.
- [471] Stott, P.E., Gorini G., Sindoni, E., *Diagnostics for experimental thermonuclear fusion reactors*, Plenum Press New York 1996.
- [472] Proc. of the 12<sup>th</sup> Top. Conf. on High Temp. Plasma Diagn. 1998 Rev. Sci. Instr. **70** (1999) 255.
- [473] Samm, U., Trans. of Fus. Technol. **33** (2T) (1998) 338.
- [474] Counsell, G.F., et al., *Towards an improved understanding of the relationship between plasma-edge and materials issues in a next-step fusion device*, in Proc. 14<sup>th</sup> Int. Conf. Plasma Surf. Interact. in Contr. Fus. Dev., Rosenheim, Germany, May 22-26, 2000, to appear in J. Nucl. Mater.
- [475] Behringer, K., Summers, H.P., Denne, B., Forrest, M., Stamp, M., Plasma Phys. Contr. Fus. **31** (1989) 2059.
- [476] Cohen, S.A., J. Nucl. Mater. **63** (1976) 65.
- [477] Kallenbach, A., et al., J. Nucl. Mater. **266-269** (1999) 343.
- [478] Doerner, R.P., *Measurements of erosion mechanisms from solid and liquid materials in PISCES-B*, in Proc. 14<sup>th</sup> Int. Conf. Plasma Surf. Interact. in Contr. Fus. Dev., Rosenheim, Germany, May 22-26, 2000, to appear in J. Nucl. Mater.
- [479] Isler, R.C., Nucl. Fusion **24** (1984) 1599.
- [480] Philipps, V., Vietzke, E., Erdweg, M., J. Nucl. Mater. **162-164** (1989) 550.
- [481] Hillis, D.L., et al., *Sub-divertor tritium concentration in JET and its relation to tritium uptake and retention*, in Proc. IEA Workshop on Tritium Experience in Large Tokamaks, Application to ITER, (Princeton, USA, 1998). Conf. Rep. in Nucl. Fusion **39** (1999) 271.
- [482] Verbeek, H., et al., Nucl. Fusion **39** (1999) 95.
- [483] Wampler, W.R., et al., J. Vac. Sci. Technol. **A7** (1989) 1083.
- [484] Bastasz, R., et al., J. Nucl. Mater. **176-177** (1990) 1038.
- [485] LaBombard, B., et al., J. Nucl. Mater. **241-243** (1997) 149.
- [486] Walsh, D.S., Doyle, B.L., Jackson, G.L., J. Vac. Sci. Technol. **A10** (4) (1992) 1174.
- [487] Coad, J.P., Rubel, M., Wu, C.H., J. Nucl. Mater. **241-243** (1997) 408.
- [488] Wampler, W.R., et al., J. Vac. Sci. Technol. **A6** (3) (1988) 2111.
- [489] Rubel, M., von Seggern, J., Karduck, P., Philipps, V., Vevecka-Priftaj, A., J. Nucl. Mater. **266-269** (1999) 1185.
- [490] Naujoks, D., Behrisch, R., Philipps, V., Schweer, B., Plasma Phys. Contr. Fus. **36** (1994) 2021.
- [491] Hancock, C.J., et al., *Operational experience of JTE surface physics diagnostics*, in Proc. 15<sup>th</sup> Symp. Fus. Technol., (Utrecht, the Netherlands, Sept. 1988), A.M. Van Ingen, A. Nijsen-Vis, H.T. Klippel, (editors), Elsevier Amsterdam, Vol. 1 (1989) 309.
- [492] Wong, C.P.C., et al., J. Nucl. Mater. **196-198** (1992) 871.
- [493] Krieger, K., et al., J. Nucl. Mater. **241-243** (1997) 684.

- [494] Wampler, W.R., et al., J. Nucl. Mater. **233-237** (1996) 791.
- [495] Matthews, G.F., *Divertor energy distribution in JET H-modes*, in Proc. 14<sup>th</sup> Int. Conf. Plasma Surf. Interact. in Contr. Fus. Dev., Rosenheim, Germany, May 22-26, 2000, to appear in J. Nucl. Mater.
- [496] Behringer, K., J. Nucl. Mater. **176-177** (1990) 606.
- [497] Liu-Hinz, C., Terreault, B., Martin, F., J. Nucl. Mater. **220-222** (1995) 1126.
- [498] Poschenrieder, W., Venus, G., and the ASDEX Team, J. Nucl. Mater. **111-112** (1982) 29.
- [499] Mertens, P., Silz, M., J. Nucl. Mater. **241-243** (1997) 842.
- [500] Kondo, K., et al., J. Nucl. Mater. **145-147** (1987) 501.
- [501] Goehlich, A., Roewekamp, M., Dobeles, H.F., J. Nucl. Mater. **176-177** (1990) 1055.
- [502] Lebedev, S.V., Moshkalev, S.A., Razdobarin, G.T., Semenov, V.V., Shakhovets, K.G., Nucl. Fusion **25** (1985) 931.
- [503] Herrmann, A., et al., Plasma Phys. Contr. Fus. **37** (1995) 17.
- [504] Hill, D.N., Ellis, R., Ferguson, W., Perkins, D.E., Rev. Sci. Instr. **59** (8) (1988) 1878.
- [505] Kobayashi, T., et al., J. Nucl. Mater. **121** (1984) 17.
- [506] Owens, D.K., et al., J. Nucl. Mater. **93-94** (1980) 213.
- [507] Duan, W., Chen, J., Yang, S., J. Nucl. Mater. **111-112** (1982) 502.
- [508] Juettner, B., Buchl, K., Weinlich, M., Contr. Plasma Phys. **34** (2/3) (1994) 472.
- [509] Goodall, D.H.J., J. Nucl. Mater. **93-94** (1980) 154.
- [510] Juettner, B., et al., Nucl. Fusion **20** (1980) 497.
- [511] Hillis, D.L., et al., Phys. Plasmas **6** (1999) 1985.
- [512] Keudell, A. von, et al., Nucl. Fusion **39** (1999) 1451.
- [513] Naujoks, D., Behrisch, R., J. Nucl. Mater. **220-222** (1995) 227.
- [514] Coad, J.P., et al., J. Nucl. Mater. **200** (1993) 360.
- [515] Jones, R., Wykes, C., *Holographic and speckle interferometry*, University Press, Cambridge, (1989).
- [516] Koch, A.W., Ruprecht, M., Wilhelm, R., *Laser speckle techniques for in-situ monitoring of erosion and re-deposition at inner walls in large experimental fusion devices*, Max-Planck-Institut fuer Plasmaphysik, Garching, Report No. IPP 4/271, (1995).
- [517] Azzam, R.M.A., Bashara, N.M., *Ellipsometry and polarized light*, North-Holland, Amsterdam, (1989).
- [518] Bastasz, R., Hirooka, Y., Khandagle, M., J. Nucl. Mater. **220-222** (1995) 352.
- [519] Wienhold, P., Waelbroeck, F., Bergsaker, H., Winter, J., Esser, H.G., J. Nucl. Mater. **162-164** (1989) 369.
- [520] Wienhold, P., Weschenfelder, F., Winter, J., J. Nucl. Mater. **220-222** (1995) 452.
- [521] Weschenfelder, F., et al., Plasma Phys. Contr. Fus. **38** (7) (1996) 1043.
- [522] Bourgoin, D., Ross, G.G., Savoie, S., Drolet, Y., Haddad, E., J. Nucl. Mater. **241-243** (1997) 765.
- [523] Rohde, V., Maier, H., Krieger, K., Neu, R., Perchermaier, J., *Carbon layers in the divertor of ASDEX-Upgrade*, in Proc. 14<sup>th</sup> Int. Conf. Plasma Surf. Interact. in Contr. Fus. Dev., Rosenheim, Germany, May 22-26, 2000, to appear in J. Nucl. Mater.
- [524] Manos, D.M., Bennett, T., Herzer, M., Schwarzmann, J., J. Nucl. Mater. **196-198** (1992) 933.
- [525] Franzen, P., et al., Nucl. Fusion **37** (1997) 1375.
- [526] Guo, H.Y., Terreault, B., Rev. Sci. Instr. **64** (3) (1993) 700.
- [527] Summers, D., et al., *In-situ measurement of hydrogen retention in JET carbon tiles*, in Proc.

- 14<sup>th</sup> Int. Conf. Plasma Surf. Interact. in Contr. Fus. Dev., Rosenheim, Germany, May 22-26, 2000, to appear in J. Nucl. Mater.
- [528] Skinner, C.H., et al., J. Vac. Sci. Technol. **A14** (6) (1996) 3267.
- [529] Kumar, A., Kugel, H.W., Ascione, G., *Measurement of radioactivity in mixed DT and DD neutron field at TFTR*, in Proc. 17<sup>th</sup> IEEE/NPSS Symp. Fus. Eng., (San Diego, USA, 1997) Ed. IEEE, Piscataway New Jersey, IEEE 97CH36131, Vol. 2. (1998) 845.
- [530] Whyte, D.G., et al., J. Nucl. Mater. **266-269** (1999) 67.
- [531] Menon, M.M., et al., *Study of the surface features on the TFTR inner limiter using a frequency modulated coherent laser radar device developed for ITER*, in Proc. 18<sup>th</sup> IEEE/NPSS Symp. on Fus. Eng. (Albuquerque, Oct. 6-10, 1999), Ed. IEEE, Piscataway - New Jersey, IEEE 99CH3705 (1999) 261.
- [532] Reichle, R., et al., *Thermography of target plates with near infrared optical fibres at Tore Supra*, in Proc. 14<sup>th</sup> Int. Conf. Plasma Surf. Interact. in Contr. Fus. Dev., Rosenheim, Germany, May 22-26, 2000, to appear in J. Nucl. Mater.
- [533] Roth, J., et al., J. Nucl. Mater. **220-222** (1995) 231.
- [534] Naujoks, D., Roth, J., Krieger, K., Lieder, G., Laux, M., J. Nucl. Mater. **210** (1994) 43.
- [535] Bastasz, R., et al., J. Nucl. Mater. **220-222** (1995) 310.
- [536] Lingertat, J., et al., J. Nucl. Mater. **241-243** (1997) 402.
- [537] Kubo, H., et al., J. Nucl. Mater. **196-198** (1992) 71.
- [538] Higashijima, S., et al., J. Nucl. Mater. **241-243** (1997) 574.
- [539] Pitcher, C.S., et al., Nucl. Fusion **26** (1986) 1641.
- [540] Klepper, C., et al., *Impurity generation in the Tore Supra outboard pump limiter*, in Proc. 20<sup>th</sup> Eur. Phys. Soc. Conf. on Contr. Fus. and Plasma Phys., (Lisbon, Portugal, 1993), Ed. Eur. Phys. Soc., Geneva, Vol. 17C - part 2 (1994) 59.
- [541] Ruggieri, R., Gauthier, E., Hogan, J., Layet, J.M., Loarer, T., J. Nucl. Mater. **266-269** (1999) 660.
- [542] Higashijima, S., *personal communication*.
- [543] Kubo, H., *personal communication*.
- [544] Ehrhardt, A.B., Langer, W.D., *Collisional processes of hydrocarbon in hydrogen plasmas*, Princeton Plasma Physics Laboratory report, PPPL-2477, Sept. 1987.
- [545] Kato, S., et al., J. Nucl. Mater. **266-269** (1999) 406.
- [546] Guo, H. Y., et al., *Impurity production and erosion/re-deposition at the JET MK-I divertor*, in Proc. 22<sup>nd</sup> European Phys. Soc. Conf. on Contr. Fus. and Plasma Phys., (Bournemouth, 3-7 July 1995), European Physical Society, Geneva, Vol. 19C - part 2 (1995) 313.
- [547] Wienhold, P., et al., Nucl. Instr. Meth. **B94** (1994) 503.
- [548] Brooks, J.N., Whyte, D.G., Nucl. Fusion **39** (1999) 525.
- [549] Mech, B.V., Haasz, A.A., Davis, J.W., J. Nucl. Mater. **241-243** (1997) 1147.
- [550] Masaki, K., et al., *The first inspection of JT-60U W-shaped divertor after high-power operation*, in Proc. 20<sup>th</sup> Symp. Fus. Technol. (Marseille, France, 1998), Ed. Beaumont, B., et al., Vol. 1 (1998) 67.
- [551] Maier, H., et al., *Deuterium inventories in different divertor configurations of ASDEX-Upgrade*, in Proc 26<sup>th</sup> Eur. Phys. Soc. Conf. on Contr. Fus. and Plasma Phys., (Maastricht, The Netherlands, 1999), edited by the Eur. Phys. Soc., Geneva, to appear.
- [552] Brooks, J.N., Causey, R., Federici, G., Ruzic, J. Nucl. Mater. **241-243** (1997) 294.
- [553] Keudell, A. von, Jacob, W., J. Appl. Phys. **79** (1996) 1092.
- [554] Nakano, T., Toyoda, H., Sugai, H., Jap. J. Appl. Phys. **30** (1992) 2908.

- [555] Motlagh, S., Moore, J., J. Chem. Phys. **109** (1998) 432.
- [556] Tabasso, A., Maier, H., Krieger, K., Roth, J. and the ASDEX-Upgrade Team, Nucl. Fusion **40** (2000) 1441.
- [557] LaBombard, B., et al., *Cross-field plasma transport and main chamber recycling in divertor plasmas on Alcator C-Mod*, in Proc. 14<sup>th</sup> Int. Conf. Plasma Surf. Interact. in Contr. Fus. Dev., Rosenheim, Germany, May 22-26, 2000, to appear in J. Nucl. Mater.
- [558] Coad, J.P., et al., *Carbon erosion and deposition at JET limiters*, in Proc. 14<sup>th</sup> Eur. Phys. Soc. Conf. on Contr. Fus. and Plasma Phys., (Madrid, Spain, 1987), Ed. Eur. Phys. Soc., Geneva, Vol. 11D - part 2 (1987) 744.
- [559] McCracken, G.M., et al., J. Nucl. Mater. **162-164** (1989) 356.
- [560] Behrisch, R., et al., J. Nucl. Mater. **162-164** (1989) 598.
- [561] Hsu, W. L., Mills, B.E., Ehrhardt, A.B., Sun, Y.C., J. Vac. Sci. Technol. **A7** (3) (1989) 1065.
- [562] Walsh, D.S., Knox, J.M., Doyle, B.L., Nucl. Instr. Meth. **B45** (1990) 62.
- [563] Hua, T.Q., Brooks, J.N., J. Nucl. Mater. **196-198** (1992) 514. Note corrected units for Figs 5 and 7 are 100Å/s (T.Q. Hua, personal communication).
- [564] Gentile, C., et al., *In-situ tritium measurements of the Tokamak Fusion Test Reactor bumper limiter tiles post DT operations*, Fus. Eng. Des. to appear.
- [565] Skinner, C.H., Gentile, C.A., Young, K.M., *Observations of Flaking of Co-Deposited layers in TFTR*, in Proc. 18<sup>th</sup> IEEE/NPSS Symp. on Fus. Eng. (Albuquerque, Oct. 6-10, 1999), Ed. IEEE, Piscataway - New Jersey, IEEE 99CH3705 (1999) 89.
- [566] Skinner, C.H., et al., *Studies of Tritiated Co-deposited Layers in TFTR*, in Proc. 14<sup>th</sup> Int. Conf. Plasma Surf. Interact. in Contr. Fus. Dev., Rosenheim, Germany, May 22-26, 2000, to appear in J. Nucl. Mater.
- [567] Philipps, V., et al., J. Nucl. Mater. **258-263** (1998) 858.
- [568] Philipps, V., et al., Nucl. Fusion **34** (1994) 1417.
- [569] Staudenmaier, G., Wampler, W.R., J. Nucl. Mater. **145-147** (1987) 569.
- [570] Wampler, W.R., Cohen, S.A., Nucl. Fusion **25** (1985) 771.
- [571] Wampler, W.R., J. Vac. Sci. Technol. **A3** (1985) 1067.
- [572] Voss, D.E., Cohen, S.A., J. Nucl. Mater. **93-94** (1980) 405.
- [573] Ruzic, D., et al., J. Nucl. Mater. **145-147** (1987) 527.
- [574] Verbeek, H., and the ASDEX Team, J. Nucl. Mater. **145-147** (1987) 523.
- [575] Verbeek, H., Schiavi, A., *The low energy neutral particle analyser (LENA) at W7-AS*, Max-Planck-Institut für Plasmaphysik, IPP Report IPP9/103 (1994).
- [576] Umansky, M.V., Krasheninnikov, S.I., La Bombard, B., Terry, J.L., Phys. Plasmas **5** (1998) 3373.
- [577] Kögler, U., et al., J. Nucl. Mater. **241-243** (1997) 816.
- [578] Staudenmaier, G., J. Vac. Sci. Technol. **A3** (1985) 1091.
- [579] Roth, J., Ehrenberg, J.K., Wittmaack, K., Coad, J.P., Roberto, J.B., J. Nucl. Mater. **145-147** (1987) 383.
- [580] Mayer, M., et al., J. Nucl. Mater. **266-269** (1999) 604.
- [581] Mayer, M., Behrisch, R., Andrew, P.L., Coad, J.P., Peacock, A.T., Phys. Scripta **T81** (1999) 13.
- [582] Wang, W., Roth, J., Behrisch, R., Staudenmaier, G., J. Nucl. Mater. **162-164** (1989) 422.
- [583] Roth, J., et al., *Impurity sources during ohmic-related discharges in ASDEX*, in Proc. 10<sup>th</sup> Eur. Phys. Soc. Conf. on Contr. Fus. and Plasma Phys., (Budapest, Hungary, 1985), Ed. Eur. Phys. Soc., Geneva, Vol. 9F - part 2 (1985) 543.



## Review: Plasma-material interactions

- [584] Roth, J., Janeschitz, G., Nucl. Fusion **29** (1989) 915.
- [585] Krieger, K., et al., J. Nucl. Mater. **241-243** (1997) 734.
- [586] Maier, H., Krieger, K., Balden, M., Roth, J., J. Nucl. Mater. **266-269** (1999) 1003.
- [587] Shiratani, M., Jolly, J., Videlot, H., Perrin, J., Jap. J. Appl. Phys. **36** (1997) 4752.
- [588] Behrisch, R., et al., J. Nucl. Mater. **145-147** (1987) 731.
- [589] McCracken, G.M., Goodall, D.H.J., Nucl. Fusion **18** (1978) 537.
- [590] Ohtsuka, H., Ogiwara, N., Maeno, M., J. Nucl. Mater. **93-94** (1980) 161.
- [591] Wampler, W.R., et al., *Suppression of erosion in the DIII-D divertor with detached plasmas*, in Proc. 14<sup>th</sup> Int. Conf. Plasma Surf. Interact. in Contr. Fus. Dev., Rosenheim, Germany, May 22-26, 2000, to appear in J. Nucl. Mater.
- [592] Safronov, V., et al., *Material erosion and erosion products under plasma heat loads typical of ITER hard disruptions*, in Proc. 14<sup>th</sup> Int. Conf. Plasma Surf. Interact. in Contr. Fus. Dev., Rosenheim, Germany, May 2000, to appear in J. Nucl. Mater.
- [593] Van der Laan, J.G., J. Nucl. Mater. **162-164** (1989) 964.
- [594] Van der Laan, J.G., Akiba, M., Hassanein, H., Seki, M., Tanchuk, V., Fus. Eng. Des. **18** (1991) 135.
- [595] Linke, J., *Disruption simulation experiments in electron and laser beam facilities*, in Proc. 16<sup>th</sup> Symp. Fus. Technol., (London, UK, 1990), B.E. Keen, M. Huguet, R. Hemsworth (editors), Elsevier Amsterdam, Vol. 1 (1991) 428.
- [596] Van Osch, E.V., et al., J. Nucl. Mater. **220-222** (1995) 781.
- [597] Anisimov, S.I., Gal'burt, V.A., Ivanov, M.F., Poyurovskaya, I.E., Fisher, V.I., Sov. Phys. Tech. Phys. **24** (3) (1979) 295.
- [598] Anisimov, S.I., Khokhlov, V.A., *Instabilities in Laser-Matter Interaction*, CRC Press Inc. 1995.
- [599] Tanaka, S., et al., Rev. Sci. Instr. **62** (1991) 761.
- [600] Akiba, M., et al., Plasma Dev. Oper. **1** (1991) 205.
- [601] Nakamura, K., et al., J. Nucl. Mater. **233-237** (1996) 730.
- [602] Duwe, R., Kühnlein, W. Münstermann, H., The new electron beam facility for material testing in hot cells - design and preliminary experience, in Proc. 18<sup>th</sup> Symp. Fus. Technol., (Karlsruhe Germany, 1994), K. Herschbach, W. Maurer, J.E. Vetter (editors), Elsevier Amsterdam, Vol. 1 (1995) 355.
- [603] Engelko, V., et al., J. Nucl. Mater. **220-222** (1995) 1071.
- [604] Engelko, V., et al., J. Nucl. Mater. **233-237** (1996) 818.
- [605] Astrelin, V.T., Nucl. Fusion **37** (1997) 1541.
- [606] Astrelin, V.A., et al., *Electron and hot plasma stream target interaction experiments under simulated ITER plasma disruption conditions at the GOL-3 facility*, in Proc. 18<sup>th</sup> Symp. Fus. Technol., (Karlsruhe Germany, 1994), K. Herschbach, W. Maurer, J.E. Vetter (editors), Elsevier Amsterdam, Vol. 1 (1995) 371.
- [607] Hassanein, A., Fusion Technol. **26** (1995) 532.
- [608] Burdakov, A.V., et al., J. Nucl. Mater. **233-237** (1996) 697.
- [609] Bolt, H., Linke, J., Penkalla, H.J., Tarret, E., Phys. Scripta **T81** (1999) 94.
- [610] Van der Stad, R.C.L., Klippel, H.Th., Kraaij, *Evaluation of plasma disruption simulating short pulse laser irradiation experiments on boronated graphites and CFCs*, in Proc. 17<sup>th</sup> Symp. Fus. Technol., (Rome, Italy, 1992), C. Ferro, M. Gasparotto, H. Knoepfel (editors), Elsevier Amsterdam, Vol. 1 (1993) 401.
- [611] Burdakov, A.V., et al., J. Nucl. Mater. **212-215** (1994) 1345.

- [612] Arkhipov, N.I., et al., Proc. 12<sup>th</sup> Int. Conf. Plasma Phys. Contr. Nucl. Fus. Res., (Nice, France, 1988), Ed. IAEA Vienna Vol. 2 (1989) 683.
- [613] Arkhipov, N.I., et al., J. Nucl. Mater. **233-237** (1996) 767.
- [614] Arkhipov, N.I., et al., J. Nucl. Mater. **266-269** (1999) 751
- [615] Gahl, J., et al., J. Nucl. Mater. **191-194** (1992) 454.
- [616] Litunovsky, V., et al., *Study of material response on simulated ITER disryptive plasma heat load with variable duration*, in Proc. 16<sup>th</sup> IEEE/NPSS Symp. Fus. Eng., (Champaign, USA, 1995) Ed. IEEE, Piscataway - New Jersey, IEEE 95CH35852, Vol. 1 (1996) 435.
- [617] Drozdov, A.A., Kuznetsov, V.E., Ljublin, B.V., Ovchinnikov, I.B., Titov, V.A., Plasma Dev. Oper. **5** (1997) 77.
- [618] Belan, V., et al., J. Nucl. Mater. **233-237** (1996) 763.
- [619] Chebotarev, V.V., et al., J. Nucl. Mater. **233-237** (1996) 736.
- [620] Hassanein, A., Konkashbaev, I., *Disruption simulation experiments and extrapolation to reactor conditions*, in Proc. 20<sup>th</sup> Symp. Fus. Technol. (Marseille, France, 1998), Ed. Beaumont, B., et al., Vol. 1 (1998) 245.
- [621] Arkhipov, N.I., et al., *Plasma temperature measurements in disruption simulated experiments*, in Proc. 18<sup>th</sup> Symp. Fus. Technol., (Karlsruhe Germany, 1994), K. Herschbach, W. Maurer, J.E. Vetter (editors), Elsevier Amsterdam, Vol. 1 (1995) 395.
- [622] Arkhipov, N.I., et al., *Plasma material interaction under simulated disruption conditions*, in Proc. 18<sup>th</sup> Symp. Fus. Technol., (Karlsruhe Germany, 1994), K. Herschbach, W. Maurer, J.E. Vetter (editors), Elsevier Amsterdam, Vol. 1 (1995) 463.
- [623] Wuerz, H., et al., Fus. Technol. **32** (1997) 45.
- [624] Martynenko, Yu.V., et al., J. Nucl. Mater. **258-263** (1998) 1120.
- [625] Scaffidi-Argentina, F., et al., J. Nucl. Mat. **283-287** (2000) 1111.
- [626] Hassanein, A., et al., **241-243** (1997) 288.
- [627] Litunovsky, V., Kuznetsov, V.E., Ovchinnikov, I.B., Titov, V.A., *Experimental study of material response on simulated plasma disruption load*, in Proc. 20<sup>th</sup> Symp. Fus. Technol. (Marseille, France, 1998), Ed. Beaumont, B., et al., Vol. 1 (1998) 245.
- [628] Makhankov, A., Barabash, V., Mazul, I., Youchison, D., *Performance of the Different Tungsten Grades under Fusion Relevant Power Loads*, in Proc. 14<sup>th</sup> Int. Conf. Plasma Surf. Interact. in Contr. Fus. Dev., Rosenheim, Germany, May 22-26, 2000, to appear in J. Nucl. Mater.
- [629] Tubbing, B.J.D., et al., *The operational characteristics of a molten and damaged beryllium divertor target in JET*, in Proc. 22<sup>nd</sup> Eur. Phys. Soc. Conf. on Contr. Fus. and Plasma Phys., (Bournemouth, UK, 1995), Ed. Eur. Phys. Soc., Geneva, Vol. 19C - part 3 (1995) 453.
- [630] JET Team, presented by G. Janeschitz, *Comparison of plasma performance with beryllium and carbon divertor targets in JET*, in Proc. 14<sup>th</sup> Conf. Plasma Phys. Contr. Nucl. Fus. Res., (Wuerzburg, Germany, 1992), Ed. IAEA Vienna, Vol. 1 (1993) 239.
- [631] Deksnis, E.B., Peacock, A.T., Altmann, H., Ibbot, C., Falter, H.D., *Beryllium Plasma-facing Components: JET Experience*, JET report JET-P(97) 01 Joint Undertaking, Abingdon, Oxfordshire, OX14 3EA, UK.
- [632] Bastasz, R., et al., J. Nucl. Mater. **241-243** (1997) 650.
- [633] West, P., personal communication (2000).
- [634] Buzhinskij, O.I., et al., J. Nucl. Mater. **266-269** (1999) 793.
- [635] Janos, A.C., et al., *Disruptions in the TFTR Tokamak*, in Proc. 14<sup>th</sup> Conf. Plasma Phys. Contr. Nucl. Fus. Res., (Wuerzburg, Germany, 1992), Ed. IAEA Vienna, Vol. 1 (1993) 527.
- [636] Martin, G., Chatelier, M., Doloc, C., *New insight into runaway electrons production and*

## Review: Plasma-material interactions

- confinement*, in Proc. 22<sup>nd</sup> Eur. Phys. Soc. Conf. on Contr. Fus. and Plasma Phys., (Bournemouth, UK, 1995), Ed. Eur. Phys. Soc., Geneva, Vol. 19C - part 2 (1995) 44.
- [637] Gill, R.D., Nucl. Fusion **33** (1993) 1613.
- [638] Gill, R.D., et al., Nucl. Fusion **40** (2000) 163.
- [639] Ciotti, M., Franzoni, G., Maddaluno, G., J. Nucl. Mater. **220-222** (1995) 567.
- [640] Maddaluno, G., Pierdominici, F., Vittori, M., J. Nucl. Mater. **241-243** (1997) 908.
- [641] Maddaluno, G., Esposito, B., J. Nucl. Mater. **266-269** (1999) 593.
- [642] Maddaluno, G., *personal communication* (1999).
- [643] Ehrenberg, J.K., et al., J. Nucl. Mater. **196-198** (1992) 992.
- [644] Ehrenberg, J.K., Philipps, V., De. Kock, L., Causey, R.A., Hsu, W.L., J. Nucl. Mater. **176-177** (1990) 226.
- [645] Ehrenberg, J.K., et al., J. Nucl. Mater. **162-164** (1989) 63.
- [646] Ehrenberg, J.K., *Wall effects on particle recycling in tokamaks*, in Physical processes of the interaction of fusion plasma with solids, Ed. by Hofer, W.O., and Roth, J., Academic Press (1996) 35.
- [647] Mueller, D., et al., J. Vac. Sci. Technol. **A 9** (1991) 2713.
- [648] Waelbroeck, F., Esser, H.G., Winter, J., J. Nucl. Mater. **162-164** (1989) 713.
- [649] Jackson, G.L., Taylor, T.S., Taylor, P.L., Nucl. Fusion **30** (1990) 2305.
- [650] Dylla, H.F., et al., J. Nucl. Mater. **162-164** (1989) 128.
- [651] Philipps, V., Vietzke, E., Erdweg, M., Winter, J., J. Nucl. Mater. **200** (1993) 355.
- [652] Grisolia, C., et al., J. Nucl. Mater. **266-269** (1999) 146.
- [653] Gauthier, E., et al., J. Nucl. Mater. **241-243** (1997) 553.
- [654] Lyssoivan, A., et al., *ICRF preionisation and plasma production in TEXTOR*, in Proc. 22<sup>nd</sup> Eur. Phys. Soc. Conf. on Contr. Fus. and Plasma Phys., (Bournemouth, UK, 1995), Ed. Eur. Phys. Soc., Geneva, Vol. 19C - part 3 (1995) 341.
- [655] Winter, J., Plasma Phys. Contr. Fus. **38** (1996) 1503.
- [656] Jackson, G.L., et al., J. Nucl. Mater. **176-177** (1990) 311.
- [657] Stott, P.E., et al., Nucl. Fusion **15** (1975) 431.
- [658] Goodall, D.H., J. Nucl. Mater. **111-112** (1982) 11.
- [659] Mioduszewski, P.K., et al., Nucl. Fusion **27** (1987) 195.
- [660] Bures, M., et al., J. Nucl. Mater. **176-177** (1990) 387.
- [661] Bures, M., et al., Fus. Eng. Des. **12** (1990) 251.
- [662] Kugel, H.W., et al., *Development of lithium deposition technology for TFTR*, in Proc. 17<sup>th</sup> IEEE/NPSSSymp. Fus. Eng. (San Diego, California 1997), edited by IEEE, Piscataway, New Jersey, Vol. 2 (1998) 869.
- [663] Campbell, D.J., et al., *The Influence of Beryllium on Plasma Operation in JET*, to appear in Fus. Eng. Des.
- [664] Winter, J., J. Nucl. Mater. **145-147** (1987) 131.
- [665] Schissel, D.P., et al., *The effects of carbonization on the confinement properties of the DIII-D H-mod*, in Proc. 17<sup>th</sup> Eur. Phys. Soc. Conf. on Contr. Fus. and Plasma Phys., (Amsterdam, The Netherlands, 1990) edited by the Eur. Phys. Soc., Geneva, Vol. 14 B part I (1990) 275.
- [666] Schneider, U., et al., J. Nucl. Mater. **176-177** (1991) 350.
- [667] Dylla, H.F., J. Nucl., Mater **176-177** (1991) 337.
- [668] Buzhinskij, O.I., Semenets, Yu.M., Fus. Technol. **32** (1997) 1.
- [669] Buzhinskij, O.I., Semenets, Yu.M., Fus. Eng. Des. **45** (1999) 343.
- [670] Rapp, J., et al., *Scaling of density limits with respect to global and edge parameters in*

- TEXTOR-94*, in Proc 26<sup>th</sup> Eur. Phys. Soc. Conf. on Contr. Fus. and Plasma Phys., (Maastricht, The Netherlands, 1999), edited by the Eur. Phys. Soc., Geneva, to appear.
- [671] Waidman, G., Guangla K., Nuc. Fusion **32** (1992) 645.
- [672] Snipes, J.A., J. Nucl. Mater. **196-198** (1992) 686.
- [673] Jackson, G.L., et al., J. Nucl. Mater. **241-243** (1997) 655.
- [674] Kondo, K., et al., J. Nucl. Mater. **241-243** (1997) 956.
- [675] Sugai, H., et al., J. Nucl. Mater. **220-222** (1995) 254.
- [676] Terreault, B., J. Nucl. Mater. **220-222** (1995) 790.
- [677] Toyoda, H., et al., J. Nucl. Mater. **241-243** (1997) 1031.
- [678] Hogan, J.T., Nucl. Fusion **37** (1997) 705.
- [679] Hirooka, Y., J. Nucl. Mater. **274** (1999) 320.
- [680] Saibene, G., et al., J. Nucl. Mater. **241-243** (1997) 476.
- [681] Haas, G., et al., *Particle exhaust and wall pumping studies in ASDEX-Upgrade*, in Proc. 22<sup>nd</sup> Eur. Phys. Soc. Conf. on Contr. Fus. and Plasma Phys., (Bournemouth, UK, 1995), Ed. Eur. Phys. Soc., Geneva, Vol. 19C - part 1 (1995) 321.
- [682] Loarer, T., Chatelier M., Grosman A. et al., Plasma Phys. Contr. Fus. **37** (11) (1995) A203.
- [683] Mahdavi, M.A., et al., in Proc. 20<sup>th</sup> Eur. Phys. Soc. Conf. on Contr. Fus. and Plasma Phys., (Lisbon, Portugal, 1993), Ed. Eur. Phys. Soc., Geneva, Vol. 17C - part 2 (1994) 647.
- [684] Loarer, T, et al., in Proc. 20<sup>th</sup> Eur. Phys. Soc. Conf. on Contr. Fus. and Plasma Phys., (Lisbon, Portugal, 1993), Ed. Eur. Phys. Soc., Geneva, Vol. 17C - part 2 (1994) 607.
- [685] Maingi, R., et al., Nucl. Fusion **36** (1996) 245.
- [686] Mioduszewski, P.K., et al., J. Nucl. Mater. **220-222** (1995) 91.
- [687] Petrie, T.W., et al., Nucl. Fusion, to appear.
- [688] Grisolia, C., Ghendrih, Ph., Peegourié, B., Grosman, A., J. Nucl. Mater. **196-198** (1992) 281.
- [689] Andrew, P.L., Pick, M.A., J. Nucl. Mater. **220-222** (1995) 601.
- [690] Grisolia, C., et al., *Tore Supra recycling properties with boromised walls*, in Proc. 20<sup>th</sup> Eur. Phys. Soc. Conf. on Contr. Fus. and Plasma Phys., (Lisbon, Portugal, 1993), Ed. Eur. Phys. Soc., Geneva, Vol. 17C - part 2 (1994) 595.
- [691] Coad, J.P., et al., J. Nucl. Mater. **226** (1995) 156.
- [692] Sartori, R., J. Nucl. Mater. **176-177** (1990) 624.
- [693] Maingi, R., et al., J. Nucl. Mater. **241-243** (1998) 672.
- [694] Lazarus, E.A., et al., Phys. Rev. Lett. **77** (1996) 2714.
- [695] Strachan, J.D., et al., Phys. Rev. Lett. **58** (1987) 1004.
- [696] Koide, Y., and the JT 60U Team, Phys. Plasmas **4** (1997) 1623.
- [697] Mahdavi, M.A., et al., J. Nucl. Mater. **176-177** (1991) 32.
- [698] Chankin, A., Saibene, G., Plasma Phys. Contr. Fus. **41** (1999) 913.
- [699] Janeschitz, G., et al., *Dependence of energy confinement on the H-mode pedestal temperature*, in Proc 26<sup>th</sup> Eur. Phys. Soc. Conf. on Contr. Fus. and Plasma Phys., (Maastricht, The Netherlands, 1999), edited by the Eur. Phys. Soc., Geneva, to appear.
- [700] Grisolia, C., Ghendrih, P., Martin, G., Van Houtte, D., J. Nucl. Mater. **241-243** (1997) 538.
- [701] Cohen, S.A., *Particle confinement and control in existing tokamaks*, in Physics of Plasma-Wall Interactions in Controlled Fusion, Edited by Post, D.E., and Behrisch, R., in NATO ASI Series B: Physics Vol. 131 (1984) 773.
- [702] TFR Group, J. Nucl. Mater. **111-112** (1982) 199.
- [703] Grisolia, C., Horton, L.D., Ehrenberg, J.K., J. Nucl. Mater. **220-222** (1995) 516.
- [704] Mayer, M., Philipps, V., Esser, H.G., Wienhold, P., Rubel, M., *Wall pumping and hydrogen*

## Review: Plasma-material interactions

- recycling in TEXTOR 94*, in Proc. of the NATO Advanced Research Workshop on Hydrogen Recycle at Plasma-Facing Materials, held in St. Petersburg, Russia, 15.-17.9.1999.
- [705] Mayer, M., Philipps, V., Esser, H.G., Wienhold, P., Rubel, M., *Co-deposition and hydrogen wall pumping in TEXTOR 94*, to appear in J. Nucl. Mater.
- [706] Sugihara, M., et al., J. Nucl. Mater. **266-269** (1999) 691.
- [707] Garin, P., and Tore Supra Team, in Proc. 20<sup>th</sup> Symp. on Fusion Techn., Marseille (1998), Vol. 2, 1709.
- [708] Dylla, H.F., Wilson, K.L., editors, *Tritium Retention in TFTR*, Princeton Plasma Physics Laboratory report PPPL-2523 and Sandia National Laboratory report SAND88-8212 (April 1988).
- [709] Mills, B.E., Buchenauer, D.A., Pontau, A.E., Ulrickson, M.A., J. Nucl. Mater. **162-164** (1989) 343.
- [710] McGrath, R.T., Brooks, J.N., J. Nucl. Mater. **162-164** (1989) 350.
- [711] Pitcher, C.S., et al., J. Nucl. Mater. **196-198** (1992) 241.
- [712] Ramsey, A.T., et al. Nucl. Fusion **31** (1991) 1811.
- [713] Ulrickson, M.A., Dylla, H.F., LaMarche, P.H., J. Vac. Sci. Technol. **A6** (1988) 2001.
- [714] Langley, R.A., Blewer, R.S., Roth, J., J. Nucl. Mater. **76-77** (1978) 313.
- [715] Ramsey, A.T., Manos, D.M., J. Nucl. Mater. **196-198** (1992) 509.
- [716] Skinner, C.H., et al., J. Nucl. Mater. **241-243** (1997) 214.
- [717] Coad, J.P., et al., J. Nucl. Mater. **162-164** (1989) 533.
- [718] Coad, J.P., Farmery, B., Vacuum **45** (1994) 435.
- [719] Coad, J.P., Andrew, P.L., Peacock, A.T., Phys. Scripta **T81** (1999) 7.
- [720] Mayer, M., Behrisch, R., Andrew, P.L., Peacock, A.T., J. Nucl. Mater. **241-243** (1997) 469.
- [721] Wong, C.P.C., et al., J. Nucl. Mater. **258-263** (1998) 433.
- [722] Hildebrandt, D., Akbi, M., Juettner, B., Schneider, W., J. Nucl. Mater. **266-269** (1999) 532.
- [723] Schleussner, D., et al., J. Nucl. Mater. **266-269** (1999) 1296.
- [724] Amemiya, S., Masuda, T., Ando, T., Kodama, K., Masaki, K., J. Nucl. Mater. **220-222** (1995) 443.
- [725] Masaki, K., *personal communication* (1999).
- [726] Carruthers, E.V., et al., J. Nucl. Mater. **176-177** (1990) 1070.
- [727] The JET Team, Nucl. Fusion **32** (1992) 187.
- [728] Dylla, H.F., et al., J. Nucl. Mater. **155-157** (1988) 15.
- [729] Coad, J.P., Orchard, J., Monahan, J., J. Nucl. Mater. **160** (1988) 95.
- [730] Coad, J.P., Gibson, A., Haigh, A., Kaveney, G. Orchard, J., *Deuterium and tritium release on venting the JET torus to air after the Be phase*, in Proc. 18<sup>th</sup> Eur. Phys. Soc. Conf. on Contr. Fus. and Plasma Phys., (Berlin, Germany, 1991), Ed. Eur. Phys. Soc., Geneva, Vol. 15C - part 3 (1992) 81.
- [731] Nemeto, M., et al., J. Nucl. Mater. **220-222** (1995) 385.
- [732] Miya, N., Nemeto, M., Toyoshima, N., Fus. Technol. **26** (1994) 507.
- [733] Masaki, K., et al., Fus. Eng. Des. **31** (1996) 181.
- [734] Ulrickson, M., et al., in Proc. 12<sup>th</sup> Conf. Plasma Phys. Contr. Nucl. Fus. Res. 1988, Suppl. to Nucl. Fusion, Vol. 3 IAEA, Vienna (1989) 419.
- [735] Goodall, D.H.J., et al., J. Nucl. Mater. **162-164** (1989) 1059.
- [736] Taylor, P.L., Kellman, A.G., Lee, R.L., J. Fus. Energy **12** (1993) 35.
- [737] Wampler, W.R. et al., *Retention of deuterium and tritium in tokamaks*, in Proc. IEA Workshop on Tritium Experience in Large Tokamaks, Application to ITER, (Princeton, USA,

- 1998). Conf. report in Nucl. Fusion **39** (1999) 271.
- [738] Sun, G.Y., et al., J. Nucl. Mater. **246** (1997) 9.
- [739] Andrew, P.L., et al., Nucl. Fusion **33** (1993) 1389.
- [740] Andrew, P.L., et al., J. Nucl. Mater. **196-198** (1992) 143.
- [741] Peacock, A.T., Coad, J.P., Dietz K. J., Knight, A. P., *Tritium retention in first-wall material at JET after the first tritium experiment (F.T.E.)*, in Proc.17<sup>th</sup> Symp. Fus. Technol., (Rome, Italy, 1992), Ed. Elsevier Science Publishers B.V., Vol. 1 (1993) 329.
- [742] Skinner, C.H., Stolter, D.P., Budny, R.V., Alder, H. Ramsey, A.T., Rev. Sci. Instr. **66** (1995) 646.
- [743] Budny, R.V., et al., *Isotopic mass and alpha heating effects in TFTR DT plasmas*, in Proc. 21<sup>st</sup> Eur. Phys. Soc. Conf. on Contr. Fus. and Plasma Phys., (Montpellier, France, 1994), Ed. Eur. Phys. Soc., Geneva, Vol. 18B - part 1 (1995) 82.
- [744] Skinner, C.H., Alder, H., Budny, R.V. et al., Nucl. Fusion **35** (1995) 143.
- [745] Efthimion, P.C., et al., in Proc. 15<sup>th</sup> Int. IAEA Conf. on Plasma Physics and Controlled Nuclear Fusion Research, (Seville, Spain, 1994), Ed. IAEA Vienna, Vol. 1 (1995) 289.
- [746] Skinner, C.H., et al., J. Nucl. Mater., **241-243** (1997) 887.
- [747] Stotler, D.P., et al., Phys. Plasmas **3** (1996) 4084.
- [748] Skinner, C.H., et al., *Tritium experience in the Tokamak Fusion Test Reactor*, in Proc. 20<sup>th</sup> Symp. Fus. Technol. (Marseille, France, 1998), Ed. Beaumont, B., et al., Vol. 1 (1998) 153.
- [749] Mueller, D., et al., J. Nucl. Mater. **241-243** (1997) 897.
- [750] Mueller, D., et al., Fus. Technol. **30** (1996) 840.
- [751] Zweben, S.J., et al., in Rev. Sci. Instr. **70** (1999) 1119.
- [752] Skinner, C.H., Gentile, C.A., Menon, M.M., Barry, R.E., Nucl. Fusion **39** (1999) 1081.
- [753] Gibson, A., and the JET Team, Phys. Plasmas **5** (1998) 1839.
- [754] Laesser, R., et al., Fus. Eng. Des. **46** (1999) 307.
- [755] Hemmerich, J.L., et al., Fus. Eng. Des. **19** (1992) 161.
- [756] Peacock, A.T. et al., *Deposits/flakes in the JET MK IIa divertor - a major source of tritium and deuterium inventory*, in Proc. 20<sup>th</sup> Symp. Fus. Technol. (Marseille, France, 1998), Ed. Beaumont, B., et al., Vol. 1 (1998) 233.
- [757] Peacock, A.T., et al., *Tritium inventory in the first-wall of JET*, Fus. Eng. Des. to appear.
- [758] Coad, J.P., et al., *Erosion/deposition issues at JET*, in Proc. 14<sup>th</sup> Int. Conf. Plasma Surf. Interact. in Contr. Fus. Dev., Rosenheim, Germany, May 22-26, 2000, to appear in J. Nucl. Mater.
- [759] Nygren, R.E., Sandia National Laboratories, Albuquerque, *personal communication* (1999).
- [760] Skinner, C.H., Kugel, H., Mueller, D., Doyle, B.L., Wampler, W.R., *Tritium removal by CO<sub>2</sub> laser heating*, in Proc. 17<sup>th</sup> IEEE/NPSS Symp. Fus. Eng., (San Diego, USA, 1997) Ed. IEEE, Piscataway New Jersey, IEEE 97CH36131, Vol. 1 (1998) 321.
- [761] Hollis, K.J., Castro, R.G., Maggiore, C.J., Ayala, A., J. Nucl. Mater. **283-287** (2000) 1085.
- [762] Hollis, K.J., Castro, R.G., Doerner, R.P., Maggiore, C.J., *The removal of co-deposited carbon/deuterium films from stainless steel and tungsten by transferred-arc cleaning*, submitted to Fus. Eng. Des.
- [763] Guile, A.E., Juttner, B., IEEE Trans. Plasma Sci., v. PS-8, no. 3 259.
- [764] Alberici, S., Hinssen, H.K., Moormann, R., Wu, C.H., J. Nucl. Mater. **266-269** (1999) 754.
- [765] Balden, M., Mayer, M., J. Nucl. Mat. **283-287** (2000) 1057.
- [766] Orchard, J.C., et al., J. Nucl. Mater. **200** (1993) 395.
- [767] Davis, J.W., Hamilton, C.G., Haasz, A.A., *Oxidation of graphite substrates*, J. Nucl. Mater.,

- accepted.
- [768] Philipps, V., et al., *J. Nucl. Mater.* **266-269** (1999) 386.
  - [769] Cowgill, D.F., *personal communication* (1997).
  - [770] Cowgill, D.F., Sandia National Laboratories, personal communication; also 18<sup>th</sup> Symp. on Fus. Technol., Karlsruhe, Aug. 22-24, 1994 and the IUVSTA Conditioning Workshop, Geneva, Feb. 27-Mar. 3, 1995.
  - [771] Outten, C.A., Barbour, J.C., Wampler, W.R., *J. Vac. Sci. Technol.* **A9** (1991) 717.
  - [772] Sakamoto, Y., et al., *J. Nucl. Mater.* **93-94** (1980) 333.
  - [773] Sakamoto, Y., et al., *J. Nucl. Mater.* **111-112** (1982) 485.
  - [774] Jacob, W., Landkammer, B., Wu, C.H., *J. Nucl. Mater.* **266-269** (1999) 552.
  - [775] Landkammer, B., Keudell, A. von, Jacob, W., *J. Nucl. Mater.* **264** (1999) 48.
  - [776] Winter, J., *Formation of dust and its role in fusion devices*, Report Nr. 68-B8-99, Institut fuer Experimentalphysik II, Ruhr-University, D-44780, Bochum (Germany) April 1999.
  - [777] Patel, B., Knipe, S., Macheta, P., Peacock, A., *Radiological properties of tritiated dust and flakes collected from the JET tokamak*, in Proc. 18<sup>th</sup> IEEE/NPSS Symp. on Fus. Eng. (Albuquerque, Oct. 6-10, 1999), Ed. IEEE, Piscataway - New Jersey, IEEE 99CH3705 (1999) 338.
  - [778] Charuau, J., et al., *Characterisation of erosion dust and tritiated products inside the JET vessel after the first tritium experiment*, in Proc. 17<sup>th</sup> Symp. Fus. Technol., (Rome, Italy, 1992), Ed. Elsevier Science Publishers B.V., Vol. 2 (1993) 1700.
  - [779] Pasini, D., et al., *J. Nucl. Mater.* **176-177** (1990) 186.
  - [780] Whyte, D., *Erosion, co-deposition and retention in DIII-D*, in Proc. IEA Workshop on Tritium Experience in Large Tokamaks, Application to ITER, (Princeton, USA, 1998). Conf. report in *Nucl. Fusion* **39** (1999) 271.
  - [781] Carmack, W.J., McCarthy, K.A., Petti, D.A., Kellman, A.G., Wong, C.P.C., *Fus. Eng. Des.* **39-40** part A (1998) 477.
  - [782] Gorman, S.V., Carmack, W.J., Hembree, P.B., *Fus. Technol.* **34** (1998) 745.
  - [783] McCarthy, K.A., et al., *Fus. Tech.* **34** (1998) 728.
  - [784] Carmack, W.J., *DIII-D dust particulate characterisation (june 1998 vent)* US Department of Energy INEEL External Report INEEL/EXT-1999-00095, (January 1999).
  - [785] Carmack, W.J., et al., *Analysis and characterisation of TFTR tokamak dust*, ITER Engineering Design File ITER/US/98/TE/SA-8, (April 1998).
  - [786] Sharpe, J.P., Chappuis, P., Petti, D.A., *Characterization of tokamak dust collected from Tore Supra*, presented at the 14<sup>th</sup> ANS Topical Meeting on the Technology of Fusion Energy, 15-19 October, 2000, Park City, UT, to appear in *Fus. Technol.*
  - [787] Hinds, W.J., *Aerosol technology: properties, behaviour, and measurement of airborne particles*, John Wiley and Sons, New York, (1982).
  - [788] Anderl, R.A., Pawelko, R.J., in Proc. of the 4<sup>th</sup> Int. Workshop on Tritium Effects in Plasma-facing Components, (Sante Fe, USA, 1998), Sandia Report SAND99-8222, Sandia National Laboratories, Albuquerque, NM. Feb. (1999) 20.
  - [789] Brunauer, S., Emmett, P.H., Teller, E., *J. Am. Chem. Soc.* **60** (1938) 309.
  - [790] Smolik, G.R., Anderl, R.A., Pawelko, R.J. et al., *BET surface area measurements of materials for fusion safety studies*, in Proc. 17<sup>th</sup> IEEE/NPSS Symp. Fus. Eng., (San Diego, USA, 1997) Ed. IEEE, Piscataway New Jersey, IEEE 97CH36131, Vol. 1 (1998) 183.
  - [791] German, R.M., *Int. J. Powder Metallurgy* **32** (1996) 4.
  - [792] Weschenfelder, F., et al., *Plasma Phys. Contr. Fus.* **38** (1996) A311.
  - [793] Garscadden, A., Ganguly, B.N., Haaland, P.D., Williams, J., *Plasma Sources Sci. Technol.* **3**

- (1994) 239.
- [794] Hollenstein, Ch., Dorier, J.L., Dutta, J., Sansonnens, L. Howling, A.A., Plasma Sources Sci. Technol. **A3** (1994) 278
- [795] Sharpe, J.P., Bourham, M., Gilligan, J.G., *Experimental investigation of disruption-induced aerosol mobilization in accident scenarios of ITER*, in Proc. 17<sup>th</sup> IEEE/NPSS Symp. Fus. Eng., (San Diego, USA, 1997) Ed. IEEE, Piscataway New Jersey, IEEE 97CH36131, Vol. 1 (1998) 153.
- [796] Sharpe, J.P., Bourham, M., Gilligan, J.G., Fus. Technol. **34** (1998) 634.
- [797] Sharpe, J.P., Bourham, M., Gilligan, J.G., Fus. Technol. **30** (1996) 1424.
- [798] Philipps, V., *personal communication* (1999).
- [799] Coad, J.P., Skorodumov, B.G., Ulanov, V.G. Wu, C.H., Vacuum **47** (1996) 986.
- [800] Von Seggern, J. et al., Phys. Scripta **T81** (1999) 31.
- [801] Bosch, H-S., et al., J. Nucl. Mater. **220-222** (1995) 558.
- [802] Pitcher, C.S., Goetz, J.A., LaBombard, B., Lipschultz, B., in Proc. 24<sup>th</sup> Eur. Phys. Soc. Conf. on Contr. Fus. and Plasma Phys., (Berchtesgaden, Germany, 1997), Ed. Eur. Phys. Soc., Geneva, Vol. 21A - Part 2 (1997) 581.
- [803] McCracken, G.M., Stangeby, P.C., Plasma Phys. Contr. Fus. **27** (1985) 1411.
- [804] Stangeby, P.C., Nucl. Fusion **33** (1993) 1695.
- [805] Krasheninnikov, S.I., Pigarov, A.Yu., Sigmar, D.J., Contr. Plasma Phys. **36** (1996) 314.
- [806] Borrass, K., Janeschitz, G., Nucl. Fusion **34** (1994) 1203.
- [807] Lipschultz, B., J. Nucl. Mater. **266-269** (1999) 370.
- [808] Petrie, T.W., et al., Nucl. Fusion **37** (1997) 643.
- [809] Pitcher, C.S., et al., J. Nucl. Mater. **241-243** (1997) 696.
- [810] Braginskii, S.I., *Transport Processes in a plasma*, Rev. of Plasma Phys., Vol. 1, Ed. Leontovich, M.A., Consultants Bureau, New York, 1965, p. 205.
- [811] Braams, B., NET report EUR-FU / XII-80-87-68 (1987).
- [812] Braams, B.J., thesis, Univ. Utrecht, the Netherlands, (1986).
- [813] Schneider, R., et al., J. Nucl. Mater. **196-198** (1992) 810.
- [814] Rognlien, T.D., Milovich, J.L., Rensink, M.E, Porter, G.D, J. Nucl. Mater. **196-198** (1992) 347.
- [815] Knoll, D.A., Prinja, A.K., Campbell, R.B., J. Comput. Phys. **104** (1993) 418.
- [816] Rognlien, T.D., Braams, B.J., Knoll, D.A., Contr. Plasma Phys. **36** (1996) 105.
- [817] Simonini, R., et al., J. Nucl. Mater. **196-198** (1992) 369.
- [818] Simonini, R., Corrigan, G., Radford, G., Spence, J., Taroni, A., Contr. Plasma Phys. **34** (1994) 368.
- [819] Petravic, M., Phys. Plasmas **1** (1994) 2207.
- [820] Shimizu, K., et al., J. Nucl. Mater. **220-222** (1995) 410.
- [821] Pitcher, C.S., Vac. Technol. Appl. Ion Phys. **38** (1988) 1059.
- [822] Heifetz, D.B., et al., J. Comp. Phys. **46** (1982) 309.
- [823] Stotler D., Karney C., Contr. Plasma Phys. **34** (1994) 392.
- [824] Reiter, D., *Randschicht-Konfiguration von Tokamaks: Entwicklung und Anwendung stochastischer Modelle zur Beschreibung des Neutralgastransports* - Kernforschungsanlage, Juelich, Report JUEL-1947, KFA Juelich, Germany, 1984 (in German).
- [825] Reiter, D., May, C., Coster, D., Schneider, R., J. Nucl. Mater. **220-222** (1995) 987.
- [826] Cupini, E., De Matteis, A., Simonini, R., Hotston, E.S., Harrison, M.F.A, *Monte-Carlo studies of helium pumping and sputtering in the INTOR divertor*, Comm. of the Europ. Communities,



## Review: Plasma-material interactions

- Brussels(BE) / NET Next European Torus, Garching (DE) EUR-XII-324-26/ NET-NR. 26 (1984).
- [827] Knoll, D.A., Krasheninnikov, S.I., McHugh, P.R., Sigmar, D., Phys. Plasmas **3** (1996) 3358.
- [828] Becker, G., Nucl. Fusion **39** (1999) 95.
- [829] Kukushkin, A.S., *personal communication*, March (1999).
- [830] Brooks, J.N., Phys. Fluids **8** (1990) 1858.
- [831] Stangeby, P.C., Elder, J.D., J. Nucl. Mater. **196-198** (1992) 258.
- [832] Evans, T.E., Finkenthal, D.F., in Atomic Processes in Plasmas, Ed. Oks, E., and Pindzola, M.S., Amer. Inst. Phys. Conf. Proc., AIP Press, New York, **443** (1998) 58.
- [833] Hogan, J.T., *BBQ: Impurity Scrape-Off Layer Transport Code*, Report ORNL-TM-13 312, Oak Ridge National Lab, Oak Ridge, Tennessee, USA (1996).
- [834] Brooks, J.N., in Atomic and Plasma-Material Interaction Processes in Controlled Thermonuclear Fusion, R. K. Janev and H. W. Darwin editors (1993) Elsevier Science Publishers B.V., p. 403.
- [835] Brooks, J.N., Nuc. Tech./Fusion **4** (1983) 33.
- [836] Naujoks, D., Behrisch, R., Coad, J.P., De Kock, L., Nucl. Fusion **33** (1993) 581.
- [837] Kirschner, A., Philipps, V., Winter, J., Kögler, U., Nucl. Fusion **40** (2000) 989.
- [838] Alman, D.A., Ruzic, D.N., Brooks, J.N., Phys. Plasmas **7** (2000) 1421.
- [839] Brooks, J.N., Brice, D.K., Dewald, A.B., McGrath, R.T., J. Nucl. Mater. **162-164** (1989) 363.
- [840] Hua, T.Q., Brooks, J.N., J. Nucl. Mater. **220-222** (1995) 342.
- [841] Coad, J.P. et al., Evidence for impurity drift in the Scrape-off Layer of JET, in Proc 26<sup>th</sup> Eur. Phys. Soc. Conf. on Contr. Fus. and Plasma Phys., (Maastricht, The Netherlands, 1999), edited by the Eur. Phys. Soc., Geneva, to appear.
- [842] Khandagle, M.J., et al., J. Nucl. Mater. **207** (1993) 116.
- [843] Hogan, J.T., et al., *Integrated impurity model for actively cooled plasma-facing components*, Proc. 16<sup>th</sup> Int. IAEA Conf. on Plasma Phys. Contr. Nucl. Fus. Res. (Montreal, Canada, 1996), Ed. IAEA Vienna, Vol. 2 (1997) 625.
- [844] Guo, H.Y., et al., J. Nucl. Mater. **266-269** (1999) 825.
- [845] Erents, S.K., et al., *Plasma flow in the JET scrape-off layer*, in Proc 26<sup>th</sup> Eur. Phys. Soc. Conf. on Contr. Fus. and Plasma Phys., (Maastricht, The Netherlands, 1999), edited by the Eur. Phys. Soc., Geneva, to appear., submitted to Plasma Physics and Controlled Fusion
- [846] Brooks, J.N., Fus. Technol. **18** (1990) 239.
- [847] Brooks, J.N., *Recent progress in tritium co-deposition modelling*, 9<sup>th</sup> Advanced Research Workshop on Hydrogen Isotope Recycling at Plasma-Facing Materials in Fusion Reactors, Proceedings to be published.
- [848] Brooks, J.N., Ruzic, D.N., Hayden, D.B., Fus. Eng. Des. **37** (1997) 455.
- [849] Sestero, A., Ventura, A., J. Nucl. Mater. **128-129** (1984) 828.
- [850] Gilligan, J., Hanh, D., J. Nucl. Mater. **145-147** (1987) 391.
- [851] Bolt, H., Harano H., Madarame, H., Okamoto, K., Tanabe, K., J. Nucl. Mater. **196-198** (1992) 948.
- [852] Hobel, H., et al., J. Nucl. Mater. **196-198** (1992) 537.
- [853] Wuerz, H., et al., J. Nucl. Mater. **212-215** (1994) 1349.
- [854] Wuerz, H., et al., J. Nucl. Mater. **220-222** (1995) 1066.
- [855] Bazylev, B., et al., *Plasma shield formation and divertor plate erosion for ITER tokamak plasma disruptions*, in Proc. 22<sup>nd</sup> European Phys. Soc. Conf. on Contr. Fus. and Plasma

- Phys., (Bournemouth, United Kingdom, 1995), Ed. Eur. Phys. Soc., Geneva, Vol. 19C - part 2 (1995) 277.
- [856] Wuerz, H., Pestchanyi, S., Bazylev, B., Kappler, F., *A consistent 2D analysis of the ITER 2D divertor*, in Proc. 20<sup>th</sup> Symp. Fus. Technol. (Marseille, France, 1998), Ed. Beaumont, B., et al., Vol. 1 (1998) 271.
- [857] Lengyel, L.L., et al., Nucl. Fusion **38** (1998) 1435.
- [858] Pestchanyi, S., Wuerz, H., Bazylev, B., Kappler, F., Landman, I., *Results from 2D radiation magnetohydrodynamics calculations of the interaction of ITER disruptive plasma with the slot divertor*, in Proc. 24<sup>th</sup> Eur. Phys. Soc. Conf. on Contr. Fus. and Plasma Phys., (Berchtesgaden, Germany, 1997), Ed. Eur. Phys. Soc., Geneva, Vol. 21A - part 3 (1997) 981.
- [859] Lalousis, P., Lengyel, L., Rozhansky, V., Spathis, P., Veselova, I., *Disruption-caused erosion and vapour shield formation*, in Proc. 22<sup>nd</sup> European Phys. Soc. Conf. on Contr. Fus. and Plasma Phys., (Bournemouth, United Kingdom, 1995), Ed. Eur. Phys. Soc., Geneva, Vol. 19C - part 2 (1995) 285.
- [860] Hassanein, A., et al., Fus. Technol. **1** (1994) 223.
- [861] Hassanein, A., *Evaluation of disruption erosion, Task report, ITER/US/98-IV-DV-0.4*.
- [862] Kawamura, T., Obayashi, H., Miyahara, A., Fus. Eng. Des. **9** (1989) 45.
- [863] Kunugi, T., Fus. Eng. Des. **23** (1993) 329.
- [864] Merola, M., J. Nucl. Mater. **202** (1993) 29.
- [865] Bartels H.W., *Runaway electrons on plasma-facing components*, in Proc. 17<sup>th</sup> Symp. Fus. Technol., (Rome, Italy, 1992), C. Ferro, M. Gasparotto, H. Knoepfel (editors), Elsevier Amsterdam, Vol. 1 (1993) 181.
- [866] Raffray, A.R., Federici, G., J. Nucl. Mater. **244** (1997) 85.
- [867] Federici, G., et al., *Analysis of heat transfer and erosion effects on ITER divertor plasma-facing components induced by slow high-power transients*, in Proc. 16<sup>th</sup> IEEE/NPSS Symp. Fus. Eng., (Champaign, USA, 1995) Ed. IEEE, Piscataway New Jersey, IEEE 95CH35852, Vol. 1 (1996) 430.
- [868] Raffray, A.R., et al., *Effects of runaway electrons and VDE's on ITER first-wall*, in Proc. 20<sup>th</sup> Symp. Fus. Technol., (Marseille, France, 1998), Ed. Beaumont, B., et al., Vol. 1 (1998) 211.
- [869] Cohen, S.A., et al., Plasma Phys. Contr. Fus. **29** (1987) 1205.
- [870] Hirooka, Y., *Particle Balance modelling for steady-state magnetic fusion devices - effects of plasma-wall interactions on the global particle confinement*, in Proc. 14<sup>th</sup> Int. Conf. Plasma Surf. Interact. in Contr. Fus. Dev., Rosenheim, Germany, May 22-26, 2000, to appear in J. Nucl. Mater.
- [871] Horton, L.D., et al., J. Nucl. Mater. **196-198** (1992) 139.
- [872] Reiter, D., *The edge plasma*, in Physical processes of the interaction of fusion plasma with solids, Ed. by Hofer, W.O., and Roth, J., Academic Press (1996) 1.
- [873] Hogan, J.T., et al., J. Nucl. Mater. **241-243** (1998) 612.
- [874] Mioduszewski, P.K., et al., J. Nucl. Mater. **121** (1984) 285.
- [875] Andrew, P.L., Peacock, A.T., Pick, M.A., J. Nucl. Mater. **196-198** (1992) 997.
- [876] Hogan, J.T., et al., J. Nucl. Mater. **196-198** (1992) 1083.
- [877] Eckstein, W., J. Nucl. Mater. **248** (1997) 1.
- [878] Audenarde, K., Emmert, G.A., Gordinier, M., J. Comput. Phys. **34** (1980) 268.
- [879] Sugihara, M. et al., *Modelling of wall pumping, fuelling and associated density behaviour in tokamaks*, in Proc. 24<sup>th</sup> Eur. Phys. Soc. Conf. on Contr. Fus. and Plasma Phys., (Bercht-

## Review: Plasma-material interactions

- esgaden, Germany, 1997) edited by the Eur. Phys. Soc., Geneva, Vol. 21A - part 3 (1997) 997.
- [880] Rehker, S., Wobig, H., Plasma Phys. **15** (1973) 1083.
- [881] Brice, D.K., Doyle, B.L., Wampler, W.R., Picraux, S.T., Haggmark, L.G., J. Nucl. Mater. **114** (1983) 277.
- [882] Saibene, G., et al., J. Nucl. Mater. **176-177** (1990) 618.
- [883] Rossi, A., et al., J. Nucl. Mater. **266-269** (1999) 922.
- [884] Philipps, V., Ehrenberg, J.K., J. Vac. Sci. Technol. **A11** (2) (1993) 437.
- [885] Haas, G., Maingi, R., Neuhauser, J., J. Nucl. Mater. **266-269** (1999) 1065.
- [886] Hillis, D.L., et al., *Comparison of hydrogen and tritium uptake and retention in JET*, in Proc. 14<sup>th</sup> Int. Conf. Plasma Surf. Interact. in Contr. Fus. Dev., Rosenheim, Germany, May 22-26, 2000, to appear in J. Nucl. Mater.
- [887] Nakamura, H., et al., JAERI Reseach Report, JAERI-M-86-175 (1986).
- [888] Grisolia, C., Gauthier, E., Grosman, A., Monier-Garbet, P., Tsitrone, E., *Tore Supra recycling properties with boronised walls*, in Proc. 20<sup>th</sup> Eur. Phys. Soc. Conf. on Contr. Fus. and Plasma Phys., (Lisbon, Portugal), Ed. Eur. Phys. Soc., Geneva, Vol. 17C - part 2 (1993) 595.
- [889] Goodall, D.H.J., Andrew, P.L., Ehrenberg, J., J. Nucl. Mater. **196-198** (1992) 1002.
- [890] Martin, G., Lewin, G., J. Vac. Sci. Technol. **3** (1) (1965) 6.
- [891] Dylla, H.F., J. Vac. Sci. Technol. **A6** (3) (1988) 1276.
- [892] Wilson, K., Hsu, W.S., J. Nucl. Mater. **145** (1987) 121.
- [893] McCracken, G.M., et al., Nucl. Fusion **18** (1978) 35.
- [894] Terrault, B. and the TFR Group, Terrault, B., J. Nucl. Mater. **127** (1985) 18.
- [895] LaMarche, P.H., Dylla, H.F., McCarthy, P.J., Ulrickson, M., J. Vac. Sci. Technol. **A4** (3) (1986) 1198.
- [896] Ehrenberg, J.K., J. Nucl. Mater. **145-147** (1987) 551.
- [897] Stangeby, P.C., Auciello, O., Haasz, A.A., Doyle, B., J. Nucl. Mater. **122-123** (1984) 1592.
- [898] Federici, G., Wu, C.H., J. Nucl. Mater. **186** (1992) 131.
- [899] Waelbroeck, F., *Influence of bulk and surface phenomena on the hydrogen permeation through metals*, Report Juelich - JUEL-1966, Institut für Plasmaphysik, Association Euratom-KfA (December 1984).
- [900] Wienhold, P., et al., *Computer Code PERI*, JUL. 1825, IPP-KFA Juelich (Jan. 1983).
- [901] Longhurst, G.R., Holland, D.F., Jones, J.L., Merrill, B.J., *TMAP4 User's Manual*, EGG-FSP-10315, Idaho National Engineering and Environmental Laboratory, (June 1992).
- [902] Cho, S., Raffray, R.A., Abdou, M.A., J. Nucl. Mater. **212-215** (1994) 961.
- [903] Dalle Donne, M., Scaffidi-Argentina, F., Ferrero, C., Ronchi, C., J. Nucl. Mater. **212-215** (1994) 954.
- [904] Longhurst, G.R., et al., J. Nucl. Mater. **258-263** (1998) 640.
- [905] Forty, C.B.A., Forrest, R.A., Compton, J.J., Rayner, C., *handbook of fusion activation data part 1: elements hydrogen to zirconium*, AEA UFS 180, AEA Technol. Fus., Euratom/UKAEA Fusion Association (May 1992).
- [906] Behrisch, R., Khripunov, V., Santoro, R.T., Yesil, J.M., J. Nucl. Mater. **258-263** (1998) 686.
- [907] Forrest, R.A., Endacott, D.A.J., *Fispact User Manual*, Harwell Report AERE-M-3654 (Rev), Harwell Laboratory, Oxfordshire, U.K. (1990).
- [908] Forty, C.B.A., Forrest, R.A., Compton, J.J., Rayner, C., *handbook of fusion activation data part 2: elements niobium to bismuth*, AEA UFS 232, AEA Technol. Fus., Euratom/UKAEA Fusion Association (May 1993).

G. Federici, C.H. Skinner, et al.

- [909] Moeller, W., Scherzer, B.M.U., Ehrenberg, J., J. Nucl. Mater. **111-112** (1982) 669.
- [910] Anderl, R.A., Longhurst, G.R., Struttman, D.A., J. Nucl. Mater. **145-147** (1987) 344.
- [911] Anderl, R.A., Holland D.F., Longhurst, G.R., J. Nucl. Mater. **176-177** (1990) 683.
- [912] Longhurst, G.R., et al., *Verification and Validation of TMAP4*, EGG-FSP-10347, INEEL Report, Idaho Nat. Eng. and Env. Lab. (July 1992).
- [913] Anderl, R.A., Hankins, M.R., Longhurst, G.R., Pawelko, R.J., Macaulay-Newcombe, R.G., J. Nucl. Mater. **196-198** (1992) 986.
- [914] Lomidze, M.A., Gorodetsky, A.E., Zakharov, A.P., Fus. Technol. **28** (1995) 1211.
- [915] García-Rosales, C., Franzen P., Plank, H., Roth, J., Gauthier, E., J. Nucl. Mater. **233-237** (1996) 803.
- [916] Franzen, P., et al., J. Nucl. Mater. **241-243** (1997) 1082.
- [917] Venhaus, T., Abeln, T., Doerner, R., Causey, R.A., *Behaviour of tungsten exposed to high fluences of low energy hydrogen isotopes*, in Proc. 14<sup>th</sup> Int. Conf. Plasma Surf. Interact. in Contr. Fus. Dev., Rosenheim, Germany, May 22-26, 2000, to appear in J. Nucl. Mater.
- [918] Hsu, W.L., et al., J. Nucl. Mater. **176-177** (1990) 218.
- [919] Causey, R.A., Longhurst, G.L., Harbin, W., J. Nucl. Mater. **241-243** (1997) 1041.
- [920] Anderl, R.A., et al., Fus. Technol. **21** (1992) 745.
- [921] Longhurst, G.R., *personal communication*.
- [922] Wampler, W.R., Sandia National Laboratories, Albuquerque, NM, unpublished data.
- [923] Federici, G., et al. *Preliminary assessment of the tritium inventory and permeation in the PFC's of ITER*, in Proc. of the 16<sup>th</sup> IEEE/NPSS Symp. Fus. Eng., (Champaign, USA, 1995), Ed. IEEE, Piscataway New Jersey, Vol. 1 (1996) 418.
- [924] Federici, G., et al., *In-vessel tritium retention and removal in the ITER-FEAT tokamak*, Physica Scripta, to appear.
- [925] Longhurst, G.R., Anderl, R.A., Dolan, T.J., Mulock, M.J., Fus. Technol. **28** (1995) 1217.
- [926] Federici, G., Holland, D., Janeschitz, G., Wu, C.H., J. Nucl. Mater. **241-243** (1997) 260.