

Characterization of the Spontaneous Light Emission of the PMTs used in the Double Chooz Experiment

Double Chooz Collaboration

Y. Abe,^a T. Abrahão,^{b,1} H. Almazan,^c C. Alt,^d S. Appel,^e E. Baussan,^f I. Bekman,^d M. Bergevin,^g T.J.C. Bezerra,^h L. Bezrukov,ⁱ E. Blucher,^j T. Brugière,^f C. Buck,^c J. Busenitz,^k A. Cabrera,^l E. Calvo,^m L. Camilleri,ⁿ R. Carr,ⁿ M. Cerrada,^m E. Chauveau,^{h,2} P. Chimenti,^o A.P. Collin,^c E. Conover,^j J.M. Conrad,^p J.I. Crespo-Anadón,^m K. Crum,^j A.S. Cucoanes,^{q,3} E. Damon,^r J.V. Dawson,^l H. de Kerret,^l J. Dhooghe,^g D. Dietrich,^s Z. Djurcic,^t J.C. dos Anjos,^b M. Dracos,^f A. Etenko,^u M. Fallot,^q J. Felde,^{g,4} S.M. Fernandes,^k V. Fischer,^v D. Franco,^l M. Franke,^e H. Furuta,^h I. Gil-Botella,^m L. Giot,^q M. Göger-Neff,^e H. Gomez,^l L.F.G. Gonzalez,^w L. Goodenough,^t M.C. Goodman,^t N. Haag,^e T. Hara,^x J. Haser,^c D. Hellwig,^d M. Hofmann,^e G.A. Horton-Smith,^y A. Hourlier,^l M. Ishitsuka,^a S. Jiménez,^m J. Jochum,^s C. Jollet,^f F. Kaether,^c L.N. Kalousis,^z Y. Kamyshev,^{aa} M. Kaneda,^a D.M. Kaplan,^{ab} T. Kawasaki,^{ac} E. Kemp,^w D. Kryn,^l M. Kuze,^a T. Lachenmaier,^s C.E. Lane,^r T. Lasserre,^{l,v} A. Letourneau,^v D. Lhuillier,^v H.P. Lima Jr.,^b M. Lindner,^c J.M. López-Castaño,^m J.M. LoSecco,^{ad} B. Lubsandorzhev,ⁱ S. Lucht,^d J. Maeda,^{ae,5} C. Mariani,^z J. Maricic,^{r,6} J. Martino,^q T. Matsubara,^{ae} G. Mention,^v A. Mereaglia,^f T. Miletic,^r R. Milincic,^{r,6} A. Minotti,^f Y. Nagasaka,^{af} D. Navas-Nicolás,^m P. Novella,^{m,7} H. Nunokawa,^{b,1} L. Oberauer,^e M. Obolensky,^l A. Onillon,^l A. Osborn,^{aa} C. Palomares,^m I.M. Pepe,^b S. Perasso,^l A. Porta,^q G. Pronost,^q J. Reichenbacher,^k B. Reinhold,^{c,6} M. Röhling,^s R. Roncin,^l B. Rybolt,^{aa} Y. Sakamoto,^{ag} R. Santorelli,^{m,8} A.C. Schilithz,^b S. Schönert,^e S. Schoppmann,^d M.H. Shaevitz,ⁿ R. Sharankova,^a D. Shrestha,^y V. Sibille,^v V. Sinev,ⁱ M. Skorokhvatov,^u E. Smith,^r M. Soiron,^d J. Spitz,^p A. Stahl,^d I. Stancu,^k L.F.F. Stokes,^s M. Strait,^j F. Suekane,^h S. Sukhotin,^u T. Sumiyoshi,^{ae} Y. Sun,^{k,6} R. Svoboda,^g K. Terao,^p A. Tonazzo,^l H.H. Trinh Thi,^e G. Valdivieso,^b N. Vassilopoulos,^f A. Verdugo,^m C. Veysiere,^v M. Vivier,^v F. von Feilitzsch,^e S. Wagner,^{b,1} N. Walsh,^g H. Watanabe,^c C. Wiebusch,^d M. Wurm,^{s,9} G. Yang,^{t,ab} F. Yermia ^q and V. Zimmer^e

¹Now at PUC University, R. Marquês de São Vicente, 225 - Gávea, Rio de Janeiro - RJ, Brazil.

²Now at CENBG, Bordeaux University, CNRS/IN2P3, F-33175 Gradignan, France.

³Now at ELI-NP, "Horia Hulubei" National Institute of Physics and Nuclear Engineering, 077125 Bucharest-Magurele, Romania.

⁴Now at Department of Physics, University of Maryland, College Park, Maryland 20742, USA.

⁵Now at Department of Physics, Kobe University, Kobe, 658-8501, Japan.

⁶Now at Department of Physics & Astronomy, University of Hawaii at Manoa, Honolulu, Hawaii 96822, USA.

⁷Now at Instituto de Física Corpuscular, IFIC (CSIC/UV), 46980 Paterna, Spain.

⁸Corresponding author. E-mail address: roberto.santorelli@ciemat.es.

⁹Now at Institut für Physik and Excellence Cluster PRISMA, Johannes Gutenberg-Universität Mainz, 55128 Mainz, Germany.

- ^aDepartment of Physics, Tokyo Institute of Technology, Tokyo, 152-8551, Japan
- ^bCentro Brasileiro de Pesquisas Físicas, Rio de Janeiro, RJ, 22290-180, Brazil
- ^cMax-Planck-Institut für Kernphysik, 69117 Heidelberg, Germany
- ^dIII. Physikalisches Institut, RWTH Aachen University, 52056 Aachen, Germany
- ^ePhysik Department, Technische Universität München, 85748 Garching, Germany
- ^fIPHC, Université de Strasbourg, CNRS/IN2P3, 67037 Strasbourg, France
- ^gUniversity of California, Davis, California 95616, USA
- ^hResearch Center for Neutrino Science, Tohoku University, Sendai 980-8578, Japan
- ⁱInstitute of Nuclear Research of the Russian Academy of Sciences, Moscow 117312, Russia
- ^jThe Enrico Fermi Institute, The University of Chicago, Chicago, Illinois 60637, USA
- ^kDepartment of Physics and Astronomy, University of Alabama, Tuscaloosa, Alabama 35487, USA
- ^lAstroParticule et Cosmologie, Université Paris Diderot, CNRS/IN2P3, CEA/IRFU, Observatoire de Paris, Sorbonne Paris Cité, 75205 Paris Cedex 13, France
- ^mCentro de Investigaciones Energéticas, Medioambientales y Tecnológicas, CIEMAT, 28040, Madrid, Spain
- ⁿColumbia University; New York, New York 10027, USA
- ^oUniversidade Federal do ABC, UFABC, Santo André, SP, 09210-580, Brazil
- ^pMassachusetts Institute of Technology, Cambridge, Massachusetts 02139, USA
- ^qSUBATECH, CNRS/IN2P3, Université de Nantes, Ecole des Mines de Nantes, 44307 Nantes, France
- ^rDepartment of Physics, Drexel University, Philadelphia, Pennsylvania 19104, USA
- ^sKepler Center for Astro and Particle Physics, Universität Tübingen, 72076 Tübingen, Germany
- ^tArgonne National Laboratory, Argonne, Illinois 60439, USA
- ^uNRC Kurchatov Institute, 123182 Moscow, Russia
- ^vCommissariat à l’Energie Atomique et aux Energies Alternatives, Centre de Saclay, IRFU, 91191 Gif-sur-Yvette, France
- ^wUniversidade Estadual de Campinas-UNICAMP, Campinas, SP, 13083-970, Brazil
- ^xDepartment of Physics, Kobe University, Kobe, 657-8501, Japan
- ^yDepartment of Physics, Kansas State University, Manhattan, Kansas 66506, USA
- ^zCenter for Neutrino Physics, Virginia Tech, Blacksburg, Virginia 24061, USA
- ^{aa}Department of Physics and Astronomy, University of Tennessee, Knoxville, Tennessee 37996, USA
- ^{ab}Department of Physics, Illinois Institute of Technology, Chicago, Illinois 60616, USA
- ^{ac}Department of Physics, Kitasato University, Sagamihara, 252-0373, Japan
- ^{ad}University of Notre Dame, Notre Dame, Indiana 46556, USA
- ^{ae}Department of Physics, Tokyo Metropolitan University, Tokyo, 192-0397, Japan
- ^{af}Hiroshima Institute of Technology, Hiroshima, 731-5193, Japan
- ^{ag}Tohoku Gakuin University, Sendai, 981-3193, Japan

E-mail: roberto.santorelli@ciemat.es

Abstract: During the commissioning of the first of the two detectors of the Double Chooz experiment, an unexpected and dominant background caused by the emission of light inside the optical volume has been observed. A specific study of the ensemble of phenomena called Light Noise has been carried out in-situ, and in an external laboratory, in order to characterize the signals and to identify the possible processes underlying the effect. Some mechanisms of instrumental noise originating from the PMTs were identified and it has been found that the leading one arises from the light emission localized on the photomultiplier base and produced by the combined effect of heat and high voltage across the transparent epoxy resin covering the electric components. The correlation of the rate and the amplitude of the signal with the temperature has been observed. For the first detector in operation the induced background has been mitigated using online and offline analysis selections based on timing and light pattern of the signals, while a modification of the photomultiplier assembly has been implemented for the second detector in order to blacken the PMT bases.

Keywords: Neutrino detectors; Photoemission; Detector design

Contents

1	Introduction	1
2	The Double Chooz light detection system	2
3	Evidence of spontaneous emission of light by the Double Chooz PMTs	5
4	Laboratory tests and explanation of the effect	7
4.1	Light emission features	7
4.2	Epoxy investigation	9
5	Characterization of the Light Noise during the commissioning of the far detector	12
5.1	Evolution of the Light Noise during the physics runs	14
6	Cuts and background rejection	15
7	The near detector	19
8	Conclusions	21

1 Introduction

Evidence of the contamination of the physics data by an instrumental background arising primarily from light signals produced inside the photomultipliers assembly has been reported by many experiments over the past years [1–5]. In some cases the instrumental background has been described as a fast ($\approx 10 - 100$ ns) flash of light or, in other cases, as a train ($\approx 1 - 10$ μ s) of pulses similar to the glowing in gas.

It is possible that the spurious light emission is detected by some of the surrounding or opposite tubes in such a way that the event can satisfy the trigger logic and be recorded on disk. In some cases it is necessary to turn off permanently the most active PMTs in order to reduce the contamination of the physics sample with spurious events or to limit an undesirable trigger dead time [6]. A set of cuts, typically based on the event topology, has to be used to reject the instrumental background offline, and the evaluation of the cut efficiency and acceptance, as well as the monitoring over time of the background stability in rate and amplitude, are then required over the entire data taking. Additionally a visual scanning of the events was required on some occasions in order to reject the remaining background [1] contaminating the physics sample. The possible *flashing* or light *glowing* of the optical units is considered a potential concern for the future giant neutrino detectors equipped with several thousands of PMTs [7, 8]. A potential correlation of the ensemble of phenomena called Light Noise (LN) with temperature and high voltage has been sometimes

evidenced [9, 10], however poor information can be found in literature and, to the best of our knowledge, no systematic study of the effect or explanation of the light emission mechanism have been published.

During the preliminary tests of the Double Chooz far detector (FD), the first one operational of the two foreseen by the project, an unexpectedly high light signal rate was measured before the detector was filled with liquid scintillator. Photon emissions, not evidenced at the time of the characterization of the PMTs in laboratory and not caused by light leaks, were detected when the PMTs were switched on, with a rate correlated to their high voltage values. None of the tubes was able to justify the total trigger rate observed, but each PMT was an effective emitter with a rate of the order of $\approx 0.1 - 1 \text{ s}^{-1}$, with some units more active than the others. The pulses were able to trigger the DAQ and contaminate the physics data sample. The effect remained substantially unchanged after the filling of the detector.

Detailed investigations, also with laboratory tests on photomultipliers of the same type as the ones installed in Double Chooz, have been carried out in order to clarify the features of the light pulse and its production mechanism. It has been observed that the light emission was likely localized on the photomultiplier base, and it was produced by the combined effect of heat and high voltage across the electric components. Currently more than 75 % of the total triggers in the far detector are identified as spurious events produced by this instrumental background. As predicted by the tests in laboratory an overall increase over time of the LN rate has been measured during the physics runs. Evidences of the correlation of the rate with the seasonal variation of the detector temperature have been additionally found after three years of data taking, thus a temperature control system has been operated in the far detector in order to reduce such dependence. At the same time the bases of the near detector (ND) PMTs have been covered with a black sheet of a radiopure and chemically neutral material (Lumirror) that substantially reduced the impact of that background.

The characteristic features of the effect, the details on the modifications implemented to the PMT assembly and the cuts used to reject the background are reported in the following. The results of the investigations can be particularly relevant for other experiments that are known to use similar optical units or base assembly [3, 5, 11].

2 The Double Chooz light detection system

Double Chooz is a reactor neutrino experiment which recently measured the mixing angle θ_{13} through reactor antineutrino disappearance. The electron antineutrinos of energy $E_{\bar{\nu}_e}$, produced by the two reactor cores of the Chooz nuclear power plant in France, are detected through inverse beta decay (IBD): $\bar{\nu}_e + p \rightarrow e^+ + n$ in hydrocarbon liquid scintillators that provide the free proton targets. The IBD signature is a coincidence of a prompt positron signal followed by a delayed neutron capture and the $\bar{\nu}_e$ energy is reconstructed from E_{prompt} , the positron visible energy ($E_{\bar{\nu}_e} \cong E_{\text{prompt}} + 0.78 \text{ MeV}$). Results obtained with the first detector in operation, located 1050 m from the two reactors, show the reactor electron antineutrino disappearance to be consistent with neutrino oscillations. From a fit to

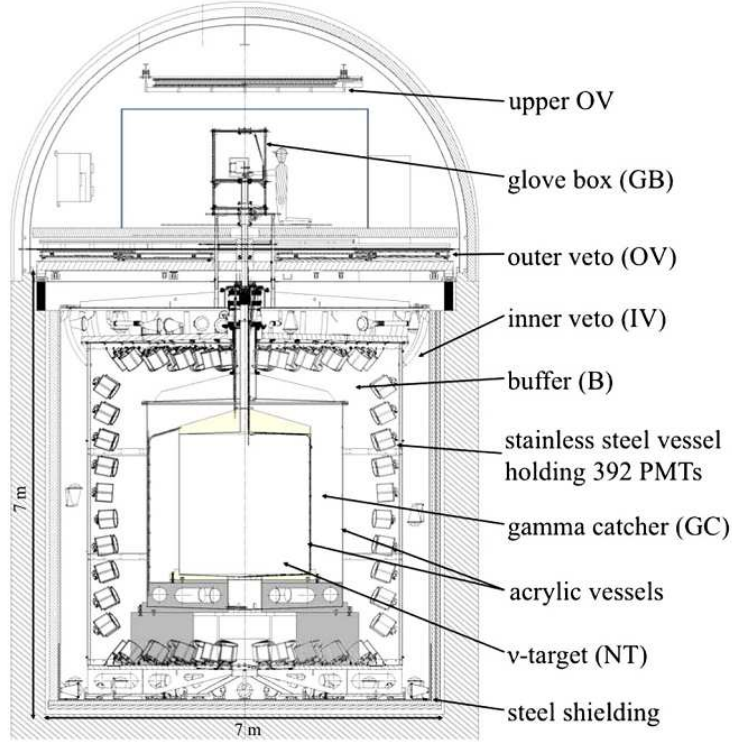

Figure 1. Cross section of the far detector.

the observed energy spectrum we found θ_{13} to be $\sin^2 2\theta_{13} = 0.090^{+0.032}_{-0.029}$ [12]. The experiment continues to run and a near detector, placed at 400 m from the reactor cores and almost identical to the far one, is now in operation and is expected to reduce the systematic uncertainties related to reactor neutrinos (flux and energy) and detection efficiency, achieving at least a precision on $\sin^2 2\theta_{13}$ of ~ 0.015 in three years of data taking [12].

The main bulk of the detector is made of four concentric cylindrical tanks with three central volumes, collectively called the inner detector (ID), optically coupled. The innermost of two acrylic vessels contains 10.3 m^3 of gadolinium-loaded (1 g/l) liquid scintillator (20 % PXE, 80 % Dodecane, PPO, Bis-MSB [13]) that acts as a $\bar{\nu}_e$ -target (NT, Fig. 1). The NT is placed in the γ -catcher (GC), a 55 cm thick Gd-free liquid scintillator (4 % PXE, 46 % Dodecane, 50 % mineral oil, PPO, Bis-MSB) layer used to detect gamma rays escaping from the NT. The GC is surrounded by a 105 cm thick mineral oil layer (buffer) whose task is to shield from radioactivity coming from PMTs and surrounding rock. The light readout system is based on 390 10-inch PMTs that are installed on the inner wall of the stainless steel buffer tank and angled to maximize the light collection uniformity at the trigger stage [14]. Outside the ID, and optically separated from it, a 50 cm thick liquid scintillator inner veto (IV) volume is equipped with 78 8-inch PMTs, and acts as an active shield to veto the interactions produced by cosmic muons or external radioactivity. The detector is surrounded by a 15 cm thick layer of demagnetized steel to suppress external

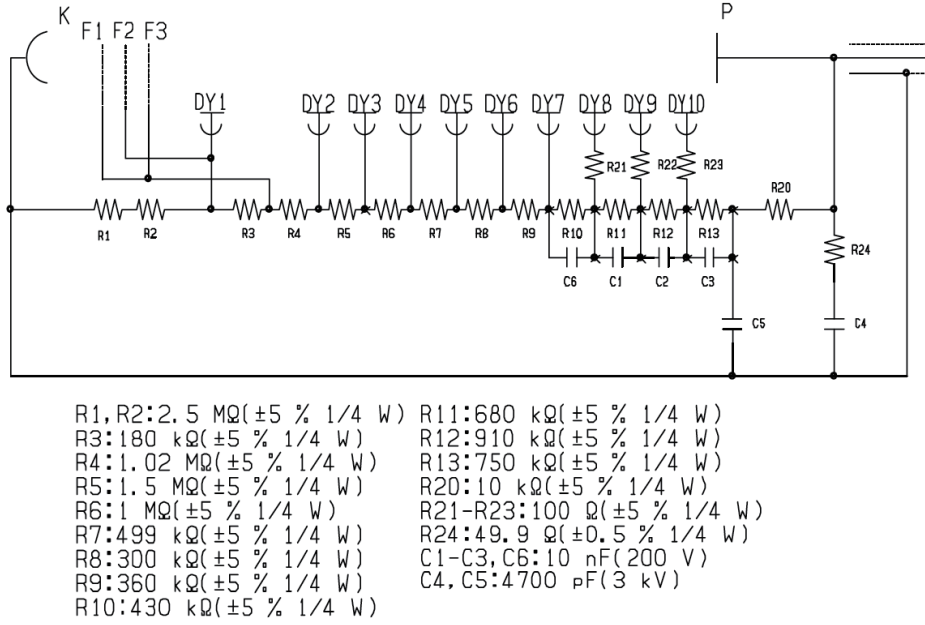

Figure 2. Schematic of the breeder circuit of the Double Chooz PMTs [15].

gamma rays, and is covered by an outer veto system (OV) made of plastic scintillator strips modules to tag muons.

A set of 390 10-inch diameter low-background PMTs (R7081MOD-ASSY) produced by Hamamatsu Photonics [15] is used to detect the scintillation light produced in the ID. The 10 inch diameter low background PMTs are characterized by good photoelectron separation and timing resolution [16, 17]. The PMT assembly is equipped with a breeder circuit (Fig. 2) which accommodates a single cable readout¹. A round board and the cable end (Fig. 3-left) are soldered to the base electrodes. The PMTs are operated with positive high voltage of 1320 V on average corresponding to a gain of $\approx 10^7$, and a maximum voltage difference of 520 V is generated between the cathode and the first dynode of the PC board. About 0.05 W of heat dissipation on R1 and R2 (Fig. 2) makes the PC board temperature locally slightly higher. The entire PMT is submerged in an organic oil (buffer liquid) made of a mixture of n-alkanes and mineral oil [13]. The maximum oil depth is 7 m and the maximum oil pressure on the PMT and its base is 0.6 atm. The base circuit part is molded with epoxy resin (main agent MG151+ hardner HY306 [18]) to insulate the PCB and the electric parts from the oil as shown in Fig. 3-right. The resin is contained in an acrylic case with a hole at the center of the end plate to allow for the volume change during the polymerization process of the resin. The choice of transparent acrylic and epoxy allows visual inspection of the sealing as well as of the electric components of the base circuit. The oil prevention treatment is similar to the ones used for KamLAND, RENO and Daya Bay PMTs.

The whole PMT is surrounded by a cylindrical (0.5 mm thick, 275 mm height and

¹ Some ringing of the PMT signal was evident in case of very large light pulses [14].

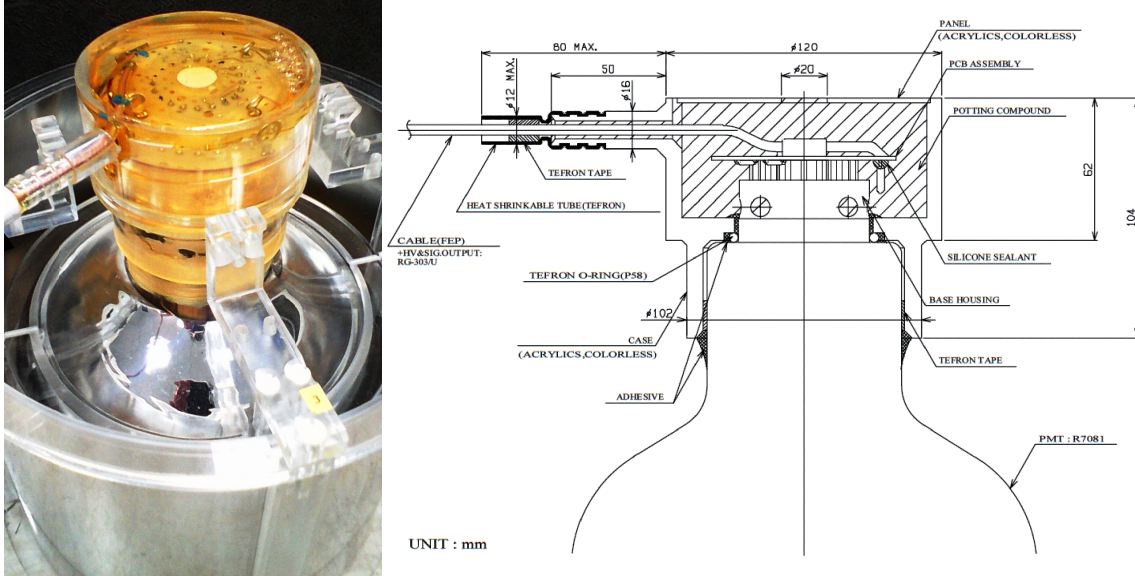

Figure 3. Picture of the optical unit (left) and cross section of the base assembly (right) [15].

300 mm inner diameter) mu-metal magnetic shield. The dimensions of the shield and its relative position with respect to the PMT photocathode are optimized to maximize the shielding capability with the minimal loss of light collection [19]. The distance between the top of the PMT and the shield edge is 5.5 cm. The inner wall of the mu-metal is a metal surface with a measured reflectivity of $\sim 60\%$ at ~ 400 nm and, being almost completely specular, it acts as an effective light concentrator/collimator.

3 Evidence of spontaneous emission of light by the Double Chooz PMTs

During the preliminary commissioning of the far detector and before its filling with liquid scintillator, tests of the light detection system were carried out by taking data with a 16 channels portable readout system connected to 16 PMTs located on the bottom of the buffer vessel. The PMT pulses were taken directly before the front-end electronics [20] and the signal coincidence rate was recorded. A ≈ 120 Hz rate for a 4-fold multiplicity condition was measured with all 390 PMTs at 1000 V. The rate dropped to ≈ 10 Hz powering only the 16 monitoring PMTs, thus suggesting that the high coincidence rate measured with all the PMTs switched on was produced by the emission of light inside the detector and was not caused by any light leaks². Additional scans were performed evidencing the correlation between the measured coincidence rate and the number of PMTs turned on (Fig. 4-left), thus it was possible to exclude a possible malfunctioning of some specific units and explain the process as a general behavior of the PMT array. LN events appeared within few tens of seconds after the voltage of the monitored PMTs was ramped up, and stayed stable over the following hours (Fig. 4-right). Subsequently an even higher trigger rate was measured

² Similar results were found for different sets of PMTs.

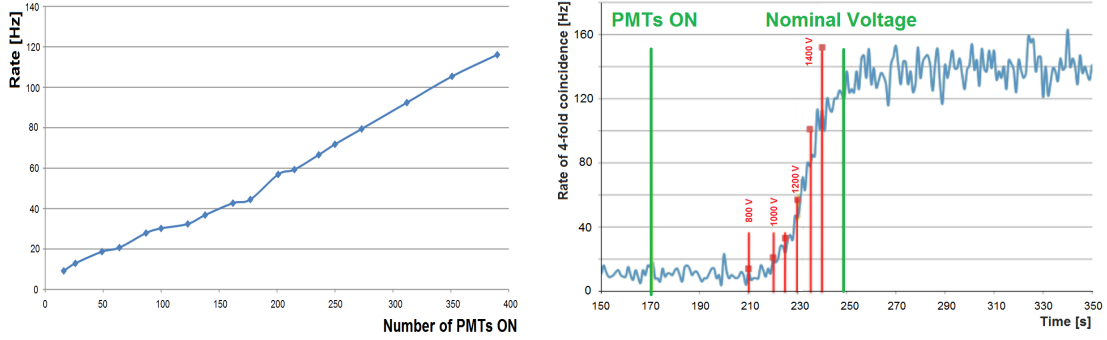

Figure 4. Coincidence rate measured with 16 monitor PMTs versus total number of PMTs on (left) and trigger rate progression as the high voltages of the monitored PMTs are ramped up (right) during the preliminary tests before the filling of the detector. The rate is measured by the 4-fold coincidence.

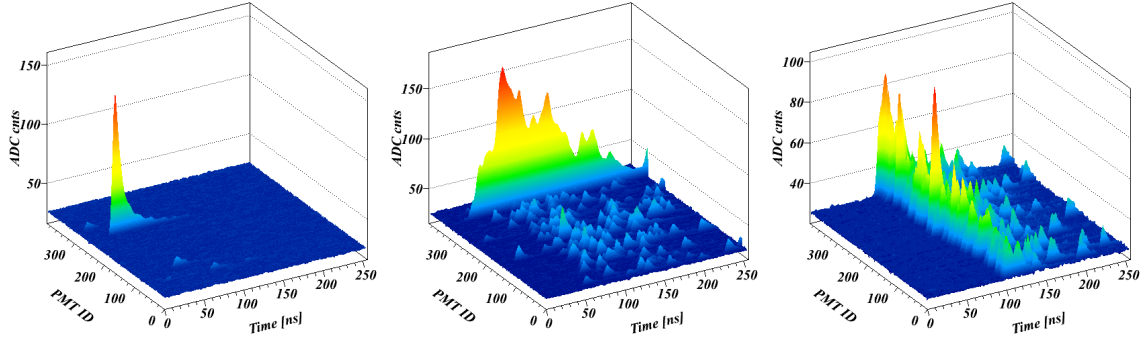

Figure 5. Time profile of the FD's PMT pulses detected for two typical LN events (left and middle) compared with a neutrino interaction (right). Only in the last case the signals of the different PMTs are similar and the time correlation between the arrival time of the photons is evident.

in operating conditions above the foreseen neutrino threshold (0.4 MeV) with the PMTs at the nominal voltages.

The effect remained substantially unchanged after the filling of the detector. A visual inspection of the waveform of those events excluded that the effect was produced by electronic noise, suggesting that the signal detected appeared to be produced by light pulses, which spanned in time from a few tens to hundreds of ns. In Fig. 5 two typical events are compared with a neutrino interaction. In case of LN, larger pulses were detected by one specific PMT, on the contrary, in case of a neutrino interaction, similar light signals were detected by all PMTs with a time correlation featuring the time-of-flight of the scintillation photons. Even though, on an event by event basis, the dominant charge signal was produced by one PMT, the light spread out inside the detector after several reflections, triggering the DAQ and contaminating the physics data sample.

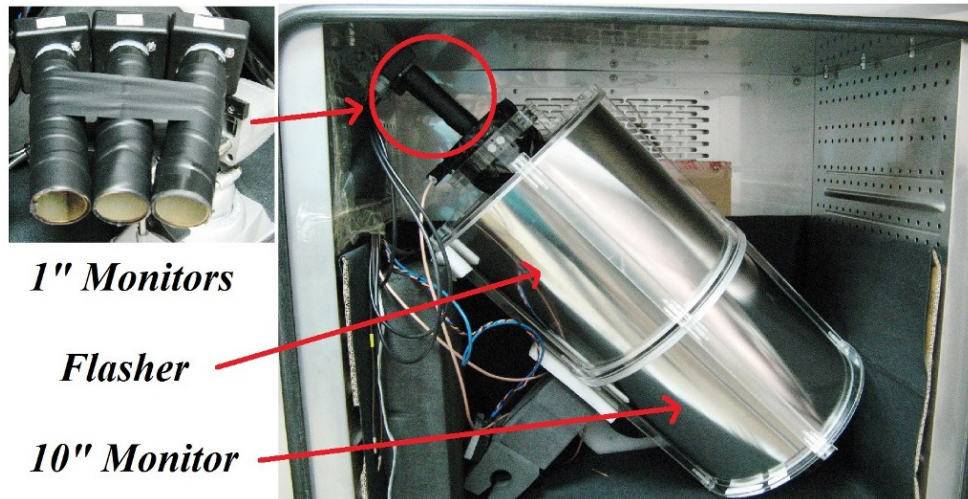

Figure 6. Experimental setup used for the tests in laboratory with the 4 monitor PMTs and the flasher placed in a climate-controlled chamber.

4 Laboratory tests and explanation of the effect

The features of the light signal and the possible physical processes causing the emission of light was studied in the laboratory with dedicated tests. Data were acquired with three 1" Hamamatsu R6095 PMTs placed on top of the base (Fig. 6) of a 10" R7081 PMT³. The PMTs were located in a climate-controlled chamber (Binder MKF240) that was completely light-tight and allowed to carry out the test in a controlled environment of humidity and temperature. Another R7081 PMT⁴ was placed in front of the tested unit in order to investigate the light escaping its reflector shield. Several runs have been taken in different configurations covering or uncovering the base, the shield and the photocathode of the emitter with a black sheet. While the main purpose of the measurement was the study of rate, amplitude and pulse shape of the light signal in different and controlled conditions, the small size of the 1" monitor PMTs placed directly on the base also makes the setup suitable for the identification of the light emission position. The glowing events are identified by the coincidence of the three 1" PMTs (200 ns window) with a signal threshold corresponding to 1 photoelectron. An 8 μ s window (1 μ s pre-trigger) is then digitized using a CAEN flash ADC (N6720) with 250 MHz sampling rate. A LED placed inside the chamber allowed to monitor the PMTs gain stability during the tests. Background runs for each configuration have been taken for reference by keeping the emitter switched off.

4.1 Light emission features

Several measurements have been made changing the voltage supplied to the light emitter and the temperature. In Fig. 7 the prompt direct dependence of the measured coincidence rate

³ The PMT has been previously identified as a flasher at room temperature.

⁴ A negligible light emission rate has been measured for that PMT during preliminary tests.

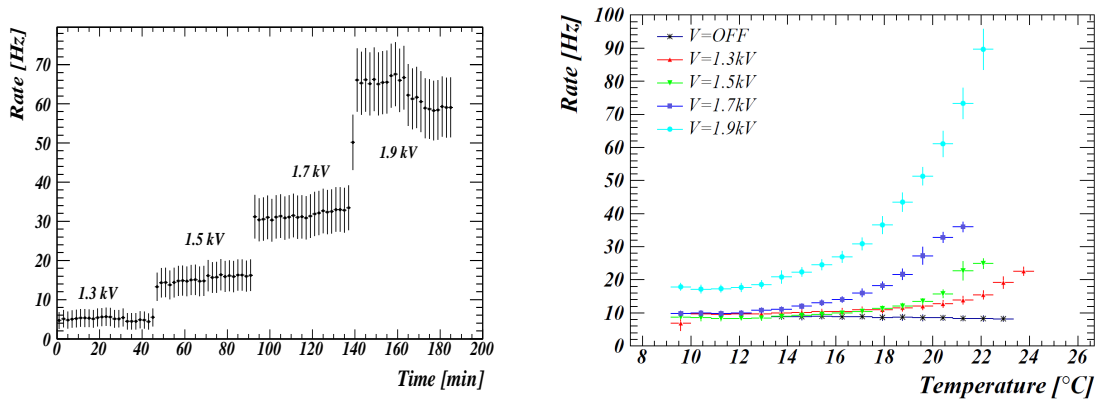

Figure 7. Variation of the light emission rate (3-fold coincidence) for different PMT high voltage values, keeping stable (left) or changing (right) the PMT temperature. A rise of the temperature always corresponds to higher rates and bigger amplitudes of the detected signals.

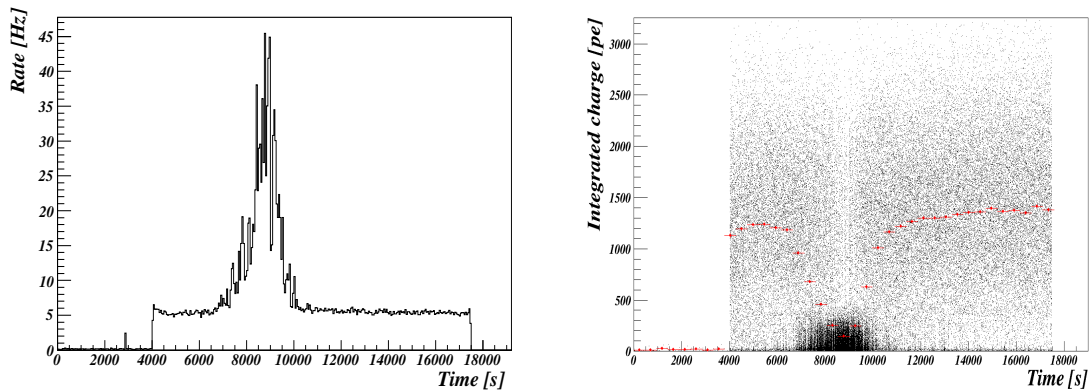

Figure 8. Variation of the monitoring PMTs coincidence rate during a LN test in stable conditions (left). The coincidence rate during the first 4000 s with the 10" glower off are shown for reference. Evolution of the integrated charge (back dots - right) and variation of the overall mean value (red dots - right) as a function of the time.

with the increase of voltage and temperature is shown, confirming the observations already noted during the preliminary tests in the far detector. A rise of the temperature always produced an increase in the light production rate, however during the tests it was noticed that the corresponding decrease of the temperature was not able to lower the emission in the same way. A rate hysteresis is thus produced moving back the temperature to the original value, with the frequency of the emission always higher after every cycle. In order to coherently characterize the light emission, the results presented in the following were obtained at constant values of temperature ($T=25\text{ }^{\circ}\text{C}$), voltage ($V=1400\text{ V}$) and humidity (60 % relative value).

In Fig. 8-left the evolution of the trigger rate is shown as a function of time for a typical run taken during the tests in laboratory with the PMT in stable conditions. During the first part of the run ($t < 4000\text{ s}$) the glower was switched off in order to measure the

background rate. Some triggers (≈ 0.1 Hz rate) mainly given by cosmic rays and cross talk between the channels have been recorded, however their impact can be considered negligible for this analysis. Even though the PMTs have been kept in stable conditions, a significant variation of the rate is evident. An average trigger rate of ≈ 6 Hz has been measured shortly after the glower was switched on, however the rate rose to as much as 45 Hz for roughly a one hour transient and then went back down to ≈ 6 Hz again without any apparent reason, thus evidencing a clear instability of the light emission process.

The variation in time of the charge integrated in the same 200 ns digitization window has been investigated in the regions evidenced by the different trigger rate values. In Fig. 8-right the integrated signal in number of photoelectrons detected by one 1" monitor PMT is plotted as a function of time. The increase in the rate is produced by signals with an amplitude smaller than the typical signal detected in the flat rate regions. In Fig. 9 two typical waveforms are shown for events in the low (first waveform) and high (second waveform) rate region. While the first one is characterized by the detection of hundreds of photoelectrons in 200-300 ns, the second event is given by the detection of a train of pulses of few ($\approx 1-2$) photoelectrons over several μs . However, even though the light pulses have widely different features, the integral signals obtained by summing up the total charge detected on large (≈ 1 s) time scale is similar (Fig. 10-left). The average number of photoelectrons detected per second seems to be constant and independent of the type of light pulses detected, thus suggesting a possible common physical process that releases the same stored energy through complementary light production mechanisms. The analysis of the signal asymmetry $(S_{PMT1} - S_{PMT3}) / (S_{PMT1} + S_{PMT3})$ between the two monitor 1" PMTs on the sides evidences different constant ratios (Fig. 10-right), suggesting the presence of different emission points on the base each of which characterized by a peculiar light signal in terms of shape, rate and amplitude.

Additional tests carried out with other R7081 PMTs, initially not identified as flashers after tests at room temperature, showed that a light emission can be induced by raising the temperature and/or the voltage to values higher than the normal operating conditions, thus suggesting that the light emission is a general effect that can characterize any Double Chooz optical unit. At the same time further tests carried out with a naked base not covered by epoxy did not evidence an emission of light in any condition. This excluded the possibility that the LN was simply caused by thermal emission and suggested a central role of the epoxy in the light production mechanism.

4.2 Epoxy investigation

More detailed investigations on the behavior of the epoxy used to cover the PMTs base have been carried out in the laboratory. Two pins (0.6 mm diameter) have been connected to a power supply and inserted (≈ 5 mm distance) in a small piece of epoxy (≈ 10 g). The signal coincidence rate of two 1" PMTs, of the same type as used in Fig. 6, has been used to monitor the emitted light. A ceramic heater has been placed underneath the epoxy sample in order to raise its temperature. While no emission of light has been observed without field between the pins, light signals have been detected with HV values of the order of 1 kV, thus confirming the central role of the epoxy in the production of light. Events similar

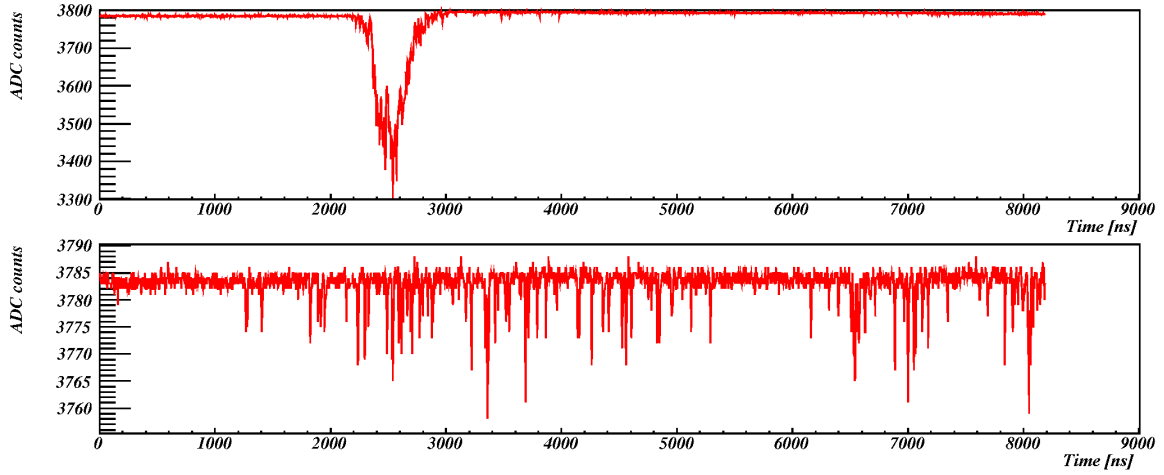

Figure 9. Different LN pulses detected during the tests in laboratory: while the first one is characterized by a bigger flash of light of some hundreds of ns, the second one is a train of small pulses of some μs .

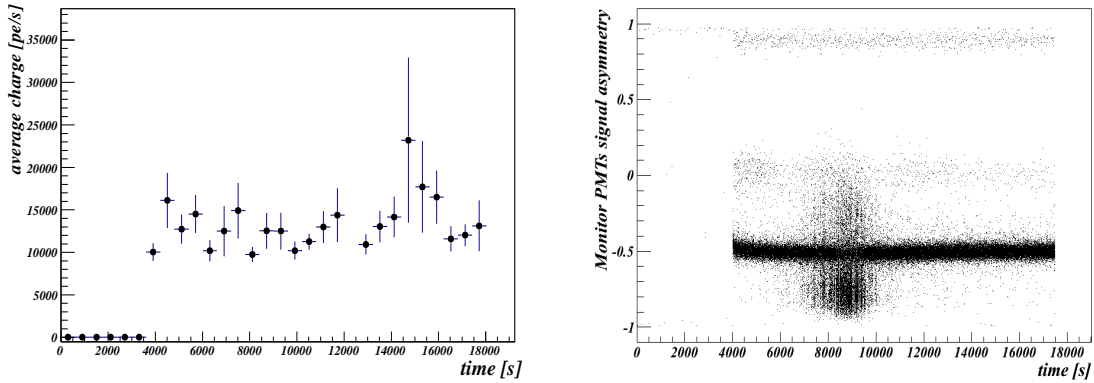

Figure 10. Average signal detected in pe/s (left) and evolution in time of the signal asymmetry (see text for details) between two monitor PMTs (right) (same run of Fig. 8). Multiple emission points can be identified on the base corresponding to the different asymmetry values.

to the ones detected during the tests of the R7081 PMTs have been detected (Fig. 11-left), with shapes related to the distance between the pins and pin holes sizes. Additionally a clear dependence of rate and amplitude of the signals on HV and temperature has been evidenced as in the previous tests. A major rise in the temperature of the sample ($\approx 50^\circ C$ average value measured with a thermographic camera) and HV ($\approx 4-5$ kV) of the sample made possible to take pictures of the light emission with a high sensitivity digital camera on several minutes exposure. In Fig. 11-right the light pattern recorded by the camera (almost blue or violet) has been superimposed on the image of the epoxy sample and the HV pins. A clear emission point can be noticed at the edge of one pin, while the rest of the

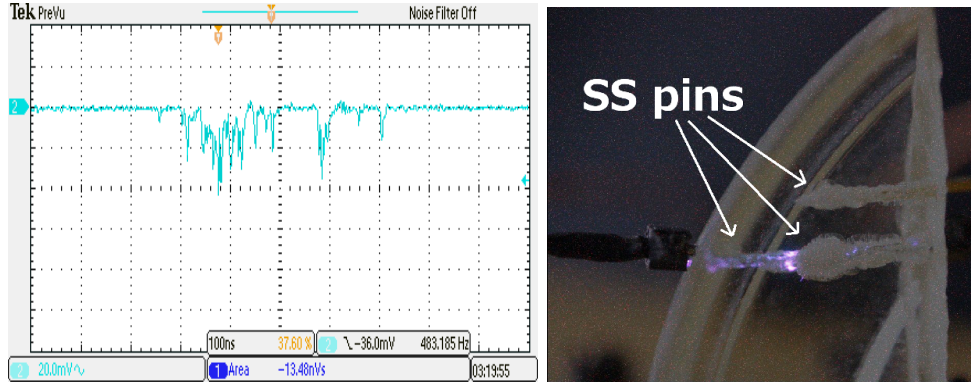

Figure 11. Typical signal detected with the epoxy sample in the electric field (left) and light emission recorded in dark conditions by the high sensitivity camera after 5 minutes exposure (right) with $T \approx 50^\circ\text{C}$ (the epoxy sample image has been overlapped to the light recorded in dark conditions). Three metal pins at different potentials have been inserted in the sample, the light emission is evident only on the cathode pin (see text for details).

pattern is mainly dominated by the light diffracted on the cracks in the epoxy holes. The emission of light is localized close to the electrode with the lower potential while it seems to be absent (or too low to be detected) on the other one. That is also the case switching the polarity between the opposite pins: after a short transient (few minutes) when the light is visible on both pins the luminosity near the anode decreases and eventually disappears. Also, more intense light emissions have been observed when the epoxy and the pins are closer (or in direct contact).

In order to fully prove that the light emission of the PMTs can be produced by the combined effect of heat and high voltage on the epoxy glue covering the base circuit, a small sample has been placed between the two pins of a $10\text{ M}\Omega$ resistor similar to the ones used on the Double Chooz PMTs base, that also acts as heater for the epoxy when a current of some mA flows in the resistor. In Fig. 12-left the image recorded by the camera in dark conditions is shown. A clear bright spot is evidenced where the cathode pin is in contact with the epoxy, while the illumination of the sample body is probably given by the diffracted light. No light emission has been recorded by the camera in dark conditions after removing the epoxy or isolating the metal pins with black tape, thus preventing the direct contact of the epoxy with the electrodes. A similar glowing emission has been observed with two different pieces of epoxy in contact with the resistor pins and separated in the middle by a small gap (Fig. 12-right). Light production, probably given by corona discharge in air caused by the polarization of the two samples, is evident while no electric discharge is observed putting the pins at the possible minimum distance. On the contrary the light production point moves back to the cathode pin location when putting the two epoxy pieces in direct contact. Similar results have been obtained carrying out the same tests with other different types of transparent epoxy commercially available (Epo-Tek[®] 301-2 [21], Araldite[®] 2011 [22]).

The previous results fully proves that the epoxy used to cover the electronic compo-

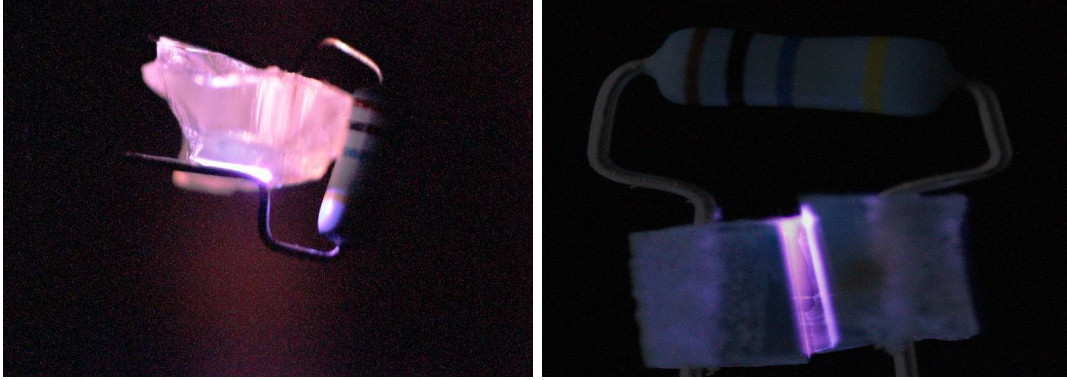

Figure 12. Glowing of epoxy samples placed on a resistor recorded with the camera in dark conditions.

nents can cause the emission of light under certain conditions of voltage and temperature, thus explaining the light emission from the Double Chooz PMTs base. A possible simple explanation of the effect can be given considering that, due to the polarization of the epoxy, a strong field is present around the electrodes. According to that scenario photons can be produced by the glowing of the air trapped between the epoxy and the pins through a corona effect. It is possible that the vapor pressure of the epoxy components could also play a role causing the corona. The possible glowing of the gas trapped at the interface between insulating layers with different dielectric properties is a well known phenomenon in industry, and procedures to remove air from epoxy or urethane mixtures are typically suggested before the encapsulation of electronic components [23].

5 Characterization of the Light Noise during the commissioning of the far detector

The Double Chooz Flash ADCs record the complete waveforms in a 256 ns digitization window with 2 ns sampling, thus allowing the full comparison between spurious and scintillation emissions in terms of pulse shape. The LN signals are typically characterized by a quite irregular shape with a relatively slow rise time (≈ 70 ns, Fig. 13-left) compared to the well known smooth shape with short rise time (≈ 10 ns, Fig. 13-right) typical of the scintillator.

As evidenced in the previous section one of the possible kinds of LN emission is in form of a long train of small pulses at the level of the single photoelectron. Thus, in this case, it is possible that the baseline measured in the pre-trigger region (first 50 ns of the digitized signal) significantly differs from the usual value since small pulses, not producing any trigger, can be present. Additionally a single spurious light emission can produce one or even two triggers resulting in correlated background.

The entire energy region of interest ($[0.4, 20]$ MeV) seems to be contaminated by the LN background. At higher energies the emitter can be more easily identified since the majority of the photons produced are detected by the PMT itself. The rate of events at which a PMT detects the maximum charge is shown in Fig. 14-left as a function of the

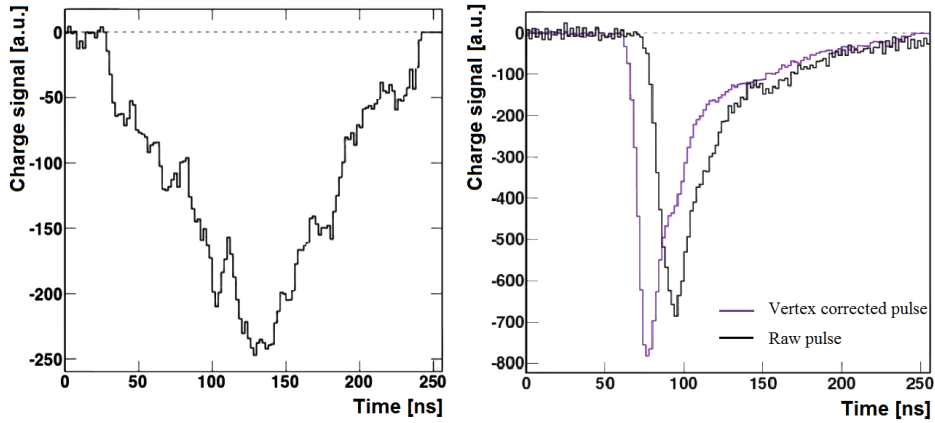

Figure 13. Summed waveforms recorded with the flash ADCs for a LN event (left) compared to a typical signal produced by the liquid scintillation (right). The shapes for the purple line have been corrected taking into account the estimated vertex position and the photons time of flight.

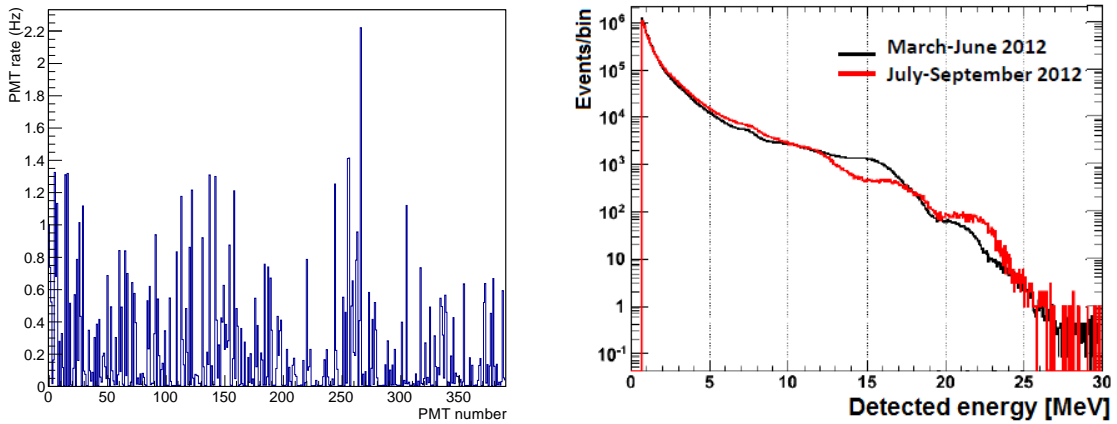

Figure 14. Rate of maximum charge detection vs PMT ID number (left), showing the units with higher rate that can be identified as possible hot LN emitters. Detected energy spectrum of LN (right) for two sets of data corresponding to the first Double Chooz publication (black) and to a later sample (red).

PMT id-number, allowing the units in the array showing the higher rate to be identified as the hottest flashers. At energies closer to the detector threshold, the identification is more difficult and more complex parameters based on the light pattern and the hit time distribution have to be considered in order to identify the spurious events (see Sec. 6). The detected energy spectrum after LN selection, shown in Fig. 14-right, is falling roughly exponentially.

It has not been possible to carry out a robust study of the LN emission position through the vertex reconstruction algorithms since the unusual light pattern detected translates into

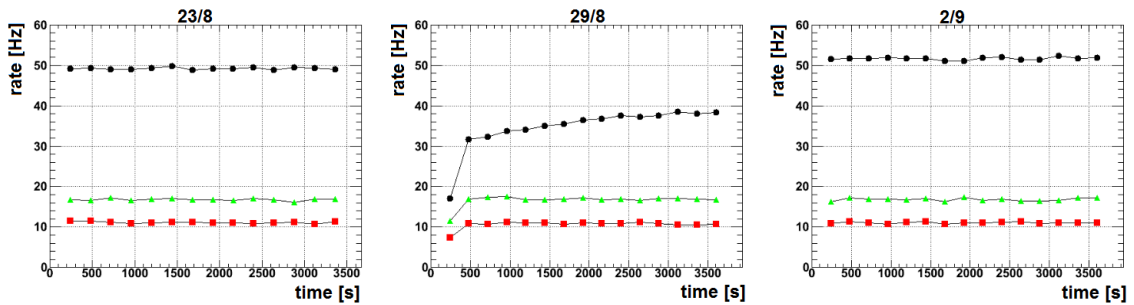

Figure 15. Rate variations for three consecutive runs. The black dots correspond to LN events, the red squares to $\bar{\nu}_e$ preselected candidates (see ref. [12] for the details on the selection) and the green triangles to muon events. The PMTs were switched-off after the first run (August, 24th) and switched-on during the second one (nominal voltages reached at $t \approx 500$ s - August, 29th).

a mis-reconstruction of the emission point by the software, such that the light appears to be emitted very often from hot spots in the center of the ID.

During the commissioning of the far detector, several tests were performed in order to decrease the LN rate. The PMT voltages were lowered such that the gains were finally 5/6 of the nominal value. As a result the rate of prompt ($\in[0.4,20]$ MeV) events decreased by $\approx 15\%$ before applying any rejection cuts, while the delayed ($\in[4,10]$ MeV) Gd capture signal rate went down by $\approx 40\%$. Switching off PMTs for a while had only a temporary impact on the background. In Fig. 15 the rate of $\bar{\nu}_e$ candidates [12] is compared with the ones of the events that are vetoed by the μ veto or tagged as LN (see Sec. 6) for dedicated runs taken before and after a six days power cut. The IBD candidates and muons rates, after a transient given by the power up of the PMTs ($t < 500$ s, Fig. 15-middle), seem to be stable and similar for all the runs, however the LN rate decreased temporarily right after the PMTs were powered back on and went back to a value similar to the original one after some days.

At the end of the commissioning phase in March 2011 the 15 hottest PMTs, identified among the more active units in events in which one PMT detected at least 10% of the total charge ($q_{\max}/q_{\text{tot}} > 0.1$), were switched off. This resulted in the overall emission rate in the detector being reduced by ≈ 30 Hz. Dedicated studies, also with Monte Carlo simulations, proved that the impact of the previous actions on the detector performance was minimal and no substantial anisotropy in the detector response was introduced since the switched-off PMTs were randomly distributed. The detector configuration was adopted as the default configuration and was kept stable over the physics runs.

5.1 Evolution of the Light Noise during the physics runs

The LN emission rate of each single photomultiplier has been unstable over the data taking. Some units showed an increasing emission which, for a subset of them, returned to normal. In spite of the actions taken during the commissioning phase to reduce the light emission, the overall trigger rate increased during the physics runs although the rate of the physics

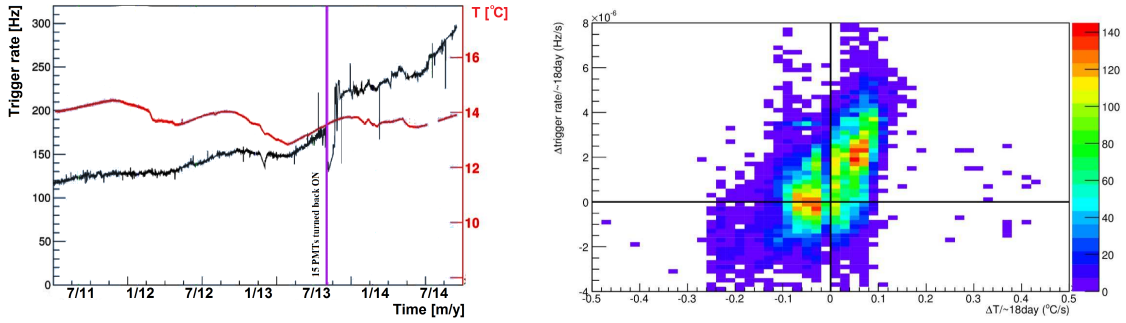

Figure 16. Variation in time of the trigger rate (black line) and buffer temperature (red line) from the start of the data taking (left): the sudden jump in the rate was produced by the 15 hot PMTs turned back on. Correlation between trigger rate and temperature gradient (right)

events was stable in the same period of time. In Fig. 16-left the variation of the total trigger rate is shown along with the temperature of the mineral oil in the buffer volume, evidencing a possible seasonal modulation of the background that increases from April to October while slightly decreases or remains stable from November to March. Even if quite small variations of the temperature (≈ 0.5 °C) have been measured, a positive gradient of the temperature has a clear impact on the event rate (Fig. 16-right), while a corresponding decrease has not been measured during the winter negative gradients. As a result a total trigger rate measured at the end of 2014, after three years of operations, was more than double the initial value. That could be explained because the rise of the temperature allows the polarization of epoxy molecules but negative temperature gradients freezes the status and do not reverse the effect, as was already observed during the laboratory test.

6 Cuts and background rejection

As discussed in Sec. 5, it was not possible to reject the LN events through the reconstructed vertex position, thus a set of variables have been studied in order to discriminate that background from the neutrinos interactions. LN pulses are characterized by an irregular shape with slower rise time with respect to the liquid scintillator pulses. A simple cut based on the rise time of the detected signal⁵ t_{rise} proved to have a certain LN identification capability. However, in order to guarantee a significant discrimination efficiency, the pulse had to be corrected by the time of flight between the reconstructed event vertex and each PMT position. Since the t_{rise} cut depends on the position reconstruction, we preferred to investigate a different low-level set of cuts that were not depending on the software algorithms.

Events in the energy range of interest ($E_{\text{vis}} \in [0.4, 20]$ MeV), and with no significant activity in IV ($Q_{\text{IV}} < 30000$ charge units, see ref. [12] for the details) are considered for the analysis. The LN emission, being localized in the PMT base, leads to inhomogeneous

⁵ Sum of signals produced by all the PMTs

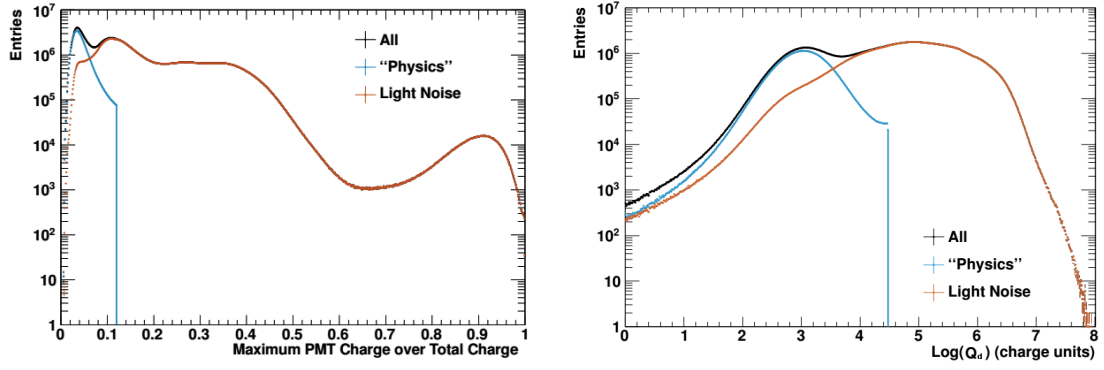

Figure 17. Histograms of q_{\max}/q_{tot} (left) and of Q_{dev} (right) for events before and after the LN selection (see the text for details). The impact of the cuts $q_{\max}/q_{\text{tot}} < 0.12$ and $Q_{\text{dev}} < 30000$ sample is evidenced.

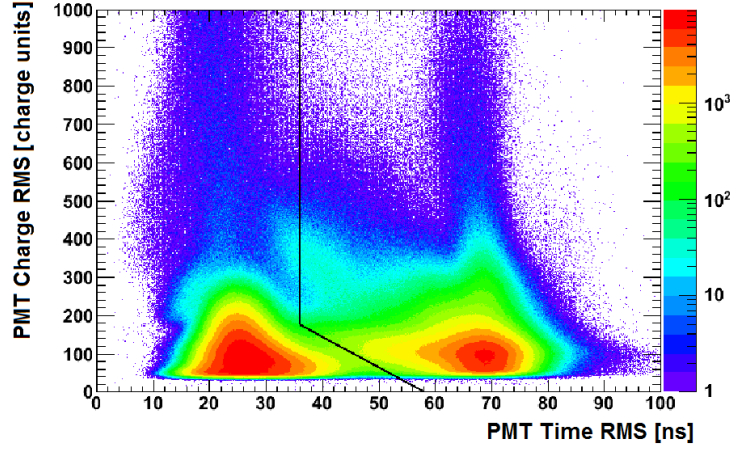

Figure 18. σ_q vs σ_t plane. q_{\max}/q_{tot} and Q_{dev} cuts are applied. The black line represents the 2D cut on the σ_q/σ_t plan. Events of interest belong to the left side of this line whereas LN events belong to the right side of this line.

distributions in charge and time among all the PMT. Therefore, one time-based as well as three charge-based variables were designed to identify and reject both the fast high energy LN events as well as the low energy long pulses:

- q_{\max}/q_{tot} corresponds to the ratio of the maximum charge recorded by a PMT over the total charge in the event
- Q_{dev} is defined as $Q_{\text{dev}} = 1/N \times \sum_i^N (q_{\max} - q_i)^2/q_i$ where N is the number of PMTs within a sphere of 1 m radius centered at the PMT with the maximum charge
- σ_t corresponds to the standard deviation of the PMTs hit time distribution
- σ_q corresponds to the standard deviation of the PMTs integrated charge distribution

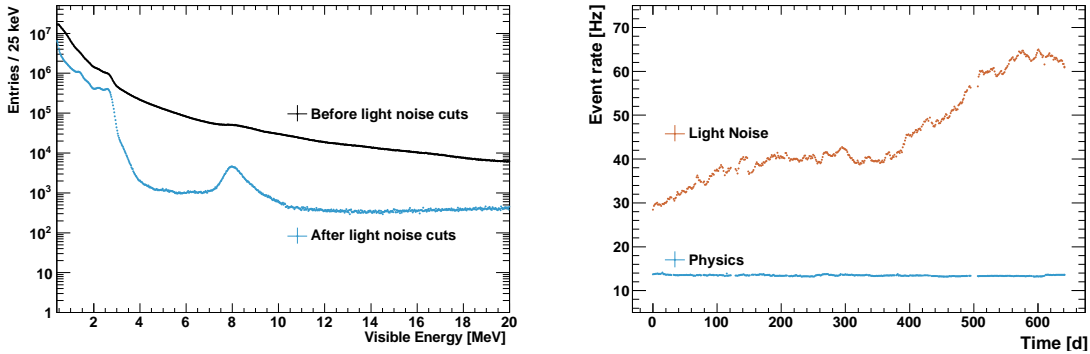

Figure 19. Visible energy spectra (left) obtained before (black) and after (blue) the LN rejection cuts. Evolution of the rates over time (right) for physics (blue) and LN event (orange).

Typically the PMT responsible for the light emission detects itself the maximum charge, thus the value q_{\max}/q_{tot} for those events tends to be larger than that of an interaction in the liquid scintillator. The q_{\max}/q_{tot} cut is then set to 0.12 (Fig. 17-left), the events with smaller values being considered as a possible scintillation emission inside the inner detector, while the others are classified as LN. Q_{dev} represents the charge non-uniformity for PMTs around the one with maximum charge, which tends to be larger for high energy LN events. The Q_{dev} variable is set to be lower than 30000 charge units for the events of interest (Fig. 17-right).

Additionally, a $\bar{\nu}_e$ -like event taking place inside the target is expected to have a nearly isotropic distribution of the light inside the inner detector, with a small spread in the photons arrival time at the PMTs. A contrario, in case of LN events characterized by long train of pulses emitted on a PMT base, the flasher, as well as the surrounding PMTs, detect promptly more photons than the units in the other side of the detector. Larger values of σ_t are expected for the LN events with respect to the physics events.

While the σ_t cut rejects efficiently the LN at higher energies, its combination with a cut based on the standard deviation of the PMTs integrated charge distribution σ_q proved to be more efficient in rejecting the LN at energies ≈ 1 MeV. Fig. 18 shows the σ_q vs σ_t spectra after applying both the q_{\max}/q_{tot} and Q_{dev} cuts. Two populations are distinguishable, separated by the black line, with the events of interest in the region at low σ_q and σ_t selected through $\sigma_t < 36$ ns or $\sigma_q < 464 - 8 \times \sigma_t$. Whereas previous analyses [24–26] used to remove events above 40 ns, the 2D cut minimizes the detection inefficiency at low energy allowing to lower the analysis threshold from 0.7 MeV to 0.4 MeV [12]. The final cuts used to reject the LN events are then:

- $q_{\max}/q_{\text{tot}} < 0.12$
- $Q_{\text{dev}} < 30000$ charge units
- $\sigma_t < 36$ ns or $\sigma_q < 464 - 8 \times \sigma_t$

The combination of those cuts proved to be efficient at discriminating event by event between LN and real interactions inside the target. The results presented here are based on

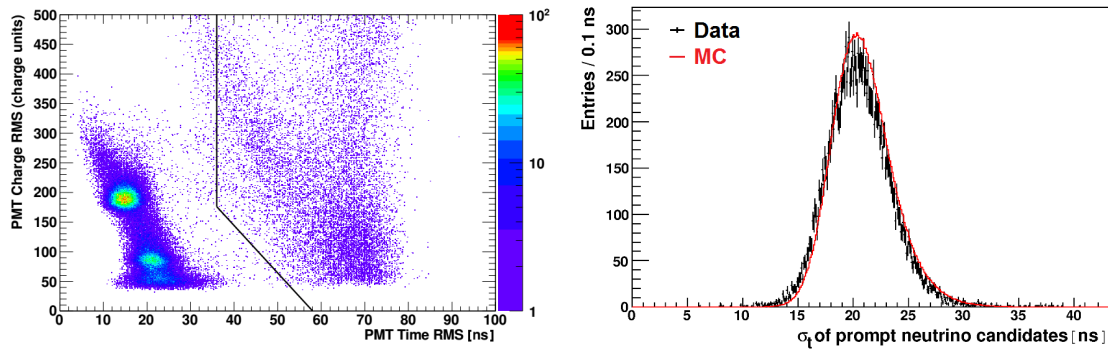

Figure 20. ^{252}Cf calibration data (source at the center of the detector) without any LN selection (left): the Gd and the H capture peaks (~ 190 and at ~ 80 charge units) can be discriminated from the LN events (population on the right) by the 2D cut in the σ_q vs σ_t plane. Distribution of the LN variable σ_t for neutrino candidates found for data and Monte Carlo (right).

the analysis of one fifth of the data used in [12] which extends from April 13, 2011 to January 30, 2013. As stated before, the events with visible energy not in the region of interest for the $\bar{\nu}_e$ analysis (i.e. between 0.4 and 20 MeV) are rejected, as well as the events with a charge deposition in the inner veto greater than 30000 charge units. Table 1 summarizes the single and the combined rejection of the data sample after the LN cuts. About 77.1 % of the events acquired don't pass the selection and are identified as background produced by spurious triggers.

Fig. 19-left shows the energy spectrum of the data sample before and after the LN cuts. The Gd capture peak around 8 MeV becomes clearly visible after the LN rejection, as well as the contribution given by the radioactive contamination below the 2.6 MeV peak from the ^{208}Tl . The remaining LN, eventually not rejected by the previous cuts, can be considered negligible for the θ_{13} analysis since the background is efficiently rejected requesting the coincidence between the prompt signal and delayed neutron capture. The possible contribution given by the coincidence of two uncorrelated LN signals is included in the accidental background, which is precisely measured through a pure accidental sample obtained by a delayed off-time (> 1 s) window [12]. Fig. 19-right shows the event rate for the two populations selected from Fig. 18. As expected the physics remains stable whereas the LN is increasing since the beginning of the data taking. No evidence of a correlated background produced by multiple triggers from long LN pulses has been found. Finally, the preliminary comparison between the physics sample after cuts with the data taken with near detector, whose PMT bases have been blackened (see Sec. 7), confirms the success of the LN rejection.

The LN strategy has been validated firstly on the calibration data. Different neutron calibration runs with a ^{252}Cf source placed at different positions along z-axis have been analyzed. In Fig. 20-left the events reconstructed in a sphere of 50 cm radius around the source are plotted in the σ_q vs σ_t plane after the same E_{vis} and Q_{IV} cuts detailed before. We clearly see a good separation between the physics events on the left and the LN on the right, with the the Gd capture peak, visible at 190 charge units, not affected by the

Cut	Single cut rejection	Combined rejection
σ_q/σ_t	67.8 %	67.8 %
q_{\max}/q_{tot}	51.9 %	76.2 %
Q_{dev}	51.4 %	77.1 %

Table 1. Fraction of events rejected by applying LN cuts. The first column represents the total events rejected by each cut independently, the second column the total events rejected by successively applying the cuts: 22.9 % of the events pass the selection.

2D cut. Dedicated simulations have been carried out in order to tune the rejection criteria (Fig. 20-right) and estimating the inefficiency on the inverse beta decay selection. The Monte Carlo based calculation of the inefficiency on IBD candidate was evaluated to be at 0.0004 ± 0.0002 % for σ_q/σ_t cut, 0.0118 ± 0.0008 % for q_{\max}/q_{tot} and 0.0004 ± 0.0002 % for Q_{dev} . Combining these 3 rejection cuts, the total detection inefficiency is 0.0124 ± 0.0008 %, that can be considered negligible for the neutrino oscillation analysis.

Since the beginning of the data taking, some noisy PMTs were turned off in order to reduce the spurious trigger contamination. A few hours of dedicated runs with these PMTs turned back on were taken later on for further LN studies. Fig. 21 shows the spatial distribution of the events for these dedicated runs before applying the LN cuts. One can clearly see structures in the buffer, the γ -catcher and the target, however it would be very difficult to identify the noisy PMTs through the position reconstruction. Fig. 22 shows the same distributions after applying the LN cuts: only a few events remain reconstructed in the buffer and a smooth distribution, without clear artifacts, is evident in the neutrino target. The success of the LN strategy allowed to turn these noisy PMTs back on in 2013.

7 The near detector

In order to reduce the trigger rate caused by the *LN*, the PMT bases of the near detector were covered with a radiopure and chemically-compatible polyester film (TORAY, Lumirror X30 [27]) which is the same type used in the KamLand experiment.

Several designs and different thicknesses of the sheet were tested, measuring the corresponding reduction in the LN trigger rate using the laboratory setup described in Sec. 4. The measurements were carried out at room temperature (29°C) with a flasher PMT high voltage set at 1900 V, higher than normal operating high voltage in order to maximize the light emission. The highest reduction (99.88 %) was found for the design consisting of a single piece of sheet folded around the PMT base, with a single cut ending in a hole to let the cable exit (Fig. 23). The base cover was attached to the PMT mechanically, using the PMT support structure, avoiding the use of glue. The cable exit had a rectangular strip of sheet wrapped around it to prevent the light escaping through it. Similar results were found for the 80 μm and 100 μm thicknesses. We chose the thinner sheet since it was easier to fold. Small holes were punctured in the covers to allow the air to escape during

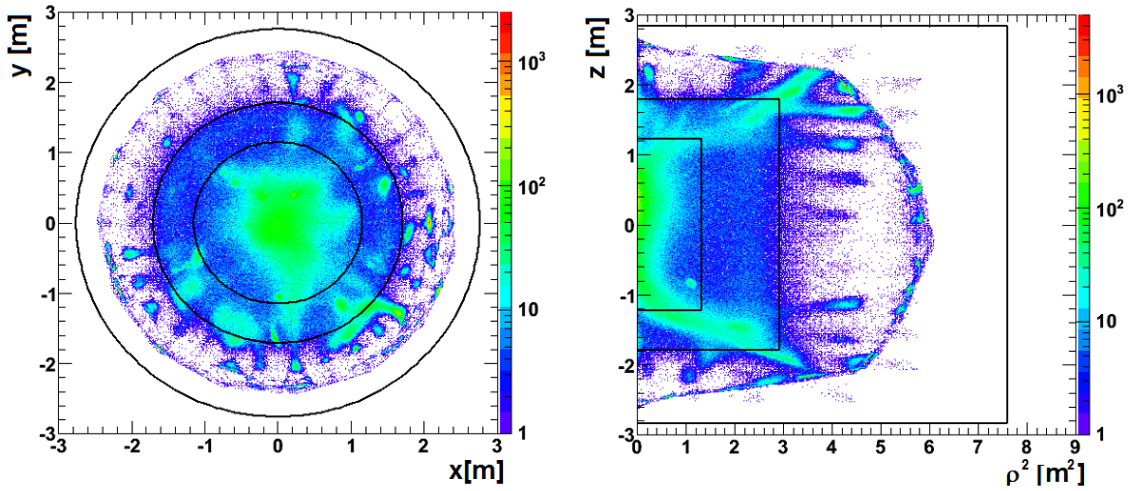

Figure 21. Distribution of the events on the xy plane (left) and on the ρ^2z plane (right) from the special runs dedicated to the LN study. LN cuts are not applied. The black lines correspond to the target, γ -catcher and buffer.

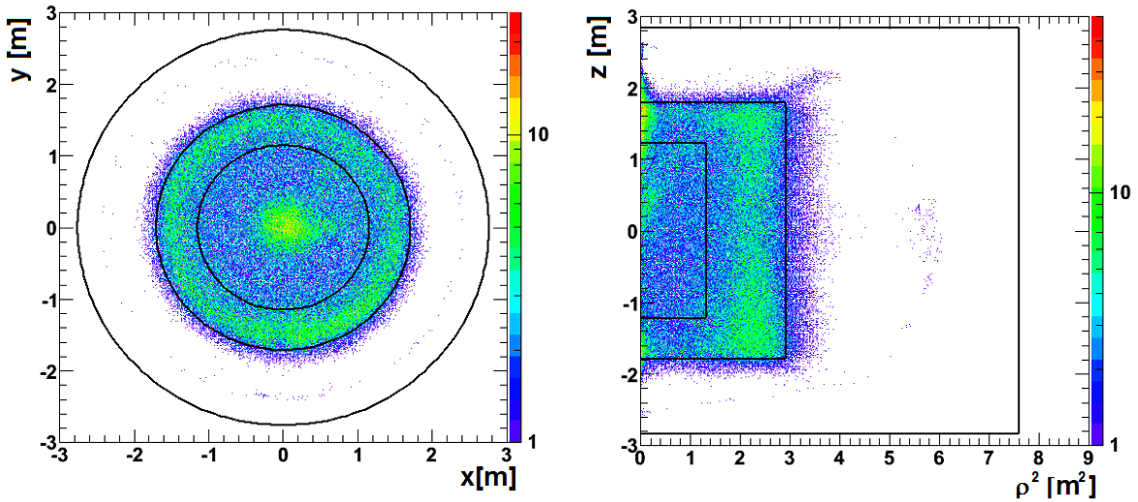

Figure 22. Distribution of the events on the xy plane (left) and on the ρ^2z plane (right) from the special runs dedicated to the LN study, after applying the cuts.

the detector filling process, thus avoiding the formation of trapped air bubbles inside the detector.

A spectroscopy study of the optical properties of the $80\mu\text{m}$ sheet was carried out independently, measuring its transmittance as a function of the wavelength. While the transmittance is practically null in the UV region, it slowly rises in the IR, being on average of the order of 0.16 % in the visible region, in agreement with the reduction measured in the laboratory setup. The bases of all the 390 PMTs for the Inner Detector were covered with the black sheet.



Figure 23. PMT base covered with black sheet as made for the near detector.

The covering of the base reduced drastically the LN in the near detector. Fig. 24 shows that only one population of events is evident in the σ_q vs σ_t spectra. Those events can be selected after applying q_{\max}/q_{tot} and Q_{dev} cuts as it has been done for the far detector, once taken into account the different PMTs gain between the two detectors. The evidence proves that the instrumental background was correctly identified and understood.

It is possible that a small fraction of the light, which propagates inside the PMT, exits through its transparent window. The pulse can be detected by the tubes in front of the flasher. However that signal should be more easily rejected by the q_{\max}/q_{tot} cut described in Sec. 6, making the impact of the LN, on both physics data and trigger rate, negligible in the near detector. Indeed, no clear evidence of the LN is present in the first near detector data, although the detector behavior will be carefully monitored during the entire data taking looking for possible hints of LN .

8 Conclusions

The emission of light inside the optical volume has been observed during the preliminary operations of the Double Chooz far detector in the form of fast ($\approx 10 - 100$ ns) flash of light or of a train ($\approx 1 - 10$ μ s) of signals similar to the glowing in gas. Even though only one PMT typically detects a large pulse, the light spreads out among the other PMTs after several reflections triggering the DAQ and contaminating the physics data sample. Tests in-situ and in an external laboratory proved that the ensemble of phenomena called Light Noise was produced by the combined effect of heat and high voltage on the epoxy resin covering the photomultiplier bases. The *Light Noise* rate rose during the data taking with the far detector, such that more than 75 % of the total triggers are currently produced by the spurious light emission. A correlation between the light emission rate and the temperature of the liquid scintillator was found, with a seasonal variation of the rate gradient.

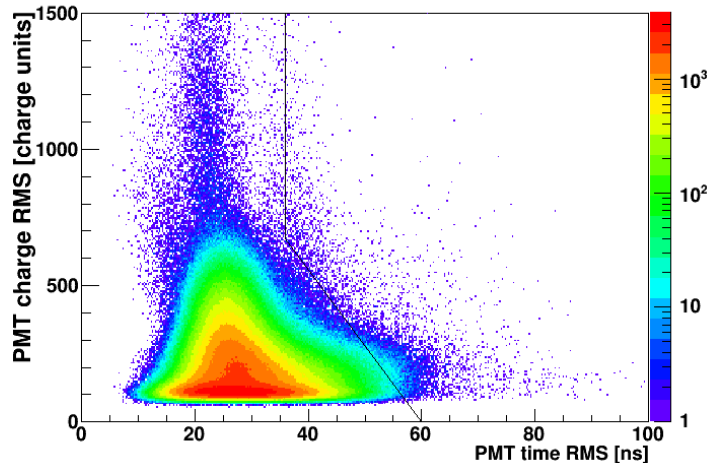

Figure 24. σ_q vs σ_t spectra of the first ND data. The black line represents a 2D cut, similar to the one used for the FD analysis (see Fig. 18), adjusted taking into account the different PMTs gain between FD and ND (see text for details).

Since the acquired data were contaminated by this instrumental background, a set of cuts was used to select the physics events in the off-line analysis. One time-based as well as three charge-based variables were designed to identify and reject the different types of *Light Noise* detected at low as well as high energy, with an estimated combined signal inefficiency of 0.0124 ± 0.0008 %, which was considered negligible for the neutrino oscillation analysis.

At the same time the bases of the near detector PMTs have been covered with a black sheet of a radiopure material in order to reduce the impact of this background on the total trigger rate. The modification has drastically reduced the contamination of the spurious events in the physics data, and is expected to improve further the efficiency of the analysis cuts. The evolution of the *Light Noise* rate and energy spectrum is constantly monitored during the data taking of the experiment with both detectors in operation.

Several other experiments reported similar instrumental effects. It is not possible to directly extrapolate our results to other detectors since no systematic study or explanation of the light emission mechanism have been published. Nonetheless, the results of the investigations can be particularly relevant for experiments that are known to use similar epoxy resins or base assembly.

Acknowledgments

We thank the French electricity company EDF; the European fund FEDER; the Région de Champagne de Champagne Ardenne; the Département des Ardennes; and the Communauté de Communes Ardenne Rives de Meuse. We acknowledge the support of the CEA, CNRS/IN2P3, the computer centre CCIN2P3, and LabEx UnivEarthS in France

(ANR-11-IDEX-0005-02); the Ministry of Education, Culture, Sports, Science and Technology of Japan (MEXT) and the Japan Society for the Promotion of Science (JSPS); the Department of Energy and the National Science Foundation of the United States; U.S. Department of Energy Award DE-NA0000979 through the Nuclear Science and Security Consortium; the Ministerio de Economía y Competitividad (MINECO) of Spain; the Max Planck Gesellschaft, and the Deutsche Forschungsgemeinschaft DFG, the Transregional Collaborative Research Center TR27, the excellence cluster “Origin and Structure of the Universe”, and the Maier-Leibnitz-Laboratorium Garching in Germany; the Russian Academy of Science, the Kurchatov Institute and RFBR (the Russian Foundation for Basic Research); the Brazilian Ministry of Science, Technology and Innovation (MCTI), the Financiadora de Estudos e Projetos (FINEP), the Conselho Nacional de Desenvolvimento Científico e Tecnológico (CNPq), the São Paulo Research Foundation (FAPESP), the Minas Gerais State Research Foundation (FAPEMIG, project CEX-APQ-01439-14), and the Brazilian Network for High Energy Physics (RENAFAE) in Brazil.

References

- [1] Y. Fukuda et al., Measurement of a small atmospheric ν_μ/ν_e ratio, Phys. Lett. B 433, Issues 1-2, (1998).
- [2] B. Aharmim et al., Determination of the ν_e and total 8B solar neutrino fluxes using the Sudbury Neutrino Observatory Phase I data set, Phys. Rev. C 75, 045502 (2007).
- [3] H. Finkel and D.M. Markoff, Analysis of High Rate Photomultiplier Tubes in KamLAND, Bull. Am. Phys. Soc. 48 No. 8, 53 (2003).
- [4] F.P. An et al., Observation of Electron-Antineutrino Disappearance at Daya Bay, Phys. Rev. Lett. 108, 171803 (2012).
- [5] J.K. Ahn et al., Observation of Reactor Electron Antineutrinos Disappearance in the RENO Experiment, Phys. Rev. Lett. 108, 191802 (2012).
- [6] J. Hosaka et al., Solar neutrino measurements in Super-Kamiokande I, Phys. Rev. D 73, 112001 (2006).
- [7] LBNE Collaboration, Long-Baseline Neutrino Experiment (LBNE) Conceptual Design Report, arXiv:1204.2295 [physics.ins-det].
- [8] Yu-Feng Li, Overview of the Jiangmen Underground Neutrino Observatory (JUNO), Int. J. Mod. Phys. Conf. Ser., 31, 1460300 (2014).
- [9] J. Cameron et al., Study of the Voltage-Dependent Phenomena in the SNO detector, SNO Technical Report 99-038.
- [10] A. Kozlov, Unusual PMT behavior in KamLAND, International Workshop on new Photon-Detectors, Kobe, Japan (2007).
- [11] H.R. Band et al., Assembly and Installation of the Daya Bay Antineutrino Detectors, JINST 8, T11006 (2013).
- [12] Y. Abe et al., Improved measurements of the neutrino mixing angle θ_{13} with the Double Chooz detector, JHEP 1410 (2014) 086. Erratum-ibid. 1502 074 (2015).

- [13] C. Aberle et al., Large scale Gd-beta-diketonate based organic liquid scintillator production for antineutrino detection, JINST 7, P06008 (2012).
- [14] Double Chooz coll., The Double Chooz experiment, paper in preparation.
- [15] Hamamatsu Photonics, <http://www.hamamatsu.com/jp/en/index.html>.
- [16] T. Matsubara et al., Evaluation of 400 low background 10-in. photo-multiplier tubes for the Double Chooz experiment, Nucl. Instrum. Methods Phys. Res., Sect. A 661, 16 (2012).
- [17] C. Bauer et al., Qualification tests of 474 photomultiplier tubes for the inner detector of the Double Chooz experiment, JINST 6, P06008 (2011).
- [18] Pelnex, Ltd., <http://www.pelnex.co.jp/en/>.
- [19] E. Calvo et al., Characterization of large area photomultipliers under low magnetic fields: Design and performances of the magnetic shielding for the Double Chooz neutrino experiment, Nucl. Instrum. Meth. A621 (2010) 222-230.
- [20] F. Sato, et al., High Voltage System for the Double Chooz Experiment, Phys. Procedia 37 (2012) 1164-1170.
- [21] <http://www.rieki.co.jp/epo-tek/pdf/05/301-2.pdf>.
- [22] <http://www.dawex.cz/userFiles/technicke-listy/huntsman/araldite-2011.pdf>.
- [23] Crosslink Technology Inc., Methods to reduce or eliminate Corona (Partial Discharge), <http://www.crosslinktech.com/support/>.
- [24] Y. Abe et al., Indication for the disappearance of reactor electron antineutrinos in the Double Chooz experiment, Phys. Rev. Lett. 108 (2012) 131801.
- [25] Y. Abe et al., First Measurement of θ_{13} from Delayed Neutron Capture on Hydrogen in the Double Chooz Experiment, Phys. Lett. B 723 (2013) 66-70.
- [26] Y. Abe et al., Reactor $\bar{\nu}_e$ disappearance in the Double Chooz experiment, Phys. Rev. D 86, 052008 (2012).
- [27] Toray Industries Inc., Lumirror X30 Datasheet, http://www.toray.jp/films/en/properties/lumirror/lum_x30.html.