

(12) INTERNATIONAL APPLICATION PUBLISHED UNDER THE PATENT COOPERATION TREATY (PCT)

(19) World Intellectual Property
Organization
International Bureau



(43) International Publication Date
15 December 2016 (15.12.2016)

WIPO | PCT

(10) International Publication Number
WO 2016/198170 A1

- (51) International Patent Classification:
C07H 15/04 (2006.01) *A61K 31/7028* (2006.01)
A61K 39/09 (2006.01) *A61P 31/04* (2006.01)
- (21) International Application Number: PCT/EP2016/051608
- (22) International Filing Date: 26 January 2016 (26.01.2016)
- (25) Filing Language: English
- (26) Publication Language: English
- (30) Priority Data:
15171079.5 8 June 2015 (08.06.2015) EP
- (71) Applicant: MAX-PLANCK-GESELLSCHAFT ZUR FÖRDERUNG DER WISSENSCHAFTEN E.V. [DE/DE]; Hofgartenstrasse 8, 80539 Munich (DE).
- (72) Inventors: ANISH, Chakkumkal; Vlaskamp 594, 2592AR Den Haag (NL). LISBOA, Marilda; Selmaplatz 4, 14163 Berlin (DE). MARTIN, Christopher; Bahnhofstrasse 38, 78532 Tuttlingen (DE). PEREIRA, Clancy Lebev; Hortensienstrasse 66, 12203 Berlin (DE). SEEBERGER, Peter H.; Rudolf-Breitscheid-Strasse 46, 14532 Klein Machnow (DE). KHAN, Naem; Str. 614 Nr. 58, 12347 Berlin (DE).
- (74) Agent: ARTH, Hans-Lothar; ABK Patent Attorneys, Jasminweg 9, 14052 Berlin (DE).
- (81) Designated States (unless otherwise indicated, for every kind of national protection available): AE, AG, AL, AM, AO, AT, AU, AZ, BA, BB, BG, BH, BN, BR, BW, BY, BZ, CA, CH, CL, CN, CO, CR, CU, CZ, DE, DK, DM, DO, DZ, EC, EE, EG, ES, FI, GB, GD, GE, GH, GM, GT, HN, HR, HU, ID, IL, IN, IR, IS, JP, KE, KG, KN, KP, KR, KZ, LA, LC, LK, LR, LS, LU, LY, MA, MD, ME, MG, MK, MN, MW, MX, MY, MZ, NA, NG, NI, NO, NZ, OM, PA, PE, PG, PH, PL, PT, QA, RO, RS, RU, RW, SA, SC, SD, SE, SG, SK, SL, SM, ST, SV, SY, TH, TJ, TM, TN, TR, TT, TZ, UA, UG, US, UZ, VC, VN, ZA, ZM, ZW.
- (84) Designated States (unless otherwise indicated, for every kind of regional protection available): ARIPO (BW, GH, GM, KE, LR, LS, MW, MZ, NA, RW, SD, SL, ST, SZ, TZ, UG, ZM, ZW), Eurasian (AM, AZ, BY, KG, KZ, RU, TJ, TM), European (AL, AT, BE, BG, CH, CY, CZ, DE, DK, EE, ES, FI, FR, GB, GR, HR, HU, IE, IS, IT, LT, LU, LV, MC, MK, MT, NL, NO, PL, PT, RO, RS, SE, SI, SK, SM, TR), OAPI (BF, BJ, CF, CG, CI, CM, GA, GN, GQ, GW, KM, ML, MR, NE, SN, TD, TG).
- Published:
— with international search report (Art. 21(3))

(54) Title: VACCINES AGAINST STREPTOCOCCUS PNEUMONIAE SEROTYPE 5

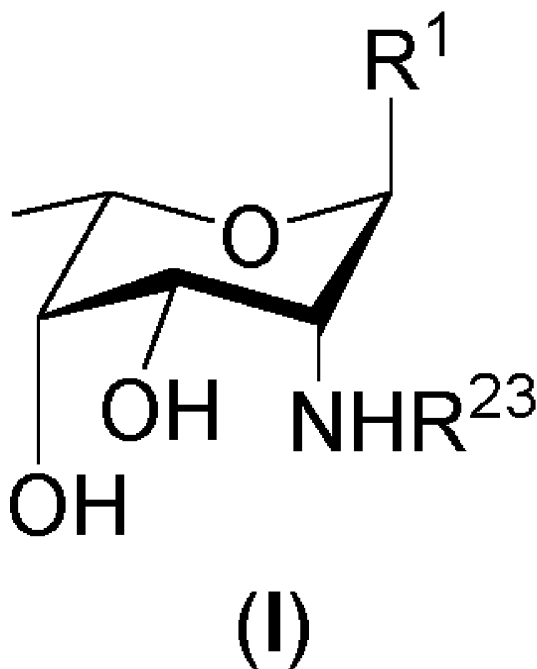

(57) Abstract: The present invention relates to well-defined synthetic saccharides of general formula (I) that are related to the repeating unit of *Streptococcus pneumoniae* serotype 5 capsular polysaccharide and conjugates thereof. The conjugates and pharmaceutical compositions containing said conjugates are useful for prevention and/or treatment of diseases associated with *Streptococcus pneumoniae*, and more specifically against diseases associated with *Streptococcus pneumoniae* serotype 5. Furthermore, the synthetic saccharides of general formula (I) are useful as marker in immunological assays for detection of antibodies against *Streptococcus pneumoniae* bacteria.

WO 2016/198170 A1

Vaccines against *Streptococcus pneumoniae* serotype 5

5

Field of the invention

The present invention relates to well-defined synthetic saccharides of general formula (I) that are related to the repeating unit of *Streptococcus pneumoniae* serotype 5 capsular polysaccharide and conjugates thereof. The conjugates and pharmaceutical compositions containing said conjugates are useful for prevention and/or treatment of diseases associated with *Streptococcus pneumoniae*, and more specifically against diseases associated with *Streptococcus pneumoniae* serotype 5. Furthermore, the synthetic saccharides of general formula (I) are useful as marker in immunological assays for detection of antibodies against *Streptococcus pneumoniae* bacteria

Background of the invention

Streptococcus pneumoniae is a Gram-positive, encapsulated bacterium that is a main cause of infections of the respiratory tract and can lead to severe invasive pneumococcal disease (IPD). More than 90 different pneumococcal serotypes have been described to date. These are classified by the structure of their capsular polysaccharide (CPS), which is unique to each serotype. Consequently, the immune response generated against the CPS varies between different serotypes. This is used to generate specific antibodies in rabbits against the antigen of each serotype. Cross-reactivity between these specific antibodies and other serotypes than those they were raised against is often observed, due to structural similarities of the CPS of different serotypes. Due to its immunological properties, CPS is used as the main component of *S. pneumoniae* vaccines.

30

The first efficient vaccine that contained the CPS of four different serotypes was described in 1945. It then took over thirty years until a vaccine was introduced that covered 14 serotypes, shortly followed by a 23-valent vaccine. However, these polysaccharide vaccines had several shortcomings. They were not able to elicit a long-lasting protection and were not effective in the populations most vulnerable to infection, namely children under two years of age as well as immunodeficient and elderly patients. These shortcomings result from the immunology of carbohydrates and were overcome by the introduction of carbohydrate-protein conjugate vaccines. The first pneumococcal conjugate vaccines were the seven-valent (PCV-7) and 10-valent (PCV-

35

10) vaccine. PCV-7 was later replaced with the most recent vaccine (PCV-13), which contains the CPS-glycoconjugates of 13 different serotypes.

5 *S. pneumoniae* serotype 5 (SP5) is globally the fifth most prevalent IPD-causing serotype among young children, and the second most prevalent serotype amongst children in the poorest countries of the world, eligible to the support of the Global Alliance for Vaccines and Immunization (GAVI). Furthermore, SP5 was recently identified as the causative agent of an epidemic of severe pneumonia among young Israeli army recruits and community outbreaks of invasive infection in impoverished, 10 urban populations in Canada. A very recent study showed that SP5 is a frequent cause of IPD outbreaks among children and adults in Spain. Although most SP5 subtypes are still susceptible to antibiotics, the emergence and dissemination of antibiotic-resistant SP5 bacteria is of concern.

15 The SP5 CPS is a component of the most recent PCV-10 and PCV-13 conjugate vaccines. The SP5 CPS consists of a branched pentasaccharide repeating unit with the sequence $[\rightarrow 4)\text{-}\beta\text{-D-Glcp}\text{-}(1\rightarrow 4)\text{-}[\alpha\text{-L-PnepNAc}\text{-}(1\rightarrow 2)\text{-}\beta\text{-D-GlcpA}\text{-}(1\rightarrow 3)]\text{-}\alpha\text{-L-FucpNAc}\text{-}(1\rightarrow 3)\text{-}\beta\text{-D-Sugp}\text{-}(1\rightarrow]$, where *Sugp* is 4-keto-D-FucNAc (systematic name: 2-acetamido-2,5-dideoxy-D-xylo-hexos-4-ulose) and *PneNAc* is *N*-acetyl-L-pneumosamine (see **Figure 1**). 20

The French patent application FR 2850106 A1 (AVENTIS PASTEUR, 23 July 2004) describes conjugates obtained by reductive amination of SP5 CPS for use as vaccines against SP5. The saccharidic part of the conjugates are fragments of SP5 CPS 25 isolated from bacterial sources containing in average 30 to 35 repeating units, wherein at least 85% of repeating units correspond to one of the following repeating units: $[\rightarrow 4)\text{-}\beta\text{-D-Glcp}\text{-}(1\rightarrow 4)\text{-}[\alpha\text{-L-PnepNAc}\text{-}(1\rightarrow 2)\text{-}\beta\text{-D-GlcpA}\text{-}(1\rightarrow 3)]\text{-}\alpha\text{-L-FucpNAc}\text{-}(1\rightarrow 3)\text{-}\beta\text{-D-Sugp}\text{-}(1\rightarrow]$; $[\rightarrow 4)\text{-}\beta\text{-D-Glcp}\text{-}(1\rightarrow 4)\text{-}[\alpha\text{-L-PnepNAc}\text{-}(1\rightarrow 2)\text{-}\beta\text{-D-GlcpA}\text{-}(1\rightarrow 3)]\text{-}\alpha\text{-L-FucpNAc}\text{-}(1\rightarrow 3)\text{-}\beta\text{-D-FucpNAc}\text{-}(1\rightarrow]$; and $[\rightarrow 4)\text{-}\beta\text{-D-Glcp}\text{-}(1\rightarrow 4)\text{-}[\alpha\text{-L-PnepNAc}\text{-}(1\rightarrow 2)\text{-}\beta\text{-D-GlcpA}\text{-}(1\rightarrow 3)]\text{-}\alpha\text{-L-FucpNAc}\text{-}(1\rightarrow 3)\text{-}\beta\text{-D-QuipNAc}\text{-}(1\rightarrow]$. The heterogeneity of the SP5 CPS fragments both in terms of size and structure is detrimental for the efficient manufacture of a well-defined vaccine. 30

35 It is the objective of the present invention to provide well-defined synthetic saccharides of general formula (I) that are related to the repeating unit of *Streptococcus pneumoniae* serotype 5 capsular polysaccharides. Said well-defined synthetic saccharides are suitable to be conjugated to an immunogenic carrier to provide conjugates and pharmaceutical compositions thereof that are useful for prevention and/or treatment of diseases associated with *Streptococcus pneumoniae*, and more

specifically against diseases associated with *Streptococcus pneumoniae* serotype 5. Furthermore, the synthetic saccharides of general formula (I) are useful as marker in immunological assays for detection of antibodies against *Streptococcus pneumoniae* bacteria.

5

The objective of the present invention is solved by the teaching of the independent claims. Further advantageous features, aspects and details of the invention are evident from the dependent claims, the description, the figures, and the examples of the present application.

10

Description of the invention

Definitions

15

The term "linker" as used herein encompasses molecular fragments capable of connecting the reducing-end monosaccharide of a saccharide with an immunogenic carrier or a solid support, optionally by binding to at least one interconnecting molecule. Thus, the function of the linker *per se* or together with the interconnecting molecule is to establish, keep and/or bridge a special distance between the reducing-end monosaccharide and an immunogenic carrier or a solid support. More specifically, one extremity of the linker is connected to the exocyclic oxygen atom at the anomeric center of the reducing-end monosaccharide and the other extremity is connected *via* the nitrogen atom with the interconnecting molecule, or directly with the immunogenic carrier or the solid support.

20
25

As used herein, the term "interconnecting molecule" refers to a bifunctional molecule containing functional group X and functional group Y, wherein functional group X is capable of reacting with the terminal amino group on the linker L and the functional group Y is capable of reacting with a functionality present on an immunogenic carrier or on a solid support. **Figure 2** displays examples of commercially available interconnecting molecules, but does not restrict the interconnecting molecules that can be used according to the present invention to the examples displayed herein.

30

35 The term "adjuvant" as used herein refers to an immunological adjuvant i.e. a material used in a vaccine composition that modifies or augments the effects of said vaccine by enhancing the immune response to a given antigen contained in the vaccine without being antigenically related to it. For the person skilled in the art, classically recognized examples of adjuvants include:

- mineral-containing compositions, including calcium salts and aluminium salts (or mixtures thereof). Calcium salts include calcium phosphate. Aluminium salts include hydroxides, phosphates, sulfates, etc., with the salts taking any suitable form (e.g. gel, crystalline, amorphous, etc.). Adsorption to these salts is preferred. The mineral containing compositions may also be formulated as a particle of metal salt. The adjuvants known as aluminium hydroxide and aluminium phosphate may be also used. The invention can use any of the "hydroxide" or "phosphate" adjuvants that are in general used as adjuvants. The adjuvants known as "aluminium hydroxide" are typically aluminium oxyhydroxide salts, which are usually at least partially crystalline. The adjuvants known as "aluminium phosphate" are typically aluminium hydroxyphosphates, often also containing a small amount of sulfate (i. e. aluminium hydroxyphosphate sulfate). They may be obtained by precipitation, and the reaction conditions and concentrations during precipitation influence the degree of substitution of phosphate for hydroxyl in the salt. Mixtures of both an aluminium hydroxide and an aluminium phosphate can be employed in the formulation according to the present invention;

- saponins, which are a heterologous group of sterol glycosides and triterpenoid glycosides that are found in the bark, leaves, stems, roots and even flowers of a wide range of plant species. Saponins from the bark of the *Quillaja saponaria*, Molina tree have been widely studied as adjuvants. Saponins can also be commercially obtained from *Smilax ornata* (sarsapilla), *Gypsophilla paniculata* (brides veil), and *Saponaria officianalis* (soap root). Saponin adjuvant formulations include purified formulations, such as QS21, as well as lipid formulations, such as ISCOMs. Saponin compositions have been purified using HPLC and RP-HPLC. Specific purified fractions using these techniques have been identified, including QS 7, QS 17, QS 18, QS2 1, QH-A, QH-B and QH-C. Saponin formulations may also comprise a sterol, such as cholesterol. Combinations of saponins and cholesterol can be used to form unique particles called immunostimulating complexes (ISCOMs). ISCOMs generally include a phospholipid such as phosphatidylethanolamine or phosphatidylcholine. Any known saponin can be used in ISCOMs. Preferably, the ISCOM includes one or more of QuilA, QHA & QHC;

- microparticles (i.e. a particle of 100 nm to 150 pm in diameter, more preferably 200 nm to 30 pm in diameter, or 500 nm to 10 pm in diameter) formed from materials that are biodegradable and non-toxic. Such non-toxic and biodegradable materials include, but are not restricted to poly(α -hydroxy acid), polyhydroxybutyric acid, polyorthoester, polyanhydride, polycaprolactone;

- CD1d ligands, such as an α -glycosylceramide, phytosphingosine-containing α -glycosylceramides, OCH, KRN7000 [(2S,3S,4R)-1-O-(α -D-galactopyranosyl)-2-(N-

hexacosanoylamino)-1,3,4-octadecanetriol], CRONY-101, 3"-sulfo-galactosyl-ceramide;

- 5 - immunostimulatory oligonucleotides, such CpG motif containing ones (a dinucleotide sequence containing an unmethylated cytosine residue linked by a phosphate bond to a guanosine residue), or Cpl motif containing ones (a dinucleotide sequence containing cytosine linked to inosine), or a double-stranded RNA, or an oligonucleotide containing a palindromic sequence, or an oligonucleotide containing a poly(dG) sequence. Immunostimulatory oligonucleotides can include nucleotide modifications/analogs such as phosphorothioate modifications and can be double-
- 10 stranded or (except for RNA) single-stranded;
- compounds containing lipids linked to a phosphate-containing acyclic backbone, such as the TLR4 antagonist E5564;
- oil emulsions (e.g. Freund's adjuvant).

15 Theoretically, each molecule or substance that is able to favor or amplify a particular situation in the cascade of immunological events, ultimately leading to a more pronounced immunological response, can be defined as an adjuvant.

In principle, through the use of adjuvants in vaccine formulations, one can

- 20 - direct and optimize immune responses that are appropriate or desirable for the vaccine;
- enable mucosal delivery of vaccines, i.e. administration that results in contact of the vaccine with a mucosal surface such as buccal or gastric or lung epithelium and the associated lymphoid tissue;
- promote cell-mediated immune responses;
- 25 - enhance the immunogenicity of weaker immunogens, such as highly purified or recombinant antigens;
- reduce the amount of antigen or the frequency of immunization required to provide protective immunity; and
- improve the efficacy of vaccines in individuals with reduced or weakened immune
- 30 responses, such as newborns, the aged, and immunocompromised vaccine recipients.

Although little is known about their mode of action, it is currently believed that adjuvants augment immune responses by one of the following mechanisms:

- increasing the biological or immunologic half-life of antigens;
- 35 - improving antigen delivery to antigen-presenting cells (APCs), as well as antigen processing and presentation by the APCs e.g., by enabling antigen to cross endosomal membranes into the cytosol after ingestion of antigen-adjuvant complexes by APC;

- mimicking danger inducing signals from stressed or damaged cells, which serve to initiate an immune response;
 - inducing the production of immunomodulatory cytokines;
 - biasing the immune response towards a specific subset of the immune system; and
- 5 - blocking the rapid dispersal of the antigen challenge.

Saccharides are known by the person skilled in the art as TI-2 (T cell independent-2) antigens and poor immunogens. Therefore, to produce a saccharide-based vaccine, said saccharides are conjugated to an immunogenic carrier to provide a conjugate, which presents an increased immunogenicity in comparison with the saccharide. In this context the term "immunogenic carrier" is defined as a structure, which is conjugated to the saccharide to form a conjugate that presents an increased immunity in comparison with the saccharide *per se*. Thus, the conjugation of the saccharides to the immunogenic carrier has as effect the stimulation of the immune response against said saccharide, without inducing an immune response against the said immunogenic carrier.

10

15

The present invention relates to saccharides of general formula (I):

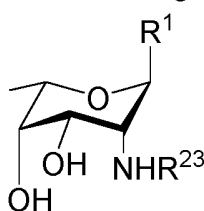

(I)

20

wherein

R¹ is selected from R², R⁴,

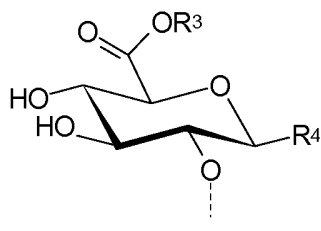
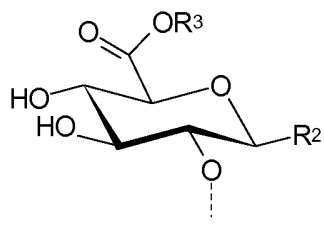

R² represents

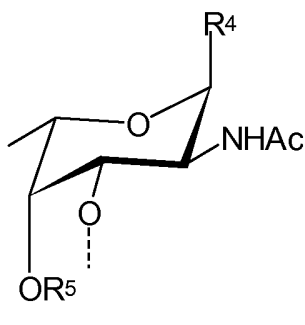

R³ is selected from -H, -CH₃, -C₂H₅, -C₃H₇, -C₄H₉ and -CF₃;

R⁴ represents R⁶ or

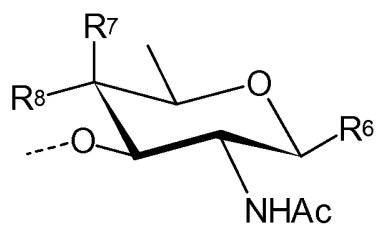

R⁵ represents -H or

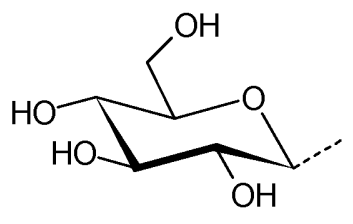

- 5 R⁶ represents -O-L-NH₂;
 R⁷ and R⁸ are independently of each other selected from -H and -OH and cannot be simultaneously -H;
 R⁷ and R⁸ can form together a =O residue; or in other words R⁷ and R⁸ can form together with the carbon atom to which they are attached to a carbonyl group C=O;
- 10 R²³ is selected from -H, -C(O)CH₃, -C(O)CF₃ and -C(O)CCl₃;
 -L- is a linker;
 and pharmaceutically acceptable salts thereof.

-L- is defined as a linker and is part of the fragment -O-L-NH₂. Thus, the linker
 15 -L- is bound to an oxygen atom and to the nitrogen atom of the NH₂-group. It is preferred that at least two carbon atoms of the linker are between the oxygen atom and the NH₂-group, like -O-C-C-NH₂. The linker -L- can be an aliphatic chain, wherein the aliphatic chain can optionally include an aromatic chain inserted in it, or a number of heteroatoms oscillating from 0 to 10.

20

The linker L preferably contains between 2 and 40 carbon atoms (including the carbon atoms of optional side chains), more preferably between 2 and 30, more preferably between 2 and 20, more preferably between 2 and 14, more preferably between 2 and 12, and still more preferably between 2 and 10 carbon atoms.

25

The shortest atom chain between the oxygen (i.e. the oxygen of -O-L-NH₂) and the NH₂-group consists preferably of 2 to 14 atoms, more preferably of 2 to 12 atoms, more preferably of 2 to 10 atoms, more preferably of 2 to 8 atoms. In case the shortest chain (which is the shortest possible connection between the oxygen at the
 30 anomeric center and the NH₂-group) consists of 2 to 6 atoms, these are preferably

carbon atoms. In case the shortest chain consists of 4 to 8 atoms, the chain may contain 1, or 2 heteroatoms selected from O, N and S. In case the shortest chain consists of 9 to 14 atoms, the chain may contain 1, 2, 3, or 4 heteroatoms selected from O, N and S. It is preferred that the shortest chain contains 0, 1, or 2 sulphur atoms and/or 0, 1, or 2 nitrogen atoms and/or 0, 1, 2, or 3 oxygen atoms.

It is also preferred that the linker $-L-$, or the shortest chain is fully or partially fluorinated. The linker $-L-$ may contain a 3-membered or a 4-membered or a 5-membered or a 6-membered saturated carbocycle or a 5-membered partly unsaturated (and not aromatic) carbocycle or a 4-membered or a 5-membered or a 6-membered saturated oxygen heterocycle or a 4-membered or a 5-membered or a 6-membered saturated nitrogen heterocycle or a 6-membered aromatic carbocycle.

The linker $-L-$ may also contain amide ($-\text{NH}-\text{CO}-$, $-\text{CO}-\text{NH}-$) and/or urea ($-\text{NH}-\text{CO}-\text{NH}-$) residues and preferably only one amide or urea residue. The linker may also contain substituents and preferably one substituent such as R^{10} or two substituents such as R^{10} and R^{14} , which have the meanings as defined herein and which are preferably selected from: $-\text{F}$, $-\text{Cl}$, $-\text{CH}_3$, $-\text{C}_2\text{H}_5$, $-\text{C}_3\text{H}_7$, $-\text{C}_5\text{H}_9$, $-\text{C}_6\text{H}_{13}$, $-\text{OCH}_3$, $-\text{OC}_2\text{H}_5$, $-\text{CH}_2\text{F}$, $-\text{CHF}_2$, $-\text{CF}_3$, $-\text{C}(\text{O})-\text{NH}_2$, $-\text{SCH}_3$, $-\text{SC}_2\text{H}_5$, $-\text{NHC}(\text{O})\text{CH}_3$, $-\text{N}(\text{CH}_3)_2$, and $-\text{N}(\text{C}_2\text{H}_5)_2$;

In case the linker is fluorinated, more than two substituents $-\text{F}$ are preferred.

Preferably the linker $-L-$ is selected from: $-\text{CH}_2-$, $-(\text{CH}_2)_2-$, $-(\text{CH}_2)_3-$, $-(\text{CH}_2)_4-$, $-(\text{CH}_2)_5-$, $-(\text{CH}_2)_6-$, $-(\text{CH}_2)_7-$, $-(\text{CH}_2)_8-$, $-(\text{CH}_2)_9-$, $-(\text{CH}_2)_{10}-$, $-\text{CF}_2-$, $-(\text{CF}_2)_2-$, $-(\text{CF}_2)_3-$, $-(\text{CF}_2)_4-$, $-(\text{CF}_2)_5-$, $-(\text{CF}_2)_6-$, $-(\text{CF}_2)_7-$, $-(\text{CF}_2)_8-$, $-(\text{CF}_2)_9-$, $-(\text{CF}_2)_{10}-$, $-(\text{CH}_2)_2-\text{O}-(\text{CH}_2)_2-$, $-\text{CH}_2-\text{O}-(\text{CH}_2)_3-$, $-(\text{CH}_2)_3-\text{O}-\text{CH}_2-$, $-\text{CH}_2-\text{O}-(\text{CH}_2)_2-$, $-(\text{CH}_2)_2-\text{O}-\text{CH}_2-$, $-(\text{CH}_2)_3-\text{O}-(\text{CH}_2)_2-$, $-(\text{CH}_2)_2-\text{O}-(\text{CH}_2)_3-$, $-(\text{CH}_2)_4-\text{O}-\text{CH}_2-$, $-\text{CH}_2-\text{O}-(\text{CH}_2)_4-$, $-\text{L}^a-$, $-\text{L}^a-\text{L}^e-$, $-\text{L}^a-\text{L}^b-\text{L}^e-$, $-\text{L}^a-\text{L}^b-\text{L}^d-\text{L}^c-\text{L}^e-$, $-\text{L}^a-\text{L}^d-\text{L}^e-$;

wherein

$-\text{L}^a-$ is selected from: $-(\text{CH}_2)_m-$, $-(\text{CF}_2)_m-$, $-(\text{CH}_2-\text{CH}_2-\text{O})_m-\text{C}_2\text{H}_4-$, $-(\text{CH}_2-\text{CH}_2-\text{O})_m-\text{CH}_2-$, $-(\text{CR}^{10}\text{R}^{11})_m-$,

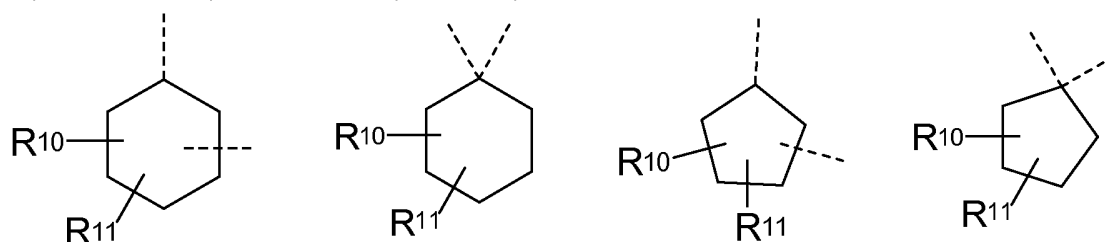

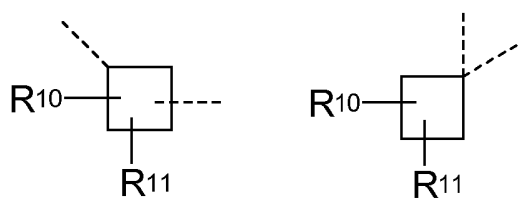

$-L^b-$ and $-L^c-$ are independently of each other selected from: $-O-$, $-S-$, $-NH-C(O)-NH-$, $-NH-C(S)-NH-$, $-NH-C(O)-$, $-C(O)-NH-$, $-NH-C(O)-O-$, $-NR^9-$, $-NR^{18}-$, $-SO_2-$,

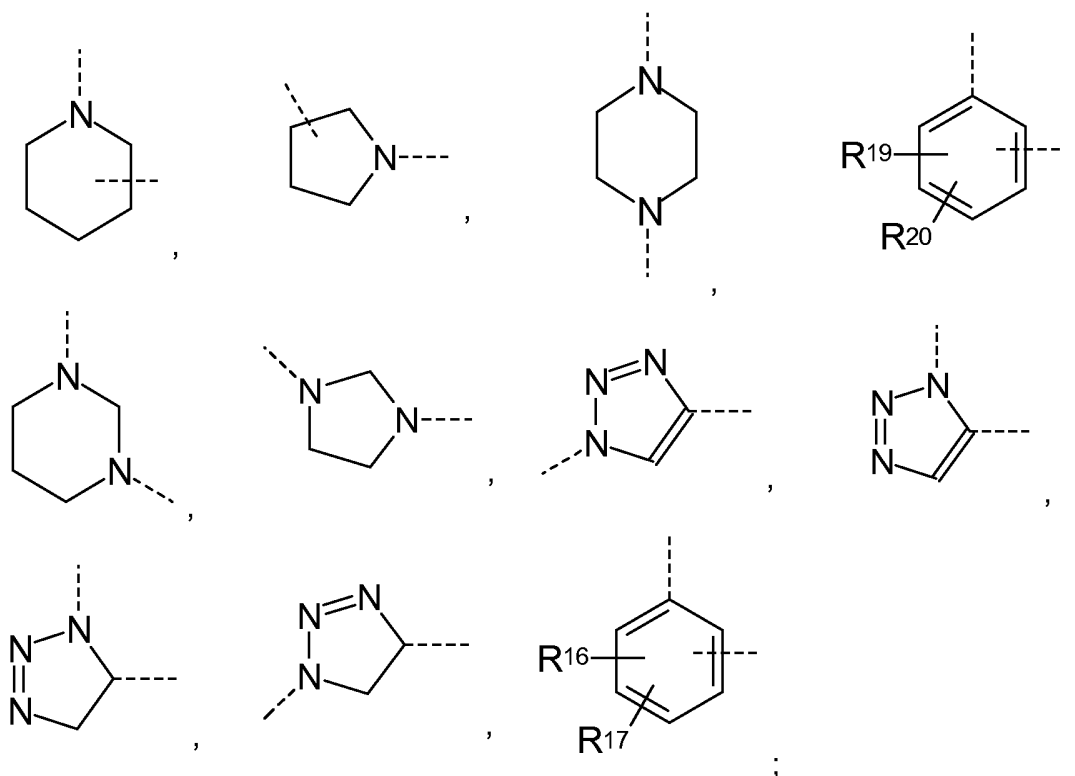

5

$-L^d-$ represents $-(CH_2)_n-$, $-(CF_2)_n-$, $-(CR^{12}R^{13})_n-$, $-(CH_2-CH_2-O)_n-C_2H_4-$, $-(CH_2-CH_2-O)_n-CH_2-$,

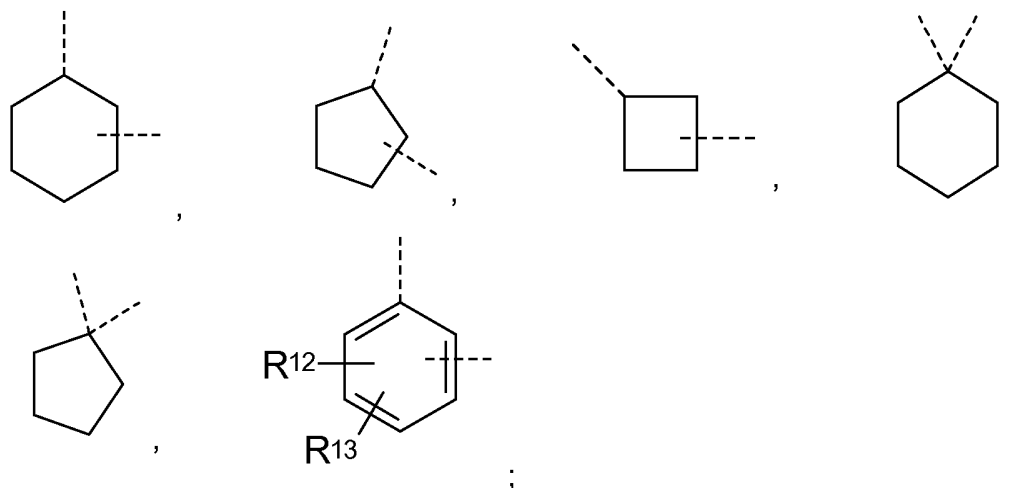

$-L^e-$ is selected from: $-(CH_2)_{p1}-$, $-(CF_2)_{p1}-$, $-C_2H_4-(O-CH_2-CH_2)_{p1}-$,
 $-CH_2-(O-CH_2-CH_2)_{p1}-$, $-(CH_2)_{p1}-O-(CH_2)_{p2}-$, $-(CH_2)_{p1}-S-(CH_2)_{p2}-$,
 $-(CR^{14}R^{15})_{p1}-$, $-(CR^{14}R^{15})_{p1}-O-(CR^{21}R^{22})_{p2}-$, $-(CR^{14}R^{15})_{p1}-S-(CR^{21}R^{22})_{p2}-$,

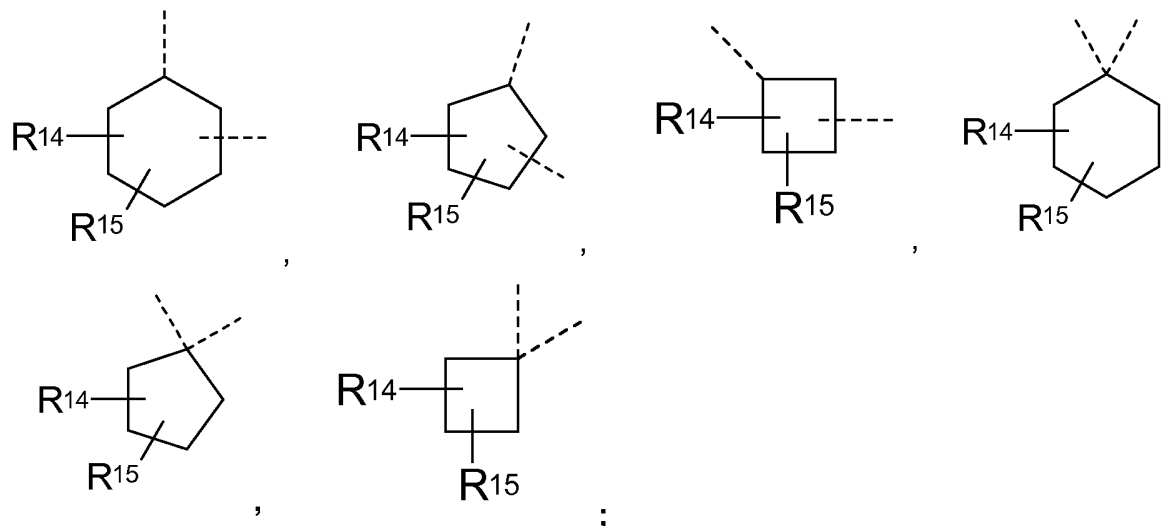

5 R^9 and R^{18} are independently of each other selected from: $-CH_3$, $-C_2H_5$,
 $-C_3H_7$, and $-C(O)CH_3$;

R^{10} , R^{11} , R^{12} , R^{13} , R^{14} , R^{15} , R^{16} , R^{17} , R^{19} , R^{20} , R^{21} and R^{22} are independently of each
 other selected from: $-H$, $-F$, $-Cl$, $-CH_3$, $-C_2H_5$, $-C_3H_7$, $-C_5H_9$, $-C_6H_{13}$,
 10 $-OCH_3$, $-OC_2H_5$, $-CH_2F$, $-CHF_2$, $-CF_3$, $-C(O)-NH_2$, $-SCH_3$, $-SC_2H_5$,
 $-NHC(O)CH_3$, $-N(CH_3)_2$ and $-N(C_2H_5)_2$;

m , n , p_1 and p_2 are independently of each other an integer selected from 1, 2, 3, 4,
 5, 6, 7, 8, 9, and 10.

15

The saccharides of the present invention bear basic and/or acidic substituents and they may form salts with organic or inorganic acids or bases.

Examples of suitable acids for such acid addition salt formation are hydrochloric acid,
 20 hydrobromic acid, sulfuric acid, phosphoric acid, acetic acid, citric acid, oxalic acid,
 malonic acid, salicylic acid, *p*-aminosalicylic acid, malic acid, fumaric acid, succinic
 acid, ascorbic acid, maleic acid, sulfonic acid, phosphonic acid, perchloric acid, nitric
 acid, formic acid, propionic acid, gluconic acid, lactic acid, tartaric acid,
 hydroxymaleic acid, pyruvic acid, phenylacetic acid, benzoic acid, *p*-aminobenzoic
 25 acid, *p*-hydroxybenzoic acid, methanesulfonic acid, ethanesulfonic acid, nitrous acid,
 hydroxyethanesulfonic acid, ethylenesulfonic acid, *p*-toluenesulfonic acid,
 naphthylsulfonic acid, sulfanilic acid, camphorsulfonic acid, china acid, mandelic acid,
o-methylmandelic acid, hydrogen-benzenesulfonic acid, picric acid, adipic acid, *d*-*o*-
 tolyltartaric acid, tartronic acid, (*o*, *m*, *p*)-toluic acid, naphthylamine sulfonic acid, and

other mineral or carboxylic acids well known to those skilled in the art. The salts are prepared by contacting the free base form with a sufficient amount of the desired acid to produce a salt in the conventional manner.

- 5 Examples of suitable inorganic or organic bases are, for example, NaOH, KOH, NH₄OH, tetraalkylammonium hydroxide, lysine or arginine and the like. Salts may be prepared in a conventional manner using methods well known in the art, for example by treatment of a solution of the compound of the general formula (I) with a solution of a base, selected out of the group mentioned above.

10

Further, it is also possible that the compounds of the present invention bear simultaneously basic and acid groups. Further, it may also occur that these basic and acid groups appear to be in close vicinity to one another enabling an intramolecular proton transfer from the acidic group to the basic group. Therefore, in a preferred embodiment of the present invention the compound of the formula (I) may be zwitterionic, bearing at least e.g. one $-O^-$ and one $-NH_3^+$ group.

15

It is clear for the skilled person in the art of carbohydrate chemistry that the saccharides of general (I) are not containing $-O-O-$ bonds and or sugar fragments connected or bound to each other *via* their anomeric or C-1 carbons.

20

Preferred are saccharides of general formulae (IV), (V), (VI) and (VII)

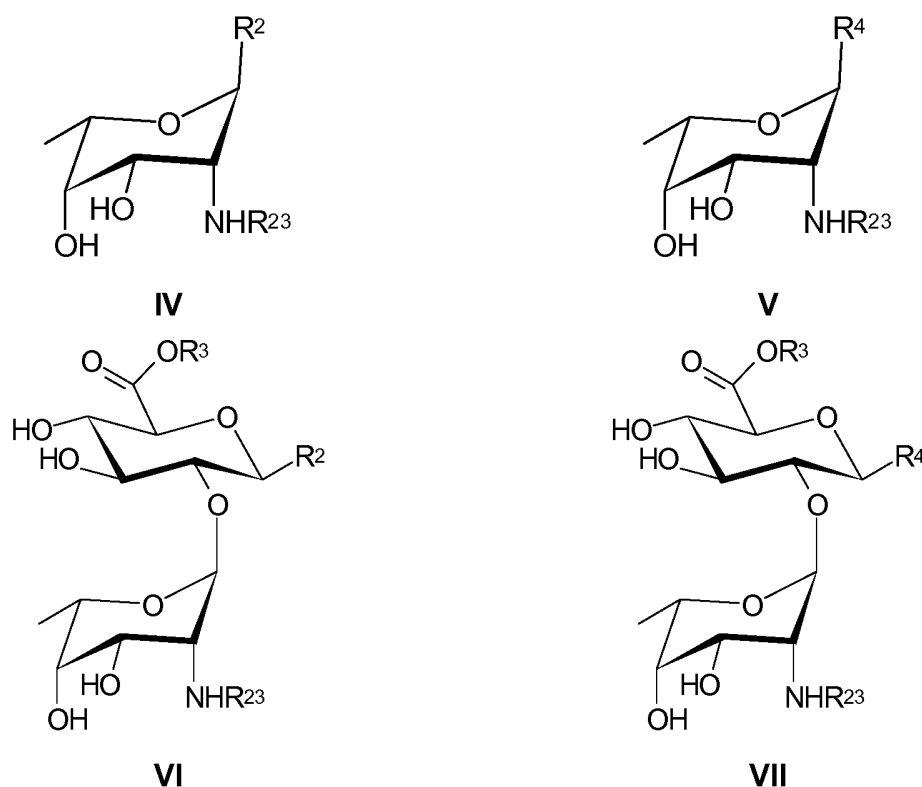

wherein R^2 , R^3 , R^4 and R^{23} have the meanings defined above, and even more preferred are saccharides of general formulae (VI) and (VII).

Another preferred embodiment of the present invention is directed to saccharides of general formula (I), wherein R^1 represents:

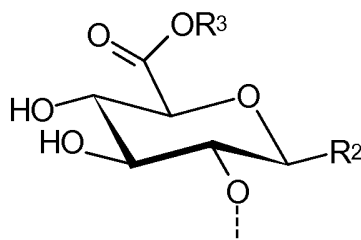

Especially preferred saccharides according to the present invention are saccharides wherein the residue R^4 represents R^6 . Thus, saccharides of general formulae (I), (IV), (V), (VI) and (VII), with R^4 being R^6 are especially preferred.

A even more preferred embodiment of the present invention is directed to a saccharide of general formula (III)

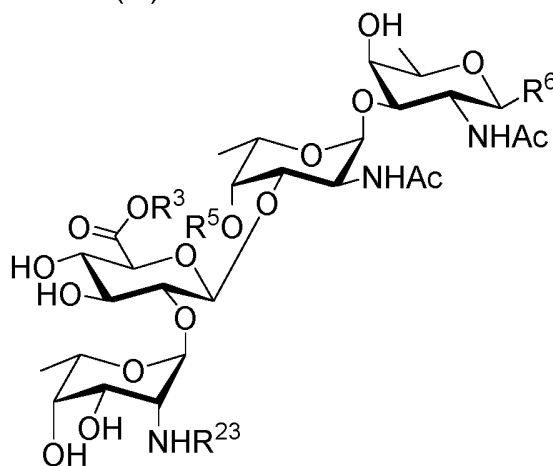

15

(III)

wherein residues R^3 , R^5 , R^6 and R^{23} are having the meanings as defined herein.

Particularly preferred are saccharides according to the present invention wherein R^3 represents $-H$. Hence, saccharides of general formulae (I), (III), (VI) and (VII), with R^3 being $-H$ are particularly preferred.

20

Preferably, the residue R^{23} represents $-C(O)CH_3$. Thus, saccharides of general formula (I) with the residue R^3 representing $-H$ and the residue R^{23} representing $-C(O)CH_3$ are especially preferred.

25

Preferred saccharides according to the present invention are saccharides of general formulae (I), (III), (IV), (V) or (VII) wherein the linker $-L-$ is selected from: $-L^a-$, $-L^a-L^e-$, $-L^a-L^b-L^e-$, $-L^a-L^b-L^d-L^c-L^e-$, $-L^a-L^d-L^e-$, and wherein

5

$-L^a-$ is selected from: $-(CH_2)_m-$, $-(CF_2)_m-$, $-(CH_2-CH_2-O)_m-C_2H_4-$, $-(CH_2-CH_2-O)_m-CH_2-$, $-(CR^{10}R^{11})_m-$;

10

$-L^b-$ and $-L^c-$ are independently of each other selected from: $-O-$, $-S-$, $-NR^9-$, $-NH-C(O)-NH-$, $-NH-C(O)-$, $-C(O)-NH-$, $-NH-C(O)-O-$, $-NR^{18}-$, $-SO_2-$,

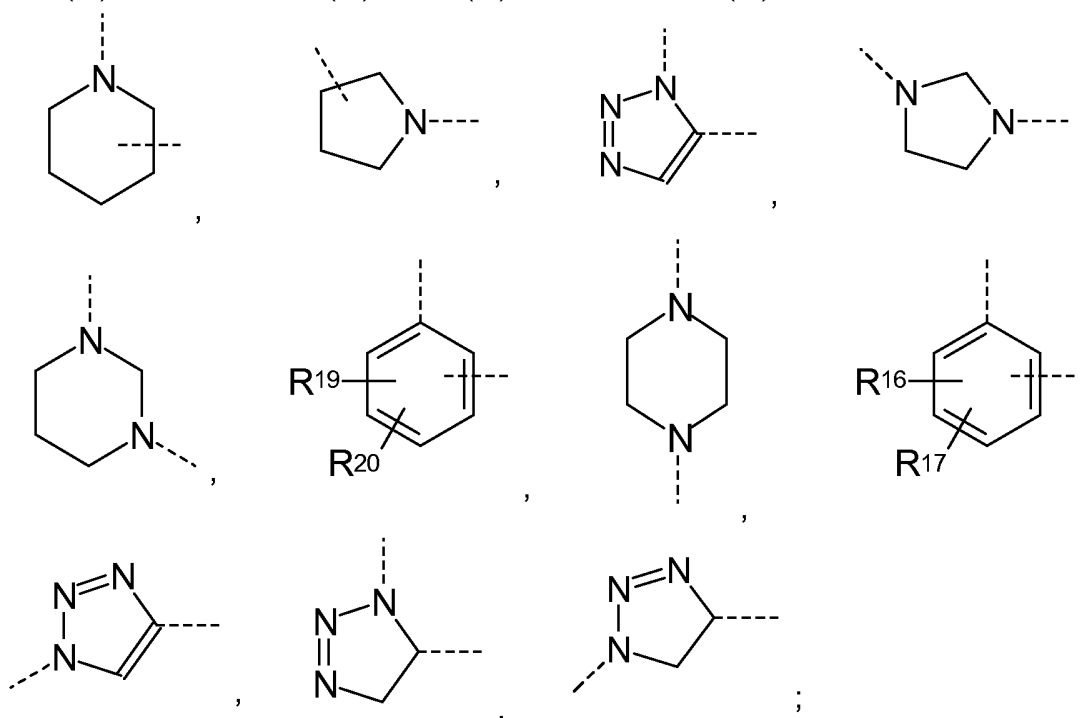

$-L^d-$ represents $-(CH_2)_n-$, $-(CF_2)_n-$, $-(CR^{12}R^{13})_n-$, $-(CH_2-CH_2-O)_n-C_2H_4-$, $-(CH_2-CH_2-O)_n-CH_2-$,

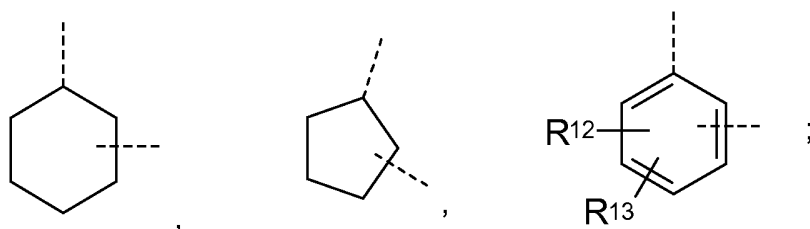

15

$-L^e-$ is selected from: $-(CH_2)_{p1}-$, $-(CF_2)_{p1}-$, $-C_2H_4-(O-CH_2-CH_2)_{p1}-$, $-CH_2-(O-CH_2-CH_2)_{p1}-$, $-(CH_2)_{p1}-O-(CH_2)_{p2}-$, $-(CH_2)_{p1}-S-(CH_2)_{p2}-$, $-(CR^{14}R^{15})_{p1}-$, $-(CR^{14}R^{15})_{p1}-O-(CR^{21}R^{22})_{p2}-$, $-(CR^{14}R^{15})_{p1}-S-(CR^{21}R^{22})_{p2}-$,

R^9 and R^{18} are independently of each other selected from: $-\text{CH}_3$, $-\text{C}_2\text{H}_5$, $-\text{C}_3\text{H}_7$, and $-\text{C}(\text{O})\text{CH}_3$;

R^{10} , R^{11} , R^{12} , R^{13} , R^{14} , R^{15} , R^{16} , R^{17} , R^{19} , R^{20} , R^{21} and R^{22} are independently of each other selected from: $-\text{H}$, $-\text{F}$, $-\text{Cl}$, $-\text{CH}_3$, $-\text{C}_2\text{H}_5$, $-\text{C}_3\text{H}_7$, $-\text{C}_5\text{H}_9$, $-\text{C}_6\text{H}_{13}$, $-\text{OCH}_3$, $-\text{OC}_2\text{H}_5$, $-\text{CH}_2\text{F}$, $-\text{CHF}_2$, $-\text{CF}_3$, $-\text{C}(\text{O})-\text{NH}_2$, $-\text{SCH}_3$, $-\text{SC}_2\text{H}_5$, $-\text{NHC}(\text{O})\text{CH}_3$, $-\text{N}(\text{CH}_3)_2$, and $-\text{N}(\text{C}_2\text{H}_5)_2$;

m , n , p_1 and p_2 are independently of each other an integer selected from 1, 2, 3, 4, 5, and 6.

In a even more preferred embodiment, the linker $-\text{L}-$ is selected from: $-\text{L}^a-$, $-\text{L}^a-\text{L}^b-\text{L}^e-$ and $-\text{L}^a-\text{L}^d-\text{L}^e-$;

and

$-\text{L}^a-$ is selected from: $-(\text{CH}_2)_m-$, $-(\text{CF}_2)_m-$, $-(\text{CH}_2-\text{CH}_2-\text{O})_m-\text{C}_2\text{H}_4-$, $-(\text{CH}_2-\text{CH}_2-\text{O})_m-\text{CH}_2-$;

$-\text{L}^b-$ is selected from: $-\text{O}-$, $-\text{S}-$, $-\text{NH}-\text{C}(\text{O})-\text{NH}-$, $-\text{NH}-\text{C}(\text{O})-$, and $-\text{C}(\text{O})-\text{NH}-$;

$-\text{L}^d-$ is selected from $-(\text{CH}_2)_n-$ and $-(\text{CF}_2)_n-$;

$-\text{L}^e-$ is selected from: $-(\text{CH}_2)_{p_1}-$, $-(\text{CF}_2)_{p_1}-$, $-\text{C}_2\text{H}_4-(\text{O}-\text{CH}_2-\text{CH}_2)_{p_1}-$, $-\text{CH}_2-(\text{O}-\text{CH}_2-\text{CH}_2)_{p_1}-$, $-(\text{CH}_2)_{p_1}-\text{O}-(\text{CH}_2)_{p_2}-$, and $-(\text{CH}_2)_{p_1}-\text{S}-(\text{CH}_2)_{p_2}-$, and

m , n , p_1 and p_2 are independently of each other an integer selected from 1, 2, 3, 4, 5, 6, 7, 8, 9, and 10. Thus, a saccharide of general formulae (I), (III), (IV), (V) or (VII) wherein the linker $-\text{L}-$ has the meaning defined above is especially preferred.

In the most preferred embodiment, the linker $-\text{L}-$ represents $-(\text{CH}_2)_m-$, wherein m has the meaning defined herein and most preferably m is an integer selected from 1, 2, 3, 4, 5 and 6, or the linker $-\text{L}-$ represents $-(\text{CH}_2-\text{CH}_2-\text{O})_m-\text{C}_2\text{H}_4-$ or $-(\text{CH}_2-\text{CH}_2-\text{O})_m-\text{CH}_2-$ and m is an integer selected from 1, 2 and 3.

Preferably the saccharides according to the present invention are selected from:

5-amino-pentanyl 2-*N*-acetyl- α -L-pneumosaminopyranosyl-(1 \rightarrow 2)- β -D-glucopyranosyluronate (**27***)

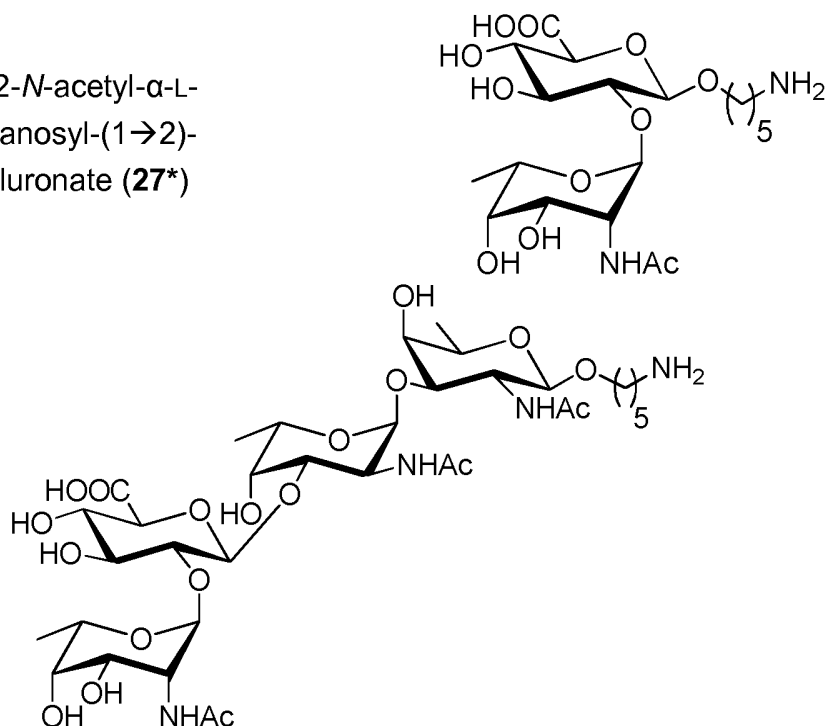

5-amino-pentanyl 2-*N*-acetyl- α -L-pneumosaminopyranosyl-(1 \rightarrow 2)- β -D-glucopyranosyluronate-(1 \rightarrow 3)-2-*N*-acetyl- α -L-fucosaminopyranosyl-(1 \rightarrow 3)-2-*N*-acetyl- β -D-fucosaminopyranoside (**33***)

5-amino-pentanyl 2-*N*-acetyl- α -L-pneumosaminopyranoside

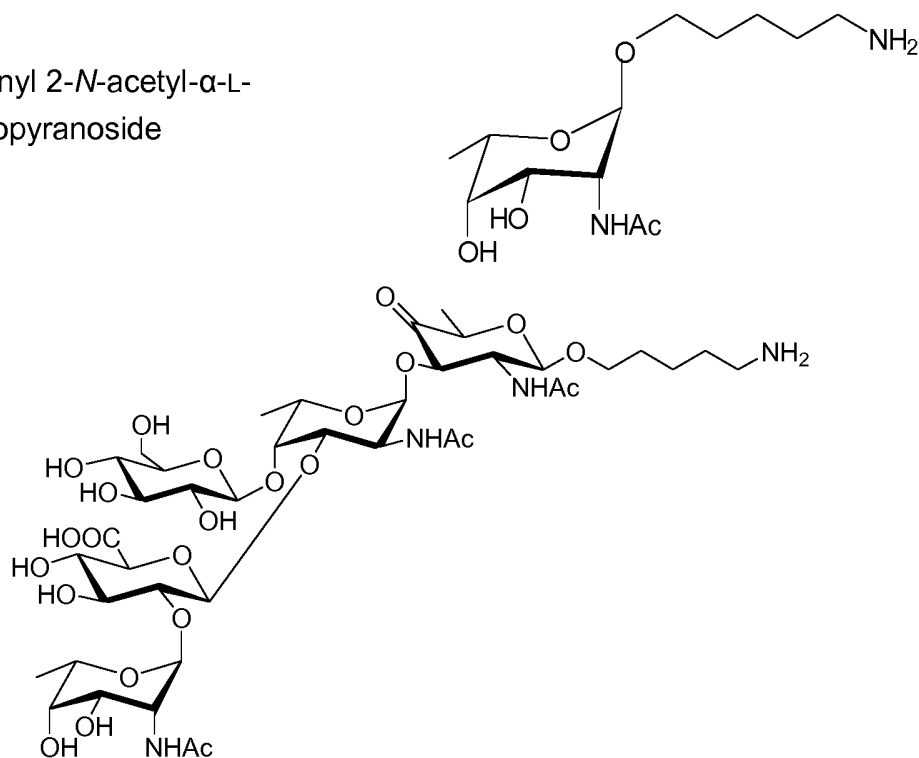

5-amino-pentanyl 2-*N*-acetyl- α -L-pneumosaminopyranosyl-(1 \rightarrow 2)- β -D-glucopyranosyluronate-(1 \rightarrow 3)-2-*N*-acetyl- α -L-fucosaminopyranosyl-(1 \rightarrow 3)-[β -D-glucopyranosyl-(1 \rightarrow 4)]-2-acetamido-2,5-dideoxy- β -D-xylo-hexos-4-uloside (**88***)

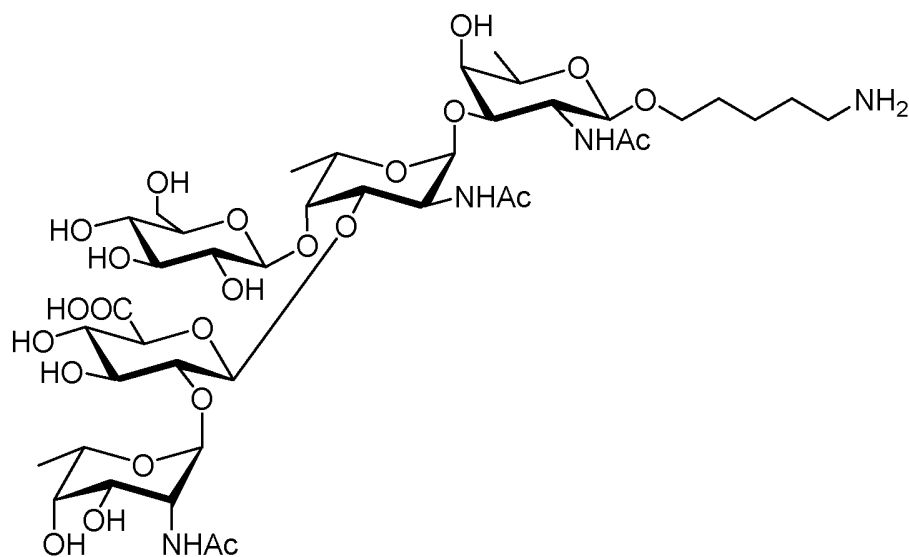

5-amino-pentanyl 2-*N*-acetyl- α -L-pneumosaminopyranosyl-(1 \rightarrow 2)- β -D-glucopyranosyluronate-(1 \rightarrow 3)-2-*N*-acetyl- α -L-fucosaminopyranosyl-(1 \rightarrow 3)-[β -D-glucopyranosyl-(1 \rightarrow 4)]-2-*N*-acetyl- β -D-fucosaminopyranoside (**73***)

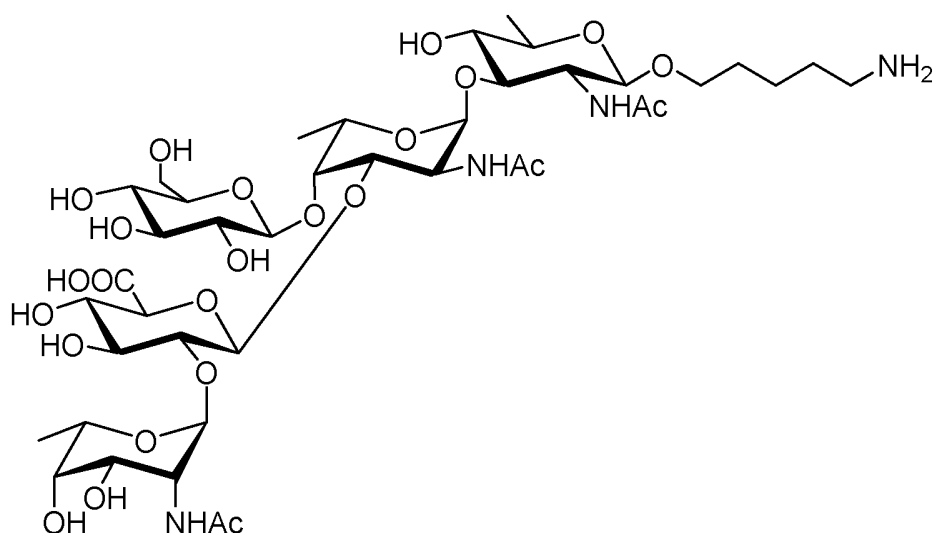

5-amino-pentanyl 2-*N*-acetyl- α -L-pneumosaminopyranosyl-(1 \rightarrow 2)- β -D-glucopyranosyluronate-(1 \rightarrow 3)-2-*N*-acetyl- α -L-fucosaminopyranosyl-(1 \rightarrow 3)-[β -D-glucopyranosyl-(1 \rightarrow 4)]-2-*N*-acetyl- β -D-quinovosaminopyranoside (**85***)

- The saccharides of general formula (I) are able to induce a protective immune response against *S. pneumoniae* serotype 5 bacteria in a human and/or animal host. The presence of the α -L-pneumosamine residue in the saccharides of general formula (I) is essential for achieving cross-reactivity towards the native *S. pneumoniae* type 5 capsular polysaccharides.

Another aspect of the present invention refers to intermediates of general formula (IX)

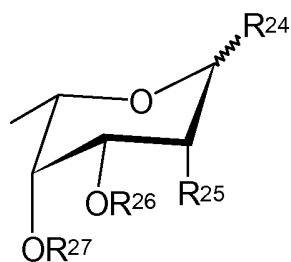

IX

wherein

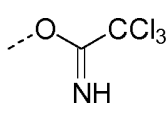
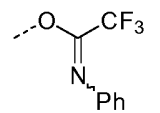
R²⁴ is selected from , , -F, -Cl, -Br, -I, -SR²⁸, -SeR²⁹, -OPO₃R³⁰₂;

5

R²⁵ is selected from -N₃, -NBn₂, -NBnCbz;

R²⁶ and R²⁷ are independently of each other selected from -H, -Bn,

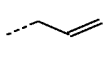
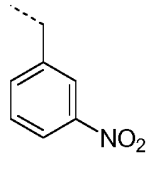
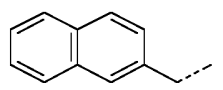
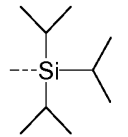
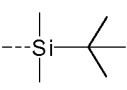
, , , , , -Si(CH₃)₃, -Si(CH₂CH₃)₃, -C(O)CH₃, -C(O)Ph,

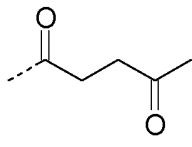
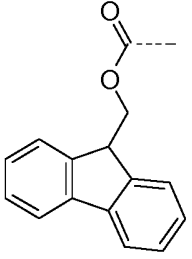
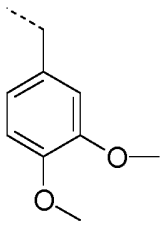
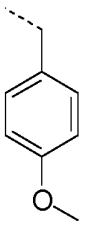
, , , ,

10

or R²⁶ and R²⁷ can form together



R²⁸ is selected from: -CH₃, -CH₂CH₃, -Ph,

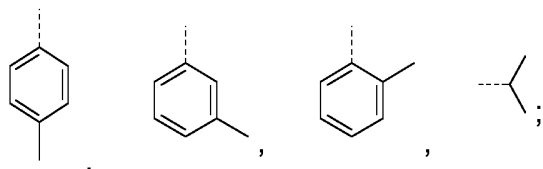

R²⁹ represents -Ph;

R³⁰ represents -CH₂CH₂CH₂CH₃; and

15 intermediates of the formulae **36**, **41**, **63**, **68***, **70** and **70a**

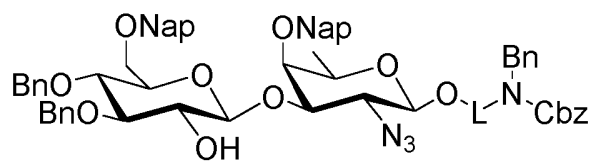

36

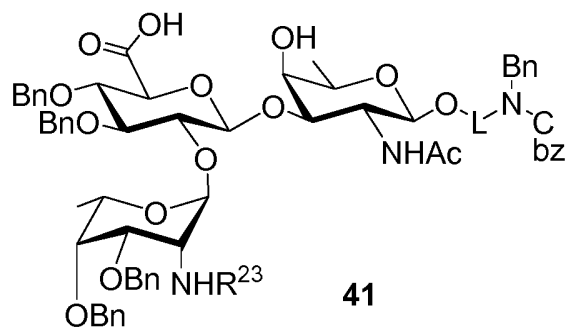

41

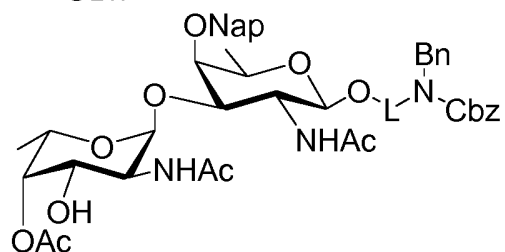

63

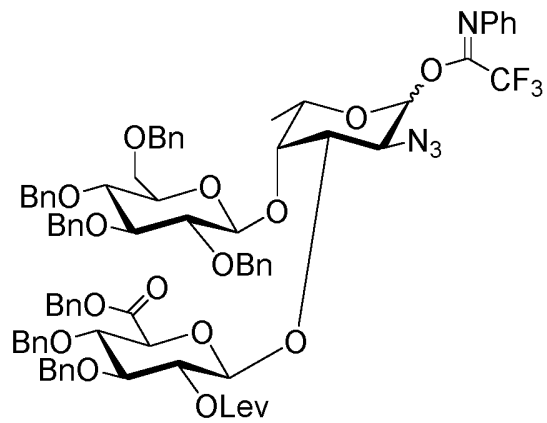

68*

5

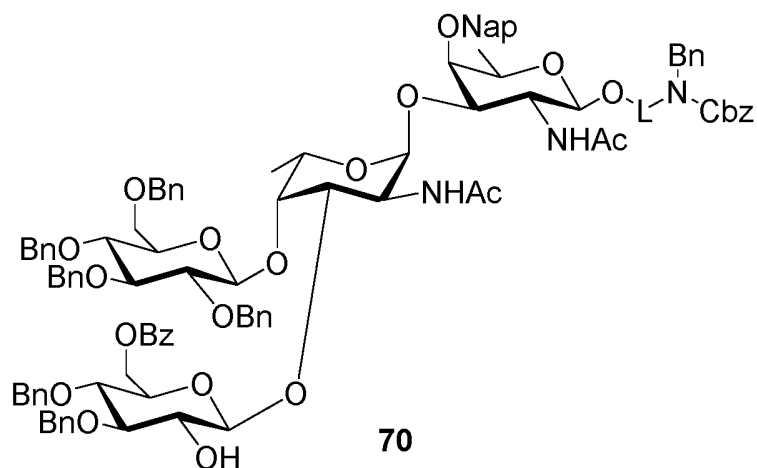

70

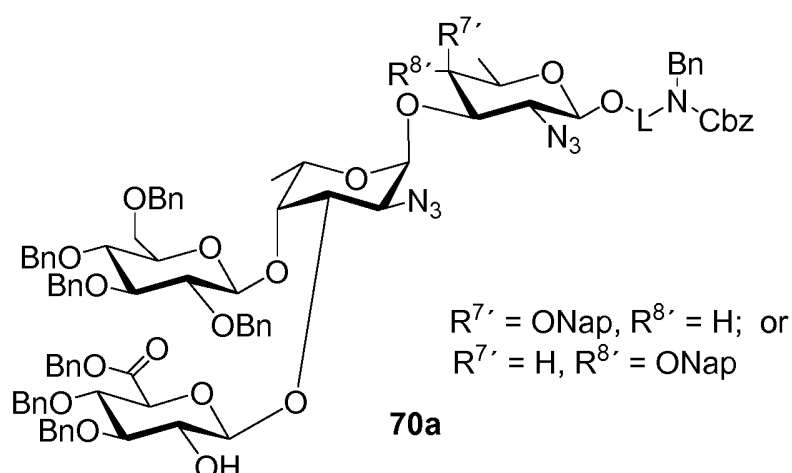

wherein L and R^{23} , and $R^{7'}$ and $R^{8'}$ are defined as disclosed herein, preferred L is $-\text{C}_5\text{H}_{10}-$ and/or R^{23} is $\text{CH}_3\text{CO}-$.

5

Glycoconjugates

Another aspect of the present invention refers to a conjugate comprising a saccharide according to the present invention. Said conjugate proved to be efficient as a vaccine for immunization against diseases associated with *Streptococcus pneumoniae* serotype 5 bacteria.

10

Saccharides are known by the person skilled in the art as generally TI-2 (T cell independent-2) antigens and poor immunogens. TI-2 antigens are antigens, which are recognized only by mature B cells through the cross linking of surface exposed immunoglobulin receptors. Without T cell help, no immunological memory is generated and neither isotype switching from IgM to other IgG subclasses, nor B cells affinity maturation occurs. Moreover, saccharides are known poor immunogens in humans due to the structural homology to human glycolipids and glycoproteins. Due to their poor immunogenic properties, saccharides manifest poor ability to produce both antibody production by B cells, as well as the formation of memory cells, features which are essential for the production of potent vaccines.

15

20

25

Therefore, to produce a potent saccharide-based vaccine, the saccharides of general formulae (I), (III), (IV), (V), (VI) and (VII) are conjugated to an immunogenic carrier to provide conjugates, which present increased immunogenicity in comparison with the saccharide. Surprisingly, it was found that immunization with a conjugate comprising a saccharide of general formula (I) covalently linked to an immunogenic carrier results in the production of high titers of antibodies specific to the carbohydrate part of the saccharide of general formula (I). Said antibodies are cross-reacting with the

natural SP-5 CPS and present opsonophagocytosis and bactericidal activity, thus conferring protection against *S. pneumoniae* serotype 5 bacteria.

5 In this context the term “immunogenic carrier” is defined as a structure, which is conjugated to the saccharide to form a conjugate that presents an increased immunity in comparison with the saccharide *per se*. Thus, the conjugation of the saccharides of general formulae (I), (III), (IV), (V), (VI) and (VII) to the immunogenic carrier has as effect the stimulation of the immune response against the saccharide of general formulae (I), (III), (IV), (V), (VI) and (VII) without inducing an immune
10 response against the said immunogenic carrier.

Preferred immunogenic carriers are carrier proteins or glycosphingolipids with immunomodulatory properties. For the person skilled in the art, a carrier protein is a protein selected from the group comprising or consisting of: a diphtheria toxoid, a
15 mutated diphtheria toxoid, a modified diphtheria toxoid, a mutated and modified diphtheria toxoid, a tetanus toxoid, a modified tetanus toxoid, a mutated tetanus toxoid, outer membrane protein (OMP), bovine serum albumin (BSA), keyhole limpet hemocyanine (KLH) or cholera toxoid (CT). The term “toxoid” as used herein refers to a bacterial toxin (usually an exotoxin), whose toxicity has been inactivated or
20 suppressed either by chemical (formalin) or heat treatment, while other properties, typically immunogenicity, are maintained. A mutated toxoid as used herein is a recombinant bacterial toxin, which has been amended to be less toxic or even non-toxic by amending the wild-type amino acid sequence. Such a mutation could be a substitution of one or more amino acids. Such a mutated toxoid presents on its
25 surface a functionality that can react with the functional group Y of the interconnecting molecule to provide a modified toxoid. Said functionality is known to the person skilled in the art and includes, but is not restricted to the primary amino functionality of a lysine residue that can react with activated esters, an isocyanate group or an aldehyde in presence of a reducing agent, to the carboxylate functionality
30 of a glutamate or aspartate residue that can be activated by carbodiimides or to the thiol functionality of a cysteine residue.

Activated esters include, but are not restricted to N-(γ -maleimidobutyryloxy) sulfosuccinimide ester (sulfo-GMBS), succinimidyl (4-iodoacetyl) aminobenzoate
35 (sulfo-SIAB), succinimidyl-3-(bromoacetamido)propionate (SBAP), disuccinimidyl glutarat (DSG), disuccinimidyl adipate (DSA), 2-pyridyldithiol-tetraoxatetradecane-*N*-hydroxysuccinimide (PEG-4-SPDP) (see **Figure 2**).

The cysteine residue on the carrier protein can be converted to the corresponding dehydroalanine that can be further reacted with a suitable interconnecting molecule to provide modified carrier protein having on their surface the functional group X of the interconnecting molecule.

5

It is especially preferred that the saccharides of general formulae (I), (III), (IV), (V), (VI) and (VII) and preferably saccharides 10, 11, 21, 24, 25, 26, 32, 42, 57, 61, 65, 72, 27*, 33*, 36*, 73*, 85* and 88* are conjugated to the non-toxic mutated diphtheria toxin CRM₁₉₇ presenting as a functionality a primary amine functionality of a lysine residue.

10

CRM₁₉₇ like wild-type diphtheria toxin is a single polypeptide chain of 535 amino acids (58 kD) consisting of two subunits linked by disulfide bridges having a single amino acid substitution of glutamic acid for glycine. It is utilized as a carrier protein in a number of approved conjugate vaccines for diseases such as Prevnar.

15

Thus, in a preferred embodiment of the present invention the carrier protein presents on its surface primary amino functionalities of lysine residues that are able to react with the functional group Y of the interconnecting molecule to provide modified carrier protein having on their surface said functional group X of the interconnecting molecule, which is able to react with the terminal amino group of the linker of the compounds of general formula (I).

20

Said functional group X of the interconnecting molecules is selected of the group comprising or consisting of maleimide; α -iodoacetyl; α -bromoacetyl; and *N*-hydroxysuccinimide ester (NHS), aldehyde, imidoester, carboxylic acid, alkyl sulfonate, sulfonyl chloride, epoxide, anhydride, carbonate (see **Figure 3**).

25

Preferably, the saccharide of general formulae (I), (III), (IV), (V), (VI) and (VII) is conjugated to the non-toxic mutated diphtheria toxin CRM₁₉₇, which is modified by maleimide. In yet another preferred embodiment, the saccharide of general formulae (I), (III), (IV), (V), (VI) and (VII) is conjugated to the non-toxic mutated diphtheria toxin CRM₁₉₇, which is modified by α -bromoacetamide. In the most preferred embodiment, the saccharide of general formula I is conjugated to the non-toxic mutated diphtheria toxin CRM₁₉₇, which is modified by *N*-hydroxysuccinimide adipate.

30

35

More preferably, the CRM₁₉₇ glycoconjugate is selected from the group consisting of:

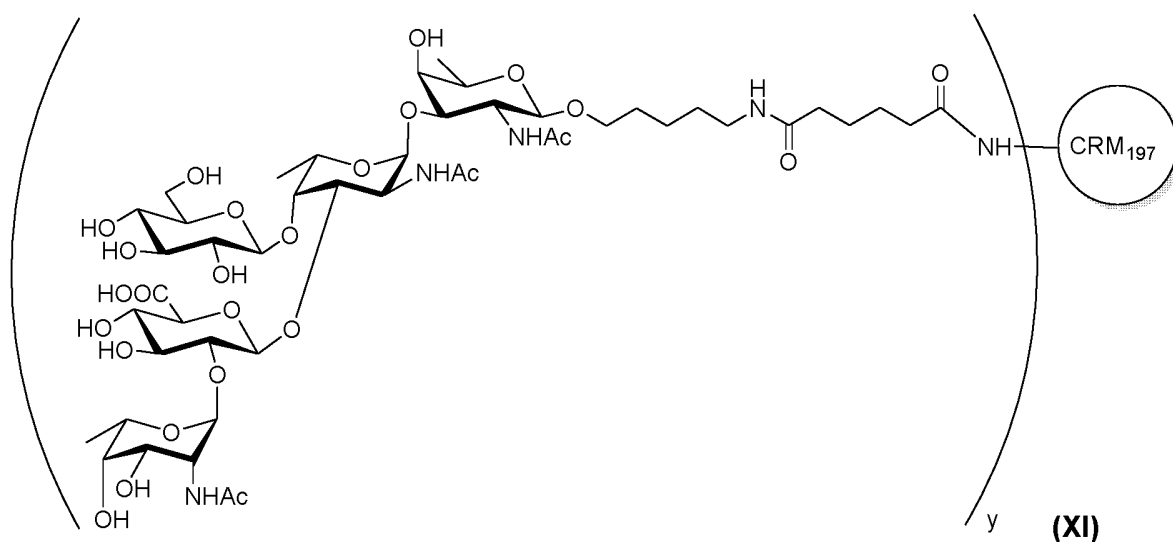
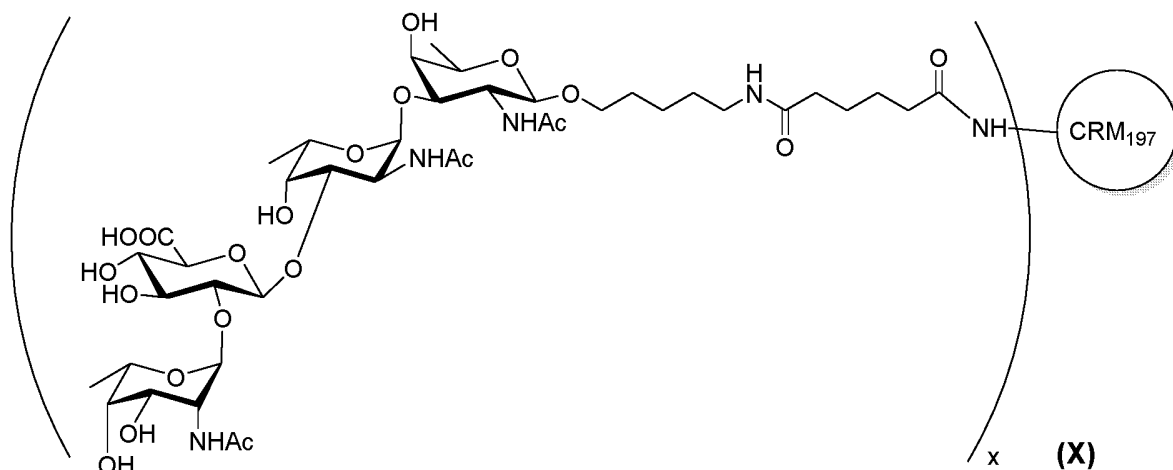

5 and

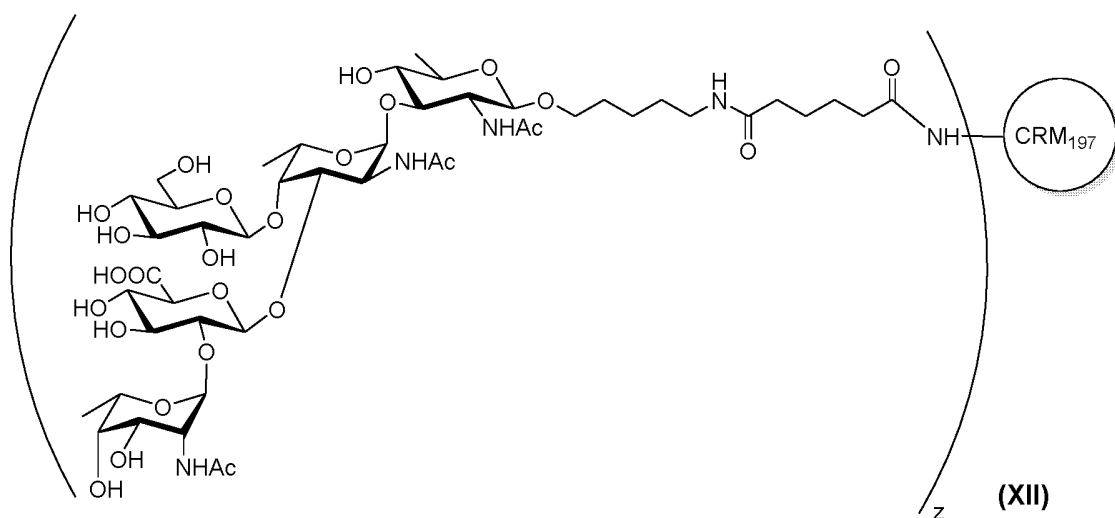

wherein x, y and z are independently integer from 1 to 20; preferred integer from 1 to 15; more preferred integer from 5 to 14; more preferred integer from 7 to 13; more preferred integer from 8 to 12.

Most preferred is the conjugates **58a***, **58b***, **58c***, and **87***

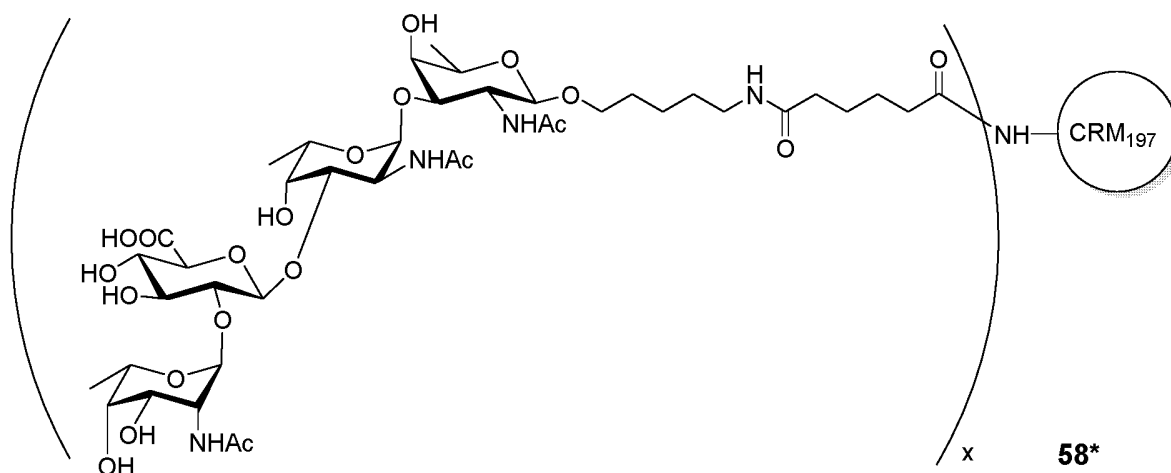

5 **58*a** when $x = 7$; **58*b** when $x=8$; **58*c** when $x = 11.2$.

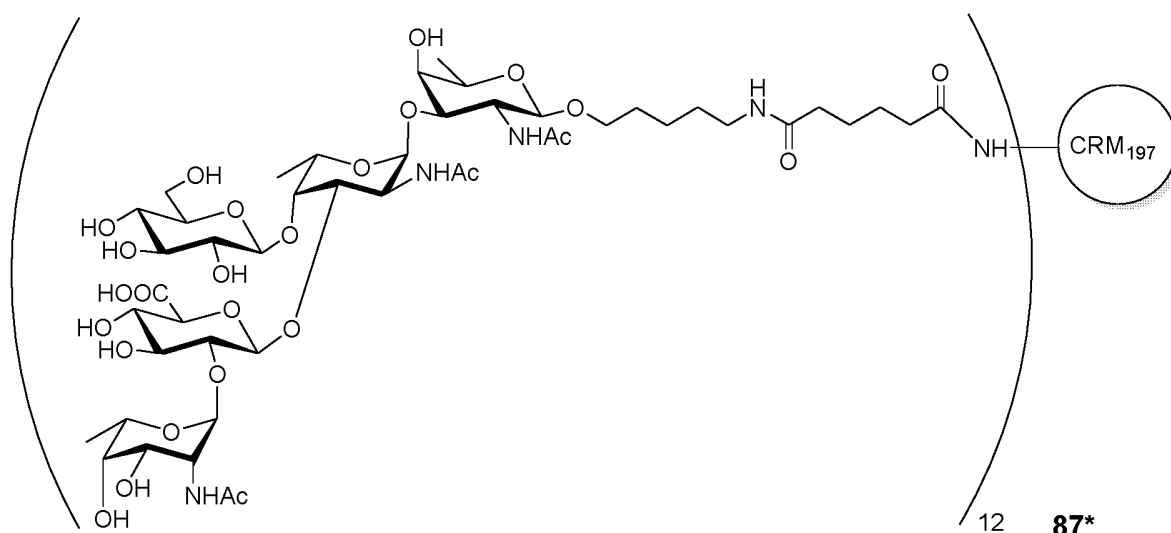

10 In another embodiment, said immunogenic carrier is preferably a glycosphingolipid with immunomodulatory properties, and more preferably (2*S*,3*S*,4*R*)-1-(α -D-galactopyranosyl)-2-hexacosanoylaminoctadecane-3,4-diol. The term glycosphingolipid with immunomodulatory properties, as used herein, refers to a suitable glycosphingolipid capable of stimulating the immune system's response to a target antigen, but which does not in itself confer immunity as defined above.

15

Glycosphingolipids as used herein are compounds containing a carbohydrate moiety α -linked to a sphingolipid. Preferably, the carbohydrate moiety is a hexopyranose and most preferably is α -D-galactopyranose. For the person skilled in the art, sphingolipids are a class of lipids containing a C18 amino alcohol connected *via* an amide bond to a fatty acid. The C18 amino alcohol is preferably mono-, di- or

20

polysubstituted with hydroxyl groups. Especially preferred, the C18 amino alcohol is phytosphingosine. The fatty acid is preferably a monocarboxylic acid having a saturated alkyl chain of a number of carbons ranging from 16 to 28 and more preferably from 18 to 26. Glycosphingolipids with immunomodulatory properties include, but they are not restricted to (2S,3S,4R)-1-(α -D-galactopyranosyl)-2-hexacosanoylamino-octadecane-3,4-diol, which can stimulate natural killer (NK) activity and cytokine production by natural killer T (NKT) cells and exhibits potent antitumor activity *in vivo* (*Proc. Natl Acad. Sci. USA*, **1998**, 95, 5690).

10 The conjugates of the saccharides of general formulae (I), (III), (IV), (V), (VI) and (VII) with a glycosphingolipid with immunomodulatory properties have the advantage of being heat stable. To be suitable for conjugation, on the glycosphingolipid with immunomodulatory properties a functionality is introduced. Said functionality is prone to react directly with the terminal amino group of the linker of the saccharides of general formulae (I), (III), (IV), (V), (VI) and (VII), or with the functional group Y of the interconnecting molecule to provide the modified glycosphingolipid with immunomodulatory properties.

20 Preferably, said functionality is introduced at the C6 of the carbohydrate moiety of the glycosphingolipid with immunomodulatory properties. Thus, the glycosphingolipid with immunomodulatory properties is functionalized with a functionality, which is prone of reacting with the terminal amino group of the saccharides or with the functional group Y of the interconnecting molecule. A functionality prone to react with an amino group includes, but it is not restricted to activated ester, isocyanate group, aldehyde, epoxide, imidoester, carboxylic acid, alkyl sulfonate and sulfonyl chloride. A functionality prone to react with the functional group Y of the interconnecting molecule so that to provide the modified glycosphingolipid with immunomodulatory properties presenting the functional group X of the interconnecting molecule includes, but it is not restricted to amine, alcohol, thiol, activated ester, isocyanate group, aldehyde, epoxide, vinyl, imidoester, carboxylic acid, alkyl sulfonate, sulfonyl chloride, vinyl group, alkynyl group and azido group.

35 Preferably, the functionality introduced at the C6 of the carbohydrate moiety of the glycosphingolipid with immunomodulatory properties is selected from the group comprising or containing an amine, a thiol, an alcohol, a carboxylic acid, a vinyl, maleimide, α -iodoacetyl, α -bromoacetyl, *N*-hydroxysuccinimide ester (NHS), 2-pyridyldithiols.

Said functional group X of the interconnecting molecules is selected from the group comprising or consisting of maleimide, α -iodoacetyl, α -bromoacetyl, *N*-hydroxysuccinimide ester (NHS), aldehyde, carboxylic acid, epoxyde alkyl sulfonate, sulfonyl chloride, anhydride, carbonate.

5

As used herein, the term "interconnecting molecule" refers to a bifunctional molecule containing functional group X and functional group Y, wherein functional group X is capable of reacting with the terminal amino group on the linker –L– and the functional group Y is capable of reacting with a functionality present on the immunogenic carrier or on the solid support.

10

It was found that the conjugates comprising the saccharides of the present invention, preferred the conjugates (X), (XI) and (XII), more preferred **58*a**, **58*b**, **58*c**, **87***, are suitable for raising a protective immune response in a human and/or animal host, and therefore are useful for prevention and/or treatment of diseases associated with bacteria containing *N*-acetyl-L-pneumosamine in their capsular polysaccharide.

15

Preferably, the bacterium containing in the capsular polysaccharide *N*-acetyl-L-pneumosamine is *Streptococcus pneumoniae* serotype 5.

20

In a preferred embodiment, the conjugates comprising the saccharides of general formulae (I), (III), (IV), (V), (VI) or (VII) conjugated to an immunogenic carrier, preferred the conjugates (X), (XI) and (XII), more preferred **58*a**, **58*b**, **58*c**, **87***, are useful for prevention and/or treatment of diseases associated with bacteria, and particularly with diseases associated with bacteria containing *N*-acetyl-L-pneumosamine in their capsular polysaccharide, and preferably with *Streptococcus pneumoniae* serotype 5, wherein said diseases include pneumonia, meningitis, otitis media, bacteremia and acute exacerbation of chronic bronchitis, sinusitis, arthritis and conjunctivitis.

25

30

One aspect of the present invention relates to pharmaceutical compositions, especially vaccines comprising a conjugate comprising a saccharide of general formula (I) conjugated to an immunogenic carrier, and/or one saccharide of general formula (I), together with at least one pharmaceutically acceptable cryoprotectant, lyoprotectant, excipient and/or diluent. Said pharmaceutical compositions can be used for raising a protective immune response in a human and/or animal host.

35

One aspect of the present invention relates to pharmaceutical compositions, especially vaccines further comprising at least one of antigens of other *Streptococcus pneumoniae* serotypes, preferred serotypes 2, 4, 8, 9A, 9V and 14.

5 Said vaccine may be prepared in the form of a suspension or may be lyophilized. The suspension form may be stored frozen. In the lyophilized form, it is preferable to add one or more stabilizers. Optionally, one or more adjuvants may be added as well. Any conventional stabilizers and adjuvants may be included in a vaccine according to this invention.

10

The term "adjuvant" as used herein refers to an immunological adjuvant i.e. a material used in a vaccine composition that modifies or augments the effects of said vaccine by enhancing the immune response to a given antigen contained in the vaccine without being antigenically related to it. For the persons skilled in the art, classically recognized examples immunological adjuvants include but are not
15 restricted to oil emulsions (e.g. Freund's adjuvant), saponins, aluminium or calcium salts (e.g. alum), non-ionic block polymer surfactants, and many others.

15

Vaccination can be performed at any age. The vaccine may be administered
20 subcutaneously, by spray, by injection, orally, intraocularly, intratracheally or nasally.

20

Another aspect of the present invention relates to pharmaceutical formulations and pharmaceutical compositions containing the vaccine as an active ingredient, together with at least one pharmaceutically acceptable carrier, excipient, solvent and/or
25 diluents.

25

Further preferred, the pharmaceutical composition is formulated in the form of a lyophilisate or liquid buffer solution.

30 The vaccine can also be administered in form of its pharmaceutically active salt optionally using substantially nontoxic pharmaceutically acceptable carrier, excipients, adjuvants or diluents. The vaccine of the present invention is prepared in a conventional solid or liquid carrier or diluents and a conventional pharmaceutically-made adjuvant at suitable dosage level in a known way. The preferred preparations
35 and formulations are in administrable form, which is suitable for oral application. These administrable forms, for example, include pills, tablets, film tablets, coated tablets, capsules, powders and deposits. Forms other than oral administrable forms are also possible. The inventive vaccine may be administered by any appropriate means, including but not limited to inhalation; injection (intravenous, intraperitoneal,

35

intramuscular, subcutaneous); by absorption through epithelial or mucocutaneous linings (oral mucosa, rectal and vaginal epithelial linings, nasopharyngeal mucosa, intestinal mucosa); orally, rectally, transdermally, topically, intradermally, intragastrically, intracutaneously, intravaginally, intravasally, intranasally, 5 intrabuccally, percutaneously, sublingually, or any other means available within the pharmaceutical arts.

The vaccine of the present invention, containing a conjugate comprising the saccharide of general formula (I) conjugated to an immunogenic carrier, the 10 saccharide of general formula (I) or pharmaceutically acceptable salts thereof as an active ingredient will typically be administered in admixture with suitable carrier materials suitably selected with respect to the intended form of administration, i.e. oral tablets, capsules (either solid-filled, semi-solid filled or liquid filled), powders for constitution, oral gels, elixirs, dispersible granules, syrups, suspensions, and the like, 15 and consistent with conventional pharmaceutical practices. For example, for oral administration in the form of tablets or capsules, the active ingredient may be combined with any oral nontoxic pharmaceutically acceptable inert carrier, such as lactose, starch, sucrose, cellulose, magnesium stearate, dicalcium phosphate, calcium sulfate, talc, mannitol, ethyl alcohol (liquid forms) and the like. Moreover, 20 when desired or needed, suitable binders, lubricants, disintegrating agents and colouring agents may also be incorporated in the mixture.

Suitable binders include starch, gelatin, natural sugars, corn sweeteners, natural and synthetic gums such as acacia, sodium alginate, carboxymethyl-cellulose, 25 polyethylene glycol and waxes. Among the lubricants that may be mentioned for use in these dosage forms, boric acid, sodium benzoate, sodium acetate, sodium chloride, and the like. Disintegrants include starch, methylcellulose, guar gum and the like. Sweetening and flavoring agents and preservatives may also be included where appropriate. Some of the terms noted above, namely disintegrants, diluents, 30 lubricants, binders and the like, are discussed in more detail below.

Additionally, the vaccine of the present invention may be formulated in sustained release form to provide the rate controlled release of any one or more of the components or active ingredients to optimize the therapeutic effects. Suitable 35 dosage forms for sustained release include layered tablets containing layers of varying disintegration rates or controlled release polymeric matrices impregnated with the active components and shaped in tablet form or capsules containing such impregnated or encapsulated porous polymeric matrices.

Liquid form preparations include solutions, suspensions and emulsions. As an example may be mentioned water or water-propylene glycol solutions for parenteral injections or addition of sweeteners and opacifiers for oral solutions, suspensions and emulsions. Liquid form preparations may also include solutions for intranasal administration.

5

Aerosol preparations suitable for inhalation may include solutions and solids in powder form, which may be in combination with a pharmaceutically acceptable carrier such as inert compressed gas, e.g. nitrogen.

10

For preparing suppositories, a low melting wax such as a mixture of fatty acid glycerides such as cocoa butter is first melted, and the active ingredient is dispersed homogeneously therein by stirring or similar mixing. The molten homogeneous mixture is then poured into convenient sized molds, allowed to cool and thereby solidifies.

15

Also included are solid form preparations that are intended to be converted, shortly before use, to liquid form preparations for either oral or parenteral administration. Such liquid forms include solutions, suspensions and emulsions.

20

The vaccine of the present invention may also be deliverable transdermally. The transdermal compositions may take the form of creams, lotions, aerosols and/or emulsions and can be included in a transdermal patch of the matrix or reservoir type as are conventional in the art for this purpose.

25

The term capsule refers to a special container or enclosure made of methyl cellulose, polyvinyl alcohols, or denatured gelatins or starch for holding or containing compositions comprising the active ingredients. Hard shell capsules are typically made of blends of relatively high gel strength bone and pork skin gelatins. The capsule itself may contain small amounts of dyes, opaquing agents, plasticizers and preservatives.

30

Tablet means compressed or molded solid dosage form containing the active ingredients with suitable diluents. The tablet can be prepared by compression of mixtures or granulations obtained by wet granulation, dry granulation or by compaction well known to a person skilled in the art.

35

Oral gels refer to the active ingredients dispersed or solubilized in a hydrophilic semi-solid matrix.

Powders for constitution refer to powder blends containing the active ingredients and suitable diluents which can be suspended in water or juices.

- 5 Suitable diluents are substances that usually make up the major portion of the composition or dosage form. Suitable diluents include sugars such as lactose, sucrose, mannitol and sorbitol, starches derived from wheat, corn rice and potato, and celluloses such as microcrystalline cellulose. The amount of diluents in the composition can range from about 5 to about 95% by weight of the total composition,
10 preferably from about 25 to about 75%, more preferably from about 30 to about 60% by weight, and most preferably from about 40 to 50% by weight.

The term disintegrants refers to materials added to the composition to help it break apart (disintegrate) and release the medicaments. Suitable disintegrants include
15 starches, "cold water soluble" modified starches such as sodium carboxymethyl starch, natural and synthetic gums such as locust bean, karaya, guar, tragacanth and agar, cellulose derivatives such as methylcellulose and sodium carboxymethylcellulose, microcrystalline celluloses and cross-linked microcrystalline celluloses such as sodium croscarmellose, alginates such as alginic acid and sodium
20 alginate, clays such as bentonites, and effervescent mixtures. The amount of disintegrant in the composition can range from about 1 to about 40% by weight of the composition, preferably 2 to about 30% by weight of the composition, more preferably from about 3 to 20% by weight of the composition, and most preferably from about 5 to about 10% by weight.

25 Binders characterize substances that bind or "glue" powders together and make them cohesive by forming granules, thus serving as the "adhesive" in the formulation. Binders add cohesive strength already available in the diluents or bulking agent. Suitable binders include sugars such as sucrose, starches derived from wheat, corn
30 rice and potato; natural gums such as acacia, gelatin and tragacanth; derivatives of seaweed such as alginic acid, sodium alginate and ammonium calcium alginate; cellulosic materials such as methylcellulose and sodium carboxymethylcellulose and hydroxypropyl-methylcellulose; polyvinylpyrrolidone; and inorganics such as magnesium aluminum silicate. The amount of binder in the composition can range
35 from about 1 to 30% by weight of the composition, preferably from about 2 to about 20% by weight of the composition, more preferably from about 3 to about 10% by weight, even more preferably from about 3 to about 6% by weight.

Lubricant refers to a substance added to the dosage form to enable the tablet, granules, etc. after it has been compressed, to release from the mold or die by reducing friction or wear. Suitable lubricants include metallic stearates such as magnesium stearate, calcium stearate or potassium stearate; stearic acid; high melting point waxes; and water soluble lubricants such as sodium chloride, sodium benzoate, sodium acetate, sodium oleate, polyethylene glycols and D, L-leucine. Lubricants are usually added at the very last step before compression, since they must be present on the surfaces of the granules and in between them and the parts of the tablet press. The amount of lubricant in the composition can range from about 0.05 to about 15% by weight of the composition, preferably 0.2 to about 5% by weight of the composition, more preferably from about 0.3 to about 3%, and most preferably from about 0.3 to about 1.5% by weight of the composition.

Glidants are materials that prevent caking and improve the flow characteristics of granulations, so that flow is smooth and uniform. Suitable glidants include silicon dioxide and talc. The amount of glident in the composition can range from about 0.01 to 10% by weight of the composition, preferably 0.1% to about 7% by weight of the total composition, more preferably from about 0.2 to 5% by weight, and most preferably from about 0.5 to about 2% by weight.

Colouring agents are excipients that provide coloration to the composition or the dosage form. Such excipients can include food grade dyes and food grade dyes adsorbed onto a suitable adsorbent such as clay or aluminium oxide. The amount of the colouring agent can vary from about 0.01 to 10% by weight of the composition, preferably from about 0.05 to 6% by weight, more preferably from about 0.1 to about 4% by weight of the composition, and most preferably from about 0.1 to about 1%.

Techniques for the formulation and administration of the vaccine of the present invention may be found in "Remington's Pharmaceutical Sciences" Mack Publishing Co., Easton PA. A suitable vaccine composition comprising at least one conjugate of the present invention and/or pharmaceutically acceptable salts thereof may be a solution of one conjugate comprising a saccharide of general formula (I) conjugated to an immunogenic carrier in a suitable liquid pharmaceutical carrier or any other formulation such as tablets, pills, film tablets, coated tablets, dragees, capsules, powders and deposits, gels, syrups, slurries, suspensions, emulsions, and the like.

A therapeutically effective dosage of one conjugate according to the present invention or of one saccharide of general formula (I) refers to that amount of the compound that results in an at least a partial immunization against a disease.

Toxicity and therapeutic efficacy of such compounds can be determined by standard pharmaceutical, pharmacological, and toxicological procedures in cell cultures or experimental animals. The dose ratio between toxic and therapeutic effect is the therapeutic index. The actual amount of the composition administered will be dependent on the subject being treated, on the subject's weight, the severity of the affliction, the manner of administration and the judgement of the prescribing physician.

Yet another aspect of the present invention refers to saccharide of general formula (I) for use as marker in immunological assays for detection of antibodies against bacteria containing *N*-acetyl-L-pneumosamine in their capsular polysaccharide.

Such assays comprise, for instance, microarray and ELISA useful for detection of antibodies against bacteria containing *N*-acetyl-L-pneumosamine in their capsular polysaccharide, such as *Streptococcus pneumoniae* serotype 5.

The saccharides of the present invention can be easily conjugated to solid supports for providing immunological assays useful for detection of antibodies against bacteria containing *N*-acetyl-L-pneumosamine in their capsular polysaccharide. Said solid supports present on their surface a functionality that is prone to react with the amino group of saccharides of general formula (I) or with the functional group Y of the interconnecting molecule to provide modified solid supports, presenting on their surface the functional group X of the interconnecting molecule that can further react with the amino group of saccharides of general formula (I). In an embodiment according to the present invention the solid supports are microarray slides, which present on their surface a functionality that is prone to react with the functional group Y of the interconnecting molecule to provide modified microarray slides, presenting of their surface the functional group X of the interconnecting molecule. Example of such microarray slides include, but are not restricted to Corning® epoxide coated slides or Corning® GAPS™ II coated slides.

In a preferred embodiment the solid supports are microarray slides presenting on their surface a functionality that is prone to react with the amino group of saccharides of general formula (I), and more preferably an *N*-hydroxysuccinimide (NHS) activated ester. Such microarray slides are for example CodeLink® NHS slides.

A glycan microarray prepared as described in **Example 78** was used to identify the binding epitopes of commercial anti-SP5 specific typing sera generated in rabbits (see **Figure 4**).

As shown by **Figure 4A**, only three out of the eleven printed glycans were bound by specific anti-SP5 IgG, namely tetrasaccharide **33*** (position 1), α -PneNAc-(1 \rightarrow 2)-GlcA disaccharide **27*** (position 8) and α -PneNAc monosaccharide **36*** (position 10).

5 All three recognized oligosaccharides contain the α -PneNAc residue, demonstrating that this motif is part of the recognized epitope. It was further observed that IgG bound tetrasaccharide **33*** and disaccharide **27*** in comparable levels, suggesting that α -PneNAc-(1 \rightarrow 2)-GlcA is in fact the epitope recognized by IgG of specific SP5 typing sera. **Figure 4B** shows a microarray sample where the typing serum was pre-
10 incubated with a solution of the natural SP5 CPS. The anti-glycan IgG levels are significantly reduced compared to the sample of **Figure 4A**. This means that antibodies bound to the natural CPS during pre-incubation are no longer available for binding to the synthetic glycans. Consequently, the binding epitopes of natural CPS and the synthetic glycans are identical.

15 In order to identify epitopes recognized by the human immune system, further screenings were carried out using pooled sera of humans who had received a pneumococcal CPS-based vaccine, containing the CPS of multiple different serotypes (see **Figure 5**).

20 The IgG response of immunized humans towards the synthetic glycans is shown in **Figure 5A**. Although the sera of immunized humans were not SP5 specific, they contained IgG predominantly against tetrasaccharide **33*** (position 1). IgG binding to PneNAc-(1 \rightarrow 2)-GlcA disaccharide **27*** (position 8) and PneNAc **36*** (position 10)
25 were also observed, however at lower levels.

Additionally, low levels of anti-**21*** (position 5) and anti-**51*** (position 6) IgG and very low levels of anti-**20*** (position 4), anti-**44*** (position 7), anti-**52*** (position 9) and anti-**37*** (position 11) IgG were detected. Antibodies against D-FucNAc **15*** (position 3)
30 and the Sug-containing sample **14*** (position 2) were not detected at all. Interestingly, higher levels of anti-disaccharide **21*** antibodies were detected than for the sample containing L-FucNAc-(1 \rightarrow 3)- β -Sug **20***. This would suggest that the presence of the ketone is indeed detrimental to antibody binding. Pre-incubation of the human sera with the natural SP5 CPS, shown in **Figure 5B**, led to a significant reduction of anti-
35 tetrasaccharide **33*** IgG levels. This proves that the antibodies binding **33*** are SP5 specific since they also bind the SP5 CPS.

Further microarray data indicated that the type sera recognized the several synthetic glycans along with CPS-5 polysaccharide (**Figure 8B**). However the type sera also

recognized the tetrasaccharide **33*** and pentasaccharide **73*** with high affinity and considered to be the B cell epitopes that has been presented to the MHCII molecules. Thus, suggesting that these oligosaccharides are critical for immunity.

5 It has been shown that substructure of the SP5 CPS such as reference structure 1 (**Ref.1**) and 2 (**Ref.2**) which do not contain the pneumosamine sugar are not recognized by the antibodies produced during immunization. Therefore, it is assumed that the pneumosamine is a very important part of the immunogenic epitope and is somehow required for effective and protective immune response and
10 antibody production. So far it was not possible to trigger determinable antibody titer against SP5 CPS when using one of the above mentioned reference structure conjugated to CRM₁₉₇ for immunization in rabbits.

In conclusion, the microarray analyses revealed that the terminal PneNAc residue is
15 part of the epitope recognized by anti-SP5 CPS antibodies and that α -PneNAc-(1→2)-GlcA is the predominant epitope recognized by SP5 typing sera. In the case of vaccinated humans, the SP5-specific epitope seems to be larger, resembling tetrasaccharide **33*** and pentasaccharide **73***. The reducing end D-FucNAc or Sug residues do not seem to be important for the immunological response to SP5.

20 Glycan microarray with antibodies raised in rabbit against ST5 synthetic glycan conjugates also demonstrates (Example 81, **Figure 9B and D**). This result suggested that the tetrasaccharide **33*** and pentasaccharide **73*** are immunogenic in rabbit and induced cross-reactive antibodies.

25 As shown in Example 82 and Figure 10, antibody responses analyzed by ELISA support that pentasaccharide **73*** is more immunogenic compared to tetrasaccharide **33***.

30 Surface binding of anti-ST5 glycan conjugates sera indicates that antibodies against the anti-ST5 glycans localized the epitope on the surface of pneumococci (Example 83, **Figure 11**) and considered to be a novel synthetic vaccine candidate.

Opsonophagocytic killing assay was performed to assess the functional relevance of the antibodies induced in response to immunization with ST5 (tetrasaccharide)
35 conjugate **58*c**. This data demonstrates that ST5 (tetrasaccharide) conjugate **58*c** generates neutralizing antibodies and promote the killing of pneumococci by differentiated HL-60 cells.

Chemical synthesis

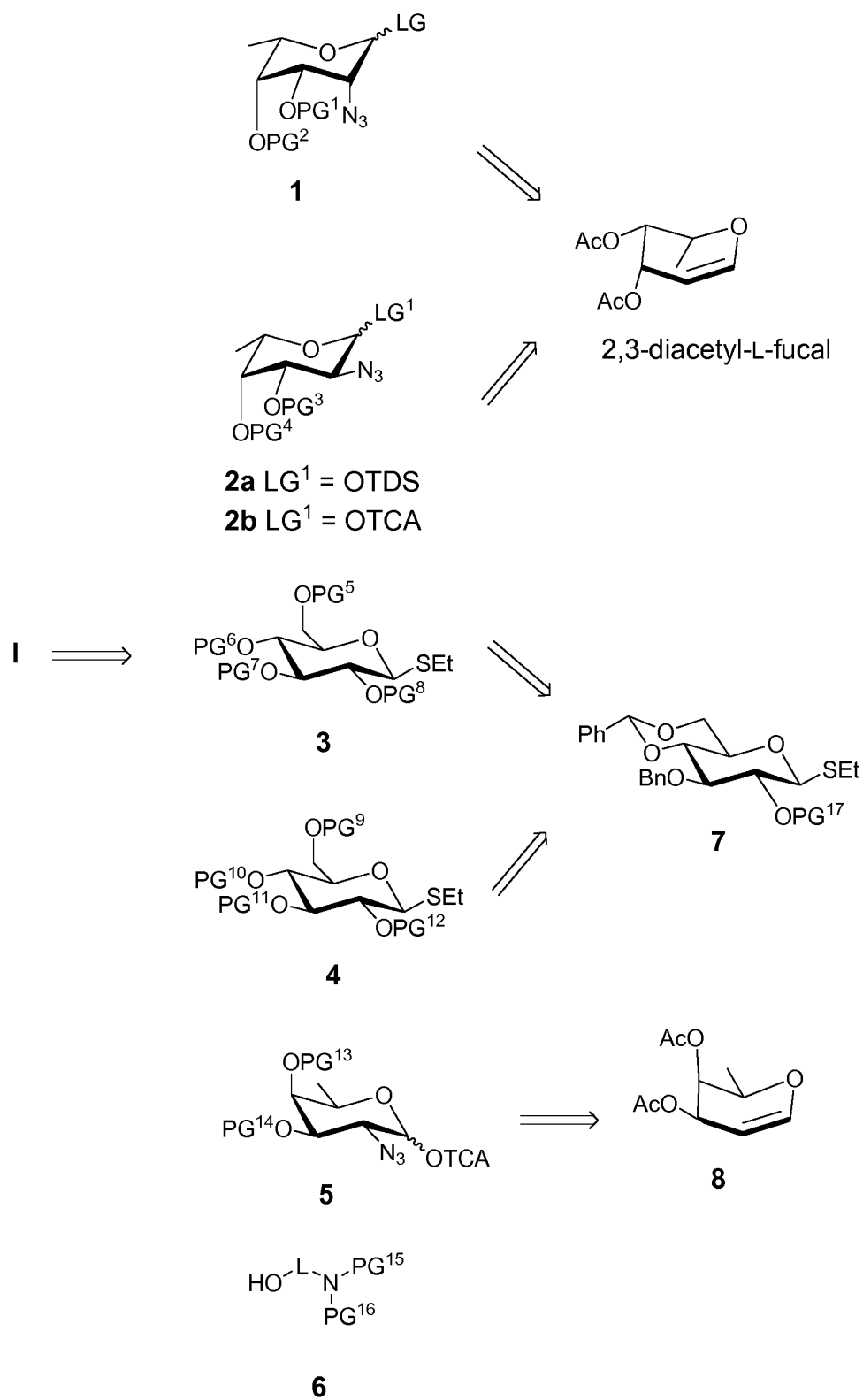
5 **Scheme 1:** Retrosynthetic scheme.

The saccharides of general formula I can be assembled starting from building blocks 1, 2, 3, 4, 5 and 6 (see Scheme 1). Building blocks 1 and 2 can be easily prepared via an azidoselenation reaction starting from known 3,4-diacetyl-L-fucal. Thioglucosides 3 and 4 can, for example, be accessed by regioselective opening of the benzylidene acetal installed at the positions 4 and 6 of the thioglucoside building block 7. D-Fucose building block 5 can be obtained via an azidoselenation reaction starting from known D-fucal 8.

LG represents a leaving group that is preferably selected from:

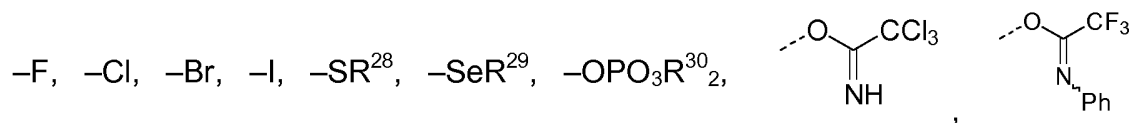

10

R^{28} is selected from: $-CH_3$, $-CH_2CH_3$, $-Ph$,

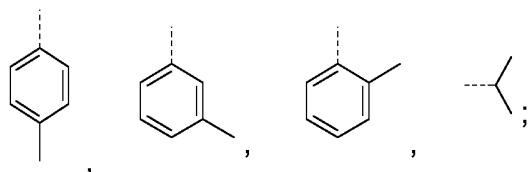

R^{29} represents $-Ph$;

R^{30} represents $-CH_2CH_2CH_2CH_3$.

15 PG^1 , PG^2 , PG^3 , PG^4 , PG^5 , PG^6 , PG^7 , PG^8 , PG^9 , PG^{10} , PG^{11} , PG^{12} , PG^{13} , PG^{14} , PG^{15} , PG^{16} and PG^{17} represent protecting groups. The term "protecting group" as used herein refers to commonly used groups in organic synthesis, preferably used for protection of amines, hydroxyl groups, thiols, imines, carbonyls, carboxyls or other common functional groups, and particularly preferred for amines and hydroxyl groups.

20

The protecting groups can be differentiated in permanent protecting groups and temporary protecting groups. Permanent protecting groups are protecting groups that are stable during the entire synthesis and that can be efficiently removed at the late stage of the synthesis. In this case, permanent protecting groups include PG^1 , PG^2 , PG^6 , PG^7 , PG^9 , PG^{11} , PG^{15} and PG^{16} . PG^1 , PG^2 , PG^6 , PG^7 , PG^9 and PG^{11} are masking the hydroxyl groups during the entire synthesis, while protecting groups PG^{15} and PG^{16} are masking the terminal amino group present on the linker L. Preferably, protecting groups PG^1 , PG^2 , PG^6 , PG^7 , PG^9 , PG^{10} , PG^{11} and PG^{15} are benzyl groups and protecting group PG^{16} is a benzyloxycarbonyl protecting group (Cbz).

25

30

The temporary protecting groups are generally orthogonal protecting groups that can be selectively removed at different levels of the synthesis to free hydroxyl groups for subsequent introduction of different substituents, including monosaccharides or other protecting groups. In this case, temporary protecting groups include PG³, PG⁴, PG⁵, PG⁸, PG¹², PG¹³, PG¹⁴ and PG¹⁷.

The ingenious choice of protecting groups allows expedient access to a library of saccharides of general formula I functionalized with an amino group for subsequent conjugation to an immunogenic carrier or a solid support.

10

More specifically PG³, PG⁴, PG⁵, PG⁸, PG¹², PG¹³, PG¹⁴ and PG¹⁷ are temporary protecting groups suitable for protection of hydroxyl groups i.e. being capable to be removed subsequently one after another by a suitable sequence of deprotection reactions. Preferably PG³, PG⁴, PG⁵, PG⁸, PG¹², PG¹³, PG¹⁴ and PG¹⁷ are selected from the group consisting of or comprising: allyl, acetyl, benzoyl, *p*-methoxybenzyl, trityl, 2-naphthylmethyl, triisopropylsilyl, *tert*-butyldimethylsilyl, *tert*-butyldiphenylsilyl, *tert*-butylmethoxyphenylsilyl, triethylsilyl, trimethylsilyl, 2-trimethylsilylethoxymethyl, 9-fluorenylmethoxycarbonyl and levulinoyl.

Preferably, PG³ and PG⁴ installed at C-3 and C-4 of building block **2** are participating protecting groups ensuring the formation of the α -glycosidic linkage, and more preferably they are acetyl groups.

Preferably, protecting groups PG⁸ and PG¹² present at position 2 of the glucoside building blocks **3** and **4** are participating protecting groups favoring the formation of the β -glycosidic linkage that are selected from benzoyl and levulinoyl. Preferably protecting group PG¹⁷ has the same meaning as protecting groups PG⁸ and PG¹².

Orthogonal protecting group PG⁵ was installed at the 6th position of the glucoside **3** in anticipation of the introduction of the carboxylic acid group at this position. Preferably, protecting group PG⁵ represents allyl, 2-naphthylmethyl, benzoyl or *p*-methoxybenzyl. Alternatively, building block **3a** could be used instead of building block **3** for the assembly of the saccharides of general formula (I).

35

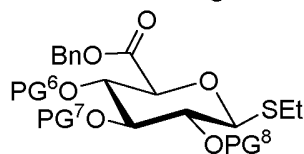
**3a**

Protecting groups PG¹³ and PG¹⁴ are non-participating protecting groups. Preferably, protecting group PG¹⁴ can be removed in presence of PG¹³ in anticipation of the chain elongation at the C-3 position. Such non-participating protecting groups are known to the person skilled in the art and include, but are not restricted to allyl ether, silyl ethers, 2-naphthylmethyl ether and *p*-methoxybenzyl ether. Preferably, PG¹⁴ is *p*-methoxybenzyl and PG¹³ is 2-naphthylmethyl.

Hence, the saccharides of general formula **I** with R¹ representing R⁴ and R⁴ representing R⁶ (i.e. monosaccharides of general formula **10**) can be synthesized according to the synthetic pathway described in **Scheme 2**. Synthesis of trichloroacetimidate L-pneumosamine **1** was accomplished via azidoselenation of known 3,4-diacetyl-L-fucal. The terminal amino linker was appended at the anomeric position by treatment of the building block **1** with the amino alcohol HO-L-NBnCbz in presence of TMSOTf at -30 °C.

Protected monosaccharide **9** can be converted to saccharides of general formula (**10**) following deprotection procedures known to the skilled person. For example, hydrogenolysis using Pd/C as catalyst in a mixture of solvents EtOH/H₂O/AcOH provides saccharides of general formula **10** with R²³ being -H. Saccharides of general formula **10** with R²³ being -C(O)CH₃ can be accessed *via* a two-step deprotection procedure including conversion of the azido group to the acetamido group by treatment with thioacetic acid in pyridine, followed by hydrogenolysis using Pd/C as catalyst. Saccharides of general formula **10** with R²³ being -C(O)CF₃ or -C(O)CCl₃ can be prepared *via* a three step deprotection procedure including chemoselective reduction of the azido group to the amino group, followed by acylation and hydrogenolysis using Pd/C as catalyst. The chemoselective reduction can be carried out *via* Staudinger reaction (PPh₃ or PMe₃, THF/H₂O) or *via* hydrogenolysis on Pd/C in presence of ammonia, ammonium acetate, triphenylphosphine or pyridine. The acylation can be for example accomplished by treatment of the amine with the suitable acyl chloride or the suitable anhydride in presence of pyridine.

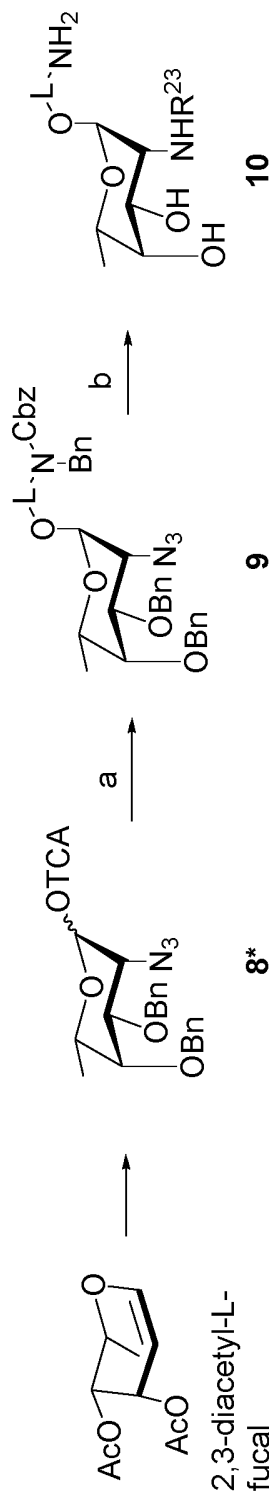

Scheme 2: Synthesis of monosaccharides of general formula **10**: **a.** HO-L-NBnCbz, TMSOTf, DCM, 4Å molecular sieves, -30 °C to -20 °C; **b.** general deprotection procedure.

38

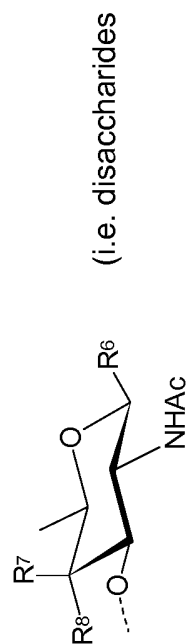

The saccharides of general formula **I** with R¹ representing R⁴ and R⁴ representing

of general formula **11**) can be, for example, prepared according to the synthetic pathway described in **Scheme 3**. Hence, starting from known D-fucal **8**, trichloroacetimidate **4*** was synthesized in 5 steps according to procedures described in the literature. At this level, the amino linker was appended at the anomeric position by reacting the trichloroacetimidate **4*** with amino alcohol HO-L-NBnCbz in presence of TMSOTf at -15 °C to give monosaccharide **13**. To access disaccharides of general formula **11**, wherein R²³ is selected from -H, -C(O)CF₃ and -C(O)CCl₃, the azido group is converted at this level to the acetamido group by treatment with thioacetic acid in pyridine to provide intermediate **14**. Removal of the PMB protecting group on intermediates **13** and **14** provides alcohols **15** and **16** representing the glycosyl acceptor for the next glycosylation reaction. Alcohol **15** was then reacted with imidate **8*** in presence of TMSOTf to provide disaccharide **17** corresponding to the precursors of disaccharides of general formula **11** with R²³ being -C(O)CH₃. The same reaction procedure applied to monosaccharide **16** results in the formation of the disaccharide **18**, which is the precursor of the disaccharide of general formula **11** with R²³ being selected from -H, -C(O)CF₃ and -C(O)CCl₃.

10

15

Step e including installation of the residues R^7 and R^8 and the final deprotection is in detail described for compound **17** in **Scheme 4**. The same pathway is performed for the compound **18**.

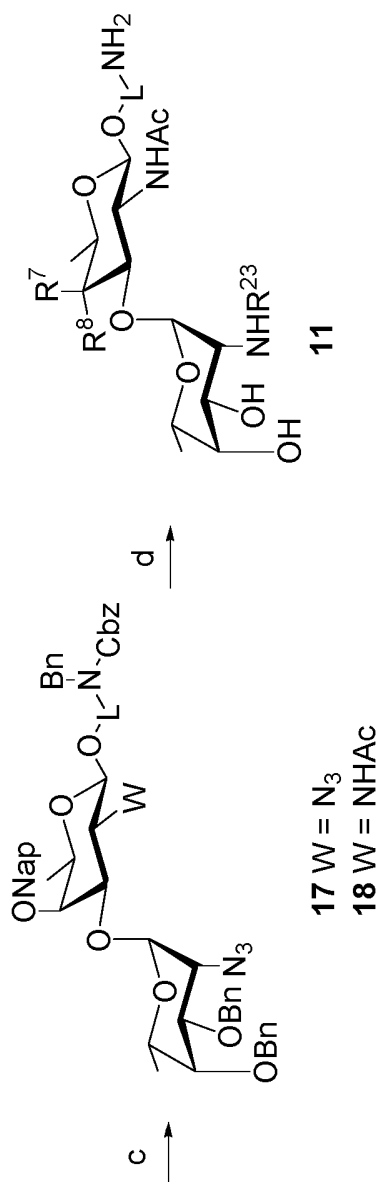
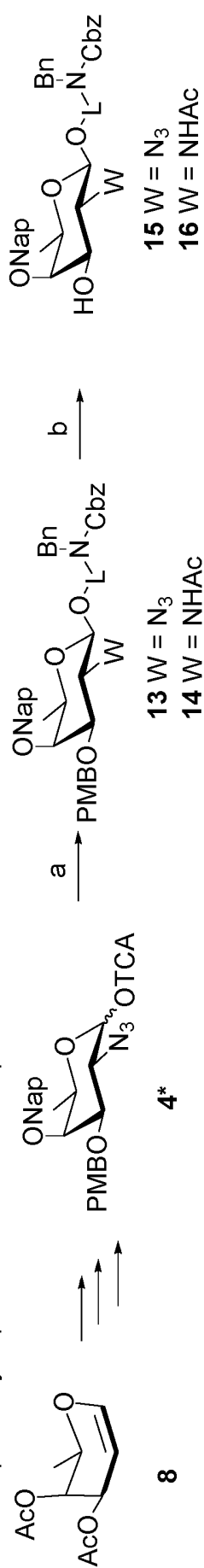

Scheme 3: Synthesis of disaccharides of general formula **11**: **a.** HO-L-NBnCbz, TMSOTf, DCM, 4Å molecular sieves, -15 °C; **b.** CAN, acetone/water; **c.** **1**, TMSOTf, DCM, 4Å molecular sieves, -30 °C to -20 °C; **d.** **1**) installation of the residues R^7 and R^8 ; **2**) deprotection.

To access disaccharide **21** ($R^7 = -OH$ and $R^8 = -H$) compound **17** is treated with thioacetic acid in pyridine so that the azido group is converted to the acetamido group, then the Nap protecting group is removed with DDQ and hydrogenolysis on Pd/C is performed. To provide disaccharide **25** (R^7 and R^8 represent $-OH$ or they form together a $=O$ residue), intermediate alcohol **20** is submitted to an oxidation reaction using Dess-Martin periodinane to provide ketone **22**. Then, the permanent protecting groups on ketone **22** are

removed to provide disaccharide **25** as a ketone (R^7 and R^8 form together a =O residue) or as a hydrated ketone (R^7 and R^8 represent -OH). When required, ketone **22** can be temporarily protected as a dithiane to avoid degradation.

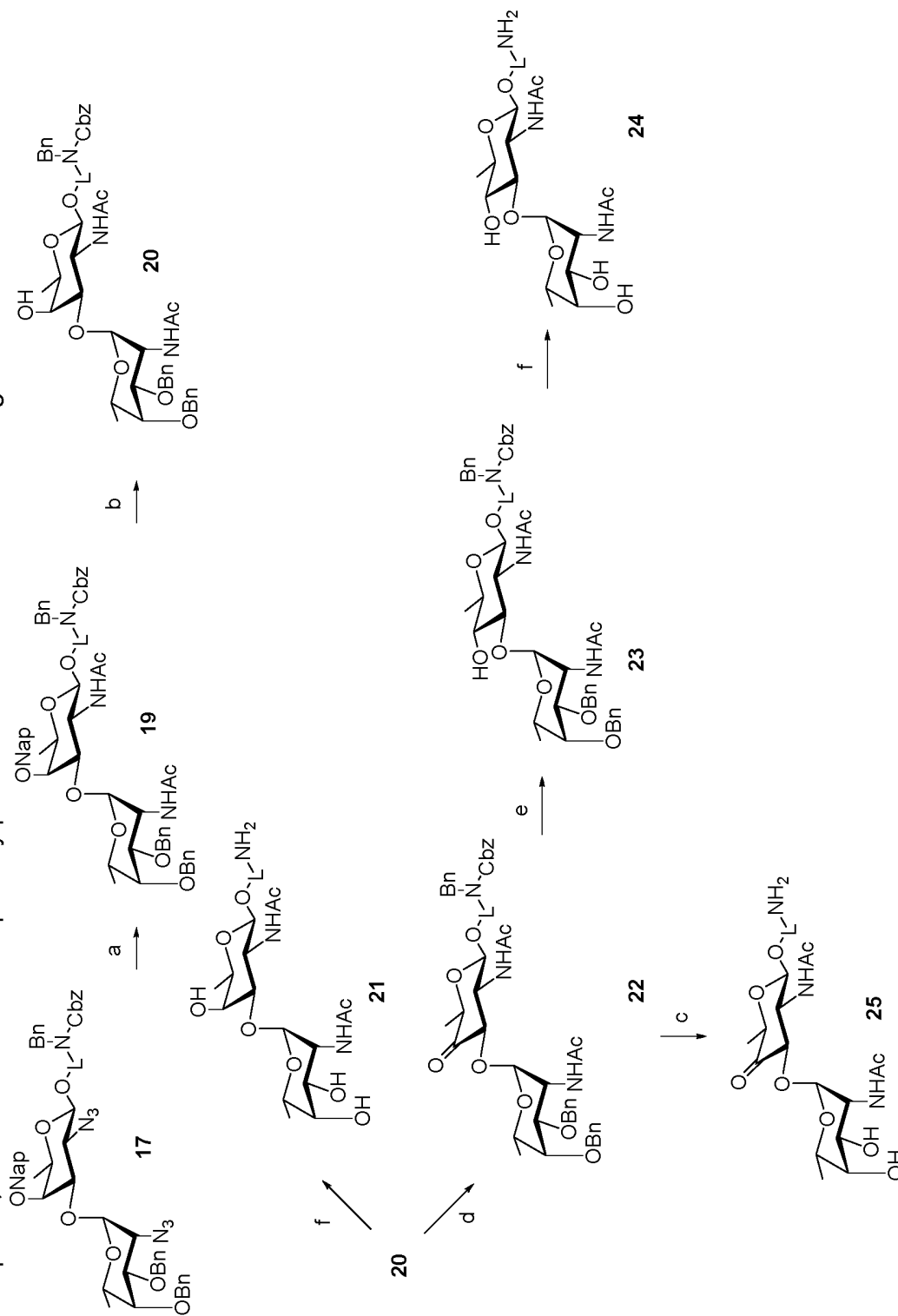

Scheme 4: Installation of the residues R^7 and R^8 : synthesis of disaccharides **21**, **24** and **25**: **a.** AcSH, pyridine; **b.** DDQ, DCM, H_2O , 0 °C to rt; **c.** 1) 1,3-propanedithiol, *p*-TsOH; 2) H_2 , Pd/C, EtOH/EtOAc/ H_2O /AcOH; **d.** Dess-Martin periodinane, DCM; **e.** L-selectride; **f.** H_2 , Pd/C, EtOH/EtOAc/ H_2O /AcOH;

5

Starting from ketone intermediate **22**, disaccharide **24** ($R^7 = -H$ and $R^8 = -OH$) can be easily accessed *via* regioselective reduction of the ketone with L-selectride and subsequent hydrogenolysis using Pd/C as catalyst.

10

The saccharides of general formula **I** with R^1 representing

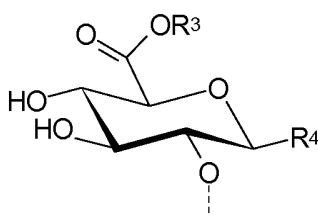

15 and R^4 representing R^6 (disaccharides of general formula **26**) can be assembled following the synthetic route shown in **Scheme 5**.

Union of thioglycoside **10*** with the linker by activation with NIS/TfOH provides monosaccharide **28**. A thioglycoside **10***, which is protected at the 6th position as a benzoyl ester instead of 2-naphthylmethyl ether is also suitable to be used as building block at this level. Removal of the levulinic ester gives alcohol **29** that is further subjected to glycosylation with **8***, resulting in disaccharide **30**. At this level, residue B can be installed on the molecule applying one the reactions mentioned for **Scheme 2**. Subsequently, Nap protecting group is removed with DDQ to provide primary alcohol **31**, which is further oxidized with TEMPO and iodobenzene diacetate to give the carboxylic acid. The carboxylic acid is further subjected to hydrogenolysis using Pd/C as catalyst to give the disaccharides of general formula **26**. To access disaccharides with R^3 being different of $-H$ i.e. R^3 being selected from $-CH_3$, $-C_2H_5$, $-C_3H_7$, $-C_4H_9$ and $-CF_3$, an esterification step should be inserted between step f and step g.

30

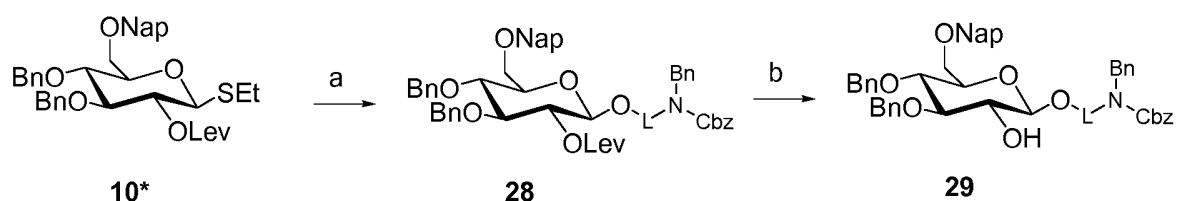

35

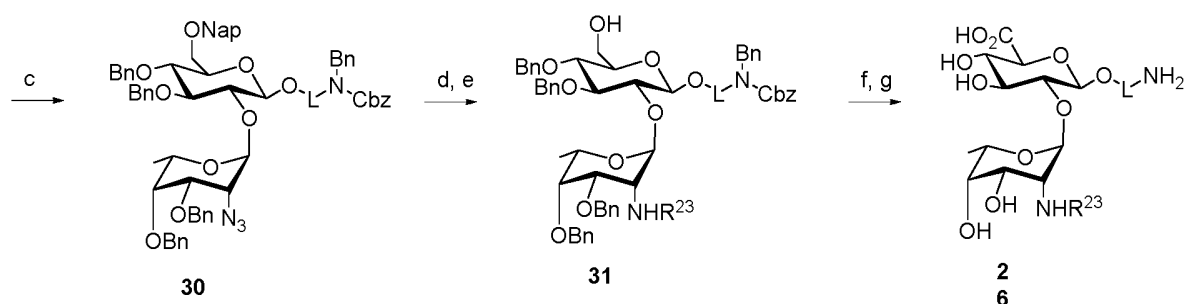

Scheme 5: Synthesis of disaccharides of general formula **26**: **a.** HO–L–NBnCbz, NIS/TfOH, DCM, 4 Å MS, $-30\text{ }^\circ\text{C}$ to $-20\text{ }^\circ\text{C}$; **b.** $N_2H_4 \cdot H_2O$, AcOH/pyridine, DCM; **c.** **8***, TMSOTf, DCM, 4 Å MS, $-30\text{ }^\circ\text{C}$ to $-20\text{ }^\circ\text{C}$; **d.** conversion $-N_3$ residue to $-NHR^{23}$ residue; **e.** DDQ, DCM, phosphate buffer, pH 7.2, $0\text{ }^\circ\text{C}$ to rt; **f.** TEMPO, iodobenzene diacetate, DCM, H_2O , $0\text{ }^\circ\text{C}$ to rt; **g.** H_2 , Pd/C, EtOH/EtOAc/ H_2O /AcOH.

10

The saccharides of general formula (I) with R^1 representing

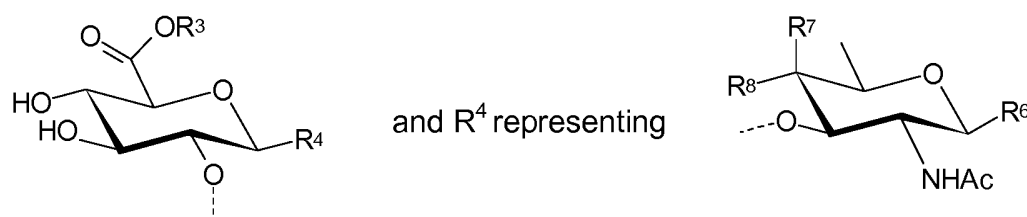

(trisaccharides of general formula **32**) can be assembled following the synthetic route shown in **Scheme 6**.

15

Firstly, building blocks **15** and **16** obtained as previously described are reacted with thioglucoside **10*** (see **Scheme 5**) in presence of an activator such as NIS/TfOH to provide disaccharides **33** and **34**. Removal of the Lev protecting group furnishes secondary alcohols **36** and **37** that are further involved in a glycosidic coupling to give trisaccharides **38** and **39**. Conversion of the $-N_3$ group to corresponding $-NHR^{23}$ residue according to one of the previously described procedure, followed by cleavage of the Nap ether furnishes the diol of general formula **40**. Regioselective oxidation of the primary alcohol with TEMPO and iodobenzene diacetate gives carboxylic acid **41** that can be further converted using the appropriate reaction conditions for installation of the residues R^7 and R^8 (see **Scheme 4**) and hydrogenolysis to trisaccharides of general formula **32**. Optionally, trisaccharides of general formula **32** with R^{23} being $-H$ could be easily accessed starting by subjecting trisaccharide **38** to steps e, f and g.

25

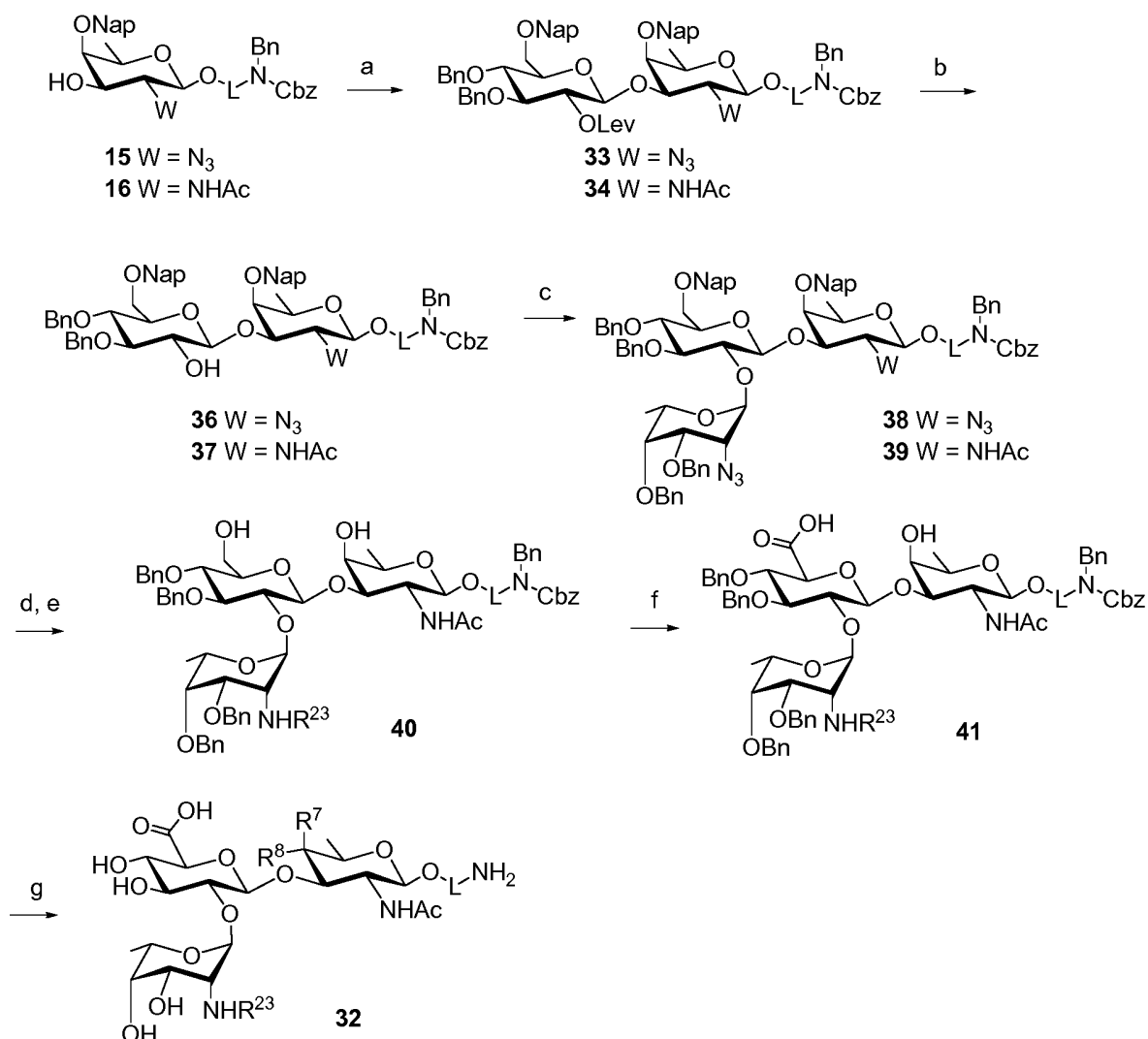

- Scheme 6:** Synthesis of trisaccharides of general formula **32**: **a.** **10***, NIS/TfOH, DCM, 4 Å MS, -20 °C to -10 °C; **b.** N₂H₄·H₂O, AcOH/pyridine, DCM; **c.** **8***, TMSOTf, DCM, 4 Å MS, -30 °C to -20 °C; **d.** conversion -N₃ residue to -NHR²³ residue.; **e.** DDQ, DCM, phosphate buffer, pH 7.2, 0 °C to rt; **f.** TEMPO, iodobenzene diacetate, DCM, H₂O, 0 °C to rt; **g.** **1)** installation of the residues R⁷ and R⁸; **2)** H₂, Pd/C, EtOH/ EtOAc/H₂O/AcOH.

The saccharides of general formula (I), wherein R¹ represents

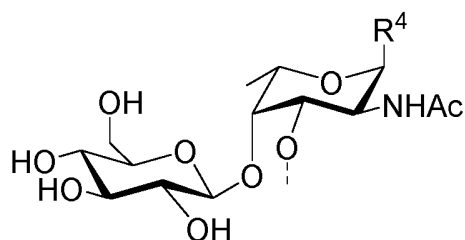

- and R⁴ represents R⁶ i.e. trisaccharides of general formula **42** can be synthesized according to the synthetic route presented in **Scheme 7**. The synthesis commences with the installation of the β-D-glucose residue at the fourth position of the D-fucose. This step is achieved by treatment of the thioglucoside **60*** with L-fucoside **38*** in

presence of NIS/TfOH. Following cleavage of the levulinoyl ester, the free alcohol at the second position of the glucoside is protected as benzyl ether, the thexydimethylsilyl protecting group is removed to provide an intermediate lactol that is further converted to the corresponding trichloroacetimidate **46**. At this level the linker is appended on the molecule by reacting trichloroacetimidate **46** with alcohol **6** in presence of an activator such as TMSOTf. Subsequently, the azido group on intermediate **47** is converted to the corresponding acetamide by treatment with thioacetic acid and pyridine. Removal of the acetate group using Zémpfen conditions frees the secondary alcohol at the second position of the L-fucose furnishing the nucleophile for the next glycosylation reaction. The last sugar moiety is appended by reacting alcohol **49** with trichloroacetimidate **1** in presence of TMSOTf. Conversion of the fully protected trisaccharide to the target trisaccharide **42** includes conversion of the $-N_3$ residue to the $-NHR^{23}$ residue and removal of permanent protective groups following the procedures previously described.

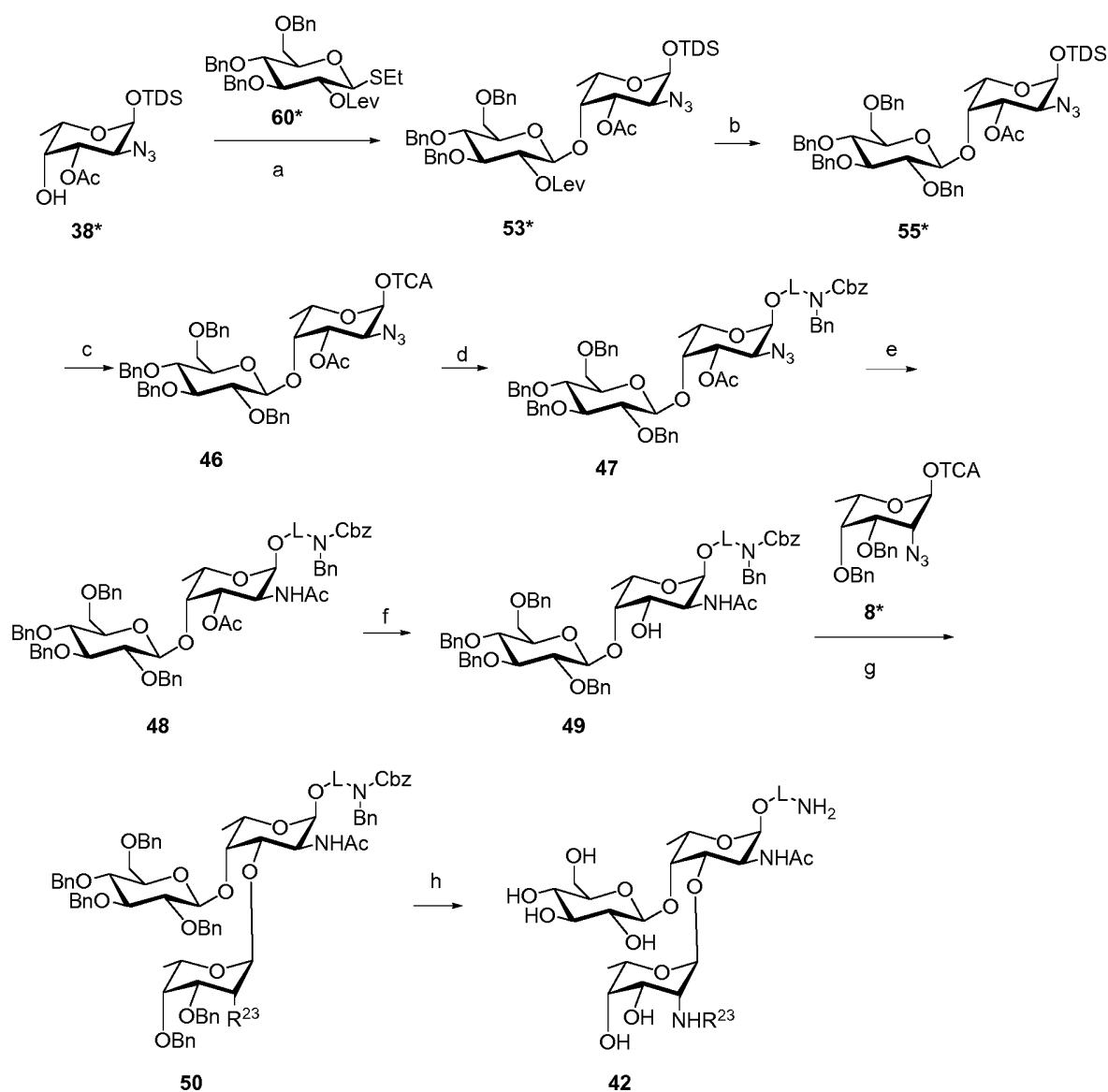

Scheme 7: Synthesis of trisaccharides of general formula **42**: **a.** **60***, NIS/TfOH, DCM, $-30\text{ }^{\circ}\text{C}$; **b.** **1)** $\text{N}_2\text{H}_4\cdot\text{H}_2\text{O}$, AcOH/pyridine, DCM; **2)** BnBr, NaH, DCM:DMF; **c.** **1)** TBAF, AcOH, THF; **2)** CCl_3CN , DBU, DCM; **d.** HO-L-NBnCbz, TMSOTf, DCM; **e.** AcSH/pyridine; **f.** MeONa/MeOH; **g.** **8***, TMSOTf, DCM, 4 \AA MS, $-30\text{ }^{\circ}\text{C}$ to $-20\text{ }^{\circ}\text{C}$; **h.** **1)** conversion $-\text{N}_3$ residue to $-\text{NHR}^{23}$ residue; **2)** deprotection.

The saccharides of general formula (I), wherein R^1 represents

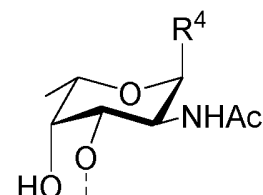

and R^4 represents R^6 i.e. the disaccharides of general formula **57** can be synthesized according to the synthetic route presented in **Scheme 8**. The synthesis starts with the installation of the linker L on the L-fucose residue. This step is accomplished by treatment of imidate **52** with HO-L-NBnCbz in presence of an activator such as TMSOTf. Subsequently, azide **53** is converted to the corresponding acetamide **54** by treatment with thioacetic acid and pyridine. Removal of the acetate groups using Zémpfen conditions provides a diol intermediate that is further reacted with trimethyl orthoacetate and *p*-TsOH and subsequently treated with 80% AcOH to furnish alcohol **54**. Alcohol **54** is further glycosylated with imidate **8*** in presence of an activator to give disaccharide **55** that is further treated with MeONa/MeOH to provide alcohols **56**, respectively. Starting from alcohol **56**, the disaccharide of general formula **57** according to the present invention can be easily accessed following the procedures above described.

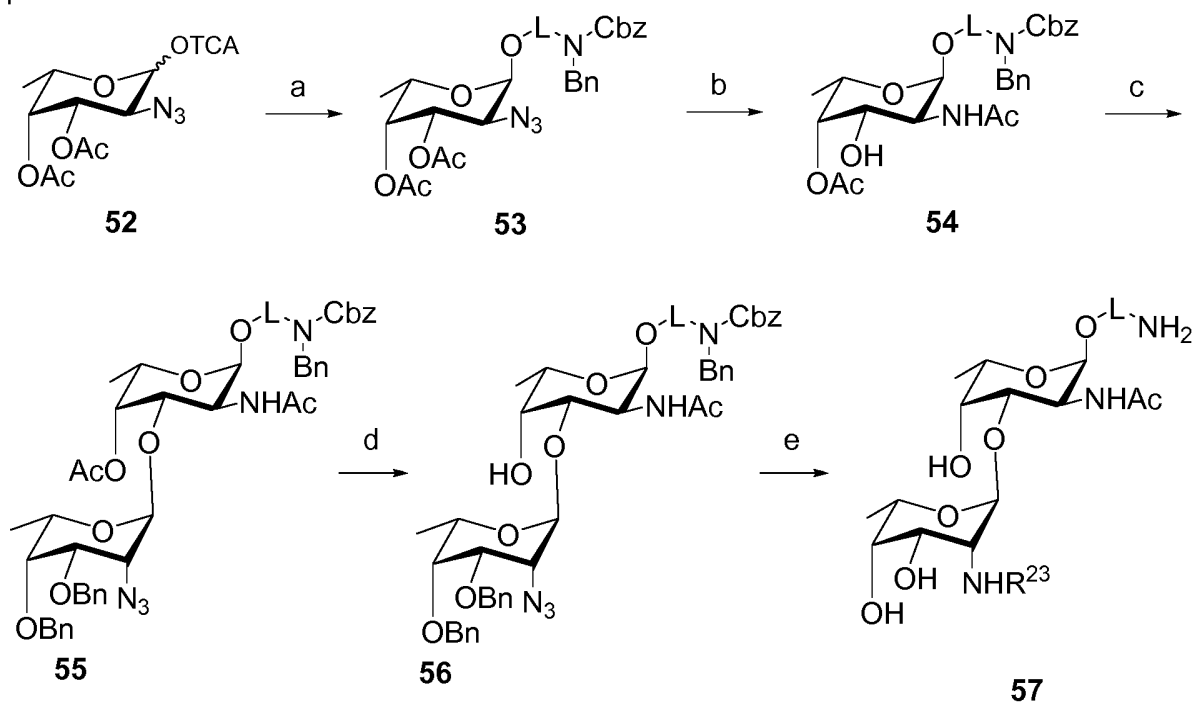

Scheme 8: Synthesis of disaccharide **57**. **a.** HO-L-NBnCbz, TMSOTf, DCM, 4Å MS, -30 °C to -20 °C; **b. 1)** AcSH, pyridine; **2)** MeONa, MeOH; **3)** trimethyl orthoacetate, *p*-TsOH, DMF then 80% AcOH; **c. 8***, TMSOTf, DCM, 4Å MS, -30 °C; **d.** MeONa, MeOH; **e. 1)** conversion -N₃ residue to -NHR²³ residue; **2)** deprotection.

10 A synthetic pathway for accessing the saccharides of general formula (I), wherein R¹ represents

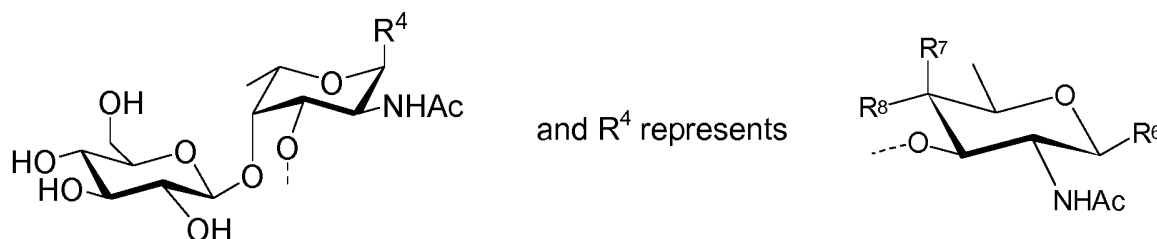

i.e the tetrasaccharides of general formula **61** is shown in **Scheme 9**. The synthesis commences from disaccharide **55*** on which the acetate ester was cleaved to provide alcohol **66**. Glycosylation of alcohol **66** with **8*** provides trisaccharide **58**. Following removal of the thexydimethylsilyl protecting group, the intermediate lactol is converted to the corresponding trichloroacetimidate **59**. The synthesis of fully protected tetrasaccharide is completed by appending the non-reducing end sugar moiety and transformation of the azido groups to the corresponding acetamido groups. Conversion of the protected tetrasaccharide **60** to target tetrasaccharide **61** follows the procedures described above.

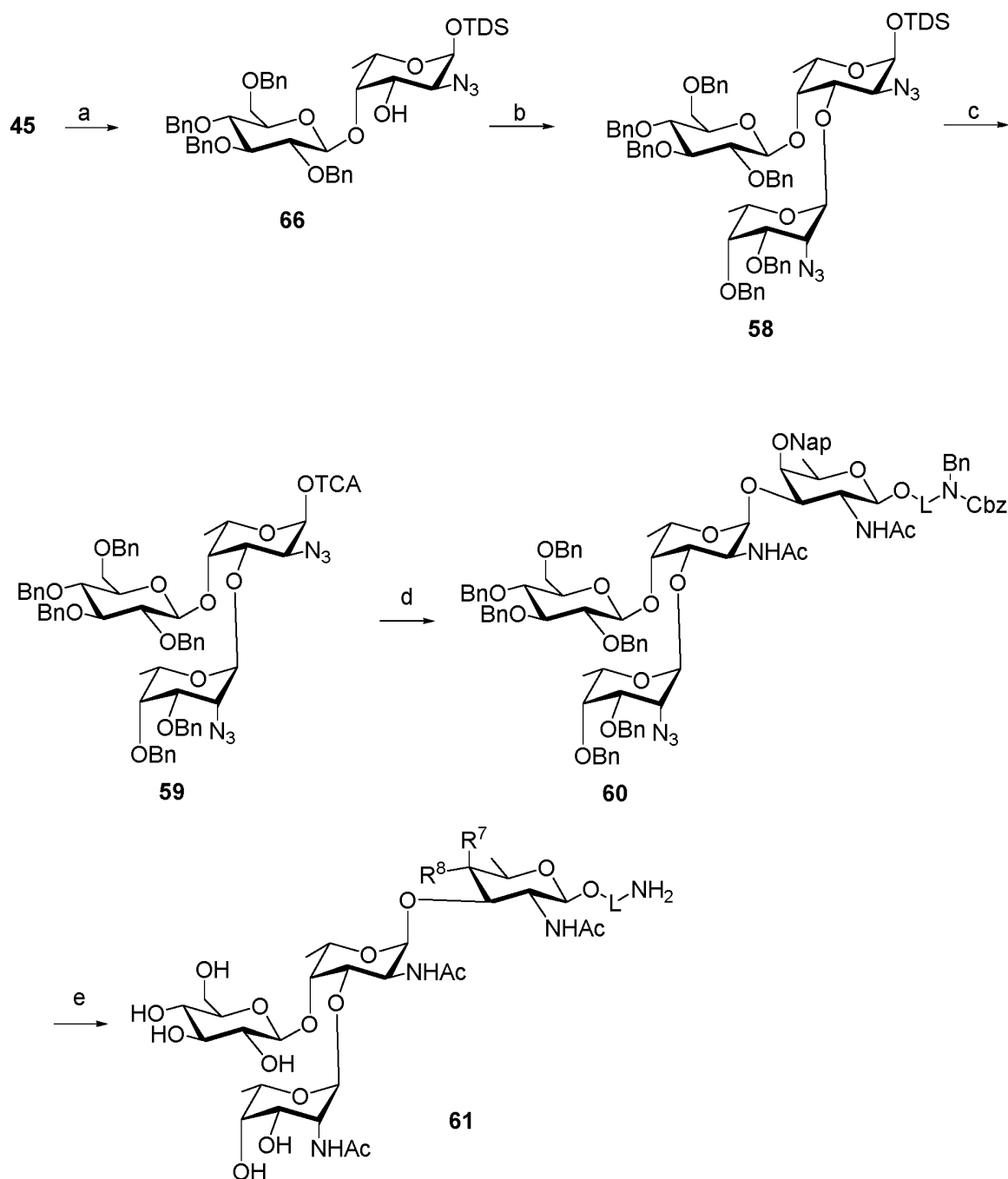

- Scheme 9:** Synthesis of tetrasaccharide **61**: **a.** MeONa/MeOH; **b.** **8***, TMSOTf, DCM; **c.** **1)** TBAF, AcOH, THF; **2)** CCl₃CN, DBU, DCM; **d.** **1)** **15**, TMSOTf, DCM; **2)** AcSH, pyridine; **e.** **1)** installation residues R⁷ and R⁸; **2)** deprotection.

A synthetic route for assessing saccharides of general formula (I), wherein R¹ represents

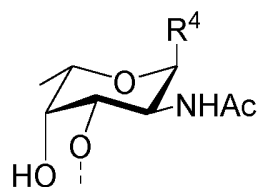

and R⁴ represents

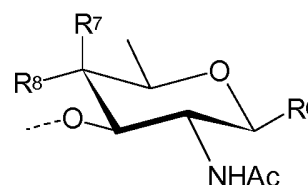

i.e. trisaccharides of general formula **65** is displayed in **Scheme 10**. The synthesis involves reaction of trichloroacetimidate **52** with alcohol **15** to provide disaccharide **62**, which is converted as shown in **Scheme 8**, **step b** to alcohol **63** that is further subjected to glycosylation reaction to furnish fully protected trisaccharide. Conversion of the protected trisaccharide **64** to target trisaccharide **65** follows the procedures described above.

10

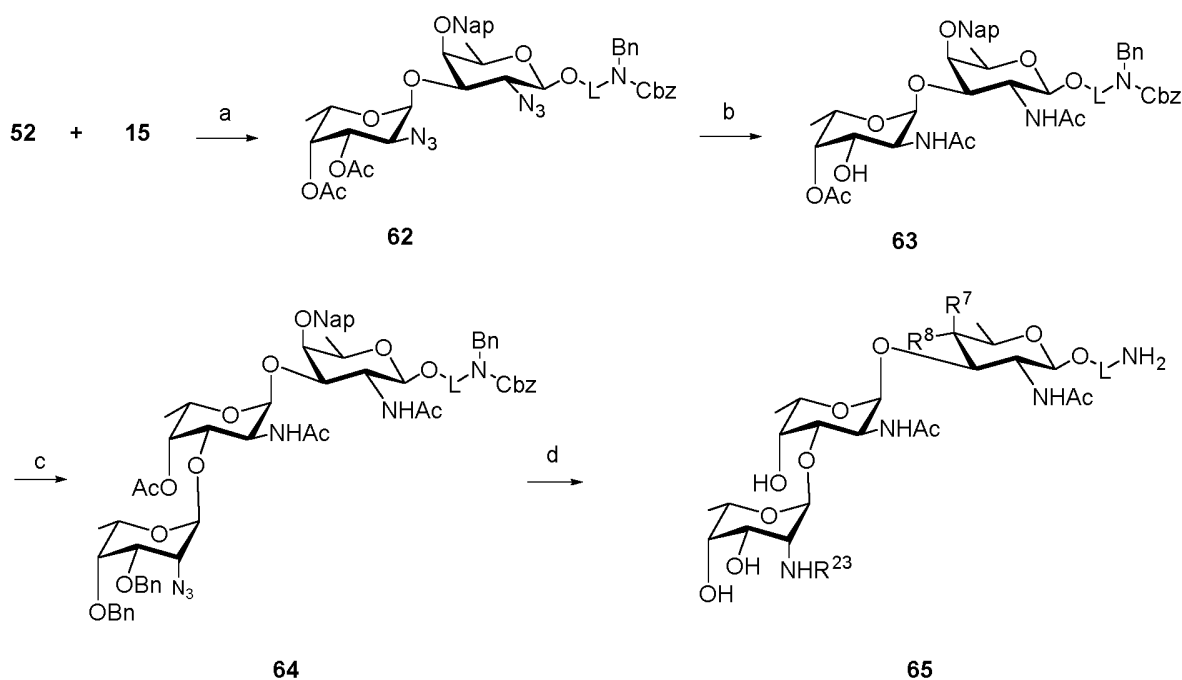

Scheme 10: Synthesis of trisaccharide **65**: **a.** TMSOTf, DCM; **b.** **1)** AcSH, pyridine; **2)** MeONa/MeOH; **3)** trimethyl orthoacetate, *p*-TsOH, DMF then 80% AcOH; **c.** **1)** TMSOTf, DCM; **d.** **1)** conversion -N₃ residue to -NHR²³ residue; **2)** installation residues R⁷ and R⁸; **3)** deprotection.

15

Finally, the saccharides of general formula (I), wherein R¹ represents

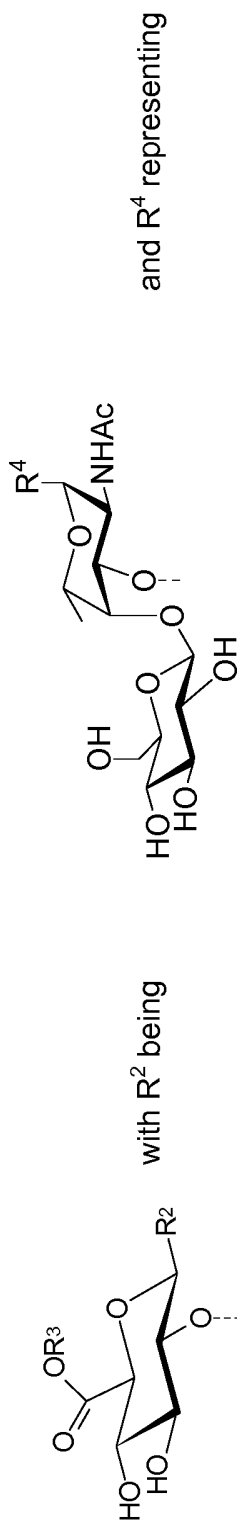

i.e. pentasaccharides of general formula **72** can be obtained according to the synthetic pathway

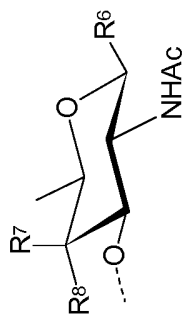

presented in **Scheme 11**. The synthesis proceeds with the cleavage of the acetate on the L-fucose residue to provide alcohol **56*** that is subjected to glycosylation reaction to give trisaccharide **57***. Treatment of trisaccharide **67** with TBAF/AcOH results in the removal of the hexylmethylsilyl protecting group furnishing an intermediate lactol that is further converted to the corresponding trichloroacetimidate **68**. At this level, the reducing-end sugar moiety is appended on the molecule via glycosylation reaction and the levulinyl ester on the glucose residue is cleaved to afford tetrasaccharide **70**. After installing the non-reducing end sugar moiety, fully protected target pentasaccharide **71** is achieved.

The conversion of the fully protected pentasaccharide **71** to the desired pentasaccharide **72** involves:

- 10 - benzoyl removal followed by oxidation of the primary alcohol to the corresponding carboxylic acid;
- conversion of the -N₃ residue to -NHR²³ residue;
- installation of the residues R⁷ and R⁸; and
- deprotection.

50

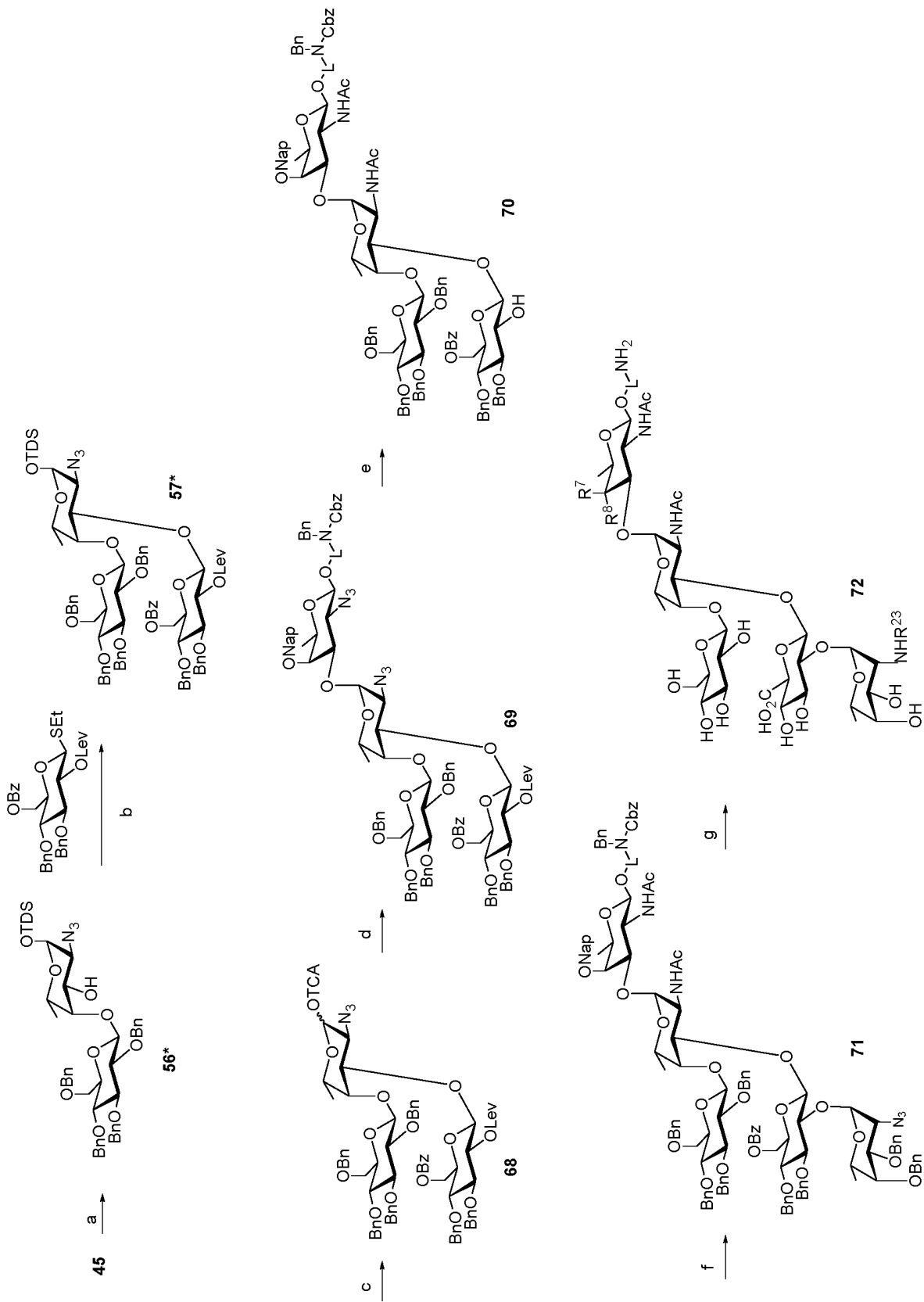

Scheme 11: Synthesis of pentasaccharide **72**:

a. MeONa/MeOH; **b.** NIS/TfOH, DCM; **c.** 1) TBAF, AcOH, THF; 2) CCl₃CN, DBU, DCM; **d.** **15**, TMSOTf, DCM; **e.** 1) AcSH, pyridine; 2) N₂H₄·H₂O, AcOH/pyridine, DCM; **f.** **1**, TMSOTf, DCM; **g.** 1) MeONa/MeOH; 2) TEMPO, iodobenzene diacetate, DCM, H₂O; 3) conversion –N₃ residue to –NHR²³ residue; 4) installation residues R⁷ and R⁸; 5) deprotection.

Alternatively, pentasaccharide **73** can be synthesized by the following synthetic route as shown in Scheme 12.

10

Scheme 12: Synthesis of pentasaccharide **73**:

a. DDQ, DCM/H₂O; **b.** NIS/TfOH, DCM/Tol; **c.** 1) HF·py, DCM/py; 2) CCl₃CNPhCl, Cs₂CO₃, DCM; **d.** TMSOTf, DCM; **e.** N₂H₄·H₂O, AcOH/pyridine/DCM; **f.** **1**, TMSOTf, Tol; **g.** conversion –N₃ residue to –NHR²³ residue.

15

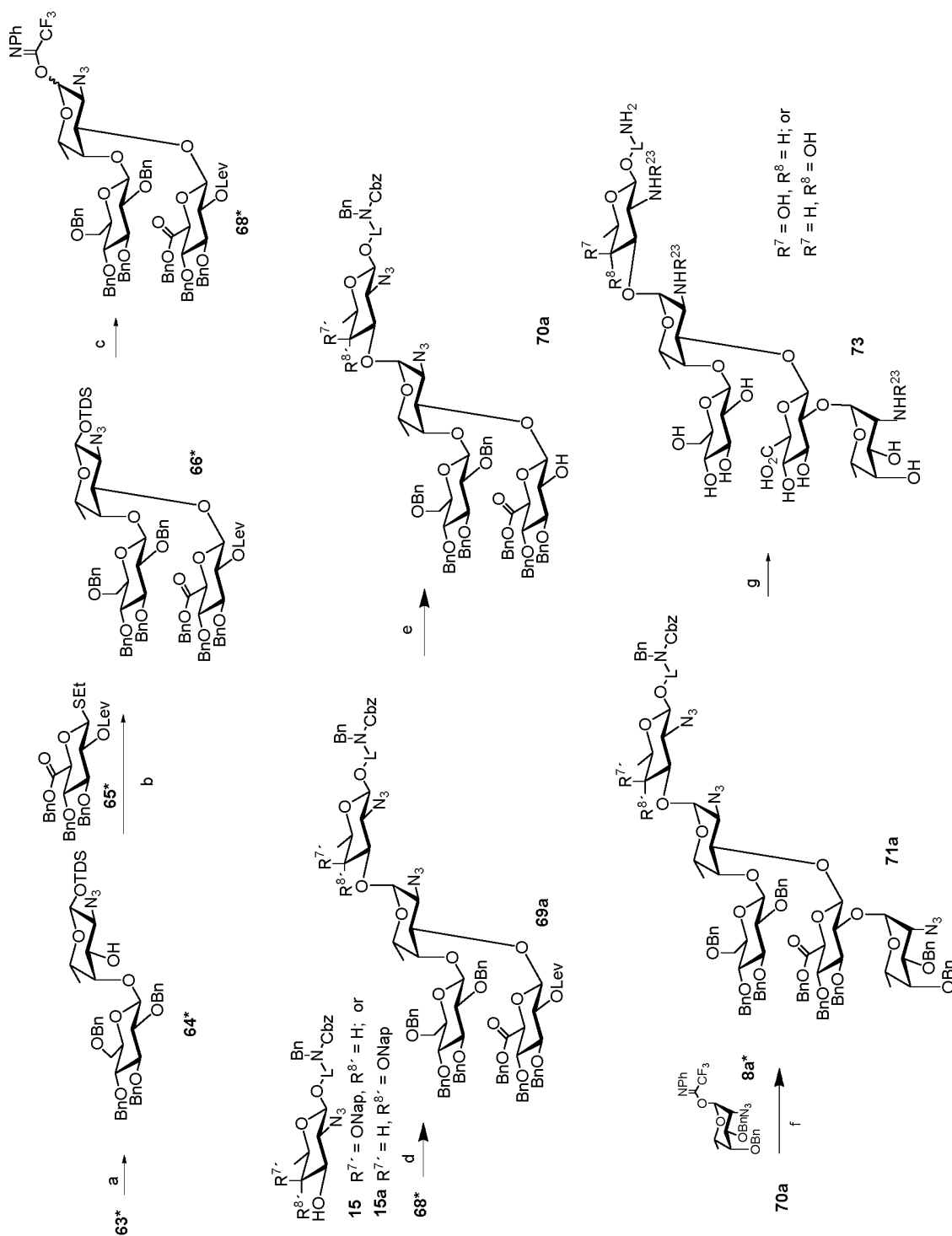

Description of the figures

5 **Figure 1** shows the chemical structure of the *S. pneumoniae* serotype 5 repeating unit.

Figure 2 provides examples of commercially available interconnecting molecules according to the present invention.

10 **Figure 3** provides examples of functional group X of the interconnecting molecule according to the present invention.

Figure 4 shows the results of the glycan array screening of *S. pneumoniae* serotype 5 rabbit typing serum. **A)** Representative well of rabbit typing serum (dilution 1:1000);
15 **B)** Representative well of rabbit typing serum (dilution 1:1000) pre-incubated with SP5 CPS (5µg/mL); **C)** Table listing the positions 1-11 of respective glycans. Samples **14*** and **20*** were impure.

Figure 5 shows the results of the glycan array screening of human pneumococcal
20 CPS vaccine recipients' pooled serum. **A)** Representative well of human pneumococcal serum (dilution 1:100); **B)** Representative well of human pneumococcal serum (dilution 1:100) pre-incubated with SP5 CPS (5µg/mL); **C)** Table listing the positions 1-11 of respective glycans. Samples **14*** and **20*** were impure.

25

Figure 6: **A)** Chemical structure of synthetic SP-5 tetrasaccharide **33***; **B)** Tetrasaccharide **33*** was conjugated with CRM₁₉₇ by PNP based chemistry and resolved on 10% SDS-PAGE along with recombinant CRM₁₉₇ and stained with Coomassie brilliant blue R250. The molecular weight marker is shown in the middle
30 of SDS-PAGE; **C)** The protein amount was estimated using the standard curve plotted with known concentration of BSA (BCA: Bicinchoninic Acid).

Figure 7: A and B : The tetrasaccharide **33*** and pentasaccharide **73*** of ST5 were conjugated with CRM₁₉₇ by PNP based chemistry and resolved on 10% SDS-PAGE
35 along with recombinant CRM₁₉₇ and stained with Coomassie brilliant blue R250 respectively. The molecular weight marker is shown in the extreme left of SDS-PAGE; **C and D:** *Matrix-assisted laser desorption/ionization (MALDI)* analysis was

carried out to measure the average molecular size of ST5 tetrasaccharide **33*** and pentasaccharide **73*** conjugates at pH 8.0 respectively. The recombinant CRM₁₉₇ was used as standard.

5 **Figure 8: Microarray with ST5 type sera**

A) Microarray slide printing pattern. (B) Microarray slide was incubated with rabbit type 5 sera (Statens Serum Institute, Denmark) at dilution 1 in 100. Microarray analysis suggested that type sera recognized synthetic structures along with native CPS -5 polysaccharide. (C) Structure description printed on the slide.

10

Figure 9: Microarray with rabbit anti-ST5 synthetic conjugates serum

(A) Immunization pattern and sera collection (printing pattern are the same in all studies). Rabbit were immunized as prime boost manner at day 0, 14 and 28. Preimmune (day 0) and hyperimmune serum (day 14, 21 and 35) was collected from individual rabbits. (B and D) Microarray slides were incubated with pooled rabbit sera (day 35) raised against tetrasaccharide and pentasaccharide conjugates to the slides. Both group of hyperimmune sera exhibited cross-reactivity with native polysaccharide. (C) Printing pattern of microarray slides.

15

20 **Figure 10: End point titer analysis.**

Immunization with ST5 glycan conjugates induces high antibody titers in rabbits. Three rabbits in each group (female ZIKA rabbits, 10-12 weeks, 2.5-3 kg) were immunized subcutaneously with 3 doses of 10 µg of tetrasaccharide and pentasaccharide conjugate (in alum) at day 0, 14 and 28. The immune response were analyzed and plotted in terms of fold change at every time point (A). The endpoint titer (total IgG) was determined in hyperimmune serum (day 35) from individual rabbit (B). Each bar represents the individual rabbit antibody titer. Antibody titers were plotted as the reciprocal of the highest dilution that gave a reading minus the absorbance value obtained with the preimmune sera (day 0; 1 in 100 dilutions). The antibody response between the groups were also analyzed (C).

25

30

Figure 11: Surface staining of anti-ST5 glycan conjugates with pneumococcal strain. Surface binding of anti-ST5 glycan conjugates sera with serotype 5 strain were analyzed by flow cytometry. The solid grey histogram represents the negative control (bacteria + secondary antibody), dotted black represent the day 0. Black and gray histograms represent the tetrasaccharide and pentasaccharide respectively.

35

Figure 12 Anti-ST5 (tetrasaccharide) antibodies promote the phagocytosis of pneumococci.

Differentiated HL-60 cells were incubated with serotype 5 bacteria pretreated with anti-ST5 (tetrasaccharide) or preimmune sera, and pneumococcal survival was assessed after 45 min. Percent killing of pneumococci was calculated based on viable pneumococcal colonies obtained relative to no sera control. This is the represent values one out of three independent experiments done in triplicates. Values represent mean \pm SE

The following examples are included to demonstrate preferred embodiments of the invention. It should be appreciated by those skilled in the art that the techniques disclosed in the examples, which follow represent techniques discovered by the inventor to function well in the practice of the invention, and thus can be considered to constitute preferred modes for its practice. However, those skilled in the art should, in light of the present disclosure, appreciate that many changes can be made in the specific embodiments, which are disclosed and still obtain a like or similar result without departing from the spirit and scope of the invention.

Further modifications and alternative embodiments of various aspects of the invention will be apparent to those skilled in the art in view of this description. Accordingly, this description is to be construed as illustrative only and is for the purpose of teaching those skilled in the art the general manner of carrying out the invention. It is to be understood that the forms of the invention shown and described herein are to be taken as examples of embodiments. Elements and materials may be substituted for those illustrated and described herein, parts and processes may be reversed, and certain features of the invention may be utilized independently, all as would be apparent to one skilled in the art after having the benefit of this description of the invention. Changes may be made in the elements described herein without departing from the spirit and scope of the invention as described in the following claims.

30

Examples

Chemical synthesis

Abbreviations:

35 NIS: *N*-iodosuccinimide;
TfOH: triflic acid;
h: hour;
DCM: dichloromethane;
TLC: thin layer chromatography;

	rt:	room temperature;
	EtOAc:	ethyl acetate;
	MS:	molecular sieves;
	TMS:	trimethylsilyl;
5	Tempo:	2,2,6,6-tetramethyl-1-piperidinyloxy, free radical;
	BAIB:	[bis(acetoxy)iodo]benzene;
	TMSOTf:	trimethylsilyl triflate;
	TBAF:	tetrabutylammonium fluoride;
	TDS:	dimethylhexylsilyl;
10	DDQ:	2,3-dichloro-5,6-dicyano-1,4-benzoquinone;
	Et ₃ N:	triethylamine;
	DBU:	1,8-diazabicycloundec-7-ene;
	Nap:	2-naphthylmethyl;
	equiv:	equivalents;
15	sat.:	saturated;
	aq.:	aqueous;
	Hex:	hexanes;
	TMSN ₃ :	trimethylsilyl azide;
	PMBCl:	<i>p</i> -methoxybenzyl chloride;
20	THF:	tetrahydrofuran;
	DMAP:	4-dimethylaminopyridine;
	TBAI:	tetrabutylammonium iodide;
	TBAB:	tetrabutylammonium bromide;
	Bu ₂ SnO:	dibutyltin oxide;
25	CAN:	cerium ammonium nitrate;
	BnBr:	benzylbromide;
	BH ₃ .THF:	borane tetrahydrofuran complex;
	DMF:	dimethylformamide;
	UV:	ultraviolet;
30	NMR:	nuclear magnetic resonance;
	MALDI-TOF:	matrix-assisted laser desorption/ionization-time of flight spectrometry;
	HRMS:	high resolution mass spectroscopy;
	ESI:	electrospray ionization;
	MeCN:	acetonitrile;
35	IR:	infrared;
	EDC:	1-ethyl-3-(3-dimethylaminopropyl)carbodiimide;
	Et ₂ O:	diethyl ether;
	NaOMe:	sodium methoxide;
	OTCA:	trichloroacetimidate;

General information for chemical synthesis

Commercial reagents were used without further purification except where noted. Solvents were dried and redistilled prior to use in the usual way. All reactions were performed in oven-dried glassware under an inert atmosphere unless noted otherwise. Analytical thin layer chromatography (TLC) was performed on Kieselgel 60 F254 aluminium plates precoated with a 0.25 mm thickness of silica gel. The TLC plates were visualized with UV light and by staining with Hanessian solution (ceric sulfate and ammonium molybdate in aqueous sulfuric acid) or sulfuric acid-ethanol solution. Column chromatography was performed on Fluka Kieselgel 60 (230-400 mesh). Optical rotations (OR) were measured with a Schmidt & Haensch UniPol L1000 polarimeter at a concentration (c) expressed in g/100 mL. ¹H and ¹³C NMR spectra were measured with a Varian 400-MR or Varian 600 spectrometer with Me₄Si as the internal standard. NMR chemical shifts (δ) were recorded in ppm and coupling constants (*J*) were reported in Hz. High-resolution mass spectra (HRMS) were recorded with an Agilent 6210 ESI-TOF mass spectrometer at the Freie Universität Berlin, Mass Spectrometry Core Facility.

General procedure (A) for removal of the TDS group at the anomeric position.

Anomeric TDS-protected starting material (1.0 equiv) was dissolved in THF (reaction concentration at 0.15 M) and cooled to 0 °C. A solution of TBAF (1 M in THF, 10 equiv) and AcOH (12 equiv) was added, warmed to room temperature and stirred for 3 h. The reaction mixture was diluted with EtOAc, washed with 0.1 N HCl, sat. aq. NaHCO₃ and brine. The organic phases were dried over MgSO₄ and concentrated. Column chromatography on silica gel (hexanes/EtOAc) afforded the corresponding lactol as a mixture of α and β anomers.

General procedure (B) for NIS/TfOH-mediated glycosylation of thio- and selenoglycosides.

The acceptor (1.0 to 2.0 equiv) and thio- or selenoglycoside (1.0 to 1.3 equiv) were co-evaporated with toluene three times and dried *in vacuo*. The residue was dissolved in DCM or MeCN (reaction concentration at 80 to 120 mM) together with freshly activated molecular sieves (4 Å) and NIS (1.2 equiv with regard to the thio- or selenoglycoside). The mixture was cooled and TfOH (0.1 equiv with regard to the thio- or selenoglycoside) was added. The reaction was stirred for 1 h, then quenched by the addition of NEt₃ and diluted with DCM. The organic layer was washed with sat. aq. Na₂S₂O₃ followed by sat. aq. NaHCO₃, dried over MgSO₄ and concentrated. Column chromatography (hexanes/EtOAc) afforded the pure product.

General procedure (C) for glycosyl-trichloroacetimidate synthesis with K₂CO₃.

To a solution of the lactol (1.0 equiv) in DCM (reaction concentration at 0.5 M) trichloroacetonitrile (10 equiv) and K₂CO₃ (1.7 equiv) were added and stirred for 3 h at room temperature. The crude product was concentrated and purified by column chromatography on silica gel (hexanes/EtOAc) to afford pure product.

General procedure (D) for glycosyl-trichloroacetimidate synthesis with DBU.

To a solution of the lactol (1.0 equiv) in DCM (reaction concentration at 0.5 M) at 0 °C trichloroacetonitrile (10 equiv) and DBU (1 drop) were added and stirred for 1 h at 0 °C. The crude product was concentrated and purified by column chromatography on silica gel (hexanes/EtOAc) to afford pure product.

General procedure (E) for TMSOTf-mediated glycosylation of glycosyl-imidates.

The acceptor (1.0 to 2.0 equiv) and glycosyl-trichloroacetimidate (1.0 to 1.3 equiv) were co-evaporated with toluene three times and dried *in vacuo*. The residue was dissolved in DCM (reaction concentration at 80 to 120 mM) and freshly activated molecular sieves (4 Å) were added. The mixture was cooled to -30 °C and TMSOTf (0.1 equiv) was added. The reaction was brought to -20 °C, then quenched by the addition of NEt₃ and concentrated under reduced pressure. Column chromatography (hexanes/EtOAc) afforded the pure product.

General procedure (F) for thioacetic acid based azide reduction.

To a solution of azide starting material in pyridine (1 mL) thioacetic acid (0.5 mL) was added and stirred for 12 to 48 h. The reaction mixture was concentrated and purified by column chromatography on silica gel (hexanes/acetone) to afford the acetamide product.

General procedure (G) for removal of the Nap protecting group.

To a mixture of naphthylated starting material (1 equiv) in a mixture of DCM/phosphate-buffer (10:1 (v:v), 7 mM, pH 7.2, reaction concentration at 4 mM or DCM/H₂O (10:1) at 0° C DDQ (2–3 equiv) was added portionwise over 1.5 h. The reaction mixture was warmed to room temperature and stirred for further 1.5 to 5 h. The mixture was diluted with sat. aq. NaHCO₃ solution, extracted with DCM and the organic layer dried over MgSO₄ and concentrated. Column chromatography on silica gel (hexanes/EtOAc) afforded the pure product.

General procedure (H) for TEMPO-mediated oxidation.

To a mixture of the primary alcohol (1.0 equiv) in DCM/H₂O ((2.5:1, v:v), reaction concentration at 7 mM) at 0 °C was added TEMPO (0.2 equiv) and BAIB (5.0 equiv).

The reaction mixture was warmed to room temperature, stirred for 2 h and then diluted with H₂O and extracted with DCM. The organic phases were dried over Na₂SO₄ and concentrated. Size exclusion chromatography on Sephadex LH-20 (CHCl₃/MeOH = 1:1) afforded the product.

5

General procedure (I) for hydrogenolysis.

A solution of starting material (reaction concentration at 4 to 8 mM) in a mixture of EtOH/EtOAc/H₂O/AcOH was purged with Ar. After that 10% Pd/C was added and the solution purged with H₂ for 10 min, then stirred under an H₂ atmosphere for 12 h, filtered and concentrated. The crude product was dissolved in H₂O, subjected to reversed phase solid phase extraction (RP SPE) (Waters Sep-Pak[®], C18) and lyophilized. When necessary, size exclusion chromatography on Sephadex LH-20 (MeOH) was performed.

15 Example 1: Synthesis of phenyl 2-azido-2-deoxy-1-seleno- α -D-fucopyranoside (**1***)



To a solution of the fucal (Bedini, E. *et. al. Synlett* 2006, 6, 825-830) (4.6 g, 21.6 mmol) and Ph₂Se₂ (6.75 g, 21.6 mmol) in DCM (70 mL) at -30 °C was added PhI(OAc)₂ (6.96 g, 21.6 mmol). Then, TMSN₃ (5.74 mL, 43.2 mmol) was added dropwise to the resulting solution. The reaction was warmed to -10 °C. After 4 h at -10 °C the reaction was complete. The reaction mixture was allowed to warm to room temperature and washed with NaHCO₃ saturated solution followed by brine. The solvent was evaporated and the impure was dissolved in MeOH (190 mL). NaOMe 0.5 M (4.75 mmol, 9.5 mL) solution was added dropwise to the mixture at room temperature. The reaction was stirred at room temperature for 1h. Amberlite was added and let stir until the pH decreased to 5. The reaction mixture was filtered and the solvent evaporated. The residue was purified by silica-gel chromatography (DCM 100% to DCM:MeOH:Acetone 97:1.5:1.5). The yellow solid obtained was washed with hexanes to give diol **1*** as a white solid (4.24 g, 12.9 mmol, 60% yield). [α]_D²⁰ = 241.6° (c = 1.00, CHCl₃); IR ν_{max} (film) 3321, 2925, 2105, 1578, 1475, 1438, 1093, 1059, 739 cm⁻¹; ¹H NMR (400 MHz, CD₃OD) δ 7.71 – 7.47 (m, 2H), 7.35 – 7.09 (m, 3H), 5.90 (d, J = 5.4 Hz, 1H), 4.28 (q, J = 6.6 Hz, 1H), 4.00 (dd, J = 9.9, 5.3 Hz, 1H), 3.70 (ddd, J = 6.6, 4.5, 2.2 Hz, 2H), 1.13 (d, J = 6.5 Hz, 3H). ¹³C NMR (101 MHz, CD₃OD) δ 134.5, 128.6, 127.3, 85.5, 71.5, 71.3, 69.2, 61.5, 15.0. HRMS (ESI+) Calcd for C₁₂H₁₅O₃N₃SeNa⁺ [M+Na]⁺ 352.0171, found 352.0179.

35

Example 2: Synthesis of phenyl 2-azido-2-deoxy-3-O-*p*-methoxybenzyl-1-seleno- α -D-fucopyranoside (**2***)

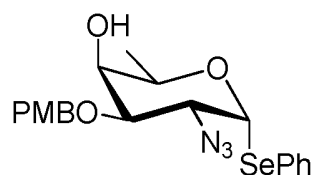

5 Diol **2*** (2.5 g, 7.62 mmol) was co-evaporated with dry toluene twice and let dry under high vacuum for 30 min. Then, dry toluene (80 mL) was added, followed by Bu_2SnO (2.84 g, 11.43 mmol) and 4 Å MS. The reaction was stirred for 1 hour under reflux. The reaction was cooled to 40 °C; PMBCl (3.11 mL, 22.85 mmol) and TBAB (3.68 g, 11.43 mmol) were added and left stir overnight at rt. In the morning the reaction was
 10 complete. The reaction was filtered and the solvent evaporated. The residue was purified by silica-gel chromatography (EtOAc in Hex 10 to 20%). Alcohol **2*** was obtained as a yellow oil (3.09 g, 6.89 mmol, 90%). $[\alpha]_D^{20} = +177.4^\circ$ ($c = 0.77$, CHCl_3); IR ν_{max} (film) 3493, 2935, 2111, 1613, 1514, 1249, 1091, 740 cm^{-1} ; $^1\text{H NMR}$ (400 MHz, CDCl_3) δ 7.79 – 7.47 (m, 2H), 7.41 – 7.12 (m, 5H), 6.92 (d, $J = 8.7$ Hz, 2H),
 15 5.88 (d, $J = 5.4$ Hz, 1H), 4.69 (d, $J = 11.0$ Hz, 1H), 4.63 (d, $J = 11.0$ Hz, 1H), 4.29 (q, $J = 6.5$ Hz, 1H), 4.15 (dd, $J = 10.2, 5.3$ Hz, 1H), 3.89 – 3.84 (m, 1H), 3.82 (s, 3H), 3.69 (dd, $J = 10.2, 3.1$ Hz, 1H), 2.36 (s, 1H), 1.26 (d, $J = 6.6$ Hz, 3H). $^{13}\text{C NMR}$ (101 MHz, CDCl_3) δ 159.7, 134.4, 129.8, 129.1, 129.0, 128.5, 127.8, 114.1, 85.2, 78.9, 71.8, 68.6, 68.5, 60.1, 55.3, 16.1. HRMS (ESI+) Calcd for $\text{C}_{20}\text{H}_{23}\text{O}_4\text{N}_3\text{SeNa}^+$ $[\text{M}+\text{Na}]^+$
 20 472.0746, found 472.0755.

Example 3: Synthesis of phenyl 2-azido-2-deoxy-3-O-*p*-methoxybenzyl-4-O-(2-naphthalenylmethyl)-1-seleno- α -D-fucopyranoside - 2-(bromomethyl)-naphthalene (**3***)

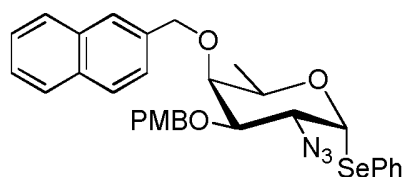

25 2-(bromomethyl)-naphthalene (2.8 g, 12.67 mmol) was added to a solution of alcohol **2*** (2.84 g, 6.33 mmol) in DMF:THF (1:1, 64 mL). Then, the mixture was cooled to 0 °C and NaH 60% (304 mg, 7.60 mmol) was added. The reaction was warmed to room temperature and let stir for 1h. The reaction was not completed. Then, it was
 30 cooled to 0 °C again and 100 mg of NaH were added. In 1h the reaction was completed. The reaction mixture was cooled to 0 °C, MeOH was added and the reaction warmed to room temperature. The reaction mixture was diluted with ether, washed with HCl, NaHCO_3 and brine. The solvent was evaporated and the residue

purified by silica-gel chromatography (EtOAc in Hex 5 to 10%). Product **3*** was obtained as a colorless oil (2.56 g, 4.35 mmol, 69%). $[\alpha]_D^{20} = 151.28^\circ$ ($c = 2.00$, CHCl_3); IR ν_{max} (film) 2896, 2109, 1612, 1513, 1249, 1101, 1065, 820, 740 cm^{-1} ; ^1H NMR (400 MHz, CDCl_3) δ 7.94 – 7.75 (m, 3H), 7.71 (s, 1H), 7.63 – 7.53 (m, 2H), 7.52 – 7.42 (m, 3H), 7.40 – 7.31 (m, 2H), 7.29 – 7.20 (m, 3H), 7.00 – 6.84 (m, 2H), 5.94 (d, $J = 5.2$ Hz, 1H), 5.09 (d, $J = 11.7$ Hz, 1H), 4.78 (d, $J = 11.7$ Hz, 1H), 4.74 (d, $J = 11.1$ Hz, 1H), 4.70 (d, $J = 11.1$ Hz, 1H), 4.48 – 4.30 (m, 1H), 4.22 (q, $J = 6.5$ Hz, 1H), 3.84 (s, 1H), 3.77 – 3.66 (m, 1H), 1.13 (d, $J = 6.5$ Hz, 3H). ^{13}C NMR (101 MHz, CDCl_3) δ 159.5, 135.6, 134.3, 133.1, 133.0, 129.6, 129.0, 128.7, 128.1, 127.9, 127.7, 127.6, 126.9, 126.3, 126.1, 125.9, 114.0, 85.6, 80.4, 75.7, 74.9, 72.4, 69.4, 60.9, 55.3, 16.6. HRMS (ESI+) Calcd for $\text{C}_{31}\text{H}_{31}\text{O}_4\text{N}_3\text{SeNa}^+$ $[\text{M}+\text{Na}]^+$ 612.1373, found 612.1371.

Example 4: Synthesis of 2-azido-2-deoxy-3-O-*p*-methoxybenzyl-4-O-(2-naphthalenylmethyl)- α,β -D-fucopyranosyl trichloroacetimidate (**4***)

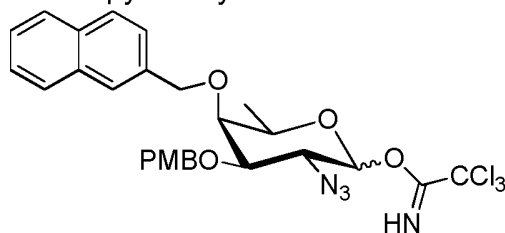

Selenide compound **3*** (730 mg, 1.24 mmol) was dissolved in THF:H₂O (1.7:1, 38 mL) and NIS (558 mg, 2.48 mmol) added. The reaction was stirred at room temperature for 2h and quenched with NaS₂O₃. Then, the reaction mixture was diluted with CH₂Cl₂ and washed with NaHCO₃ and brine. The solvent was evaporated and the residue purified by silica-gel chromatography (EtOAc in Hex 20%). A colorless oil was obtained in 94% yield (524 mg, 1.17 mmol). The product was dissolved in DCM (12 mL) and cooled to 0 °C. Trichloroacetonitrile (1.16 mL, 11.57 mmol) and DBU (0.012 mmol, 2 μ L) were added. After 1h stirring at 0 °C the reaction was not complete. Then, trichloroacetonitrile (1 mL) was added. One hour later the reaction was complete. The solvent was evaporated and the residue purified by silica-gel chromatography (EtOAc in Hex 20%). Trichloroacetimidate **4*** was obtained as mixture of alpha and beta anomers ($\alpha:\beta$, 1:3) in quantitative yield (700 mg, 1.18 mmol). Characterization is given for the beta anomer. $[\alpha]_D^{20} = -8.69^\circ$ ($c = 1.99$, CHCl_3); IR ν_{max} (film) 2934, 2113, 1675, 1513, 1059, 821, 796 cm^{-1} ; ^1H NMR (400 MHz, CDCl_3) δ 8.63 (s, 1H), 7.98 – 7.78 (m, 3H), 7.73 (s, 1H), 7.59 – 7.43 (m, 3H), 7.34 (d, $J = 8.7$ Hz, 2H), 6.92 (d, $J = 8.7$ Hz, 2H), 5.53 (d, $J = 8.5$ Hz, 1H), 5.10 (d, $J = 11.8$ Hz, 1H), 4.86 (d, $J = 11.8$ Hz, 1H), 4.70 (s, 2H), 4.07 (dd, $J = 10.2, 8.6$ Hz, 1H), 3.83 (s, 3H), 3.68 – 3.52 (m, 2H), 3.45 (dd, $J = 10.3, 2.7$ Hz, 1H), 1.23 (d, $J = 6.4$ Hz, 3H). ^{13}C NMR (101 MHz, CDCl_3) δ 161.5, 159.5, 135.4, 133.1, 133.0,

129.6, 129.5, 128.1, 127.9, 127.7, 127.4, 126.6, 126.1, 126.0, 114.0, 97.2, 92.5, 80.7, 74.8, 74.5, 72.6, 71.9, 62.5, 55.3, 29.7, 16.9. HRMS (ESI+) Calcd for $C_{27}H_{27}O_4N_4Cl_3Na^+$ $[M+Na]^+$ 617.0912, found 617.0930.

- 5 **Example 5:** Synthesis of *N*-(benzyl)benzyloxycarbonyl-5-amino-pentanyl 2-azido-2-deoxy-3-*O*-*p*-methoxybenzyl-4-*O*-(2-naphthalenylmethyl)- β -D-fucopyranoside (**5***)

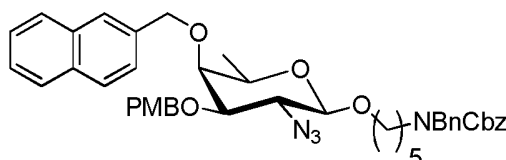

- 10 Imidate **4*** (538 mg, 0.91 mmol) and the linker *N*-(benzyl)benzyloxycarbonyl-5-amino-1-pentanol (593 mg, 1.8 mmol) were co-evaporated with dry toluene and dried in high vacuum. The residue was dissolved in acetonitrile and cooled to -15 °C. TMSOTf (16 μ L, 0.09 mmol) was added and the reaction was stirred for 1h. The reaction was quenched with triethylamine and the solvent evaporated. The residue was purified by silica-gel chromatography (EtOAc in Hex 15 to 20%) to give monosaccharide **5*** as a colorless oil in 74% yield (510 mg, 0.672 mmol). $[\alpha]_D^{20} = -21.34^\circ$ (c = 2.10, $CHCl_3$); IR ν_{max} (film) 2935, 2110, 1697, 1513, 1248, 1068, 819, 699 cm^{-1} ; 1H NMR (400 MHz, $CDCl_3$) δ 7.90 – 7.77 (m, 3H), 7.72 (s, 1H), 7.58 – 7.43 (m, 3H), 7.38 – 7.14 (m, 12H), 6.91 (d, $J = 8.6$ Hz, 2H), 5.18 (d, $J = 12.1$ Hz, 1H), 5.07 (d, $J = 11.9$ Hz, 1H), 4.84 (d, $J = 11.9$ Hz, 1H), 4.73 – 4.60 (m, 1H), 4.50 (d, $J = 7.6$ Hz, 1H), 4.14 (t, $J = 8.7$ Hz, 1H), 3.93 – 3.71 (m, 2H), 3.53 (d, $J = 2.4$ Hz, 1H), 3.44 – 3.35 (m, 1H), 3.32 – 3.15 (m, 1H), 1.66 – 1.47 (m, 1H), 1.41 – 1.26 (m, 1H), 1.19 (d, $J = 6.4$ Hz, 1H). ^{13}C NMR (101 MHz, $CDCl_3$) δ 137.9, 135.7, 133.1, 133.0, 129.8, 129.5, 128.5, 128.5, 128.0, 127.9, 127.8, 127.7, 127.2, 126.7, 126.0, 125.9, 113.9, 102.3, 80.7, 74.7, 74.6, 72.5, 70.5, 69.6, 67.1, 63.1, 55.3, 50.5, 50.2, 47.1, 46.2, 29.2, 27.9, 27.5, 23.2, 17.0.
- 25 HRMS (ESI+) Calcd for $C_{45}H_{50}O_7N_4Na^+$ $[M+Na]^+$ 781.3577, found 781.3590.

- Example 6:** Synthesis of *N*-(benzyl)benzyloxycarbonyl-5-amino-pentanyl 2-azido-2-deoxy-4-*O*-(2-naphthalenylmethyl)- β -D-fucopyranoside (**6***)

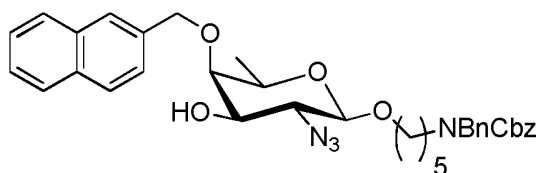

30

PMB protected compound **5*** (510 mg) was dissolved in acetone (10 mL) and H_2O (1.1mL), then 700 mg of CAN was added (solid). After that, a solution of CAN (700 mg) in acetone (1.7 mL) and H_2O (0.2 mL) was added over 70 min. After 10 min the

reaction was poured in NaHCO_3 and extracted with CH_2Cl_2 . The solvent was evaporated and the residue purified by silica-gel chromatography (EtOAc in Hex 20%). Alcohol **6*** was obtained as a yellow oil in 73% yield (315 mg, 0.493 mmol). $[\alpha]_{\text{D}}^{20} = -1.73^\circ$ ($c = 2.18$, CHCl_3); IR ν_{max} (film) 3440, 3031, 2935, 2109, 1694, 1068, 698 cm^{-1} ; ^1H NMR (400 MHz, CDCl_3) δ 7.89 – 7.74 (m, 4H), 7.62 – 7.43 (m, 3H), 7.41 – 7.21 (m, 9H), 7.17 (d, $J = 6.9$ Hz, 1H), 5.18 (d, $J = 13.1$ Hz, 2H), 4.97 (d, $J = 11.8$ Hz, 1H), 4.90 (d, $J = 11.8$ Hz, 1H), 4.50 (d, $J = 8.7$ Hz, 2H), 4.18 (t, $J = 8.6$ Hz, 1H), 3.95 – 3.80 (m, 1H), 3.64 – 3.37 (m, 5H), 3.23 (m, 2H), 2.31 (s, 1H), 1.69 – 1.46 (m, 4H), 1.43 – 1.18 (m, 2H), 1.31 (d, $J = 6.5$ Hz, 3H). ^{13}C NMR (101 MHz, CDCl_3) δ 137.9, 135.3, 133.2, 133.1, 128.5, 128.4, 128.0, 127.9, 127.8, 127.7, 127.2, 127.1, 126.2, 126.1, 126.1, 102.2, 78.2, 75.9, 73.0, 70.8, 69.7, 67.1, 64.7, 50.5, 50.2, 47.1, 46.2, 29.2, 27.9, 27.4, 23.2, 17.0. HRMS (ESI+) Calcd for $\text{C}_{37}\text{H}_{42}\text{O}_6\text{N}_4\text{Na}^+$ $[\text{M}+\text{Na}]^+$ 661.3002, found 661.3015.

- 15 **Example 7:** Synthesis of phenyl 2-azido-3,4-di-O-benzyl-2-deoxy-1-seleno- β -L-pneumopyranoside (**7***)

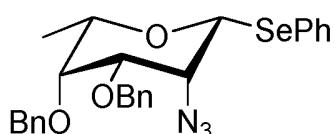

- To an impure mixture containing approx. 25% of 2-azido-2-deoxy-1-seleno- β -L-pneumopyranoside (192 mg) in DMF (5 mL) at 0 °C, BnBr (0.21 mL, 1.8 mmol) and NaH (31 mg, 1.3 mmol) were added. After 3 h the reaction was quenched with MeOH at 0 °C and diluted with Et_2O . The organic layer was washed with 0.1 M aq. HCl solution, sat. aq. NaHCO_3 and brine. The organic layers were dried over MgSO_4 and concentrated. Column chromatography on silica gel (hexanes/ethyl acetate) afforded **7*** (66 mg, 0.13 mmol, 22%). $[\alpha]_{\text{D}}^{20} = -72.2^\circ$ ($c = 1.6$, CHCl_3); IR ν_{max} (film) 3062, 3031, 2933, 2869, 2106, 1578, 1496, 1477, 1454, 1438, 1361, 1279, 1202, 1162, 1105, 1067 cm^{-1} ; ^1H -NMR (400 MHz, CDCl_3) δ 7.58 – 7.23 (m, 15H), 5.80 (d, $J=1.5$, 1H), 5.02 ($J=11.8$, 1H), 4.81 – 4.64 (m, 3H), 4.24 – 4.10 (m, 2H), 3.99 – 3.90 (m, 1H), 3.71 – 3.66 (m, 1H), 1.24 (d, $J=6.5$, 3H); ^{13}C -NMR (100 MHz, CDCl_3) δ 138.4, 137.4, 133.9, 129.4, 129.1, 128.8, 128.6, 128.3, 128.2, 128.0, 127.8, 127.7, 83.9, 77.5, 75.4, 75.0, 71.4, 70.6, 60.0, 16.7; HRMS (ESI): Calcd for $\text{C}_{26}\text{H}_{27}\text{N}_3\text{O}_3\text{SeNa}^+$ $[\text{M}+\text{Na}]^+$ 532.1115, found 532.1112.

Example 8: Synthesis of 2-azido-3,4-di-O-benzyl-2-deoxy- α -L-pneumopyranosyl trichloroacetimidate (**8***)

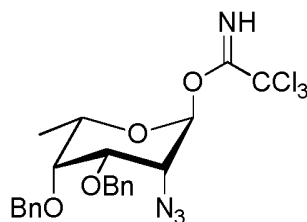

To a solution of **7*** (30 mg, 59 μmol) in THF (1.25 mL) and H_2O (0.75 mL) was added NIS (27 mg, 180 μmol) and stirred for 2 h. The reaction was diluted with DCM and the organic layer washed with sat. aq. $\text{Na}_2\text{S}_2\text{O}_3$ followed by sat. aq. NaHCO_3 , dried over MgSO_4 and concentrated. Column chromatography (hexanes/EtOAc) afforded the free lactol (20 mg, 54 μmol , 92%) as a mixture of α and β anomers. IR ν_{max} (film) 3413, 3031, 2872, 2110, 1496, 1454, 1360, 1306, 1176, 1109, 1053, 1027 cm^{-1} ; $^1\text{H-NMR}$ (400 MHz, CDCl_3) δ 7.59 – 7.20 (m, 10H), 5.20 (d, $J = 1.6$ Hz, 0.5H), 4.99 (d, $J = 11.7$ Hz, 1H), 4.81 – 4.64 (m, 3H), 4.56 (d, $J = 1.8$ Hz, 0.5H), 4.02 (t, $J = 3.4$ Hz, 1H), 3.67 (t, $J = 3.4$ Hz, 0.5H), 3.65 – 3.63 (m, 0.5H), 3.60 – 3.55 (m, 0.5H), 3.44 (qd, $J = 6.3, 1.1$ Hz, 0.5H), 1.26 (d, $J = 6.4$ Hz, 1.5H), 1.23 (d, $J = 6.6$ Hz, 1.5H); $^{13}\text{C-NMR}$ (100 MHz, CDCl_3) δ 138.4, 138.1, 137.8, 137.3, 129.0, 128.8 (2C), 128.6, 128.4, 128.3, 128.2, 127.9, 127.7, 127.5, 127.4, 93.6, 93.2, 79.7, 76.7, 75.4, 74.9, 73.8, 71.8, 71.4, 71.2, 67.3, 60.4, 58.3, 17.0, 16.9; HRMS (ESI): Calcd for $\text{C}_{20}\text{H}_{23}\text{N}_3\text{O}_4\text{Na}^+$ $[\text{M}+\text{Na}]^+$ 392.1586, found 392.1583. According to general procedure (C), the lactol (75 mg, 0.20 mmol) was reacted with trichloroacetonitrile (0.20 mL, 2.0 mmol) and K_2CO_3 (48 mg, 0.35 mmol) in DCM (2 mL) to afford compound **8*** (65 mg, 0.13 mmol, 62%). $[\alpha]_{\text{D}}^{20} = -32.3^\circ$ ($c = 1.5$, CHCl_3); IR ν_{max} (film) 3336, 2910, 2113, 1672, 1454, 1356, 1273, 1157, 1063 cm^{-1} ; $^1\text{H-NMR}$ (400 MHz, CDCl_3) δ 8.65 – 8.49 (m, 1H), 7.43 – 7.22 (m, 10H), 6.19 (d, $J = 1.5$ Hz, 1H), 5.03 (d, $J = 11.7$ Hz, 1H), 4.78 (d, $J = 11.8$ Hz, 1H), 4.70 (d, $J = 3.7$ Hz, 2H), 4.09 – 3.98 (m, 3H), 3.69 (dd, $J = 1.6, 1.2$ Hz, 1H), 1.23 (d, $J = 6.5$ Hz, 3H); $^{13}\text{C-NMR}$ (100 MHz, CDCl_3) δ 159.9, 138.2, 137.2, 128.9, 128.8 (2C), 128.7, 128.4, 128.3, 128.2, 128.0, 127.9 (2C), 97.0, 91.0, 76.0, 75.1, 74.5, 71.2, 70.3, 56.2, 16.9; HRMS (MALDI-TOF): Calcd for $\text{C}_{22}\text{H}_{23}\text{Cl}_3\text{N}_4\text{O}_4\text{Na}^+$ $[\text{M}+\text{Na}]^+$ 535.0677, found 535.0660.

Example 9: Synthesis of ethyl 2-O-benzoyl-3,4-di-O-benzyl-6-O-(2-naphthalenylmethyl)-1-thio- β -D-glucopyranoside (**9***)

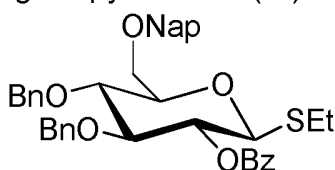

To a solution of 2-O-benzoyl-3-O-benzyl-4,6-O-benzylidene-1-thio- β -D-glucopyranoside (584 mg, 1.15 mmol) in DCM (10 mL), $\text{BH}_3 \cdot \text{THF}$ (1 M in THF, 6.9 mL, 6.9 mmol) and TMSOTf (0.1 mL, 0.6 mmol) were added dropwise at 0°C . The

reaction was warmed to room temperature over 2 h, cooled to 0° C again and quenched by drop wise addition of sat. aq. NaHCO₃ solution. The emulsion was diluted with DCM and washed with a sat. aq. NaHCO₃ solution. The organic phase was then dried over MgSO₄, filtered and concentrated to give the crude alcohol. To a solution of crude alcohol in THF/DMF (9:1, 10 mL) at 0 °C, naphthyl bromide (509 mg, 2.30 mmol) and NaH (33 mg, 1.38 mmol) were added. The reaction was warmed to room temperature and stirred for 30 min, cooled to 0 °C and quenched by the addition of water. After dilution with Et₂O the organic phase was washed with 0.1 M HCl and sat. aq. NaHCO₃ solutions. The organic phase was then dried over MgSO₄, filtered and concentrated. Column chromatography on silica gel (hexanes/ethyl acetate) afforded **9*** (626 mg, 0.97 mmol, 84%). $[\alpha]_D^{20} = + 29.5^\circ$ (c = 3.1, CHCl₃), IR ν_{\max} (film) 3061, 3030, 2867, 1722, 1602, 1496, 1452, 1359, 1315, 1264, 1087, 1067, 1026 cm⁻¹; ¹H-NMR (400 MHz, CDCl₃) δ 8.06 – 8.01 (m, 2H), 7.86 – 7.79 (m, 4H), 7.60 – 7.42 (m, 6H), 7.26 – 7.04 (m, 10H), 5.34 (dd, *J* = 10.0, 8.9 Hz, 1H), 4.84 – 4.54 (m, 7H), 3.88 – 3.74 (m, 4H), 3.60 (ddd, *J* = 9.5, 4.5, 2.0 Hz, 1H), 2.81 – 2.68 (m, 2H), 1.26 (t, *J* = 7.5 Hz, 3H); ¹³C-NMR (100 MHz, CDCl₃) δ 165.4, 138.0, 137.9, 135.8, 133.4, 133.3, 133.2, 130.1, 130.0, 128.5 (2C), 128.4, 128.3, 128.1 (3C), 127.9, 127.8 (2C), 126.6, 126.2, 126.0, 125.9, 84.5, 83.4, 79.7, 78.1, 75.4, 75.2, 73.7, 72.6, 69.1, 24.1, 15.1; HRMS (MALDI-TOF): Calcd for C₄₀H₄₀O₆SNa⁺ [M+Na]⁺ 671.2438, found 671.2478.

Example 10: Synthesis of ethyl 3,4-di-O-benzyl-2-O-levulinoyl-6-O-(2-naphthalenylmethyl)-1-thio- β -D-glucopyranoside (**10***)

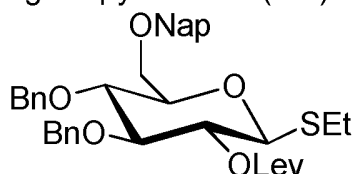

To a solution of **9*** (367 mg, 0.57 mmol) in DCM (5.0 mL) was added 0.5 M NaOMe in MeOH (5.0 mL) and stirred for 16 h. The mixture was neutralized with Amberlite[®] IR 120 (H⁺) ion exchange resin, filtered and concentrated. The residue was dissolved in DCM (5.0 mL) together with DMAP (7 mg, 0.06 mmol), levulinic acid (81 μ L, 0.79 mmol) and EDC (120 μ L, 0.68 mmol). The reaction mixture was stirred for 4 h, concentrated and redissolved in EtOAc. The organic layer was washed with sat. aq. NH₄Cl, sat. aq. NaHCO₃ and brine, then dried over MgSO₄ and concentrated. Column chromatography on silica gel (hexanes/ethyl acetate) afforded **10*** (271 mg, 0.42 mmol, 75%). $[\alpha]_D^{20} = - 1.0^\circ$ (c = 1.5, CHCl₃), IR ν_{\max} (film) 3061, 3031, 2926, 2869, 1746, 1718, 1497, 1454, 1404, 1361, 1203, 1158, 1081, 1062 cm⁻¹; ¹H-NMR (400 MHz, CDCl₃) δ 7.89 – 7.73 (m, 4H), 7.55 – 7.42 (m, 3H), 7.41 – 6.97 (m, 10H), 5.11 – 5.02 (m, 1H), 4.82 – 4.69 (m, 5H), 4.56 (d, *J* = 10.8 Hz, 1H), 4.39 (d, *J* = 10.0

Hz, 1H), 3.82 – 3.68 (m, 4H), 3.53 (ddd, $J = 9.2, 4.6, 2.1$ Hz, 1H), 2.80 – 2.64 (m, 4H), 2.60 – 2.46 (m, 2H), 2.16 (s, 3H), 1.28 (t, $J = 7.5$ Hz, 3H); $^{13}\text{C-NMR}$ (100 MHz, CDCl_3) δ 206.2, 171.6, 138.3, 137.9, 135.7, 133.3, 133.1, 128.4 (2C), 128.3, 128.2, 128.0 (2C), 127.9 (3C), 127.8 (2C), 126.5, 126.2, 125.9, 125.8, 84.4, 83.5, 79.5, 77.9, 75.2, 75.1, 73.6, 72.3, 68.9, 38.0, 29.9, 28.2, 24.0, 15.0; HRMS (MALDI-TOF): Calcd for $\text{C}_{38}\text{H}_{42}\text{O}_7\text{SNa}^+ [\text{M}+\text{Na}]^+$ 665.2543, found 665.2558.

Example 11: Synthesis of *N*-(benzyl)benzyloxycarbonyl-5-amino-pentanyl 2-azido-3-*O*-benzyl-2-deoxy-4-*O*-(2-naphthalenylmethyl)- β -D-fucopyranoside (**11***)

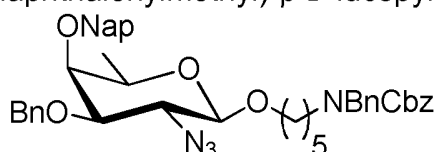

10

To a solution of **6*** (50 mg, 78 μmol) in DMF (4 ml) at 0 °C, BnBr (28 μL , 240 μmol), TBAI (3 mg, 8 μmol) and NaH (3 mg, 125 mmol) were added. After 3 h the reaction was quenched with MeOH at 0 °C and diluted with Et_2O . The organic layer was washed with 0.1 M aq. HCl solution, sat. aq. NaHCO_3 and brine. The organic layers

15

were dried over MgSO_4 and concentrated. Column chromatography on silica gel (hexanes/ethyl acetate) afforded **11*** (32 mg, 44 μmol , 56%). $[\alpha]_{\text{D}}^{20} = -24.2^\circ$ ($c = 1.6$, CHCl_3); IR ν_{max} (film) 3031, 2935, 2110, 1697, 1496, 1454, 1421, 1362, 1230, 1172, 1111, 1068 cm^{-1} ; $^1\text{H-NMR}$ (400 MHz, CDCl_3) δ 7.42 (s, 22H), 5.19 (d, $J = 12.8$ Hz, 2H), 5.09 (d, $J = 11.9$ Hz, 1H), 4.86 (d, $J = 11.9$ Hz, 1H), 4.79 – 4.68 (m, 2H),

20

4.51 (d, $J = 8.8$ Hz, 2H), 4.22 – 4.11 (m, 1H), 3.96 – 3.80 (m, 2H), 3.58 (d, $J = 2.5$ Hz, 1H), 3.51 – 3.36 (m, 2H), 3.34 – 3.17 (m, 3H), 1.67 – 1.47 (m, 4H), 1.46 – 1.28 (m, 2H), 1.21 (d, $J = 6.4$ Hz, 3H); $^{13}\text{C-NMR}$ (100 MHz, CDCl_3) δ 138.0, 137.9, 135.8, 133.2, 133.1, 128.6 (2C), 128.6, 128.1 (2C), 128.0, 127.9, 127.8, 127.3, 126.8, 126.1, 126.0, 102.4, 81.1, 74.8, 74.7, 72.9, 70.6, 69.8, 67.2, 63.3, 50.6, 50.3, 47.2,

25

46.3, 29.3, 28.0, 27.6, 23.3, 17.1; HRMS (MALDI-TOF): Calcd for $\text{C}_{44}\text{H}_{48}\text{N}_4\text{O}_6\text{Na}^+ [\text{M}+\text{Na}]^+$ 751.3466, found 751.3417.

Example 12: Synthesis of *N*-(benzyl)benzyloxycarbonyl-5-amino-pentanyl 2-*N*-acetyl-3-*O*-benzyl-2-deoxy-4-*O*-(2-naphthalenylmethyl)- β -D-fucosaminopyranoside

30

(**12***)

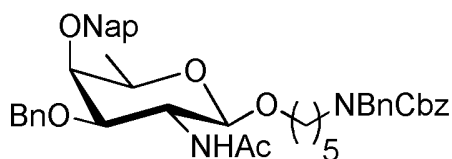

According to general procedure (F), azido-monosaccharide **11*** (32 mg, 44 μmol) was reacted with thioacetic acid for 24 h to give **12*** (26 mg, 35 μmol , 80%). $[\alpha]_{\text{D}}^{20} = +8.8^\circ$ ($c = 1.4$, CHCl_3); IR ν_{max} (film) 3288, 3062, 2933, 1698, 1654, 1555, 1496, 1454,

1422, 1366, 1308, 1231, 1173, 1113, 1068 cm^{-1} ; $^1\text{H-NMR}$ (400 MHz, CDCl_3) δ 7.93 – 7.08 (m, 22H), 5.17 (d, $J = 15.1$ Hz, 2H), 5.06 (d, $J = 11.9$ Hz, 1H), 4.95 (d, $J = 8.3$ Hz, 1H), 4.84 (d, $J = 12.0$ Hz, 1H), 4.72 – 4.63 (m, 1H), 4.60 – 4.32 (m, 4H), 3.92 – 3.72 (m, 1H), 3.65 (d, $J = 2.2$ Hz, 1H), 3.57 (q, $J = 6.3$ Hz, 1H), 3.53 – 3.32 (m, 2H),
 5 3.32 – 3.09 (m, 2H), 1.98 – 1.79 (m, 3H), 1.63 – 1.41 (m, 4H), 1.33 – 1.16 (m, 5H); $^{13}\text{C-NMR}$ (100 MHz, CDCl_3) δ 171.1, 138.0, 133.2, 133.0, 128.6, 128.1, 128.0 (2C), 127.9, 127.8, 127.3, 127.0, 126.7, 126.1, 125.9, 99.4, 78.2, 75.5, 74.7, 72.6, 70.4, 69.5, 67.2, 55.5, 50.3, 47.3, 29.1, 27.5, 23.8, 23.5, 17.3; HRMS (MALDI-TOF): Calcd for $\text{C}_{46}\text{H}_{52}\text{N}_2\text{O}_7\text{Na}^+$ $[\text{M}+\text{Na}]^+$ 767.3667, found 767.3575.

10

Example 13: Synthesis of *N*-(benzyl)benzyloxycarbonyl-5-amino-pentanyl 2-*N*-acetyl-3-*O*-benzyl-2-deoxy- β -D-fucosaminopyranoside (**13***)

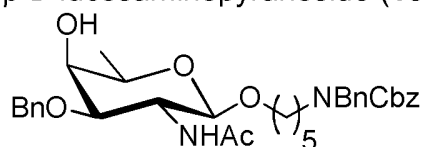

According to general procedure (G), monosaccharide **12*** (20 mg, 27 μmol) was
 15 reacted with DDQ (12 mg, 53 μmol) in $\text{DCM}/\text{H}_2\text{O}$ to give alcohol **13*** (12 mg, 20 μmol , 74%). $[\alpha]_{\text{D}}^{20} = +13.9^\circ$ ($c = 1.2$, CHCl_3); IR ν_{max} (film) 3298, 3032, 2934, 1697, 1657, 1554, 1497, 1454, 1423, 1369, 1303, 1229, 1173, 1069 cm^{-1} ; $^1\text{H-NMR}$ (400 MHz, CDCl_3) δ 7.53 – 7.07 (m, 15H), 5.16 (d, $J = 18.4$ Hz, 2H), 4.85 (d, $J = 8.4$ Hz, 1H), 4.67 (d, $J = 11.7$ Hz, 1H), 4.59 – 4.42 (m, 3H), 4.31 – 4.15 (m, 1H), 3.92 – 3.72 (m,
 20 2H), 3.61 (q, $J = 6.4$ Hz, 1H), 3.45 – 3.10 (m, 4H), 2.34 (s, 1H), 1.99 – 1.80 (m, 3H), 1.64 – 1.43 (m, 4H), 1.36 – 1.20 (m, 5H); $^{13}\text{C-NMR}$ (100 MHz, CDCl_3) δ 170.9, 138.0, 128.7, 128.6, 128.1 (2C), 127.9, 127.4, 127.3, 99.4, 77.4, 76.7, 71.9, 70.0, 69.5, 68.7, 67.3, 54.6, 50.5, 50.3, 47.4, 29.3, 29.0, 27.5, 23.8, 23.6, 16.7; HRMS (MALDI-TOF): Calcd for $\text{C}_{35}\text{H}_{77}\text{N}_2\text{O}_7\text{Na}^+$ $[\text{M}+\text{Na}]^+$ 627.3041, found 627.2969.

25

Example 14: Synthesis of 5-amino-pentanyl 2-acetamido-2,5-dideoxy- β -D-xylohexos-4-uloside (**14***)

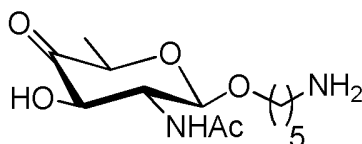

To a solution of alcohol **13*** (12 mg, 20 μmol) in DCM (2 mL) Dess Martin
 30 periodinane (17 mg, 40 μmol) was added and stirred for 12 h. The reaction mixture was loaded onto a silica gel column and purified by column chromatography (hexanes/acetone) to give the crude protected ketone. According to general procedure (I), the crude protected ketone was subjected to hydrogenolysis to give

14* as a minor component in a mixture of compounds. HRMS (ESI): Calcd for $C_{13}H_{26}N_2O_6Na^+$ $[M+H_2O+Na]^+$ 329.1689, found 329.1479.

Example 15: Synthesis of 5-amino-pentanyl 2-*N*-acetyl-2-deoxy- β -D-fucosaminopyranoside (**15***)

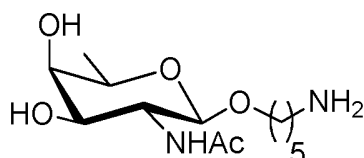

According to general procedure (I), D-fucosaminoside **12*** (7 mg, 9 μ mol) was subjected to hydrogenolysis to give **15*** (2.5 mg, 8.6 μ mol, 92%). 1H -NMR (600 MHz, D_2O) δ 4.43 (d, J = 8.5 Hz, 1H), 3.94 – 3.81 (m, 2H), 3.80 – 3.68 (m, 3H), 3.64 – 3.56 (m, 1H), 3.06 – 2.96 (m, 2H), 2.05 (s, 3H), 1.69 (dt, J = 15.2, 7.6 Hz, 2H), 1.63 – 1.57 (m, 2H), 1.45 – 1.37 (m, 2H), 1.28 (d, J = 6.3 Hz, 3H); ^{13}C -NMR (150 MHz, D_2O) δ 177.2, 104.1, 73.8, 73.5, 73.1, 72.6, 54.8, 41.9, 30.8, 29.0, 24.8, 24.7, 18.1; HRMS (ESI): Calcd for $C_{13}H_{27}N_2O_5^+$ $[M+H]^+$ 291.1920, found 291.1925.

Example 16: Synthesis of *N*-(benzyl)benzyloxycarbonyl-5-amino-pentanyl 2-azido-2-deoxy- α -L-fucopyranosyl-(1 \rightarrow 3)-2-azido-2-deoxy-4-*O*-(2-naphthalenylmethyl)- β -D-fucopyranoside (**16***)

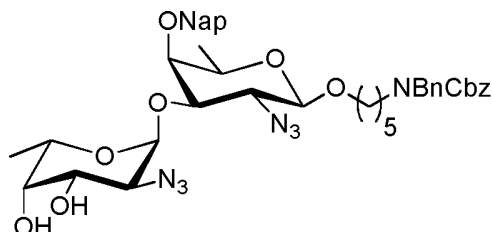

According to general procedure (E), 2-azido-3,4-di-*O*-benzyl-2-deoxy- α -L-fucopyranosyl trichloroacetimidate (140 mg, 335 μ mol) and **6*** (100 mg, 157 μ mol) were reacted in DCM (2 mL) at -20 $^{\circ}C$ to -15 $^{\circ}C$ over 30 min to give the crude disaccharide. To a solution of the crude disaccharide in DCM/MeOH (1:1, 2mL) was added 0.5 M NaOMe in MeOH (0.1 mL) and stirred for 16 h. The mixture was neutralized with Amberlite[®] IR 120 (H^+) ion exchange resin, filtered and concentrated. Column chromatography (DCM/MeOH/acetone) afforded disaccharide **16*** (110 mg, 136 μ mol, 87%). $[\alpha]_D^{20} = -41.6$ $^{\circ}$ (c = 1.5, $CHCl_3$); IR ν_{max} (film) 3328, 2936, 2119, 1697, 1422, 1255, 1095, 1070, 1028 cm^{-1} ; 1H -NMR (400 MHz, $CDCl_3$) δ 7.94 – 7.72 (m, 4H), 7.59 – 7.44 (m, 3H), 7.41 – 7.03 (m, 10H), 5.24 (d, J = 3.6 Hz, 1H), 5.17 (d, J = 12.9 Hz, 2H), 4.99 (d, J = 12.2 Hz, 1H), 4.80 (d, J = 12.2 Hz, 1H), 4.49 (d, J = 6.9 Hz, 2H), 4.21 (t, J = 9.3 Hz, 1H), 3.99 – 3.84 (m, 2H), 3.59 – 3.39 (m, 6H), 3.31 – 3.12 (m, 4H), 2.30 (s, 2H), 1.69 – 1.47 (m, 4H), 1.43 – 1.27 (m, 5H), 1.10 (d, J = 6.6 Hz, 3H); ^{13}C -NMR (100 MHz, $CDCl_3$) δ 136.0, 133.2, 133.1, 128.6, 128.3, 128.0,

127.9, 127.8, 127.4, 126.8, 126.6, 126.5, 126.3, 102.8, 99.9, 79.1, 78.2, 75.6, 71.4, 71.0, 69.9, 67.9, 67.3, 66.3, 63.8, 59.7, 50.6, 50.3, 47.2, 46.3, 29.3, 23.3, 17.3, 16.2; HRMS (MALDI-TOF): Calcd for $C_{43}H_{51}N_7O_9Na^+$ $[M+Na]^+$ 832.3640, found 832.3676.

- 5 **Example 17:** Synthesis of *N*-(benzyl)benzyloxycarbonyl-5-amino-pentanyl 3,4-di-*O*-benzyl-2-azido-2-deoxy- α -L-fucopyranosyl-(1 \rightarrow 3)-2-azido-2-deoxy-4-*O*-(2-naphthalenylmethyl)- β -D-fucopyranoside (**17***)

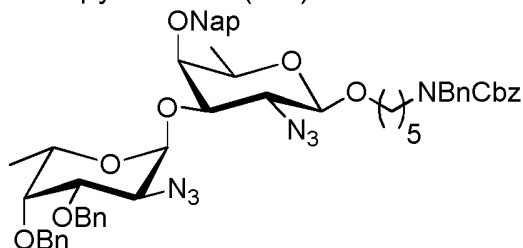

- To a solution of diol **16*** (87 mg, 107 μ mol) in DMF (5 mL) at 0 °C, BnBr (77 μ L, 645 μ mol), TBAI (4 mg, 11 μ mol) and NaH (8 mg, 333 mmol) were added. After 3 h the reaction was quenched with MeOH at 0 °C and diluted with Et₂O. The organic layer was washed with 0.1 M aq. HCl solution, sat. aq. NaHCO₃ and brine. The organic layers were dried over MgSO₄ and concentrated. Column chromatography on silica gel (hexanes/ethyl acetate) afforded **17*** (88 mg, 89 μ mol, 83%). $[\alpha]_D^{20} = -50.2^\circ$ (c = 1.4, CHCl₃); IR ν_{max} (film) 2937, 2114, 1697, 1496, 1454, 1421, 1360, 1233, 1171, 1103, 1068, 1038 cm⁻¹; ¹H-NMR (400 MHz, CDCl₃) δ 7.92 – 7.72 (m, 4H), 7.63 – 7.07 (m, 23H), 5.22 (d, *J* = 3.7 Hz, 1H), 5.18 (d, *J* = 13.1 Hz, 2H), 4.95 (d, *J* = 12.1 Hz, 1H), 4.83 (dd, *J* = 12.5 Hz, 2H), 4.57 – 4.36 (m, 5H), 4.21 (dd, *J* = 11.6, 8.1 Hz, 1H), 4.02 – 3.84 (m, 2H), 3.75 (dd, *J* = 10.8, 3.5 Hz, 1H), 3.64 – 3.40 (m, 6H), 3.33 – 3.15 (m, 3H), 1.70 – 1.49 (m, 4H), 1.43 – 1.26 (m, 5H), 1.00 (d, *J* = 6.5 Hz, 3H); ¹³C-NMR (100 MHz, CDCl₃) δ 138.1, 137.6, 136.0, 133.2, 133.0, 128.6, 128.5, 128.4, 128.3, 128.0, 127.9 (2C), 127.8, 127.3, 126.5, 126.4, 126.2, 102.7, 100.4, 79.4, 78.9, 75.8, 75.7, 74.9, 72.2, 70.9, 70.0, 67.2, 63.9, 59.4, 50.6, 50.3, 47.2, 46.3, 29.3, 28.0, 27.5, 23.3, 17.3, 16.8; HRMS (MALDI-TOF): Calcd for $C_{57}H_{63}N_7O_9Na^+$ $[M+Na]^+$ 1012.4579, found 1012.4502.

- Example 18:** Synthesis of *N*-(benzyl)benzyloxycarbonyl-5-amino-pentanyl 2-*N*-acetyl-3,4-di-*O*-benzyl- α -L-fucosaminopyranosyl-(1 \rightarrow 3)-2-*N*-acetyl-4-*O*-(2-naphthalenylmethyl)- β -D-fucosaminopyranoside (**18***)

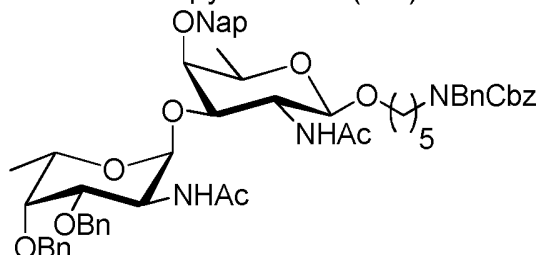

According to general procedure (F), azido-disaccharide **17*** (88 mg, 89 μmol) was reacted with thioacetic acid for 24 h to give **18*** (82 mg, 80 μmol , 90%). $[\alpha]_{\text{D}}^{20} = -21.0^\circ$ ($c = 1.2$, CHCl_3); IR ν_{max} (film) 3314, 2933, 1682, 1497, 1454, 1366, 1304, 1233, 1172, 1104, 1063, 1029 cm^{-1} ; $^1\text{H-NMR}$ (400 MHz, CDCl_3) δ 7.91 – 7.71 (m, 4H), 7.55 – 7.04 (m, 23H), 5.21 – 5.08 (m, 2H), 5.00 – 4.62 (m, 5H), 4.60 – 4.40 (m, 4H), 4.35 – 4.00 (m, 3H), 3.90 – 3.66 (m, 3H), 3.57 – 3.09 (m, 7H), 2.07 – 1.84 (m, 6H), 1.65 – 1.40 (m, 4H), 1.36 – 1.15 (m, 5H), 1.05 (d, $J = 6.5$ Hz, 3H); $^{13}\text{C-NMR}$ (100 MHz, CDCl_3) δ 171.4, 170.8, 133.2, 132.9, 128.6, 128.5, 128.4 (2C), 128.3, 128.2, 128.0, 127.9, 127.8, 127.6, 127.5, 127.4, 127.3, 126.4, 126.1, 126.0, 125.5, 101.4, 100.5, 78.5, 75.5, 74.3, 72.2, 70.7, 68.5, 67.6, 67.2, 52.0, 50.5, 48.1, 47.6, 29.2, 28.7, 23.6, 23.5, 17.4, 17.0; HRMS (MALDI-TOF): Calcd for $\text{C}_{61}\text{H}_{71}\text{N}_3\text{O}_{11}\text{Na}^+$ $[\text{M}+\text{Na}]^+$ 1044.4981, found 1044.4917.

Example 19: Synthesis of *N*-(benzyl)benzyloxycarbonyl-5-amino-pentanyl 2-*N*-acetyl-3,4-di-*O*-benzyl- α -L-fucosaminopyranosyl-(1 \rightarrow 3)-2-*N*-acetyl- β -D-fucosaminopyranoside (**19***)

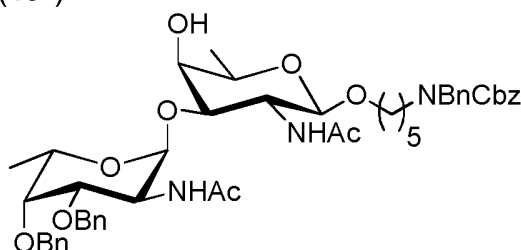

According to general procedure (G), disaccharide **18*** (46 mg, 45 μmol) was reacted with DDQ (30 mg, 132 μmol) in $\text{DCM}/\text{H}_2\text{O}$ to give alcohol **19*** (30 mg, 34 μmol , 76%). $[\alpha]_{\text{D}}^{20} = -35.7^\circ$ ($c = 1.0$, CHCl_3); IR ν_{max} (film) 3290, 3088, 2932, 1702, 1646, 1548, 1497, 1454, 1422, 1372, 1304, 1227, 1101, 1063, 1024 cm^{-1} ; $^1\text{H-NMR}$ (400 MHz, CDCl_3) δ 7.41 – 7.14 (m, 20H), 5.22 – 5.07 (m, 2H), 5.01 – 4.85 (m, 2H), 4.84 – 4.31 (m, 6H), 4.29 – 4.18 (m, 1H), 4.11 – 3.89 (m, 2H), 3.87 – 3.38 (m, 6H), 3.36 – 3.04 (m, 3H), 2.00 (s, 3H), 1.91 (s, 3H), 1.63 – 1.38 (m, 4H), 1.27 (d, $J = 6.4$ Hz, 5H), 1.17 (d, $J = 6.5$ Hz, 3H); $^{13}\text{C-NMR}$ (100 MHz, CDCl_3) δ 170.8, 128.7, 128.6, 128.5, 128.4 (2C), 128.0, 127.6, 127.5, 127.4, 101.5, 101.1, 80.4, 78.4, 75.8, 74.8, 72.0, 71.5, 70.1, 68.8, 67.4, 67.3, 51.3, 50.6, 48.8, 47.6, 28.7, 27.0, 23.6, 23.5, 17.2, 16.5; HRMS (MALDI-TOF): Calcd for $\text{C}_{50}\text{H}_{63}\text{N}_3\text{O}_{11}\text{Na}^+$ $[\text{M}+\text{Na}]^+$ 904.4355, found 904.4344.

Example 20: Synthesis of 5-amino-pentanyl 2-*N*-acetyl- α -L-fucosaminopyranosyl-(1 \rightarrow 3)-2-acetamido-2,5-dideoxy- β -D-xylo-hexos-4-uloside (**20***)

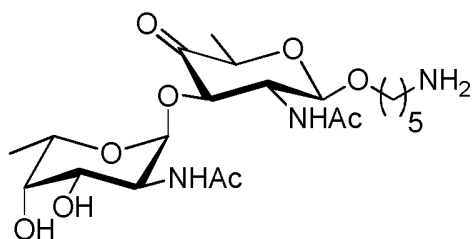

To a solution of **19*** (9 mg, 10 μ mol) in DCM (2 mL) Dess Martin periodinane (9 mg, 9 μ mol) was added and stirred for 12 h. The reaction mixture was loaded onto a silica gel column and purified by column chromatography (hexanes/acetone) to give the crude protected ketone. According to general procedure (I), the crude protected ketone was subjected to hydrogenolysis to give **20*** as a mixture of compounds (approx. 2 mg, approx. 4 μ mol, approx. 39%). $^1\text{H-NMR}$ (600 MHz, D_2O) δ 5.02 (d, J = 4.0 Hz, 1H), 4.49 (q, J = 6.5 Hz, 1H), 4.45 (d, J = 8.8 Hz, 1H), 4.15 (dd, J = 11.2, 4.1 Hz, 1H), 3.99 (dd, J = 11.2, 3.2 Hz, 1H), 3.92 – 3.83 (m, 3H), 3.66 – 3.54 (m, 3H), 3.01 – 2.97 (m, 2H), 2.06 (s, 3H), 1.98 (s, 3H), 1.70 – 1.64 (m, 2H), 1.61 – 1.55 (m, 2H), 1.42 – 1.36 (m, 2H), 1.29 (d, J = 6.4 Hz, 3H), 1.20 (d, J = 6.6 Hz, 3H); $^{13}\text{C-NMR}$ (150 MHz, D_2O) δ 177.0, 176.4, 104.0, 100.9, 95.4, 81.4, 75.9, 73.7, 72.8, 70.2, 69.9, 52.1, 42.0, 30.8, 29.1, 24.9, 24.8, 24.7, 17.9, 13.8; HRMS (ESI): Calcd for $\text{C}_{21}\text{H}_{40}\text{N}_3\text{O}_{10}^+$ $[\text{M}+\text{H}_2\text{O}+\text{H}]^+$ 494.2714, found 494.2740.

15

Example 21: Synthesis of 5-amino-pentanyl 2-*N*-acetyl- α -L-fucosaminopyranosyl-(1 \rightarrow 3)-2-*N*-acetyl- β -D-fucosaminopyranoside (**21***)

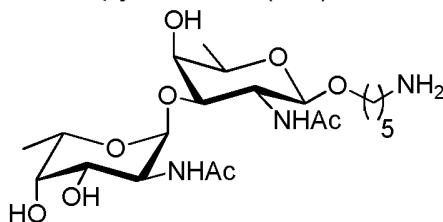

According to general procedure (I), disaccharide **20*** (7 mg, 7 μ mol) was subjected to hydrogenolysis to give **21*** (2.73 mg, 5.7 μ mol, 83%). $^1\text{H-NMR}$ (600 MHz, D_2O) δ 5.00 (d, J = 4.0 Hz, 1H), 4.41 (d, J = 8.5 Hz, 1H), 4.15 – 4.09 (m, 2H), 4.01 – 3.94 (m, 2H), 3.89 (dt, J = 10.2, 6.0 Hz, 1H), 3.85 (d, J = 3.0 Hz, 1H), 3.82 – 3.74 (m, 3H), 3.58 (dt, J = 10.1, 6.4 Hz, 1H), 3.04 – 2.96 (m, 2H), 2.05 (s, 3H), 2.00 (s, 3H), 1.72 – 1.64 (m, 2H), 1.63 – 1.55 (m, 2H), 1.44 – 1.36 (m, 2H), 1.28 (d, J = 6.5 Hz, 3H), 1.24 (d, J = 6.6 Hz, 3H); $^{13}\text{C-NMR}$ (150 MHz, D_2O) δ 176.8, 176.7, 104.2, 101.6, 79.4, 73.6, 73.3, 73.1, 72.7, 70.1, 69.7, 54.0, 52.1, 41.9, 30.8, 29.1, 24.8 (2C), 24.7, 18.0 (2C); HRMS (ESI): Calcd for $\text{C}_{21}\text{H}_{40}\text{N}_3\text{O}_9^+$ $[\text{M}+\text{H}]^+$ 478.2765, found 478.2775.

Example 22: Synthesis of *N*-(benzyl)benzyloxycarbonyl-5-amino-pentanyl 3,4-di-*O*-benzyl-2-*O*-levulinoyl-6-*O*-(2-naphthalenylmethyl)- β -D-glucopyranoside (**22***)

30

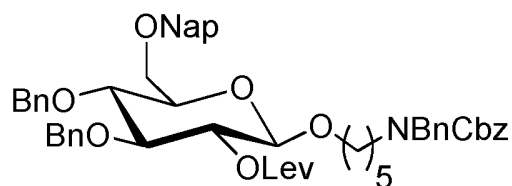

According to general procedure (B), thioglucoside **10*** (30 mg, 47 μmol) was reacted with *N*-(benzyl)benzyloxycarbonyl-5-amino-pentanol (31 mg, 93 μmol), NIS (13 mg, 56 μmol) and TfOH (0.8 μL, 9 μmol) in DCM (1 mL) at –30 °C to –20 °C over 1 h.

5 After work-up column chromatography (hexanes/EtOAc) afforded **22*** (26 mg, 29 μmol, 61%). $[\alpha]_D^{20} = + 3.7^\circ$ (c = 0.9, CHCl₃); IR ν_{\max} (film) 2924, 1747, 1698, 1454, 1421, 1362, 1210, 1153, 1071 cm⁻¹; ¹H-NMR (400 MHz, CDCl₃) δ 7.84 – 7.76 (m, 4H), 7.26 (s, 22H), 7.09 – 7.05 (m, 2H), 5.21 – 5.13 (m, 3H), 4.98 (t, J = 8.6 Hz, 1H), 4.77 (d, J = 10.9 Hz, 3H), 4.70 (d, J = 11.6 Hz, 2H), 4.53 – 4.44 (m, 4H), 4.37 – 4.27

10 (m, 1H), 3.85 – 3.59 (m, 5H), 3.53 – 3.11 (m, 3H), 2.82 – 2.39 (m, 4H), 2.17 – 2.03 (m, 2H), 1.62 – 1.43 (m, 8H), 1.37 – 1.17 (m, 3H); ¹³C-NMR (100 MHz, CDCl₃) δ 171.5, 138.4, 133.4, 133.1, 128.7, 128.5, 128.3, 128.1 (2C), 128.0, 127.9, 127.8 (2C), 126.7, 126.2, 126.0, 101.1, 83.0, 78.1, 75.2 (2C), 75.1, 73.7 (2C), 69.6, 68.8, 67.3, 50.3, 47.2, 37.9, 30.0, 29.3, 28.1, 23.3; HRMS (MALDI-TOF): Calcd for

15 C₅₆H₆₁NO₁₀Na⁺ [M+Na]⁺ 930.4188, found 930.4190.

Example 23: Synthesis of *N*-(benzyl)benzyloxycarbonyl-5-amino-pentanyl 3,4-di-*O*-benzyl-6-*O*-(2-naphthalenylmethyl)-β-D-glucopyranoside (**23***)

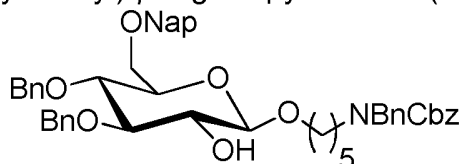

20 To a solution of **22*** (13 mg, 14 μmol) in DCM (1 mL) hydrazine hydrate (2.8 μL, 57 μmol) dissolved in AcOH (40 μL) and pyridine (60 μL) was added and the solution stirred for 1 h. The reaction was then quenched by the addition of acetone and concentrated. Column chromatography on silica gel (hexanes/ethyl acetate) afforded

25 **23*** (10 mg, 12 μmol, 86%). $[\alpha]_D^{20} = + 4.9^\circ$ (c = 1.0, CHCl₃); IR ν_{\max} (film) 2926, 1698, 1454, 1230, 1063 cm⁻¹; ¹H-NMR (400 MHz, CDCl₃) δ 7.84 – 7.01 (m, 27H), 5.16 (d, J = 9.8 Hz, 2H), 4.93 (t, J = 11.1 Hz, 1H), 4.81 (dd, J = 11.0, 6.1 Hz, 2H), 4.75 (d, J = 12.4 Hz, 1H), 4.67 (d, J = 12.4 Hz, 1H), 4.51 – 4.43 (m, 3H), 4.26 – 4.17 (m, 1H), 4.02 – 3.79 (m, 2H), 3.78 – 3.67 (m, 2H), 3.60 – 3.44 (m, 4H), 3.30 – 3.12 (m, 2H), 1.66 – 1.43 (m, 4H), 1.38 – 1.19 (m, 2H); ¹³C-NMR (100 MHz, CDCl₃) δ

30 138.0, 135.7, 133.4, 133.1, 128.7, 128.6, 128.5, 128.3, 128.1, 128.0 (2C), 127.8, 127.3, 126.8, 126.2, 126.0, 103.1, 84.7, 77.7, 75.3, 75.2, 74.8, 73.7, 70.1, 69.9, 69.0, 67.3, 50.3, 47.2, 46.2, 32.4, 29.3, 27.5, 23.5; HRMS (MALDI-TOF): Calcd for C₅₁H₅₅NO₈Na⁺ [M+Na]⁺ 832.3820, found 832.3870.

Example 24: Synthesis of *N*-(benzyl)benzyloxycarbonyl-5-amino-pentanyl 2-azido-3,4-di-*O*-benzyl-2-deoxy- α -L-pneumopyranosyl-(1 \rightarrow 2)-3,4-di-*O*-benzyl-6-*O*-(2-naphthalenylmethyl)- β -D-glucopyranoside (**24***)

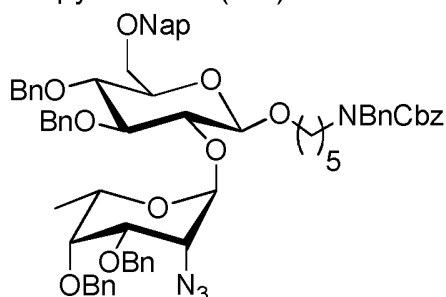

5

According to general procedure (E), pneumosyl-imidate **8*** (12 mg, 23 μ mol) and **23*** (10 mg, 12 μ mol) were reacted in DCM (1 mL) at -30 $^{\circ}$ C to -20 $^{\circ}$ C over 30 min to give **24*** (13 mg, 11 μ mol, 91%). $[\alpha]_{\text{D}}^{20} = -0.7$ $^{\circ}$ ($c = 0.7$, CHCl_3); IR ν_{max} (film) 2929, 2868, 2112, 1697, 1496, 1454, 1421, 1361, 1229, 1126, 1057 cm^{-1} ; $^1\text{H-NMR}$ (400 MHz, CDCl_3) δ 7.86 – 7.72 (m, 4H), 7.50 – 7.43 (m, 3H), 7.41 – 7.02 (m, 30H), 5.24 – 5.08 (m, 3H), 4.93 (dd, $J = 30.9, 11.5$ Hz, 2H), 4.77 – 4.44 (m, 10H), 4.26 – 4.08 (m, 2H), 3.85 – 3.67 (m, 4H), 3.66 – 3.51 (m, 5H), 3.47 – 3.29 (m, 2H), 3.25 – 3.09 (m, 2H), 1.61 – 1.38 (m, 4H), 1.32 – 1.03 (m, 5H); $^{13}\text{C-NMR}$ (100 MHz, CDCl_3) δ 137.9, 133.4, 133.1, 128.8, 128.7 (2C), 128.6 (2C), 128.4, 128.2, 128.1, 128.0, 127.9, 127.8, 127.2, 126.8, 126.3, 126.0 (2C), 101.8, 99.2, 78.7, 77.4, 75.7, 75.1 (2C), 73.8 (2C), 70.9, 68.9, 67.3, 66.9, 29.5, 23.4, 17.0; HRMS (MALDI-TOF): Calcd for $\text{C}_{71}\text{H}_{76}\text{N}_4\text{O}_{11}\text{Na}^+$ $[\text{M}+\text{Na}]^+$ 1183.5403, found 1183.5391.

20

Example 25: Synthesis of *N*-(benzyl)benzyloxycarbonyl-5-amino-pentanyl 2-*N*-acetyl-3,4-di-*O*-benzyl- α -L-pneumosaminopyranosyl-(1 \rightarrow 2)-3,4-di-*O*-benzyl-6-*O*-(2-naphthalenylmethyl)- β -D-glucopyranoside (**25***)

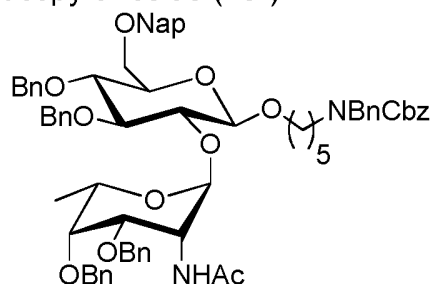

25

According to general procedure (F), azido-disaccharide **24*** (13 mg, 11 μ mol) was reacted with thioacetic acid for 24 h to give **25*** (10 mg, 8 μ mol, 76%). $[\alpha]_{\text{D}}^{20} = -31.1$ $^{\circ}$ ($c = 1.0$, CHCl_3); IR ν_{max} (film) 2930, 1698, 1497, 1454, 1363, 1229, 1056 cm^{-1} ; $^1\text{H-NMR}$ (400 MHz, CDCl_3) δ 7.85 – 7.73 (m, 4H), 7.49 – 7.43 (m, 3H), 7.35 – 7.12 (m, 28H), 7.08 – 7.02 (m, 2H), 7.01 – 6.94 (m, 1H), 5.28 (s, 1H), 5.21 – 5.13 (m, 2H), 4.90 – 4.81 (m, 3H), 4.77 – 4.67 (m, 5H), 4.60 – 4.54 (m, 1H), 4.51 – 4.30 (m, 5H),

4.28 – 4.20 (m, 1H), 3.90 – 3.78 (m, 2H), 3.76 – 3.57 (m, 6H), 3.49 – 3.43 (m, 1H), 3.38 (s, 1H), 3.28 – 3.14 (m, 2H), 1.65 (s, 3H), 1.58 – 1.45 (m, 4H), 1.30 – 1.16 (m, 5H); ^{13}C -NMR (100 MHz, CDCl_3) δ 169.8, 138.5, 138.3, 137.9, 135.7, 133.4, 133.2, 128.7 (2C), 128.5 (3C), 128.3 (2C), 128.2, 128.1, 128.0 (3C), 127.9, 127.7, 127.6, 126.8, 126.3, 126.0, 102.0, 100.3, 86.0, 79.0, 78.5, 77.4, 75.6 (2C), 75.1, 75.0, 73.8, 73.3, 70.0, 69.0, 67.3, 66.6, 50.7, 50.4, 47.6, 29.6, 27.7, 23.5, 23.3, 16.8; HRMS (MALDI-TOF): Calcd for $\text{C}_{73}\text{H}_{80}\text{N}_2\text{O}_{12}\text{Na}^+$ $[\text{M}+\text{Na}]^+$ 1199.5603, found 1199.5599.

Example 26: Synthesis of *N*-(benzyl)benzyloxycarbonyl-5-amino-pentanyl 2-*N*-acetyl-3,4-di-*O*-benzyl- α -L-pneumosaminopyranosyl-(1 \rightarrow 2)-3,4-di-*O*-benzyl- β -D-glucopyranoside (**26***)

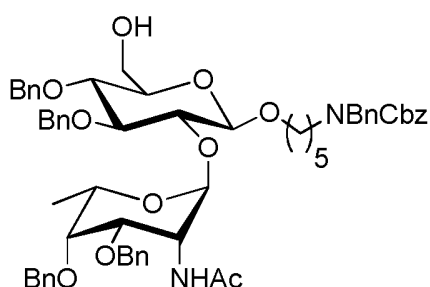

According to general procedure (G), disaccharide **25*** (10 mg, 8 μmol) was reacted with DDQ (6 mg, 25 μmol) for 4 h to give primary alcohol **26*** (7 mg, 7 μmol , 79%). $[\alpha]_{\text{D}}^{20} = -34.5^\circ$ ($c = 0.7$, CHCl_3); IR ν_{max} (film) 3404, 2925, 1697, 1497, 1454, 1421, 1362 1260, 1027 cm^{-1} ; ^1H -NMR (400 MHz, CDCl_3) δ 7.39 – 7.16 (m, 30H), 7.04 – 6.93 (m, 1H), 5.28 (s, 1H), 5.23 – 5.14 (m, 2H), 4.92 – 4.83 (m, 3H), 4.80 (d, $J = 11.0$ Hz, 1H), 4.72 (d, $J = 12.2$ Hz, 2H), 4.63 – 4.55 (m, 2H), 4.53 – 4.47 (m, 2H), 4.45 – 4.37 (m, 1H), 4.35 – 4.23 (m, 2H), 3.90 – 3.72 (m, 3H), 3.72 – 3.53 (m, 5H), 3.47 – 3.30 (m, 2H), 3.29 – 3.14 (m, 2H), 1.66 (s, 3H), 1.58 – 1.45 (m, 4H), 1.30 – 1.16 (m, 5H); ^{13}C -NMR (100 MHz, CDCl_3) δ 169.8, 138.5, 138.2, 138.0, 128.7 (3C), 128.5 (2C), 128.3, 128.2 (2C), 128.1, 128.0, 127.7, 127.6, 102.0, 100.4, 85.7, 78.9, 78.1, 77.4, 75.8, 75.6, 75.1, 73.2, 70.0, 67.4, 66.7, 62.1, 50.5, 47.6, 47.2, 29.4, 28.1, 27.4, 23.3, 16.7; HRMS (MALDI-TOF): Calcd for $\text{C}_{62}\text{H}_{72}\text{N}_2\text{O}_{12}\text{Na}^+$ $[\text{M}+\text{Na}]^+$ 1059.4977, found 1059.4938.

Example 27: Synthesis of 5-amino-pentanyl 2-*N*-acetyl- α -L-pneumosaminopyranosyl-(1 \rightarrow 2)- β -D-glucopyranosyluronate (**27***)

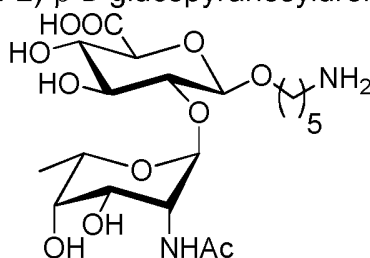

According to general procedure (H), alcohol **26*** (6 mg, 6 μ mol) was reacted with TEMPO (0.2 mg, 2 μ mol) and BAIB (9 mg, 30 μ mol) to give the protected uronate disaccharide. According to general procedure (I), the uronate disaccharide was subjected to hydrogenolysis to give **27*** (1.6 mg, 3.4 μ mol, 59%). ¹H-NMR (600 MHz, D₂O) δ 5.15 (s, 1H), 4.55 (d, *J* = 7.9 Hz, 1H), 4.33 (q, *J* = 6.7 Hz, 1H), 4.23 (d, *J* = 4.8 Hz, 1H), 4.09 (dd, *J* = 4.8, 3.2 Hz, 1H), 3.92 (dt, *J* = 10.0, 6.9 Hz, 1H), 3.85 – 3.81 (m, 1H), 3.74 – 3.65 (m, 3H), 3.55 – 3.50 (m, 1H), 3.43 (dd, *J* = 9.0, 8.0 Hz, 1H), 3.00 (t, *J* = 7.6 Hz, 2H), 2.06 (s, 3H), 1.73 – 1.66 (m, 4H), 1.49 – 1.42 (m, 2H), 1.26 (d, *J* = 6.6 Hz, 3H); ¹³C-NMR (150 MHz, D₂O) δ 178.4, 176.74, 103.6, 102.6, 80.8, 78.8, 78.7, 74.3, 73.6, 72.7, 69.9, 66.5, 53.8, 42.0, 30.9, 28.9, 25.0, 24.7, 18.1; HRMS (ESI): Calcd for C₁₉H₃₄N₂O₁₁Na⁺ [M+Na]⁺ 489.2060, found 489.2060.

Compounds **27*a-27*e** constitute further examples according to the present invention that can be obtained following the procedure described for compound **27**:

27*a 2-(2-aminoethoxy)ethyl 2-*N*-acetyl- α -L-pneumosaminopyranosyl-(1 \rightarrow 2)- β -D-glucopyranosyluronate

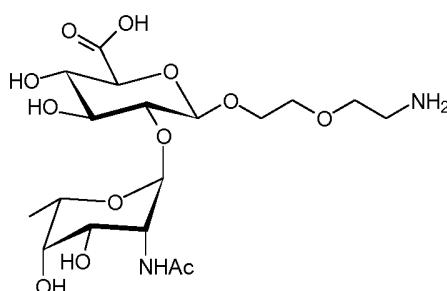

Chemical formula: C₁₈H₃₂N₂O₁₂, Exact mass: 468.1955.

27*b 3-amino-2,2-difluoropropyl 2-*N*-acetyl- α -L-pneumosaminopyranosyl-(1 \rightarrow 2)- β -D-glucopyranosyluronate

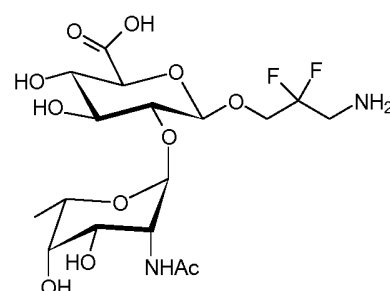

Chemical formula: C₁₇H₂₈F₂N₂O₁₁; Exact mass: 474.1661.

27*c *N*-(2-*N*-acetyl- α -L-pneumosaminopyranosyl-(1 \rightarrow 2)- β -D-glucopyranosyluronate ethyl)-6-amino-hexanamide

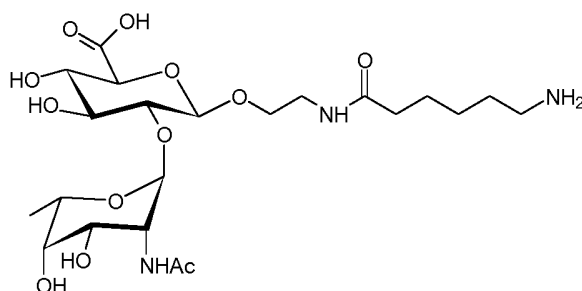

Chemical formula: $C_{22}H_{39}N_3O_{12}$, Exact mass: 537.2534.

27*d *N*-(2-*N*-acetyl- α -L-pneumosaminopyranosyl-(1 \rightarrow 2)- β -D-glucopyranosyluronyl) 2-ethoxyethyl-3-aminopropanamide

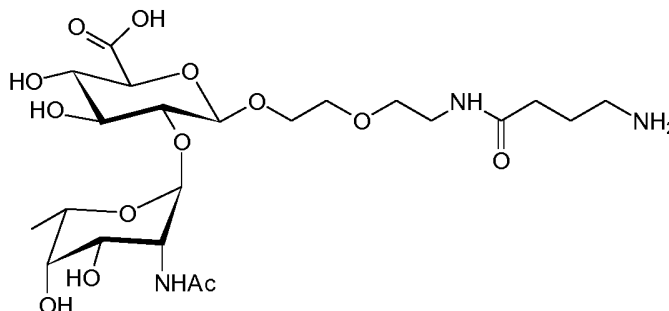

Chemical formula: $C_{22}H_{39}N_3O_{12}$; Exact mass: 537.2534.

27*e 3-(3-aminopropyl)ureido-propyl 2-*N*-acetyl- α -L-pneumosaminopyranosyl-(1 \rightarrow 2)- β -D-glucopyranosyluronate

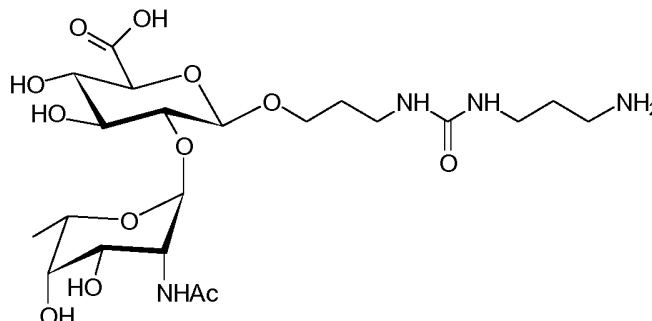

Chemical formula: $C_{21}H_{38}N_4O_{12}$; Exact mass: 538.2486.

Example 28: Synthesis of *N*-(benzyl)benzyloxycarbonyl-5-amino-pentanyl 4-*O*-acetyl-2-azido-2-deoxy- α -L-fucopyranosyl-(1 \rightarrow 3)-2-azido-2-deoxy-4-*O*-(2-naphthalenylmethyl)- β -D-fucopyranoside (**28***)

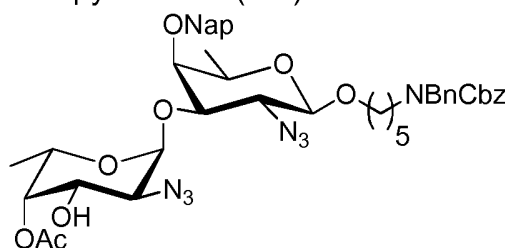

To a solution of the disaccharide **16*** (110 mg, 136 μmol) in DMF (1 mL) was added trimethyl orthoacetate (104 μL , 815 μmol) and *p*-TSA (4 mg, 21 μmol) and the reaction mixture stirred for 30 min. Triethylamine (2 drops) was added and the solvent removed under vacuum using toluene as an azeotrope. The crude residue
5 was taken up in 80% acetic acid (3 mL) and the reaction mixture stirred for 1 h. The solvent was removed under vacuum and azeotroped with toluene. Column chromatography on silica gel (hexanes/EtOAc) afforded **28*** (92 mg, 108 μmol , 80%).
[α]_D²⁰ = - 50.9 ° (c = 1.3, CHCl₃); IR ν_{max} (film) 3436, 2937, 2114, 1743, 1696, 1423, 1363, 1232, 1165, 1125, 1093, 1070, 1036 cm⁻¹; ¹H-NMR (400 MHz, CDCl₃) δ 7.95 –
10 7.74 (m, 4H), 7.59 – 7.47 (m, 3H), 7.41 – 7.10 (m, 10H), 5.24 (d, *J* = 3.6 Hz, 1H),
5.17 (d, *J* = 13.3 Hz, 2H), 5.05 (d, *J* = 12.4 Hz, 1H), 4.74 (d, *J* = 12.4 Hz, 1H), 4.49
(d, *J* = 7.6 Hz, 2H), 4.41 (d, *J* = 2.2 Hz, 1H), 4.21 (dd, *J* = 11.2, 8.3 Hz, 1H), 4.01 –
3.84 (m, 2H), 3.60 – 3.37 (m, 6H), 3.31 – 3.16 (m, 3H), 2.09 (s, 3H), 1.67 – 1.48 (m,
15 4H), 1.44 – 1.27 (m, 5H), 0.94 (d, *J* = 6.6 Hz, 3H); ¹³C-NMR (100 MHz, CDCl₃) δ
171.3, 138.0, 136.0, 133.1 (2C), 128.6, 128.4, 127.9, 127.8, 127.3, 126.9, 126.8,
126.7, 126.5, 102.7, 99.8, 79.2, 78.1, 75.8, 72.7, 71.0, 70.0, 67.2, 66.5, 65.4, 63.9,
59.6, 50.6, 50.3, 47.2, 46.3, 29.3, 28.0, 27.5, 23.3, 20.8, 17.3, 16.1; HRMS (MALDI-
TOF): Calcd for C₄₅H₅₃N₇O₁₀Na⁺ [M+Na]⁺ 874.3746, found 874.3737.

20 **Example 29:** Synthesis of *N*-(benzyl)benzyloxycarbonyl-5-amino-pentanyl 3,4-di-*O*-benzyl-6-*O*-(2-naphthalenylmethyl)- β -D-glucopyranosyl-(1 \rightarrow 3)-4-*O*-acetyl-2-azido-2-deoxy- α -L-fucopyranosyl-(1 \rightarrow 3)-2-azido-2-deoxy-4-*O*-(2-naphthalenylmethyl)- β -D-fucopyranoside (**29***)

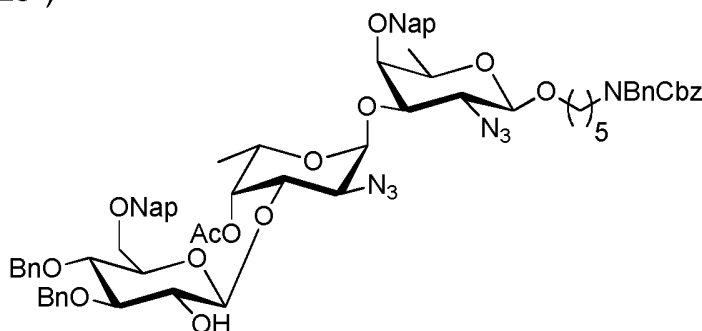

25 According to general procedure (B), thioglucoside **10*** (75 mg, 117 μmol) was reacted with disaccharide **28*** (50 mg, 59 μmol), NIS (29 mg, 129 μmol) and TfOH (1 μL , 12 μmol) in DCM (2 mL) at -20 °C to -10 °C over 1 h to give the crude trisaccharide. To a solution of the crude trisaccharide in DCM (3 mL) hydrazine hydrate (11 μL , μmol) dissolved in AcOH (40 μL) and pyridine (60 μL) was added and
30 the solution stirred for 1 h. The reaction was then quenched by the addition of acetone and concentrated. Column chromatography on silica gel (hexanes/ethyl acetate) afforded alcohol **29*** (72 mg, 54 μmol , 91%). [α]_D²⁰ = - 19.2 ° (c = 1.0, CHCl₃); IR ν_{max} (film) 2936, 2115, 1697, 1454, 1360, 1235, 1069 cm⁻¹; ¹H-NMR (400

MHz, CDCl₃) δ 7.87 – 7.72 (m, 8H), 7.50 – 7.17 (m, 24H), 7.10 – 7.03 (m, 2H), 5.33 (d, *J* = 3.6 Hz, 1H), 5.19 (d, *J* = 12.8 Hz, 2H), 5.05 (d, *J* = 11.3 Hz, 1H), 4.98 (d, *J* = 12.3 Hz, 1H), 4.88 – 4.70 (m, 6H), 4.60 – 4.46 (m, 4H), 4.32 – 4.19 (m, 1H), 4.09 (d, *J* = 7.0 Hz, 1H), 4.01 – 3.86 (m, 3H), 3.74 – 3.66 (m, 3H), 3.63 – 3.42 (m, 7H), 3.40 (d, *J* = 2.1 Hz, 1H), 3.33 – 3.18 (m, 3H), 2.13 (s, 3H), 1.71 – 1.50 (m, 4H), 1.47 – 1.21 (m, 5H), 0.90 (d, *J* = 6.5 Hz, 3H); ¹³C-NMR (100 MHz, CDCl₃) δ 174.1, 138.4, 138.2, 138.0, 137.9, 135.6, 133.2, 133.0, 132.9, 128.5, 128.4, 128.3, 128.1 (2C), 128.0, 127.9, 127.8, 127.7(2C), 127.6 (2C), 127.5, 127.3, 127.2, 126.7, 126.5, 126.4, 126.3, 126.1, 126.0, 125.7, 102.7, 100.3, 100.2, 85.1, 82.0, 77.9, 77.4, 77.0, 76.7, 75.5, 75.5, 75.0, 74.9, 74.5, 74.2, 73.4, 70.8, 69.8, 68.5, 67.1, 63.8, 58.1, 29.2, 27.9, 23.2, 17.1, 16.6; HRMS (MALDI-TOF): Calcd for C₇₆H₈₃N₇O₁₅Na⁺ [M+Na]⁺ 1356.5839, found 1356.5896.

Example 30: Synthesis of *N*-(benzyl)benzyloxycarbonyl-5-amino-pentanyl 2-azido-3,4-di-*O*-benzyl-2-deoxy- α -L-pneumopyranosyl-(1 \rightarrow 2)-3,4-di-*O*-benzyl-6-*O*-(2-naphthalenylmethyl)- β -D-glucopyranosyl-(1 \rightarrow 3)-4-*O*-acetyl-2-azido-2-deoxy- α -L-fucopyranosyl-(1 \rightarrow 3)-2-azido-2-deoxy-4-*O*-(2-naphthalenylmethyl)- β -D-fucopyranoside (**30***)

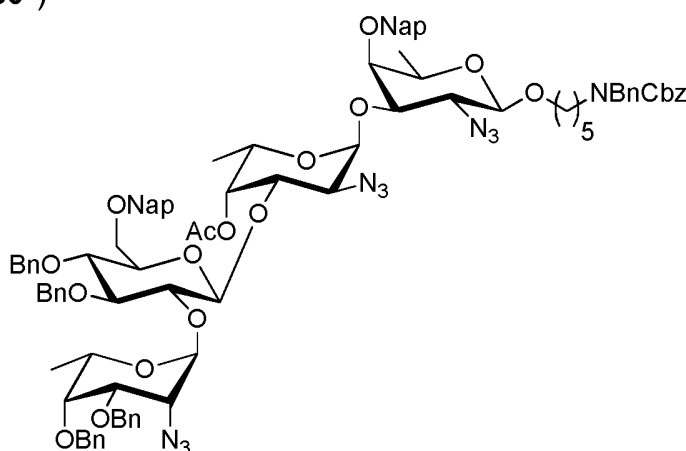

20 According to general procedure (E), pneumosyl-imidate **8*** (100 mg, 196 μ mol) and trisaccharide **29*** (58 mg, 43 μ mol) were reacted in DCM (2 mL) at -30 $^{\circ}$ C to -20 $^{\circ}$ C over 30 min to give tetrasaccharide **30*** (40 mg, 24 μ mol, 55%). $[\alpha]_D^{20} = -38.3$ $^{\circ}$ (*c* = 1.2, CHCl₃); IR ν_{\max} (film) 2936, 2114, 1744, 1697, 1496, 1454, 1361, 1231, 1065 cm⁻¹; ¹H-NMR (400 MHz, CDCl₃) δ 7.85 – 6.94 (m, 44H), 5.34 (d, *J* = 3.7 Hz, 1H), 5.23 (s, 1H), 5.21 – 5.10 (m, 3H), 4.96 (dd, *J* = 11.8, 3.2 Hz, 2H), 4.88 (d, *J* = 11.3 Hz, 1H), 4.77 – 4.36 (m, 12H), 4.27 – 4.14 (m, 2H), 4.08 – 3.99 (m, 1H), 3.95 – 3.85 (m, 2H), 3.81 – 3.76 (m, 1H), 3.74 – 3.60 (m, 5H), 3.58 – 3.37 (m, 8H), 3.33 – 3.16 (m, 3H), 1.90 (s, 3H), 1.64 – 1.46 (m, 4H), 1.42 – 1.22 (m, 5H), 1.19 (d, *J* = 6.5 Hz, 3H), 0.83 (d, *J* = 6.4 Hz, 3H); ¹³C-NMR (100 MHz, CDCl₃) δ 170.3, 138.4, 138.0, 137.9, 137.7, 135.6, 133.2, 133.1, 133.0, 128.9, 128.7, 128.6 (2C), 128.5, 128.4, 128.3,

128.2, 128.1, 128.0 (2C), 127.9, 127.8, 127.7, 127.4, 127.2, 126.8, 126.5, 126.4, 126.1, 125.9, 125.8, 102.8, 100.1, 98.6, 96.7, 84.8, 78.7, 78.5, 77.4, 76.0, 75.3, 75.1, 75.0, 74.7, 73.3, 71.0, 70.9, 69.9, 68.9, 68.7, 67.3, 65.7, 63.9, 57.4, 57.0, 29.3, 27.6, 23.3, 20.9, 17.6, 16.8, 16.3; HRMS (MALDI-TOF): Calcd for C₉₆H₁₀₄N₁₀O₁₈Na⁺ [M+Na]⁺ 1707.7422, found 1707.7445.

Example 31: Synthesis of *N*-(benzyl)benzyloxycarbonyl-5-amino-pentanyl 2-*N*-acetyl-3,4-di-*O*-benzyl- α -L-pneumosaminopyranosyl-(1 \rightarrow 2)-3,4-di-*O*-benzyl-6-*O*-(2-naphthalenylmethyl)- β -D-glucopyranosyl-(1 \rightarrow 3)-4-*O*-acetyl-2-*N*-acetyl- α -L-fucosaminopyranosyl-(1 \rightarrow 3)-2-*N*-acetyl-4-*O*-(2-naphthalenylmethyl)- β -D-fucosaminopyranoside (**31***)

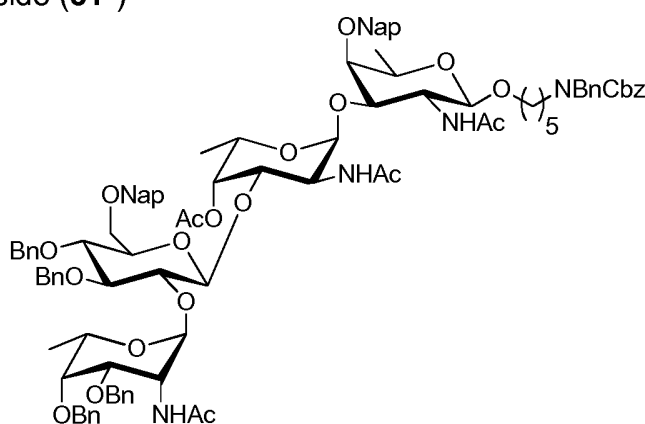

According to general procedure (F), azido-tetrasaccharide **30*** (40 mg, 24 μ mol) was reacted with thioacetic acid for 48 h to give **31*** (31 mg, 18 μ mol, 75%). $[\alpha]_D^{20} = -58.3^\circ$ ($c = 1.2$, CHCl₃); IR ν_{\max} (film) 2963, 1740, 1674, 1519, 1454, 1365, 1260, 1234, 1025 cm⁻¹; ¹H-NMR (400 MHz, CDCl₃) δ 7.89 – 6.61 (m, 44H), 5.40 – 5.04 (m, 6H), 4.95 – 4.80 (m, 2H), 4.79 – 4.11 (m, 16H), 4.10 – 3.92 (m, 2H), 3.91 – 3.73 (m, 4H), 3.74 – 3.54 (m, 4H), 3.54 – 3.31 (m, 4H), 3.30 – 3.02 (m, 4H), 2.00 (s, 3H), 1.90 – 1.85 (m, 3H), 1.68 (s, 3H), 1.58 – 1.38 (m, 4H), 1.38 – 1.23 (m, 5H), 1.20 (d, $J = 6.4$ Hz, 3H), 1.10 – 1.00 (m, 3H); ¹³C-NMR (100 MHz, CDCl₃) δ 171.2, 170.7 (2C), 170.0, 138.5, 138.1, 137.9, 137.7, 136.2, 133.4, 133.1 (2C), 133.0, 128.8, 128.7, 128.5 (2C), 128.4, 128.2, 128.0, 127.9, 127.7 (2C), 127.6, 127.5, 127.4, 127.3, 126.7, 126.3, 125.9, 125.5, 100.7, 98.7, 98.6, 97.1, 84.1, 79.1, 78.4, 77.4, 75.6, 75.0, 74.5, 74.0, 73.8, 73.5, 73.3, 73.1, 70.7, 70.1, 69.7, 69.3, 68.1, 67.3, 66.9, 66.0, 50.4, 48.6, 47.6, 47.4, 29.0, 27.2, 23.8, 23.4, 23.1, 21.0, 17.3, 16.9, 16.7; HRMS (MALDI-TOF): Calcd for C₁₀₂H₁₁₆N₄O₂₁Na⁺ [M+Na]⁺ 1755.8024, found 1755.8089.

Example 32: Synthesis of *N*-(Benzyl)benzyloxycarbonyl-5-amino-pentanyl 2-*N*-acetyl-3,4-di-*O*-benzyl- α -L-pneumosaminopyranosyl-(1 \rightarrow 2)-3,4-di-*O*-benzyl- β -D-glucopyranosyl-(1 \rightarrow 3)-2-*N*-acetyl- α -L-fucosaminopyranosyl-(1 \rightarrow 3)-2-*N*-acetyl- β -D-fucosaminopyranoside (**32***)

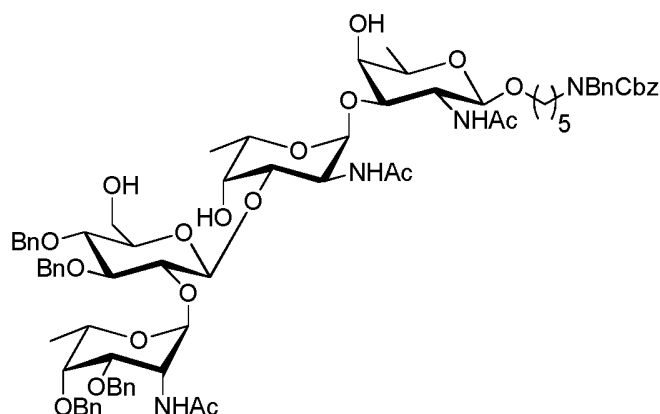

To a solution of **31*** (19 mg, 11 μ mol) in DCM/MeOH (1:1, 1 mL) was added 0.5 M NaOMe in MeOH (0.5 mL) and stirred for 16 h. The mixture was neutralized with Amberlite[®] IR 120 (H⁺) ion exchange resin, filtered and concentrated. According to
 5 general procedure (G), the crude material was reacted with DDQ (9 mg, 40 μ mol) in DCM/H₂O to give triol **32*** (10 mg, 7 μ mol, 64%). $[\alpha]_D^{20} = -69.7^\circ$ (c = 1.0, CHCl₃); IR ν_{\max} (film) 3400, 3030, 2933, 1656, 1524, 1497, 1454, 1421, 1366, 1305, 1232, 1055 cm^{-1} ; ¹H-NMR (400 MHz, CDCl₃) δ 7.53 – 6.98 (m, 30H), 5.25 – 5.01 (m, 4H), 4.94 – 4.70 (m, 4H), 4.67 – 4.34 (m, 7H), 4.28 – 4.10 (m, 4H), 4.00 – 3.10 (m, 19H), 2.06 (s, 3H), 1.99 – 1.94 (m, 3H), 1.70 (s, 3H), 1.63 – 1.37 (m, 4H), 1.37 – 1.07 (m, 11H); ¹³C-NMR (100 MHz, CDCl₃) δ 171.6, 170.9, 170.1, 138.3, 128.7, 128.6 (2C), 128.5, 128.4, 128.3, 128.2, 128.1, 127.7, 127.5, 127.3, 127.2, 126.8, 101.7, 101.4, 101.2, 100.6, 99.5, 84.2, 80.8, 78.5, 77.5, 77.4, 77.2, 76.8, 75.7, 75.5, 75.2, 72.7, 72.5, 71.8, 71.3, 70.2, 69.7, 68.7, 68.6, 68.2, 67.3, 66.9, 61.9, 51.4, 50.6, 49.5, 48.5, 47.9,
 10 23.9, 23.8, 23.5, 21.2, 16.6; HRMS (MALDI-TOF): Calcd for C₇₈H₉₈N₄O₂₀Na⁺ [M+Na]⁺ 1433.6666, found 1433.6640.

Example 33: Synthesis of 5-amino-pentanyl 2-N-acetyl- α -L-pneumosaminopyranosyl-(1 \rightarrow 2)- β -D-glucopyranosyl-(1 \rightarrow 3)-2-N-acetyl- α -L-
 20 fucosaminopyranosyl-(1 \rightarrow 3)-2-N-acetyl- β -D-fucosaminopyranoside (**33***)

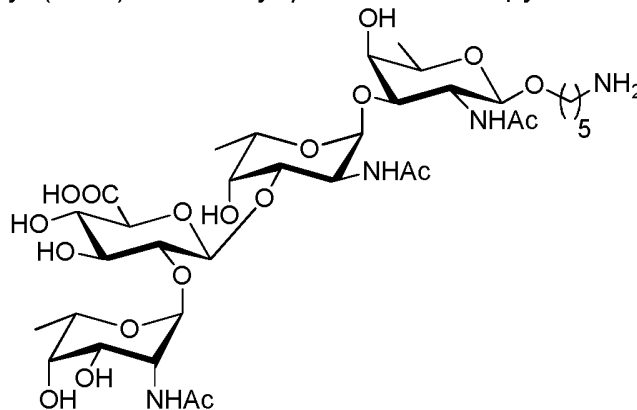

According to general procedure (H), triol **32*** (10 mg, 7 μ mol) was reacted with TEMPO (0.3 mg, 2 μ mol) and BAIB (6 mg, 19 μ mol) to give the protected uronate

tetrasaccharide. According to general procedure (I), the uronate tetrasaccharide was subjected to hydrogenolysis to give carboxylic acid **33*** (4.9 mg, 5.8 μ mol, 83%). ¹H-NMR (600 MHz, D₂O) δ 5.18 (s, 1H), 5.07 (d, *J* = 3.9 Hz, 1H), 4.69 (d, *J* = 7.8 Hz, 1H), 4.65 (q, *J* = 6.7 Hz, 1H), 4.41 (d, *J* = 8.6 Hz, 1H), 4.37 (dd, *J* = 11.6, 3.0 Hz, 1H), 4.18 (d, *J* = 4.8 Hz, 1H), 4.12 (dd, *J* = 4.7, 3.2 Hz, 1H), 4.10 – 4.06 (m, 2H), 4.03 (dd, *J* = 11.6, 3.9 Hz, 1H), 3.94 (t, *J* = 9.6 Hz, 1H), 3.88 (dt, *J* = 10.1, 6.0 Hz, 1H), 3.82 – 3.74 (m, 4H), 3.73 – 3.68 (m, 2H), 3.61 – 3.52 (m, 2H), 3.51 (dd, *J* = 9.2, 7.9 Hz, 1H), 3.02 – 2.98 (m, 2H), 2.05 (s, 3H), 2.04 (s, 3H), 2.00 (s, 3H), 1.71 – 1.65 (m, 2H), 1.61 – 1.56 (m, 2H), 1.44 – 1.37 (m, 2H), 1.28 (d, *J* = 6.5 Hz, 3H), 1.24 (d, *J* = 6.6 Hz, 3H), 1.15 (d, *J* = 6.6 Hz, 3H); ¹³C-NMR (150 MHz, D₂O) δ 178.4, 176.8, 176.5, 176.3, 104.2, 102.1, 101.0, 98.2, 79.1, 78.8, 78.1, 74.3, 73.7, 73.5, 73.2, 73.1, 72.6, 69.8, 69.6, 68.9, 66.4, 54.0, 53.7, 51.0, 41.9, 30.8, 29.0, 25.0, 24.9, 24.8, 24.7, 18.1, 18.0, 17.9; HRMS (ESI): Calcd for C₃₅H₆₀N₄O₁₉Na⁺ [M+Na]⁺ 863.3744, found 864.3774.

15 Compounds **33*a-33*e** constitute further examples according to the present invention that can be obtained following the procedure described for compound **33***:

33*a 2-(2-aminoethoxy)ethyl 2-*N*-acetyl- α -L-pneumosaminopyranosyl-(1 \rightarrow 2)- β -D-glucopyranosyl-(1 \rightarrow 3)-2-*N*-acetyl- α -L-fucosaminopyranosyl-(1 \rightarrow 3)-2-*N*-acetyl- β -D-fucosaminopyranoside

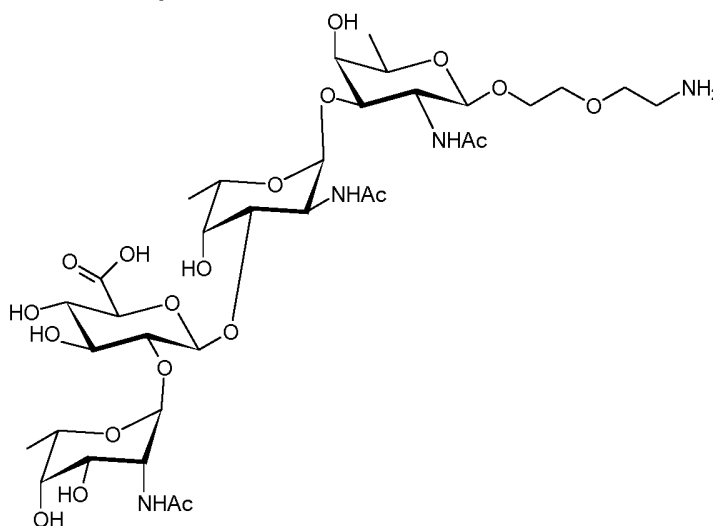

Chemical formula: C₃₄H₅₈N₄O₂₀; Exact mass: 842.3644.

33*b 3-amino-2,2-difluoro-propyl 2-*N*-acetyl- α -L-pneumosaminopyranosyl-(1 \rightarrow 2)- β -D-glucopyranosyl-(1 \rightarrow 3)-2-*N*-acetyl- α -L-fucosaminopyranosyl-(1 \rightarrow 3)-2-*N*-acetyl- β -D-fucosaminopyranoside

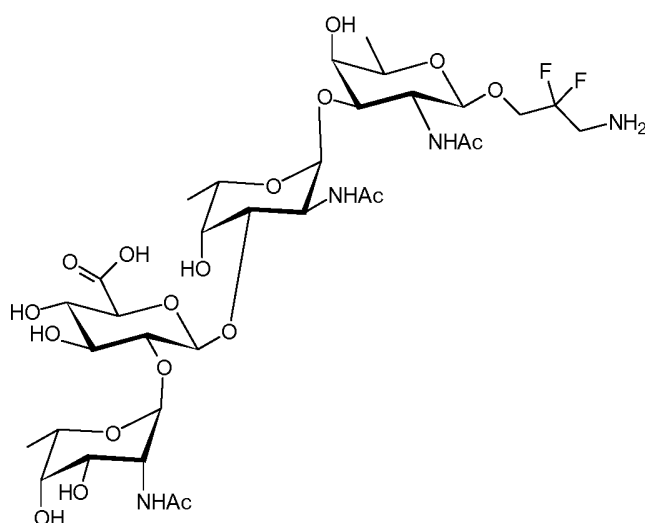

Chemical formula: $C_{33}H_{54}F_2N_4O_{19}$; Exact mass: 848.3350.

- 33*c** *N*-(2-*N*-acetyl- α -L-pneumosaminopyranosyl-(1 \rightarrow 2)- β -D-glucopyranosyl-(1 \rightarrow 3)-2-*N*-acetyl- α -L-fucosaminopyranosyl-(1 \rightarrow 3)-2-*N*-acetyl- β -D-fucosaminopyranosyl)-6-amino-hexanamide

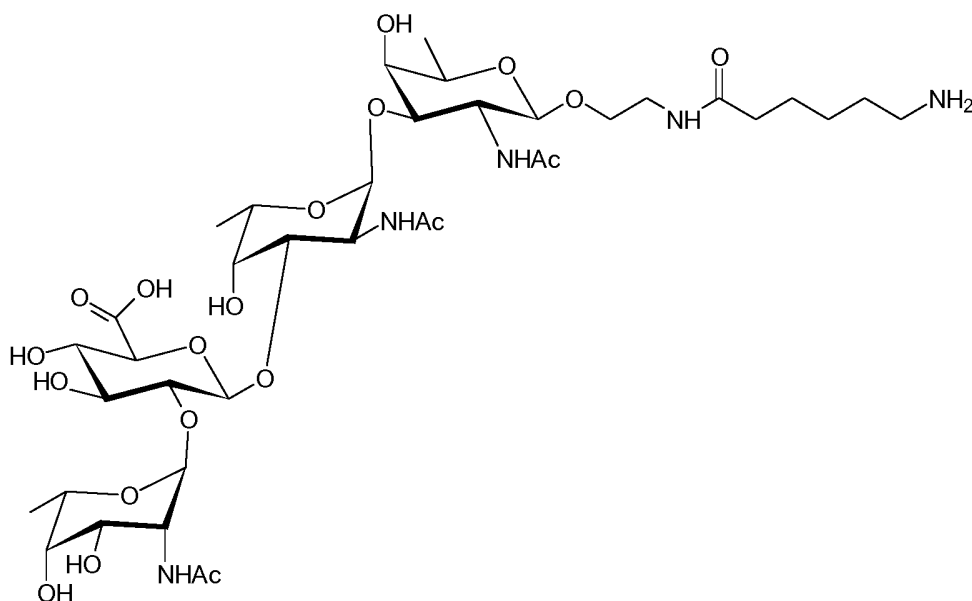

Chemical formula: $C_{38}H_{65}N_5O_{20}$; Exact mass: 911.4223.

- 33*d** *N*-(2-*N*-acetyl- α -L-pneumosaminopyranosyl-(1 \rightarrow 2)- β -D-glucopyranosyl-(1 \rightarrow 3)-2-*N*-acetyl- α -L-fucosaminopyranosyl-(1 \rightarrow 3)-2-*N*-acetyl- β -D-fucosaminopyranosyl 2-ethoxyethyl)-3-aminopropanamide

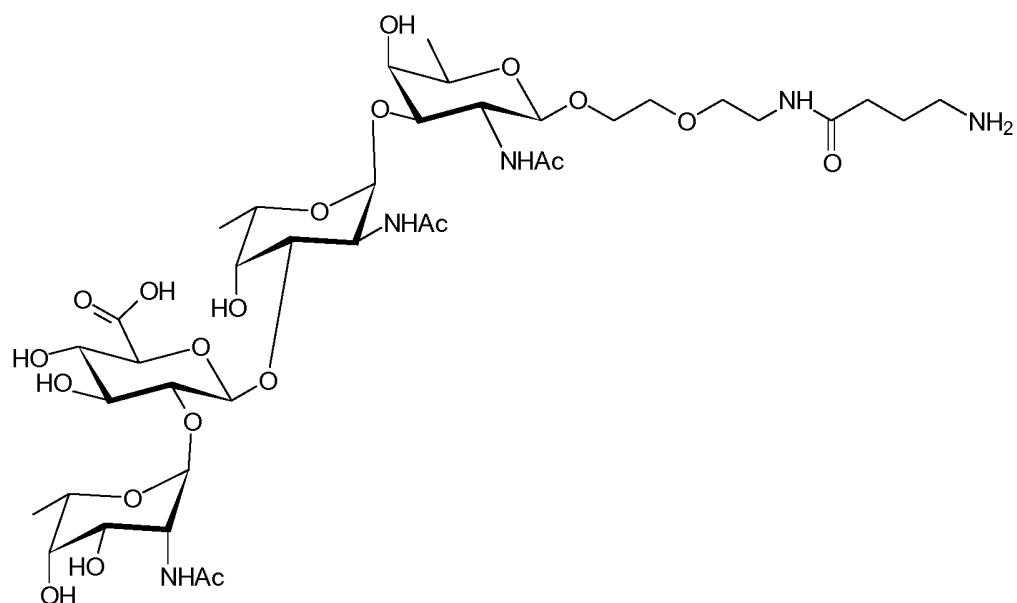

Chemical formula: $C_{38}H_{65}N_5O_{21}$; Exact mass: 927.4172.

33*e 3-(3-aminopropyl)ureido-propyl 2-*N*-acetyl- α -L-pneumosaminopyranosyl-(1 \rightarrow 2)- β -D-glucopyranosyl-(1 \rightarrow 3)-2-*N*-acetyl- α -L-fucosaminopyranosyl-(1 \rightarrow 3)-2-*N*-acetyl- β -D-fucosaminopyranoside

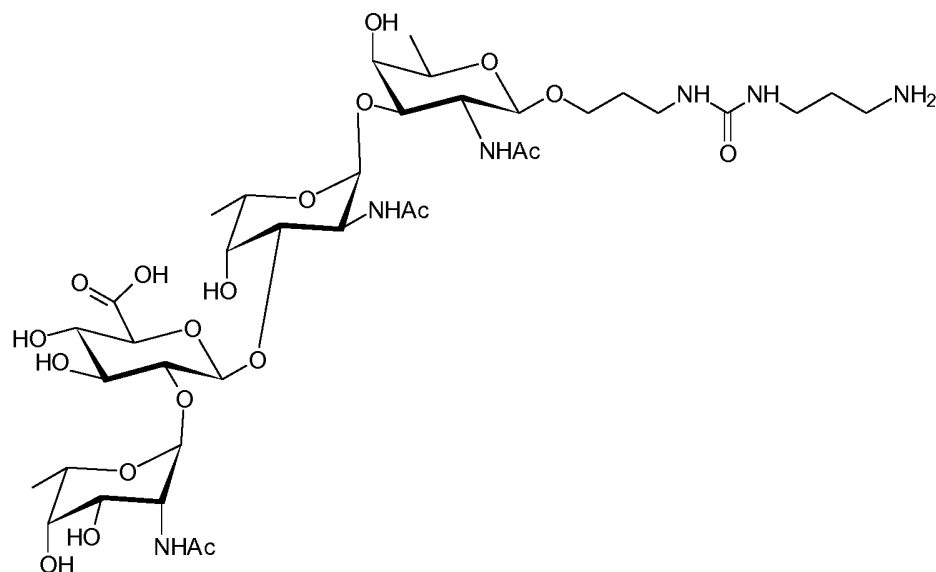

Chemical formula: $C_{37}H_{64}N_6O_{20}$; Exact mass: 912.4175.

Example 34: Synthesis of *N*-(Benzyl)benzyloxycarbonyl-5-amino-pentanyl 2-azido-3,4-di-*O*-benzyl-2-deoxy-L-pneumopyranosides (**34* α** and **34* β**)

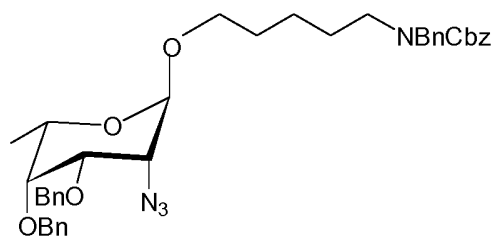
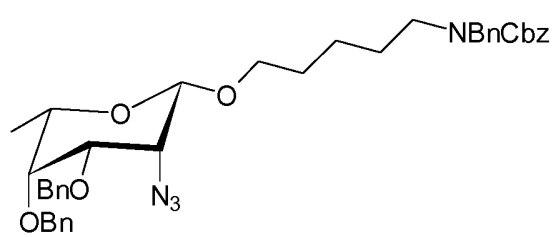
**34* α** **34* β**

According to general procedure (E), pneumosyl-imidate **8*** (30 mg, 58 μ mol) and *N*-(benzyl)benzyloxycarbonyl-5-amino-pentanol (38 mg, 117 μ mol) were reacted in DCM (1 mL) at -30 $^{\circ}$ C to -20 $^{\circ}$ C over 30 min to give α and β anomers **34* α** (28 mg, 41 μ mol, 71%) and **34* β** (10 mg, 15 μ mol, 25%). **34* α** : $[\alpha]_D^{20} = -18.0$ $^{\circ}$ ($c = 1.3$, CHCl_3); IR ν_{max} (film) 2934, 2111, 1697, 1496, 1454, 1422, 1360, 1229, 1061 cm^{-1} ; $^1\text{H-NMR}$ (400 MHz, CDCl_3) δ 7.60 – 7.06 (m, 20H), 5.18 (d, $J = 13.0$ Hz, 2H), 4.99 (d, $J = 11.7$ Hz, 1H), 4.79 – 4.69 (m, 3H), 4.64 (d, $J = 11.8$ Hz, 1H), 4.50 (d, $J = 6.9$ Hz, 2H), 3.98 – 3.85 (m, 2H), 3.83 – 3.73 (m, 1H), 3.62 (s, 1H), 3.58 – 3.45 (m, 1H), 3.37 – 3.15 (m, 3H), 1.58 – 1.41 (m, 4H), 1.31 – 1.16 (m, 5H); $^{13}\text{C-NMR}$ (100 MHz, CDCl_3) δ 138.4, 137.8, 128.8, 128.7, 128.6, 128.3, 128.1, 127.9 (2C), 127.7, 127.4, 98.6, 77.2, 75.2, 74.9, 71.2, 67.7, 67.3, 66.9, 58.1, 50.6, 50.3, 47.2, 46.2, 29.1, 23.5, 16.9. **34* β** : $[\alpha]_D^{20} = +59.2$ $^{\circ}$ ($c = 0.9$, CHCl_3); IR ν_{max} (film) 2928, 2110, 1697, 1496, 1454, 1421, 1359, 1229, 1119, 1070 cm^{-1} ; $^1\text{H-NMR}$ (400 MHz, CDCl_3) δ 7.55 – 7.09 (m, 20H), 5.17 (d, $J = 12.4$ Hz, 2H), 5.02 (d, $J = 11.9$ Hz, 1H), 4.77 – 4.70 (m, 2H), 4.62 (d, $J = 12.2$ Hz, 1H), 4.53 – 4.44 (m, 2H), 4.31 (d, $J = 14.7$ Hz, 1H), 3.96 – 3.78 (m, 2H), 3.52 (s, 2H), 3.44 – 3.14 (m, 4H), 1.62 – 1.45 (m, 4H), 1.38 – 1.20 (m, 5H); $^{13}\text{C-NMR}$ (100 MHz, CDCl_3) δ 138.6, 138.1, 137.6, 128.7, 128.6, 128.2, 128.1, 128.0, 127.9, 127.6 (2C), 127.4, 100.1, 78.8, 77.5, 77.2, 76.8, 74.8, 74.1, 71.8, 70.8, 69.3, 67.2, 58.8, 29.3, 23.4, 16.9; HRMS (MALDI-TOF): Calcd for $\text{C}_{40}\text{H}_{46}\text{N}_4\text{O}_6\text{Na}^+$ $[\text{M}+\text{Na}]^+$ 701.3310, found 701.3337.

Example 35: Synthesis of *N*-(benzyl)benzyloxycarbonyl-5-amino-pentanyl 2-*N*-acetyl-3,4-di-*O*-benzyl-*L*-pneumosaminopyranosides (**35* α** and **35* β**)

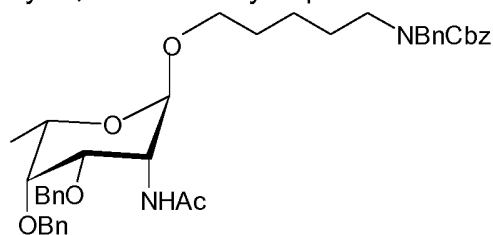
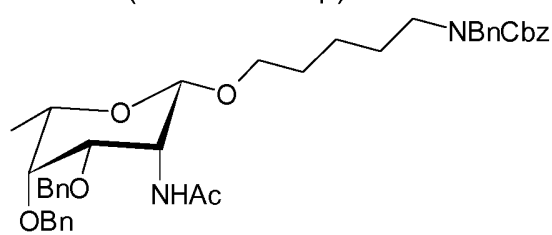
**35* α** **35* β**

According to general procedure (F), azido-pneumosides **34* α** (28 mg, 41 μ mol) and **34* β** (10 mg, 15 μ mol) were individually reacted with thioacetic acid for 12 h to give

35* α (19 mg, 27 μ mol, 66%) and **35* β** (7 mg, 10 μ mol, 68%). **35* α** : $[\alpha]_D^{20} = -47.4^\circ$ (c = 1.9, CHCl₃); IR ν_{\max} (film) 3404, 2935, 1698, 1675, 1515, 1497, 1454, 1421, 1361, 1305, 1228, 1120, 1055, 1040 cm⁻¹; ¹H-NMR (400 MHz, CDCl₃) δ 7.43 – 7.12 (m, 20H), 5.18 (d, *J* = 14.2 Hz, 2H), 4.90 (d, *J* = 10.3 Hz, 1H), 4.75 – 4.68 (m, 2H), 4.60 (d, *J* = 10.3 Hz, 1H), 4.56 – 4.40 (m, 4H), 3.92 – 3.79 (m, 2H), 3.67 – 3.60 (m, 1H), 3.59 – 3.15 (m, 5H), 1.74 (s, 3H), 1.61 – 1.40 (m, 4H), 1.35 – 1.15 (m, 5H); ¹³C-NMR (100 MHz, CDCl₃) δ 170.4, 138.3, 138.2, 138.0, 128.7, 128.6, 128.5 (2C), 128.2, 128.1, 127.9, 127.7 (2C), 127.4, 127.3, 100.1, 78.7, 75.7, 72.8, 69.9, 67.7, 67.3, 66.3, 50.6, 50.3, 48.0, 47.2, 46.2, 29.3, 28.1, 27.7, 23.5, 16.8. **35* β** : $[\alpha]_D^{20} = +18.3^\circ$ (c = 0.7, CHCl₃); IR ν_{\max} (film) 3420, 2929, 2865, 1698, 1677, 1521, 1454, 1421, 1367, 1312, 1230, 1113, 1058 cm⁻¹; ¹H-NMR (400 MHz, CDCl₃) δ 7.42 – 7.13 (m, 20H), 6.79 (d, *J* = 9.8 Hz, 1H), 5.16 (d, *J* = 11.6 Hz, 2H), 4.91 (d, *J* = 10.2 Hz, 1H), 4.84 – 4.73 (m, 2H), 4.58 (d, *J* = 10.2 Hz, 1H), 4.52 – 4.42 (m, 3H), 4.28 (d, *J* = 13.1 Hz, 1H), 3.80 – 3.65 (m, 1H), 3.59 – 3.51 (m, 2H), 3.50 – 3.35 (m, 2H), 3.27 – 3.10 (m, 2H), 1.76 (s, 3H), 1.59 – 1.43 (m, 4H), 1.34 – 1.17 (m, 5H); ¹³C-NMR (100 MHz, CDCl₃) δ 170.7, 138.2, 138.1, 128.8, 128.6 (2C), 128.5, 128.1, 128.0, 127.9 (2C), 127.8, 127.3, 100.5, 77.7, 76.2, 75.7, 71.4, 69.8, 67.2, 47.9, 29.3, 23.6, 23.3, 16.8; HRMS (MALDI-TOF): Calcd for C₄₂H₅₀N₂O₇Na⁺ [M+Na]⁺ 717.3510, found 717.3543.

20

Example 36: Synthesis of 5-amino-pentanyl 2-*N*-acetyl-L-pneumosaminopyranosides (**36*** and **37***)

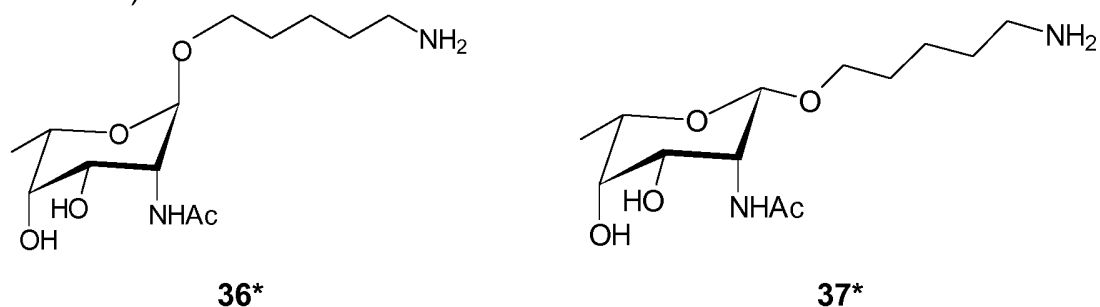

According to general procedure (I), pneumosaminosides **35* α** (19 mg, 27 μ mol) and **35* β** (7 mg, 10 μ mol) were individually submitted to hydrogenolysis to give **36*** (7 mg, 24 μ mol, 88%) and **37*** (2 mg, 7 μ mol, 68%), respectively. **36***: ¹H-NMR (400 MHz, D₂O) δ 4.75 (s, 1H), 4.13 – 3.93 (m, 3H), 3.78 (s, 1H), 3.71 – 3.61 (m, 1H), 3.55 – 3.44 (m, 1H), 3.03 – 2.91 (m, 2H), 2.01 (s, 3H), 1.74 – 1.57 (m, 4H), 1.49 – 1.35 (m, 2H), 1.22 (d, *J* = 6.6 Hz, 3H); ¹³C-NMR (150 MHz, D₂O) δ 176.8, 101.6, 73.5, 70.2, 69.5, 66.6, 53.9, 42.0, 30.5, 29.2, 25.0, 18.1. **37***: ¹H-NMR (400 MHz, D₂O) δ 4.61 (d, *J* = 1.7 Hz, 1H), 4.29 (d, *J* = 5.0 Hz, 1H), 3.88 (dd, *J* = 4.5, 3.4 Hz, 1H), 3.81 (dt, *J* = 9.9, 6.3 Hz, 1H), 3.71 – 3.58 (m, 3H), 3.00 – 2.93 (m, 2H), 2.02 (s, 3H), 1.68 – 1.54 (m, 4H), 1.42 – 1.33 (m, 2H), 1.25 (d, *J* = 6.5 Hz, 3H); ¹³C-NMR (150 MHz,

30

D₂O) δ 177.2, 102.4, 74.2, 72.9, 72.0, 70.1, 54.5, 42.0, 30.8, 29.3, 25.9, 25.2, 24.8, 18.0; HRMS (ESI): Calcd for C₁₃H₂₆N₂O₅Na⁺ [M+Na]⁺ 313.1739, found 313.1750.

Example 37: Synthesis of thexyldimethylsilyl 3-O-acetyl-2-azido-2-deoxy- α -L-fucopyranoside (**38***) and thexyldimethylsilyl 4-O-acetyl-2-azido-2-deoxy- α -L-fucopyranoside (**39***)



To a solution of 2-azido-2-deoxy- α -L-fucopyranoside (200 mg, 0.60 mmol) in DCM/pyridine (4:1 (v/v), 10 mL), a solution of AcCl (51 μ L, 0.72 mmol) in DCM (1 mL) was added drop-wise at 0 °C and stirred for 6 h at the same temperature. The mixture was diluted with DCM and washed with sat. aq. NaHCO₃. The combined organic layers were dried over MgSO₄, filtered and concentrated. Column chromatography on silica gel (DCM/MeOH/acetone) afforded **38*** (163 mg, 0.44 mmol, 72%). $[\alpha]_D^{20} = + 4.4$ ° (c = 1.0, CHCl₃); IR ν_{\max} (film) 3483, 2958, 2868, 2111, 1747, 1726, 1465, 1370, 1251, 1171, 1145, 1069, 1039 cm⁻¹; ¹H-NMR (400 MHz, CDCl₃) δ 4.66 (dd, *J* = 10.8, 3.1 Hz, 1H), 4.50 (d, *J* = 7.6 Hz, 1H), 3.77 (d, *J* = 2.6 Hz, 1H), 3.61 (qd, *J* = 6.4, 0.8 Hz, 1H), 3.55 (dd, *J* = 10.8, 7.6 Hz, 1H), 2.16 (s, 3H), 1.66 (dt, *J* = 13.7, 6.9 Hz, 1H), 1.28 (d, *J* = 6.5 Hz, 3H), 0.89 (d, *J* = 1.0 Hz, 3H), 0.88 (s, 9H), 0.19 (s, 6H); ¹³C-NMR (100 MHz, CDCl₃) δ 170.3, 97.3, 74.0, 70.4, 69.5, 63.5, 34.0, 25.0, 21.2, 20.1, 20.0, 18.6, 18.5, 16.4, -1.9, -3.2; HRMS (MALDI-TOF): Calcd for C₁₆H₃₁N₃O₅SiNa⁺ [M+Na]⁺ 396.1925, found 396.1911. Thexyldimethylsilyl 4-O-acetyl-2-azido-2-deoxy- α -L-fucopyranoside (**39***) (22 mg, 0.06 mmol, 10%) was obtained as a byproduct. $[\alpha]_D^{20} = + 5.3$ ° (c = 1.3, CHCl₃); IR ν_{\max} (film) 3462, 2959, 2869, 2112, 1744, 1465, 1443, 1380, 1252, 1185, 1114, 1073 cm⁻¹; ¹H-NMR (400 MHz, CDCl₃) δ 5.09 (dd, *J* = 3.5, 1.1 Hz, 1H), 4.48 (d, *J* = 7.6 Hz, 1H), 3.65 (qd, *J* = 6.4, 1.2 Hz, 1H), 3.57 (dd, *J* = 10.4, 3.6 Hz, 1H), 3.40 (dd, *J* = 10.4, 7.6 Hz, 1H), 2.19 (s, 3H), 1.68 (dt, *J* = 13.7, 6.9 Hz, 1H), 1.17 (d, *J* = 6.5 Hz, 3H), 0.93 – 0.86 (m, 12H), 0.19 (d, *J* = 1.6 Hz, 6H); ¹³C-NMR (100 MHz, CDCl₃) δ 171.7, 97.2, 71.9, 71.1, 69.4, 66.5, 34.0, 25.0, 21.0, 20.1, 20.0, 18.6, 18.3, 16.5, -1.9, -3.0; HRMS (MALDI-TOF): Calcd for C₁₆H₃₁N₃O₅SiNa⁺ [M+Na]⁺ 396.1925, found 396.1954.

Example 38: Synthesis of thexyltrimethylsilyl 2-O-benzoyl-3,4,6-tri-O-benzyl- β -D-glucopyranosyl-(1 \rightarrow 3)-4-O-acetyl-2-azido-2-deoxy- α -L-fucopyranoside (**40***)

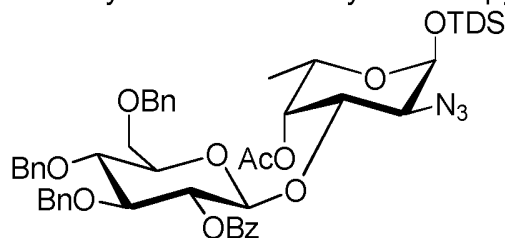

According to general procedure (B), 2-O-benzoyl-3,4,6-tri-O-benzyl-1-thio- β -D-glucopyranoside (109 mg, 0.18 mmol) was reacted with fucoside **39*** (62 mg, 0.17 mmol), NIS (45 mg, 0.20 mmol) and TfOH (1.8 μ L, 20 μ mol) in DCM (1 mL) at -25 $^{\circ}$ C to -20 $^{\circ}$ C over 1 h. After workup column chromatography (hexanes/EtOAc) afforded **40*** (139 mg, 0.15 mmol, 92%). $[\alpha]_D^{20} = -13.9^{\circ}$ ($c = 1.9$, CHCl_3); IR ν_{max} (film) 2958, 2867, 2113, 1744, 1496, 1453, 1364, 1267, 1234, 1179, 1095, 1071 cm^{-1} ; $^1\text{H-NMR}$ (400 MHz, CDCl_3) δ 8.10 – 8.03 (m, 2H), 7.60 – 7.54 (m, 1H), 7.50 – 7.42 (m, 2H), 7.41 – 7.21 (m, 10H), 7.16 – 7.02 (m, 5H), 5.32 (dd, $J = 9.1, 7.7$ Hz, 1H), 5.12 (d, $J = 2.8$ Hz, 1H), 4.82 (d, $J = 11.0$ Hz, 1H), 4.76 – 4.66 (m, 4H), 4.63 (dd, $J = 11.0, 6.5$ Hz, 2H), 4.36 (d, $J = 7.7$ Hz, 1H), 3.89 (dd, $J = 10.4, 3.5$ Hz, 1H), 3.86 – 3.80 (m, 2H), 3.79 – 3.72 (m, 2H), 3.62 (ddd, $J = 9.4, 5.3, 1.9$ Hz, 1H), 3.50 – 3.41 (m, 2H), 1.73 – 1.62 (m, 1H), 1.49 (s, 3H), 1.07 (d, $J = 6.4$ Hz, 3H), 0.92 – 0.87 (m, 12H), 0.17 (d, $J = 4.6$ Hz, 6H); $^{13}\text{C-NMR}$ (100 MHz, CDCl_3) δ 170.6, 164.9, 138.6, 138.0, 137.8, 133.3, 130.2, 129.8, 128.6, 128.5, 128.4, 128.3, 128.2, 128.1, 128.0, 127.7, 127.6 (2C), 97.1, 96.8, 83.0, 78.1, 75.7, 75.3, 75.1, 74.6, 73.7, 73.5, 69.0, 68.9, 67.8, 63.9, 34.0, 25.0, 20.2, 20.1 (2C), 18.6 (2C), 16.5, -1.8, -3.0; HRMS (MALDI-TOF): Calcd for $\text{C}_{50}\text{H}_{63}\text{N}_3\text{O}_{11}\text{SiNa}^+ [\text{M}+\text{Na}]^+$ 932.4124, found 932.4125.

Example 39: Synthesis of 2-O-benzoyl-3,4,6-tri-O-benzyl- β -D-glucopyranosyl-(1 \rightarrow 3)-4-O-acetyl-2-azido-2-deoxy- α -L-fucopyranosyl trichloroacetimidate (**41***)

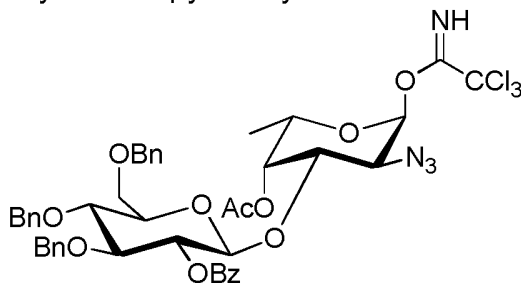

According to general procedure (A), disaccharide **40*** (55 mg, 60 μ mol) was reacted with TBAF (1 m in THF, 600 μ L, 600 μ mol) and AcOH (42 μ L, 725 μ mol) in THF (2 mL) to give the crude lactol. According to general procedure (D), the crude lactol was reacted with trichloroacetonitrile (60 μ L, 600 μ mol) and DBU in DCM (2 mL) at 0 $^{\circ}$ C to afford **41*** (44 mg, 48 μ mol, 81%). $[\alpha]_D^{20} = -64.8^{\circ}$ ($c = 1.8$, CHCl_3); IR ν_{max} (film) 2871, 2115, 1743, 1673, 1496, 1453, 1361, 1267, 1229, 1093, 1070, 1027 cm^{-1} ; $^1\text{H-NMR}$

NMR (400 MHz, CDCl₃) δ 8.67 (s, 1H), 8.11 – 8.03 (m, 2H), 7.60 – 7.56 (m, 1H), 7.50 – 7.43 (m, 2H), 7.42 – 7.26 (m, 8H), 7.24 – 7.18 (m, 2H), 7.16 – 7.03 (m, 5H), 6.35 (d, *J* = 3.6 Hz, 1H), 5.38 – 5.30 (m, 2H), 4.84 – 4.78 (m, 2H), 4.73 (d, *J* = 11.0 Hz, 1H), 4.67 – 4.54 (m, 5H), 4.21 (q, *J* = 6.4 Hz, 1H), 3.88 – 3.71 (m, 5H), 3.61 (ddd, *J* = 9.5, 4.7, 1.8 Hz, 1H), 1.44 (s, 3H), 1.08 (d, *J* = 6.5 Hz, 3H); ¹³C-NMR (100 MHz, CDCl₃) δ 170.3, 165.0, 160.9, 138.3, 137.9, 137.8, 133.4, 130.3, 129.7, 128.6, 128.5 (2C), 128.4, 128.2, 128.1, 128.0, 127.8, 127.7, 96.8, 95.4, 91.1, 82.9, 78.1, 75.8, 75.4, 75.2, 73.9, 73.7, 70.8, 69.0, 68.2, 68.0, 57.2, 19.9, 16.3; HRMS (ESI): Calcd for C₄₄H₄₅Cl₃N₄O₁₁Na⁺ [M+Na]⁺ 933.2048, found 933.2051.

10

Example 40: Synthesis of *N*-(benzyl)benzyloxycarbonyl-5-amino-pentanyl 2-*O*-benzoyl-3,4,6-tri-*O*-benzyl-β-D-glucopyranosyl-(1→3)-4-*O*-acetyl-2-azido-2-deoxy-L-fucopyranoside (**42***)

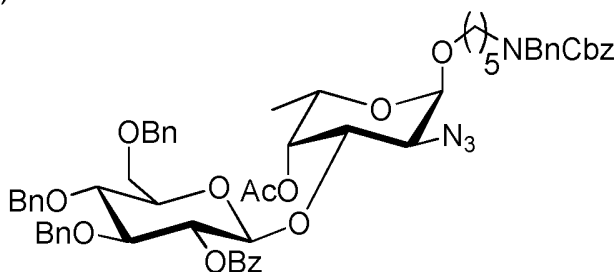

15 According to general procedure (E), disaccharide-imidate **41*** (44 mg, 48 μmol) and *N*-(benzyl)benzyloxycarbonyl-5-amino-pentanol (32 mg, 96 μmol) were reacted in DCM (2 mL) at –30 °C to –20 °C over 30 min to give the α and β anomers of **42*** (45 mg, 42 μmol, 87%) in a ratio α/β=1:6. Analytical data is given for the α anomer. [α]_D²⁰ = –68.5 ° (c = 0.5, CHCl₃); IR ν_{max} (film) 2927, 2111, 1743, 1698, 1454, 1267, 1091
 20 cm⁻¹; ¹H-NMR (400 MHz, CDCl₃) δ 8.06 (d, *J* = 7.9 Hz, 2H), 7.57 (t, *J* = 7.4 Hz, 1H), 7.44 (d, *J* = 7.6 Hz, 2H), 7.39 – 7.27 (m, 15H), 7.23 – 7.01 (m, 10H), 5.31 (t, *J* = 8.4 Hz, 1H), 5.25 (s, 1H), 5.16 (d, *J* = 7.8 Hz, 2H), 4.85 – 4.78 (m, 2H), 4.74 – 4.69 (m, 2H), 4.63 – 4.52 (m, 4H), 4.45 (s, 3H), 4.01 – 3.90 (m, 1H), 3.85 – 3.69 (m, 4H), 3.59 (dd, *J* = 8.6, 4.1 Hz, 2H), 3.41 (dd, *J* = 10.8, 3.6 Hz, 2H), 3.18 (d, *J* = 20.7 Hz, 2H),
 25 1.56 – 1.43 (m, 4H), 1.42 (s, 3H), 1.35 – 1.18 (m, 3H), 1.02 (d, *J* = 6.4 Hz, 3H); ¹³C-NMR (100 MHz, CDCl₃) δ 170.5, 165.0, 138.4, 138.0, 137.8, 133.3, 130.3, 129.8, 128.7, 128.6, 128.5, 128.4, 128.3, 128.2, 128.1, 128.0, 127.9, 127.7 (2C), 98.6, 97.4, 83.1, 78.1, 77.4, 75.7, 75.4, 75.2, 73.7, 73.6, 70.9, 69.1, 68.9, 68.5, 67.3, 65.0, 57.8, 50.6, 47.2, 46.2, 29.2, 23.4, 20.0, 16.3; HRMS (ESI): Calcd for C₆₂H₆₈N₄O₁₃Na⁺
 30 [M+Na]⁺ 1099.4681, found 1099.4679.

Example 41: Synthesis of *N*-(benzyl)benzyloxycarbonyl-5-amino-pentanyl 2-*O*-benzoyl-3,4,6-tri-*O*-benzyl-α-D-glucopyranosyl-(1→3)-2-*N*-acetyl-4-*O*-acetyl-α-L-fucosaminopyranoside (**43***)

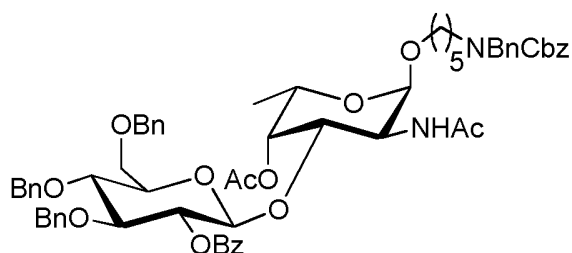

According to general procedure (F), azido-disaccharide **42*** (10 mg, 9 μmol) was reacted with thioacetic acid for 48 h to give **43*** (8 mg, 7 μmol , 79%). $[\alpha]_D^{20} = -5.5^\circ$ (c = 1.0, CHCl_3); IR ν_{max} (film) 2928, 1743, 1697, 1454, 1365, 1266, 1232, 1091 cm^{-1} ;
 5 $^1\text{H-NMR}$ (400 MHz, CDCl_3) δ 8.06 – 8.01 (m, 2H), 7.61 – 7.55 (m, 1H), 7.47 – 7.42 (m, 2H), 7.38 – 7.26 (m, 15H), 7.26 – 7.20 (m, 2H), 7.18 – 7.06 (m, 8H), 6.50 – 6.27 (m, 1H), 5.22 – 5.12 (m, 5H), 4.80 (d, $J = 10.9$ Hz, 1H), 4.69 (d, $J = 10.9$ Hz, 1H), 4.66 – 4.60 (m, 2H), 4.50 (dd, $J = 22.3, 11.3$ Hz, 5H), 4.08 (s, 2H), 3.98 – 3.86 (m, 1H),
 10 3.82 – 3.49 (m, 6H), 3.43 – 3.28 (m, 1H), 3.28 – 3.06 (m, 2H), 1.83 (s, 3H), 1.64 (s, 3H), 1.55 – 1.42 (m, 4H), 1.29 – 1.16 (m, 2H), 1.01 (d, $J = 6.5$ Hz, 3H); $^{13}\text{C-NMR}$ (100 MHz, CDCl_3) δ 170.7, 165.1, 138.0, 137.8, 137.6, 133.3, 130.1, 129.8, 128.7 (2C), 128.6, 128.4 (2C), 128. (2C), 127.9, 127.8, 98.9, 97.1, 82.9, 77.8, 77.4, 75.2 (2C), 74.5, 73.5, 73.3, 72.6, 69.9, 68.9, 68.3, 67.3, 64.8, 49.7, 29.2, 23.4, 23.1, 20.2,
 15 16.3; HRMS (MALDI-TOF): Calcd for $\text{C}_{64}\text{H}_{72}\text{N}_2\text{O}_{14}\text{Na}^+$ $[\text{M}+\text{Na}]^+$ 1115.4876, found 1115.4890.

Example 42: Synthesis of 5-amino-pentanyl β -D-glucopyranosyl-(1 \rightarrow 3)-2-N-acetyl- α -L-fucosaminopyranoside (**44***)

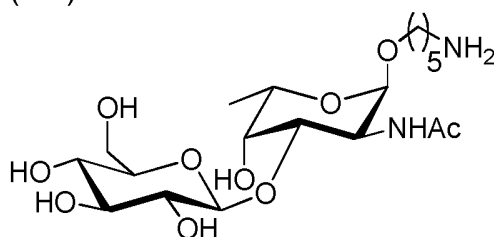

To a solution of **43*** (8 mg, 7 μmol) in MeOH (1 mL) was added 0.5 m NaOMe in MeOH (0.2 mL) and stirred for 16 h. The mixture was neutralized with Amberlite[®] IR 120 (H^+) ion exchange resin and the resulting diol was filtered and concentrated.
 According to general procedure (I), the crude diol was submitted to hydrogenolysis to
 25 give **44*** (3.4 mg, 7.5 μmol , 89%). $^1\text{H-NMR}$ (600 MHz, D_2O) δ 4.95 (d, $J = 3.7$ Hz, 1H), 4.55 (d, $J = 7.9$ Hz, 1H), 4.19 (dd, $J = 11.3, 3.7$ Hz, 1H), 4.13 (dd, $J = 11.3, 2.9$ Hz, 1H), 4.09 (q, $J = 6.6$ Hz, 1H), 4.03 (d, $J = 2.5$ Hz, 1H), 3.98 (dd, $J = 12.2, 2.1$ Hz, 1H), 3.75 – 3.68 (m, 2H), 3.54 – 3.45 (m, 3H), 3.38 (t, $J = 9.5$ Hz, 1H), 3.31 (dd, $J = 9.4, 8.0$ Hz, 1H), 3.03 – 2.98 (m, 2H), 2.05 (s, 3H), 1.73 – 1.62 (m, 4H), 1.49 – 1.41
 30 (m, 2H), 1.27 (d, $J = 6.6$ Hz, 3H); $^{13}\text{C-NMR}$ (150 MHz, D_2O) δ 177.1, 103.0, 99.3,

78.7, 78.1, 77.8, 75.4, 72.3, 71.3, 70.4, 69.0, 63.6, 50.9, 42.0, 30.5, 29.0, 24.8, 24.6, 18.1; HRMS (ESI): Calcd for $C_{19}H_{36}N_2O_{10}Na^+$ $[M+Na]^+$ 475.2268, found 475.2273.

Example 43: Synthesis of thexyldimethylsilyl 3,4-di-O-benzyl-2-O-levulinoyl-6-O-(2-naphthalenylmethyl)- β -D-glucopyranosyl-(1 \rightarrow 4)-3-O-acetyl-2-azido-2-deoxy- α -L-fucopyranoside (**45***)

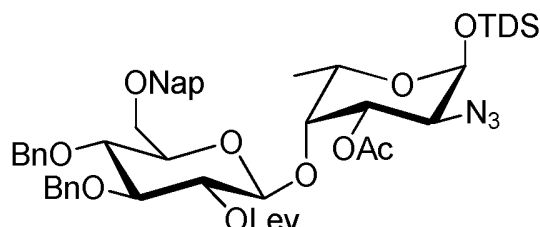

According to general procedure (B), thioglucoside **10*** (140 mg, 218 μ mol) was reacted with fucoside **38*** (50 mg, 134 μ mol), NIS (54 mg, 240 μ mol) and TfOH (2.4 μ L, 27 μ mol) in DCM (1 mL) at -30 $^{\circ}$ C to -20 $^{\circ}$ C over 1 h. After work-up, column chromatography (hexanes/EtOAc) afforded **45*** (114 mg, 119 μ mol, 89%). $[\alpha]_D^{20} = -13.0$ $^{\circ}$ ($c = 1.8$, $CHCl_3$); IR ν_{max} (film) 2958, 2867, 2112, 1748, 1721, 1603, 1509, 1455, 1364, 1240, 1147, 1072 cm^{-1} ; 1H -NMR (400 MHz, $CDCl_3$) δ 7.87 – 7.76 (m, 4H), 7.52 – 7.43 (m, 3H), 7.35 – 7.25 (m, 5H), 7.23 – 7.12 (m, 3H), 7.04 – 6.98 (m, 2H), 5.16 (dd, $J = 9.6, 8.1$ Hz, 1H), 4.80 – 4.75 (m, 3H), 4.70 (d, $J = 12.1$ Hz, 1H), 4.60 (d, $J = 12.2$ Hz, 1H), 4.49 – 4.39 (m, 3H), 4.30 (d, $J = 8.1$ Hz, 1H), 3.94 (d, $J = 3.4$ Hz, 1H), 3.85 – 3.79 (m, 1H), 3.76 – 3.65 (m, 3H), 3.58 (dd, $J = 11.0, 7.6$ Hz, 1H), 3.52 (q, $J = 6.5$ Hz, 1H), 3.39 (ddd, $J = 9.8, 3.5, 2.0$ Hz, 1H), 2.93 – 2.81 (m, 1H), 2.68 – 2.63 (m, 1H), 2.62 – 2.58 (m, 1H), 2.54 – 2.45 (m, 1H), 2.16 (s, 3H), 2.11 (s, 3H), 1.67 (dt, $J = 13.7, 6.9$ Hz, 1H), 1.25 (d, $J = 6.5$ Hz, 3H), 0.92 (s, 3H), 0.90 (s, 3H), 0.89 (s, 6H), 0.18 (s, 3H), 0.15 (s, 3H); ^{13}C -NMR (100 MHz, $CDCl_3$) δ 206.4, 171.4, 171.2, 138.3, 137.9, 135.1, 133.3, 133.1, 128.4 (3C), 128.1, 128.0, 127.9, 127.8 (3C), 126.6, 126.3, 126.1, 125.8, 101.9, 97.2, 82.9, 77.5, 75.1, 75.0 (2C), 74.3, 73.8, 73.4, 72.8, 70.0, 68.7, 62.8, 38.1, 34.0, 29.9, 28.0, 24.9, 21.0, 20.0 (2C), 18.6, 18.5, 16.4, -2.0, -3.1; HRMS (MALDI-TOF): Calcd for $C_{52}H_{67}N_3O_{12}SiNa^+$ $[M+Na]^+$ 976.4386, found 976.4333.

Example 44: Synthesis of 3,4-di-O-benzyl-2-O-levulinoyl-6-O-(2-naphthalenylmethyl)- β -D-glucopyranosyl-(1 \rightarrow 4)-3-O-acetyl-2-azido-2-deoxy-L-fucopyranoside (**46***)

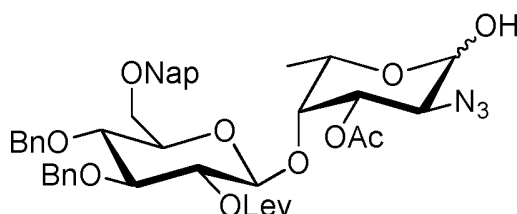

According to general procedure (A), disaccharide **45*** (105 mg, 0.11 mmol) was reacted with TBAF (1.0 mL, 1.00 mmol) and AcOH (70 μ L, 1.22 mmol) in THF (2 mL) to give lactol **46*** (81 mg, 0.10 mmol, 95%) as a mixture of α and β anomers. IR ν_{\max} (film) 3424, 2869, 2111, 1742, 1717, 1454, 1363, 1237, 1151, 1059 cm^{-1} ; $^1\text{H-NMR}$ (400 MHz, CDCl_3) δ 7.87 – 7.75 (m, 4H), 7.53 – 7.41 (m, 3H), 7.34 – 7.25 (m, 5H), 7.22 – 7.10 (m, 3H), 7.03 – 6.95 (m, 2H), 5.37 – 5.28 (m, 0.5H) 5.25 (d, $J = 3.5$ Hz, 0.5H), 5.16 – 5.02 (m, 1.5H), 4.80 – 4.65 (m, 4H), 4.60 (d, $J = 12.1$ Hz, 1H), 4.50 – 4.43 (m, 2H), 4.35 (d, $J = 8.0$ Hz, 0.5H), 4.31 (d, $J = 8.1$ Hz, 0.5H), 4.19 (q, $J = 6.6$ Hz, 0.5H), 4.07 (dd, $J = 11.1, 3.1$ Hz, 1H), 3.88 – 3.56 (m, 6H), 3.41 – 3.35 (m, 1H), 2.92 – 2.62 (m, 2H), 2.55 – 2.44 (m, 1H), 2.24 (s, 1.5H), 2.15 (s, 1.5H), 2.12 (s, 1.5H), 2.09 (s, 1.5H), 1.29 (d, $J = 6.5$ Hz, 1.5H), 1.19 (d, $J = 6.6$ Hz, 1.5H); $^{13}\text{C-NMR}$ (100 MHz, CDCl_3) δ 208.9, 206.4, 171.9, 171.7, 171.2, 171.1, 138.5, 138.4, 137.9, 135.1 (2C), 133.3, 133.1, 128.5 (2C), 128.4 (2C), 128.1, 127.9 (4C), 127.8 (3C), 127.7, 126.8, 126.6, 126.4, 126.1, 125.9, 125.8, 101.7, 100.9, 96.8, 92.2, 83.0, 82.9, 77.8, 77.6, 75.4, 75.2, 75.1, 75.0 (2C), 73.9 (2C), 73.6, 73.3, 72.8, 70.7, 70.4, 68.8, 68.6, 65.8, 62.8, 57.9, 38.1, 37.6, 30.5, 30.0, 28.1 (2C), 21.1, 21.0, 17.0, 16.3; HRMS (MALDI-TOF): Calcd for $\text{C}_{44}\text{H}_{49}\text{N}_3\text{O}_{12}\text{Na}^+$ $[\text{M}+\text{Na}]^+$ 834.3208, found 834.3222.

Example 45: Synthesis of 3,4-di-O-benzyl-2-O-levulinoyl-6-O-(2-naphthalenylmethyl)- β -D-glucopyranosyl-(1 \rightarrow 4)-3-O-acetyl-2-azido-2-deoxy-L-fucopyranosyl trichloroacetimidate (**47***)

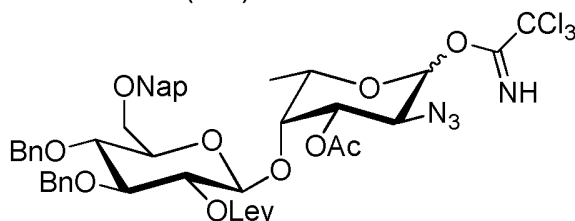

According to general procedure (D), lactol **46*** (81 mg, 100 μ mol) was reacted with trichloroacetonitrile (100 μ L, 998 μ mol) and DBU in DCM (2 mL) at 0 $^{\circ}\text{C}$ to afford **47*** (82 mg, 86 μ mol, 86%) as a mixture of α and β anomers. Analytical data is given for the α anomer. $[\alpha]_{\text{D}}^{20} = -88.7^{\circ}$ ($c = 1.5$, CHCl_3); IR ν_{\max} (film) 3336, 3060, 3030, 2906, 2868, 2113, 1746, 1718, 1673, 1363, 1273, 1243, 1144, 1063, 1028 cm^{-1} ; $^1\text{H-NMR}$ (400 MHz, CDCl_3) δ 8.67 (s, 1H), 7.90 – 7.75 (m, 4H), 7.52 – 7.42 (m, 3H), 7.35 – 7.25 (m, 5H), 7.23 – 7.10 (m, 3H), 7.05 – 6.96 (m, 2H), 6.36 (d, $J = 3.6$ Hz, 1H), 5.14 (dd, $J = 9.6, 8.1$ Hz, 1H), 5.08 (dd, $J = 11.1, 3.1$ Hz, 1H), 4.80 – 4.69 (m, 4H), 4.60 (d, $J = 12.1$ Hz, 1H), 4.47 (d, $J = 10.8$ Hz, 1H), 4.34 (d, $J = 8.0$ Hz, 1H), 4.22 – 4.13 (m, 2H), 4.10 (dd, $J = 11.1, 3.6$ Hz, 1H), 3.87 – 3.72 (m, 3H), 3.71 – 3.64 (m, 1H), 3.40 (ddd, $J = 9.8, 3.5, 2.0$ Hz, 1H), 2.84 – 2.64 (m, 2H), 2.61 – 2.46 (m, 2H), 2.17 (s, 3H), 2.13 (s, 3H), 1.24 (d, $J = 6.6$ Hz, 3H); $^{13}\text{C-NMR}$ (100 MHz, CDCl_3) δ 206.3, 171.7, 171.0, 161.1, 138.3, 137.9, 135.0, 133.3, 133.2, 128.5, 128.4, 128.1,

128.0, 127.9, 127.8 (2C), 126.7, 126.4, 126.1, 125.9, 101.7, 95.2, 91.1, 82.9, 77.5, 75.1, 74.5, 73.9, 73.5, 70.7, 68.7, 68.5, 56.6, 38.1, 30.0, 28.1, 21.0, 16.3; HRMS (ESI): Calcd for $C_{46}H_{49}Cl_3N_4O_{12}Na^+$ $[M+Na]^+$ 977.2310, found 977.2312.

- 5 **Example 46:** Synthesis of *N*-(benzyl)benzyloxycarbonyl-5-amino-pentanyl 3,4-di-*O*-benzyl-2-*O*-levulinoyl-6-*O*-(2-naphthalenylmethyl)- β -*D*-glucopyranosyl-(1 \rightarrow 4)-3-*O*-acetyl-2-azido-2-deoxy-*L*-fucopyranoside (**48***)

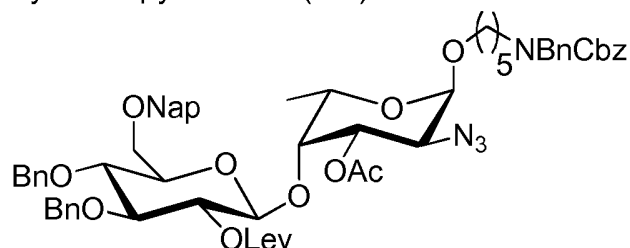

- According to general procedure (E), disaccharide-imidate **47*** (17 mg, 18 μ mol) and
- 10 *N*-(benzyl)benzyloxycarbonyl-5-amino-pentanol (12 mg, 36 μ mol) were reacted in DCM (1 mL) at -30 $^{\circ}$ C to -20 $^{\circ}$ C over 30 min to give the α and β anomers of **48*** (18 mg, 16 μ mol, 90%) in a ratio $\alpha/\beta=1:3$. Analytical data is given for the α anomer. $[\alpha]_D^{20} = -70.3$ $^{\circ}$ ($c = 0.3$, $CHCl_3$); IR ν_{max} (film) 2936, 2110, 1746, 1699, 1497, 1454, 1421, 1362, 1244, 1131, 1054 cm^{-1} ; 1H -NMR (400 MHz, $CDCl_3$) δ 7.84 – 7.73 (m, 4H), 7.49 – 7.40 (m, 3H), 7.34 – 7.21 (m, 14H), 7.19 – 7.09 (m, 4H), 7.00 – 6.95 (m, 2H), 5.18 – 5.07 (m, 3H), 5.00 (dd, $J = 11.1, 2.6$ Hz, 1H), 4.78 – 4.65 (m, 5H), 4.57 (d, $J = 12.0$ Hz, 1H), 4.51 – 4.42 (m, 3H), 4.28 (d, $J = 7.9$ Hz, 1H), 4.04 (s, 1H), 3.92 – 3.86 (m, 1H), 3.77 (d, $J = 9.4$ Hz, 1H), 3.72 – 3.57 (m, 4H), 3.36 (d, $J = 9.6$ Hz, 2H), 3.26 – 3.15 (m, 2H), 2.82 – 2.57 (m, 3H), 2.50 (t, $J = 7.0$ Hz, 2H), 2.13 (s, 3H), 2.08 (s, 3H),
- 15 – 5.07 (m, 3H), 5.00 (dd, $J = 11.1, 2.6$ Hz, 1H), 4.78 – 4.65 (m, 5H), 4.57 (d, $J = 12.0$ Hz, 1H), 4.51 – 4.42 (m, 3H), 4.28 (d, $J = 7.9$ Hz, 1H), 4.04 (s, 1H), 3.92 – 3.86 (m, 1H), 3.77 (d, $J = 9.4$ Hz, 1H), 3.72 – 3.57 (m, 4H), 3.36 (d, $J = 9.6$ Hz, 2H), 3.26 – 3.15 (m, 2H), 2.82 – 2.57 (m, 3H), 2.50 (t, $J = 7.0$ Hz, 2H), 2.13 (s, 3H), 2.08 (s, 3H),
- 20 1.54 – 1.46 (m, 4H), 1.33 – 1.25 (m, 2H), 1.15 (d, $J = 6.4$ Hz, 3H); ^{13}C -NMR (100 MHz, $CDCl_3$) δ 206.4, 171.7, 171.2, 138.4, 137.9, 135.1, 133.4, 133.2, 128.7, 128.5 (2C), 128.1, 128.0, 127.9 (3C), 127.8, 127.4, 126.7, 126.4, 126.1, 125.9, 101.7, 98.0, 83.0, 77.6, 77.4, 75.4, 75.1 (2C), 75.0, 73.9, 73.5, 70.3, 68.7, 68.3, 67.3, 65.6, 57.1, 38.2, 30.0, 29.3, 28.1, 23.5, 21.1, 16.3; HRMS (MALDI-TOF): Calcd for $C_{64}H_{72}N_4O_{14}Na^+$ $[M+Na]^+$ 1143.4937, found 1143.4974.
- 25

- Example 47:** Synthesis of *N*-(benzyl)benzyloxycarbonyl-5-amino-pentanyl 3,4-di-*O*-benzyl-2-*O*-levulinoyl-6-*O*-(2-naphthalenylmethyl)- β -*D*-glucopyranosyl-(1 \rightarrow 4)-2-*N*-acetyl-3-*O*-acetyl- α -*L*-fucosaminopyranoside (**49***)

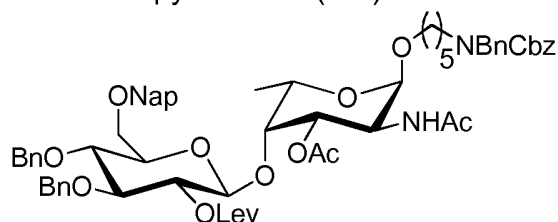

According to general procedure (F), azido-disaccharide **48*** (28 mg, 25 μmol) was reacted with thioacetic acid for 24 h to give **49*** (20 mg, 18 μmol , 70%). $[\alpha]_{\text{D}}^{20} = -53.6^\circ$ ($c = 1.0$, CHCl_3); IR ν_{max} (film) 2926, 1694, 1454, 1364, 1247, 1053 cm^{-1} ; $^1\text{H-NMR}$ (400 MHz, CDCl_3) δ 7.92 – 7.72 (m, 4H), 7.60 – 7.08 (m, 21H), 7.06 – 6.90 (m, 2H), 5.90 – 5.30 (m, 1H), 5.27 – 5.02 (m, 3H), 4.84 (d, $J = 11.4$ Hz, 1H), 4.80 – 4.67 (m, 5H), 4.64 – 4.57 (m, 1H), 4.56 – 4.39 (m, 4H), 4.34 (d, $J = 8.0$ Hz, 1H), 3.99 – 3.46 (m, 7H), 3.39 (d, $J = 9.7$ Hz, 1H), 3.36 – 3.10 (m, 3H), 2.89 – 2.62 (m, 2H), 2.62 – 2.44 (m, 2H), 2.15 (s, 3H), 2.04 (s, 3H), 1.92 (s, 3H), 1.66 – 1.41 (m, 4H), 1.39 – 1.22 (m, 2H), 1.19 (d, $J = 5.6$ Hz, 3H); $^{13}\text{C-NMR}$ (100 MHz, CDCl_3) δ 206.8, 171.9, 171.3, 171.1, 138.4, 137.9, 135.3, 133.4, 133.1, 128.7, 128.6, 128.5 (2C), 128.4, 128.3, 128.1, 128.0 (2C), 127.8 (2C), 127.7, 126.5, 126.3, 126.0, 125.9, 101.8, 97.5, 83.2, 77.7, 77.4, 75.5, 75.1, 74.9, 73.9, 73.5, 70.3, 69.0, 67.3, 65.6, 50.3, 47.5, 47.2, 38.2, 38.0, 30.0, 29.3, 28.1, 27.5, 23.9, 23.5, 21.2, 16.4; HRMS (MALDI-TOF): Calcd for $\text{C}_{66}\text{H}_{76}\text{N}_2\text{O}_{15}\text{Na}^+ [\text{M}+\text{Na}]^+$ 1159.5138, found 1159.5148.

15

Example 48: Synthesis of *N*-(benzyl)benzyloxycarbonyl-5-amino-pentanyl 3,4-di-*O*-benzyl- β -D-glucopyranosyl-(1 \rightarrow 4)-2-*N*-acetyl- α -L-fucosaminopyranoside (**50***)

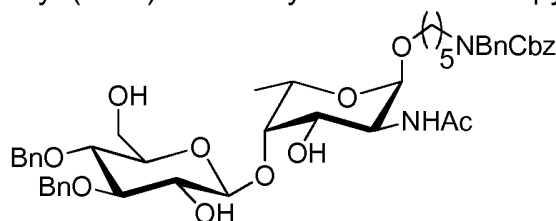

According to general procedure (G), disaccharide **49*** (20 mg, 18 μmol) was reacted with DDQ (12 mg, 53 μmol) for 1.5 h to give the crude primary alcohol. To a solution of crude primary alcohol in MeOH (1 mL) was added 0.5 m NaOMe in MeOH (0.3 mL) and stirred for 16 h. The mixture was neutralized with Amberlite[®] IR 120 (H^+) ion exchange resin, filtered and concentrated. Column chromatography (DCM/MeOH/acetone) afforded **50*** (9 mg, 11 μmol , 60%). $[\alpha]_{\text{D}}^{20} = -45.2^\circ$ ($c = 0.7$, CHCl_3); IR ν_{max} (film) 3354, 2925, 1695, 1542, 1497, 1454, 1422, 1361, 1231, 1049 cm^{-1} ; $^1\text{H-NMR}$ (400 MHz, CDCl_3) δ 7.68 – 6.84 (m, 20H), 6.07 – 5.61 (m, 1H), 5.18 (d, $J = 11.9$ Hz, 2H), 5.01 – 4.76 (m, 3H), 4.76 – 4.58 (m, 2H), 4.57 – 4.33 (m, 4H), 4.02 – 3.80 (m, 2H), 3.80 – 3.42 (m, 8H), 3.39 – 3.14 (m, 3H), 2.53 (s, 1H), 2.01 (s, 3H), 1.91 – 1.63 (m, 2H), 1.63 – 1.45 (m, 4H), 1.36 – 1.26 (m, 5H); $^{13}\text{C-NMR}$ (100 MHz, CDCl_3) δ 172.0, 138.6, 137.9, 128.7, 128.6 (2C), 128.3, 128.1, 128.0, 127.9 (2C), 103.4, 98.1, 84.3, 83.3, 77.7, 77.4, 76.3, 75.4, 75.2, 74.9, 70.5, 67.4, 67.2, 61.9, 50.3, 47.0, 46.2, 29.3, 27.5, 23.7, 16.8; HRMS (MALDI-TOF): Calcd for $\text{C}_{48}\text{H}_{60}\text{N}_2\text{O}_{12}\text{Na}^+ [\text{M}+\text{Na}]^+$ 879.4038, found 879.4004.

20
25
30

Example 50: Synthesis of 5-amino-pentanyl β -D-glucopyranosyluronate-(1 \rightarrow 4)-2-*N*-acetyl- α -L-fucosaminopyranoside (**51***)

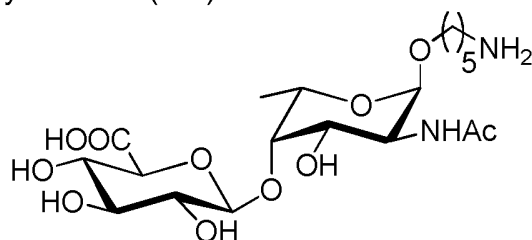

According to general procedure (H), triol **50*** (8 mg, 9 μ mol) was reacted with
 5 TEMPO (0.3 mg, 2 μ mol) and BAIB (15 mg, 47 μ mol) to give the protected uronate
 disaccharide. According to general procedure (I), the uronate disaccharide was
 subjected to hydrogenolysis to give carboxylic acid **51*** (2.6 mg, 5.3 μ mol, 57%).
 $^1\text{H-NMR}$ (600 MHz, D_2O) δ 4.89 (d, J = 3.7 Hz, 1H), 4.53 (d, J = 7.3 Hz, 1H), 4.20 –
 4.12 (m, 2H), 4.05 (d, J = 2.9 Hz, 1H), 3.93 (dd, J = 11.2, 3.0 Hz, 1H), 3.77 – 3.72 (m,
 10 1H), 3.70 (dt, J = 8.1, 5.6 Hz, 1H), 3.59 – 3.45 (m, 4H), 3.06 – 2.97 (m, 2H), 2.05 (s,
 3H), 1.73 – 1.63 (m, 4H), 1.49 – 1.42 (m, 2H), 1.34 (d, J = 6.6 Hz, 3H); $^{13}\text{C-NMR}$ (150
 MHz, D_2O) δ 178.1, 177.1, 105.5, 99.6, 82.5, 78.8, 77.9, 75.8, 74.4, 70.5, 69.6, 69.5,
 53.2, 42.0, 30.6, 29.1, 24.9, 24.5, 17.9; HRMS (ESI): Calcd for $\text{C}_{19}\text{H}_{34}\text{N}_2\text{O}_{11}\text{Na}^+$
 15 $[\text{M}+\text{Na}]^+$ 489.2060, found 489.2063.

Example 51: Synthesis of 5-amino-pentanyl 2-*N*-acetyl-L-fucosaminopyranoside (**52***)

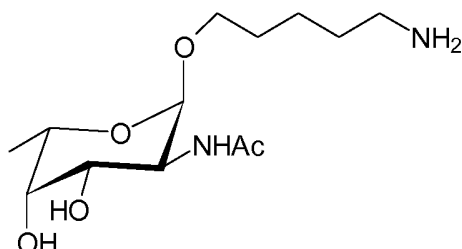

The fucosamine derivative **52*** was obtained according to the synthetic procedure
 20 described for the synthesis of pneumosamine derivative **36*** (3.26 mg, 11 μ mol, 83%
 yield) $^1\text{H-NMR}$ (400 MHz, D_2O) δ 4.81 (d, J = 3.8 Hz, 1H), 4.11 – 4.02 (m, 2H), 3.88
 (dd, J = 11.1, 3.3 Hz, 1H), 3.77 (d, J = 3.1 Hz, 1H), 3.65 (dt, J = 10.1, 6.6 Hz, 1H),
 3.44 (dt, J = 10.1, 6.3 Hz, 1H), 3.01 – 2.92 (m, 2H), 2.01 (s, 3H), 1.70 – 1.57 (m, 4H),
 1.47 – 1.35 (m, 2H), 1.20 (d, J = 6.6 Hz, 3H); $^{13}\text{C-NMR}$ (100 MHz, D_2O) δ 174.4,
 25 96.8, 71.0, 67.7, 67.7, 66.5, 49.6, 39.2, 27.9, 26.4, 22.2, 21.8, 15.3; HRMS (ESI):
 Calcd for $\text{C}_{13}\text{H}_{26}\text{N}_2\text{O}_5\text{Na}^+$ $[\text{M}+\text{Na}]^+$ 313.1739, found 313.1750.

Example 52: Synthesis of hexyldimethylsilyl 3,4,6-tri-*O*-benzyl-2-*O*-levulinoyl- β -D-
 glucopyranosyl-(1 \rightarrow 4)-3-*O*-acetyl-2-azido-2-deoxy- α -L-fucopyranoside (**53***)

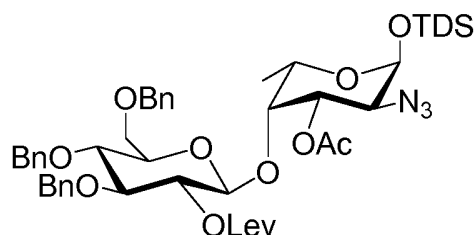

Alcohol **38*** (100 mg, 0.268 mmol, 1.0 equiv) and 2-O-levulinoyl-3,4,6-tri-O-benzyl-1-thio-β-D-glucopyranoside (190 mg, 0.321 mmol, 1.2 equiv) were co-evaporated with toluene two times and dried *in vacuo*. The residue was dissolved in dry dichloromethane. Molecular sieves (4 Å) were added and the reaction mixture cooled to -30 °C. NIS (73 mg, 0.321 mmol, 1.2 equiv) and TfOH (3 μL, 0.032 mmol, 0.12 equiv) were added and the reaction let warm to -20 °C over one hour. The reaction was quenched with triethylamine and diluted with dichloromethane. The organic phase was washed with saturated aqueous Na₂S₂O₃, NaHCO₃ and brine. The organic layer was dried over Na₂SO₄ and concentrated. Column chromatography on silica gel (hexanes/ethyl acetate) afforded disaccharide **53*** (182 mg, 0.201 mmol, 75%). ¹H NMR (400 MHz, CDCl₃) δ 7.40 – 7.25 (m, 13H), 7.15 – 7.12 (m, 2H), 5.14 (dd, *J* = 9.5, 8.2 Hz, 1H), 4.79 (d, *J* = 10.8 Hz, 1H), 4.76 (s, 2H), 4.59 – 4.35 (m, 5H), 4.30 (d, *J* = 8.1 Hz, 1H), 3.93 (d, *J* = 3.3 Hz, 1H), 3.81 (t, *J* = 9.3 Hz, 1H), 3.75 – 3.64 (m, 3H), 3.57 (dd, *J* = 10.9, 7.7 Hz, 1H), 3.52 (dd, *J* = 12.9, 6.4 Hz, 1H), 3.40 – 3.34 (m, 1H), 2.93 – 2.42 (m, 4H), 2.16 (s, 3H), 2.09 (s, 3H), 1.73 – 1.59 (m, 1H), 1.26 (d, *J* = 6.5 Hz, 3H), 0.93 – 0.85 (m, 12H), 0.17 (s, 3H), 0.15 (m, 3H).

Example 53: Synthesis of thexyldimethylsilyl 3,4,6-tri-O-benzyl-β-D-glucopyranosyl-(1→4)-3-O-acetyl-2-azido-2-deoxy-α-L-fucopyranoside (**54***)

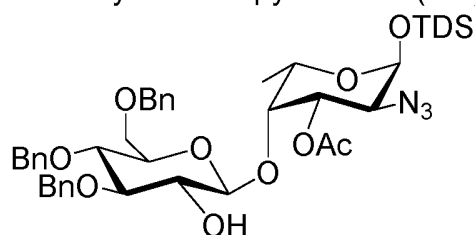

To a solution of disaccharide **53*** (180 mg, 0.199 mmol, 1 equiv) in DCM (11 mL) hydrazine hydrate (40 μL, 0.796 mmol, 4 equiv) dissolved in AcOH (0.22 mL) and pyridine (0.33 mL) was added and the solution stirred for 1 h. The reaction was then quenched by the addition of acetone and concentrated. Column chromatography on silica gel (hexanes/ethyl acetate) afforded disaccharide **54*** (150 mg, 0.186 mmol, 93%). ¹H NMR (400 MHz, CDCl₃) δ 7.38 – 7.21 (m, 13H), 7.15 – 7.10 (m, 2H), 5.02 (d, *J* = 11.2 Hz, 1H), 4.83 (d, *J* = 11.0 Hz, 1H), 4.81 (d, *J* = 11.4 Hz, 1H), 4.57 – 4.32 (m, 5H), 4.20 (d, *J* = 7.7 Hz, 1H), 4.00 (d, *J* = 3.3 Hz, 1H), 3.80 – 3.50 (m, 7H), 3.44 – 3.30 (m, 1H), 3.21 (s, 1H), 2.11 (s, 3H), 1.74 – 1.63 (m, 1H), 1.33 (d, *J* = 6.5 Hz, 3H), 0.94 – 0.85 (m, 12H), 0.2 (s, 6H).

Example 54: Synthesis of thexyldimethylsilyl 3,4,6-tri-O-benzyl- β -D-glucopyranosyl-(1 \rightarrow 4)-3-O-acetyl-2-azido-2-deoxy- α -L-fucopyranoside (**55***)

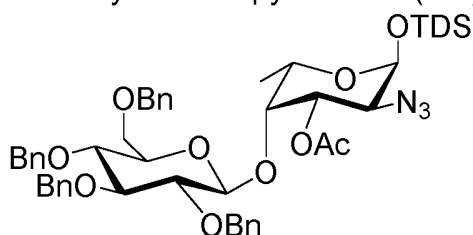

- 5 Benzyl bromide (0.074 mL, 0.620 mmol, 10 equiv) was added to a solution of alcohol **55*** (50 mg, 0.062 mmol, 1 equiv) in DCM (0.5 mL). Then, the mixture was cooled to 0°C and NaH 60% in mineral oil (304 mg, 7.60 mmol) was added. After 10 min, DMF was added (17 μ L). The reaction was warmed to room temperature and let stir for 30 min. The reaction mixture was cooled to 0 °C and quenched with AcOH (0.1 mL).
- 10 The reaction mixture was warmed to room temperature and the solvent evaporated. Column chromatography on silica gel (hexanes/ethyl acetate) afforded disaccharide **55*** (55 mg, 0.061 mmol, 99%). ¹H NMR (400 MHz, CDCl₃) δ 7.45 – 7.03 (m, 20H), 5.19 (dd, *J* = 9.6, 8.1 Hz, 1H), 4.89 (d, *J* = 12.6 Hz, 1H), 4.82 – 4.75 (m, 2H), 4.70 (d, *J* = 11.4 Hz, 1H), 4.56 – 4.44 (m, 3H), 4.40 (d, *J* = 12.0 Hz, 1H), 4.35 (d, *J* = 12.0 Hz,
- 15 1H), 4.31 (d, *J* = 7.7 Hz, 1H), 3.87 (d, *J* = 3.0 Hz, 1H), 3.73 – 3.43 (m, 6H), 3.34 (q, *J* = 6.5 Hz, 1H), 3.10 (dd, *J* = 10.5, 3.1 Hz, 1H), 1.99 (s, 3H), 1.72 – 1.59 (m, 1H), 1.28 (d, *J* = 6.6 Hz, 3H), 0.96 – 0.77 (m, 12H), 0.13 (m, 6H).

Example 55: Synthesis of thexyldimethylsilyl 2,3,4,6-tetra-O-benzyl- β -D-glucopyranosyl-(1 \rightarrow 4)-2-azido-2-deoxy- α -L-fucopyranoside (**56***)

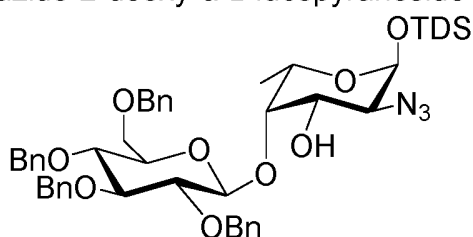

- To a solution of disaccharide **55*** (55 mg, 61 μ mol) in MeOH (1 mL) was added 0.5 M NaOMe in MeOH (0.12 mL) and stirred for 16 h. The mixture was neutralized with Amberlite[®] IR 120 (H⁺) ion exchange resin and the resulting alcohol was filtered and concentrated. Column chromatography on silica gel (hexanes/ethyl acetate) afforded disaccharide **56*** (43 mg, 50 μ mol, 82%). ¹H NMR (400 MHz, CDCl₃) δ 7.42 – 7.20 (m, 18H), 7.18 – 7.12 (m, 2H), 5.00 (d, *J* = 11.3 Hz, 1H), 4.85 (d, *J* = 11.4 Hz, 2H), 4.76 (d, *J* = 11.3 Hz, 1H), 4.63 (d, *J* = 12.2 Hz, 1H), 4.51 (d, *J* = 10.9 Hz, 1H), 4.48 –
- 25 4.32 (m, 4H), 3.93 (d, *J* = 2.9 Hz, 1H), 3.76 – 3.46 (m, 7H), 3.40 (q, *J* = 6.6 Hz, 1H),
- 30

3.18 (dd, $J = 10.5, 3.1$ Hz, 1H), 1.73 – 1.63 (m, 1H), 1.32 (d, $J = 6.5$ Hz, 3H), 0.92 – 0.83 (m, 12H), 0.16 (d, $J = 2.4$ Hz, 6H).

Example 56: Synthesis of thexyldimethylsilyl [2,3,4,6-tetra-O-benzyl- β -D-glucopyranosyl-(1 \rightarrow 4)]-3,4-di-O-benzyl-6-O-benzoyl-2-levulinoyl- β -D-glucopyranosyl-(1 \rightarrow 3)-2-azido-2-deoxy- α -L-fucopyranoside (**57***)

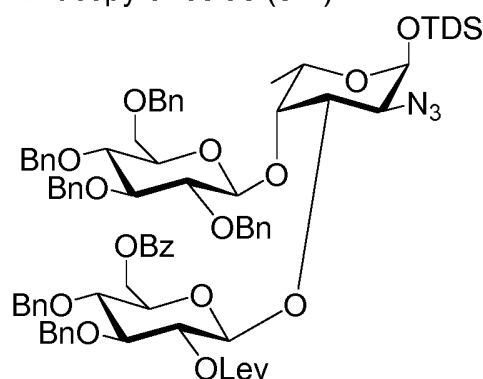

10 Acceptor **56*** (40 mg, 0.047 mmol, 1.0 equiv) and 6-O-benzoyl-3,4-di-O-benzyl-2-O-levulinoyl-1-thio- β -D-glucopyranoside (43 mg, 0.070 mmol, 1.5 equiv) were coevaporated with toluene two times and dried *in vacuo*. The residue was dissolved in a mixture of toluene (2 mL) and dichloromethane (1 mL). Molecular sieves (4 Å) were added and the reaction mixture cooled to -45°C . NIS (21 mg, 0.094 mmol, 2 equiv) and TfOH (0.5 μL , 5.6 μmol , 0.12 equiv) were added and the reaction let warm to -30°C over two hours. The reaction was quenched with triethylamine and diluted with dichloromethane. The organic phase was washed with saturated aqueous Na₂S₂O₃, NaHCO₃ and brine. The organic layer was dried over Na₂SO₄ and concentrated. Column chromatography on silica gel (hexanes/ethyl acetate) afforded trisaccharide **57*** (52 mg, 0.037 mmol, 79%). ¹H NMR (400 MHz, CDCl₃) δ 8.10 – 7.98 (m, 2H), 7.57 – 7.50 (m, 1H), 7.47 – 7.09 (m, 30H), 7.07 – 7.00 (m, 2H), 5.23 (d, $J = 8.1$ Hz, 1H), 5.14 – 5.05 (m, 1H), 4.91 (d, $J = 5.1$ Hz, 1H), 4.88 (d, $J = 6.4$ Hz, 1H), 4.84 – 4.76 (m, 2H), 4.73 – 4.31 (m, 11H), 4.28 (d, $J = 7.8$ Hz, 1H), 3.99 (d, $J = 2.9$ Hz, 1H), 3.96 – 3.87 (m, 2H), 3.85 – 3.82 (m, 1H), 3.71 – 3.34 (m, 8H), 3.18 (dd, $J = 10.4, 3.1$ Hz, 1H), 2.66 – 2.14 (m, 4H), 2.03 (s, 1H), 1.60 – 1.48 (m, 1H), 1.44 (d, $J = 6.5$ Hz, 3H), 0.83 (dd, $J = 7.6, 2.4$ Hz, 12H), 0.12 (d, $J = 10.5$ Hz, 6H).

25

Example 57: Synthesis of thexyldimethylsilyl 3-O-*p*-methoxybenzyl-2-azido-2-deoxy- β -L-fucopyranoside (**59***)

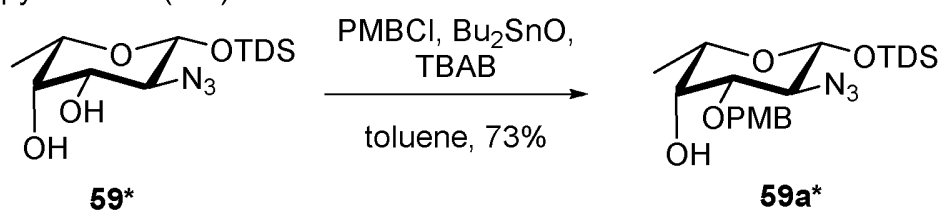

Diol **59*** (1.02 g, 3.07 mmol, 1.0 equiv) was co-evaporated with dry toluene twice and let dry *in vacuo* for 30 min. Then, dry toluene (30 mL) was added, followed by Bu_2SnO (1.14 g, 4.60 mmol, 1.5 equiv) and 4 Å MS. The reaction was stirred for 1 hour under reflux. The reaction was cooled to 40 °C; PMBCl (1.25 mL, 9.20 mmol, 3 equiv) and TBAB (1.48 g, 4.60 mmol, 1.5 equiv) were added and left stir overnight at rt. The reaction mixture was filtered and the solvent evaporated. Column chromatography on silica gel (hexanes/ethyl acetate) afforded building block **59a*** (1.01 g, 2.23 mmol, 73%). $[\alpha]_{\text{D}}^{20} = 25.6$ ($c = 2.00$, CHCl_3); IR ν_{max} (film) 3494, 2960, 2870, 2112, 1515, 1251, 1073, 829 cm^{-1} ; ^1H NMR (400 MHz, CDCl_3) δ 7.36 – 7.28 (m, 2H), 6.97 – 6.84 (m, 2H), 4.63 (s, 2H), 4.39 (d, $J = 7.7$ Hz, 1H), 3.81 (s, 3H), 3.71 – 3.63 (m, 1H), 3.53 – 3.39 (m, 2H), 3.24 (dd, $J = 10.1, 3.3$ Hz, 1H), 2.41 – 2.26 (m, 1H), 1.67 (hept, $J = 6.8$ Hz, 1H), 1.31 (d, $J = 6.5$ Hz, 3H), 0.89 (d, $J = 7.0$ Hz, 12H), 0.17 (d, $J = 3.5$ Hz, 6H). ^{13}C NMR (101 MHz, CDCl_3) δ 159.6, 129.7, 129.5, 114.1, 97.0, 79.0, 71.8, 70.2, 68.4, 65.2, 55.4, 34.0, 24.9, 20.1, 20.0, 18.6, 18.5, 16.5, -1.8, -3.2. LRMS (ESI+) Calcd for $\text{C}_{22}\text{H}_{37}\text{N}_3\text{O}_5\text{SiNa}^+$ $[\text{M}+\text{Na}]^+$ 474.2400, found 474.2.

Example 58: Synthesis of thexyldimethylsilyl 3,4,6-tri-O-benzyl-2-O-levulinoyl- β -D-glucopyranosyl-(1 \rightarrow 4)-3-O-*p*-methoxybenzyl-2-azido-2-deoxy- β -L-fucopyranoside (**61***)

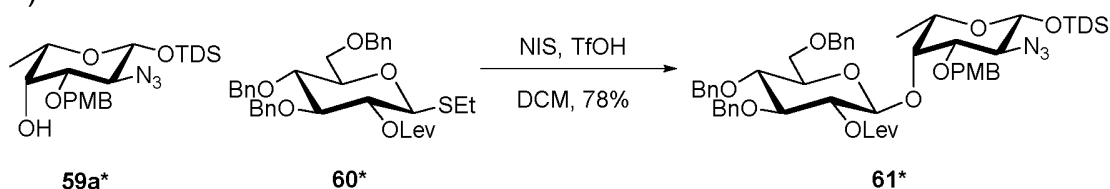

L-fucosyl acceptor **59a*** (200 mg, 0.443 mmol, 1.0 equiv) and thioglucoside **60*** (354 mg, 0.70 mmol, 1.35 equiv) were coevaporated with toluene two times and dried *in vacuo*. The residue was dissolved in DCM (15 mL). Molecular sieves acid washed (4 Å) were added and the reaction mixture cooled to -40 °C. NIS (149 mg, 0.66 mmol, 1.5 equiv) and TfOH (2 μL , 0.02 mmol, 0.05 equiv) were added and let stir for one hour at -40 °C. The reaction was quenched with triethylamine and diluted with DCM. The organic phase was washed with saturated aqueous $\text{Na}_2\text{S}_2\text{O}_3$, NaHCO_3 and brine, dried over Na_2SO_4 , filtered and concentrated. Column chromatography on silica gel (hexanes/ethyl acetate) afforded disaccharide **61*** (338 mg, 0.34 mmol, 78%). $[\alpha]_{\text{D}}^{20} = -2.5$ ($c = 1.00$, CHCl_3); IR ν_{max} (film) 2959, 2868, 2112, 1750, 1721, 1515, 1250, 1075, 832 cm^{-1} ; ^1H NMR (600 MHz, CDCl_3) δ 7.41 – 7.19 (m, 15H), 7.18–7.11 (m, 2H), 6.82 (d, $J = 8.4$ Hz, 2H), 5.19 (t, $J = 8.8$ Hz, 1H), 4.83 – 4.74 (m, 4H), 4.53 – 4.43 (m, 3H), 4.39 (d, $J = 5.3$ Hz, 2H), 4.26 (d, $J = 7.7$ Hz, 1H), 3.85 – 3.82 (m,

1H), 3.77 (s, 3H), 3.73 – 3.63 (m, 2H), 3.60 – 3.43 (m, 4H), 3.33 (q, $J = 6.6$ Hz, 1H), 3.08 (dd, $J = 10.5, 3.0$ Hz, 1H), 2.90 – 2.79 (m, 1H), 2.65 – 2.55 (m, 2H), 2.53 – 2.45 (m, 1H), 2.14 (s, 3H), 1.64 (h, $J = 6.8$ Hz, 1H), 1.27 (d, $J = 6.6$ Hz, 3H), 0.91 – 0.81 (m, 12H), 0.11 (d, $J = 12.5$ Hz, 6H). ^{13}C NMR (151 MHz, CDCl_3) δ 206.6, 171.3, 159.2, 138.4, 137.9, 130.2, 129.6, 128.6, 128.5, 128.5, 128.3, 128.2, 128.0, 128.0, 127.8, 127.8, 113.8, 101.7, 97.2, 83.2, 78.0, 75.3, 75.2, 75.0, 74.0, 73.9, 73.6, 70.3, 70.0, 69.7, 64.7, 55.4, 38.2, 34.1, 30.0, 28.0, 24.9, 20.1, 20.1, 18.63, 18.58, 17.0, -1.8, -3.1. HRMS (ESI+) Calcd for $\text{C}_{54}\text{H}_{71}\text{N}_3\text{O}_{12}\text{SiNa}^+$ $[\text{M}+\text{Na}]^+$ 1004.4705, found 1004.4709.

10

Example 59: Synthesis of hexyldimethylsilyl 3,4,6-tri-O-benzyl- β -D-glucopyranosyl-(1 \rightarrow 4)-3-O-p-methoxybenzyl-2-azido-2-deoxy- β -L-fucopyranoside (**62***)

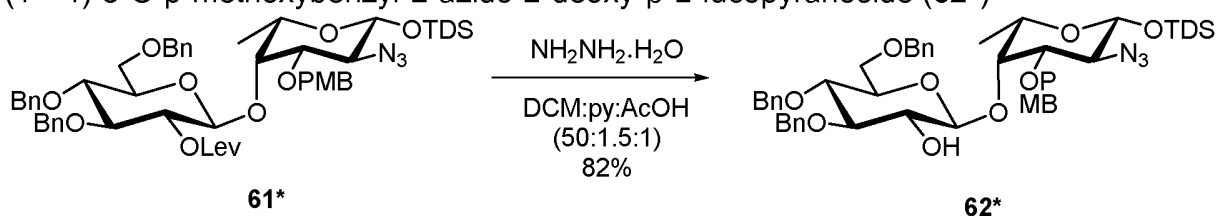

15 To a solution of disaccharide **61*** (970 mg, 0.99 mmol, 1 equiv) in DCM (11 mL), a solution of hydrazine hydrate (190 μL , 3.95 mmol, 4 equiv) dissolved in AcOH (1.1 mL) and pyridine (1.7 mL) was added. The resulting reaction mixture was stirred at rt for 1 to 2 h. The reaction was quenched by the addition of acetone and the solvent evaporated. Column chromatography on silica gel (hexanes/ethyl acetate) afforded

20 disaccharide **62*** (720 mg, 0.81 mmol, 82%). $[\alpha]_{\text{D}}^{20} = 28.5$ ($c = 0.10$, CHCl_3); IR ν_{max} (film) 3470, 2930, 2870, 2113, 1515, 1252, 1115, 1069, 832 cm^{-1} , ^1H NMR (600 MHz, CDCl_3) δ 7.40 – 7.36 (m, 2H), 7.35 – 7.21 (m, 13H), 7.20 – 7.12 (m, 2H), 6.80 (d, $J = 8.3$ Hz, 2H), 5.00 (d, $J = 11.4$ Hz, 1H), 4.86 (d, $J = 10.9$ Hz, 1H), 4.80 – 4.72 (m, 2H), 4.60 (d, $J = 11.6$ Hz, 1H), 4.53 (d, $J = 10.8$ Hz, 1H), 4.50 – 4.40 (m, 3H), 4.36 (d, $J = 7.7$ Hz, 1H), 3.90 (d, $J = 3.0$ Hz, 1H), 3.74 (s, 3H), 3.69 – 3.44 (m, 8H), 3.39 (q, $J = 6.4$ Hz, 1H), 3.18 (dd, $J = 10.5, 3.1$ Hz, 1H), 1.66 (h, $J = 6.8$ Hz, 1H), 1.29 (d, $J = 6.5$ Hz, 3H), 0.94 – 0.81 (m, 12H), 0.17 (d, $J = 4.3$ Hz, 6H). ^{13}C NMR (151 MHz, CDCl_3) δ 159.6, 139.2, 138.3, 138.1, 130.3, 129.3, 128.51, 128.50, 128.46, 128.2, 127.94, 127.89, 127.8, 127.6, 114.0, 102.5, 97.2, 84.6, 78.0, 77.0, 75.4, 75.2, 75.1, 73.8,

25 73.6, 72.2, 72.1, 70.7, 69.6, 65.7, 55.4, 34.1, 25.0, 20.2, 20.1, 18.7, 18.6, 17.5, -1.7, -3.0. HRMS (ESI+) Calcd for $\text{C}_{49}\text{H}_{65}\text{N}_3\text{O}_{10}\text{SiNa}^+$ $[\text{M}+\text{Na}]^+$ 906.4337, found 906.4371.

30

Example 60: Synthesis of thexyltrimethylsilyl 2,3,4,6-tetra-O-benzyl- β -D-glucopyranosyl-(1 \rightarrow 4)-3-O-*p*-methoxybenzyl-2-azido-2-deoxy- β -L-fucopyranoside (**63***)

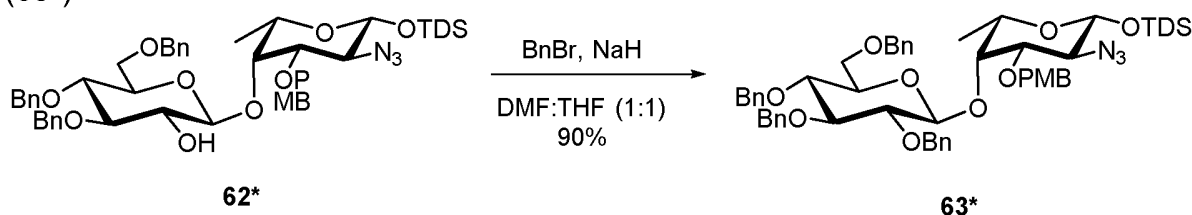

5

Benzyl bromide (194 μ L, 1.63 mmol, 2 equiv) was added to a solution of alcohol **62*** (720 mg, 0.81 mmol, 1 equiv) in THF:DMF (1:1, 17 mL). Then, the mixture was cooled to 0°C and NaH 60% in mineral oil (65 mg, 1.63 mmol, 2 equiv) was added. The reaction mixture was warmed to room temperature and let stir for 3h. Then, it was diluted with DCM and quenched with NaHCO₃. The aqueous layer was extracted with DCM (3x). The organic phase was washed with brine, dried over Na₂SO₄, filtered and the solvent evaporated. Column chromatography on silica gel (hexanes/ethyl acetate) afforded disaccharide **63*** (715 mg, 0.73 mmol, 90%). $[\alpha]_D^{20} = -5.4$ (c = 2.44, CHCl₃); IR ν_{max} (film) 3066, 3033, 2957, 2867, 2112, 1514, 1249, 1068, 831, 698 cm⁻¹, ¹H NMR (400 MHz, CDCl₃) δ 7.47 – 7.07 (m, 22H), 6.83 (d, *J* = 8.2 Hz, 2H), 5.17 (d, *J* = 10.4 Hz, 1H), 5.04 (d, *J* = 11.1 Hz, 1H), 4.90-4.69 (m, *J* = 25.2, 21.0, 11.5 Hz, 5H), 4.54 – 4.32 (m, 6H), 3.97 (d, *J* = 3.2 Hz, 1H), 3.78 (s, 3H), 3.73 – 3.36 (m, 9H), 3.15 (dd, *J* = 10.5, 3.1 Hz, 1H), 1.68 – 1.56 (h, *J* = 6.8 Hz, 1H), 1.38 (d, *J* = 6.5 Hz, 3H), 0.92 – 0.78 (m, 12H), 0.15 (s, 6H). ¹³C NMR (101 MHz, CDCl₃) δ 159.2, 138.9, 138.2, 137.9, 137.8, 130.1, 129.8, 129.3, 128.52, 128.49, 128.47, 128.34, 128.32, 128.03, 127.97, 127.8, 127.7, 113.7, 104.5, 97.1, 85.0, 81.8, 77.9, 76.6, 75.8, 75.1, 75.0, 74.9, 73.7, 73.5, 70.5, 70.0, 69.6, 65.2, 55.3, 34.0, 24.9, 20.2, 20.0, 18.6, 18.5, 17.3, -1.9, -3.2. HRMS (ESI+) Calcd for C₅₆H₇₁N₃O₁₀SiNa⁺ [M+Na]⁺ 1004.4806, found 996.4809.

25

Example 61: Synthesis of thexyltrimethylsilyl 2,3,4,6-tetra-O-benzyl- β -D-glucopyranosyl-(1 \rightarrow 4)-2-azido-2-deoxy- β -L-fucopyranoside (**64***)

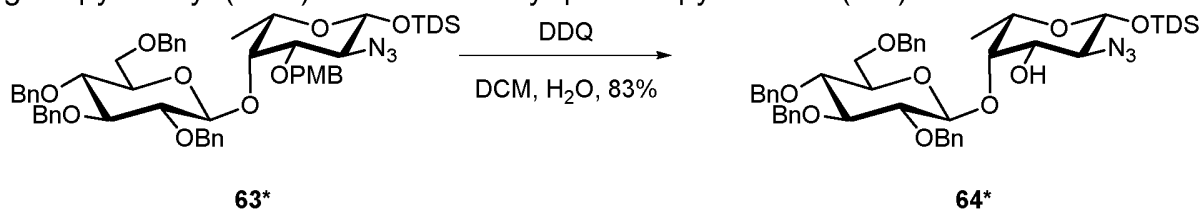

30

To a solution of disaccharide **63*** (630 mg, 0.65 mmol, 1 equiv) in DCM:H₂O (18:1, 5.3 mL) was added 2,3-dichloro-5,6-dicyano-1,4-benzoquinone (DDQ) (161 mg, 0.71 mmol, 1.1 equiv) at 0°C. The reaction was warmed to rt and let stir for 2.5h. The reaction was not complete, then 10 mg DDQ were added. After 30 minutes, the reaction was diluted with DCM and NaHCO₃ added. The organic phase was washed (3x) with NaHCO₃ until the solution was colorless. Then, the organic phase was washed with brine, dried over Na₂SO₄, filtered and the solvent evaporated. Column chromatography on silica gel (hexanes/ethyl acetate) afforded disaccharide **64*** (460 mg, 0.54 mmol, 83%). $[\alpha]_D^{20} = 1.9$ (c = 1.36, CHCl₃); IR ν_{\max} (film) 3484, 3034, 2959, 2869, 2112, 1254, 1069, 833, 629 cm⁻¹, ¹H NMR (400 MHz, CDCl₃) δ 7.43 – 7.19 (m, 18H), 7.16-7.08 (m, 2H), 5.08-4.97 (m, 2H), 4.87 – 4.75 (m, 3H), 4.59 – 4.44 (m, 4H), 4.37 (d, *J* = 7.7 Hz, 1H), 3.73 – 3.34 (m, 10H), 1.66 (h, *J* = 7.0 Hz, 1H), 1.30 (d, *J* = 6.4 Hz, 3H), 0.93 – 0.78 (m, 12H), 0.20 (s, 6H). ¹³C NMR (101 MHz, CDCl₃) δ 138.6, 137.9, 137.85, 137.81, 128.8, 128.6, 128.5, 128.4, 128.2, 128.1, 128.0, 127.9, 127.9, 127.8, 104.0, 97.3, 84.6, 81.5, 80.6, 77.6, 77.4, 75.9, 75.3, 75.0, 73.8, 71.4, 70.3, 68.8, 67.7, 34.1, 24.9, 20.2, 20.0, 18.6, 18.5, 16.7, -1.9, -3.0. HRMS (ESI+) Calcd for C₄₈H₆₃N₃O₉SiNa⁺ [M+Na]⁺ 876.4231, found 876.4234.

Example 62: Synthesis of thexyldimethylsilyl [2,3,4,6-tetra-O-benzyl- β -D-glucopyranosyl-(1 \rightarrow 4)]-benzyl-3,4-di-O-benzyl-6-O-benzoyl-2-levulinoyl- β -D-glucopyranosyluronate-(1 \rightarrow 3)-2-azido-2-deoxy- β -L-fucopyranoside (**66***)

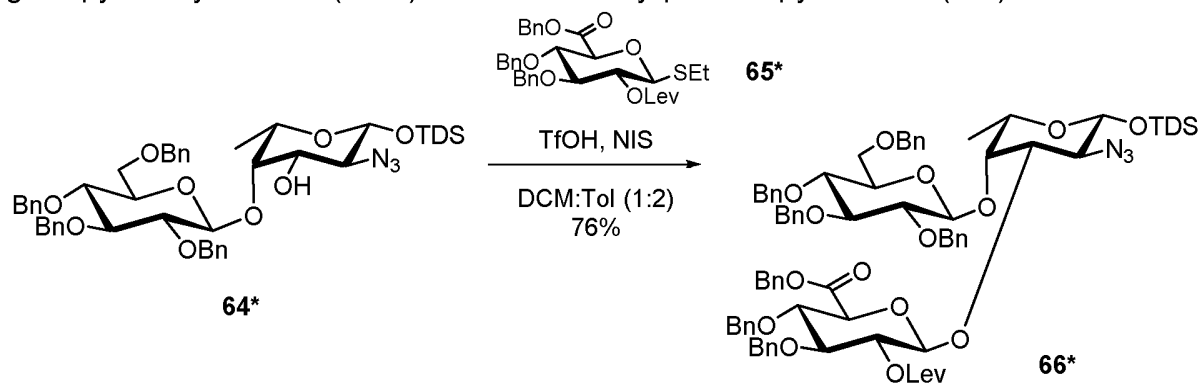

Acceptor **64*** (91 mg, 0.11 mmol, 1.0 equiv) and thioglucoside **65*** (129 mg, 0.21 mmol, 2 equiv) were coevaporated with toluene two times and dried *in vacuo*. The residue was dissolved in a mixture of toluene (4 mL) and DCM (2 mL). Molecular sieves acid washed (4 Å) were added and the reaction mixture cooled to -30°C. NIS (53 mg, 0.23 mmol, 2.2 equiv) and TfOH (0.5 μ L, 5.3 μ mol, 0.05 equiv) were added and the reaction let warm to -15°C over two hours. The reaction was quenched with triethylamine and diluted with DCM. The organic phase was washed with saturated aqueous Na₂S₂O₃, NaHCO₃ and brine, dried over Na₂SO₄, filtered and concentrated.

Column chromatography on silica gel (hexanes/ethyl acetate) afforded trisaccharide **66*** (114 mg, 0.08 mmol, 76%). $[\alpha]_D^{20} = -26.6$ ($c = 0.87$, CHCl_3); IR ν_{max} (film) 3034, 2929, 2870, 2116, 1751, 1720, 1072, 832, 698 cm^{-1} , $^1\text{H NMR}$ (400 MHz, CDCl_3) δ 7.56 – 6.90 (m, 35H), 5.21 – 5.06 (m, 5H), 5.02 – 4.94 (m, 2H), 4.83 – 4.61 (m, 6H), 4.53 – 4.32 (m, 6H), 4.06 – 3.88 (m, 3H), 3.83 – 3.73 (m, 2H), 3.65 – 3.33 (m, 8H), 3.21 (t, $J = 9.2$ Hz, 1H), 2.78 – 2.57 (m, 2H), 2.50–2.37 (m, 2H), 2.11 (s, 3H), 1.68–1.53 (m, 1H), 1.35 (d, $J = 6.5$ Hz, 3H), 0.94 – 0.73 (m, 12H), 0.15 (d, $J = 8.8$ Hz, 6H). $^{13}\text{C NMR}$ (101 MHz, CDCl_3) δ 206.3, 171.3, 168.6, 138.8, 138.4, 138.3, 138.2, 138.0, 137.9, 135.3, 129.2, 128.7, 128.65, 128.60, 128.56, 128.55, 128.53, 128.4, 128.20, 128.18, 128.1, 128.0, 127.9, 127.8, 127.73, 127.70, 127.67, 104.0, 96.8, 95.5, 84.9, 82.0, 81.4, 79.5, 78.3, 75.9, 75.2, 74.9, 74.8, 74.4, 74.3, 74.1, 73.4, 73.4, 73.0, 72.4, 70.5, 69.2, 67.3, 64.6, 37.9, 34.1, 30.1, 28.2, 24.9, 20.2, 20.0, 18.7, 18.5, 17.5, -1.9, -3.2. HRMS (ESI+) Calcd for $\text{C}_{80}\text{H}_{95}\text{N}_3\text{O}_{17}\text{SiNa}^+$ $[\text{M}+\text{Na}]^+$ 1420.6328, found 1420.6322.

15

Example 63: Synthesis of [2,3,4,6-Tetra-O-benzyl- β -D-glucopyranosyl-(1 \rightarrow 4)]-benzyl-3,4-di-O-benzyl-6-O-benzoyl-2-levulinoyl- β -D-glucopyranosyluronate-(1 \rightarrow 3)-2-azido-2-deoxy- α,β -L-fucopyranoside (**67***)

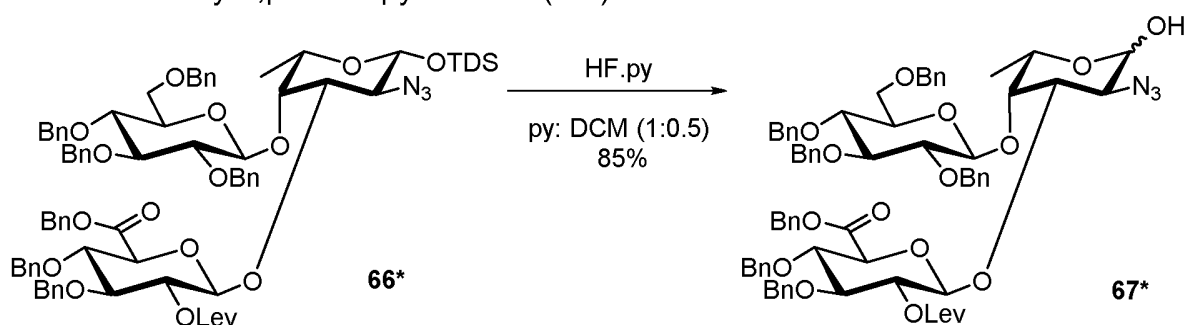

20

Trisaccharide **66*** (235 mg, 0.17 mmol, 1.0 equiv) was dissolved in a mixture of pyridine (1 mL) and DCM (0.5 mL) in a plastic falcon tube. HF.py (0.15 mL, 1.70 mmol, 10 equiv) was added dropwise and the reaction let stir at rt for 48-72h. The reaction was diluted with DCM and quenched with NaHCO_3 . The phases were separated and the organic phase washed with brine, dried over Na_2SO_4 , filtered and concentrated. Column chromatography on silica gel (hexanes/ethyl acetate) afforded trisaccharide lactol **67*** (180 mg, 0.14 mmol, 85%). $\alpha:\beta$ (1.4:1) mixture: clear oil. $[\alpha]_D^{20} = -36.8$ ($c = 1.12$, CHCl_3); IR ν_{max} (film) 3480, 3033, 2912, 2870, 2115, 1750, 1720, 1071, 740, 698 cm^{-1} , $^1\text{H NMR}$ (600 MHz, CDCl_3) δ 7.48 – 7.03 (m, 60H), 5.29 (d, $J = 3.5$ Hz, 1H), 5.21 – 5.05 (m, 9H), 5.00 – 4.94 (m, 2H), 4.82 – 4.76 (m, 4H), 4.74 – 4.63 (m, 7H), 4.53 – 4.43 (m, 9H), 4.35 (dd, $J = 10.2, 3.0$ Hz, 1H), 4.16 (q, $J = 6.7$ Hz, 1H), 4.07 (d, $J = 2.9$ Hz, 1H), 4.03 – 3.95 (m, 4H), 3.90 (dd, $J = 10.2, 3.5$ Hz, 1H), 3.87 (dd, $J = 10.4, 3.1$ Hz, 1H), 3.84 – 3.77 (m, 2H), 3.67 – 3.59 (m, 4H), 3.57–3.48

30

(m, 3H), 3.47 – 3.38 (m, 3H), 3.31 – 3.25 (m, 2H), 2.70 – 2.65 (m, 3H), 2.56 – 2.47 (m, 2H), 2.45 – 2.36 (m, 2H), 2.13 (s, 2H), 2.11 (s, 3H), 1.39 (d, $J = 6.6$ Hz, 2H), 1.36 (d, $J = 6.7$ Hz, 3H). ^{13}C NMR (151 MHz, CDCl_3) δ 206.4, 206.1, 171.3, 168.5, 168.4, 138.7, 138.40, 138.38, 138.3, 138.1, 138.00, 137.98, 135.3, 135.2, 129.0, 128.9, 128.73, 128.72, 128.67, 128.64, 128.61, 128.58, 128.54, 128.53, 128.50, 128.47, 128.39, 128.37, 128.19, 128.16, 128.1, 128.05, 127.98, 127.93, 127.92, 127.88, 127.86, 127.84, 127.77, 127.75, 127.71, 103.8, 103.7, 96.14, 96.09, 96.0, 91.9, 84.9, 82.6, 82.4, 81.44, 81.40, 79.7, 79.5, 78.3, 75.9, 75.2, 75.14, 75.13, 75.06, 74.96, 74.94, 74.6, 74.5, 74.43, 74.40, 74.3, 74.2, 73.6, 73.4, 73.3, 73.0, 72.3, 71.7, 71.0, 69.2, 69.1, 67.4, 67.1, 63.6, 59.9, 37.8, 30.10, 30.07, 28.3, 17.5, 17.2. HRMS (ESI+) Calcd for $\text{C}_{72}\text{H}_{77}\text{N}_3\text{O}_{17}\text{Na}^+$ $[\text{M}+\text{Na}]^+$ 1278.5151, found 1278.5177.

Example 64: Synthesis of *N*-(Benzyl)benzyloxycarbonyl-5-amino-pentanyl [2,3,4,6-tetra-*O*-benzyl- β -D-glucopyranosyl-(1 \rightarrow 4)]-benzyl-3,4-di-*O*-benzyl-6-*O*-benzoyl-2-levulinoyl- β -D-glucopyranosyluronate-(1 \rightarrow 3)-2-azido-2-deoxy- α -L-fucopyranosyl-(1 \rightarrow 3)-2-azido-2-deoxy-4-*O*-(2-naphthalenylmethyl)- β -D-fucopyranoside (**69***)

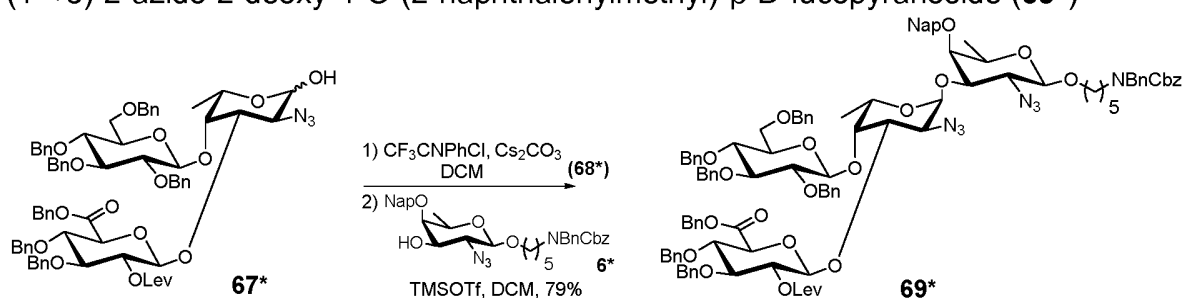

To a solution of the trisaccharide lactol **67*** (80 mg, 0.06 mmol, 1.0 equiv) in DCM (3 mL) were added Cs_2CO_3 (42 mg, 0.12 mmol, 2.0 equiv) and 2,2,2-trifluoro-*N*-phenylacetimidoyl chloride (30 μL , 0.19 mmol, 3.0 equiv) at 0°C . After 2 h at rt, the product (**68***) was filtered and the solvent evaporated. The crude mixture was passed through a small plug of silica and used in the next reaction without further purification. Acceptor **6*** (81 mg, 0.13 mmol, 2.0 equiv) and trisaccharide imidate **68*** (90 mg, 0.06 mmol, 1.0 equiv) were coevaporated with toluene two times and dried *in vacuo*. The residue was dissolved in DCM (3 mL). Molecular sieves acid washed (4 \AA) were added and the reaction mixture cooled to -35°C . TMSOTf (1 μL , 6 μmol , 0.1 equiv) was added and the reaction let warm to -20°C over 1h. The reaction was quenched with triethylamine, filtered and the solvent evaporated. Column chromatography on silica gel (hexanes/ethyl acetate) afforded tetrasaccharide **69*** (94 mg, 0.05 mmol, 79%). $[\alpha]_{\text{D}}^{20} = -52.6$ ($c = 0.54$, CHCl_3); IR ν_{max} (film) 3033, 2929, 2870, 2116, 1751, 1699, 1361, 1071, 737, 698 cm^{-1} , ^1H NMR (600 MHz, CDCl_3) δ 7.81 – 7.75 (m, 3H), 7.72 (s, 1H), 7.51 – 7.48 (m, 1H), 7.45 – 7.40 (m, 2H), 7.39 – 7.07 (m, 43H), 7.04 (d,

$J = 7.5$ Hz, 2H), 5.26 (d, $J = 3.6$ Hz, 1H), 5.20 – 5.14 (m, 2H), 5.12 – 5.05 (m, 2H),
 4.99 – 4.94 (m, 2H), 4.91 (d, $J = 11.0$ Hz, 1H), 4.86 (d, $J = 12.2$ Hz, 1H), 4.83 – 4.71
 (m, 4H), 4.69 – 4.59 (m, 4H), 4.54 – 4.40 (m, 6H), 4.35 (d, $J = 7.9$ Hz, 1H), 4.30 (dd,
 $J = 10.3, 3.0$ Hz, 1H), 4.22 – 4.12 (m, 1H), 4.03 (d, $J = 9.9$ Hz, 1H), 3.95 (t, $J = 9.3$
 5 Hz, 1H), 3.88 – 3.82 (m, 3H), 3.79 – 3.73 (m, 1H), 3.73 – 3.65 (m, 2H), 3.63 – 3.54
 (m, 2H), 3.53 – 3.35 (m, 7H), 3.32 (t, $J = 9.4$ Hz, 1H), 3.29 – 3.23 (m, 1H), 3.22 –
 3.16 (m, 1H), 2.63 (t, $J = 6.6$ Hz, 2H), 2.44 (dt, $J = 17.4, 6.5$ Hz, 1H), 2.36 (dt, $J =$
 17.4, 6.7 Hz, 1H), 2.08 (s, 3H), 1.68 – 1.46 (m, 4H), 1.43 – 1.27 (m, 2H), 1.31 (d, $J =$
 6.4 Hz, 3H), 1.00 (d, $J = 6.5$ Hz, 3H). ^{13}C NMR (151 MHz, CDCl_3) δ 206.2, 171.3,
 10 168.1, 138.7, 138.4, 138.2, 138.0, 135.8, 135.1, 133.2, 133.1, 128.7, 128.62, 128.59,
 128.56, 128.55, 128.52, 128.51, 128.46, 128.4, 128.3, 128.21, 128.20, 128.1,
 128.03, 127.99, 127.97, 127.9, 127.82, 127.75, 127.7, 127.5, 127.4, 127.1, 126.3,
 126.2, 103.7, 102.74, 99.1, 97.0, 85.0, 82.4, 81.4, 79.7, 79.0, 78.3, 75.8, 75.2, 74.9,
 74.8, 74.72, 74.68, 74.4, 73.7, 73.2, 71.0, 69.2, 67.3, 67.2, 64.0, 59.0, 50.7, 50.4,
 15 47.3, 46.4, 37.8, 30.1, 29.4, 28.2, 23.4, 17.4, 16.8. HRMS (ESI+) Calcd for
 $\text{C}_{109}\text{H}_{117}\text{N}_7\text{O}_{22}\text{Na}^+ [\text{M}+\text{Na}]^+$ 1900.1187, found 1900.184.

Example 65: Synthesis of *N*-(Benzyl)benzyloxycarbonyl-5-amino-pentanyl [2,3,4,6-
 tetra-*O*-benzyl- β -D-glucopyranosyl-(1 \rightarrow 4)]-benzyl-3,4-di-*O*-benzyl-6-*O*-benzoyl- β -D-
 20 glucopyranosyluronate-(1 \rightarrow 3)-2-azido-2-deoxy- α -L-fucopyranosyl-(1 \rightarrow 3)-2-azido-2-
 deoxy-4-*O*-(2-naphthalenylmethyl)- β -D-fucopyranoside (**70***)

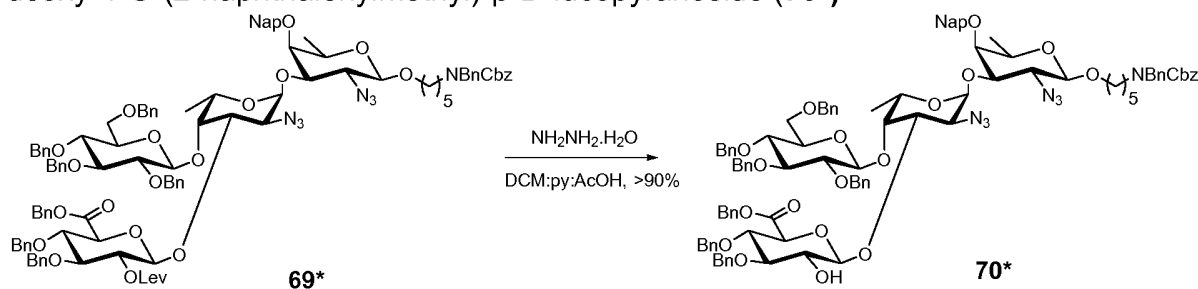

To a solution of tetrasaccharide **69*** (40 mg, 0.021 mmol, 1 equiv) in DCM (2 mL), a
 25 solution of hydrazine hydrate (13 μL , 0.26 mmol, 12 equiv) dissolved in AcOH (0.08
 mL) and pyridine (0.12 mL) was added. The resulting reaction mixture was stirred at
 rt for 1 to 2 h. The reaction was quenched by the addition of acetone and the solvent
 evaporated. Column chromatography on silica gel (hexanes/ethyl acetate) afforded
 tetrasaccharide **70*** (34 mg, 0.019 mmol, 90%). $[\alpha]_{\text{D}}^{20} = -66.6$ ($c = 1.00$, CHCl_3); IR
 30 ν_{max} (film) 3501, 3033, 2928, 2870, 2116, 1749, 1698, 1070, 735, 698 cm^{-1} , ^1H NMR
 (400 MHz, CDCl_3) δ 7.87 – 7.74 (m, 3H), 7.17 (s, 1H), 7.58 – 6.92 (m, 48H), 5.29 (d,
 $J = 3.7$ Hz, 1H), 5.21 – 5.13 (m, 3H), 5.08 – 4.71 (m, 10H), 4.59 – 4.38 (m, 6H), 4.37
 – 4.29 (m, 2H), 4.27 – 4.18 (m, 2H), 4.00 – 3.86 (m, 5H), 3.78 – 3.17 (m, 17H), 1.72

– 1.47 (m, 4H), 1.39 (d, $J = 6.4$ Hz, 3H), 1.43 – 1.27 (m, 2H), 1.04 (d, $J = 6.6$ Hz, 3H).
 ^{13}C NMR (101 MHz, CDCl_3) δ 168.0, 156.8, 156.3, 138.7, 138.7, 138.2, 138.1, 138.0,
 137.83, 137.78, 135.6, 135.3, 133.1, 133.0, 128.9, 128.7, 128.62, 128.61, 128.51,
 128.49, 128.47, 128.44, 128.40, 128.35, 128.26, 128.2, 128.1, 127.92, 127.89,
 127.86, 127.8, 127.7, 127.6, 127.3, 127.0, 126.7, 126.5, 126.3, 104.1, 103.4, 102.8,
 100.7, 84.6, 83.9, 82.3, 79.0, 78.8, 78.2, 77.6, 75.8, 75.7, 75.3, 75.23, 75.20, 75.1,
 75.0, 74.2, 73.2, 71.0, 70.0, 69.9, 68.2, 67.4, 67.2, 66.8, 63.8, 58.0, 50.6, 50.3, 47.2,
 46.3, 29.3, 28.0, 27.5, 23.3, 17.5, 16.8. HRMS (ESI+) Calcd for $\text{C}_{104}\text{H}_{111}\text{N}_7\text{O}_{20}\text{Na}^+$
 $[\text{M}+\text{Na}]^+$ 1801.7815, found 1801.7992.

10

Example 66: Synthesis of *N*-(Benzyl)benzyloxycarbonyl-5-amino-pentanyl 2-azido-3,4-di-*O*-benzyl-2-deoxy- α -L-pneumopyranosyl-(1 \rightarrow 2)-[2,3,4,6-tetra-*O*-benzyl- β -D-glucopyranosyl-(1 \rightarrow 4)]-benzyl-3,4-di-*O*-benzyl-6-*O*-benzoyl- β -D-glucopyranosyluronate-(1 \rightarrow 3)-2-azido-2-deoxy- α -L-fucopyranosyl-(1 \rightarrow 3)-2-azido-2-deoxy-4-*O*-(2-naphthalenylmethyl)- β -D-fucopyranoside (**71***)

15

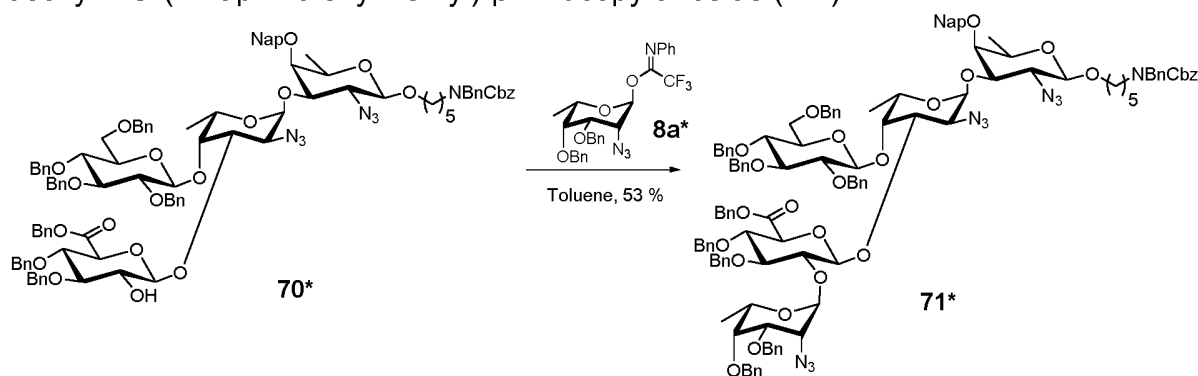

Acceptor **70*** (25 mg, 0.014 mmol, 1.0 equiv) and imidate **8a*** (23 mg, 0.042 mmol, 3.0 equiv) were coevaporated with toluene two times and dried *in vacuo*. The residue
 was dissolved in toluene (2 mL). The reaction mixture cooled to -35 °C. TMSOTf (0.25 μL , 1.4 μmol , 0.1 equiv) was added and the reaction let warm to -20 °C over 2h. The
 reaction was quenched with triethylamine, filtered and the solvent evaporated. Column chromatography on silica gel (hexanes/ethyl acetate) afforded
 pentasaccharide **71*** (16 mg, 0.07 mmol, 53%). $[\alpha]_{\text{D}}^{20} = -39.5$ ($c = 0.30$, CHCl_3); IR ν_{max} (film) 3034, 2931, 2870, 2115, 1750, 1698, 1455, 1070, 736, 698 cm^{-1} , ^1H NMR
 (600 MHz, CDCl_3) δ 7.87 – 7.73 (m, 3H), 7.68 (s, 1H), 7.62 – 7.02 (m, 55H), 7.02 – 6.86 (m, 3H), 5.32 (d, $J = 3.9$ Hz, 1H), 5.28 – 5.22 (m, 2H), 5.21 – 5.13 (m, 2H), 5.03
 – 4.39 (m, 22H), 4.33 (d, $J = 7.9$ Hz, 1H), 4.26 (d, $J = 10.9$ Hz, 1H), 4.24 – 4.16 (m, 2H), 4.06 (d, $J = 9.7$ Hz, 1H), 4.01 – 3.86 (m, 4H), 3.85 – 3.79 (m, 2H), 3.73 (t, $J =$
 8.3 Hz, 1H), 3.67 – 3.54 (m, 4H), 3.54 – 3.32 (m, 8H), 3.31 – 3.12 (m, 4H), 1.74 – 1.46 (m, 4H), 1.46 – 1.18 (m, 8H), 0.97 (d, $J = 6.7$ Hz, 3H). ^{13}C NMR (151 MHz,
 CDCl_3) δ 168.1, 138.7, 138.4, 137.7, 137.60, 135.58, 134.9, 133.2, 128.73, 128.65,

30

128.62, 128.57, 128.5, 128.44, 128.42, 128.37, 128.35, 128.23, 128.20, 128.1, 128.03, 127.97, 127.91, 127.87, 127.8, 127.7, 127.6, 127.5, 127.4, 127.2, 127.1, 126.7, 126.4, 126.2, 103.9, 102.9, 100.3, 99.2, 95.4, 85.2, 84.1, 81.2, 80.4, 78.8, 78.2, 77.5, 76.8, 76.5, 75.6, 75.1, 74.9, 74.84, 74.77, 74.5, 74.2, 73.2, 72.5, 71.1, 70.5, 70.0, 69.92, 69.87, 69.3, 68.0, 67.3, 67.0, 66.9, 66.5, 64.0, 57.9, 57.3, 50.7, 50.4, 47.3, 47.3, 46.3, 32.1, 29.8, 29.5, 29.4, 28.0, 27.60, 23.4, 23.3, 22.8, 17.5, 17.1, 17.0, 14.7, 14.3. HRMS (ESI+) Calcd for $C_{124}H_{132}N_{10}O_{23}Na^+$ $[M+Na]^+$ 2152.9398, found 2152.9582.

10 **Example 67:** Synthesis of *N*-(Benzyl)benzyloxycarbonyl-5-amino-pentanyl 2-*N*-acetyl-3,4-di-*O*-benzyl- α -L-pneumopyranosyl-(1 \rightarrow 2)-[2,3,4,6-tetra-*O*-benzyl- β -D-glucopyranosyl-(1 \rightarrow 4)]-benzyl-3,4-di-*O*-benzyl-6-*O*-benzoyl- β -D-glucopyranosyluronate-(1 \rightarrow 3)-2-*N*-acetyl- α -L-fucopyranosyl-(1 \rightarrow 3)-2-*N*-acetyl-4-*O*-(2-naphthalenylmethyl)- β -D-fucopyranoside (**72***)

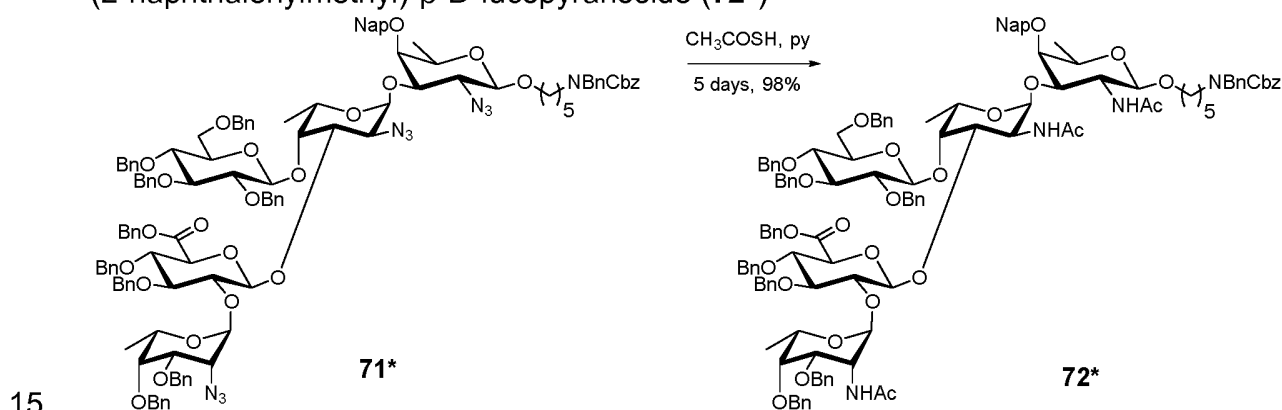

To a solution of azido pentasaccharide **71*** (32 mg, 0.015 mmol, 1 equiv) in pyridine (2 mL), thioacetic acid (0.5 mL) was added and stirred for 5 days at rt. The reaction mixture was concentrated and purified by column chromatography on silica gel (hexanes/acetone) to afford the acetamide pentasaccharide **72*** (32 mg, 0.015 mmol, 98%). $[\alpha]_D^{20} = -26.6$ ($c = 0.87$, $CHCl_3$); IR ν_{max} (film) 3420, 3330, 3030, 2935, 2870, 1677, 1455, 1364, 1070, 7, 698 cm^{-1} , 1H NMR (400 MHz, $CDCl_3$) δ 7.92 – 7.67 (m, 5H), 7.63 – 6.87 (m, 55H), 6.80 (d, $J = 7.5$ Hz, 2H), 6.09 (bs, 1H), 5.76 (bs, 1H), 5.51 (bs, 1H), 5.46 – 5.36 (m, 2H), 5.28 (s, 1H), 5.22 – 5.12 (m, 2H), 5.07 – 4.96 (m, 3H), 4.93 – 4.33 (m, 22H), 4.29 – 4.08 (m, 5H), 3.96 – 3.58 (m, 11H), 3.56 – 3.30 (m, 6H), 3.28 – 3.16 (m, 3H), 2.03 – 1.85 (m, 6H), 1.65 – 1.45 (m, 7H), 1.36 – 1.08 (m, 11H). ^{13}C NMR (151 MHz, $CDCl_3$) δ 171.6, 170.7, 169.7, 169.4, 138.6, 138.3, 138.2, 138.02, 137.98, 137.8, 137.7, 137.6, 136.3, 134.5, 133.2, 133.1, 128.9, 128.7, 128.65, 128.62, 128.58, 128.48, 128.43, 128.36, 128.33, 128.29, 128.2, 128.1, 128.02, 127.97, 127.94, 127.89, 127.69, 127.67, 127.64, 127.56, 127.44, 127.39, 126.9, 126.53, 126.49, 126.2, 103.8, 100.5, 99.7, 97.0, 95.0, 85.3, 84.5, 80.9, 80.6,

20

25

30

78.8, 78.3, 77.8, 76.2, 75.8, 75.3, 75.1, 74.4, 74.22, 73.4, 73.2, 71.7, 70.7, 69.8, 69.5, 68.3, 67.4, 67.3, 66.6, 66.5, 55.2, 50.6, 50.4, 49.6, 48.0, 47.4, 46.2, 29.3, 27.99, 27.5, 24.0, 23.6, 23.3, 17.6, 17.5, 16.5. HRMS (ESI+) Calcd for $C_{130}H_{144}N_4O_{26}Na^+$ $[M+Na]^+$ 2201.0000, found 2201.0086.

5

Example 68: Synthesis of 5-amino-pentanyl 2-*N*-acetyl- α -L-pneumopyranosyl-(1 \rightarrow 2)-[β -D-glucopyranosyl-(1 \rightarrow 4)]- β -D-glucopyranosyluronate-(1 \rightarrow 3)-2-*N*-acetyl- α -L-fucopyranosyl-(1 \rightarrow 3)-2-*N*-acetyl- β -D-fucopyranoside (**73***)

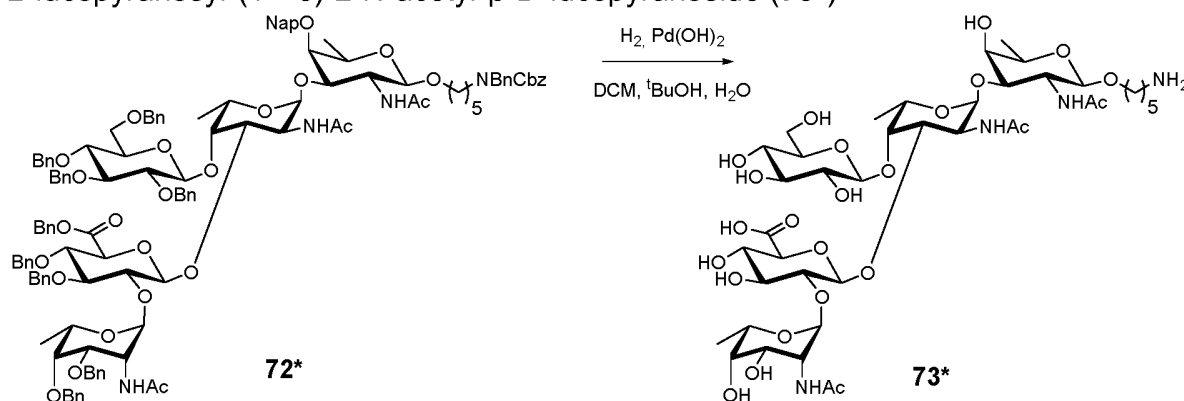

10

The pentasaccharide **72*** was dissolved in $CH_2Cl_2/tBuOH/water$ (1.5:16:8, 1 mL), purged with argon and treated with a suspension of $Pd(OH)_2$ on carbon (20% (w/w) loading, 10 mg) in the same solvent mixture (1 mL). The suspension was purged with hydrogen, stirred under hydrogen atmosphere at rt. After 24 h, a freshly prepared suspension of $Pd(OH)_2$ (5 mg, 1mL) was added and the reaction was stirred for 24h more, filtered and concentrated. The residue was purified by solid phase extraction (Chromabond C18, Macherey-Nagel) and size exclusion chromatography on Sephadex LH-20 (MeOH: H_2O) and lyophilized to give pentasaccharide **73*** (3 mg, 2.99 μ mol, 50%) as a white solid.

15

1H NMR (400 MHz, D_2O) δ 5.16 (d, $J = 4.0$ Hz, 1H), 5.07 (s, 1H), 5.00 (d, $J = 7.6$ Hz, 1H), 4.58 – 4.47 (m, 2H), 4.44 – 4.28 (m, 3H), 4.17 – 4.05 (m, 3H), 4.00 – 3.61 (m, 12H), 3.56 – 3.27 (m, 7H), 3.11 (dd, $J = 9.3, 7.9$ Hz, 1H), 2.99 – 2.88 (m, 2H), 2.00 (s, 3H), 1.96 (s, 3H), 1.95 (s, 3H), 1.69 – 1.46 (m, 4H), 1.41 – 1.26 (m, 5H), 1.22 (d, $J = 6.4$ Hz, 3H), 1.05 (d, $J = 6.5$ Hz, 3H). ^{13}C NMR (101 MHz, D_2O) δ 176.0, 174.01, 173.97, 173.3, 102.8, 101.6, 99.7, 97.3, 93.7, 77.8, 76.0, 75.8, 75.2, 73.8, 71.9, 71.7, 71.0, 70.9, 70.6, 70.3, 69.9, 69.8, 67.0, 66.9, 63.8, 60.6, 51.4, 50.8, 49.0, 39.2, 28.1, 26.3, 22.3, 22.1, 21.9, 15.9, 15.3, 15.2. HRMS (ESI+) Calcd for $C_{141}H_{70}N_4O_{24}Na^+$ $[M+Na]^+$ 1026.4311, found 1026.4397.

25

Example 69: *N*-(Benzyl)-benzyloxycarbonyl-5-amino-pentanyl 2-azido-2-deoxy-4-*O*-(2-naphthalenylmethyl)-3-*O*-allyl- β -D-fucopyranoside (**74***)

30

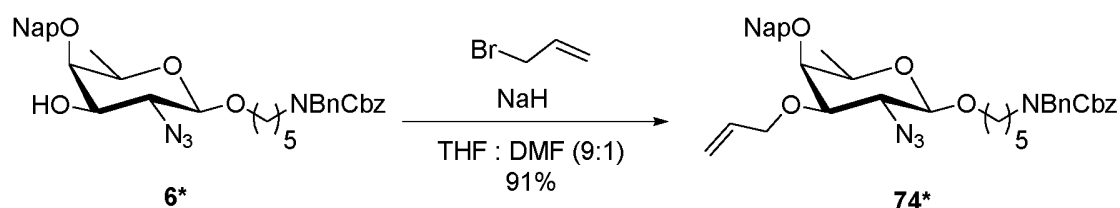

Allyl bromide (30 μ L, 0.35 mmol, 1.5 equiv) was added to a solution of alcohol **6*** (150 mg, 0.24 mmol, 1 equiv) in THF:DMF (9:1, 2.0 mL). Then, the mixture was cooled to 0°C and NaH 60% in mineral oil (19 mg, 0.47 mmol, 2 equiv) was added. The reaction was warmed to room temperature and let stir overnight. The reaction mixture was diluted with DCM and quenched with NaHCO₃. The organic phase was washed with brine, dried over Na₂SO₄, filtered and the solvent evaporated. Column chromatography on silica gel (hexanes/ethyl acetate) afforded the allyl fucopyranoside **74*** (145 mg, 0.21 mmol, 91%). ¹H NMR (600 MHz, CDCl₃) δ 7.41 – 7.19 (m, 15H), 7.18–7.11 (m, 2H), 6.82 (d, *J* = 8.4 Hz, 2H), 5.19 (t, *J* = 8.8 Hz, 1H), 4.83 – 4.74 (m, 4H), 4.53 – 4.43 (m, 3H), 4.39 (d, *J* = 5.3 Hz, 2H), 4.26 (d, *J* = 7.7 Hz, 1H), 3.85 – 3.82 (m, 1H), 3.77 (s, 3H), 3.73 – 3.63 (m, 2H), 3.60 – 3.43 (m, 4H), 3.33 (q, *J* = 6.6 Hz, 1H), 3.08 (dd, *J* = 10.5, 3.0 Hz, 1H), 2.90 – 2.79 (m, 1H), 2.65 – 2.55 (m, 2H), 2.53 – 2.45 (m, 1H), 2.14 (s, 3H), 1.64 (h, *J* = 6.8 Hz, 1H), 1.27 (d, *J* = 6.6 Hz, 3H), 0.91 – 0.81 (m, 12H), 0.11 (d, *J* = 12.5 Hz, 6H). ¹³C NMR (151 MHz, CDCl₃) δ 156.8, 156.3, 138.0, 137.0, 136.9, 135.8, 134.5, 133.2, 133.1, 128.6, 128.5, 128.1, 128.0, 127.9, 127.8, 127.3, 127.2, 126.7, 126.1, 126.0, 117.6, 102.3, 81.0, 74.7, 71.6, 70.6, 69.7, 69.6, 67.2, 63.0, 50.6, 50.3, 47.2, 46.3, 29.3, 28.0, 27.5, 23.3, 17.1. HRMS (ESI+) Calcd for C₄₀H₄₆N₄O₆Na⁺ [M+Na]⁺ 701.3315, found 701.3336.

Example 70: *N*-(Benzyl)-benzyloxycarbonyl-5-amino-pentanyl 2-azido-2-deoxy-4-*O*-acetyl-3-*O*-allyl- β -D-quinovopyranoside (**77***)

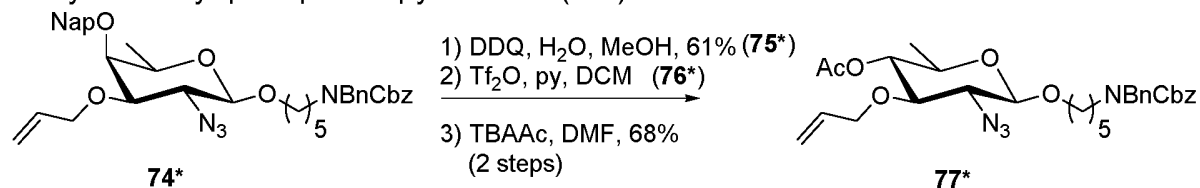

25

To a solution of fucopyranoside **74*** (145 mg, 0.21 mmol, 1 equiv) in DCM:H₂O (18:1, 2 mL) was added 2,3-dichloro-5,6-dicyano-1,4-benzoquinone (58 mg, 0.26 mmol, 1.2 equiv) at 0°C. The reaction was warmed to rt and let stir for 2.5h. The reaction was diluted with DCM and NaHCO₃ was added. The organic phase was washed (3x) with NaHCO₃ until the solution was colorless. Then, the organic phase was washed with brine, dried over Na₂SO₄ and the solvent evaporated. Column chromatography on silica gel (hexanes/ethyl acetate) afforded fucopyranoside **75*** (70 mg, 0.13 mmol,

30

61%). To a solution of fucopyranoside **75*** (35 mg, 0.065 mmol, 1 equiv) in DCM (1 mL) was added pyridine (32 μ L, 0.390 mmol, 6 equiv) and triflic anhydride (22 μ L, 0.130 mmol, 2 equiv) at 0°C. The resulting deep purple colored reaction mixture was let stir at 0°C for 30 min. Then, the reaction was diluted with DCM and quenched with NaHCO₃. The phases were separated and the organic layer was washed with brine, dried over Na₂SO₄, filtered and the solvent evaporated. The resulting oil was co-evaporated with toluene, dissolved in DMF (1 mL) and used in the next step without further purification. Tetrabutylammonium acetate was added to the solution of the triflate (**76***) in DMF and let stir overnight at rt. The solvent was evaporated. Column chromatography on silica gel (hexanes/ethyl acetate) afforded the quinovopyranoside **77*** (26 mg, 0.044 mmol, 68%). $[\alpha]_D^{20} = -19.6$ (c = 0.56, CHCl₃); IR ν_{max} (film) 2939, 2868, 2111, 1747, 1698, 1423, 1230, 1066, 699 cm⁻¹; ¹H NMR (400 MHz, CDCl₃) δ 7.45 – 7.08 (m, 10H), 5.86 (ddt, *J* = 17.2, 10.4, 5.7 Hz, 1H), 5.30 – 5.10 (m, 4H), 4.74 (t, *J* = 9.5 Hz, 1H), 4.56 – 4.41 (m, 2H), 4.32 – 4.15 (m, 2H), 4.12 – 4.05 (m, 1H), 3.94 – 3.76 (m, 1H), 3.56 – 3.32 (m, 3H), 3.30 – 3.16 (m, 3H), 2.09 (s, 3H), 1.69 – 1.46 (m, 4H), 1.42 1.26 (m, 2H), 1.19 (d, *J* = 6.2 Hz, 3H). ¹³C NMR (151 MHz, CDCl₃) δ 169.8, 138.1, 134.6, 128.7, 128.6, 128.04, 127.97, 127.4, 117.3, 102.0, 80.1, 74.9, 73.7, 70.2, 67.3, 66.2, 50.7, 50.4, 47.2, 46.3, 29.3, 28.0, 27.6, 23.3, 21.1, 17.5. HRMS (ESI+) Calcd for C₃₁H₄₀N₄O₇Na⁺ [M+Na]⁺ 603.2795, found 603.2809.

20

Example 71: *N*-(Benzyl)-benzyloxycarbonyl-5-amino-pentanyl 2-azido-2-deoxy-4-*O*-(2-naphthalenylmethyl)-3-*O*-allyl- β -D-quinovopyranoside (**79***)

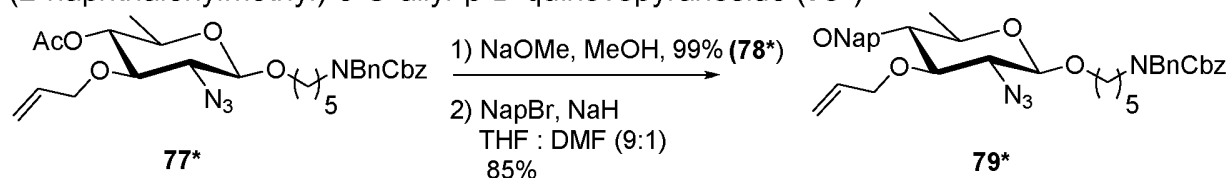

25 To a solution of quinovopyranoside **77*** (35 mg, 0.060 mmol, 1 equiv) in MeOH (0.5 mL) was added 0.5 M NaOMe in MeOH (0.362 mL, 0.181 mmol, 3 equiv) and stirred overnight. The mixture was neutralized with Amberlite[®] IR 120 (H⁺) ion exchange resin, filtered and concentrated *in vacuo*. Column chromatography on silica gel (hexanes/ethyl acetate) afforded alcohol (**78***) (32 mg, 0.059 mmol, 99%). 2-naphthalenylmethyl bromide (20 mg, 0.091 mmol, 1.5 equiv) was added to a solution of alcohol (**78***) (32.5 mg, 0.060 mmol, 1 equiv) in THF: DMF (9:1, 1.0 mL). Then, the mixture was cooled to 0°C and NaH 60% in mineral oil (3 mg, 0.121 mmol, 2 equiv) was added. The reaction was warmed to room temperature. After 1.5h, 2 equiv of NaH were added and the reaction let stir for further 1h. The reaction mixture was diluted with DCM and quenched with NaHCO₃. Then, the organic phase was washed with brine, dried over Na₂SO₄, filtered and the solvent evaporated. Column

35

chromatography on silica gel (hexanes/ethyl acetate) afforded the quinovopyranoside **79*** (35 mg, 0.052 mmol, 82%). ¹H NMR (400 MHz, CDCl₃) δ 7.78 – 7.71 (m, 3H), 7.70 (bs, 1H), 7.45 – 7.33 (m, 3H), 7.33 – 7.04 (m, 10H), 5.92 (ddt, *J* = 16.4, 10.3, 5.8 Hz, 1H), 5.24 (dd, *J* = 16.0, 1.6 Hz, 1H), 5.18 – 5.03 (m, 3H), 4.83 (ABq, *J* = 11.0 Hz, 2H), 4.42 (d, *J* = 7.7 Hz, 2H), 4.27 (qdt, *J* = 12.2, 5.9, 1.5 Hz, 2H), 4.11 (t, *J* = 8.7 Hz, 1H), 3.83 – 3.69 (tt, *J* = 15.6, 6.3 Hz, 1H), 3.47 – 3.03 (m, 7H), 1.62 – 1.37 (m, 4H), 1.35 – 1.16 (m, 2H), 1.22 (d, *J* = 6.1 Hz, 3H). ¹³C NMR (101 MHz, CDCl₃) δ 156.8, 156.3, 138.0, 137.0, 136.9, 135.5, 134.8, 133.4, 133.1, 128.63, 128.57, 128.4, 128.0, 127.9, 127.8, 127.4, 127.3, 126.9, 126.3, 126.2, 126.1, 101.9, 83.3, 82.7, 75.5, 74.4, 71.4, 70.0, 69.9, 67.2, 66.5, 50.6, 50.3, 47.2, 46.3, 29.3, 28.0, 27.5, 23.3, 18.0. HRMS (ESI+) Calcd for C₄₀H₄₆N₄O₆Na⁺ [M+Na]⁺ 701.3315, found 701.3348.

Example 72: *N*-(Benzyl)-benzyloxycarbonyl-5-amino-pentanyl 2-azido-2-deoxy-4-*O*-(2-naphthalenylmethyl)-β-*D*-quinovopyranoside (**80***)

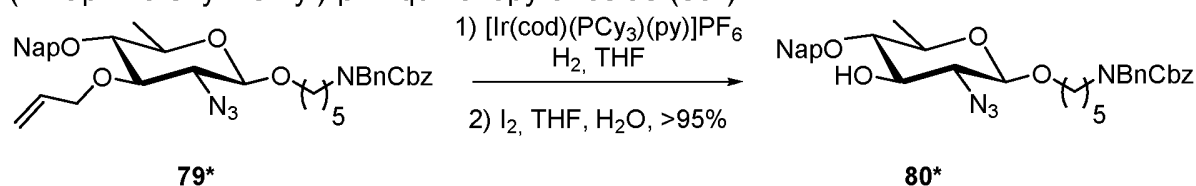

15

79***80***

Iridium complex (0.71 mg, 0.884 μmol, 0.02 equiv) was taken in dry THF (2 mL) and bubbled with nitrogen for 2 minutes at rt. The red colored catalyst dissolved in THF. Then, the solution was purged with hydrogen for about 2 more minutes. The reaction mixture color changed from red to colorless and the solution was let stir for 15 minutes under hydrogen pressure. The solution of the active catalyst was added to the of solution of allyl quinovopyranoside **79*** (30 mg, 0.044 mmol, 1 equiv) in dry THF (1 mL) under argon via syringe and let stir for 2 hours at rt. The reaction mixture was quenched with NaHCO₃ solution and extracted with DCM. Combined organic layers were washed with brine, dried over Na₂SO₄, filtered and evaporated to get the isomerized compound (isomerization confirmed by ¹H NMR). The substrate was taken in THF-water (2:1, 1.5 mL) and iodine (22 mg, 0.088 mmol, 2 equiv) was added at rt. The brown colored solution was stirred for 2 hours before quenched with 10% solution of Na₂S₂O₃ solution. Then, the aqueous phase was extracted with ethyl acetate (3x). Combined organic layers were dried over Na₂SO₄, filtered and the solvent evaporated to get brown liquid. Column chromatography on silica gel (hexanes/ethyl acetate) afforded the quinovopyranoside **80*** (30 mg, 0.053 mmol, quant.). [α]_D²⁰ = - 8.4 (*c* = 1.7, CHCl₃); IR ν_{\max} (film) 3429, 3032, 2937, 2868, 2110, 1698, 1455, 1424, 1093, 698 cm⁻¹; ¹H NMR (600 MHz, CDCl₃) δ 7.87 – 7.80 (m, 3H), 7.79 (s, 1H), 7.51 – 7.45 (m, 3H), 7.42 – 7.13 (m, 10H), 5.18 (d, *J* = 18.8 Hz, 2H), 4.94 (ABq, *J* = 11.4 Hz, 2H), 4.50 (d, *J* = 12.8 Hz, 2H), 4.31 – 4.18 (m, 1H), 3.92 –

35

3.78 (m, 1H), 3.54 – 3.34 (m, 3H), 3.34 – 3.12 (m, 4H), 2.49 (d, $J = 2.8$ Hz, 1H), 1.60 (q, $J = 13.9, 7.5$ Hz, 4H), 1.43 – 1.27 (m, 2H), 1.36 (d, $J = 6.2$ Hz, 3H). ^{13}C NMR (151 MHz, CDCl_3) δ 156.9, 156.3, 138.1, 135.5, 133.4, 133.2, 128.7, 128.6, 128.1, 128.03, 127.96, 127.9, 127.3, 127.0, 126.4, 126.2, 126.0, 101.9, 83.2, 75.3, 71.4, 70.0, 67.3, 66.7, 50.7, 50.3, 47.2, 46.3, 29.4, 28.0, 27.6, 23.3, 18.1. HRMS (ESI+) Calcd for $\text{C}_{37}\text{H}_{42}\text{N}_4\text{O}_6\text{Na}^+$ $[\text{M}+\text{Na}]^+$ 661.3002, found 661.3019.

Example 73: Synthesis of *N*-(Benzyl)benzyloxycarbonyl-5-amino-pentanyl [2,3,4,6-tetra-*O*-benzyl- β -D-glucopyranosyl-(1 \rightarrow 4)]-benzyl-3,4-di-*O*-benzyl-6-*O*-benzoyl- β -D-glucopyranosyluronate-(1 \rightarrow 3)-2-azido-2-deoxy- α -L-fucopyranosyl-(1 \rightarrow 3)-2-azido-2-deoxy-4-*O*-(2-naphthalenylmethyl)- β -D-quinovopyranoside (**82***)

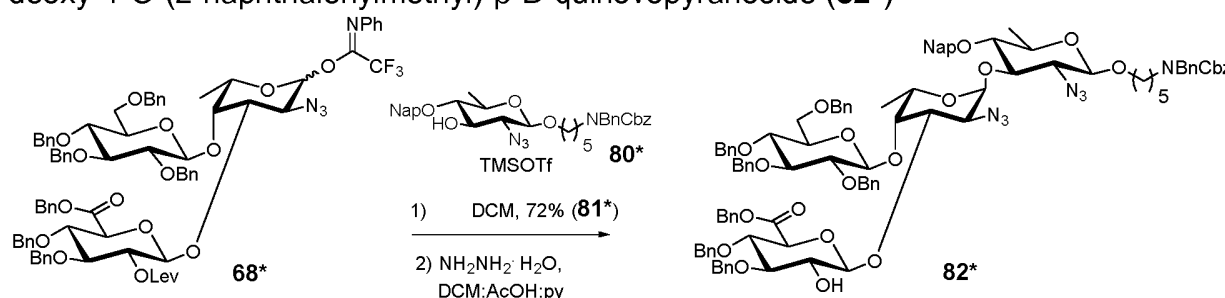

Acceptor **80*** (17 mg, 0.027 mmol, 1.9 equiv) and trisaccharide imidate **68*** (20 mg, 0.014 mmol, 1.0 equiv) were coevaporated with toluene two times and dried *in vacuo*. The residue was dissolved in DCM (1 mL). Molecular sieves acid washed (4 Å) were added and the reaction mixture cooled to -35°C . TMSOTf (1 μL , 5.5 μmol , 0.4 equiv) was added and the reaction let warm to -20°C over 1h. The reaction was quenched with triethylamine, filtered and the solvent evaporated. Column chromatography on silica gel (hexanes/ethyl acetate) afforded tetrasaccharide (**81***) (19.3 mg, 10.3 μmol , 73%). HRMS (ESI+) Calcd for $\text{C}_{109}\text{H}_{117}\text{N}_7\text{O}_{22}\text{Na}^+$ $[\text{M}+\text{Na}]^+$ 1899.8183, found 1899.8203. To a solution of tetrasaccharide (**81***) (17 mg, 0.009 mmol, 1 equiv) in DCM (1 mL), a solution of hydrazine hydrate (6 μL , 0.12 mmol, 13 equiv) dissolved in AcOH (0.04 mL) and pyridine (0.06 mL) was added. The resulting reaction mixture was stirred at rt for 1 to 2 h. The reaction was quenched by the addition of acetone and the solvent evaporated. Column chromatography on silica gel (hexanes/ethyl acetate) afforded tetrasaccharide **82*** (14 mg, 7.87 μmol , 87%). ^1H NMR (400 MHz, CDCl_3) δ 7.72 (m, 3H), 7.66 (bs, 1H), 7.41 – 7.35 (m, 2H), 7.31 – 7.12 (m, 41H), 7.09 – 7.04 (m, 3H), 6.98 – 6.90 (m, 2H), 5.59 (d, $J = 3.7$ Hz, 1H), 5.15 – 5.04 (m, 4H), 4.97 – 4.87 (m, 2H), 4.82 – 4.57 (m, 8H), 4.47 – 4.40 (m, 5H), 4.35 – 4.28 (m, 3H), 4.27 – 4.18 (m, 1H), 4.13 (d, $J = 7.1$ Hz, 1H), 3.99 – 3.80 (m, 5H), 3.68 – 3.31 (m, 16H), 3.25 – 3.10 (m, 4H), 1.65 – 1.40 (m, 4H), 1.37 – 1.22 (m,

2H), 1.31 (d, $J = 6.1$ Hz, 3H), 0.75 (d, $J = 6.6$ Hz, 3H). HRMS (ESI+) Calcd for $C_{104}H_{111}N_7O_{20}Na^+$ $[M+Na]^+$ 1801.7815, found 1801.7781.

- Example 74:** Synthesis of *N*-(Benzyl)benzyloxycarbonyl-5-amino-pentanyl 2-azido-3,4-di-*O*-benzyl-2-deoxy- α -L-pneumopyranosyl-(1 \rightarrow 2)-[2,3,4,6-tetra-*O*-benzyl- β -D-glucopyranosyl-(1 \rightarrow 4)]-benzyl-3,4-di-*O*-benzyl-6-*O*-benzoyl- β -D-glucopyranosyluronate-(1 \rightarrow 3)-2-azido-2-deoxy- α -L-fucopyranosyl-(1 \rightarrow 3)-2-azido-2-deoxy-4-*O*-(2-naphthalenylmethyl)- β -D-quinovopyranoside (**83***)

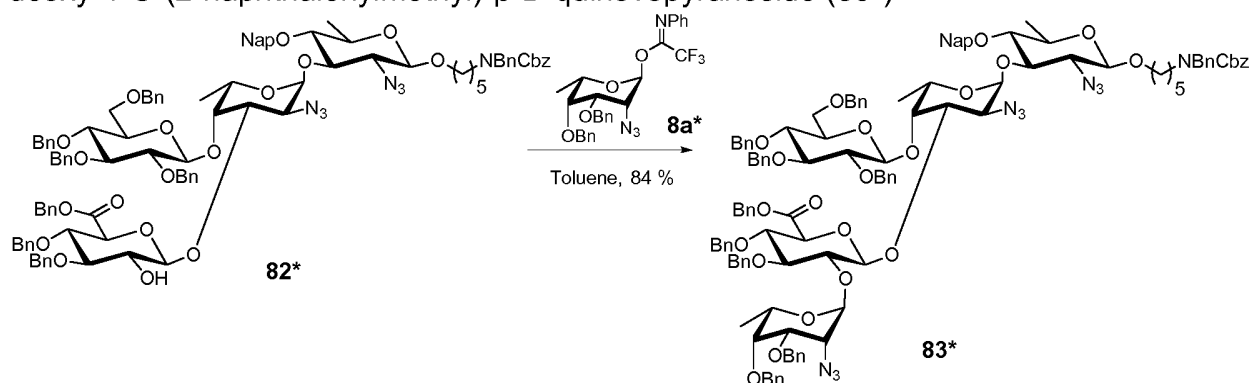

10

Acceptor **82*** (13.5 mg, 7.6 μ mol, 1.0 equiv) and imidate **8a*** (10 mg, 0.019 mmol, 2.4 equiv) were coevaporated with toluene two times and dried *in vacuo*. The residue was dissolved in toluene (1 mL). The reaction mixture cooled to -35°C . TMSOTf (0.25 μ L, 1.4 μ mol, 0.1 equiv) was added and the reaction let warm to -20°C over 2h. The reaction was quenched with triethylamine, filtered and the solvent evaporated. Column chromatography on silica gel (hexanes/ethyl acetate) afforded pentasaccharide **83*** (13.5 mg, 6.34 μ mol, 84%). HRMS (ESI+) Calcd for $C_{124}H_{132}N_{10}O_{23}Na^+$ $[M+Na]^+$ 2152.9398, found 2152.9406.

15

- Example 75:** Synthesis of 5-amino-pentanyl 2-*N*-acetyl- α -L-pneumopyranosyl-(1 \rightarrow 2)-[β -D-glucopyranosyl-(1 \rightarrow 4)]- β -D-glucopyranosyluronate-(1 \rightarrow 3)-2-*N*-acetyl- α -L-fucopyranosyl-(1 \rightarrow 3)-2-*N*-acetyl- β -D-quinovopyranoside (**85***)

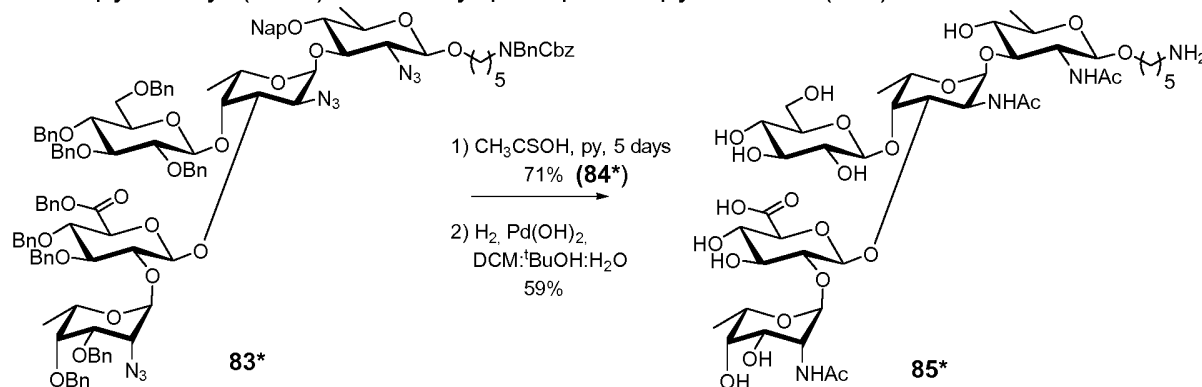

20

To a solution of azido pentasaccharide **83*** (13 mg, 6.1 μmol , 1 equiv) in pyridine (1 mL), thioacetic acid (0.25 mL) was added and stirred for 5 days at rt. The reaction mixture was concentrated and purified by column chromatography on silica gel (hexanes/acetone) to afford the acetamide pentasaccharide (**84***) (9.4 mg, 4.31 μmol , 71%). HRMS (ESI+) Calcd for $\text{C}_{130}\text{H}_{144}\text{N}_4\text{O}_{26}\text{Na}^+$ $[\text{M}+\text{Na}]^+$ 2201.0000, found 2201.0027. The pentasaccharide (**84***) (5.5 mg, 2.52 μmol , 1 equiv) was dissolved in $\text{CH}_2\text{Cl}_2/t\text{BuOH}/\text{water}$ (1.5:16:8, 1 mL), purged with argon and treated with a suspension of $\text{Pd}(\text{OH})_2$ on carbon (20% (w/w) loading, 10 mg) in the same solvent mixture (1 mL). The suspension was purged with hydrogen and stirred under hydrogen atmosphere at rt. After 24h, a freshly prepared suspension of $\text{Pd}(\text{OH})_2$ (5 mg, 1mL) was added and the reaction was stirred for 24h more, filtered and concentrated. The residue was purified by solid phase extraction (Chromabond C18, Macherey-Nagel) and size exclusion chromatography on Sephadex LH-20 (MeOH:H₂O) and lyophilized to give pentasaccharide **85*** (1.5 mg, 1.49 μmol , 59%) as a white solid. ¹H NMR (400 MHz, D₂O) δ 5.20 (d, $J = 4.0$ Hz, 1H), 5.09 (s, 1H), 5.01 (d, $J = 7.6$ Hz, 1H), 4.52 (d, $J = 7.9$ Hz, 1H), 4.51 – 4.29 (m, 5H), 4.18 – 4.13 (m, 1H), 4.13 – 4.07 (m, 1H), 4.02 – 3.90 (m, 2H), 3.86 – 3.62 (m, 6H), 3.58 (t, $J = 9.4$ Hz, 1H), 3.54 – 3.30 (m, 9H), 3.25 (t, $J = 9.2$ Hz, 1H), 3.13 (dd, $J = 9.3, 7.9$ Hz, 1H), 2.97 – 2.92 (m, 2H), 2.01 (s, 3H), 1.97 (s, 3H), 1.96 (s, 3H), 1.68 – 1.49 (m, 4H), 1.40 – 1.31 (m, 2H), 1.31 – 1.23 (m, 6H), 1.07 (d, $J = 6.6$ Hz, 3H). ¹³C NMR (151 MHz, D₂O) δ 175.8, 173.9, 173.6, 173.2, 102.6, 101.3, 99.5, 96.0, 93.6, 77.6, 77.1, 76.3, 75.8, 75.7, 75.3, 73.7, 73.4, 71.8, 71.5, 71.1, 70.7, 69.9, 69.7, 66.9, 66.8, 66.6, 63.7, 60.5, 55.5, 50.6, 48.7, 39.2, 28.0, 26.6, 22.2, 22.1, 22.0, 21.8, 16.6, 15.6, 15.2. HRMS (ESI+) Calcd for $\text{C}_{141}\text{H}_{70}\text{N}_4\text{O}_{24}\text{Na}^+$ $[\text{M}+\text{Na}]^+$ 1025.4278, found 1025.4309.

25

Example 76: 5-amino-pentanyl [β -D-glucopyranosyl-(1 \rightarrow 4)]- β -D-glucopyranosyluronate-(1 \rightarrow 3)-2-N-acetyl- α -L-fucopyranoside (**Ref. 1**)

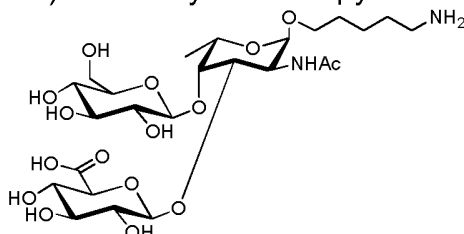

¹H NMR (400 MHz, D₂O) δ 4.93 (d, $J = 3.5$ Hz, 1H), 4.67 – 4.56 (m, 2H), 4.30 – 4.27 (m, 1H), 4.26 – 4.03 (m, 3H), 3.92 – 3.84 (m, 1H), 3.76 – 3.60 (m, 3H), 3.54 – 3.25 (m, 8H), 2.94 (t, $J = 7.6$ Hz, 2H), 1.97 (s, 3H), 1.68 – 1.52 (m, $J = 20.7, 7.0, 6.4$ Hz, 4H), 1.44 – 1.34 (m, $J = 7.6$ Hz, 1H), 1.31 (d, $J = 6.7$ Hz, 3H), 1.27 – 1.18 (m, 1H). HRMS (ESI+) Calcd for $\text{C}_{25}\text{H}_{44}\text{N}_2\text{O}_6\text{Na}^+$ $[\text{M}+\text{Na}]^+$ 651.2589, found 651.2598.

30

Example 77: 5-amino-pentanyl [β -D-glucopyranosyl-(1 \rightarrow 4)]- β -D-glucopyranosyluronate-(1 \rightarrow 3)-2-N-acetyl- α -L-fucopyranosyl-(1 \rightarrow 3)-2-N-acetyl- β -D-fucopyranoside (Ref. 2)

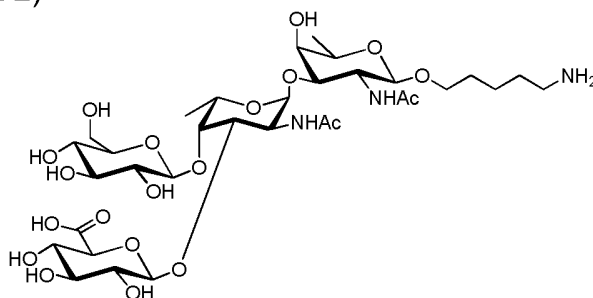

5 ^1H NMR (400 MHz, D_2O) δ 5.04 (d, $J = 3.9$ Hz, 1H), 4.65 – 4.60 (m, 2H), 4.38 (d, $J = 8.5$ Hz, 1H), 4.34 – 4.06 (m, 4H), 3.95 – 3.24 (m, 16H), 2.98 – 2.90 (m, 2H), 1.98 (s, 3H), 1.96 (s, 3H), 1.68 – 1.49 (m, 4H), 1.41 – 1.17 (m, 2H), 1.31 (d, $J = 6.8$ Hz, 3H), 1.23 (d, $J = 6.5$ Hz, 3H). HRMS (ESI+) Calcd for $\text{C}_{33}\text{H}_{57}\text{N}_3\text{O}_{20}\text{Na}^+$ $[\text{M}+\text{Na}]^+$ 833.3433, found 833.3441.

10

Example 78: Glycan Microarray Preparation and Screening - I

64 well glycan arrays were printed using a Scienion S3 microarray printer on CodeLink® NHS activated glass slides (Surmodics). All compounds (proteins and
15 glycan containing an aminolinker) were dissolved in printing buffer (50 mM sodium phosphate, pH 8.5). The printed slides were stored overnight in a humidity saturated chamber for complete reaction, dried by centrifugation at 1200 g and stored at 4 °C afterwards. Prior to use, slides were washed with water, quenched with quenching solution (50 mM sodium phosphate, 100 mM ethanolamine, pH 7.4) at room
20 temperature for 2 h, washed with water and blocked for 1 h at room temperature with 1% BSA in PBS. After washing with PBS, the slides were dried by centrifugation. A 64 well gasket was applied to the slides and primary antibody incubation (serum dilutions in 1% BSA-PBS) was carried out at room temperature for 1 h. The wells were washed three times for 10 min with PBS containing 0.1% Tween-20. Secondary
25 antibody dilutions were pipetted into the wells. After 1h incubation at room temperature in the dark, the slides were washed three times for 10 min with PBS containing 0.1% Tween-20 and once shortly with water. The gasket was removed and the slides were dried by centrifugation. Fluorescence was read out using a GenePix 4300A microarray scanner (Bucher Biotec, Basel, Switzerland) with a 488
30 nm laser for FITC excitation and a 594 nm laser for AlexaFluor 594. GenePix Pro 7 (Bucher Biotec) was used for analysis.

A glycan microarray prepared as above described containing eleven SP5 CPS substructures was used to identify the binding epitopes of commercial anti-SP5 specific typing sera generated in rabbits (see **Figure 4**).

5 As shown by **Figure 4A**, only three out of eleven glycans were bound by specific anti-SP5 IgG, namely tetrasaccharide **33*** (position 1), α -PneNAc-(1 \rightarrow 2)-GlcA disaccharide **27*** (position 8) and α -PneNAc monosaccharide **36*** (position 10). All three recognized oligosaccharides contain the α -PneNAc residue, demonstrating that this motif is part of the recognized epitope. It was further observed that IgG bound
10 tetrasaccharide **33*** and disaccharide **27*** in comparable levels, suggesting that α -PneNAc-(1 \rightarrow 2)-GlcA is in fact the epitope recognized by IgG of specific SP5 typing sera. **Figure 4B** shows a microarray sample where the typing serum was pre-incubated with a solution of the natural SP5 CPS. The anti-glycan IgG levels are significantly reduced compared to the sample of **Figure 4A**. This means that
15 antibodies bound to the natural CPS during pre-incubation are no longer available for binding to the synthetic glycans. Consequently, the binding epitopes of natural CPS and the synthetic glycans are identical.

In order to identify epitopes recognized by the human immune system, further
20 screenings were carried out using pooled sera of humans who had received a pneumococcal CPS-based vaccine, containing the CPS of multiple different serotypes (see **Figure 5**).

The IgG response of immunized humans towards the synthetic glycans is shown in
25 **Figure 5A**. Although the sera of immunized humans were not SP5 specific, they contained IgG predominantly against tetrasaccharide **33*** (position 1). IgG binding to PNeNAc-(1 \rightarrow 2)-GlcA disaccharide **27*** (position 8) and PNeNAc **36*** (position 10) were also observed, however at lower levels.

30 Additionally, low levels of anti-**21*** (position 5) and anti-**51*** (position 6) IgG and very low levels of anti-**20*** (position 4), anti-**44*** (position 7), anti-**52*** (position 9) and anti-**37*** (position 11) IgG were detected. Antibodies against D-FucNAc **15*** (position 3) and the Sug-containing sample **14*** (position 2) were not detected at all. Interestingly, higher levels of anti-disaccharide **21*** antibodies were detected than for the sample
35 containing L-FucNAc-(1 \rightarrow 3)- β -Sug **20***. This would suggest that the presence of the ketone is indeed detrimental to antibody binding. Pre-incubation of the human sera with the natural SP5 CPS, shown in **Figure 5B**, led to a significant reduction of anti-tetrasaccharide **33*** IgG levels. This proves that the antibodies binding **33*** are SP5 specific since they also bind the SP5 CPS.

In conclusion, the microarray analyses revealed that the terminal PneNAc residue is part of the epitope recognized by anti-SP5 CPS antibodies and that α -PneNAc-(1 \rightarrow 2)-GlcA is the predominant epitope recognized by SP5 typing sera. In the case of vaccinated humans, the SP5-specific epitope seems to be larger, resembling tetrasaccharide **33***. The reducing end D-FucNAc or Sug residues do not seem to be important for the immunological response to SP5.

Example 79: Conjugation of tetrasaccharide 33* to CRM₁₉₇: synthesis of conjugate 58*a , 58*b and 58*c

Conjugates were prepared using a two-step procedure as described here in details.

Step 1: Formation of the *p*-nitro phenyl (PNP) amide

To the tetrasaccharide **33*** (0.5 mg, 0.6 μ mol, 1 equivalent) and diphenyl adipate (1.6 mg, 4.2 μ mol, 7 equivalents) in a glass vial were added a mixture of pyridine and DMSO (1:1, 0.24 mL) and the mixture let stir for 5 minutes for complete solubilization. Then, triethylamine (0.83 μ L, 6 μ mol, 10 equivalents) was added and let stir for 20 minutes. TLC indicated complete consumption of the starting material. The solvent was removed in *vacuum*. The residue was washed with dichloromethane (3 x 1 mL) to remove PNP ester excess and the white solid obtained was dried in *vacuum*.

Step 2: Conjugation with CRM₁₉₇

The compound obtained at step 1 (40 equivalents) was dissolved in DMSO (10 μ L), CRM₁₉₇ (1 equivalent) was added in sodium phosphate buffer (0.1 NaPi, pH ~ 8.0) and the mixture let stir for 18h. Then, the reaction mixture was washed twice with 400 μ L of buffer (pH ~ 8.0), followed by washing with 400 μ L of autoclaved water three times using amicon filter (10000 KDa). The material was transferred to Eppendorf vial using PBS buffer and stored at -20 $^{\circ}$ C (400 μ L).

The same procedure was repeated with buffer pH ~ 8.5.

30

117

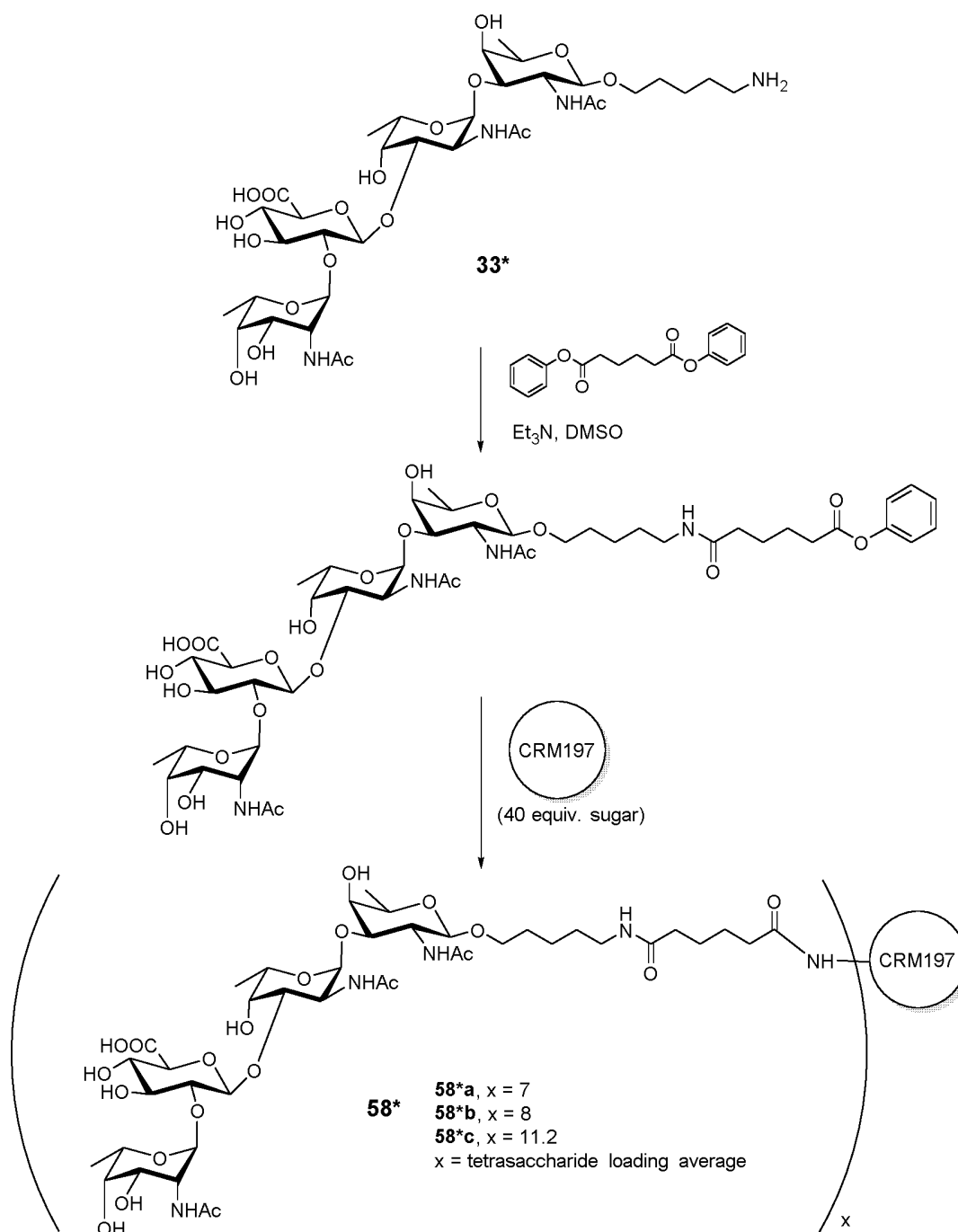

5

Pentasaccharide conjugate **87*** was obtained by conjugation of pentasaccharide **73*** to CRM₁₉₇.

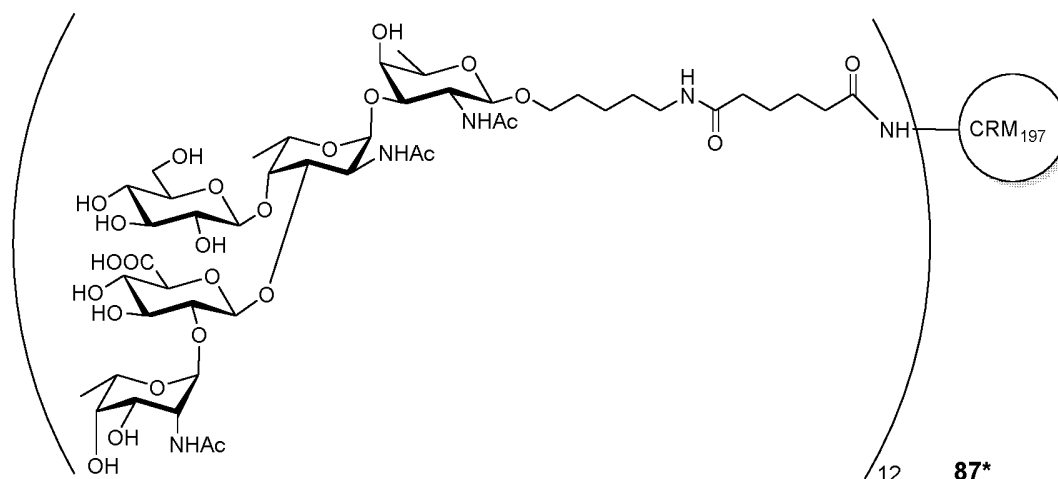

Maldi analysis:

- 1) Conjugate **58*a (conjugate 1 in Figure 6 B)**: pH 8.0, 0.9 mg CRM₁₉₇,
tetrasaccharide loading average = 7
- 2) Conjugate **58*b (conjugate 2 in Figure 6 B)**: pH 8.5, 0.6 mg CRM₁₉₇,
tetrasaccharide loading average = 8
- 3) Conjugate **58*c (conjugate 2 in Figure 7 A)**., tetrasaccharide loading average
= 11.2
- 4) Conjugate **87* (conjugate in Figure 7 B)**: at pH 8.0, pentasaccharide loading
average = 12

Characterization of conjugates

MALDI analysis: The average molecular size of conjugates **58*a** and **58*b** was determined by *Matrix-assisted laser desorption/ionization (MALDI)* analysis using CRM₁₉₇ as standard and calculate the average number of tetrasaccharide attached per CRM₁₉₇ molecule.

SDS-PAGE: The conjugates were resolved by SDS-PAGE (10%) in denaturing condition. The samples were prepared in 6X SDS-PAGE sample loading dye. The electrophoresis was carried out at 120 V and 25 mA for 1 hr 30 min in electrode buffer and gel was stained with Coomassie brilliant blue R250.

Protein estimation

The protein concentration was estimated using Micro BCA Protein Assay Kit (Thermo-scientific, USA) following the manufacturer's instructions. The sample was prepared in PBS and mixed with equal volume of reagent mixture (B:C:A::24:1:25). The plate was incubated at 37°C and the absorbance was measured at 560 nm. The standard curve was plotted with known concentration of BSA provided with the kit.

Mice immunization and generation of polyclonal sera

Ten to twelve week old female ZIKA rabbits (n= 3) were immunized subcutaneously with the conjugates in alum (10 µg conjugate in alum (aluminum hydroxide)) formulation at day 0, 14 and 28. Preimmune and hyperimmune sera were collected at day 0, 14, 21 and 35. Control group received only CRM₁₉₇ in alum formulation. The immune responses were analyzed by glycan microarray and ELISA.

Example 80: Glycan Microarray Preparation and Screening - II

Preparation of microarrays slides: Oligosaccharides, polysaccharides, CRM₁₉₇ and spacer bearing glass slides were prepared, quenched, blocked with 1% BSA-PBS and stored at 4° C until use.

The CodeLink NHS activated glass slides (Surmodics) were spotted with synthetic glycans and native polysaccharides at two different concentrations (100 µM and 200 µM) in printing buffer (50 mM sodium phosphate, pH 8.5) by using a S3 piezoelectric microarray printer (Scienion) equipped with a type 4 coated nozzle. The relative humidity of spotted chamber was constantly maintained at 65%. The spotted slides were incubated over night at room temperature in a humidifying chamber. The unreactive groups on the slides were blocked with 50 mM sodium phosphate, 100 mM ethanolamine pH 9.0 at room temperature for one hour. Slides were subsequently washed three times for 5 min with water, dried by centrifugation at 300 g for 5 min (CombiSlide system, Eppendorf) and stored at 4°C until use.

Microarray binding assays: A FlexWell 64 (Grace Bio-Labs, Bend, OR, USA) grid was applied to microarray slides (The grid was applied on the printed slides as mentioned above). Slides were incubated with polyclonal sera raised in rabbits against SP-5 tetrasaccharide and pentasaccharide conjugates at different dilutions, diluted in 1% BSA-PBS (w/v) in a humid chamber for 1 h at room temperature , washed three times with 0.1% Tween-20 in PBS (v/v) and dried by centrifugation (300 x g, 5 min). Slides were incubated with a fluorescence-labeled secondary antibody, goat anti-mouse IgG 635 nm (red; 1 in 400 dilution), goat anti mouse IgM 594 nm (yellow; 1 in 200 dilution) and goat anti-rabbit FITC488 (1in 200 dilutions) (Life Technologies, USA) diluted in 1% BSA in PBS (w/v) in a humid chamber for 1 h at room temperature, washed three times with 0.1% Tween-20 in PBS (v/v), rinsed once with deionized water and dried by centrifugation (300 x g, 5 min) prior to scanning with a GenePix 4300A microarray scanner (Molecular Devices, Sunnyvale, CA, USA). Image analysis was carried out with the GenePix Pro 7 software

(Molecular Devices). The photomultiplier tube (PMT) voltage was adjusted such that scans were free of saturation signals (**Figure 8**).

Further microarray was prepared to identify the smallest glycan structure of CPS-5 polysaccharide, we incubated the microarray slides with ST5 type sera raised in rabbit (**Figure 8**). The reactivity pattern of type sera against printed glycan's and polysaccharide was analyzed by glycan microarray. The microarray data indicated that the type sera recognized the several synthetic glycans along with CPS-5 polysaccharide (**Figure 8B**). However the type sera also recognized the tetrasaccharide **33*** and pentasaccharide **73*/85*** with high affinity which are considered to be the B cell epitopes that has been presented by the MHCII molecules. Thus, the following results suggest that these oligosaccharides are critical for immunity.

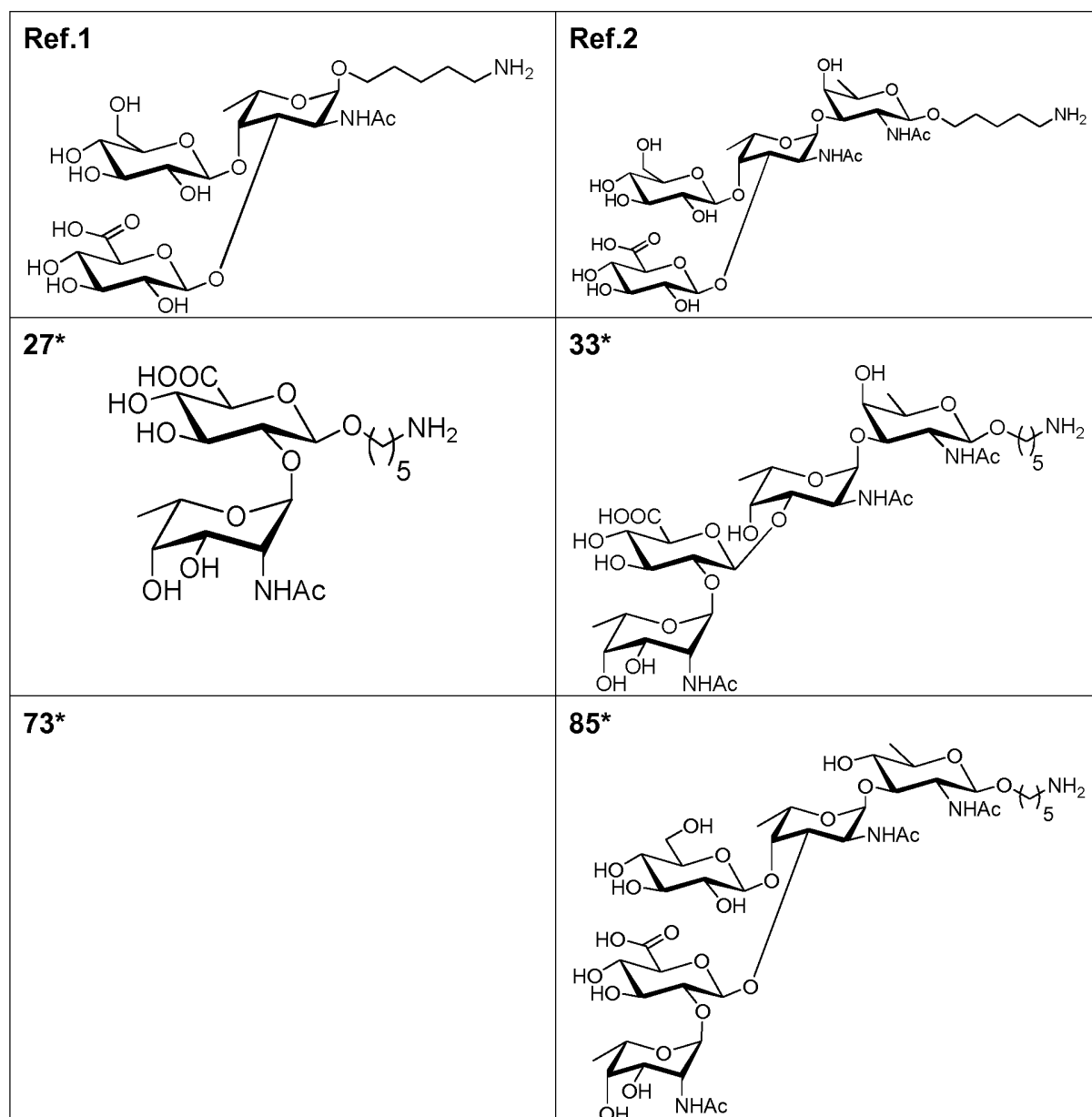

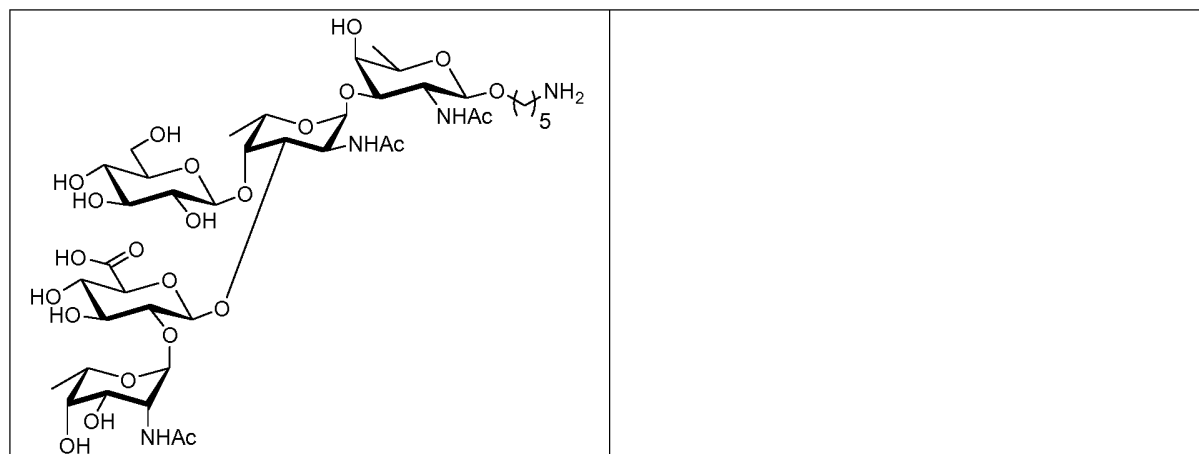

Example 81: Glycan microarray with antibodies raised in rabbit against ST5 synthetic glycan conjugates

To analyze the ST5 synthetic glycans specific immune response, we subjected hyperimmune sera raised in rabbit ($n = 3$) immunized with ST5 tetrasaccharide (**58*c**) and pentasaccharide conjugates (**87***) to microarray slides. The microarray data suggested that the synthetic glycans specific antibodies were cross-reactive with the structures printed on slides and native polysaccharide (**Figure 9B and D**). This result suggested that the tetrasaccharide **33*** and pentasaccharide **73*** are immunogenic in rabbit and induced cross-reactive antibodies.

Example 82: ELISA: The end point titer of rabbit sera were analyzed by ELISA. High binding ninety six well polystyrene microtiter plates (Corning, USA) were coated overnight at 4°C with CSP-5 (50 μ l of 10 μ g/ml per well) in PBS, pH 7.2. The plates were washed thrice with PBS containing 0.1% Tween-20 (PBST) and blocked with 10% FCS in PBS at 37°C for 1 hr. After washing thrice with PBST, the plate was incubated with the individual and pooled rabbit serum ($n = 3$) at different dilutions in duplicate or triplicates at 37°C for 1 hr. The plate was washed 4-5 times with PBST and incubated with HRP conjugated goat anti-rabbit IgG antibodies (diluted 1 in 10,000 in PBS containing serum diluted in 10% FCS followed by incubation at 37°C for 1 hr. The plate was washed thoroughly with PBST and developed using 3, 3', 5, 5'-tetramethylbenzidine (Thermo Fisher Scientific, USA). The reaction was stopped by adding 2% H₂SO₄ and absorbance recorded at 450 nm.

25 Antibody responses analyzed by ELISA

Three groups of rabbit ($n=3$) were immunized with 10 μ g of glycans equivalent conjugate on day 0, 14 and 28 subcutaneously, and the antibody responses were analyzed at different time point. The CSP-5 (Life Technologies, USA) polysaccharide specific endpoint antibody titer of the individual rabbit serum was determined.

Immunization with tetrasaccharide and pentasaccharide conjugates induced high antibody titers (**Figure 10A**). We further quantitated the polysaccharide specific immunoglobulins by endpoint (**Figure 10B**). Endpoint titer was calculated as the reciprocal of the highest serum dilution that gave an absorbance value obtained with the preimmune sera (diluted 1:1000). The antibody response for individual animal of each groups were plotted as fold change at day 35. This analysis suggested that pentasaccharide **73*** or conjugate **87*** is more immunogenic compared to tetrasaccharide **33*** or conjugate **58*c**.

10 **Example 83 Surface binding of anti-ST5 glycan conjugates sera**

The protective immunity against pneumococci is primarily antibody mediated and for an effective vaccine candidate the B cell epitopes should be accessible to the antibody. To investigate the accessibility of B cell epitope, we performed the flow cytometry for surface staining. The UV inactivated pneumococcal cells were incubated with preimmune and hyperimmune sera followed by the FITC-conjugated goat anti-rabbit antibodies. The stained bacteria were analyzed by flow cytometry. The flow cytometry data indicated that the pneumococcal cells incubated with hyperimmune sera exhibited the surface staining (tetrasaccharide; black histogram and pentasaccharide; gray histogram). We did not observe any staining with the preimmune sera (dotted black histogram). This indicated that antibodies against the anti-ST5 glycans localized the epitope on the surface of pneumococci (**Figure 11**) and considered to be a novel synthetic vaccine candidate.

Flow cytometry analysis: *S pneumoniae* serotype 5 cells were stained as previously described with minor modifications (Khan *et al*; 2015, Clin Vaccine Immunol. 22(1):99-107). Briefly, mid-logarithmic phase ($A_{600} = 0.3-0.4$) pneumococcal cells were harvested by centrifuging at 6000 x g. Cells were washed with PBS (pH 7.4) and UV inactivated for 10 min. The cell inactivation was confirmed by plating on blood agar plats. The cells were blocked with 2% BSA prepared in PBS at room temperature for 30 min followed by incubation with preimmunre and hyperimmune pooled sera (n =3) (diluted 1:100) at room temperature for 1 hr. FITC-conjugated goat anti-rabbit IgG (Life Technologies, USA) diluted 1:200 dilution in 0.5% BSA-PBS) was used as the secondary antibody. The stained cells were analyzed by flow cytometry (BD Bioscience).

Example 84: In vitro opsonophagocytic killing assay: opsonophagocytic killing assay was performed as described previously (Romero-Steiner et al., CLINICAL AND DIAGNOSTIC LABORATORY IMMUNOLOGY 1997, 415-422). Briefly, $\sim 4 \times 10^5$ cell/ml HL-60 cells were differentiated into HL-60 cells were differentiated into

phagocytic cells by using 0.8% Dimethylformamide (DMF) for 5-6 days before performing the assay. After differentiation the cells were harvested and counted by using a haemocytometer and resuspended in opsonophagocytic buffer (HBSS with Ca^{++} and Mg^{++} and 0.1% gelatin) at a density of 1×10^7 cells/ml. Serotype 5 strain (1000 cfu) in 20 μl of opsonophagocytic buffer were incubated with 10 μl of pooled (n=3) anti-SP-5 tetrasaccharide conjugate (**58*c**) polyclonal sera (day 35). Preimmune sera (day 0), anti-CRM₁₉₇ and anti-Prevnar 13[®] sera were used as positive and negative controls and bacteria were preopsonized for 15 min at 37°C. After preopsonization 8 μl of baby rabbit complement and 40 μl differentiated HL-60 cells (1:400 ratio) were added with antibody treated pneumococci for 45 min at 37°C and 5% CO₂ with intermittent shaking. The viable extracellular pneumococci were determined by plating serial dilutions on TSA plates in triplicates. The mean of 3 independent experiments was plotted as percent killing relative to the 'no sera' control.

15

Anti-ST5 (tetrasaccharide) antibodies augment uptake of pneumococci by HL-60 cells

Anti-ST5 (tetrasaccharide) may facilitate clearance of pneumococci by phagocytosis. We performed opsonophagocytic killing assay to assess the functional relevance of the antibodies induced in response to immunization with ST5 (tetrasaccharide) conjugate **58*c**. Differentiated HL-60 cells were incubated with serotype 5 bacteria pre-opsonized with either anti-ST5 (tetrasaccharide) or preimmune sera. The killing of pneumococci was assessed by plating method as described in the Material and Methods. The relative percent killing value obtained for polyclonal antibody against ST5 (tetrasaccharide) was greater than 50% compared to the preimmune sera (**Figure 12**). We observed some basal level of killing (~25%) with the preimmune sera. The anti-prevnar 13[®] rabbit sera were used as a positive control. The OPKA data demonstrates that ST5 (tetrasaccharide) conjugate (**58*c**) generate neutralizing antibodies and promote the killing of pneumococci by differentiated HL-60 cells.

30

Claims

5 1. A saccharide of general formula (I)

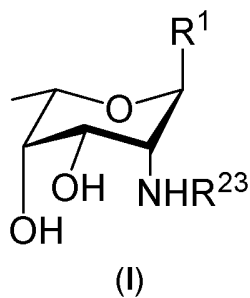

wherein

R¹ is selected from -R², -R⁴,

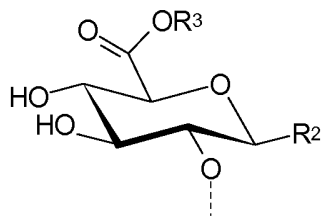

and

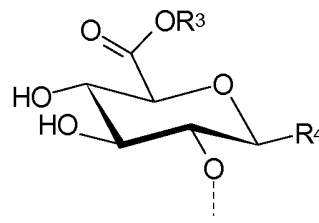

10

R² represents

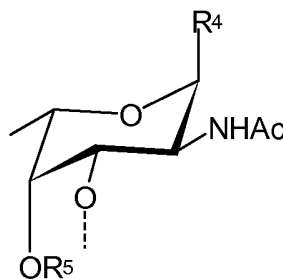

R³ is selected from -H, -CH₃, -C₂H₅, -C₃H₇, -C₄H₉ and -CF₃;

R⁴ represents R⁶ or

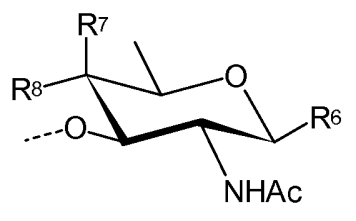

R⁵ represents -H or

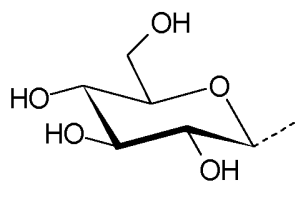

15

R^6 represents $-O-L-NH_2$;

R^7 and R^8 are independently of each other selected from $-H$ and $-OH$ and cannot be simultaneously $-H$;

5

R^7 and R^8 can form together with the carbon atom to which they are attached to a carbonyl group $C=O$;

10

R^{23} is selected from $-H$, $-C(O)CH_3$, $-C(O)CF_3$ and $-C(O)CCl_3$;

$-L-$ is a linker;

and pharmaceutically acceptable salts thereof.

15 2. The saccharide according to claim 1, wherein R^1 represents

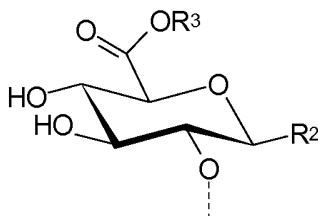

and R^2 and R^3 have the meanings as defined in claim 1.

3. The saccharide according to claim 1 or 2, wherein R^4 represents R^6 .

20

4. The saccharide according to claim 1 or 2 of general formula (III)

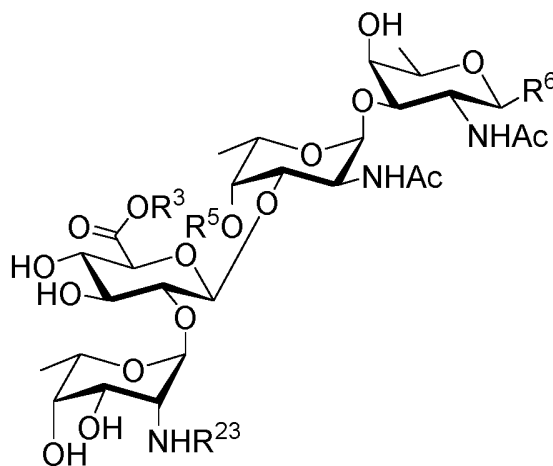

(III)

25 wherein R^3 , R^5 , R^6 and R^{23} have the meanings as defined in claim 1.

5. The saccharide according to claim 1 or 2 of the formula 72

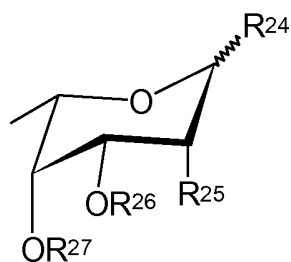

(IX)

wherein

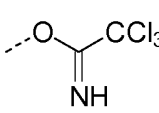
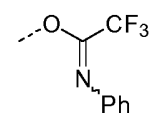
R²⁴ is selected from , , -F, -Cl, -Br,
5 -I, -SR²⁸, -SeR²⁹, -OPO₃R³⁰₂;

R²⁵ is selected from -N₃, -NBn₂, -NBnCbz;

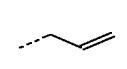
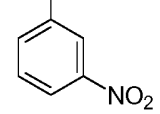
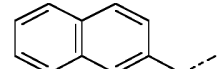
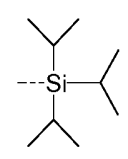
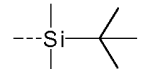

R²⁶ and R²⁷ are independently of each other selected from -H, -Bn,

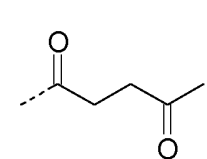
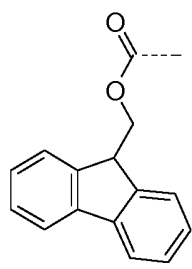
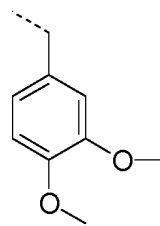
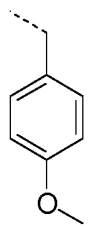
, , , , ,
10 -Si(CH₃)₃, -Si(CH₂CH₃)₃, -C(O)CH₃, -C(O)Ph,

, , ,  ;

or R²⁶ and R²⁷ can form together  ;

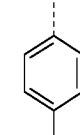
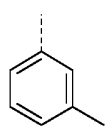
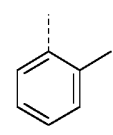
R²⁸ is selected from: -CH₃, -CH₂CH₃, -Ph,

, , ,  ;

R²⁹ represents -Ph;

R³⁰ represents -CH₂CH₂CH₂CH₃;

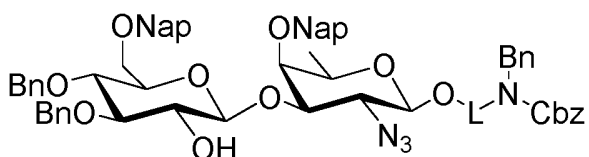

36

;

wherein L has the meanings as defined in Claim 1;

5

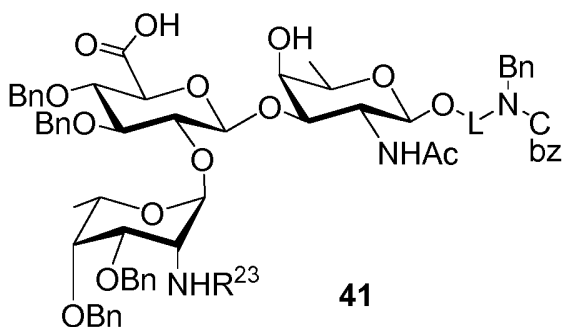

41

wherein L and R²³ have the meanings as defined in Claim 1;

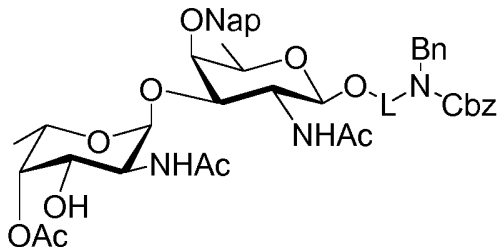

63

10

wherein L has the meanings as defined in Claim 1;

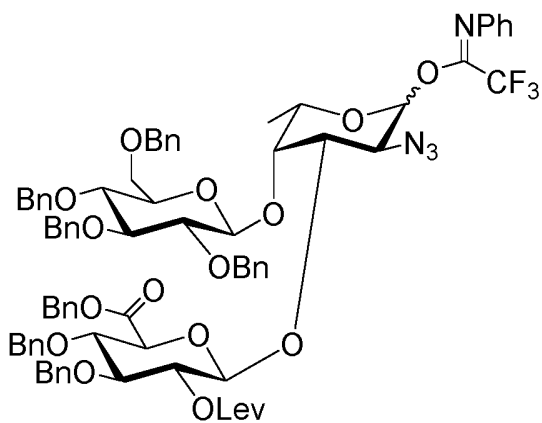

68*

;

15

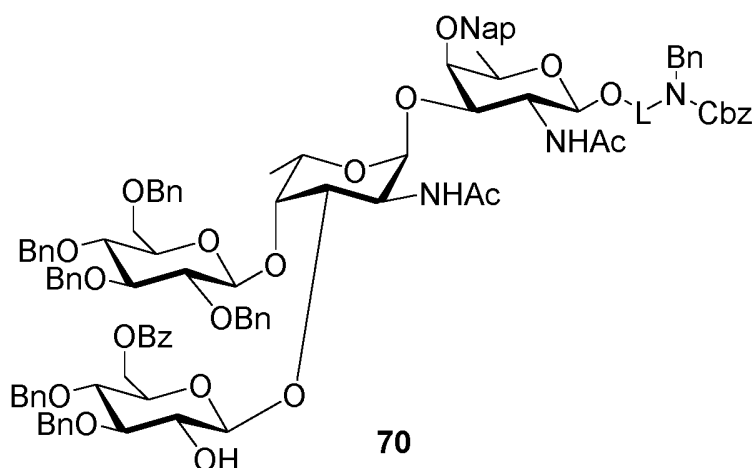

wherein L has the meanings as defined in Claim 1;

5 or

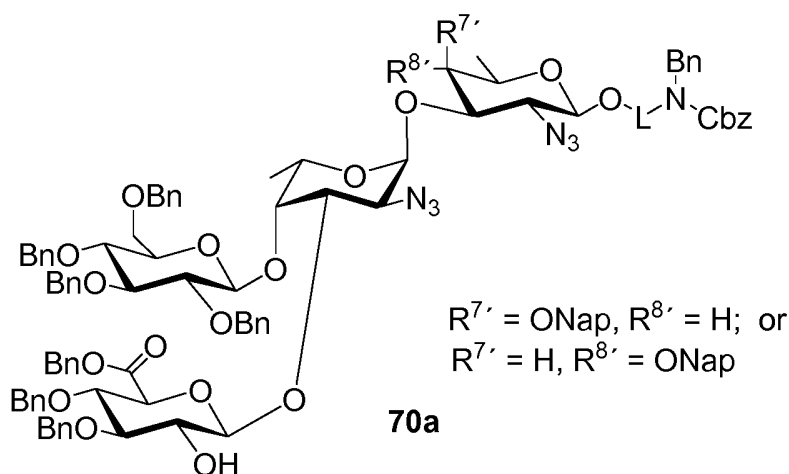

wherein L has the meanings as defined in Claim 1.

10 9. The intermediate according to Claim 8 is selected from the group consisting of the saccharides **36**, **41**, **63**, **70**, **70a**, wherein L is $-\text{C}_5\text{H}_{10}-$ and/or R^{23} is $\text{CH}_3\text{CO}-$.

15 10. A conjugate comprising the saccharide according to any of claims 1 – 7.

11. The conjugate according to claim 10 selected from the group consisting of the conjugates of the formulae **(X)**, **(XI)** and **(XII)**:

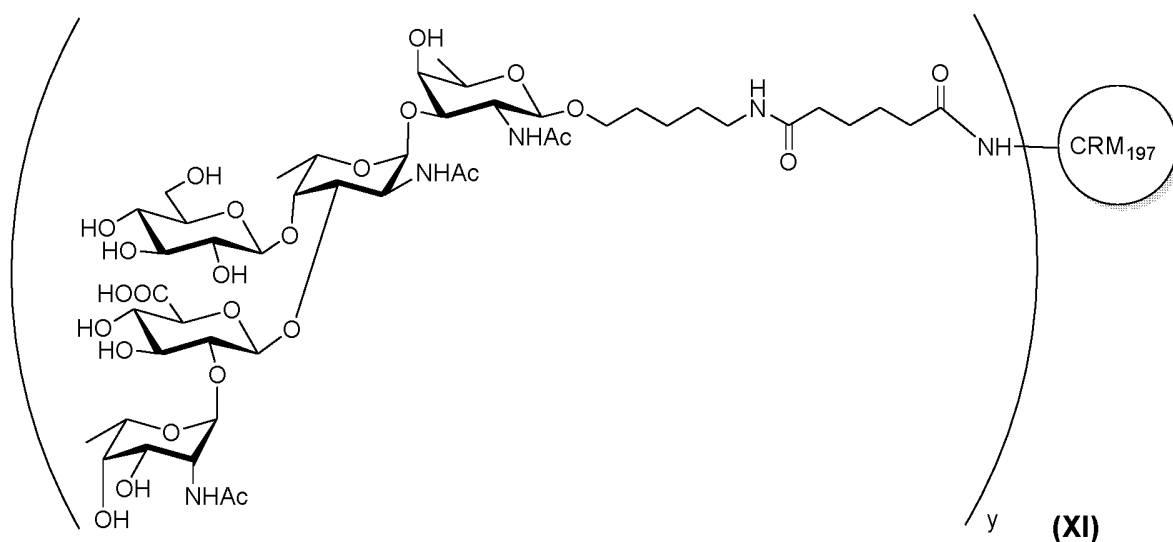
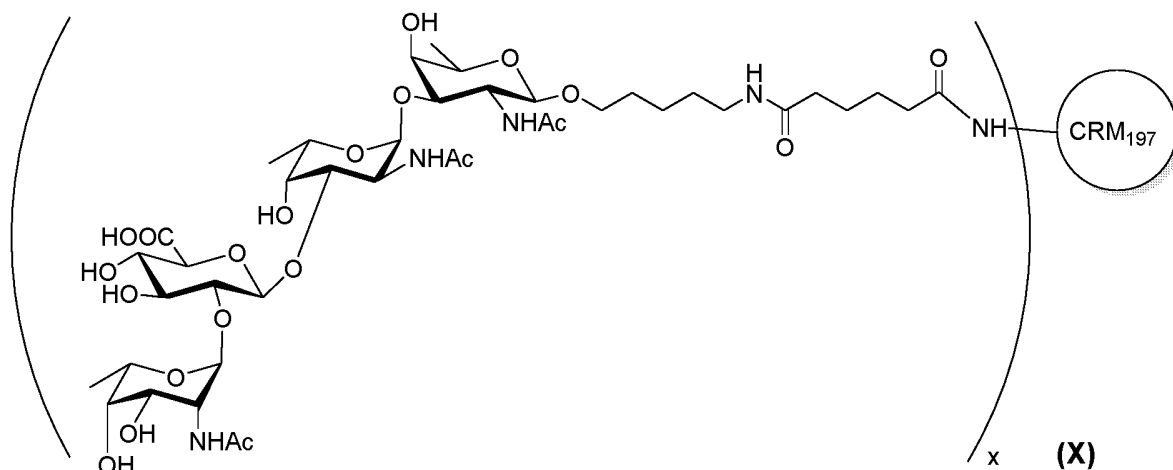

5 and

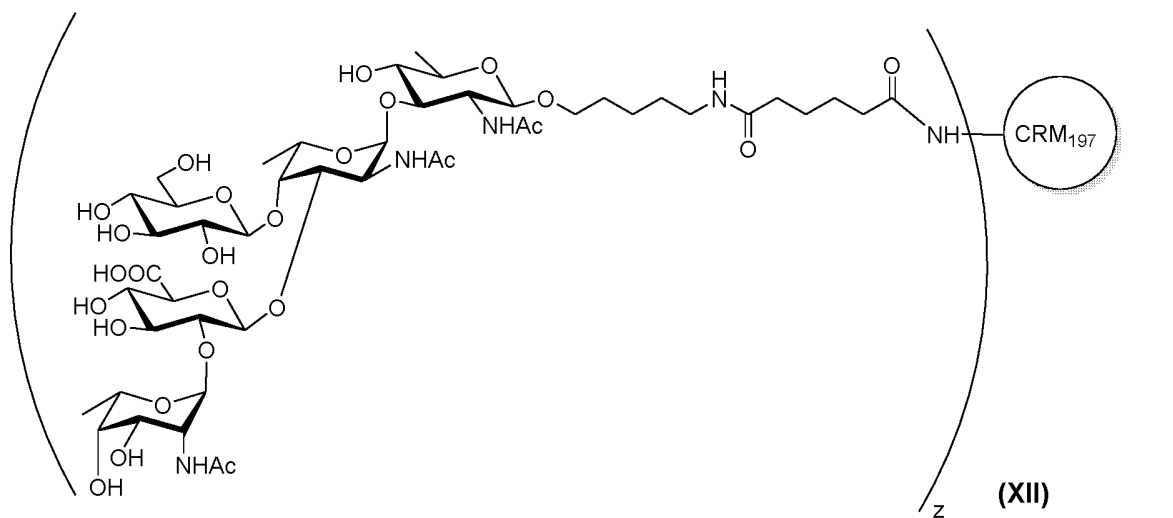

wherein x, y and z are independently integer from 1 to 20.

12. The conjugate according to Claim 10 or 11 selected from the group consisting of **58*a**, **58*b**, **58*c** and **87***:

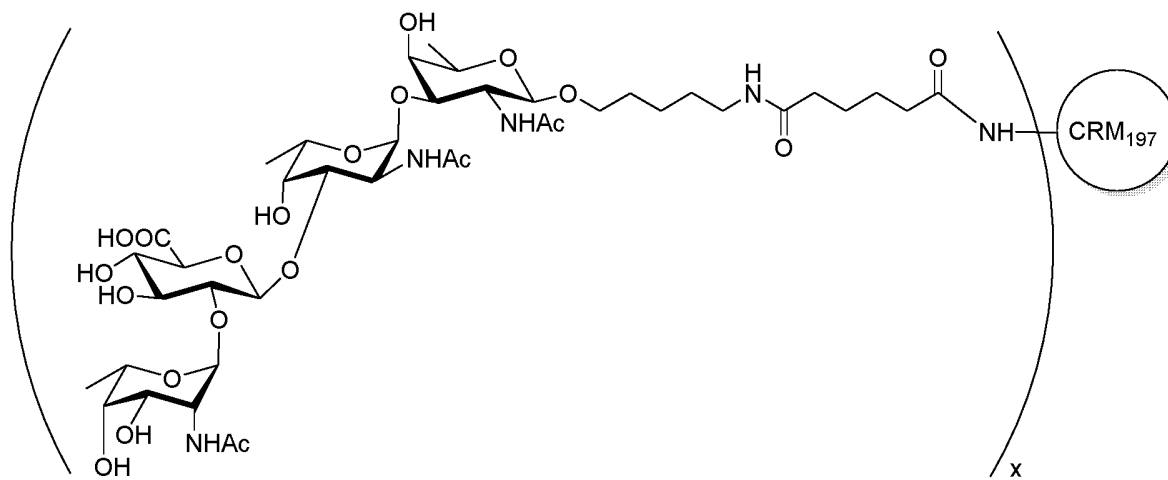

58*a, x = 7
58*b, x = 8
58*c, x = 11.2

5

and

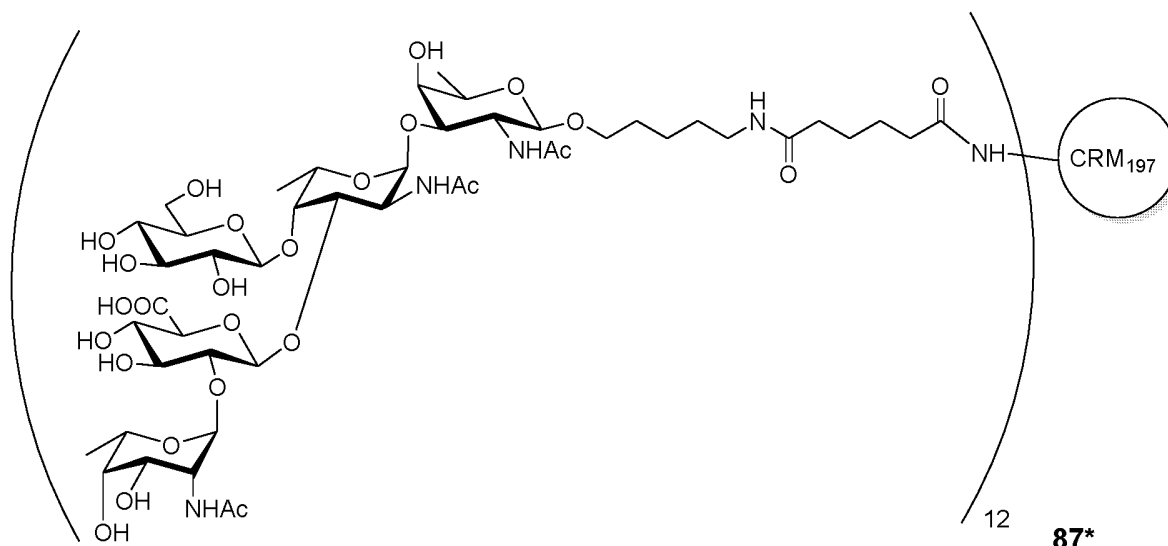

87*

10

13. The conjugate according to any of claims 10 to 12 for use in raising a protective immune response in a human and/or animal host.
14. The conjugate according to any of claims 10 to 13 for use in prevention and/or treatment of diseases associated with bacteria containing *N*-acetyl-L-pneumosamine in their capsular polysaccharide.

15

15. The conjugate according to claim 14, wherein the bacteria is *Streptococcus pneumoniae* serotype 5.
- 5 16. The conjugate according to claim 14 or 15, wherein the diseases associated with bacteria include pneumonia, meningitis, otitis media, bacteremia and acute exacerbation of chronic bronchitis, sinusitis, arthritis and conjunctivitis.
- 10 17. A pharmaceutical composition comprising the conjugate according to any of claims 10 to 12 and/or the saccharide according to any of claims 1 – 7 together with at least one pharmaceutically acceptable cryoprotectant, lyoprotectant, excipient and/or diluent.
- 15 18. The pharmaceutical composition according to claim 17 further comprising at least one of antigens of other *Streptococcus pneumoniae* serotypes.
19. The pharmaceutical composition according to claim 17 or 18 for use in raising a protective immune response in a human and/or animal host.
- 20 20. A saccharide according to any of the claims 1 – 7 for use as marker in immunological assays for detection of antibodies against bacteria containing *N*-acetyl-L-pneumosamine in their capsular polysaccharide.

Figures

Figure 1

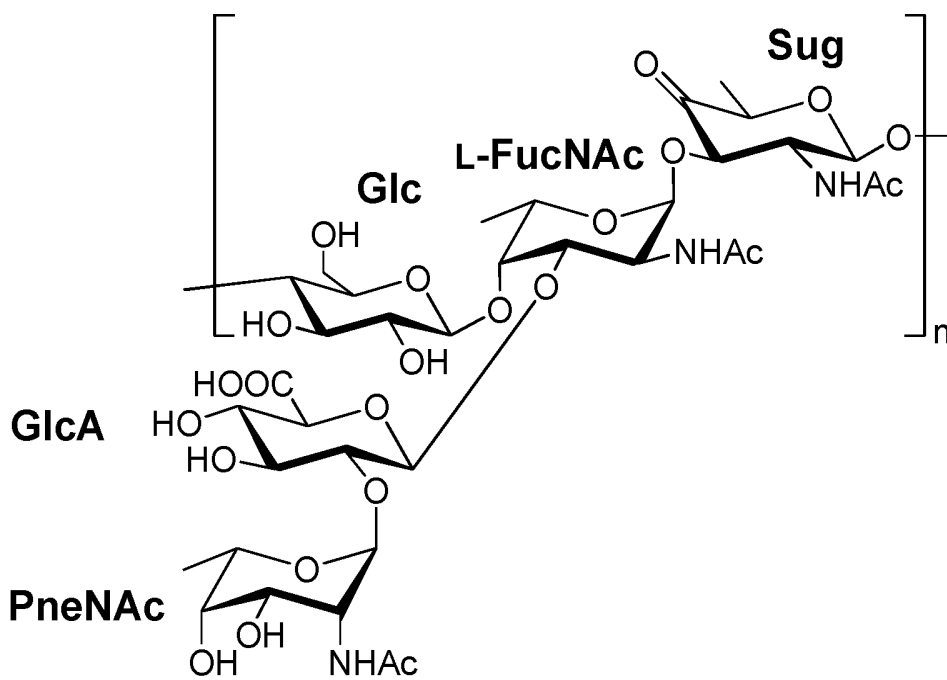

Figure 3

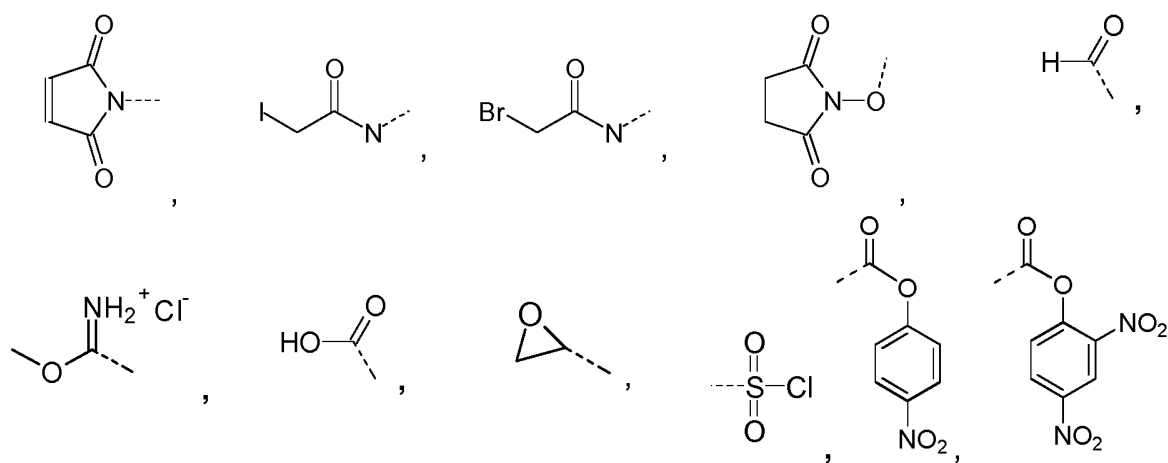

Figure 2

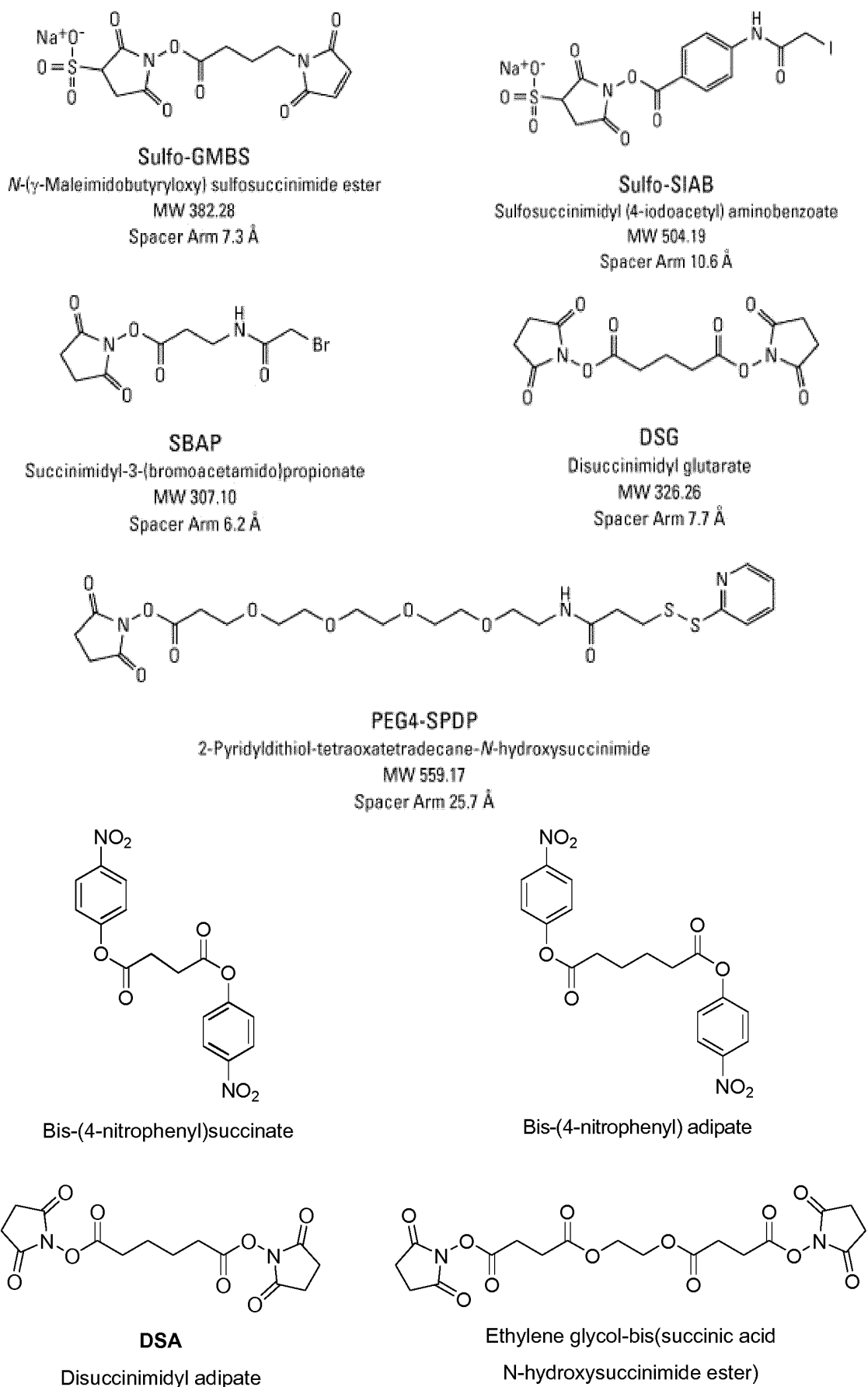
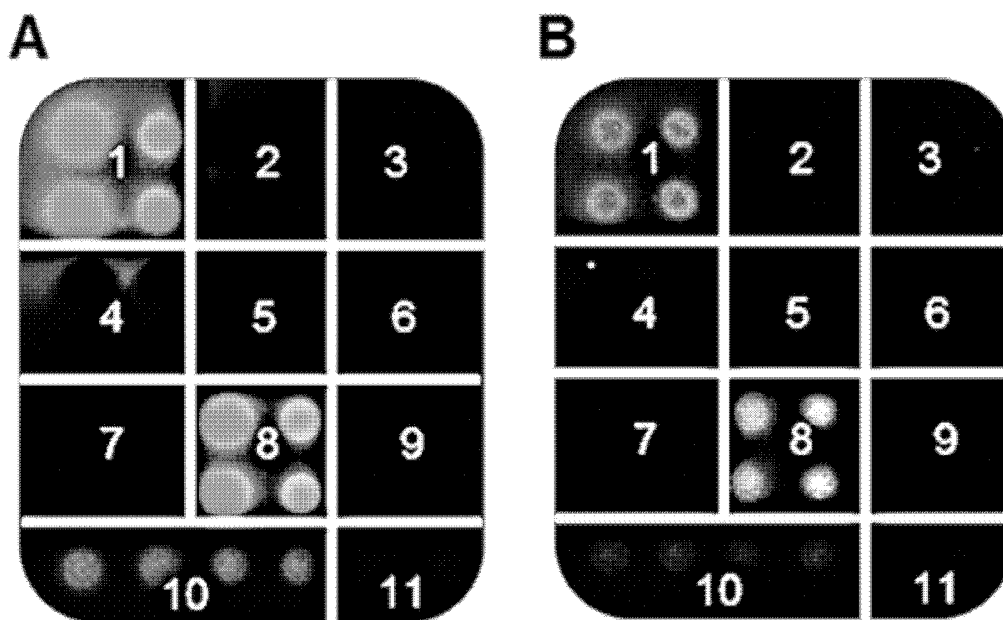

Figure 4



C

Position	Saccharide	Position	Saccharide
1	33*	7	44*
2	14*	8	27*
3	15*	9	52*
4	20*	10	36*
5	21*	11	37*
6	51*		

Figure 5

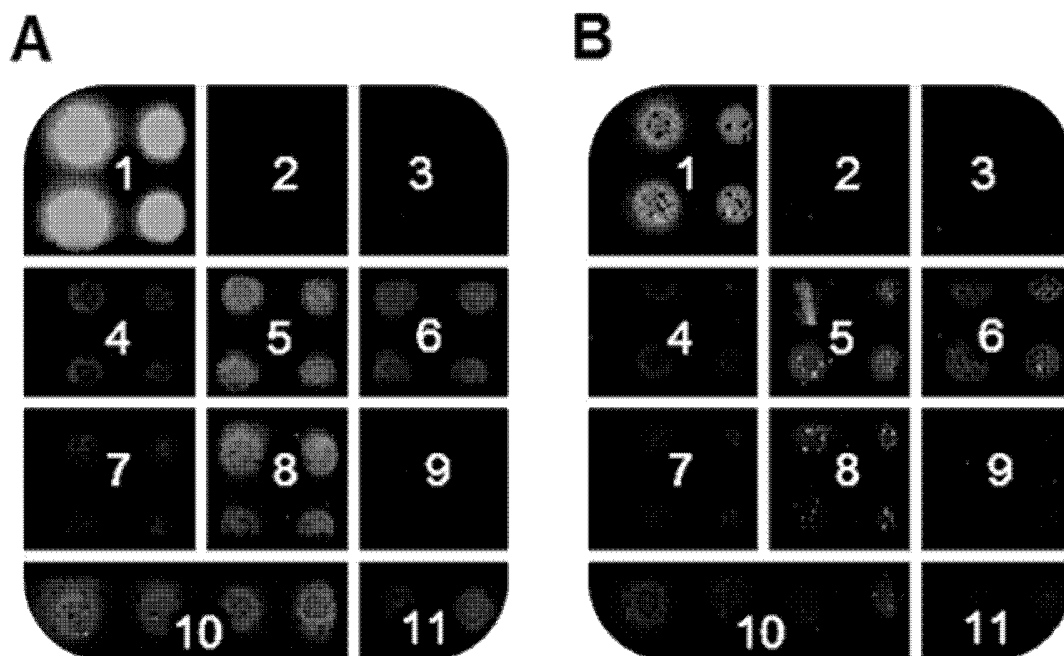

C

Position	Saccharide	Position	Saccharide
1	33*	7	44*
2	14*	8	27*
3	15*	9	52*
4	20*	10	36*
5	21*	11	37*
6	51*		

Figure 6

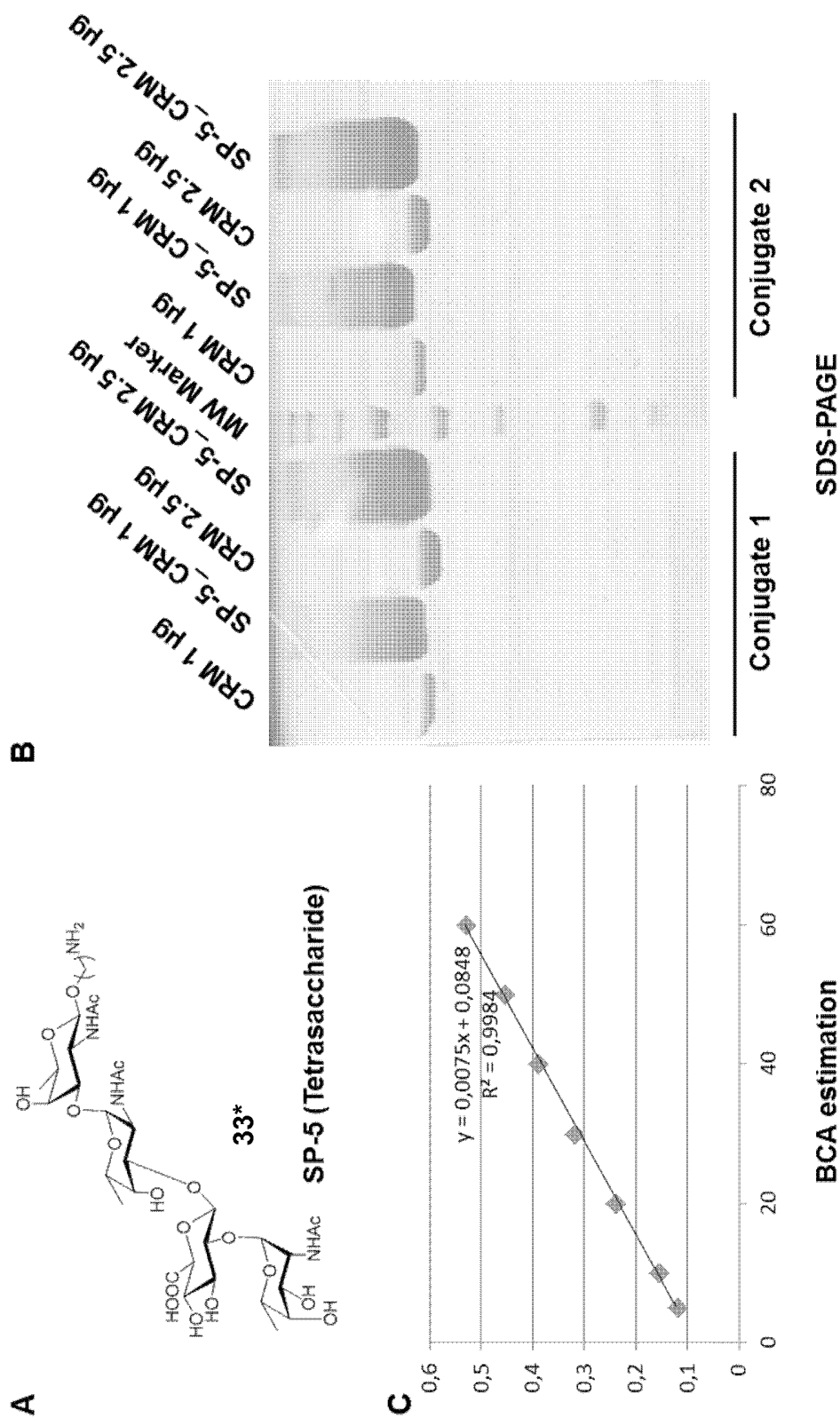

Figure 7

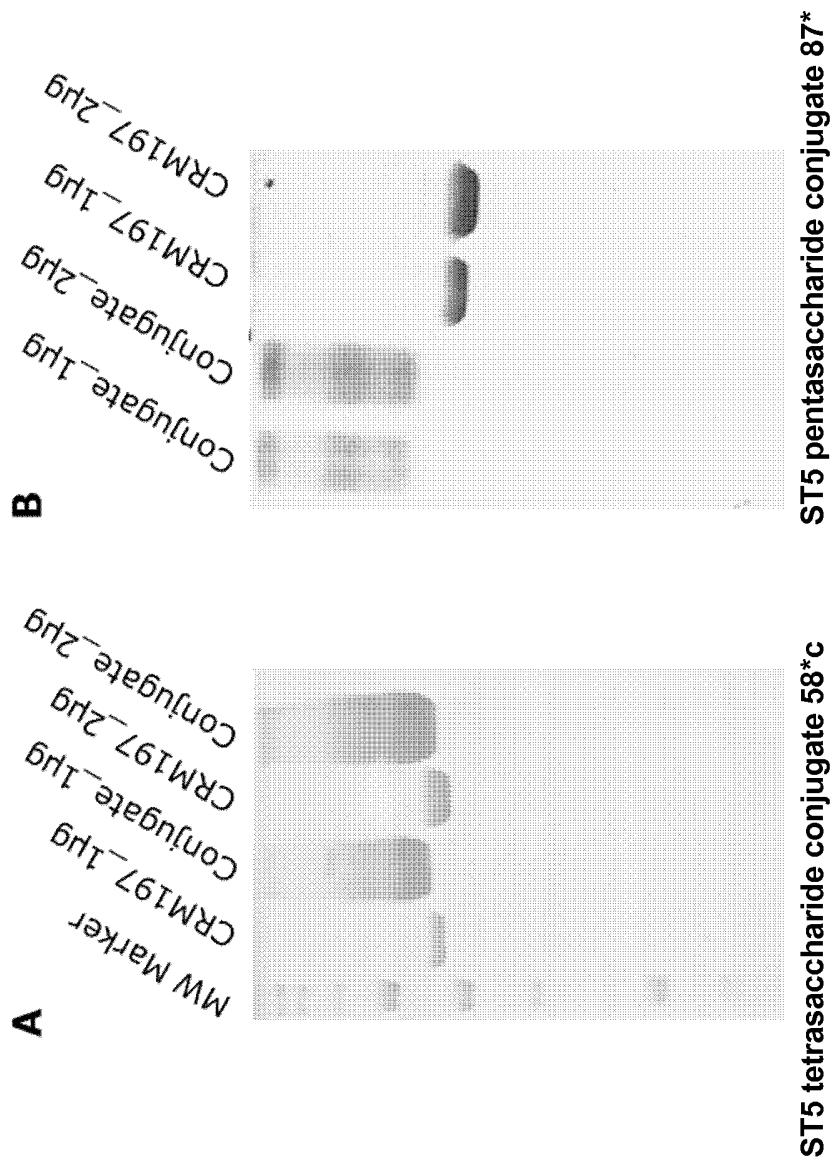

Figure 7 continued

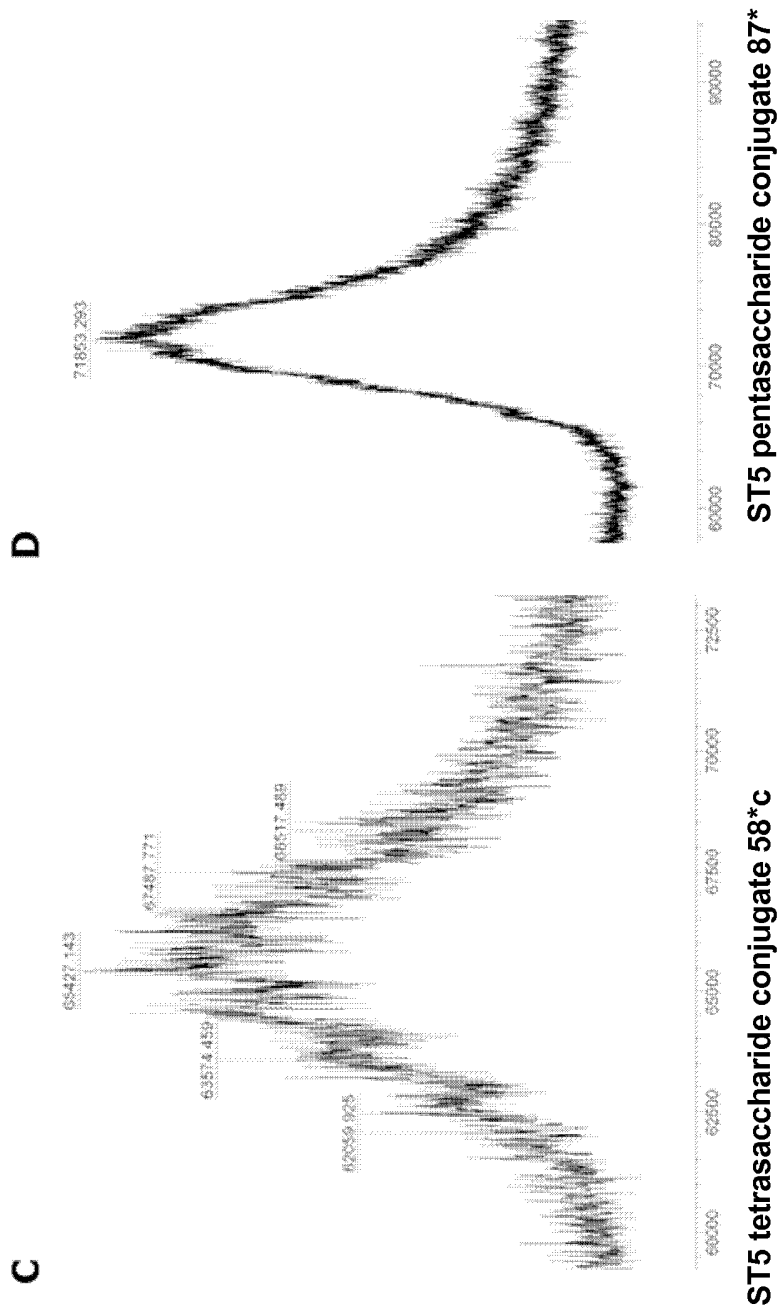

Figure 8

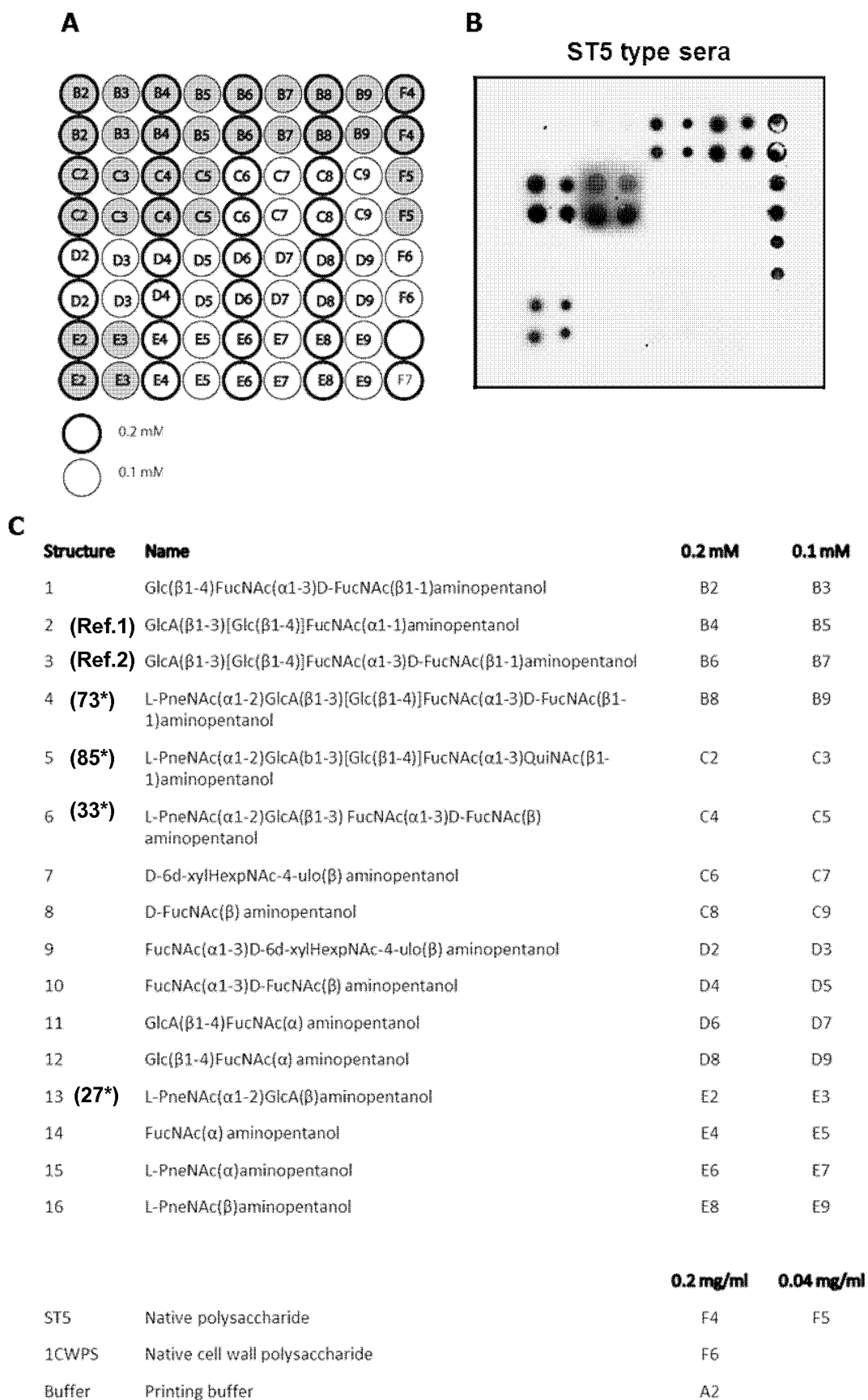

Figure 9

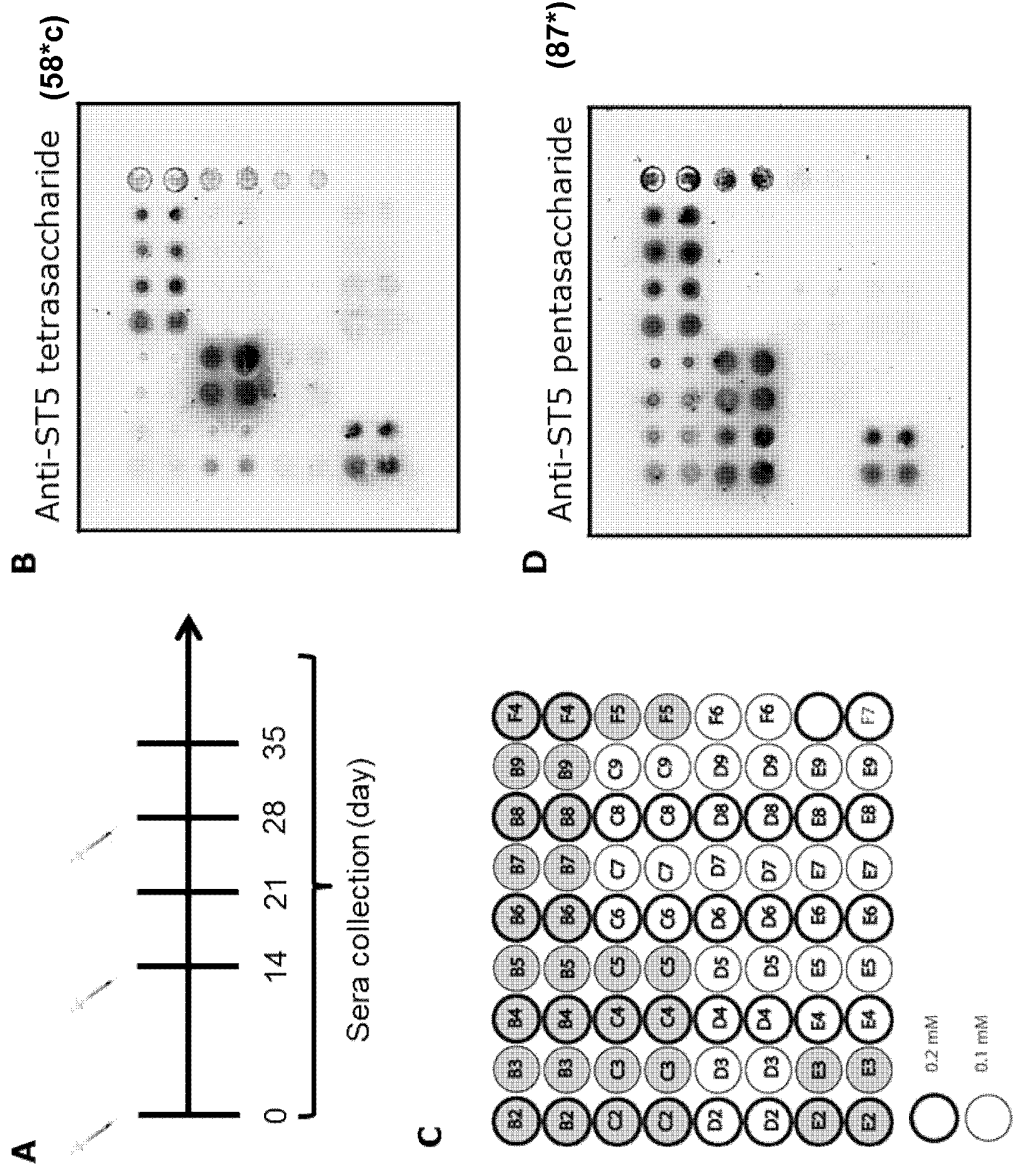

Figure 10

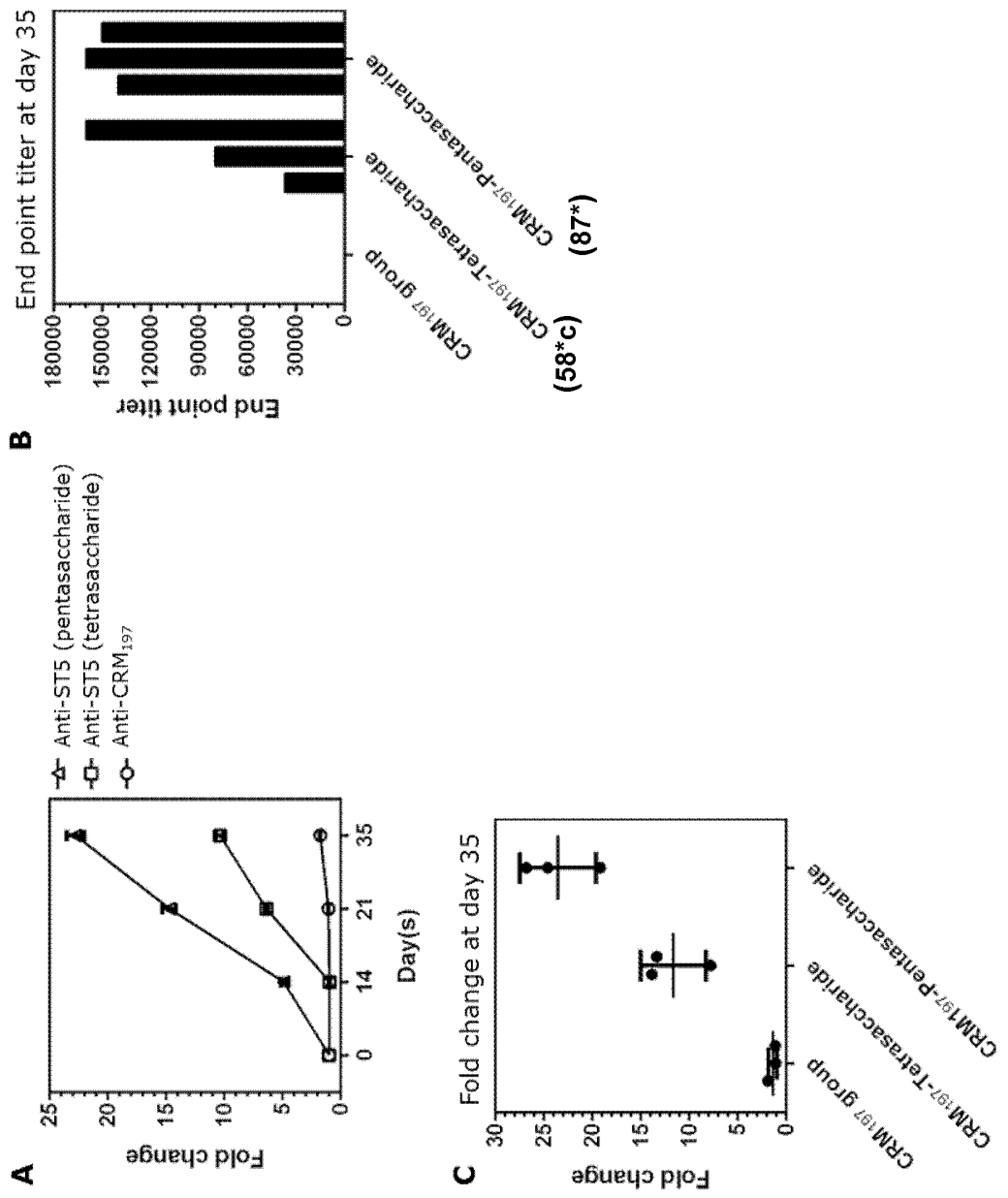

Figure 11

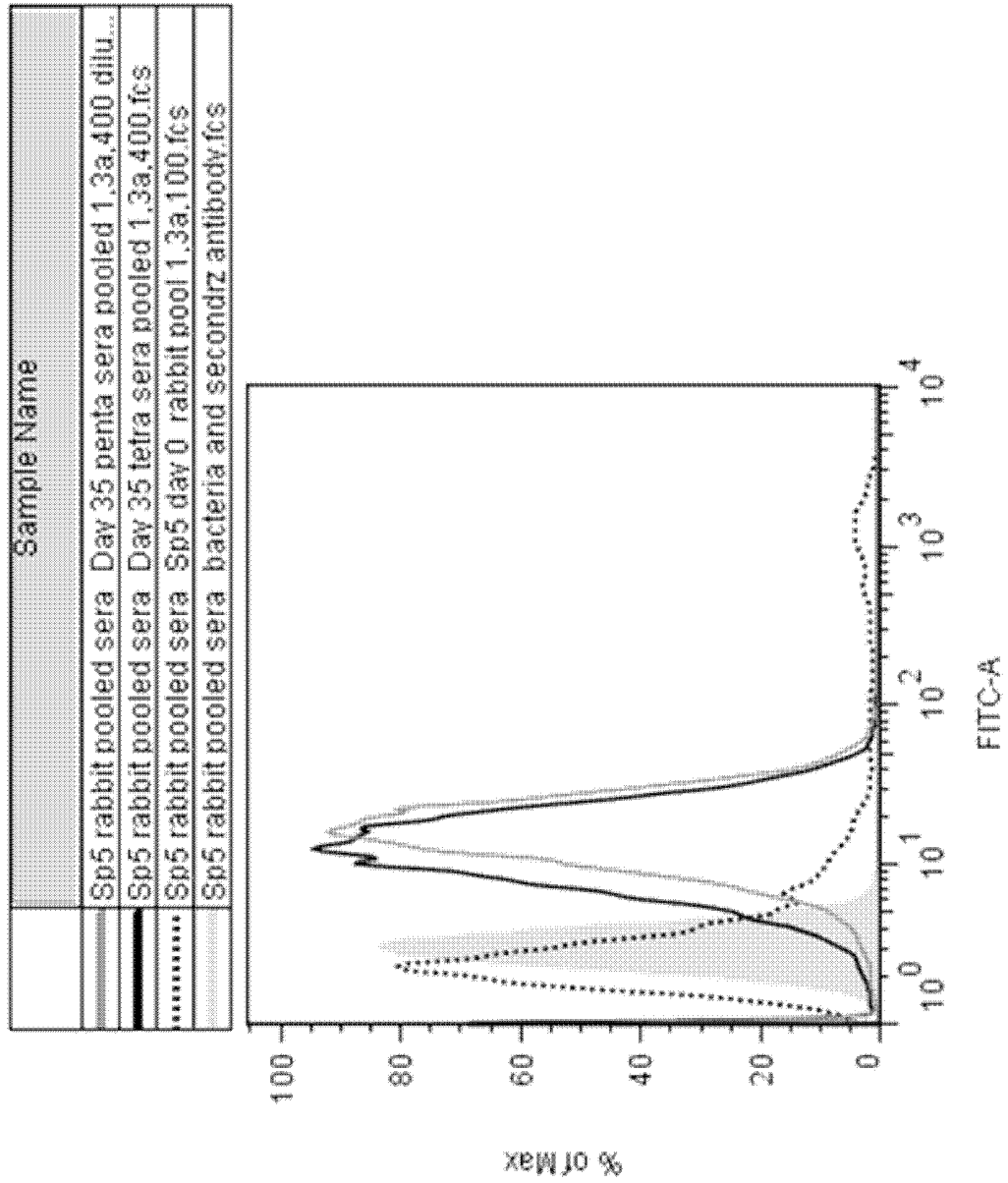
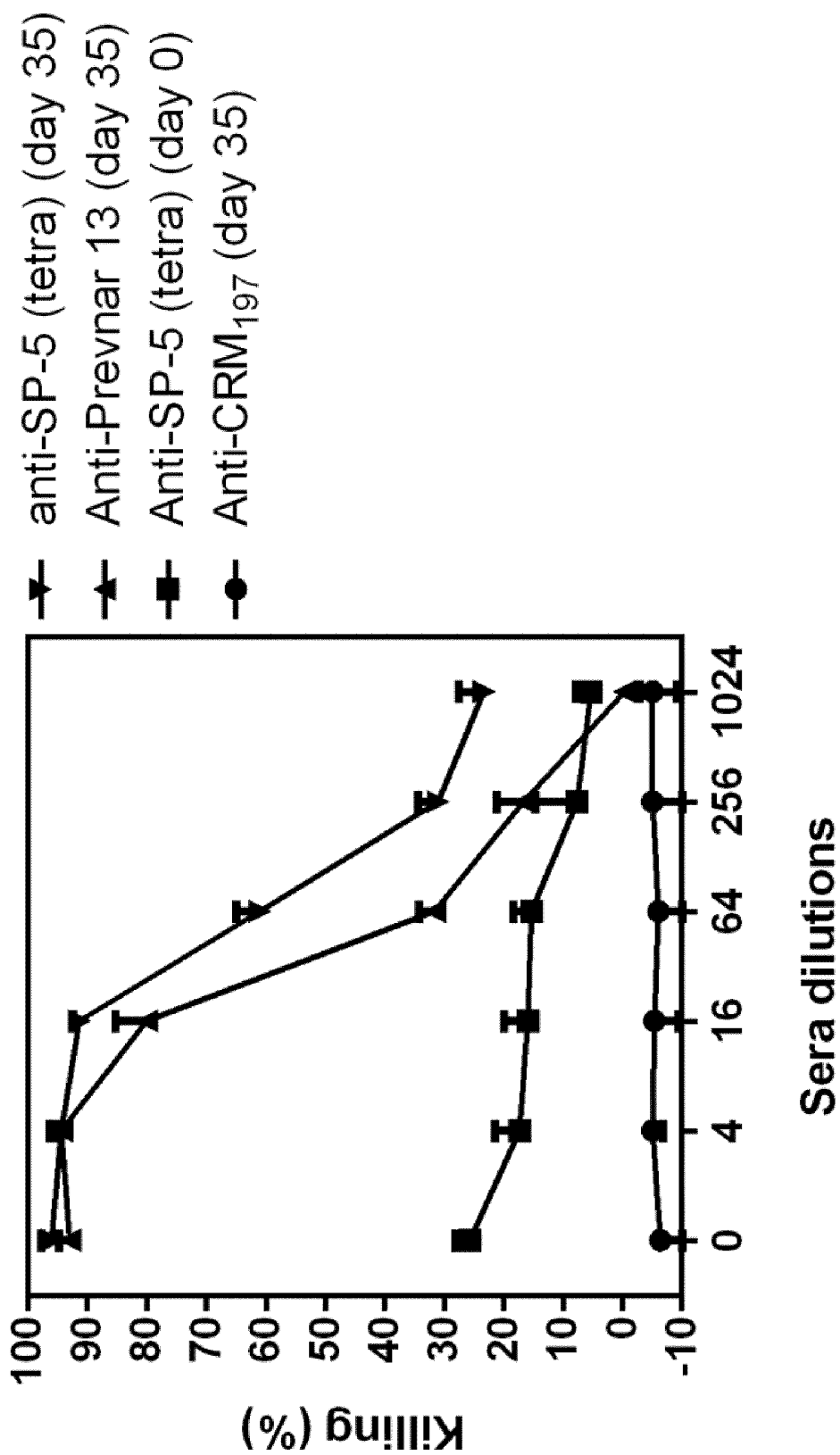

Figure 12



INTERNATIONAL SEARCH REPORT

International application No PCT/EP2016/051608

A. CLASSIFICATION OF SUBJECT MATTER INV. C07H15/04 A61K39/09 A61K31/7028 A61P31/04 ADD.				
According to International Patent Classification (IPC) or to both national classification and IPC				
B. FIELDS SEARCHED				
Minimum documentation searched (classification system followed by classification symbols) C07H A61K				
Documentation searched other than minimum documentation to the extent that such documents are included in the fields searched				
Electronic data base consulted during the international search (name of data base and, where practicable, search terms used) EPO-Internal, WPI Data, CHEM ABS Data				
C. DOCUMENTS CONSIDERED TO BE RELEVANT				
Category*	Citation of document, with indication, where appropriate, of the relevant passages	Relevant to claim No.		
Y	FR 2 850 106 A1 (AVENTIS PASTEUR [FR]) 23 July 2004 (2004-07-23) cited in the application abstract; claims pages 10-11 pages 17-19	1-20		
Y	WO 2009/000826 A1 (GLAXOSMITHKLINE BIOLOG SA [BE]; BIEMANS RALPH LEON [BE]; HERMAND PHILI) 31 December 2008 (2008-12-31) abstract; claims pages 17-18 claim 59	1-20		

-/--				
<table style="width: 100%; border: none;"> <tr> <td style="width: 50%; border: none;"><input checked="" type="checkbox"/> Further documents are listed in the continuation of Box C.</td> <td style="width: 50%; border: none;"><input checked="" type="checkbox"/> See patent family annex.</td> </tr> </table>			<input checked="" type="checkbox"/> Further documents are listed in the continuation of Box C.	<input checked="" type="checkbox"/> See patent family annex.
<input checked="" type="checkbox"/> Further documents are listed in the continuation of Box C.	<input checked="" type="checkbox"/> See patent family annex.			
* Special categories of cited documents :				
"A" document defining the general state of the art which is not considered to be of particular relevance "E" earlier application or patent but published on or after the international filing date "L" document which may throw doubts on priority claim(s) or which is cited to establish the publication date of another citation or other special reason (as specified) "O" document referring to an oral disclosure, use, exhibition or other means "P" document published prior to the international filing date but later than the priority date claimed	"T" later document published after the international filing date or priority date and not in conflict with the application but cited to understand the principle or theory underlying the invention "X" document of particular relevance; the claimed invention cannot be considered novel or cannot be considered to involve an inventive step when the document is taken alone "Y" document of particular relevance; the claimed invention cannot be considered to involve an inventive step when the document is combined with one or more other such documents, such combination being obvious to a person skilled in the art "&" document member of the same patent family			
Date of the actual completion of the international search	Date of mailing of the international search report			
29 April 2016	10/05/2016			
Name and mailing address of the ISA/ European Patent Office, P.B. 5818 Patentlaan 2 NL - 2280 HV Rijswijk Tel. (+31-70) 340-2040, Fax: (+31-70) 340-3016	Authorized officer Gohlke, Pascale			

INTERNATIONAL SEARCH REPORT

International application No

PCT/EP2016/051608

C(Continuation). DOCUMENTS CONSIDERED TO BE RELEVANT		
Category*	Citation of document, with indication, where appropriate, of the relevant passages	Relevant to claim No.
Y	ALONSODEVELASCO E ET AL: "STREPTOCOCCUS PNEUMONIAE: VIRULENCE FACTORS, PATHOGENESIS, AND VACCINES", MICROBIOLOGICAL REVIEWS, AMERICAN SOCIETY FOR MICROBIOLOGY, WASHINGTON, DC, US, vol. 59, no. 4, 1 December 1995 (1995-12-01), pages 591-603, XP000946788, ISSN: 0146-0749 pages 598-600	1-20
A	----- KIM J S ET AL: "Determination of saccharide content in pneumococcal polysaccharides and conjugate vaccines by GC-MSD", ANALYTICAL BIOCHEMISTRY, ACADEMIC PRESS INC, NEW YORK, vol. 347, no. 2, 15 December 2005 (2005-12-15), pages 262-274, XP027200111, ISSN: 0003-2697 [retrieved on 2005-11-24] pages 265-266; figure 1	1-20
A	----- PIERETTI G ET AL: "The complete structure of the core of the LPS from Plesiomonas shigelloides 302-73 and the identification of its O-antigen biological repeating unit", CARBOHYDRATE RESEARCH, PERGAMON, GB, vol. 345, no. 17, 22 November 2010 (2010-11-22), pages 2523-2528, XP027445301, ISSN: 0008-6215, DOI: 10.1016/J.CARRES.2010.09.007 [retrieved on 2010-10-25] page 2526, left-hand column; compound OS1	1-20
A	----- MARIA&EMSP14;M. CORSARO ET AL: "Highly Phosphorylated Core Oligosaccharide Structures from Cold-Adapted Psychromonas arctica", CHEMISTRY - A EUROPEAN JOURNAL., vol. 14, no. 30, 20 October 2008 (2008-10-20), pages 9368-9376, XP055268242, WEINHEIM, DE ISSN: 0947-6539, DOI: 10.1002/chem.200800117 Scheme 4; page 335; compounds D-9	1-20

INTERNATIONAL SEARCH REPORT

Information on patent family members

International application No

PCT/EP2016/051608

Patent document cited in search report	Publication date	Patent family member(s)	Publication date		
FR 2850106	A1	23-07-2004	AT 520718 T 15-09-2011		
			AU 2004207647 A1 12-08-2004		
			BR PI0406819 A 27-12-2005		
			CA 2512847 A1 12-08-2004		
			DK 1590373 T3 05-12-2011		
			EP 1590373 A1 02-11-2005		
			FR 2850106 A1 23-07-2004		
			KR 20050093838 A 23-09-2005		
			MX PA05007533 A 05-12-2005		
			NZ 541254 A 31-07-2008		
			WO 2004067574 A1 12-08-2004		

			WO 2009000826	A1	31-12-2008
AU 2008267210 A1 31-12-2008					
BR PI0813307 A2 23-12-2014					
BR PI0813644 A2 23-12-2014					
CA 2690707 A1 31-12-2008					
CA 2690708 A1 31-12-2008					
CA 2690710 A1 31-12-2008					
CN 101784282 A 21-07-2010					
CN 101883583 A 10-11-2010					
CN 104873965 A 02-09-2015					
DK 2167121 T3 23-11-2015					
EA 200901576 A1 30-06-2010					
EA 200901578 A1 30-08-2010					
EA 201391788 A1 29-08-2014					
EP 2167120 A2 31-03-2010					
EP 2167121 A1 31-03-2010					
EP 2170379 A2 07-04-2010					
EP 2687228 A2 22-01-2014					
ES 2552366 T3 27-11-2015					
HR P20151122 T1 20-11-2015					
JP 5476295 B2 23-04-2014					
JP 5489993 B2 14-05-2014					
JP 5848790 B2 27-01-2016					
JP 2010531329 A 24-09-2010					
JP 2010531330 A 24-09-2010					
JP 2010531331 A 24-09-2010					
JP 2014139192 A 31-07-2014					
KR 20100045445 A 03-05-2010					
KR 20100045446 A 03-05-2010					
PT 2167121 E 02-12-2015					
SI 2167121 T1 31-12-2015					
US 2010183662 A1 22-07-2010					
US 2010209450 A1 19-08-2010					
US 2010239604 A1 23-09-2010					
WO 2009000824 A2 31-12-2008					
WO 2009000825 A2 31-12-2008					
WO 2009000826 A1 31-12-2008					
