

TECHNICAL REPORTS

27

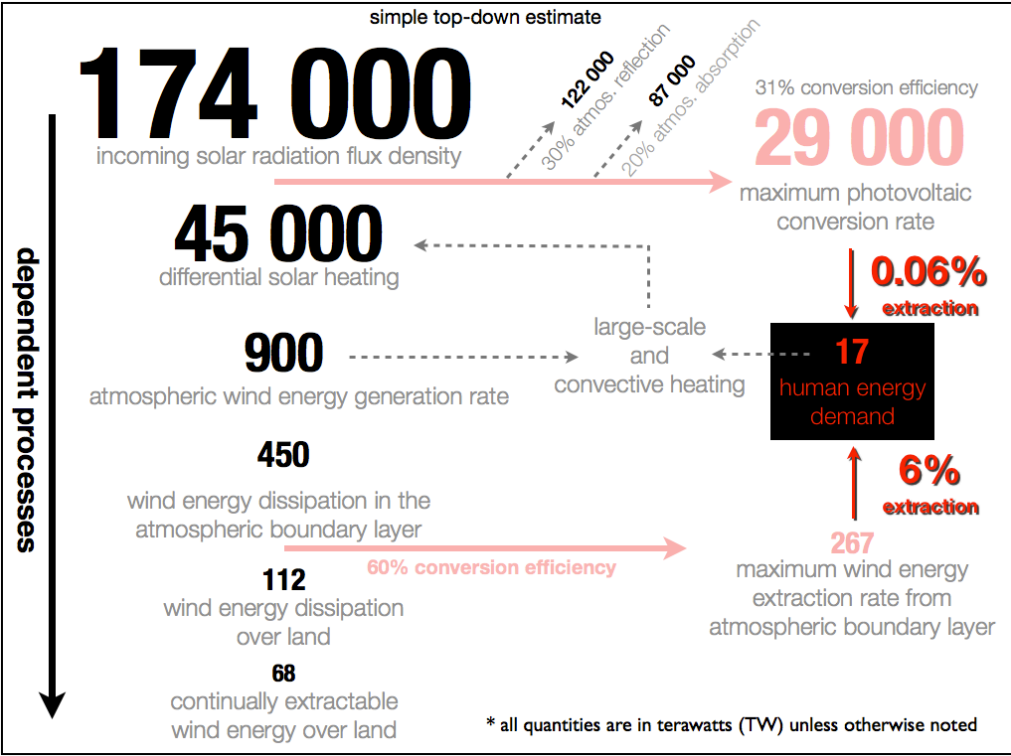

Limits and consequences of the large-scale deployment of renewable energy technologies

by
Lee Miller



Technical Reports - Max-Planck-Institut für Biogeochemie 27, 2012

Max-Planck-Institut für Biogeochemie
P.O.Box 10 01 64
07701 Jena/Germany
phone: +49 3641 576-0
fax: + 49 3641 577300
<http://www.bgc-jena.mpg.de>

Limits and consequences of the large-scale deployment of renewable energy technologies

Dissertation

zur Erlangung des Doktorgrades der Naturwissenschaften
im Department Geowissenschaften der Universität Hamburg

vorgelegt von

Lee M. Miller

aus Lancaster, Pennsylvania (USA)

Hamburg

2011

Als Dissertation angenommen vom Department Geowissenschaften
der Universität Hamburg

auf Grund der Gutachten von Prof. Dr. Hartmut Graß
und Axel Kleidon

Hamburg, den 5. Sept. 2011

Professor Dr. Jürgen Oßenbrügge
Leiter des Departments für Geowissenschaften

Abstract

A message presently heralded in the scientific literature is that by installing the appropriate number of renewable energy devices (*i.e.* wind turbines, photovoltaic panels, etc.), the atmosphere can return to pre-industrial conditions — this is impossible. Renewable energy technologies alter the Earth System during the energy extraction process. How these changes are manifested depends on more complex factors such as the technology, geographic location, and scale, but climatic differences are unavoidable. For example, although about 450 terawatts (TW) of wind power is normally dissipated near the Earth surface, through increasingly complex methods, we estimate a maximum electricity production rate of near-surface wind energy extraction over the global non-glaciated land surface of 18-68 TW_e . The general circulation model (GCM) simulation representing the maximum energy extraction rate shows that some climatic effects are similar in magnitude to a doubling of CO_2 , with large-scale differences in temperature and precipitation. The influence of the large-scale wind turbines also causes atmospheric dynamics that result in a 2-3% decrease in the generation rate of total atmospheric wind energy which will also influence subsequent atmospheric dynamics. Exploring jet stream wind power from the same top-down perspective, we estimate a maximum electricity production rate of 4.5 TW_e , about 200-times less than the previous estimate and quantified with a GCM to result in upper-atmospheric temperature increases of $> 20^\circ C$ at both poles and substantial differences in climate. With the clear relevance of the energy transformation hierarchy to estimate both power potentials and climatic impacts, we model near-surface wind power deployed in the 'windiest' areas or photovoltaic power deployed in the 'sunniest' areas. GCM simulations suggest that photovoltaics are able to fulfill the current global human energy of 17 TW demand with less than 1% coverage of the prescribed 'sunniest' areas and without any clearly discernible climatic differences compared to the control simulation. In strong contrast, near-surface wind power requires 100% of the 'windiest' areas to produce the same power, with this maximum extraction scenario associated with substantial climatic differences compared to the control simulation. Numerous other renewable technologies, geographic configurations, and complex model frameworks are presently available and fully worthy of similar fundamental limit-climatic consequence related studies. Ultimately, this work emphasizes the relevance of a 'top-down' thermodynamic Earth System based approach to large-scale renewable energy estimates. The actual quantified power estimates and environmental consequences included here may change slightly depending on the model or the assumptions, but the more core-realization that renewables have finite extraction limits and must be associated with climatic consequences seems certain.

Contents

1	Introduction	7
1.1	State of the Art Research Questions	9
1.2	Thesis outline	11
2	Estimating maximum global land surface wind power extractability and associated climatic consequences	13
2.1	Introduction	14
2.2	Estimation of wind power availability over land	15
2.2.1	Framework	15
2.2.2	How to conceptualize the process hierarchy - a back-of-the-envelope estimate	15
2.2.3	Simple momentum model with reanalysis wind data	17
2.2.4	Climate model simulations	20
2.3	Climatic Impacts from Wind Power Extraction	23
2.4	Discussion	27
2.4.1	Limitations	27
2.4.2	Implications	28
2.5	Conclusion	30
3	Jet stream wind power as a renewable energy resource: little power, big impacts	35
3.1	Introduction	36
3.2	The jet stream as a simple thought experiment	37
3.2.1	Framework	37
3.2.2	Derive understanding and conclusions	40
3.3	Methods: parameterization within a general circulation model	40
3.3.1	Kinetic energy extraction	41
3.3.2	Simulation setup and analysis	42
3.4	Results	42
3.4.1	Maximum extractable wind power and energetics of jet streams	42
3.4.2	Climatic impacts from jet stream wind power extraction	43
3.5	Discussion	44
3.5.1	Comparison and validity to previous estimates	44

CONTENTS

3.5.2	Implications	46
3.6	Summary and Conclusions	47
4	Solar and wind energy: same but different — why these differences matter for power potentials and climate impacts?	59
4.1	Introduction	60
4.2	Estimating solar (PV) and wind power availability over land	60
4.2.1	The power hierarchy	60
4.2.2	Conceptualizing climate impact consistency	62
4.2.3	Outline for this study	63
4.3	Methods	64
4.3.1	Parameterizing surface wind	64
4.3.2	Parameterizing photovoltaics	66
4.3.3	Quantifying climate differences	67
4.4	Results	67
4.4.1	Large-scale wind power potentials	67
4.4.2	Large-scale photovoltaic power potentials	68
4.4.3	Comparing the differences in mean climate response	68
4.5	Summary	69
4.6	Conclusions	70
5	Conclusion and Future Research	75
5.1	Summary	75
5.2	Possible Directions of Future Research	78
	Bibliography	81
	Acknowledgements	89

Chapter 1

Introduction

In the recent *Special Report on Renewable Energy Sources and Climate Change Mitigation* (SRREN) by the IPCC, "...lighting, cooking, space comfort, mobility, [and] communication," p. 5 are defined as basic human needs related to energy (Arvizu et al. 2011). To define these energy needs as *basic* speaks to the incredible advancements of mankind, specifically in the last 100 years from the technological advancements in both the appropriation and utilization of fossil fuels. During this time, energy use has quadrupled while population has tripled, resulting in a 12-fold increase in global human energy from 1.38 TW in 1900 (816 W/person) to 17 TW in 2011 (2500 W/person) (Smil 2010; EIA 2011). As we now recognize that "Most of the observed increase in global average temperature since the mid-20th century is very likely due to the observed increase in anthropogenic GHG (greenhouse gas) concentrations," (IPCC 2007) and current fossil fuel reserves represent a diminishing 600-year supply (Rogner et al. 2000), the need for energy sources that are "...secure and have low environmental impacts," p. 5 (Arvizu et al. 2011) becomes a key component to the human future on Earth.

A suggested response to these climatic changes, depleting resource stocks, and geopolitical factors is the large-scale deployment of renewable energy resources. Many researchers suggest present-day renewable energy technologies can simply be up-scaled to address present and future energy demand. A recent study stated that by using only 20% of the windiest land areas (*i.e.* ≥ 6.9 m/s at 80 meters above the land surface and 6 turbines per km^2), wind energy could provide for the global human energy demand (Archer & Jacobson 2005). A supporting global study of near-surface wind power states, "Should wind supply the world's energy needs, this parameterization estimates energy loss in the lowest 1km of the atmosphere to be 0.007%," p.816 of Santa-Maria & Jacobson (2009). The first quantification of jet stream wind energy extractability also states its enormous extractable potential, stating "The total wind energy in the jet streams is roughly 100 times the global energy demand [*i.e.* 1700 TW]," p.307-308.

This prevalence of readily-available renewable energy then demands a more detailed look at the economics and engineering constraints which is just beginning to permeate the literature. One very recent example, *Providing all global energy with wind*,

CHAPTER 1 INTRODUCTION

water, and solar power, part 1: technologies, energy resources, quantities and areas of infrastructure, and materials by Jacobson & Delucchi (2010) states:

”...powering the world with a WWS [wind, water, sunlight] system includes 3.8 million 5-MW wind turbines... 49,000 300-MW CSP power plants... 40,000 solar PV power plants... 5350 100-MW geothermal power plants... 900 1300-MW hydroelectric power plants... 720,000 0.75-MW wave devices... and 490,000 1-MW tidal turbines” p.18

So far, the assumptions stated by these cited studies are dependent on an Earth System that either shows no response to the energy extraction or with such negligible effects as to only require a detailed assessment when the human energy demand increases substantially from today.

There is another perspective worth considering. Schneider & Dennett (1975) stated how ”...no energy producing system can be considered completely free of climatic side effects if it alters natural energy flow patterns” p.70. Renewable technologies are specifically designed to extract the most energy per unit time (*e.g.* windy areas for wind turbines, sunny areas for photovoltaics). Ideally, these technologies are then installed in these optimum conditions, making the electricity they produce as cost-competitive as possible. Combined, this scenario suggests how renewable technologies are designed to extract energy at the maximum rate and are then deployed to locations when they can achieve their maximum energy extraction efficiencies. All this happens without a climatic consequence? Framed within the context where, for example, wind power accounted for 0.2% (0.034 TW_e) of the 17 TW global human energy demand in 2008 (Arvizu et al. 2011), it seems possible that present-day installations of renewables have simply not been up-scaled enough for the climatic consequences to be clearly discernible on a regional or global scale?

Pursuing this logic further, basing the maximum extraction rates of renewables on a combination of the present-day generation rates of Earth System processes and the potential climatic consequences of these extraction rates, in *Limits to wind power utilization*, Gustavson (1979) used a 'top-down' approach to illustrate how one can estimate how much wind energy can be fully utilized. Gustavson (1979) recognized that this 'top-down' approach draws ”...attention to some potentially grave environmental consequences and avoids some difficulties and misunderstandings that can arise out of generalizing from specific details,” p.13 such as using wind velocities to estimate large-scale wind power and assuming all kinetic wind energy can be extracted. Considering the generation rate rather the instantaneous kinetic energy of the atmosphere, Gustavson (1979) estimated that of the 1300 TW of near-surface wind energy dissipated globally (assuming 35% of the total), extracting 130 TW (10%) would reflect consideration of the generation rate, maximum extraction rate, and the climatic consequences.

Gustavson (1979) went on to include some other profound statements:

”***A distinction must be made between the amount of kinetic en-***

ergy in the wind and the rate at which energy can be continually extracted. This is essential not only as an antecedent to the conclusions reached herein [(instantaneous wind energy cannot be continually extracted)], but also because of the confusion surrounding this topic [(wind velocity is assumed to be directly related to extractable wind energy)]” p.14

and

*”Aside from the practical factors and economic incentives [of large-scale wind power installations], the only general limitation would appear to be a reluctance to significantly modify the earth’s climate. That is, if wind energy extraction were pursued with enormous diligence, the level of energy capture might be so large as to **significantly perturb the natural global processes**” p.14.*

These conclusions are not well-known but are also similar to research by Williams et al. (1977); Williams (1978); Weingart (1979) which also considered unavoidable climatic impacts.

1.1 State of the Art Research Questions

Scientific understanding of the Earth System through the use of models and measurement data has certainly increased in the last 30 years. Renewable technologies have also drastically increased in physical size and efficiency. Still, the focus of Gustavson (1979) on the generation rate providing the upper-bound to any estimate, dependent on an atmospheric system that already appears to be maximized without any additional disturbance or extraction (Paltridge 1978; Lorenz et al. 2001; Kleidon et al. 2006), makes intuitive sense. This poses the immediate question:

- (1) Why are the estimates for the maximum extraction rates so different?
- (2) Are there different ways to estimate these maximum extraction rates with some agreement in the estimates?

Gustavson (1979) also stated that there must be a direct climatic response to large-scale wind energy extraction near the surface. This historical opinion is supported by more recent wind modeling studies (Keith et al. 2004; Kirk-Davidoff & Keith 2008; Barrie & Kirk-Davidoff 2009; Wang & Prinn 2010; Calaf et al. 2010; Wang & Prinn 2011; Baidya Roy 2011) and detailed measurements (Baidya Roy 2010) that also show climatic consequences to wind energy extraction. With all of these studies tailored to illustrate wind power extraction from promising geographic locations rather than explore more general climate dynamics, another open question is:

- (3) How would the global atmosphere respond to continental-scale near-surface wind energy extraction?

- (4) Could the global generation rate of wind energy be altered with these large-scale deployments?

Focusing on the generation rate of wind energy of ≈ 900 TW (Lorenz 1955), with approximately half of this dissipated in the upper atmosphere, this draws immediate question to the 1700 TW that is estimated as extractable from the jet streams (Archer & Caldeira 2009). Noting that in Archer & Caldeira (2009), jet stream wind power estimates were derived from reanalysis datasets using $\frac{1}{2}\rho v^3$ while climatic impacts were derived from a general circulation model, it seems probable that there may be a confusion here between the flux of kinetic energy through a jet stream cross-section and the energy that can be continually extracted from the jet streams. So, using a 'top-down' approach to jet stream wind power:

- (5) How does a 'top-down' estimate of jet stream wind energy extractability differ from the previous estimate by Archer & Caldeira (2009) regarding power potential and/or climatic impacts?

Presently, the focus of renewable technology scenarios based on wind power appears to be the result of economic and the related Energy Return On Investment (EROI) considerations (Murphy & Hall 2010; Kubiszewski 2010) rather than extracting the most renewable energy possible over the global surface area. Simply, $\approx 175\,000$ TW of incoming solar radiation is transformed into $\approx 45\,000$ TW of differential solar heating, which is then transformed with a 2% conversion efficiency to ≈ 900 TW of wind energy (Lorenz 1955, 1960). Thus:

- (6) Would extracting solar energy (*e.g.* photovoltaic technology) result in more energy per unit surface area compared to its indirect form, wind energy?
- (7) Assuming an equivalent energy extraction rate from the Earth System from either photovoltaics or wind energy, how are the climatic impacts different?

1.2 Thesis outline

This thesis consists of 3 chapters written in the form of journal articles and as such, can be read individually. Each contains its own specific introduction, methodologies, and conclusions. In Chapter 2, we estimate the near-surface wind energy extractability over the global land surface and the associated climatic consequences. This chapter has been published in *Earth System Dynamics*¹. In Chapter 3, we analyze the jet streams as a potential renewable energy resource. This chapter has been published in open discussion in *Earth System Dynamics Discussions*². In Chapter 4, we analyze the renewable power potential and associated climatic effects of very large-scale near-surface wind energy extraction and photovoltaic-based energy extraction as a framework to determine if the current global energy demand of 17 TW can be satisfied with either technology. A summary of these findings is included in Chapter 5, and concludes with several short- and long-term research opportunities that are currently outstanding.

¹Miller L M, Gans F, Kleidon A, Estimating maximum global land surface wind power extractability and associated climatic consequences. *Earth Syst. Dynam.* **2** 1-12, 2011

²Miller L M, Gans F, Kleidon A, Jet stream wind power as a renewable energy resource: little power, big impacts. *Earth Syst. Dynam. Discuss.* **2**, 435-465, 2011

Chapter 2

Estimating maximum global land surface wind power extractability and associated climatic consequences

The availability of wind power for renewable energy extraction is ultimately limited by how much kinetic energy is generated by natural processes within the Earth system and by fundamental limits of how much of the wind power can be extracted. Here we use these considerations to provide a maximum estimate of wind power availability over land. We use several different methods. First, we outline the processes associated with wind power generation and extraction with a simple power transfer hierarchy based on the assumption that available wind power will not geographically vary with increased extraction for an estimate of 68 TW. Second, we set up a simple momentum balance model to estimate maximum extractability which we then apply to reanalysis climate data, yielding an estimate of 21 TW. Third, we perform general circulation model simulations in which we extract different amounts of momentum from the atmospheric boundary layer to obtain a maximum estimate of how much power can be extracted, yielding 18-34 TW. These three methods consistently yield maximum estimates in the range of 18-68 TW and are notably less than recent estimates that claim abundant wind power availability. Furthermore, we show with the general circulation model simulations that some climatic effects at maximum wind power extraction are similar in magnitude to those associated with a doubling of atmospheric CO₂. We conclude that in order to understand fundamental limits to renewable energy resources, as well as the impacts of their utilization, it is imperative to use a 'top-down' thermodynamic Earth system perspective, rather than the more common 'bottom-up' engineering approach.

2.1 Introduction

Several recent studies (Archer & Jacobson 2005; Santa-Maria & Jacobson 2009; Lu et al. 2009; Jacobson & Archer 2010a) propose that wind power can easily meet the current global human energy demand while also having negligible impacts on the Earth system. Archer & Jacobson (2005) quantified 72 TW of wind power extraction potential over land utilizing only 13% of the most windy land areas. Lu et al. (2009) increased this land-based quantification to 125 TW using an increased land area, larger wind turbines, and additional wind velocity measurements. Even more recently, Jacobson & Archer (2010a) stated that should 11.5 TW of wind turbine derived electricity sustain global power demand, "...[the required wind turbine] power extraction at 100m amounts to < 1% (11.5 TW/1700 TW) of the world's available wind power at 100m."

All of the above-mentioned studies neglect energy conservation, nearly imperceptible at smaller scales but critical when quantifying wind power potential at regional to global scales, as recently shown by Gans et al. (2010). The methodologies for calculating extractable wind power employed by these studies (Jacobson & Masters 2001; Archer & Jacobson 2003, 2005; Archer & Caldeira 2009; Santa-Maria & Jacobson 2009; Lu et al. 2009; Jacobson & Delucchi 2010) also differ significantly with those of Keith et al. (2004) and Wang & Prinn (2010) and should not be confused.

Combining wind turbine characteristics and wind velocity measurements is critical when estimating the potential electricity output of a proposed wind farm but the engineering focused 'bottom-up' methodology does not allow the quantification of changes to global wind power availability or climatic impacts directly resulting from wind power extraction. Previous very large-scale estimates, such as those utilizing large expanses of land (e.g. Archer & Jacobson (2005)) or the global atmospheric boundary layer (e.g. Santa-Maria & Jacobson (2009)) for wind energy extraction cannot use the same methodology as small wind farm developments without resulting in overestimations. Kinetic wind energy, and thereby extractable wind power, is not infinite.

Here, we constrain our estimates by the total rate of kinetic wind energy generated in the Earth system (Lorenz 1955; Gustavson 1979; Kleidon 2010). We use a simple back-of-the-envelope estimate to illustrate the natural Earth system process hierarchy that could result in wind power extractability from the atmospheric boundary layer. This process-based understanding is then extended with 2 different methods of increasing complexity, both based on fundamental limits of kinetic energy generation and extractability. From these differing methods, we can estimate a range of wind power extractability potentials over all non-glaciated land surfaces. These estimates therefore represent a realistic range of the maximum wind power potential that cannot be exceeded by improving wind turbine technologies (e.g. increasing their height or blade length, capacity factor, between-turbine spacing) or wind velocity mapping methods while maintaining energy conservation. Inevitably, this removal of wind power from the

Earth system must result in climatic impacts, shown here to be linearly proportional to the amount of wind power extraction.

2.2 Estimation of wind power availability over land

2.2.1 Framework

Approximately 900 TW of kinetic wind energy is currently generated and dissipated in the global atmosphere (Lorenz 1955) — this is based on theory and supporting observations (Peixoto & Oort 1992). Thermodynamic derivations show that this rate of wind power generation is the maximum rate achievable by the Earth System given present-day radiative forcing gradients, demonstrated by simple theoretical considerations (Lorenz 1960), box models (Paltridge 1978; Lorenz et al. 2001; Kleidon 2010), and general circulation models (Kleidon et al. 2003, 2006). Of the total wind power in the atmosphere, physics-based considerations fundamentally restrict the extraction potential of turbines to a decreased percentage of the initial flow (Lanchester 1915; Betz 1920). Using these ingredients, we derive 3 different estimates of wind power availability.

2.2.2 How to conceptualize the process hierarchy - a back-of-the-envelope estimate

A conceptualization of the interacting processes that could result in wind power extractability in the atmospheric boundary layer is shown in Fig. 2.1 and briefly outlined as follows:

1. **175,000 TW** \approx incoming solar radiation at the top of the atmosphere
2. **45,000 TW** \approx 25% of incoming solar radiation, differential solar heating results in atmospheric pressure differences which sets the air into motion, a process that is currently operating at its maximum rate of conversion (Lorenz 1960)
3. **900 TW** \approx 2% of differential solar heating, total wind power generation rate in the global atmosphere (Lorenz 1955) is the upper limit available for wind power extraction (Gustavson 1979)
4. **450 TW** \approx 50% of total generated wind power is dissipated in the atmospheric boundary layer (Peixoto & Oort 1992)
5. **112 TW** \approx 25% of the global land surface is non-glaciated land so assuming dissipated kinetic energy is equally distributed globally, this percentage of kinetic wind energy is most accessible for extraction

6. **68 TW** $\approx 60\%$ at most of the wind power extraction rate can be converted to mechanical power (Lanchester 1915; Betz 1920)

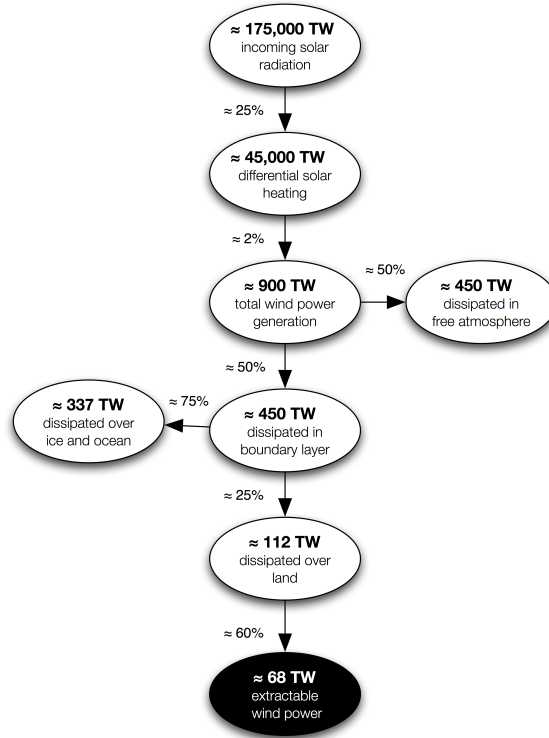

Figure 2.1: The conversion processes between incoming solar radiation and extractable wind power over the land in the Earth system is shown. In this simplified framework, assuming a 100% conversion efficiency from mechanical power to electrical power, a maximum of 68 TW of electricity can be produced from wind power extraction from the atmospheric boundary layer over all non-glaciated land surfaces.

Note that this process-based understanding is completely independent of wind velocity measurements and wind turbine characteristics (*e.g.* hub-height, aerodynamic efficiency, rotor diameter). The maximum land-based wind power extractability is not dependent on current engineering or technological limitations, but is instead completely dependent on wind power generation rates (Gustavson 1979) and the unavoidable competition between wind power extraction and dissipation by natural processes such as turbulence.

This estimate also includes numerous simplifications compared to the Earth system. For example, it assumes that wind power can be extracted where kinetic wind energy is dissipated. The introduction of large-scale wind turbines would certainly alter the

2.2 ESTIMATION OF WIND POWER AVAILABILITY OVER LAND

global patterns of atmospheric boundary layer dissipation. It also does not consider the contribution of momentum from higher-altitudes (Calaf et al. 2010) or the availability of extractable kinetic energy that was generated over the oceans. Finally, there is no feedback on the generation rate of kinetic wind energy resulting from wind power extraction.

Given these stated assumptions, the back-of-the-envelope estimate is only applicable as a first-order approximation of the processes related to wind power extraction from the atmospheric boundary layer. Its true benefit lies in its transparency, making it immediately apparent that much less than the generation rate of kinetic wind energy in the Earth system is available for extraction, regardless of the technology, as well as being based on very simple straightforward assumptions.

2.2.3 Simple momentum model with reanalysis wind data

A simple momentum balance model was developed to refine the back-of-the-envelope estimate of maximum wind power extractability. To establish the limit of maximum extraction, we consider the momentum balance of the boundary layer in steady state as:

$$\frac{d(mv)}{dt} = F_{acc} - F_{fric} - M = 0 \quad (2.1)$$

where mv represents atmospheric momentum, F_{acc} is the rate of momentum generation by an acceleration force, $F_{fric} = k \cdot v^2$ is the frictional force resulting in boundary layer turbulence with k being a friction coefficient ($kg \cdot m$) and v being the mean 1958-2001 European Centre for Medium Range Forecasting (ECMWF) ERA-40 10-meter wind velocity (0.7457 m/s), and M is the rate of momentum extraction by wind turbines. F_{acc} ($1.1918 \cdot 10^{14}$ N) is assumed to be constant, constrained by thermodynamic limits and currently operating at the maximum rate achievable as discussed by thermodynamic arguments (Paltridge 1978; Lorenz et al. 2001; Kleidon 2010) as well as climate model simulations (Kleidon et al. 2003, 2006).

The mean wind flow v is then given by:

$$v = ((F_{acc} - M)/k)^{1/2} \quad (2.2)$$

The wind power in the boundary layer P_{tot} is given by:

$$P_{tot} = F_{acc} \cdot v \quad (2.3)$$

This power is partitioned into dissipation by natural boundary layer turbulence D_n and power extraction $P_{ext}(M)$ by wind turbines:

$$P_{tot} = D_n + P_{ext}(M) \quad (2.4)$$

The expressions for these terms are:

$$D_n = F_{fric} \cdot v = k \cdot v^3 \quad (2.5)$$

and

$$P(M) = M \cdot v = M \cdot ((F_{acc} - M)/k)^{1/2} \quad (2.6)$$

The maximum power extraction from the system is obtained by:

$$\frac{dP_{ext}}{dM} = 0 \quad (2.7)$$

yielding an optimum value of extracted momentum M_{opti} :

$$M_{opti} = 2/3 \cdot F_{acc} \quad (2.8)$$

The associated maximum power extracted is:

$$P_{ext,max} = 2 \cdot (1/3)^{(3/2)} \cdot P_{tot}(M = 0) \quad (2.9)$$

or about 38.5 % of the original wind power in the absence of extraction. Of the extracted power, less than 60% of the wind power extracted from the atmospheric system is effectively converted to mechanical power while the rest of the extracted wind power is dissipated as wake turbulence (Lanchester 1915; Betz 1920; Garrett & Cummins 2007). We now use this estimated maximum efficiency of extraction and combine it with the wind power in the boundary layer as estimated from the ECMWF ERA-40 reanalysis climate data (ECMWF 2004). We use the u - and v -surface wind stress and 10-meter u - and v -wind velocity components to estimate natural dissipation D in the atmospheric boundary layer:

$$D = \vec{\tau} \cdot \vec{v} \quad (2.10)$$

where τ is the wind stress and v is the wind velocity. We find that for the period 1958-2001, a mean of 513 TW of wind energy is dissipated globally in the atmospheric boundary layer, most of which is dissipated over the southern ocean (Fig. 2.2). Of these 513 TW, 89 TW are dissipated over non-glaciated land surfaces that would be most easily accessible for wind turbine installations.

Using the simple momentum balance model and the estimated land-based dissipation of the ECMWF ERA-40 data results in a maximum extraction rate of 34 TW from the initial 89 TW of dissipation. Based on previously mentioned unavoidable inefficiencies (Lanchester 1915; Betz 1920; Garrett & Cummins 2007) and a 100% conversion efficiency from mechanical to electrical power, a maximum of 21 TW of electricity can be produced (Fig. 2.3). The simple momentum balance model also extends the back-of-the-envelope estimate by showing how an overall increase in momentum removal (natural drag + human extraction) corresponds to a decrease in boundary layer dissipation, with increased momentum removal beyond the maximum power extraction corresponding to a decrease in extracted power due to the reduced wind velocities.

2.2 ESTIMATION OF WIND POWER AVAILABILITY OVER LAND

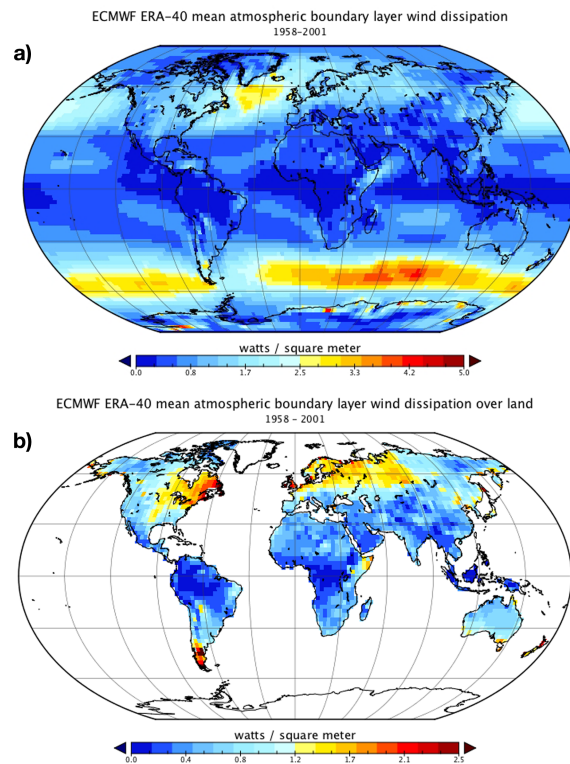

Figure 2.2: Distribution of estimated boundary layer wind dissipation **a)** globally and **b)** over non-glaciated land as a proxy for wind power extractability from ECMWF ERA-40 reanalysis data.

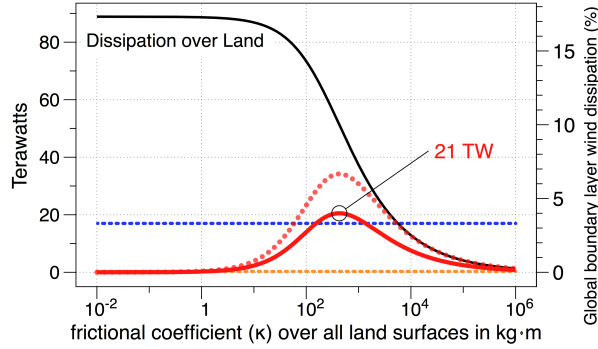

Figure 2.3: The relationship between an increased frictional coefficient (κ) to changes in wind dissipation over land (black line), extracted wind power (dashed red), and mechanical power that drives the wind turbine (solid red) is shown for the simple momentum balance model. For reference, the dashed blue horizontal line shows the estimated 17 TW of global energy demand in 2009 (EIA 2011) and the dashed orange horizontal line indicates the estimated 0.03 TW of global electricity production by wind turbines in 2008 (World Wind Energy Association 2008).

2.2.4 Climate model simulations

In the third method, we use a global climate model of intermediate complexity (Fraedrich et al. 2005; Lunkeit et al. 2007) and a methodology similar to the one used by Keith et al. (2004) to implement the effects of wind turbines. The climate model consists of a low-resolution atmospheric general circulation model, a mixed-layer ocean model with prescribed ocean heat transport, interactive sea-ice model, a simple land surface model, and prescribed ice sheets. To quantify the variations resulting from model resolution, 4 different model configurations were utilized: T21 spectral resolution (5.6° longitude by 5.6° latitude) and ten atmospheric levels, T21 spectral resolution with twenty atmospheric levels, T42 spectral resolution (2.8° longitude by 2.8° latitude) with ten atmospheric levels, and T42 spectral resolution with twenty atmospheric levels.

Boundary layer dissipation in the lowest model layer is parameterized by the commonly used surface drag parameterization of the form:

$$F_{drag} = \rho(C_n|v_l| + C_{ext}|v_l|) \cdot \vec{v}_l \quad (2.11)$$

where ρ is the air density, C_n is the volumetric drag coefficient for natural turbulence (which depends on surface roughness and atmospheric stability among other factors), v_l is the wind velocity, and C_{ext} is the additional volumetric drag coefficient to simulate momentum extraction by wind turbines. This model's reference manual provides a more detailed explanation of the drag parameterization (Lunkeit et al. 2007).

2.2 ESTIMATION OF WIND POWER AVAILABILITY OVER LAND

Natural dissipation by boundary layer turbulence D is given by

$$D = \rho C_n v_l^3 \quad (2.12)$$

while the extracted power by wind turbines is given by:

$$P_{ext} = \rho C_{ext} v_l^3 \quad (2.13)$$

A range of model simulations was conducted for different values of C_{ext} . The simulation with $C_{ext} = 0.0$ represents the natural case in the absence of power extraction by wind turbines and is referred to as our control simulation. In total, 13 simulations were completed with different values of $C_{ext} = [0.0 : 1.0]$ for each of the 4 model configurations. All simulations were conducted for 30 simulated years with the first 10 years discarded from the analysis to exclude spin-up effects. As large drag coefficients (*e.g.* $C_{ext} = 1.0$) greatly increase the atmospheric boundary layer depth, the lowest model layer influenced by F_{drag} is referred to as the control-region atmospheric boundary layer and is the only vertical level available for potential wind power extraction.

To compare the control simulations of the general circulation model and the estimated atmospheric boundary layer dissipation of the ECMWF ERA-40 reanalysis data, the mean values of each grid cell value in the boundary layer dataset were compared. As shown in Table 1, the T42 simulations correspond to the ECMWF ERA-40 reanalysis data more closely than the T21 simulations. This general interpretation is further reinforced by comparing the histograms as shown in Figure 2.4. Note the absence of mean dissipation values $> 3W/m^2$ in the T21 simulation (Fig. 2.4a) but the presence of these values in the T42 simulation (Fig. 2.4b). Although the T42 simulation land dissipation is larger than the ECMWF ERA-40 reanalysis data, the general agreement between the statistics (Table 1) and histograms (Fig. 2.4b) indicates that the T42 model resolution and ERA-40 based estimate from the previous section are similar, providing scientific validity with both resulting estimates. Their relative discrepancy from the T21 simulations can in part be attributed to that model parameterization's poor representation of topography due to less spatial resolution.

The sensitivity of wind power extraction over land is shown in Fig. 2.5. It is very similar to the simple estimate of Fig. 2.3. Different general circulation model configurations result in different estimates. For the T21 simulations with 10 vertical layers, we find a maximum of ≈ 18 TW of mechanical power over all non-glaciated land surfaces in the boundary layer in comparison to the 71 TW of boundary layer dissipation in the control simulation. For the T42 simulations with 10 vertical layers, we find a maximum of ≈ 34 TW of mechanical power over all non-glaciated land surfaces in the boundary layer in comparison to the 125 TW of boundary layer dissipation in the control simulation.

Although the estimated ECMWF ERA-40 dissipation values and the T42 simulations were previously shown to be similar, only the non-glaciated land dissipation (89 TW)

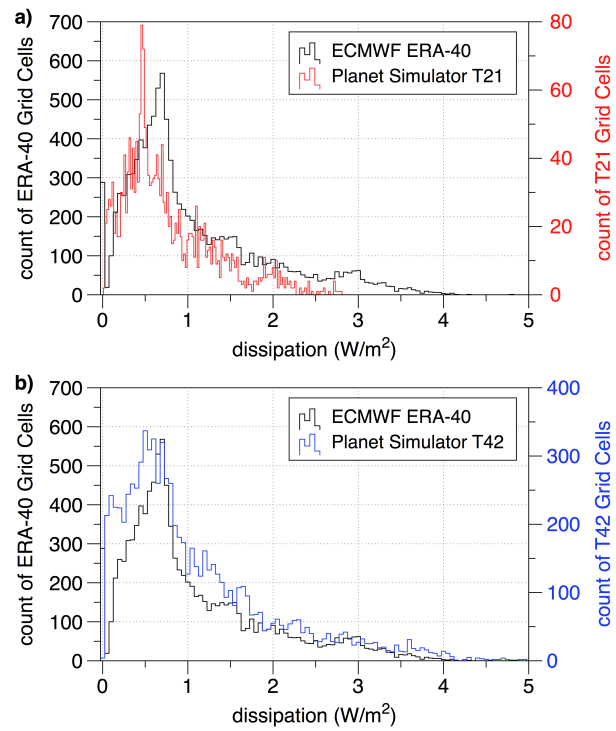

Figure 2.4: Global mean dissipation values for **a)** ERA-40 and a T21 10-vertical layer simulation and **b)** ERA-40 and T42 10-vertical layer simulation.

2.3 CLIMATIC IMPACTS FROM WIND POWER EXTRACTION

data	global	land	mean	median	σ	count
ERA-40	513	89	1.06	0.77	0.82	10512
T21,10	352	71	0.76	0.61	0.54	2048
T21,20	352	71	0.76	0.60	0.55	2048
T42,10	497	125	1.09	0.80	0.90	8192
T42,20	496	126	1.09	0.80	0.91	8192

Table 2.1: Mean data values for ECMWF ERA-40 reanalysis data (1958-2001), T21 spectral resolution with 10 and 20 vertical layers (20 year mean), and T42 spectral resolution and 10 vertical layers and 20 vertical (20 year mean) is shown. The corresponding units are: global = global atmospheric boundary layer dissipation in terawatts (TW), land = non-glaciated land atmospheric boundary layer dissipation in terawatts (TW), mean = mean of all data values in W/m^2 , median = median of all data values in W/m^2 , σ = standard deviation of all data values, and count = number of input data values.

was used in the simple momentum balance model. As such, we would expect the exchange of momentum between land and ocean that is present in the general circulation model but absent in the simple momentum balance model to result in a higher maximum extractable power for the T42 simulations which did occur. The variation of initial dissipation rates between the general circulation model simulations and the ERA-40 estimate may also explain the range of extracted mechanical power estimates. For comparison purposes, the mean dissipation for control conditions with a T42 spectral resolution and 10 vertical layers is shown in (Fig. 2.6).

2.3 Climatic Impacts from Wind Power Extraction

Global atmospheric motion will be affected by the extraction of momentum by large-scale wind turbine development. It has been previously suggested that the global human energy demand (17 TW in 2009 (EIA 2011)) could be easily accounted for by large-scale wind power development (Archer & Jacobson 2005; Archer & Caldeira 2009; Santa-Maria & Jacobson 2009; Lu et al. 2009). In stark contrast, our estimates suggest that 17 TW of wind power derived electricity would represent $\approx 50-95\%$ of the maximum land-based wind power possible with significant climate effects.

We use the climate model simulations of section 2.3 to demonstrate these climate effects. The control simulation was initially compared to an identical control simulation to estimate the variability within the climate model for the analyzed climatic variables and as such, there was no need for error estimation within the 52 simulations. To compare the magnitude of the climatic effects, we perform an additional model simula-

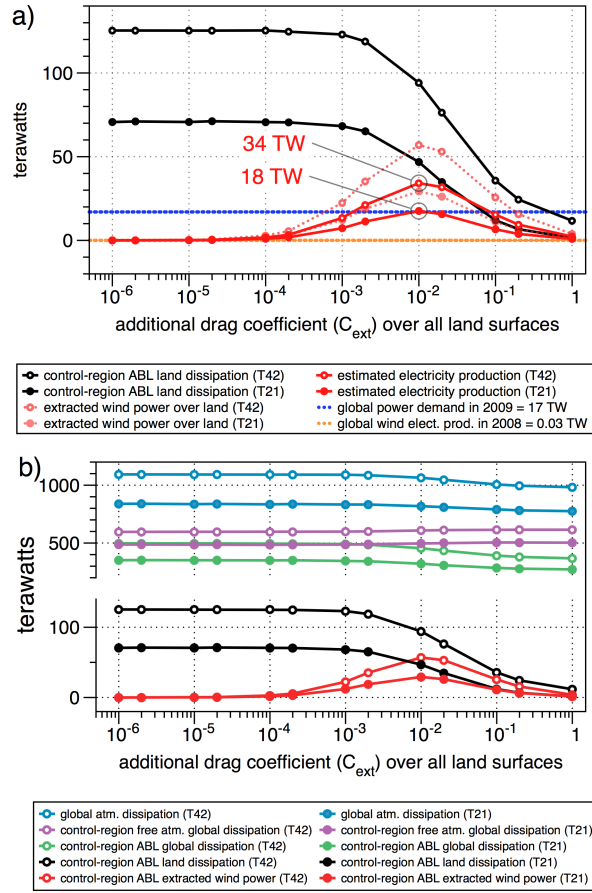

Figure 2.5: In **a)** sensitivity analysis between an increased drag coefficient (C_{ext}) over all non-glaciated land surfaces and the corresponding impacts to atmospheric boundary layer wind dissipation over land, extracted wind power (additional turbulence + power extraction), and mechanical wind power for the T42 (open circles) and T21 (closed circles) simulations with 10 vertical layers. Control-region corresponds to the volumetric region of the atmosphere in the control simulation, as increased drag coefficients eventually result in a new vertical compartmentalization of atmospheric boundary layer and free atmosphere dissipation. For reference, the dashed blue horizontal line shows the estimated 17 TW of global energy demand in 2009 (EIA 2011) and the dashed orange horizontal line indicates the estimated 0.03 TW of global electricity production by wind turbines in 2008 (World Wind Energy Association 2008). In **b)**, the same sensitivity analysis is shown but illustrating changes to the global atmospheric dissipation, control-region free atmosphere dissipation, control-region global atmospheric boundary layer dissipation, and control-region atmospheric boundary layer dissipation over land.

2.3 CLIMATIC IMPACTS FROM WIND POWER EXTRACTION

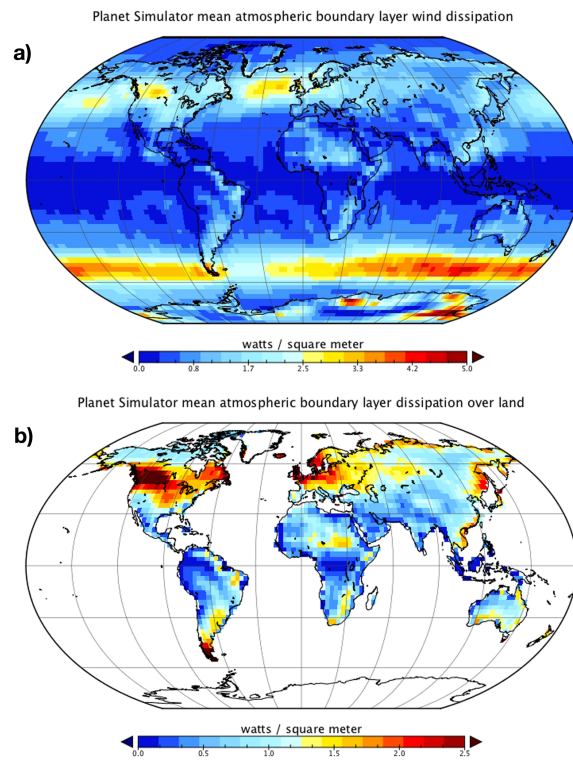

Figure 2.6: Distribution of boundary layer wind dissipation **a)** globally and **b)** over non-glaciated land as a proxy for wind power extractability simulated by a general circulation mode at T42 resolution and 10 vertical layers.

tion using an identical control setup with a doubled atmospheric CO_2 concentration of $720ppm$. Area-weighted mean land values only changed slightly at the maximum wind power extraction ($C_{ext} = 0.01$) and the sensitivity to a doubled CO_2 concentration shows a typical magnitude of change ($CO_2 = 720ppm$) as shown in Table 2. This is to be expected since the primary cause for the expected climatic changes from wind power extraction (the decrease in atmospheric mixing and transport) are much less directly linked to surface temperature change than direct changes in radiative forcing due to elevated CO_2 concentrations.

Table 2.2: The area-weighted mean climatic variables of all non-glaciated land points for the control simulation ($C_{ext} = 0.00$ and $CO_2=360ppm$), $C_{ext} = 0.01$ for maximum wind power extraction, and an atmospheric $CO_2 = 720ppm$ simulation are shown. The associated climatic variables have the following units: temperature in $^{\circ}C$, heat flux (latent + sensible) in W/m^2 , precipitation in mm/day , and surface thermal radiation in W/m^2 .

resol.	C_{ext}	2m air temp	heat flux	precip.	surf rad.
T21,10	0.00	16.50	97.93	3.06	77.70
T21,20	0.00	16.49	98.17	3.08	77.16
T21,10	0.01	16.93	96.96	2.99	79.13
T21,20	0.01	16.92	97.20	3.02	78.69
T42,10	0.00	13.95	70.46	1.63	76.46
T42,20	0.00	13.97	70.55	1.66	76.21
T42,10	0.01	14.32	70.45	1.63	77.77
T42,20	0.01	14.32	70.52	1.65	77.66
resol.	CO_2	2m air temp	heat flux	precip.	surf rad.
T21,10	360	16.50	97.93	3.06	77.70
T21,20	360	16.49	98.17	3.08	77.16
T21,10	720	20.39	105.06	3.20	72.66
T21,20	720	20.35	104.63	3.20	73.58
T42,10	360	13.95	70.46	1.63	76.46
T42,20	360	13.97	70.55	1.66	76.21
T42,10	720	15.63	95.27	2.79	78.98
T42,20	720	15.66	95.63	2.78	78.59

To identify resulting climatic impacts, we take the area-weighted mean of the absolute value differences for monthly climatological means for 20 simulation years for all non-glaciated land grid points as: $\sum_n^1 |x_{simulation} - x_{control}|$, where x is the climatic variable under consideration. Values reflect the climatic impacts resulting from the decrease

in atmospheric boundary layer dissipation over land, at the maximum wind power extraction by 24.7% in the T21, 10 vertical level simulation and 33.8% in the T42, 10 vertical level simulation (Fig. 2.5). Absolute differences do not identify if a land point is warmer or wetter than the control simulation, but rather focus on how monthly climatic variables differ. Figure 2.7 shows the linear sensitivity response of 2-meter air temperature, heat fluxes, precipitation, and surface thermal radiation to increases in momentum extraction and associated decrease in the control-region atmospheric boundary layer dissipation over land. Previous studies have shown changes in climatic variables with wind power extraction (Keith et al. 2004; Roy & Pacala 2004; Kirk-Davidoff & Keith 2008; Barrie & Kirk-Davidoff 2009; Wang & Prinn 2010) but this study directly relates changes in boundary layer dissipation to absolute differences in climate.

As shown in Fig. 2.7, the magnitude change of heat flux and precipitation for the maximum wind power extraction simulations are similar in value to the 720 ppm CO_2 simulations. Maximum wind power extraction over non-glaciated land (Fig. 2.8) also results in changes in 2-meter air temperature, convective precipitation rates, and incoming solar radiation at the surface as shown in Fig. 2.9. These climatic impacts are the result of increased turbulence and entrainment of higher-altitude air from the simulated wind turbines. This higher-altitude air has a higher potential temperature and when mixed with the air near the surface, results in a temperature increase. The increased turbulent mixing of the atmosphere from large-scale wind power extraction is also associated with changes in convective precipitation and solar radiation at the surface. These climatic impact dynamics are similar to those previously illustrated by Kirk-Davidoff & Keith (2008).

2.4 Discussion

2.4.1 Limitations

Our results show how the generation rate of kinetic wind energy in the atmosphere and thermodynamic constraints of power extraction ultimately limit wind power extractability. This is consistent with previous supporting research that states at the large scale:

1. conversion efficiencies from incoming solar radiation to atmospheric motion are currently maximized to present-day radiative forcing (Lorenz 1960; Paltridge 1978)
2. the maximized conversion rate suggests ≈ 900 TW of atmospheric kinetic energy is generated and dissipated in the Earth system (Peixoto & Oort 1992; Kleidon 2010)

3. Earth’s kinetic wind energy generation rate is the unattainable upper-bound for any kinetic wind energy extraction technology (Gustavson 1979)
4. perturbations to the system will decrease the conversion efficiency from solar radiation to atmospheric motion (Lucarini et al. 2010; Hernández-Deckers & von Storch 2010), with wind turbines being one example of an atmospheric perturbation
5. large-scale wind power extraction will result in climatic impacts (Keith et al. 2004; Roy & Pacala 2004; Kirk-Davidoff & Keith 2008; Barrie & Kirk-Davidoff 2009; Wang & Prinn 2010; Kirk-Davidoff 2010)

Points 1-3 are reproduced in our simple back-of-the-envelope estimate, a simple momentum balance model, and a range of model resolutions with a general circulation model of intermediate complexity. Taken together, our estimates range from 18-68 TW and are significantly less than the ≈ 900 TW of initially generated kinetic wind energy. Our simple momentum balance model and general circulation model simulations also reinforce points 4 and 5.

In the general circulation model sensitivities with wind power extraction, we did find that model resolution affects the estimates. At a resolution of T21 and 10 vertical levels, a maximum of 2.1% (18 TW) of the control simulation total atmospheric dissipation rate of 838 TW can be extracted as mechanical power from the control-region atmospheric boundary layer. Similarly, with sensitivity simulations at a resolution of T42 and 20 vertical levels, a maximum of 3.2% (34 TW) of the control simulation total atmospheric dissipation rate of 1064 TW can be extracted as mechanical power from the control-region atmospheric boundary layer. Different model configurations do result in different dissipation rates. Assuming climatic steady-state, this difference in the dissipation rate also shows a difference in the modeled generation rate. Still, by relating the total atmospheric dissipation rate to extractable mechanical power, these estimates only vary by $\approx 1\%$. A different general circulation model will certainly result in slightly different estimates, yet there is no obvious reason why other models should yield substantially different estimates in both maximized power extraction and the associated climatic consequences.

2.4.2 Implications

Given the variety of methodologies, we are confident that our estimates (18-68 TW) include the necessary complexity and processes to approximate the maximum extractable wind power over land within an order of magnitude. Adding additional complexity and/or processes may help to refine these estimates but will not drastically alter them. Nevertheless, this range of ‘top-down’ estimates is up to ≈ 100 -times less than the common ‘bottom-up’ engineering approach (Jacobson & Masters 2001; Archer & Jacobson

2003, 2005, 2007; Archer & Caldeira 2009; Lu et al. 2009; Santa-Maria & Jacobson 2009; Jacobson & Archer 2010a,b,c; Jacobson & Delucchi 2010).

This alternative 'bottom-up' engineering approach can be described as follows: using an extrapolated wind velocity to wind turbine hub height, a wind turbine power curve, air density, a modeled / measured / reanalysis-based wind velocity, a prescribed wind turbine density, and a geographic spatial area (*e.g.* land-only, land + nearshore, global), this approach attempts to estimate the extractable wind power. Note that in this approach, wind power is never removed from the global atmospheric system, leaving the global mean wind field and the wind field outside the wind turbine wake completely unaffected.

This also suggests why more recent estimates continue to increase, as the 'bottom-up' approach considers increased wind turbine height, rotor diameter, and aerodynamic efficiency to mimic engineering advancements (*e.g.* Archer & Jacobson (2003, 2005) use 80-meter hub height, Jacobson & Delucchi (2010) use a 100-meter hub height). Following such an approach, on p. 816 of Santa-Maria & Jacobson (2009), they state that "...should wind supply the world's energy needs [12 TW], this parameterization estimates energy loss in the lowest 1km of the atmosphere to be $\approx 0.007\%$." A simple translation of this statement suggests $> 170,000$ TW of wind derived electricity is continually available for extraction in the atmospheric boundary layer region. Similarly, using the same method but different assumptions, in Table 3 of Jacobson & Delucchi (2010), they estimate global extractable wind power at 100-meters = 1,700 TW. This 'bottom-up' approach is also being used for estimating high-altitude wind power extractability, where on p. 307 of Archer & Caldeira (2009), they recently stated that "...total wind energy in the jet streams is roughly 100 times the global energy demand," assumed here to suggest an additional $\approx 1,200$ -1,700 TW is available at higher altitudes, should the technology be developed and deployed effectively. As shown, the 'bottom-up' approach can exceed the ≈ 900 TW simply by adding additional or larger wind turbines, thereby neglecting the current generation rate of kinetic wind energy in the total atmosphere (Peixoto & Oort 1992) and exceeding the unattainable upper-limit for wind power extractability (Gustavson 1979).

Bergmann (2010) clearly identified this problem with the 'bottom-up' approach used by Santa-Maria & Jacobson (2009) and Jacobson & Archer (2010a) - it does not distinguish between the total instantaneous energy content of the atmosphere and the generation rate of energy into the atmospheric system. This is primarily based on the 'bottom-up' understanding of an atmosphere with wind turbines, where in response to Bergmann (2010), Jacobson & Archer (2010c) stated, "Energy loss occurs in the [wind turbine] wake, but not outside the [wind turbine] wake." Jacobson & Archer (2010a) further explain their approach when they state that, "...in the real atmosphere in the presence of wind turbines, F_{acc} [generation rate of kinetic wind energy in the atmosphere] would increase by the rate of momentum extraction by wind turbines."

As previously also identified by Bergmann (2010), this is a perpetual motion machine. For a single wind turbine, the effect of energy removal from the total atmosphere is not relevant. With multiple turbines, the influence of the wind field on nearby and distant wind turbines begins to be relevant. Finally, when one strives to estimate the maximum extractable wind power from the atmospheric boundary layer over the global non-glaciated land surface, the limited generation rate becomes critically important (Gans et al. 2010). Furthermore, the feedback of such a large perturbation to the atmosphere and its effect of decreasing the atmospheric generation rate also directly influences the estimates.

Our results show why the 'top-down' approach must be utilized when estimating wind power at a large-scale - the generation rate of kinetic wind energy into the atmospheric system is critical. As such, wind power is a renewable but finite resource with associated fundamental limits to extraction (Gustavson 1979). Utilizing wind power is also accompanied by unavoidable climatic consequences (Kirk-Davidoff 2010). This study renews and reinforces these facts while constraining future large-scale wind power extractability estimates to realizable bounds.

2.5 Conclusion

We estimate that between 18-68 TW of mechanical wind power can be extracted from the atmospheric boundary layer over all non-glaciated land surfaces. Although wind power extraction from a single turbine has little effect on the global atmosphere, many more will influence atmospheric flow and reduce the large-scale extraction efficiency. Any extraction of momentum must also compete with the natural process of wind power dissipation by boundary layer turbulence.

Our study focuses on the rate of wind power generation in the climate system rather than previous near-surface estimates that focused on measured wind velocities and engineering limitations (*e.g.* Archer & Jacobson, 2005; Lu et al., 2009; Santa Maria & Jacobson, 2009). This consideration results in our estimate being significantly less than previous studies while also being independent of wind turbine size or layout.

Given that only 0.03 TW of wind-derived electricity was produced in 2008 (World Wind Energy Association 2008), there is still substantial wind power development possible with relatively minor climatic impacts. However, future plans for large-scale wind power development must recognize the finite potential of the Earth system to generate kinetic wind energy. It has also been suggested that with increased carbon dioxide concentrations, the total atmospheric dissipation rate, and therefore its kinetic energy generation rate, will decrease (Lucarini et al. 2010; Hernández-Deckers & von Storch 2010). Future plans must accept that the human appropriation of wind power must be accompanied by a climatic effect and with large-scale deployment, will be associated with a decrease in the total atmospheric kinetic energy generation rate.

2.5 CONCLUSION

Our estimation methods are certainly extreme, but they nevertheless provide critical understanding of the limits of wind power in the climate system and how it can serve human energy requirements. Faced with the present-day global energy demand of 17 TW and a predicted change to 16-120 TW by 2100 (EIA 2011; IPCC 2007), extreme calculations such as this will provide the maximum power potentials and possible climatic effects of different forms of renewable energy sources planned to fulfill future human energy requirements. This in turn helps to prioritize which renewable energy resources are likely to be successful in meeting the future global human energy demand. More complex modeling studies can help refine our estimates and climatic impacts, but the presence of a maximum in wind power extractability and the associated climatic consequences from this extraction are fundamental.

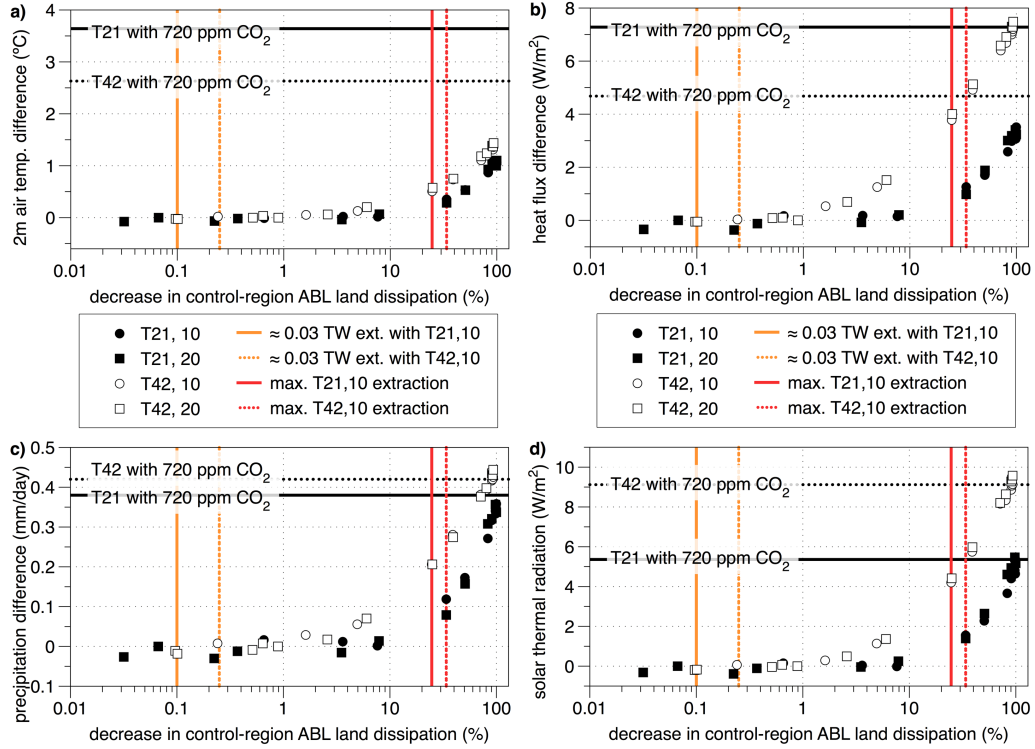

Figure 2.7: A simulated sensitivity analysis showing absolute differences in climatic variables over all non-glaciated land for a) 2-meter air temperature, b) sensible + latent heat flux, c) precipitation, and d) surface thermal radiation, resulting from increasing land-based wind power extraction compared to the respective model configuration control simulation. For comparison, simulations with an atmospheric CO₂ concentration of 720ppm are shown for a T21 simulation with 10 vertical levels (horizontal solid black line) and a T42 simulation with 10 vertical levels (horizontal dashed black line). For reference, the maximum wind power extraction (vertical red lines) and estimated 0.03 TW of electricity production in 2008 (World Wind Energy Association 2008) from the general circulation model configurations (vertical orange lines) is also shown. The climatic differences are shown in relation to the decrease in control-region atmospheric boundary layer (ABL) land dissipation estimated by the respective model configuration.

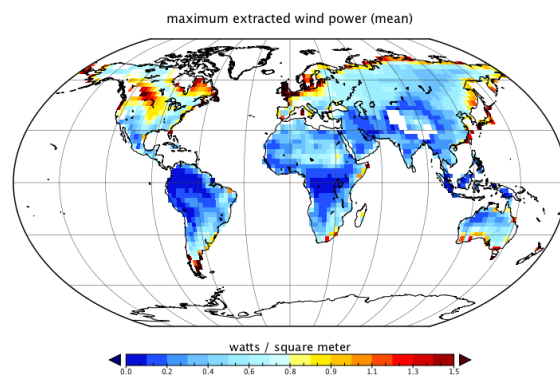

Figure 2.8: The maximum wind power extraction at T42 resolution and 10 vertical levels for a total extraction of 34 TW of mechanical power. Each non-glaciated land grid point has been parameterized with an additional drag coefficient ($C_{ext} = 0.01$). Note the influence of the large-scale circulation on large-scale extractable wind power, also noted in Barrie & Kirk-Davidoff (2009).

CHAPTER 2 WIND POWER EXTRACTABILITY OVER LAND

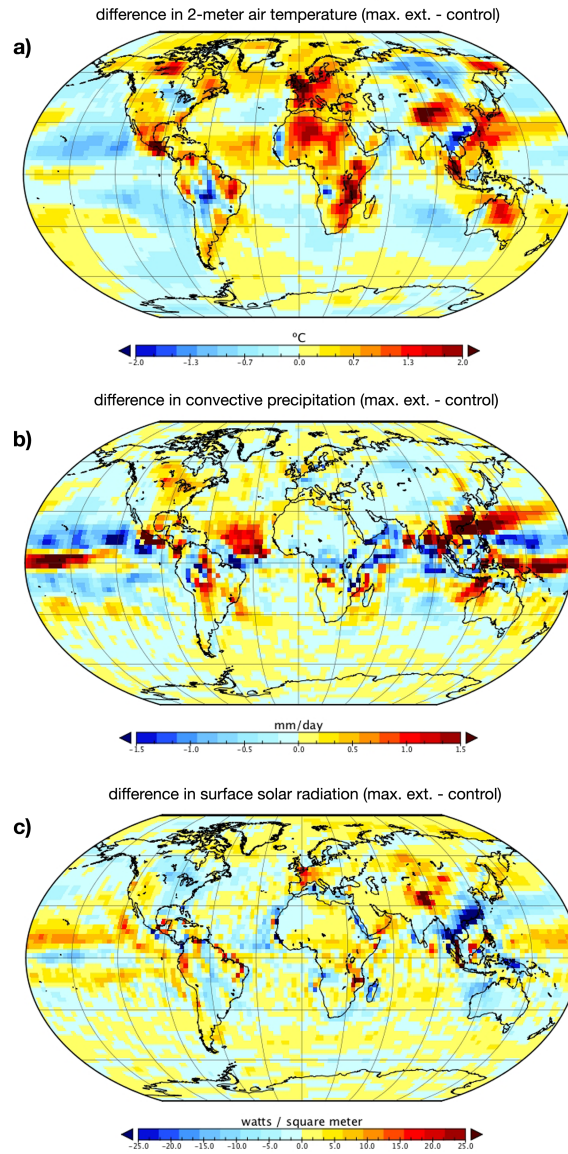

Figure 2.9: The climatic consequences of large-scale wind power extraction is shown at T42 resolution with 20 vertical levels as a difference between the mean maximum extraction and mean control simulations for **a)** 2-meter air temperature, **b)** convective precipitation, and **c)** surface solar radiation.

Chapter 3

Jet stream wind power as a renewable energy resource: little power, big impacts

Jet streams are regions of sustained high wind speeds in the upper atmosphere and are seen by some as a substantial renewable energy resource. However, jet streams are nearly geostrophic flow, that is, they result from the balance between the pressure gradient and Coriolis force in the near absence of friction. Therefore, jet stream motion is associated with very small generation rates of kinetic energy to maintain the high wind velocities, and it is this generation rate that will ultimately limit the potential use of jet streams as a renewable energy resource. Here we estimate the maximum limit of jet stream wind power by considering extraction of kinetic energy as a term in the free energy balance of kinetic energy that describes the generation, depletion, and extraction of kinetic energy. We use this balance as the basis to quantify the maximum limit of how much kinetic energy can be extracted sustainably from the jet streams of the global atmosphere as well as the potential climatic impacts of its use. We first use a simple thought experiment of geostrophic flow to demonstrate why the high wind velocities of the jet streams are not associated with a high potential for renewable energy generation. We then use an atmospheric general circulation model to estimate that the maximum sustainable extraction from jet streams of the global atmosphere is about 7.5 TW. This estimate is about 200-times less than previous estimates and is due to the fact that the common expression for instantaneous wind power $\frac{1}{2}\rho v^3$ merely characterizes the transport of kinetic energy by the flow, but not the generation rate of kinetic energy. We also find that when maximum wind power is extracted from the jet streams, it results in significant climatic impacts due to a substantial increase of heat transport across the jet streams in the upper atmosphere. This results in upper atmospheric temperature differences of $> 20^\circ\text{C}$, greater atmospheric stability, substantial reduction in synoptic activity, and substantial differences in surface climate. We conclude that

jet stream wind power does not have the potential to become a significant source of renewable energy.

3.1 Introduction

Energy options without carbon dioxide emissions and associated climatic impacts are necessary to avoid the current predictions of global climate change (IPCC 2008). Renewable energy sources are seen as such options, in particular, the use of naturally generated wind power of the atmosphere by wind turbines. Surface-based wind turbine installations have proven themselves to be economically attractive examples of a renewable energy technology with tremendous growth projected for the future (American Wind Energy Association 2007; United States Department of Energy 2008; EEA 2009; EWEA 2009). Yet wind power is not necessarily limited to the atmospheric region near the surface. Strong winds in the upper atmosphere, concentrated into so-called jet streams at 7-16 km altitude with velocities exceeding 50 knots (or about 25 m/s, American Meteorological Society (1999)), are seen by some as particularly rich sources of renewable wind power (Roberts et al. 2007; Vance 2009; Archer & Caldeira 2009). Archer & Caldeira (2009) estimated the potential of jet stream wind power as "...roughly 100 times the global energy demand". If we take the present global energy demand of 17 TW of 2010 (EIA 2010), then this estimate would imply that ≈ 1700 TW of wind power can be sustainably extracted from jet streams. However, this estimate is almost twice the value of the total wind power of ≈ 900 TW (Lorenz 1955; Li et al. 2007; Kleidon 2010) that is associated with *all* winds within the global atmosphere.

Here we resolve this contradiction between the energy that can maximally be extracted from the jet stream and the total power involved in generating all winds within the atmosphere. We start from the free energy balance that describes motion in the jet stream and accounts for the generation of kinetic energy, its dissipation, and the potential extraction of kinetic energy by wind turbines (see also Gans et al. (2010)). With this approach, we provide a more realistic upper limit for high altitude wind power that is consistent with atmospheric energetics. The contradiction originates from the erroneous assumption that the high wind speeds of the jet streams result from a strong power source. It is well known in meteorology that jet streams reflect quasi-geostrophic flow, that is, the high wind speeds result from the near absence of friction and not from a strong power source. To demonstrate this quantitatively, we first explore the physics of jet streams, the power involved in maintaining the flow, and how these aspects change when kinetic energy is extracted from the flow in the context of a thought experiment in the following section. We then describe the implementation of a kinetic energy extraction scheme for jet stream flow into an atmospheric general circulation model in section 3 as well as the setup of sensitivity simulations to various strengths of extraction. We present the results of these sensitivity simulations in section 4 in terms of differences

in velocity and dissipation rates, the limit on how much kinetic energy can maximally be extracted, as well as the climatic impacts that would result from a maximum extraction. In the discussion (section 5), we compare our results to previous studies. In particular, we use the GCM simulations to elaborate further on the difference between the transport of kinetic energy (which is often used as a proxy for instantaneous wind power in the renewable energy literature) and the kinetic energy that can be extracted from jet streams sustainably. We close with a brief summary and conclusion.

3.2 The jet stream as a simple thought experiment

3.2.1 Framework

To understand the relationship between wind speed and wind power in the jet stream, extractable wind power, and climatic impacts, we use a simple model of the jet stream based on basic physics (Peixoto & Oort 1992). The velocity of a jet stream \vec{v} results from a near-geostrophic balance in which the pressure gradient force F_0 is balanced by the Coriolis force F_c (Fig. 3.1). We represent the velocity \vec{v} by its zonal, eastward component u and its meridional, poleward component v . To describe the steady-state of these two components, we consider the geostrophic balance, but also introduce a drag term $k\vec{v}$ that characterizes friction and kinetic energy extraction by turbines, and a depletion term γv of the pressure gradient by the zonal flow of mass associated with v :

$$\frac{du}{dt} = fv - ku \quad \frac{dv}{dt} = -fu + (F_0 - \gamma v) - kv \quad (3.1)$$

where f is the Coriolis acceleration and we assumed that the pressure gradient acts in zonal, poleward direction.

In the steady state, the analytical expressions for u and v are:

$$u = \frac{f}{f^2 + k^2 + k\gamma} \cdot F_0 \quad v = \frac{k}{f^2 + k^2 + k\gamma} \cdot F_0 \quad (3.2)$$

The maintenance of this flow is characterized by the free energy balance of generation, dissipation, and extraction of kinetic free energy KE (Fig. 3.2):

$$\frac{dKE}{dt} = G - D_n - P_{ex} \quad (3.3)$$

where G is the generation of kinetic energy, D_n is the natural dissipation by momentum diffusion to regions adjacent to the jet stream, and P_{ex} is the extraction of kinetic energy by the wind turbines. The generation rate G is given by the power P associated with the net force acting on the mean flow, i.e.

$$G = P = \vec{F}_{net} \cdot \vec{v} = (F_0 - \gamma v)v = k \cdot \frac{(f^2 + k^2)}{(f^2 + k^2 + k\gamma)^2} \cdot F_0^2 \quad (3.4)$$

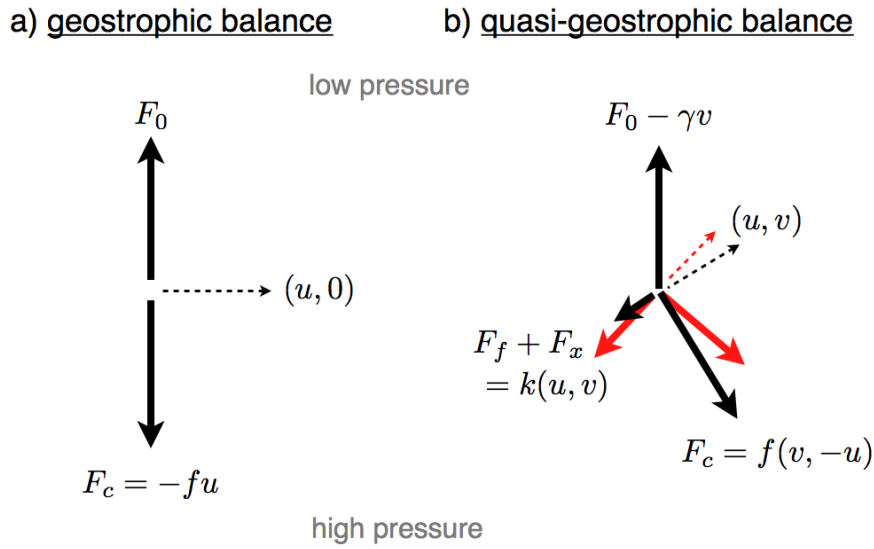

Figure 3.1: The balance of forces that describe the velocity $\vec{v} = (u, v)$ of the jet stream in **a)** the geostrophic balance (pressure gradient force F_0 , Coriolis force F_c , with Coriolis parameter f), and **b)** the quasi-geostrophic balance that considers friction F_f and removal of kinetic energy F_x (with $F_f + F_x = k\vec{v}$) as well as the depletion of the pressure gradient by the zonal flow $(0, -\gamma v)$. When wind turbines extract kinetic energy from the jet stream, then the balance is shifted further away from the geostrophic balance, as indicated by the red arrows in **(b)**.

3.2 THE JET STREAM AS A SIMPLE THOUGHT EXPERIMENT

The free energy of the jet stream is dissipated at the edges of the jet where velocity gradients deplete the momentum of the jet stream. We express this natural dissipation rate by a typical drag-like parameterization, with a drag coefficient k_n and the square of the wind speed:

$$D_n = k_n(u^2 + v^2) = k_n \cdot \frac{f^2 + k^2}{(f^2 + k^2 + k\gamma)^2} \cdot F_0^2 \quad (3.5)$$

The extraction of kinetic energy by wind turbines is expressed equivalently by an additional drag characterized by an additional parameter k_{ex} related to the number of turbines and their characteristics:

$$P_{ex} = k_{ex}(u^2 + v^2) = k_{ex} \cdot \frac{f^2 + k^2}{(f^2 + k^2 + k\gamma)^2} \cdot F_0^2 \quad (3.6)$$

Hence, the value of k in the expressions above is the combination of the natural drag k_n as well as the drag from the wind turbines k_{ex} , i.e. $k = k_n + k_{ex}$.

We now use the simple model to explore the relationship between the mean jet stream velocity and the dynamics of generation and dissipation of this flow. We first note that in geostrophic balance (with the absence of friction represented by $k = 0$), the generation of KE as well as its dissipation is zero ($G = D_n = 0$), as is the zonal flow velocity $v = 0$. The mean flow of the jets is given by $u = F_0/f$, that is, we have a non-zero wind speed, a large stock of kinetic energy, but no power is needed to sustain its flow. This energetic view of jet stream motion is highly relevant, as the instantaneous wind power of the flow, $\frac{1}{2}\rho v^3$, is often used in studies to calculate wind power estimates. *Since no power is involved in sustaining geostrophic flow though, the instantaneous wind power provides no indication of how much kinetic energy can be extracted sustainably from the flow!*

As soon as we consider some drag in this balance, either by the natural dissipation of momentum at the edges of the jet stream or by placing wind turbines into the flow (i.e. $k > 0$), then the balance is shifted away from a purely geostrophic balance (Fig. 3.1b). In this case, the flow becomes dissipative as kinetic energy of the jet stream is dissipated by the drag, $G = D > 0$ in steady state, and the flow gains a meridional component $v > 0$ that depletes the driving pressure gradient (Fig. 3.2). The extent to which the gradient is depleted by the meridional component of the flow is captured by the parameter γ that we introduced in the equations above.

The parameter γ plays a pivotal role in limiting how much kinetic energy can maximally be extracted sustainably from the flow. When turbines are placed into the jet stream to extract kinetic energy to convert it further to electricity, the drag is necessarily enhanced. This results in a shift in the balance of forces further away from the geostrophic balance. Then, the generation rate G may actually increase as the angle between the net force and the flow decreases, but the extent to which this increase

takes place depends on how fast the driving pressure gradient is depleted by the mass transported by the zonal flow.

3.2.2 Derive understanding and conclusions

We demonstrate this reasoning with the simple model (Fig. 3.3) using the parameter values given in Appendix Table 1. Since the value of γ is highly uncertain, we use different values that span two orders of magnitude to evaluate its relevance. Note that a higher value of γ implies a stronger depletion of the pressure gradient.

The first plot (Fig. 3.3a) shows a decrease of the u component and an increase in the v component with increasing values for the total drag, as would be expected by considering the three terms of the near-geostrophic balance. After reaching a peak value, the v component declines for high values of the drag due to the accelerated depletion of the driving pressure gradient. The sensitivity of the decline in u to the applied drag is greater and the peak in v is at a lower value with greater values of γ , although the value of the drag at which the v component peaks is not affected.

Fig. 3.3b shows the extracted kinetic energy as a function of the drag. The extracted power P_{ex} reaches a maximum at the value of the drag at which the v component is at a maximum as well, although the value of the peak is strongly affected by the value of γ . Further note that the peak of extraction occurs at a drag at which the velocity is still greater than zero, which implies that not only can all of the kinetic energy not be captured but is also limited to a maximum extraction rate.

The common expression for instantaneous wind power $\frac{1}{2}\rho|v|^3$ is compared to the actual rate of extraction P_{ex} in Fig. 3.3c. What this shows is that there is no simple, linear relationship between these two properties, so that the expression of instantaneous wind power does not adequately capture the potential for wind power extraction.

Fig. 3.3d shows the decline of natural dissipation D_n with increased drag. The lines essentially track the decline of velocity as shown in Fig. 3.3a.

To briefly summarize the insights gained from the geostrophic balance, we note that (i) instantaneous wind power $\frac{1}{2}\rho|v|^3$ provides no adequate estimate of sustainable extraction rates of kinetic energy; (ii) the maximum rate of kinetic energy extraction is constrained to less than the generation rate of kinetic energy; and (iii) the depletion rate of the pressure gradient γ in the upper atmosphere is critical to estimate how much kinetic energy can be at maximum extracted sustainably from jet stream flow.

3.3 Methods: parameterization within a general circulation model

In order to adequately estimate the maximum rate of wind power extraction from the jet streams in the global atmosphere, we resort to a general circulation model of the

atmosphere. Despite the possible limitations that such numerical models may have, this tool is critical to estimating the upper bound as it explicitly simulates the generation and dissipation of kinetic energy of jet streams in their atmospheric setting and it can explicitly simulate the effect that kinetic energy extraction from the jet streams has on the overall atmospheric dynamics. That is, the effect of the pressure gradient depletion that was captured by γ in the simple model above is explicitly simulated.

In this study, we use PlaSim, an atmospheric general circulation model of intermediate complexity (Fraedrich et al. 2005; Lunkeit et al. 2007) to quantify wind power extraction from the jet streams. We use this model with T42 spectral resolution, corresponding to a horizontal resolution of about 2.8° longitude by 2.8° latitude, ten atmospheric layers, a mixed-layer ocean model with prescribed oceanic heat transport, interactive sea-ice model, a simple land surface model, and prescribed ice sheets. Previous research shows that this model adequately captures the present-day climate and key sensitivities (Fraedrich et al. 2005; Kleidon et al. 2006).

In the following, we first describe briefly how we extract kinetic energy from the jet stream and then describe the setup of the sensitivity simulations.

3.3.1 Kinetic energy extraction

To simulate kinetic energy extraction, we apply an additional momentum flux $J_{turbines}$ to the vertical diffusion scheme for momentum for those grid cells at which the velocity is greater than a threshold wind speed of v_{jet} at a given model time step. Vertical diffusion of momentum represents non-resolved turbulent exchange between layers and is applied to the horizontal wind components, as well as to potential temperature and specific humidity. The momentum fluxes $J_{u,v}$ for the u and v wind components are expressed as:

$$J_{u,v} = \rho K_m \frac{\partial(u,v)}{\partial z} \quad (3.7)$$

where ρ is the air density, K_m is the exchange coefficient for momentum (which depends on stability, among other factors), and z is the vertical coordinate. The change in wind speed $\partial(u,v)/\partial t$ by momentum diffusion is then given by a diffusion equation:

$$\frac{\partial(u,v)}{\partial t} = \frac{1}{\rho} \frac{\partial J_{(u,v)}}{\partial z} - \frac{1}{\rho} J_{turbines} \quad (3.8)$$

where $J_{turbines}$ is the additional drag exerted by the wind turbines. The additional drag is in turn expressed in a similar way as the surface drag as:

$$J_{turbine} = \rho(C_{ex}|\vec{v}|) \cdot \vec{v} \quad (3.9)$$

where C_{ex} is the representative drag coefficient corresponding to the momentum extraction by wind turbines of a certain intensity.

We then diagnose the extracted power P_{ex} by turbines by

$$P_{ex} = J_{turbine} \cdot \vec{v} \quad (3.10)$$

as well as the frictional dissipation D_n by

$$D_n = \frac{\partial J_{(u,v)}}{\partial z} \cdot (u, v) \quad (3.11)$$

3.3.2 Simulation setup and analysis

A sensitivity analysis with 15 simulations was performed with different values of $C_{ex} = [10^{-10} : 10^{-4}]$ was applied to all grid points within the model grid with wind velocities that exceeded $v_{jet} > 25$ m/s. These simulations were compared to the "control" simulation of the present-day without momentum extraction ($C_{ex} = 0$). The simulation at which extracted wind power is at maximum will be referred to as "peak extraction" in the following. Through this setup, we establish the natural, upper limit of extractable wind power from high altitude jet streams without including methodological, technological, or engineering considerations. All simulations were run for 30 years with the first 10 years discarded to exclude spin-up effects.

The simulations were evaluated with respect to the resulting rate of kinetic energy extraction P_{ex} as well as variables of the jet stream, such as the u and v component as in the simple model above. In addition, we investigated the impacts of kinetic energy extraction on the dynamics of the jet streams and the climate system in general. To do so, we evaluated the differences in the the 20-year means for the "control" and "peak extraction" simulations in terms of the u -wind, v -wind, 2-meter air temperature, large-scale precipitation, convective precipitation, incoming solar radiation at the top of the atmosphere, and outgoing longwave radiation at the top of the atmosphere. To quantify changes in synoptic activity, the difference in standard deviation of simulated surface pressures (daily mean) for the 20-year simulation dataset are compared.

Additional sensitivity analyses were performed with thresholds of $v_{jet} > 20$ m/s and $v_{jet} > 15$ m/s to evaluate the sensitivity of this threshold on the jet stream wind power estimates.

3.4 Results

3.4.1 Maximum extractable wind power and energetics of jet streams

The sensitivity of the extractable wind power to the drag C_{ex} associated with wind turbines is shown in Fig. 3.4. As in the case of the simple thought experiment, it shows a pronounced peak at intermediate values of C_{ex} . The peak extractable power in these simulations is 7.5 TW of mechanical power removed from the flow. Because of wake

turbulence behind the turbines (which is not included in the simulations), not all of this extracted power is likely to be available as mechanical power to drive the turbine. Previous research showed a maximum, but unachievable, conversion efficiency from extracted power to mechanical power of 59.3% (Lanchester 1915; Betz 1920; Garrett & Cummins 2007). Assuming a 60% conversion efficiency to mechanical turbine power and 100% conversion efficiency from mechanical to electrical power, this upper bound yields a peak potential for electricity production of 4.5 TW.

This upper estimate of extractable wind power is relatively insensitive to the threshold velocity v_{jet} . In sensitivity simulations with $v_{jet} = 20$ m/s, the peak extracted power drops from 7.5 TW to 7.2 TW. When $v_{jet} = 15$ m/s is used, the peak drops further to 6.7 TW. The low value of extractable power in the climate model simulations suggests a high value of γ of at least $\gamma = 10^{-3}$ in the simple model, that is, that kinetic energy extraction results in a strong depletion of the upper atmospheric pressure gradient.

The dynamics and sensitivities as well as the maximum in extraction at intermediate values of C_{ex} directly correspond to the ones shown by the simple model of the previous section. The sensitivity of upper atmospheric winds and jet stream dissipation to the intensity of kinetic energy extraction from the jet streams is shown in Fig. 3.5. As in the case of the simple model (Fig. 3.3a), the zonal component of the upper atmospheric velocities decreases in response to enhanced drag, while the meridional component increases. This is accompanied with a general decrease of the total dissipation of the jet stream (Fig. 3.3d & 3.5b). Since velocities decreased considerably and below the threshold value of v_{jet} , jet streams were not continuously present in the simulations for drag coefficients $C_{ex} \geq 10^{-6}$.

Note that in addition to the dynamics represented by the simple model, the climate model simulations show a successive decrease in the generation of kinetic energy in the global atmosphere, as reflected by the reduction of dissipation in the free atmosphere and the atmospheric boundary layer (Fig. 3.4). This decrease in kinetic energy generation by the atmosphere is about two orders of magnitude larger than the extracted mechanical power at peak extraction. In order to understand why this is an inevitable consequence of the kinetic energy extraction from jet streams, we need to first investigate the broader climatic impacts.

3.4.2 Climatic impacts from jet stream wind power extraction

The substantial extraction of kinetic energy from jet streams has a marked global impact on atmospheric dynamics in the simulations. As already shown above, the meridional wind component increases substantially as a result of the kinetic energy extraction. This is shown in Fig. 3.6, where the upper atmospheric winds at peak extraction are compared to the control. Zonal flow in the mid-latitudes is reduced to

about 2/3 at peak extraction when compared to the control, and this reduction of zonal flow is accompanied with a substantial increase in meridional flow.

The enhanced meridional flow in the upper atmosphere has important effects on climate and atmospheric dynamics. The enhanced meridional flow transports more heat in the upper atmosphere. This results in a substantial difference in upper atmospheric temperatures of more than 20 °C in both high-altitude polar atmospheres (Fig. 3.7a). These differences occur adjacent to the regions in which the kinetic energy is extracted (Fig. 3.7b), substantiating the direct link between extraction and enhanced meridional heat transport in the upper atmosphere.

This strong warming in the extratropical upper atmosphere has further consequences. It results in a reduced vertical temperature gradient in the extratropics (Fig. 3.7a) and thereby in a much enhanced vertical stability of the atmosphere. As a result, the ability of the atmosphere to generate kinetic energy is much reduced. This is reflected in a lower total dissipation in the free atmosphere and the atmospheric boundary layer (Fig. 3.4, also Table 3.1), with a 44% decrease in free atmosphere dissipation (635 TW to 358 TW) and a 29% decrease in boundary layer dissipation (584 TW to 419 TW). The reduction in kinetic energy generation and associated, overall heat transport is then reflected in a greater radiative imbalance at the top of the atmosphere (Fig. 3.8). Even though this enhanced radiative imbalance would seem to imply a stronger radiative forcing and thereby a greater ability of the atmosphere to generate motion, it is critical to note that this radiative imbalance is rather the *consequence* of reduced overall motion within the atmosphere.

In the simulation of peak extraction, we find considerable differences in climate (Fig. 3.9). The climatic differences shown in Table 3.1 are not related to a mean change in radiative forcing, as would be the case for climatic change due to alterations of the atmospheric greenhouse effect, but result directly from the weakened energetics of atmospheric motion. In particular, we find that the variability of surface pressure is considerably reduced in the mid-latitudes, indicating a reduction of synoptic activity. This reduction is consistent with the general reduction of kinetic energy generation within the atmosphere. The associated differences in mean 2m air temperature in the mid-latitudes are consistent with this reduced synoptic activity, with pronounced cooler temperatures over land.

3.5 Discussion

3.5.1 Comparison and validity to previous estimates

Our estimate of maximally extractable wind power from jet streams of 7.5 TW is substantially lower than the estimate of 1700 TW by Archer & Caldeira (2009). Naturally, there must be a simple reason why our estimate is so much lower. In the following, we

parameter	control	medium	peak
ABL diss. (TW)	584	482	419
free atm. diss. (TW)	635	477	358
2-meter air temp. ($^{\circ}\text{C}$)	17.7	17.4	17.2
large scale precip. (mm/day)	0.68	0.63	0.54
conv. precip (mm/day)	2.95	2.96	3.00

Table 3.1: Global mean values for atmospheric dissipation and climatic parameters for the control simulation (no extraction), a medium rate of extraction (4.2 TW of kinetic energy extraction), and the peak extraction simulation (7.5 TW of kinetic energy extraction).

first describe that our results are consistent with the basic physics of jet streams. Hence, the difference in estimates likely originates from the difference in methodology. We relate this difference to the flaw in the common methodology that derives extractable wind power from wind speeds rather than from the free energy balance that describes the generation, dissipation, and extraction of kinetic energy (*e.g.* Gans et al. (2010) gives a detailed description of the severe limitations of the common method) and illustrate this flaw with output from the climate model simulations. We then discuss the implications of these results in terms of the methodology that should be used for maximum estimates of wind power and for the prospects of wind power from high altitude winds.

First, we point out that our results are fully consistent with the basic physics that describe the dynamics of jet streams and what would be expected when jet streams are disturbed by kinetic energy extraction. As it is well known in meteorology, jet streams result from a near geostrophic balance of forces, that is, the quasi-geostrophic flow results from the near absence of friction. Hence, little power is involved in maintaining the high wind speeds of the jet streams. This near-geostrophic nature of jet streams is reflected in our low maximum estimate of extractable wind power.

The potential impacts of extraction that we find in the climate model simulations are consistent with the potential alteration of the near-geostrophic balance of forces by kinetic energy extraction of wind turbines. This balance is disturbed by an additional drag by wind turbines, and this drag is unavoidable as kinetic energy needs to be extracted from the flow to rotate the turbine. Through this additional drag, the resulting motion is brought further away from the geostrophic balance, yielding a stronger ageostrophic component of the flow. The climate model simulations show this expected change and the simulated climatic impacts result from this enhanced ageostrophic flow in the upper atmosphere. Furthermore, the climatic impacts that we find are consistent with those reported by Archer & Caldeira (2009). Specifically, Archer & Caldeira

(2009) p.315 found a "... strengthening of the Equator-to-Pole thermal difference [that was] caused by the weakening of the global winds". Such a strengthening of the surface temperature difference at the surface is also found in our simulations at peak extraction and consistent with our interpretation.

Hence, the discrepancy of our estimate to previous ones should be found in the methodology. While extractable wind power is commonly determined from the wind speed by $\frac{1}{2}\rho v^3$, we took a different approach and considered the free energy balance of kinetic energy generation, dissipation, and extraction. In steady state, the rate of kinetic energy extraction needs to be balanced by how much kinetic energy is generated and must be less than the rate at which it is naturally transferred out of the jet stream by momentum diffusion. The mean stock of free energy, the kinetic energy of the flow $\frac{1}{2}\rho v^2$, then reflects not just the generation rate, but also the intensity of its natural depletion and the extent of extraction. However, as already shown in section 2 above, the instantaneous wind power density of $\frac{1}{2}\rho v^3$ is not related to the maximum sustainable rate at which kinetic energy can be extracted from jet streams. The instantaneous wind power density merely describes the transport of kinetic energy by the flow through a cross section perpendicular to the flow, but yields little information about the generation and natural depletion rate of kinetic energy. This is in particular the case for geostrophic flow, where no generation is needed to sustain geostrophic motion because of the absence of frictional dissipation.

This critical distinction between the transport of kinetic energy in contrast to the natural rate of depletion is shown in Fig. 3.10 for the climate model simulation. The high rates of the mean transport of kinetic energy at 200 hPa height shown in Fig. 3.10a are consistent in pattern and magnitude with the maps shown by Archer & Caldeira (2009), although these are referred to by Archer & Caldeira (2009) as wind power density. Fig. 3.10b shows the natural depletion rate at 200 hPa due to momentum diffusion with no extraction. As can be seen, the natural depletion rate at 200 hPa is 4 orders of magnitude smaller than the transport of kinetic energy. Since in the natural steady state, the generation of motion balances its depletion, it is this depletion rate that characterizes the power involved in sustaining the flow. The maximum estimates for wind power extraction are then even lower, as shown in Fig. 3.10c, and show relatively little correspondence to the patterns of the transport of kinetic energy. Therefore, the transport of kinetic energy by jet streams cannot be used to provide estimates of maximum sustainable rates of kinetic energy extraction.

3.5.2 Implications

Our results have broader implications for how maximum estimates of wind power should to be computed in general. First, we showed that it is critical to consider extraction as a term in the free energy balance of kinetic energy and use this balance as the

fundamental limit on maximum possible rates of kinetic energy extraction by wind turbines (following Gans et al. (2010)). As wind speeds merely reflect the stock of kinetic energy within the atmosphere, these cannot be used to provide such estimates of maximum possible extraction rates. Second, our climate model results showed that there are substantial, first order effects when kinetic energy is extracted that affect the ability of the atmosphere to generate kinetic energy. To capture these effects, physically-based models that simulate the generation of kinetic energy and the effects of extraction on this generation rate are critical for estimates of upper limits of wind power, despite all the potential flaws that these models may have. Upper estimates that are based on observed wind speeds cannot represent the free energy balance of kinetic energy and the feedbacks of extraction on generation rates of kinetic energy and thereby cannot provide physically consistent estimates.

The simulations that we conducted represent an extreme scenario, and therefore our maximum estimate should be seen as very much an upper limit. It would seem technically nearly impossible to continuously track the regions at which wind speeds exceed 25 m/s and extract substantial rates of kinetic energy from the upper atmosphere at the global scale to get close to our estimate. Furthermore, substantial interference with jet streams would change the climate substantially, in particular through the weakening the atmospheric heat engine by two orders of magnitude more than the power gained by extraction. Hence, it would seem that high altitude wind power has very little potential to contribute to the challenge of meeting the primary energy demands of humans.

3.6 Summary and Conclusions

We used a new, physically consistent method to estimate the maximum rate of kinetic energy extraction from high altitude winds of > 25 m/s. This method represents kinetic energy extraction as a term in the free energy balance of kinetic energy generation, dissipation, and extraction. Our estimate for maximum sustainable extraction of kinetic energy from jet streams is 7.5 TW and is about two orders of magnitude less than previous estimates. Our substantially lower estimate reflects physical consistency with the free energy balance of kinetic energy, the impacts that substantial kinetic energy extraction has on the generation rate, and is consistent with the well-established notion that jet streams represent near-geostrophic flow. In contrast, other estimates are often based on wind speeds that are then used to compute the transport of kinetic energy by the flow. This term is then misinterpreted as being the sustainable extraction rate of kinetic energy. Hence, it would seem that velocity based estimates of wind power are flawed because they cannot infer the terms of the free energy balance and the effects of extraction on the generation rate of free energy, but these terms are the ones that ultimately limit sustainable extraction rates.

CHAPTER 3 JET STREAM WIND POWER EXTRACTABILITY

We conclude that it is critical to start with the free energy balance for evaluating the potential contributions of different forms of renewable energy to the growing human needs for energy. These estimates need to be performed in an Earth system context to account for first-order consequences of extraction on the generation rates of free energy. Our application of this physically-based approach to high altitude winds shows that in practicality, there is a very limited potential of jet streams to contribute to human energy needs, and if it were used, only with a very substantial climatic consequence. Previous claims by researchers that "if you tapped into 1 percent of the power in high-altitude winds, that would be enough to continuously power all civilization" (Blackman 2009) are based on estimates that do not account for the limitations imposed by the free energy balance and are therefore physically flawed. Such statements substantiate the urgent need for a physically-based approach that quantifies the dynamics of free energy generation and depletion in the context of Earth system functioning in order to understand how much these can potentially contribute to a human renewable energy future.

Table 3.2: Variables and parameters used to understand the dynamics of the jet stream (Eqs. 1-6) are listed below. Values listed in column 3 are taken from *Physics of Climate* by Peixoto & Oort (1992). Column 4 shows the parameters derived or estimated by the authors.

variable	thought experiment simple model definition	Peixoto & Oort (1992)	estimates	units
f	coriolis acceleration at 30°	$0.7 \cdot 10^{-4}$	—	1/s
k_n	natural jet stream drag	10^{-6}	—	1/s
k_{ex}	human-induced jet stream drag	—	—	1/s
k	natural and human-induced jet stream drag	—	—	1/s
v	mean control jet stream poleward (north-south) component	—	28.6	m/s
u	mean control jet stream meridional (east-west) component	—	0.41	m/s
\bar{v}	mean control jet stream velocity	—	28.6	m/s
F_0	pressure driven acceleration of v -component	$2 \cdot 10^{-3}$	—	m/s^2
F_c	Coriolis force	—	—	$kg \cdot m/s^2$
F_f	frictional force	—	—	$kg \cdot m/s^2$
F_x	removal of kinetic energy	—	—	$kg \cdot m/s^2$
F_{net}	frictional force and KE removal force ($F_f + F_x = k\bar{v}$)	—	—	$kg \cdot m/s^2$
KE	jet stream kinetic energy	—	—	$kg \cdot m/s$
P	power associated with the net force (F_{net})	—	—	$kg \cdot m^2/s^3$
G	generation rate of jet stream kinetic energy	—	—	$kg \cdot m^2/s^3$
γ	depletion rate of the jet stream gradient	—	—	1/s
D_n	natural wind dissipation by mom. diffusion	10^{-4}	—	$kg \cdot m^2/s^3$
Δz	vertical extent of one jet stream	—	10^3	m
$\Delta R\phi$	horizontal extent of one jet stream	—	10^6	m
L	length of one jet stream at 30° and 10km altitude	—	$3.4 \cdot 10^7$	m
ρ	density of one jet stream at 10 km altitude	—	0.4	kg/m^3
V	volume of one jet stream at 30° and 10km altitude	—	$2.7 \cdot 10^{16}$	m^3
$\rho \cdot V$	mass of one jet stream at 30° and 10km altitude	—	10^{16}	kg

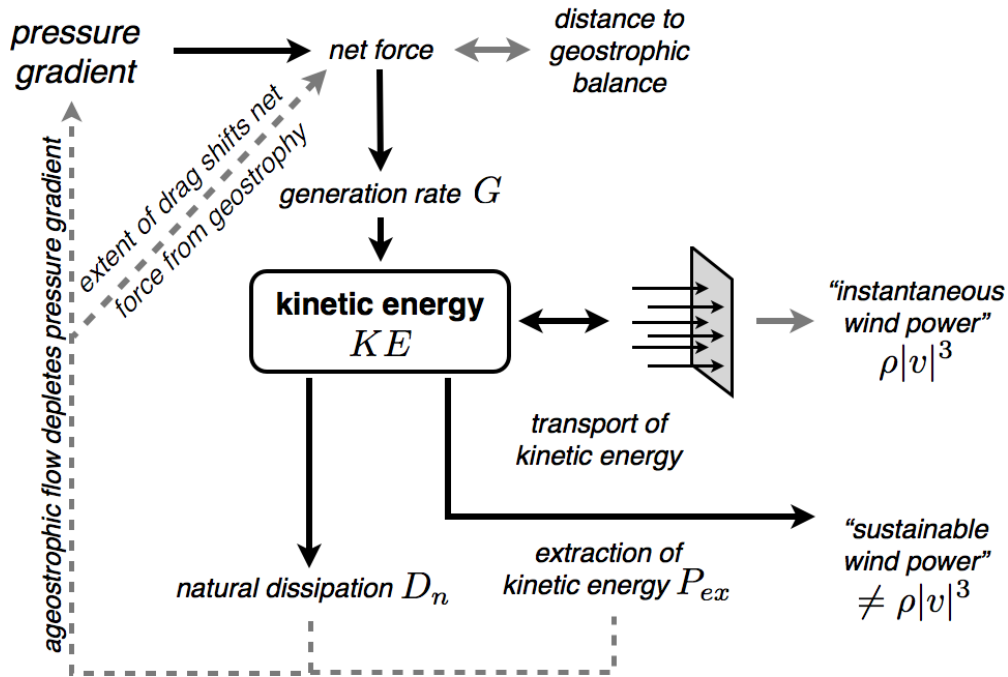

Figure 3.2: The kinetic energy KE of the jet stream results from the balance of generation G , natural dissipation D_n at the edges of the jet stream due to momentum diffusion, and extraction P_{ex} due to the placement of wind turbines. Note that in geostrophic balance, $G = D_n = 0$ but $KE > 0$, so that the common metric of instantaneous wind power $\frac{1}{2}\rho|v|^3$ of the flow through some cross-sectional area perpendicular to the flow is not adequate to estimate the sustainable rate of kinetic energy extraction P_{ex} . To estimate this rate, one needs to implement the extraction of kinetic energy as a separate term into the kinetic energy balance and to evaluate its effect on the generation rate (as shown by the dashed lines).

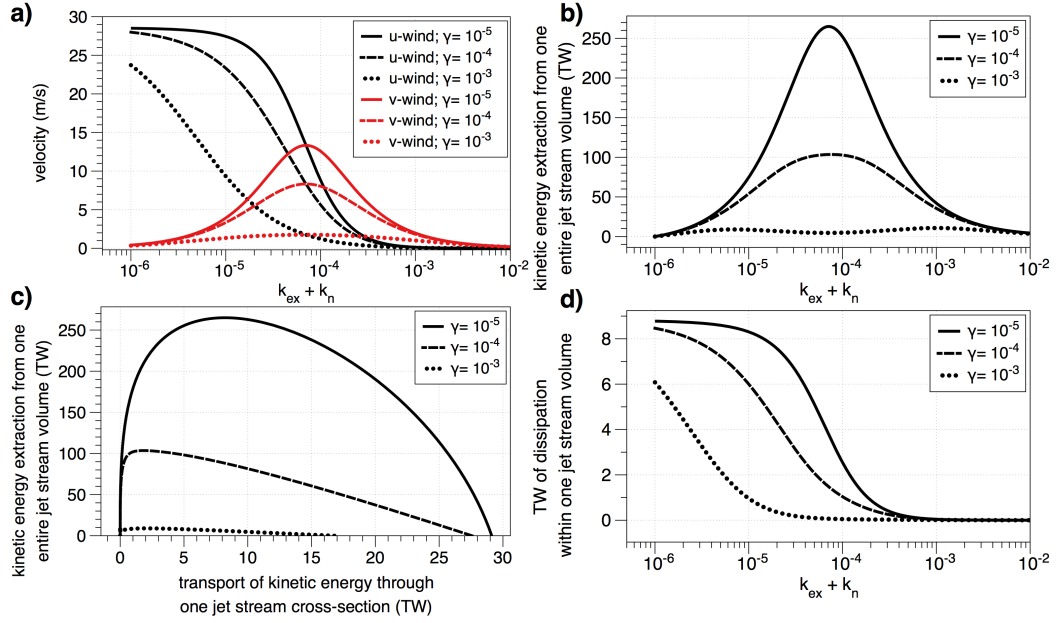

Figure 3.3: Sensitivity of jet stream dynamics to the intensity of kinetic energy extraction of the simple model for different values of the intensity γ by which the pressure gradient force is depleted. Shown are: **a)** u and v components of the flow; **b)** kinetic energy extracted from the flow due to the additional drag k_{ex} ; **c)** the sustainable extraction rate P_{ex} of kinetic energy versus the transport of kinetic energy through a single jet stream cross-section (which is often taken as a measure of wind power); and **d)** natural dissipation D_n of one jet stream. All parameters are specified in Appendix Table 1.

3.6 SUMMARY AND CONCLUSIONS

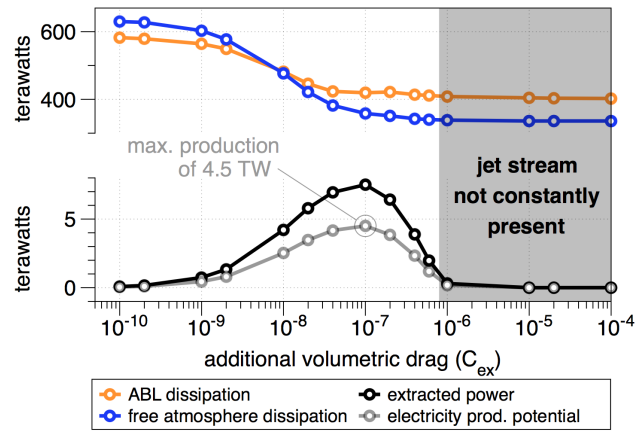

Figure 3.4: Sensitivity of extracted kinetic energy from jet streams P_{ex} and total atmospheric dissipation D_n to the additional drag C_{ex} imposed by wind turbines.

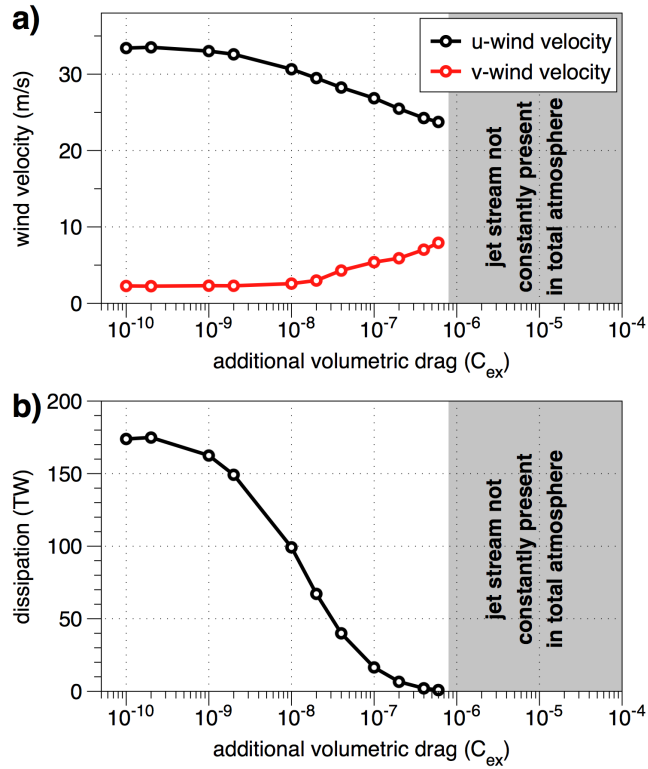

Figure 3.5: Sensitivity of jet stream dynamics to the intensity of kinetic energy extraction C_{ex} from jet streams with $v_{jet} = 25$ m/s in terms of **a)** the mean u - and v -wind velocities at 200 hPa and **b)** the dissipation rate within those atmospheric regions at which the wind velocity is > 25 m/s.

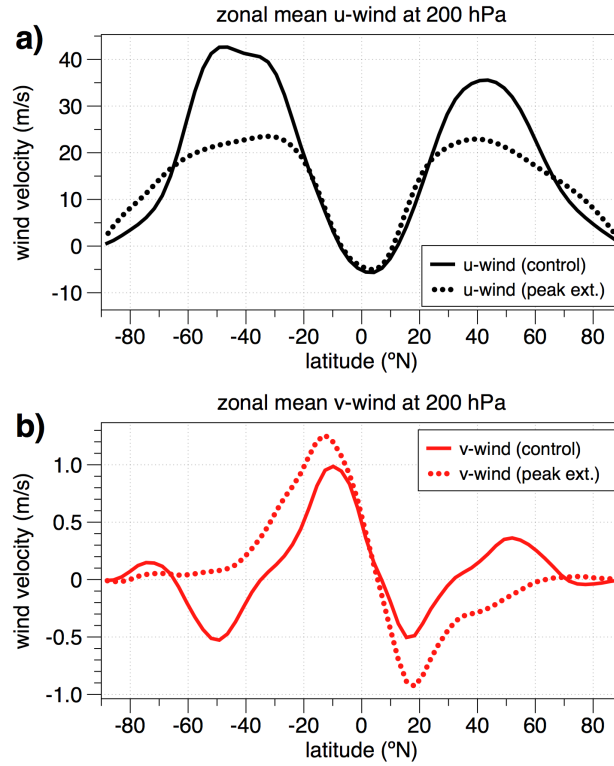

Figure 3.6: Zonal annual means of the wind fields at 200 hPa for **a**) the zonal (u) wind component and the **b**) meridional (v) wind component. Shown are the control simulation (solid line) and the simulation with maximum kinetic energy extraction (dotted line).

CHAPTER 3 JET STREAM WIND POWER EXTRACTABILITY

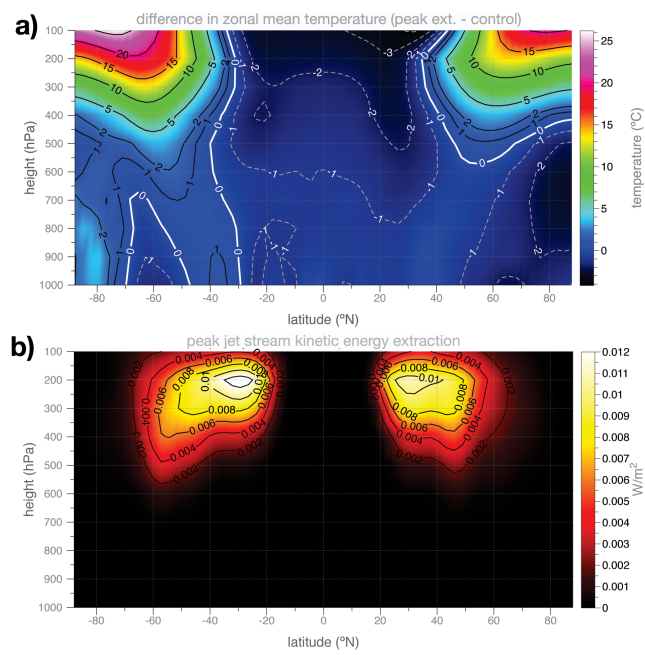

Figure 3.7: **a)** Difference in the zonal mean temperature **b)** The maximum extracted wind power for the 20 year mean is mainly derived from the southern hemisphere at a height of 200 hPa (≈ 10 km).

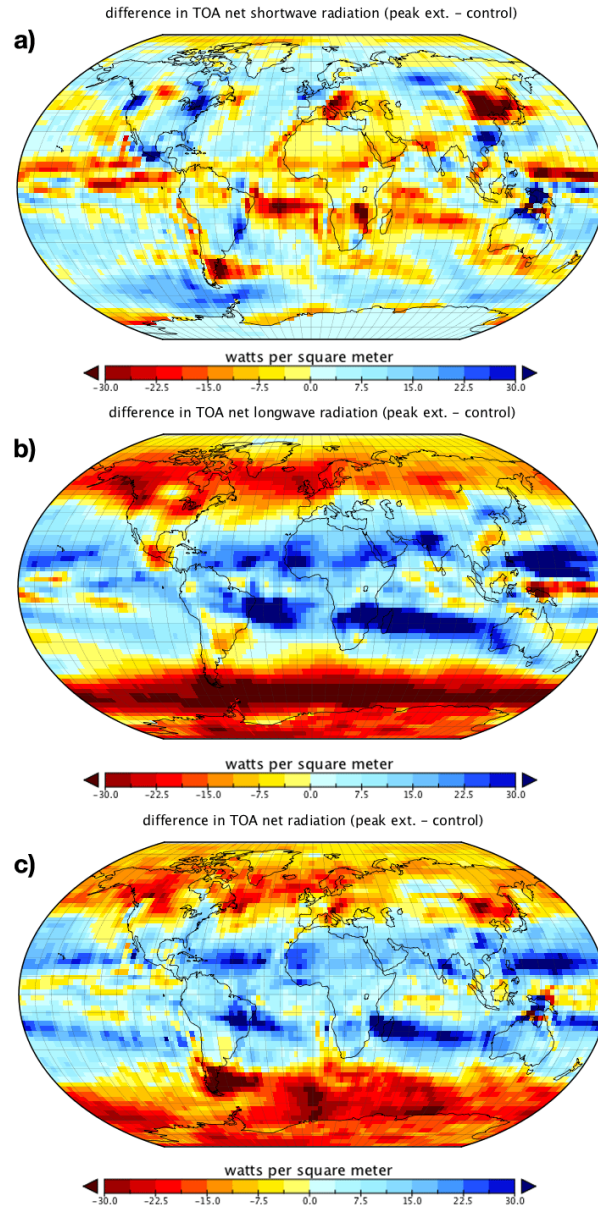

Figure 3.8: Net radiation differences between the peak extraction and control simulations at the top of the atmosphere for **a)** shortwave (solar) radiation, **b)** longwave (thermal) radiation, and **c)** net radiation. Note how the extraction of kinetic energy from the jet streams results in relatively small changes to the net shortwave radiation (**a)** but also corresponds to relatively large changes to the net longwave radiation (**b)** in response to the enhanced upper-atmospheric meridional heat transport to the poles. The overall difference at the top of the atmosphere is less net radiation in the tropics and more net radiation in the mid-latitudes and polar regions (**c)**.

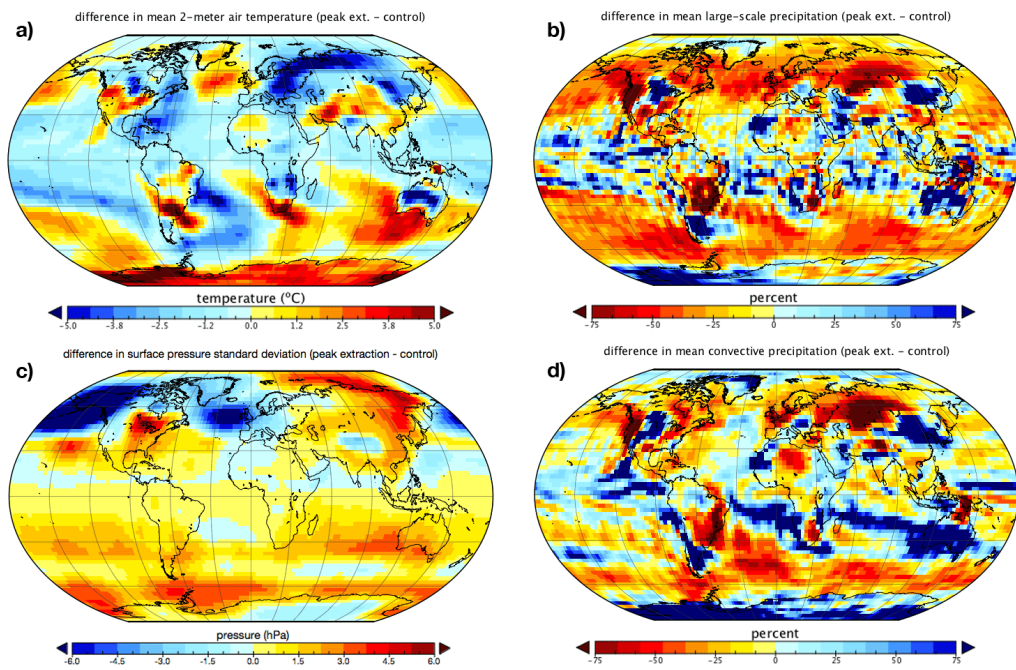

Figure 3.9: Mean 20-year simulation differences between the maximum jet stream wind power extraction and the control simulation with differences in **a)** 2-meter air temperature, **b)** large-scale precipitation, and **c)** surface pressure variability, and **d)** convective precipitation shown.

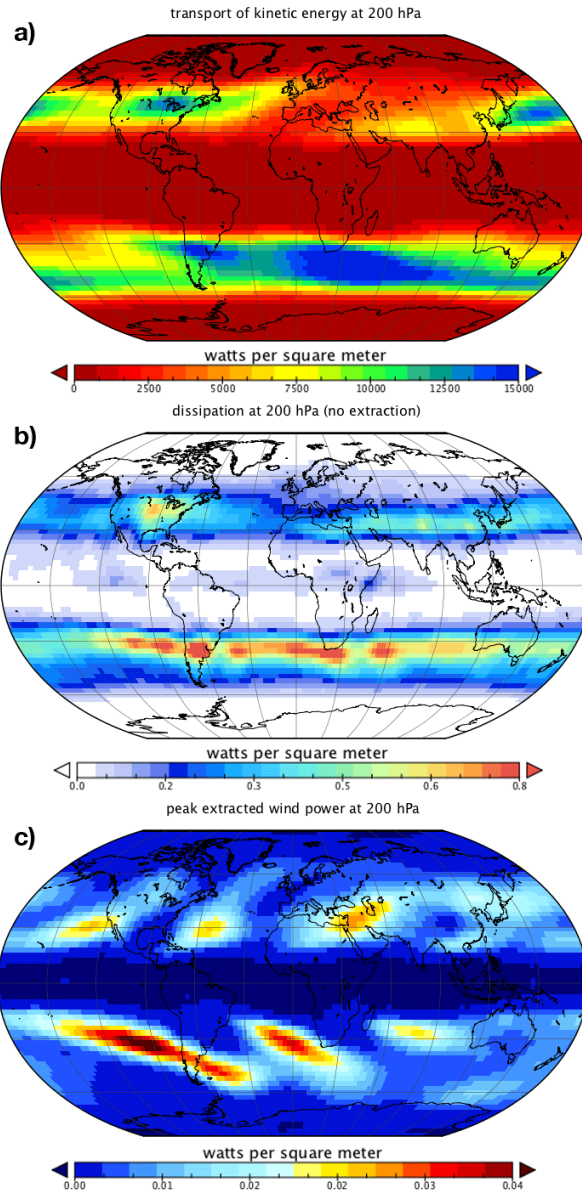

Figure 3.10: **a)** Mean transport of kinetic energy through a cross section at 200 hPa derived by $\frac{1}{2}\rho\vec{v}^3$ where ρ is the air density and \vec{v} is the wind velocity. **b)** The mean depletion (D_n) within the 200 hPa model layer due to momentum diffusion under control conditions and **c)** mean maximum extraction (P_{ext}) within the 200 hPa model layer.

Chapter 4

Solar and wind energy: same but different — why these differences matter for power potentials and climate impacts?

Solar and wind power are publicly regarded as infinite sources of energy, easily appropriated to satisfy all the current global energy demand and not associated with climate impacts. Scientifically, this cannot be true. In this analysis, we find that the current global human energy demand of 17 TW can be satisfied using either near-surface based wind power or surface based photovoltaic technologies (PV) on land, making $\approx 30\%$ the 'windiest' or 'sunniest' locations available to the respective technology. Sensitivity analyses for each technology were completed, allowing the simultaneous assessment of the extracted energy and associated climatic impact. The differences are profound. 18.2 TW of wind derived electricity required all of the prescribed 'windiest' land area, roughly equivalent to 5.5 continental United States' maximally populated with 319 million 2.0 MW turbines. Attempting to extract additional wind energy over this area, such as the the addition of more densely positioned wind turbines, then resulted in less extracted wind energy, similar to creating a new land surface of solid wind turbines. The maximum wind energy extraction rate also results in disruptions to normal atmospheric flow, with the atmosphere showing clear geographic differences in wind velocity, precipitation, heat fluxes, 2-meter air temperature, and net radiation. In contrast, an equivalent energy extraction rate using PV causes the general circulation model to estimate differences that are barely perceptible from the control simulation. Again, specific to this model's control simulation and prescribed available area, 16.7 TW of electricity was extracted by covering just less than 1% of the 'sunniest' areas with 20% efficient 5% reflective PV panels. While both the modeling methods and the technology parameterizations can be increased in complexity, this unavoidable dependency of energy extractability and

climatic impacts on present-day climate sustaining Earth System processes should be beyond scientific dispute.

4.1 Introduction

Schneider and Dennett (1975) stated, "...No energy producing system can be considered completely free of climatic side effects if it alters natural energy flow patterns." Situated just after the 1973 oil crisis, but before the second one in 1979, Schneider and Dennett (1975) are not directly referring to renewable energy technologies, but to a more general understanding of dependent Earth System processes. Still, after only a peripheral glance at photovoltaic panels or wind turbines, it is clear that each of these technologies must alter "...natural energy flow patterns." Although not all researchers would directly attribute climatic differences to select renewables (*e.g.* Archer & Caldeira (2009); Jacobson & Archer (2010a); Santa-Maria & Jacobson (2009)), they do exist Williams et al. (1977); Weingart (1977); Bach & Matthews (1979); Weingart (1979); Kirk-Davidoff & Keith (2008); Barrie & Kirk-Davidoff (2009); Baidya Roy (2010); Wang & Prinn (2010); Baidya Roy (2011); Miller et al. (2011); Wang & Prinn (2011).

Confronted with a reality where our fossil fuel emissions, our agricultural practices Pongratz et al. (2010), and potentially even our concentrated use of energy may be causing climatic differences Lovins (1974); Schneider & Dennett (1975); Williams et al. (1977), attributing renewables to climatic differences may appear both untimely and emotionally disappointing. Yet, different renewable energy technologies interact with existing Earth System processes differently (*e.g.* Goodenough (1976)), thereby presenting complications as well as potential opportunities to their large-scale deployment.

4.2 Estimating solar (PV) and wind power availability over land

4.2.1 The power hierarchy

The incoming solar radiation flux density at the top of the atmosphere is $\approx 342 \text{ W/m}^2$ Hartmann (1994) as shown in Figure 4.1. As the solar radiation penetrates the layers of the atmosphere, about 30% is reflected by clouds, dust, and the Earth's surface while an additional 20% is absorbed by the atmosphere Peixoto & Oort (1992). Due to Earth's geometry in relation to the Sun, the tropics (30°N to 30°S) are influenced by 120% of the global mean solar radiation while the geographic regions outside the tropics receive 80% of the global mean solar radiation Kleidon (2010). This is the position in the power hierarchy where photovoltaic technologies would interact with the Earth System — by assuming a maximum theoretical efficiency of a single band-gap photovoltaic cell of 31% Lewis (2007), one could estimate 106 W/m^2 of electricity production. This

4.2 ESTIMATING SOLAR (PV) AND WIND POWER AVAILABILITY OVER LAND

maximal PV production rate is dependent on a number of underlying criteria, such as minimal atmospheric influence. Progressing further down the hierarchy without the presence of PV, these differences in solar radiative heating result in about 86 W/m^2 being responsible for differential solar heating Kleidon (2010).

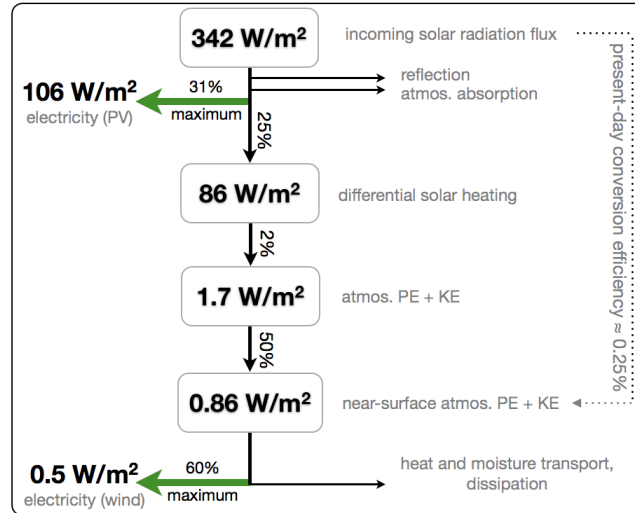

Figure 4.1: A simple representation of photovoltaic and wind power technologies deployed within the Earth System, presented as their position within the hierarchy of present-day natural system processes and assuming optimal values wherever necessary (*i.e.* PV conversion efficiency, maximum wind energy extraction rates)

Differential solar heating is responsible for driving the large-scale atmospheric circulation, with a maximum conversion efficiency of about 2% based on present-day Earth conditions Lorenz (1955, 1960). Of the potential energy (PE) and kinetic energy (KE) present in the atmosphere, about 50% is present in the atmospheric boundary layer Peixoto & Oort (1992). Assuming a very large-scale deployment of wind power technologies, no more than 59.3% of the kinetic energy can be extracted from the flow Lanchester (1915); Betz (1920) with more recent analysis of a tidal turbine channel suggesting 30% is actually closer to the maximum Garrett & Cummins (2007). This results in a mean of 0.5 W/m^2 of wind-derived electricity potential when deployed on a global scale and similar to the estimate of photovoltaic technologies, assumes several optimal assumptions to arrive at the estimate.

A number of conclusions can be derived by viewing this power hierarchy. First, note that present-day conditions on Earth result in 342 W/m^2 at the top of the atmosphere being transformed into about 0.86 W/m^2 of wind energy near the surface for a conversion efficiency of 0.25%. Also note the position within the hierarchy where photovoltaics

and wind power would compete with existing processes along with their relative quantities. Large-scale deployment of photovoltaics would alter the differential solar heating and all dependent processes, partially by the difference in reflectivity compared to the surface before installation and partially by the re-allocation of heat during the human utilization process. Large-scale wind power technologies may be responsible for altering atmospheric pressure gradients, but the competing process of radiative cooling prevents this gradient from resulting in additional atmospheric potential and kinetic wind energy. This was shown in Miller et al (2011) by the global decrease in atmospheric wind dissipation when near-surface wind power was deployed over all non-glaciated land surfaces for maximum extraction rates. Wind energy extraction also directly competes with heat and moisture transport within the atmosphere, and given the assumption that less total atmospheric wind energy will be available during large-scale extraction of wind energy, this additional restriction to the reallocation of heat and moisture may also result in climatic effects.

4.2.2 Conceptualizing climate impact consistency

Given the existing Earth System hierarchy (Figure 4.1), one could deduce that extracting one watt of incoming solar radiation at the surface will alter the system differently than extracting one watt of atmospheric motion near the surface. As a first step, assume extracting 0.03 W/m^2 (17 TW) of wind energy from the atmosphere is our goal. This rate of energy demand is consistent with the current global energy demand of 17 TW, roughly considers that a fully electric economy would require less total energy Jacobson & Delucchi (2010), and that the conversion efficiency from large-scale atmospheric motion to electricity is largely unknown. This quantity of 0.03 W/m^2 would represent about 4% of the original 0.86 W/m^2 that is continually generated and dissipated near the surface.

Now, accepting that differences in the specific climate dynamics will, at least in part, be related to the technology's vertical position within the hierarchy, a 4% extraction ratio in the midst of atmospheric absorption and reflection would be equivalent to 14 W/m^2 . This would also be in approximate agreement as to the ability of 14 W/m^2 being responsible for 0.03 W/m^2 of atmospheric motion. One immediate practical discrepancy to this comparison would be the geographic discrepancies between windy and sunny locations — they do not normally coincide.

This conceptualization ignores how each technology would alter its local atmospheric region. Due to the influence of turbine wake effects, large-scale wind power extraction would be heavily reliant on the contribution of upper-atmospheric potential and kinetic energy. Over land areas, this air will normally have a higher potential temperature, so when it is brought to equilibrium with the surface pressure, this air will cause an increase in local near-surface air temperature. These types of local influences suggest

4.2 ESTIMATING SOLAR (PV) AND WIND POWER AVAILABILITY OVER LAND

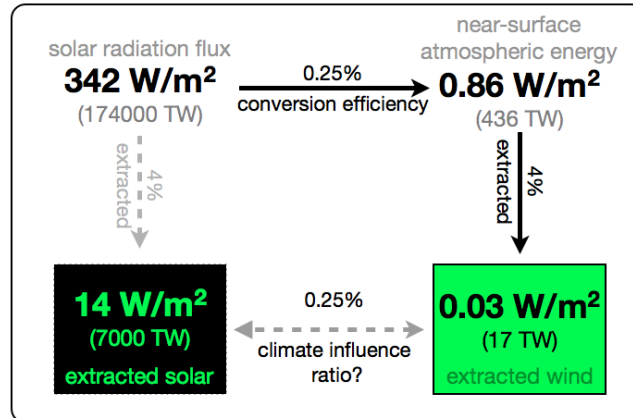

Figure 4.2: A conceptualized view on how an extraction of 14 W/m^2 (7000 TW globally) of solar radiation may be roughly equivalent to the extraction of 0.03 W/m^2 (17 TW globally) of atmospheric wind motion.

a possibility for downwind evaporation and related cloud effects.

Photovoltaic technology design is normally represented as a flat contiguous panel. Because of shading effects, photovoltaic 'farms' are only able to cover about 50% of the installation surface. This would certainly induce changes to how solar radiation and water are able to interact with the underlying surface. To achieve maximum efficiencies, panels are also routinely placed on one- or two-axis tracking systems, which alters the area proportions between the panels and the ground depending on the sun angle or azimuth while also the associated climate dependency on this dynamic surface reflectance.

4.2.3 Outline for this study

This paper is well-behind any "pre-design a climate with renewable energy" proposition. We first take a holistic view of the Earth System hierarchy to understand why much more solar energy than wind energy can be extracted. We then use this perspective to understand climatic differences, deciding that it is not the quantity of energy removed from the entire system but is rather related to the ratio of what is present in the system compared to what is extracted. The focus then shifts from a conceptual understanding to general circulation model parameterizations. The methods related to parameterizing photovoltaic and near-surface wind power technologies will be described. Through model sensitivity simulations, progressive differences in climate directly related to the deployed technology will then be presented. We close with a brief summary and conclusion.

4.3 Methods

To capture these induced dynamics of both renewable technologies on climate, we use PlaSim, an atmospheric general circulation model of intermediate complexity that explicitly simulates the generation and dissipation of kinetic energy Fraedrich et al. (2005); Lunkeit et al. (2007). We run the model with T42 spectral resolution, corresponding to a resolution of 2.8° longitude by 2.8° latitude, 10 atmospheric layers, a mixed-layer ocean model with prescribed oceanic heat transport, interactive sea-ice model, a simple land surface model, and prescribed ice sheets. Previous research shows that this model adequately captures the present-day climate and key sensitivities Fraedrich et al. (2005); Kleidon et al. (2006).

All simulations were run for 30 model years, with the last 10 years used in the analysis to exclude initial model spin-up effects. An initial "control" simulation without any additional wind or solar energy extraction was completed to estimate present-day climatic conditions. The 10-year mean control climate was used to identify preferential wind and solar energy extraction land areas.

4.3.1 Parameterizing surface wind

To identify our prescribed locations for large-scale wind power installations, we use the 10-year control simulation. As a first step, only those land grid points with mean wind velocities greater than 5m/s at the midpoint of the lowest of 10 model layers are considered. These points were then subset to exclude locations with $> 50\%$ glacier coverage (*e.g.* Antarctica, Greenland, Himalaya Mountains). Additional land-area restrictions related to topography, land use, and legal issues were not considered. This results in $4.21 \cdot 10^7 \text{ km}^2$ of development area as shown in Figure 4.3.

To simulate kinetic energy extraction, we implement the effects of wind turbines in a similar method as Keith et al. (2004) by modifying the commonly used surface drag parameterization in the lowest-altitude of the 10 model layers as:

$$F_{\text{drag}} = \rho (C_n |\vec{v}_1| + C_{\text{ext}} |\vec{v}_1|) \cdot \vec{v}_1 \quad (4.1)$$

where ρ is the air density, C_n is the volumetric drag coefficient for natural turbulence (which depends on surface roughness and atmospheric stability among other factors), \vec{v}_1 is the wind velocity, and C_{ext} is the additional volumetric drag coefficient to simulate kinetic energy extraction by wind turbines. This same parameterization was previously implemented for this general circulation model in Miller et al. (2011) and is very similar to other recent work by Wang & Prinn (2010, 2011). Natural dissipation within this model layer by turbulence (D) is given by:

$$D = \rho C_n v_l^3 \quad (4.2)$$

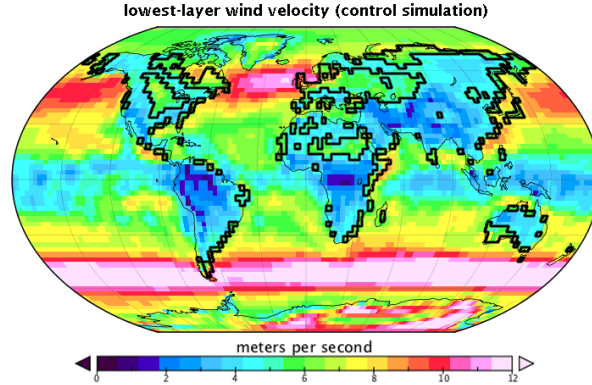

Figure 4.3: Mean wind velocity in the lowest model layer with areas designated for wind power extraction outlined in black

with extracted power by the wind turbines given by:

$$P_{ext} = \rho C_{ext} v_l^3 \quad (4.3)$$

In total, 18 simulations were completed for different values of $C_{ext} = [0.0 : 0.9]$. As previous research suggests that increases to the drag coefficient in the lowest model layer will result in an increase in the atmospheric boundary layer depth, this necessitates a clear definition of this atmospheric region — we will refer to the lowest of the 10 model layers as the control-region atmospheric boundary layer.

It is also important to differentiate between power extracted from the atmosphere (P_{ext}) and electrical power (P_{exte}). To some wind power researchers, the 59.3% conversion efficiency of Lanchester (1915); Betz (1920) may be considered too large while the 25% conversion efficiency of Wang & Prinn (2011) may be too small. Given the discrepancy at this time, we will use the Lanchester-Betz Limit but recognize that this may be found to be overly optimistic in the future.

To relate the drag coefficient (C_{ext}) to a wind turbine quantity, we use the same estimate method as Gans et al. (2010) who approximated the quantity of 2.0 MW Tjaereborg wind turbines (N_{turb}) as:

$$N_{turb} = \frac{2 \cdot 0.6 \cdot C_{ext} \cdot A_{land}}{C_f \cdot A_{rotor}} \quad (4.4)$$

where A_{land} is the area of land area available for extraction, C_f is the wind turbine capacity factor, assumed here to be 0.56, and A_{rotor} is the swept-area of the rotor blades, estimated here to be 2827 m^2 . A simple application would be when $C_{ext} = 0.0013$, that is approximately equal to 1.0 wind turbine per square kilometer of land (A_{land}).

4.3.2 Parameterizing photovoltaics

To identify our prescribed locations of the large-scale photovoltaics, we again use the 10-year control simulation. First, all land points with a mean surface solar radiation of $>195 \text{ W/m}^2$ were identified. These potential development areas were then reduced by requiring a Budyko-Lettau dryness ratio > 1.3 , calculated as $100 * R/P$ where R is the mean net surface radiation, and P is the mean total precipitation in the form of latent heat of condensation Budyko (1958, 1974); Lettau (1969). This additional subset step compared to developing the development area for wind energy extraction was used to not allocate areas such as the Amazon Rainforest to large-scale renewable development. Additional land-area restrictions related to topography, land use, and legal issues were not considered. These specifications result in $4.19 \cdot 10^7 \text{ km}^2$ of land area potentially available for photovoltaic development, shown as delineated areas in Figure 4.4.

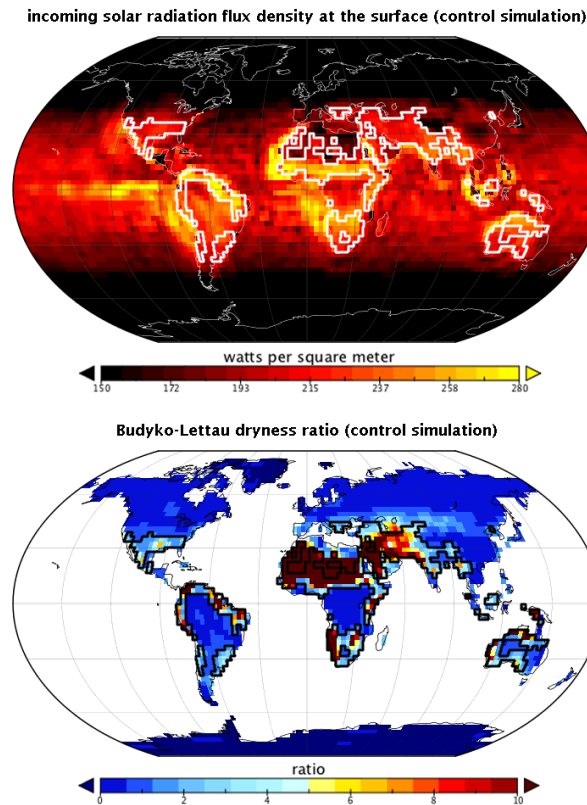

Figure 4.4: Mean surface solar radiation with photovoltaic regions outlined in white and the Budyko-Lettau dryness ratio with photovoltaic regions outlined in black

The photovoltaic panels will have the same slope and aspect of the underlying land

surface, so to simulate their effect on the Earth System, we modify the land surface dynamics related to the albedo (α_{dyn}) as:

$$\alpha_{dyn} = \alpha_{orig} \cdot (1 - PV_{cov}) + \alpha_{pv} \cdot PV_{cov} \quad (4.5)$$

where α_{orig} is the original albedo of the land surface, PV_{cov} is the coverage of the grid cell by photovoltaics, and α_{pv} is the albedo of the photovoltaic cell, here defined as 5% and the same as that used by Nemet (2009). To simulate the extraction rate of electrical power by the photovoltaic array (P_{ext_e}), we use:

$$P_{ext_e} = SW_{surf} \cdot (1 - \alpha_{pv}) \cdot PV_{cov} \cdot PV_{eff} \quad (4.6)$$

where SW_{surf} is the downwelling shortwave (solar) radiation at the land surface, and PV_{eff} is the photovoltaic efficiency of the panel in converting the solar radiation to electricity, here defined as 20% based on supporting research by Lewis (2007). In total 14 simulations were completed for $PV_{cov} = [0.0:0.04]$.

4.3.3 Quantifying climate differences

To identify and quantify climatic impacts from the PV or wind power deployment simulations, we use the mean values for the 10-year simulation. We quantify mean values by the area-weighted mean, calculated as: $\sum_n^1 (x_{simulation} - x_{control})$ where x is the climate variable under consideration. We also quantify differences related to their percent difference from the control simulation, quantified as:

$$\sum_n^1 \left(\frac{x_{simulation} - x_{control}}{x_{control}} \cdot 100 \right) \quad (4.7)$$

To provide a spatial component to these analyses, 3 areas were included in the restricted spatial analysis. Land values refer to any grid point with more than 50% land coverage. The 'solar area' and 'wind area' refer to the prescribed areas used in the photovoltaic and near-surface wind energy development simulations.

4.4 Results

4.4.1 Large-scale wind power potentials

The climate sensitivity of extractable wind power to the additional lowest-layer atmospheric drag (C_{ext}) is shown in Figure 4.5. With a value of $C_{ext} = 0.01$, 30.7 TW of mechanical wind energy is removed from the lowest model layer. The wind energy extraction parameterization does not include additional turbulence in the wake of the turbines, but all of the wind energy extracted from the atmosphere still cannot be converted to mechanical torque by the wind turbine. Assuming the optimistic 59.3%

conversion efficiency to mechanical turbine power and 100% conversion efficiency from mechanical to electrical power, the maximum estimated mean electricity production is 18.2 TW_e .

To continuously extract this amount of wind energy from the atmospheric system, the entire $4.21 \cdot 10^7 \text{ km}^2$ of available land area was utilized for maximum extraction. For comparison purposes, this total area is roughly equivalent to 121 Germanys or 5.5 contiguous United States'. Using Equation 4 and the maximum value for $C_{ext} = 0.01$, we can estimate that this represents the deployment of about 319 million 2.0 MW equally distributed wind turbines. As the intention was to use wind energy to compensate for the current global energy demand, which we later quantified as being nearly equivalent to the maximum extraction rate of wind energy from our prescribed area, the mean energy production from each 2.0 MW turbine of 57 kW_e is in itself interesting, but was not considered further.

This wind energy extraction rate near the surface must extract energy from other Earth System processes. At the maximum extraction rate, this is quantified as a 9.5% decrease (584 to 537 TW) in the control-region atmospheric boundary layer dissipation rate, a 2% increase (708 to 723 TW) in the control-region free atmospheric region, and spatial changes in net radiation at the top-of-atmosphere and surface (Figure 4.5).

4.4.2 Large-scale photovoltaic power potentials

The sensitivity of the extracted solar energy in relation to the coverage of photovoltaics (P_{cov}) is shown in Figure 4.5. It shows a mean of 16.7 TW_e is extracted by covering 0.8% of the initially available land area of $4.18 \cdot 10^7 \text{ km}^2$. The coverage area (*i.e.* 334000 km^2) is nearly equivalent to that of Germany or 4.4% of the contiguous land area of the United States. Note that in these model simulations, the photovoltaics are distributed equally throughout the available land area, seemingly resulting in very different climatic consequences than, for example, covering a centralized location with photovoltaics. As previously shown with wind energy extraction, photovoltaic power must also result in changes to other Earth System processes. Again, as a measure of the atmospheric generation rate of wind energy, the control-region boundary layer dissipation rate decreased about 1% (584 to 581 TW), as did the control-region free atmospheric region (707 to 706 TW). More subtle differences to the net radiation at the top of the atmosphere and at the surface can also be seen in Figure 4.5.

4.4.3 Comparing the differences in mean climate response

As conceptually illustrated by Figure 4.2, the extraction rate and 'hierarchy location' within the Earth System where energy is transformed and/or extracted by renewable energy technologies does approximate the climatic differences compared to the control simulation. Directly comparing the 2 renewable technologies, while the maximum wind

energy extraction rate of 0.79 W/m^2 within the prescribed wind extraction area is estimated to produce 18.2 TW_e of electricity (*i.e.* 30.7 TW extracted $\cdot 0.593$ (Lanchester-Betz Limit)), the photovoltaics extract 0.40 W/m^2 of downwelling shortwave radiation within the prescribed photovoltaic extraction area, assumed to be equivalent to the electricity production rate of 16.7 TW_e . Figure 4.6 shows the mean climate differences between these two electricity production simulations and the control simulation.

The 16.7 TW_e photovoltaic simulation did cause small changes to the atmospheric dynamics, but when the 18.2 TW_e wind simulation is compared using the same scale, the differences are clearly more pronounced in the simulation involving wind energy extraction. Spatially, the difference is easy to identify. When area-weighted mean values are quantified for the entire land area, prescribed solar area, and prescribed wind area, only the difference in wind velocity can be seen to diverge between the 2 renewable energy technologies. Instead, both photovoltaic and wind power appear to redistribute heat and moisture within the climate system. This was conceptually suggested in Figure 4.1 in reference to the required competition between wind energy extraction and present-day wind processes such as heat transport, moisture transport, and wind energy dissipation while it also appears true, to a lesser degree, for photovoltaics.

The center line plots of Figure 4.6 also show percent difference values, capturing spatial differences, while also illustrating the difference in climate response between very small extraction rates (*e.g.* 7% difference in precipitation with almost no wind or PV extraction) and the proportionally larger necessary extraction rates required to satisfy the current global energy demand.

4.5 Summary

From our perspective, extracting the equivalent of 17 TW of electricity from renewable Earth System processes is possible. Jacobson & Delucchi (2010) broadly state something very similar. The contrast between these two similar dialogs lies within the supporting details. While some recent research suggests the deployment of very large-scale renewable energy technologies such as wind power have negligible, if not insignificant, climatic impacts Santa-Maria & Jacobson (2009); Jacobson & Archer (2010a), we find direct links between energy extraction and climatic differences for both wind and photovoltaic technologies. In the case of wind energy, and in a similar manner to previous larger-scale wind energy research Miller et al. (2011), the presence of a maximum in wind energy extraction potential is determined by Earth System processes, not technological or engineering constraints. Additionally, once the realization that climatic differences are accepted as inevitable, how these climatic differences are influenced by the renewable technology and vice versa then becomes important. With the intention to simulate the production of $\approx 17 \text{ TW}$ of electricity, comparing the control simulation to the near-surface wind and photovoltaic (PV) deployment scenarios that are

able to produce electricity at this rate, the mean values for common climatic variables change very little but spatially, there are clear differences between the 2 technology deployments.

The wind energy simulation that produces 18.2 TW of electricity represents the maximum extraction rate of near-surface wind energy over an area equivalent to 5.5-times the area of the continental United States, or 100% of the prescribed 'windiest' areas based on our selection criteria. Through sensitivity analyses of additional drag, calculating at what rate wind energy extraction is optimally balanced by the altered atmospheric generation rate (due to the influence of the wind turbines as a momentum sink and the related climatic differences due of redistributing heat and moisture within the atmosphere). During this process, wind energy extraction is altering the distribution and energy partitioning of heat and moisture within the Earth System.

The photovoltaic simulation that produces 16.7 TW of electricity does not represent the maximum extraction rate possible, requiring an equivalent of 4% of the continental United States land area, or 0.8% of the prescribed 'sunny and dry' area based on our criteria. Again through sensitivity analyses of additional area coverage by 20% efficient 5% reflective photovoltaic panels, mean and percent difference quantifications were not readily discernible from the control simulation (Fig. 4.6 left and center). It was initially proposed that decreasing the albedo of the dry equatorial region may result in increased atmospheric energy, but potentially based on the coverage area being dispersed throughout the prescribed PV-study area, we did not find this atmospheric response.

4.6 Conclusions

A great deal of work regarding the comparison of various renewable technologies, both from a power potential and climatic consequence perspective, still demand a tremendous amount of research. Specific to this study and our focus on near-surface wind energy or photovoltaic-based solar energy, we ignored several important concepts:

- power intermittency, a significant hindrance to renewable-based energy sources Hoffert et al. (2002); Denholm & Margolis (2008)
- waste heat, either related to the electricity transmission losses Trieb et al. (2009) or the concentrated release of heat by human energy use and the potential influence on climate Lovins (1974); Schneider & Dennett (1975); Weingart (1977)
- material constraints for wind (*e.g.* United States Department of Energy (2008); Meibom et al. (2006)) and photovoltaics (*e.g.* Green (2006); Feltrin & Freundlich (2008))

- energy return on investment (EROI), suggesting that from strictly an energy-in to energy-out perspective and based on present-day atmospheric dynamics, wind energy with a EROI of 1:20 is currently a much more energy-sound investment than photovoltaics with a ratio of 1:7 Cleveland et al. (1984); Hall et al. (1986); Cleveland (2005); Murphy & Hall (2010); Kubiszewski (2010).

We view all these concepts as secondary to the question: **Can the current global energy demand be derived from near-surface wind energy or surface-based photovoltaic technologies?** This is not initially an engineering or technological problem that can be overcome with larger, more efficient wind turbines, or more reflective and efficient photovoltaic panels, but rather requires an entire Earth System perspective on what the energy quantities are before any type of extraction takes place. This provides an upper-bound to start from, about 174 000 TW for incoming solar power at the top of the atmosphere Hartmann (1994), through a series of transformation processes, resulting in about 900 TW of total atmospheric wind energy Lorenz (1955).

This natural hierarchy and the position from which energy is extracted from the system, such as near the top for photovoltaic-based power but near the bottom for wind power, then helps define a power potential and how different the resulting climate would be from the control if the same energy quantity was continually extracted from either system. The specific power potentials and climatic impacts are related to our prescribed scenarios and stated assumptions. Should one want to use renewables to account for the 17 TW of current global energy demand, we estimate that this can be done with either large-scale land-based wind- or photovoltaic-based power, but with the clear expectation that utilizing wind power will induce much different global climate dynamics than with photovoltaics. How we begin to deal with these energy-resource-policy considerations is yet unknown.

In this least, our hope is that this simple portrayal of wind and photovoltaic derived energy sources within the context of the Earth System reinforces the understanding of fundamental limits to extraction and the associated yet unavoidable climatic impacts. This should help reinvigorate historic renewable energy research from the 1970s which already included these considerations (*e.g.* Williams et al. (1977); Williams (1978); Bach & Matthews (1979); Gustavson (1979); Weingart (1979)), hopefully propelling us well beyond the 0.22% contribution ($0.037 TW_e$) Arvizu et al. (2011); Wiser et al. (2011) of power to the 2008 global human energy demand and into a more renewable, yet realistically educated future.

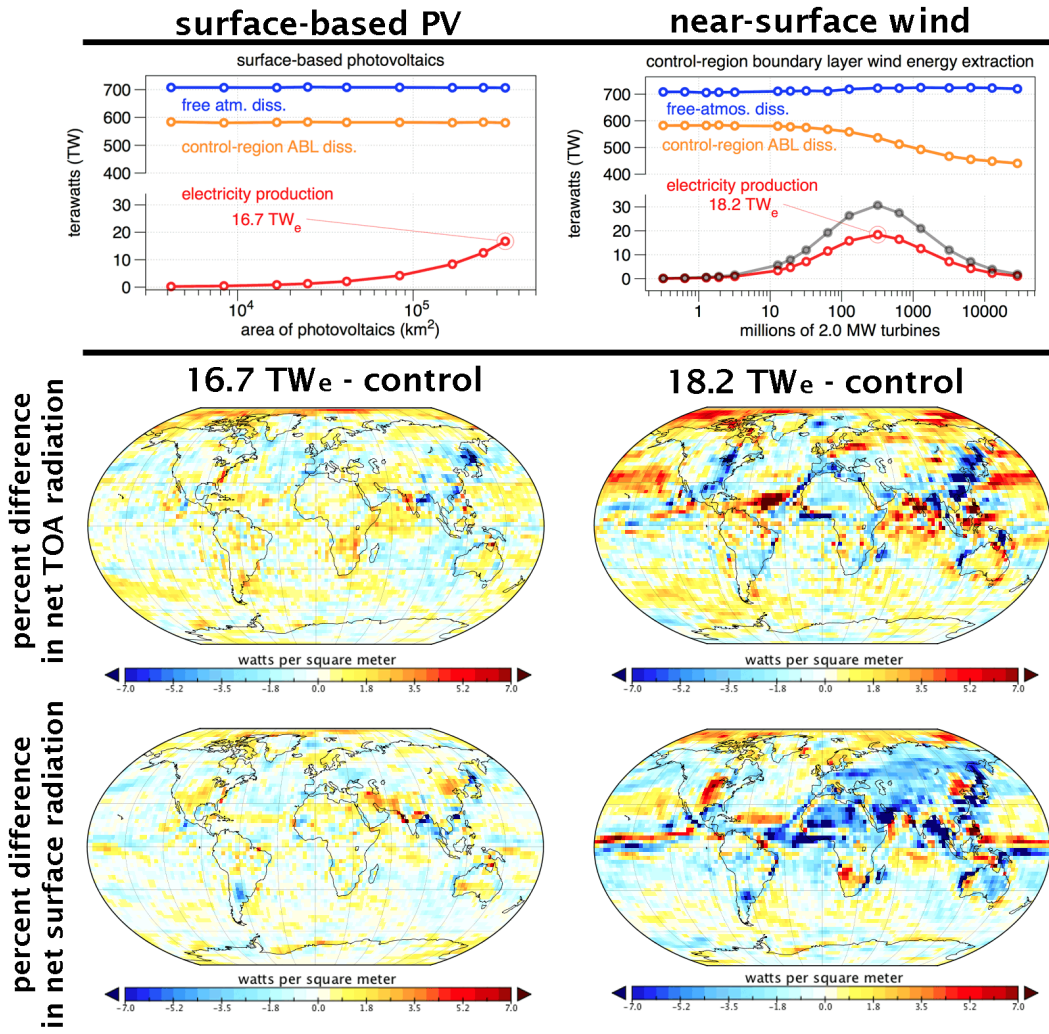

Figure 4.5: In the top plots, dissipation rates electricity production rates are shown in relation to the photovoltaic coverage area (left) or millions of estimated wind turbines (right). Note that the gray line in the wind energy extraction plot shows the quantity of wind energy removed from the atmosphere, converted to electricity by assuming a conversion efficiency of 59.3%. The lower 4 maps show the percent difference in net radiation at the top-of-atmosphere (TOA) and for the surface.

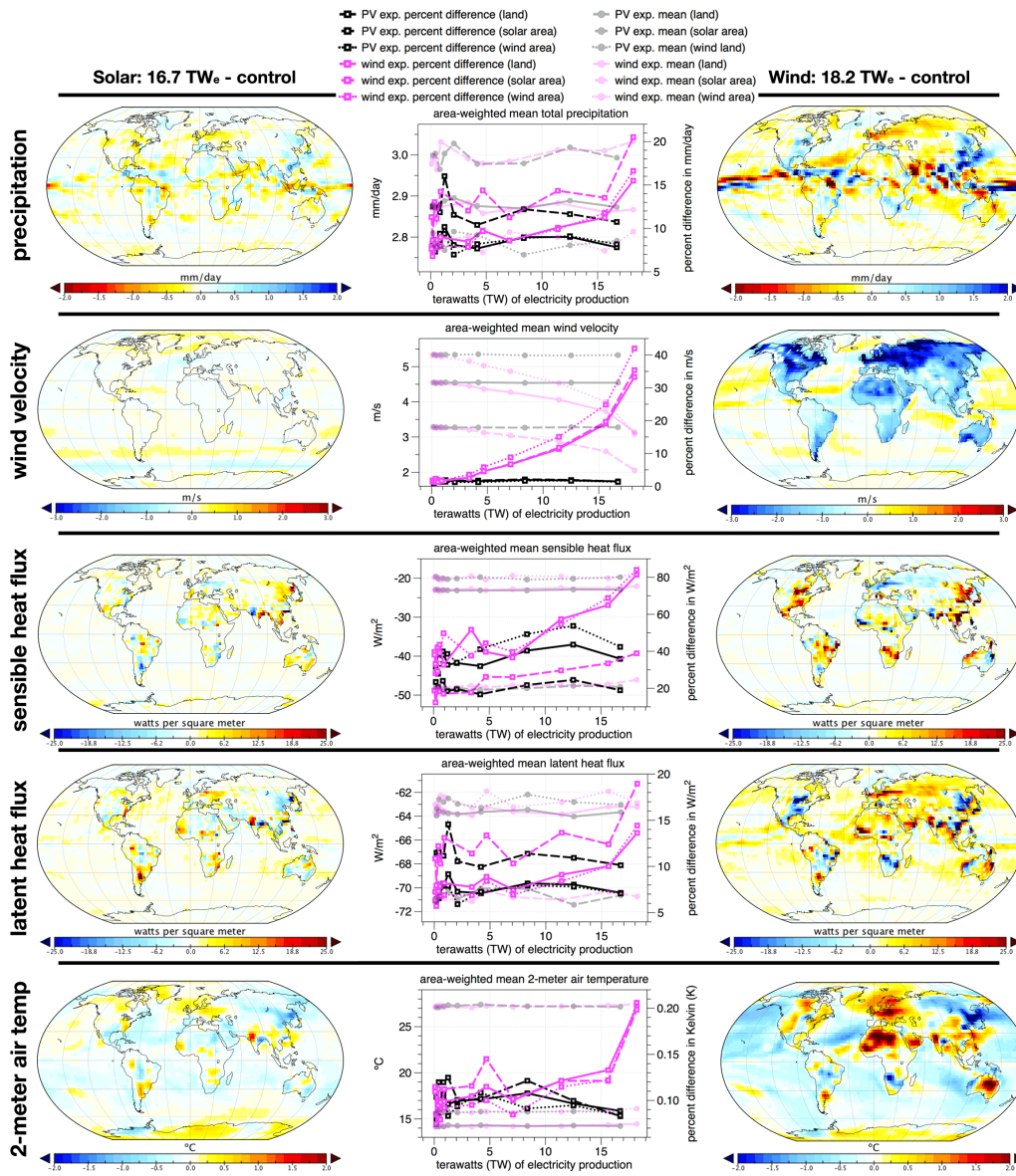

Figure 4.6: Difference maps for the the photovoltaic power simulation with 16.7 TW_e and the control simulation (left), peak wind power simulation with 18.4 TW_e and control simulation (right), and the intermediate sensitivity simulations showing area-weighted mean values for 3 different spatial areas and percent difference values for the same 3 spatial areas (center). Note that for 2-meter temperature, mean values are shown in Celsius while percent difference values are shown in Kelvin.

Chapter 5

Conclusion and Future Research

The aim of the present study was to assess the implications of applying a holistic Earth System perspective to 3 selected renewable energy technologies. Through this 'top-down' rather than 'bottom-up' perspective, recent estimates regarding power potentials and the near-lack of climatic consequences at extraction rates of 100s to 1000s of terawatts were explicitly challenged. Using a variety of increasingly complex methods, we are not only open about the range of derived estimates, but also frame them from the viewpoint of understanding the interacting Earth System processes rather than focusing on the precision of one technique over another. Here, we will first summarize the main results of the study originally posed in the introduction and then give an outlook of possible directions for future research.

5.1 Summary

- (1) Why are the estimates for the maximum extraction rates so different?

The differences are related to the consideration of time. Although many previous large-scale estimates use wind velocity as a proxy for wind power (Jacobson & Masters 2001; Archer & Jacobson 2005, 2007; Archer & Caldeira 2009; Lu et al. 2009; Santa-Maria & Jacobson 2009; Jacobson & Delucchi 2010), this basis would suggest that by building larger turbines, increasing turbine density, and/or increasing efficiencies, one could continually extract more and more wind-derived power. Using $\frac{1}{2}\rho v^3$ modified with specific turbine characteristics, these estimates are actually quantifying the kinetic energy flux through the turbine blades' cross-sections. This could be envisioned by imagining an atmosphere instantly populated with the maximum number of wind turbines, extracting all of the kinetic wind energy within 1 second. At the end of this second, all the kinetic wind energy has been removed. Then, the limit to continuous extraction by these turbines is limited by the ability of Earth System processes to generate wind energy. In this way, wind velocities, regardless of their precision or resolution, cannot be directly related to estimating the maximum continuous large-scale wind energy extraction rate. This same confusion, along with the lack of consideration for the

climatic consequence of extraction, also forms the foundation for the discrepancy in jet stream wind power estimates (*e.g.* Fig. 3.10).

- (2) Are there different ways to estimate these maximum extraction rates with some agreement in the estimates?

A number of different methods were used in this study, especially to estimate maximum near-surface wind energy extraction over land. First, a simple back-of-the-envelope estimate (Fig. 2.1) was used to be clear about the hierarchy of interacting processes, resulting in an estimate of 68 TW of maximum wind energy extraction. Then, a simple model using reanalysis data was developed, including the influence of additional turbines on atmospheric flow, resulting in an estimate of 21 TW (Fig. 2.3). Finally, a suite of GCM simulations were conducted with T21 and T42 spectral resolution and 10 or 20 vertical levels with resulting estimates ranging from 18-34 TW (Fig. 2.5). This general agreement is clear about the range of estimates that is possible but also helps refine estimates based on their dependency of the hierarchy of Earth System processes.

- (3) How would the global atmosphere respond to continental-scale near-surface wind energy extraction?

The extraction of kinetic energy from the atmosphere will first cause a decrease in the wind velocity at the level of the wind turbines. This change in the wind profile helps to entrain upper-atmospheric momentum towards the level of extraction. This upper-atmospheric air is typically warmer and drier when brought to equilibrium with the near-surface atmospheric pressure, increasing the latent heat flux gradient and decreasing the sensible heat flux gradient. With the assumption that the downwind region is not moisture limited, this results in an increased latent heat flux from the surface to the atmosphere. Further downwind, the availability of vertically advected moisture will alter the net radiation and precipitation rates. These alterations to the energy balance partitioning of net radiation to sensible and latent heat fluxes are difficult to differentiate using large-scale means (Table 2.2, Fig. 4.6) but are visible when viewed geographically (Fig. 4.5, 4.6) or using more advanced analysis metrics (Figs. 2.7, 2.9, 4.6).

- (4) Could the global generation rate of wind energy be altered with these large-scale deployments?

Yes. Under the assumption that the generation rate is equivalent to the dissipation rate in the climatic steady state, this can be shown to occur for near-surface wind energy extraction over all non-glaciated land using the simple model (Fig. 2.3) and

the GCM for multiple resolutions (Fig. 2.5). The extraction process of kinetic energy from the jet streams also causes a decrease in the global generation rate of wind energy (Fig. 3.4 & Table 3.1). A decrease in the generation rate was also shown to occur with large-scale near-surface wind energy extraction from prescribed modeled regions with wind velocities greater than 5 m/s (Fig. 4.5). These alterations to the generation rate not only influence subsequent wind energy extraction rates but also alter existing wind-transport processes such as heat and moisture transport.

- (5) How does a 'top-down' estimate of jet stream wind energy extractability differ from the previous estimate by Archer & Caldeira (2009) regarding power potential and/or climatic impacts?

The 'top-down' view on jet stream wind energy extractability didn't help to specifically refine the estimate, but rather identified some problem in the previous estimate because the suggested estimate was larger than the total atmospheric generation rate. This view also helped to understand, through a simple thought experiment, that the rate of momentum diffusion into and out of the jet streams actually defines the generation rate and therefore the unattainable upper-bound to energy extractability. Through this new understanding and GCM simulations, the previous estimates were reproduced using $\frac{1}{2}\rho\bar{v}^3$ where ρ is the air density and \bar{v} is the wind velocity, but also compared to the mean energy depletion rate of the control simulation's jet stream regions and the simulation representing the maximum extraction rates (Fig. 3.10). These differences in the calculation resulted in a maximum wind energy extraction estimate ≈ 200 -times less than that of Archer & Caldeira (2009) along with unavoidable climatic impacts that differ substantially from the control simulation such as a 36% decrease (1219 TW to 777 TW) in atmospheric wind energy and upper-atmospheric temperature increases of more than 20 °C in both high-altitude polar atmospheres (Fig. 3.6, 3.7, 3.8, 3.9).

- (6) Would extracting solar energy (*e.g.* photovoltaic technology) result in more energy per unit surface area compared to its indirect form, wind energy?

This would depend on the extraction efficiency of the 2 technologies, but generally, yes. The global mean energy flux density of solar radiation of $\approx 342 W/m^2$ at the top of the atmosphere is influenced by atmospheric absorption, atmospheric reflection, and differential solar heating resulting in about 86 W/m^2 of downwelling surface solar radiation at the surface and about 1 W/m^2 of kinetic wind energy in the atmospheric boundary layer (Hartmann 1994; Peixoto & Oort 1992). This natural transformation hierarchy of incoming solar radiation \rightarrow differential solar heating \rightarrow atmospheric wind energy \rightarrow near-surface wind energy cannot be circumvented and based on thermodynamics, dictates that each successive transformation results in less available free energy

(Fig. 4.1). This hierarchy forms the basis for estimating first-order energy extractability. Where near-surface wind energy only has about 1 W/m^2 initially available for potential extraction, photovoltaics are influenced by at least 86 W/m^2 for potential extraction. This makes statements such as jet stream wind energy being "...the highest concentration of renewable energy in large quantities" p.564 (Vance 2009) seeming to violate our understanding of thermodynamics and the resulting hierarchy of Earth System processes.

- (7) Assuming an equivalent energy extraction rate from the Earth System from either photovoltaics or wind energy, how are the climatic impacts different?

Neglecting the contribution of waste heat in both cases, the location of these 2 technologies within the energy transformation hierarchy (Fig. 4.1) suggests the climatic impacts will be quite different (Fig. 4.2). In the GCM simulations comparing an equivalent available land area for development to produce the same quantity of electricity, climatic differences resulting from large-scale photovoltaics were barely detectable (Fig. 4.5 & 4.6 left) while large-scale near-surface wind energy extraction caused dramatic climatic differences compared to the control simulation (Fig. 4.5 & 4.6 right). We theorize, although this has not been clearly proven, that the ratio of *energy availability rate / energy extraction rate* gives a closer approximation to the overall differences in climatic impacts although this requires further research and is at least in part related to the climate metric selected to quantify change (*e.g.* wind velocity, precipitation rates, albedo).

5.2 Possible Directions of Future Research

Our calculations have helped clarify the response of the Earth System to large-scale near-surface wind energy extraction, global jet stream wind energy extraction, and the large-scale deployment of photovoltaics (PV). Not only are there finite limits to extraction for all renewable technologies, but they also all cause changes to the climate system. Given the current disparity in the scientific literature related to this very topic, continued work on the parameterization of renewable technologies such as near-surface wind and photovoltaics, within various general circulation models and in several different spatial configurations should certainly be completed. Additionally, the spatial expanse of large wind and PV farms is just beginning to encompass a cooperative size as to allow a detailed network of field measurements to refine and/or verify larger scale modeled estimates. The intercomparison between regional and global scale simulations for specific consistent scenarios should also be completed.

With studies related to energy return on investment (EROI) suggesting that present-day wind technologies are capable of delivering much more energy during their lifetime

than is required for their manufacture and installation compared to photovoltaics (20:1 for surface-based wind turbines compared to 7:1 for PV), additional wind energy from the 'middle-altitudes' also seems worth exploring further. The temporal, geographic, and seasonal complexities of utilizing this additional wind resource are presently not identified, but the presence of a renewable 'middle-altitude' wind resource of the same quantity as that of the boundary layer does exist.

This study also did not include all potentially large renewable resources or technologies. Quantifying the fundamental limits to extraction for ocean thermal energy conversion (OTEC) in a similar 'simple model' framework employed by this study has already been completed by Nihous (2005) but the biological and climate considerations related to increasing the vertical fluxes of the ocean in select geographic locations remains unexplored. This assessment for OTEC impacts could be easily completed within a GCM with a coupled ocean. Concentrated solar power (CSP) also deserves more research, as the ability to differentiate between direct and diffuse solar radiation has just been included in recently released GCMs. As with the other renewables, the climatic consequences of large-scale CSP also requires further exploration.

Potentially coinciding or separate from renewable energy research, the 2009 global human energy demand of 17 TW (EIA 2011) is being released into the atmosphere with currently unknown climatic impacts (Lovins 1974; Schneider & Dennett 1975) and to our knowledge, is not included in any GCM simulation. This may in fact even be a moot point at the moment and possibly even with a human energy demand exceeding 100 TW, estimated as possible by 2100 by IPCC (2008). Still, this increase in the waste heat release must eventually result in climatic impacts. It would certainly deserve to be included in a modeling study that considers a global human energy demand of 100s of terawatts, regardless of whether this energy is renewably extracted from the Earth System or derived from fossil fuel or nuclear resources.

All of these future research topics in some way suggest how human actions may alter the climate system. While publicly regarded as 'green' technologies without climatic consequences, this renewed and enhanced understanding regarding the impact of renewable technologies should not be identified as good or bad. Throughout this study, we have strived to not place this value judgement on these changes, as the renewables simply cause *differences* in the climate dynamics. The next possible, but politically complicated step, could then be 'climate optimization,' where a specific renewable energy technology is selected for not only producing renewable power, but also preferential climatic differences (*e.g.* warmer or wetter conditions). This specific renewable energy installation may also have influences on the generation rate of the resource and climate at regional, continental, and potentially even global scales. How this is perceived and implemented will certainly perplex researchers for decades, but the computer models and initial understanding of how to parameterize various renewable technologies to begin this analysis are available now.

Bibliography

- American Meteorological Society, Glossary of Meteorology.
<http://amsglossary.allenpress.com/glossary/search?p=1&query=jet+stream&submit=Search> accessed on May 24, 2011, 1999
- American Wind Energy Association, 20 percent wind energy penetration in the United States: a technical analysis of the energy resource. *Black & Veatch B&V project number 144864*, 2007
- Archer C L, Jacobson M Z, Spatial and temporal distributions of U.S. winds and wind power at 80 m derived from measurements. *J. Geophys. Res.* **108 (D9)**, 4289, doi:10.1029/2002JD00207, 2003
- Archer C L, Jacobson M Z, Evaluation of global wind power. *J. Geophys. Res.* **110** D12110, doi:10.1029/2004JD005462, 2005
- Archer C L, Jacobson M Z, Supplying baseload power and reducing transmission requirements by interconnecting wind farms. *J. Appl. Meteorol.* **46**, 1701-1717, doi:10.1175/2007JAMC1538.1, 2007
- Archer C L, Caldeira K, Global assessment of high-altitude wind power. *IEEE Trans. Energy Convers.* **2**, 307-319, 2009
- Arvizu D, Bruckner T, Edenhofer O, Estefen S, Faaij A, Fishedick M, Hiriart G, Hohmeyer O, Hollands K G T, Huckerby J, Kadner S, Killingtveit A, Kumar A, Lewis A, Lucon O, Matschoss P, Maurice L, Mirza M, Mitchell C, Moomaw W, Moreira J, Nilsson L J, Nyboer J, Pichs-Madruga R, Sathaye J, Sawin J, Schaeffer R, Schei T, Schlömer S, Seyboth K, Sims R, Sinden G, Sokona Y, von Stechow C, Steckel J, Verbruggen A, Wiser R, Yamba F, Zwickel T, *2011: Technical Summary. In IPCC Special Report on Renewable Energy Sources and Climate Change Mitigation* [Edenhofer O, Pich-Madruga R, Sokona Y, Seyboth K, Matschoss P, Kadner S, Zwickel T, Eickemeier P, Hansen G, Schlmer S, von Stechow C. (eds)], Cambridge University Press, Cambridge, United Kingdom and New York, NY, USA, 2011
- Bach W, Matthews W H, Exploring alternative energy strategies, *Energy* **4** 711-722, 1979

BIBLIOGRAPHY

- Baidya Roy S, Impacts of wind farms on surface air temperatures, *P. Natl. Acad. Sci. USA*, **107** 42, 17899-17904, 2010
- Baidya Roy S, Simulating impacts of wind farms on local hydrometeorology, *Journal of Wind Engineering and Industrial Aerodynamics*, **99** 4, 491498, 2011
- Barrie D, Kirk-Davidoff D, Weather response to management of a large wind turbine array, *Atmospheric Chemistry and Physics*, **10**, 769–775, 2010
- Battisti R, and Corrado A, Evaluation of technical improvements of photovoltaic systems through life cycle assessment methodology. *Energy* **30** 952-967, 2005
- Bergmann J C, Interactive comment on "Estimating maximum global land surface wind power extractability and associated climatic consequences" by L.M. Miller et al., (Earth Syst. Dynam. Discuss., 1, 169-189, doi:10.5194/esdd-1-169-2010, 2010) *Earth Syst. Dynam. Discuss.* **1**, C96–C100, 2010
- Betz A, The maximum of theoretically available potential of wind by wind turbines. (originally German) *Z. Gesamte Turbinenwesen.* **26**, 1920
- Blackman C, High-altitude winds: the greatest source of concentrated energy on Earth. *Stanford University News* <http://news.stanford.edu/news/2009/june24/high-altitude-winds-062309.html>, 2009
- Budyko M I, The heat balance of the earths surface, U.S. Dept of Commerce, Washington, 1958
- Budyko M I, Climate and Life, Academic Press, N. Y., USA, 1974
- Calaf M, Meneveau C, Meyers J, Large eddy simulation study of fully developed wind-turbine array boundary layers, *Phys. Fluids.* **22** 015110, 2010
- Canale M, Fagiano L, Milanese M, KiteGen: a revolution in wind energy generation, *Energy* **34** 355-361, 2009
- Christiansen M B, Hasager C B, Wake effects of large offshore wind farms identified from satellite SAR. *Remote Sensing of Environment*, 98(2-3), 251268, 2005
- Cleveland C J, Costanza R, Hall C A S, Kaufmann R, Energy and the U.S. economy: a biophysical perspective. *Science* **22** 890897, 1984
- Cleveland C J, Net energy from oil and gas extraction in the United States, 1954-1997. *Energy* **30** 769782, 2005
- Denholm P, Margolis R M, Land-use requirements and the per-capita solar footprint for photovoltaic generation in the United States. *Energy Policy* **36** 3531-3543, 2008

- European Centre for Medium Range Forecasting, The ERA-40 archive, *European Centre for Medium Range Forecasting*, 2004
- Edenhofer O, Pich-Madruga R, Sokona Y, Seyboth K, Matschoss P, Kadner S, Zwickel T, Eickemeier P, Hansen G, Schlmer S, von Stechow C, 2011: *Technical Summary. In IPCC Special Report on Renewable Energy Sources and Climate Change Mitigation* Cambridge University Press, Cambridge, United Kingdom and New York, NY, USA, 2011
- Energy Information Administration, International energy outlook 2010. *United States Department of Energy - Energy Outlook Administration*, 2010
- Energy Information Administration, International energy statistics. United States Department of Energy - Energy Outlook Administration. <http://www.eia.gov/cfapps/ipdbproject/IEDIndex3.cfm?tid=44&pid=44&aid=2> accessed on July 6, 2011., 2011
- European Environment Agency, Europe's onshore and offshore wind energy potential. *European Environment Agency*. ISSN 1725-2237, 2009
- European Wind Energy Association, Oceans of opportunity: harnessing Europe's largest domestic energy resource. *European Wind Energy Association*, 2009
- Feltrin A, Freundlich A, Material considerations for terawatt level development of photovoltaics, *Renewable Energy* **33** 180-185, 2008
- Fraedrich K, Jansen H, Kirk E, Luksch U, Lunkeit F, The planet simulator: towards a user friendly model. *Meteorologische Zeitschrift*. **14**, 299-304, 2005
- Gans F, Miller L M, Kleidon A, The problem of the second wind — a note on common but flawed wind power estimation methods, *Earth Syst. Dynam. Discuss.* **1**, 168-189, 2010
- Garrett C, Cummins P, The efficiency of a turbine in a tidal channel. *J. Fluid Mech.* **588**, 243-251, 2007
- Goodenough J B, The options for using the sun. *Tech. Rev.* **79** 63-71, 1976
- Green M S, Consolidation of thin-film photovoltaic technology: the coming decade of opportunity. *Prog. Photovolt: Res. Appl* **14** 383-392, 2006
- Gustavson M R, Limits to wind power utilization. *Science* **204**, 13-17, 1979
- Hall C A S, Cleveland C J, Kaufmann R, Energy and Resource Quality: The Ecology of the Economic Process. Wiley. New York, 1986

BIBLIOGRAPHY

- Hall, C A S, Balogh S, Murphy D J, What is the minimum EROI that a sustainable society must have? *Energies* **2** 2547, 2009
- Hartmann D L, Global physical climatology. San Diego, CA: Academic Press; 1994.
- Hernández-Deckers D, von Storch J S, Energetic responses to increases in greenhouse gas concentrations, *J. Climate*, **23**, 3874-3887, 2010
- Hoffert M I, Caldeira K, Benford G, Criswell D R, Green C, Herzog H, Jain A K, Kheshgi H S, Lackner K S, Lewis J S, Lightfoot D, Manheimer W, Mankins J C, Mauel M E, Perkins J, Schlesinger M E, Volk T, Wigley T M L, Advanced Technology Paths to Global Climate Stability: Energy for a Greenhouse Planet, *Science* **298** 981, 2002
- Intergovernmental Panel on Climate Change. Contribution of Working Group III to the Fourth Assessment Report of the Intergovernmental Panel on Climate Change, Cambridge University Press, Cambridge, United Kingdom and New York, NY, USA, 2007
- Intergovernmental Panel on Climate Change. IPCC scoping meeting on renewable energy sources - proceedings, 2008
- Jacobson M Z, Masters G M, Exploiting wind versus coal, *Science*, **293**, 5534, 1438, 2001
- Jacobson M Z, Archer C L, Comment on Estimating maximum global land surface wind power extractability and associated climatic consequences, by L.M. Miller, F. Gans, and A. Kleidon (Earth Syst. Dynam. Discuss., 1, 169-189, doi:10.5194/esdd-1-169-2010, 2010), *Earth Syst. Dynam. Discuss.* **1**, C84–C85, 2010a
- Jacobson M Z, Archer C L, Interactive comment on "Estimating maximum global land surface wind power extractability and associated climatic consequences" by L.M. Miller et al., (Earth Syst. Dynam. Discuss., 1, 169-189, doi:10.5194/esdd-1-169-2010, 2010) *Earth Syst. Dynam. Discuss.* **1**, C101–C103, 2010b
- Jacobson M Z, Archer C L, Reply to D.B. Kirk-Davidoff. on (Earth Syst. Dynam. Discuss., 1, 169-189, doi:10.5194/esdd-1-169-2010, 2010) *Earth Syst. Dynam. Discuss.* **1**, C112, 2010c
- Jacobson M Z, Delucchi M A, Providing all global energy with wind, water, and solar power, part 1: technologies, energy resources, quantities and areas of infrastructure, and materials, *Energy Policy*, **39** 1154-1169, 2010

- Keith D, DeCarolis J F, Denkenberger D C, Lenschow D H, Malyshev S L, Pacala S, Rasch P J, The influence of large-scale wind power on global climate. *Proc. Natl. Acad. Sci* **101** 16115-16120, 2004
- Kirk-Davidoff D, Keith D, On the climate impact of surface roughness anomalies. *J. Atmos. Sci.* **65** 2215-2234, 2008
- Kirk-Davidoff D, Interactive comment on "Estimating maximum global land surface wind power extractability and associated climatic consequences" by L.M. Miller et al., (Earth Syst. Dynam. Discuss., 1, 169-189, doi:10.5194/esdd-1-169-2010, 2010) *Earth Syst. Dynam. Discuss.* **1**, C90–C93, 2010
- Kleidon A, Fraedrich K, Kunz T, Lunkeit F, The atmospheric circulation and states of maximum entropy production, *Geophys. Res. Lett.*, **30**, 2223, 2003
- Kleidon A, The climate sensitivity to human appropriation of vegetation productivity and its thermodynamic characterization, *Glob. Planet. Ch.*, **54**, 109-127, 2006
- Kleidon A, Fraedrich K, Kirk D, Lunkeit F, Maximum entropy production and the strength of the boundary layer exchange in an atmospheric general circulation model, *Geophys. Res. Lett.*, **33**, L06706, 2006
- Kleidon A, Life, hierarchy, and the thermodynamic machinery of planet Earth. *Physics of Life Reviews* **7**, 424-460, 2010
- Kubiszewski I, Cleveland C J, Endres P K, Meta-analysis of net energy return for wind power systems. *Renewable Energy* **35**. 218-225, 2010
- Lanchester F W, A contribution to the theory of propulsion and the screw propeller. *Trans. Inst. Naval Archit.* **LVII** 98-116, 1915
- Lettau H, Evapotranspiration climatology: I. A new approach to numerical prediction of monthly evapotranspiration, run-off and soil moisture storage, *Mon. Wea. Rev.*, **97**, 691-699, 1969
- Lewis N, Toward cost-effective solar energy use. *Science*. **315** 798-801, 2007
- Lorenz E, Available potential energy and the maintenance of the general circulation, *Tellus*, **7**, 271-281, 1955
- Lorenz E, Generation of available potential energy and the intensity of the global circulation, *Dynamics of Climate*, Pergamon Press, Oxford, UK. pp. 86-92, 1960
- Lorenz R, Lunine J, Withers P, McKay C, Titan, Mars, and Earth: entropy production by latitudinal heat transport, *Geophys. Res. Lett.*, **28**, 415-418, 2001

BIBLIOGRAPHY

- Lovins, A B, Thermal limits to world energy-use. *B. Atom. Sci.*, 1974
- Li L, Ingersoll A P, Jiang X, Feldman D, Yung Y L, Lorenz energy cycle of the global atmosphere based on reanalysis datasets. *Geophys. Res. Lett.* **34** L16813, doi:10.1029/2007GL029985, 2007
- Lu X, McElroy M B, Kiviluoma J, Global potential for wind-generated electricity. *Proc. Natl. Acad. Sci.* **106**, 2009
- Lucarini V, Fraedrich K, Lunkeit F, Thermodynamics of climate change: generalized sensitivities, *Atmos. Chem. Phys.*, **10**, 9729-9737 2010
- Lunkeit F, Böttinger M, Fraedrich K, Jansen H, Kirk E, Kleidon A, Luksch U, Planet simulator reference manual version 15.0, *Meteorological Institute of the University of Hamburg*, 2007
- Meibom P, Barth R, Norheim I, Ravn H, Sørensen P, Wind Power Integration in an Liberalised Electricity Market, Final Technical Report, Project No. ENK5-CT-2002-00663, Risø National Laboratory, Denmark, January, 2006
- Miller L M, Gans F, Kleidon A, Estimating maximum global land surface wind power extractability and associated climatic consequences. *Earth Syst. Dynam.* **2** 1-12, 2011
- Murphy D, Hall C A S, Year in review EROI or energy return on (energy) invested. *Ann. N.Y. Acad. Sci.* **1185** 102-118, 2010
- Nemet G F, Net radiative forcing from widespread deployment of photovoltaics. *Environ. Sci. Technol.* **43** 2173-2178, 2009
- Nihous G C, An order-of-magnitude estimate of ocean thermal energy conversion resources. *Trans. of the ASME* **127** 328-333, 2005
- Paltridge G W, The steady-state format of global climate. *Quart. J. R. Met. Soc.* **104** 927-945, 1978
- Peixoto J P, Oort A H, Physics of climate. *American Institute of Physics*, 1992
- Pongratz J, Reick C H, Raddatz T, Claussen M, Biogeophysical versus biogeochemical climate response to historical anthropogenic land cover change, *Geophys. Res. Lett.* **37**, L08702, doi:10.1029/2010GL043010, 2010
- Roberts B W, Shepard D H, Caldeira K, Cannon M E, Eccles D G, Grenier A J, Freidin J F, Harnessing high-altitude wind power. *IEEE Trans. Energy Convers.* **22** 136-144, 2007

BIBLIOGRAPHY

- Rogner H, Barthel F, Cabrera M, Faaij A, Giroux M, Hall D, Kagramanian V, Kononov S, Lefevre T, Moreira R, Nötstaller R, Odell P, Taylor M, Energy resources. In: World Energy Assessment. Energy and the Challenge of Sustainability. United Nations Development Programme, United Nations Department of Economic and Social Affairs, World Energy Council, New York, USA, 2000
- Roy S B, Pacala S, Can wind farms affect local meteorology. *J. Geophys. Res.* **109** D19101, 2004
- Santa-Maria M R V, Jacobson M Z, Investigating the effect of large wind farms on energy in the atmosphere, *Energies.*, **2**, 816-838, 2009
- Schneider S H and Dennett R D, Climate barriers to long-term energy growth. *Ambio* **4** 2, 65-74, 1975
- Smil V, Energy transitions: history, requirements, prospects. *Praeger*, Santa Barbara (USA), 2010
- Trieb F S, Schillings C, O'Sullivan M, Pregger T, Hoyer-Klick C, Global Potential of Concentrating Solar Power. In: SolarPACES Conference, 15-18 September 2009, Berlin, Germany, 2009
- U.S. Department of Energy. 20% wind energy by 2030: increasing wind energy's contribution to U.S. electricity supply. accessed via <http://www.nrel.gov/docs/fy08osti/41869.pdf> on Mar. 11, 2011, DOE/GO-102008-2567, 2008
- Vance E, High Hopes. *Nature.* **460** 564-566, 2009
- Wang C, Prinn R G, Potential climatic impacts and reliability of very large-scale wind farms. *Atmos. Chem. & Phys.*, **10**, 2053–2061, 2010
- Wang, C & Prinn R G, Potential climatic impacts and reliability of large-scale offshore wind farms. *Environ. Res. Lett.* **6** 025101, 2011
- Weingart J, Local energy balance of solar thermal electric and photovoltaic power plants, In Climate and Solar Energy Conversion: Proceedings of a IIASA Workshop, 8-10 December 1976, Laxenburg, Austria, 1977
- Weingart J, Global aspects of sunlight as a major energy source. *Energy* **4** 775-798, 1979
- Williams J, Krömer G, Weingart J, Climate and solar energy conversions. CP-77-9, Int. Inst. for Applied Systems Analysis, Laxenburg, Austria, 1977

BIBLIOGRAPHY

Williams J, The effects of climate on energy policy, *Electronics & Power* **24** 4, 261-268, 1978

Wiser R, Yang Z, Hand M, Hohmeyer O, Infield D, Jensen P H, Nikolaev V, O'Malley M, Sinden G, Zervos A. Wind Energy. In IPCC Special Report on Renewable Energy Sources and Climate Change Mitigation [Edenhofer O, Pich-Madruga R, Sokona Y, Seyboth K, Matschoss P, Kadner S, Zwickel T, Eickemeier P, Hansen G, Schlömer S, von Stechow C (eds)], 2011, Cambridge University Press, Cambridge, United Kingdom and New York, NY, USA.

World Wind Energy Report, World Wind Energy Association 2009. Bonn, Germany, 2008

Acknowledgements

The scientific pursuits of my PhD research have not always been embraced by the scientific community but it has never wavered in 2 particular cases:

Axel Kleidon — you are a scientific giant among men who is just beginning to gain the recognition you rightfully deserve. I don't ever expect to hear of another advisor who remained optimistic and wildly supportive of a topic that took 2.5 years and 4 rejections before its first publication — I could have not addressed this summons without you. Your open mind, scientific passion, and sincerity is an eternal inspiration.

Kerry Hinds — as my wife and more simply a person, you routinely exceed what I deem possible, much less, worthy of sharing time with. Your situation places you under many of the same pressures, expectations, and sometimes disorderly 'life path' alterations but with only the opportunity to sit on the sidelines and interject your opinions when I appear to be in the right mindset to acknowledge them. You mentioned once that if the situation were reversed, the same may not be possible of me and you are probably sadly correct. Thank you for truly helping me to be the best I can be — I will spend the rest of my years attempting to right the imbalance.

I am also greatly indebted to my other 4 committee members: Prof. Dr. Hartmut Graßl, Dr. James Dyke, Prof. Dr. Valerio Lucarini. and Prof. Dr. Bjorn Stevens. To Prof. Dr. Hartmut Graßl, it has been a tremendous pleasure and inspiration getting to know you. Your initial insight into science and life, initially bestowed upon me under a desert sun and 48 °C will never be forgotten. I am also only one voice, but I thank you Prof. Dr. Graßl for your continued support of science, students, and the human future and am confident that these same thoughts are echoed in the minds of thousands. To Dr. James Dyke, you have always been open to hearing my rants and raves with openness and thoughtful responses strong in scientific- and life-knowledge — thank you. To Prof. Dr. Valerio Lucarini, I sincerely appreciate the way you handled your editorial/reviewer duties related to my work on wind power and your continued enthusiasm on this topic — thank you. To Prof. Dr. Bjorn Stevens, thank you for leading the IMPRS-ESM and inspiring me with your insightful yet succinct questions at the annual retreats — thank you.

Prof. Dr. Hartmut Graßl, Prof. Dr. Bjorn Stevens, Dr. Antje Weitz, and Cornelia

ACKNOWLEDGEMENTS

Kampmann were also key to my admittance to the University of Hamburg. Dr. Antje Weitz, and Cornelia Kampmann were also very helpful in the final stages of the PhD when things seemed so complicated and overwhelming, I offer you my sincere thanks.

My colleague Fabian Gans provided critical insight into the development of simple models to learn about complex processes, was endlessly patient in answering all my math and physics questions, never complained when asked to read iterative versions of a manuscript, and definitely challenged my own preconceptions about Germany and theoretical physicists.

Dr. Nathaniel Brunsell provided life and academic wisdom that can only be effectively transferred after a solid personal and scientific respect is established. Our past conversations continue to challenge and complicate my overall life, for which I'm very thankful.

I thank my fellow members of the Max Planck Institute for Biogeochemistry (MPI-BGC) and the International Max Planck Research School for Earth System Modeling (IMPRS-ESM) for so many interesting discussions, especially Kristin Bohn, Corina Buendia, Dr. Nuno Carvalhais, Dr. Miguel Mahecha, Ryan Pavlick, Dr. Raphaël Proulx, Dr. Björn Reu, Dr. Stan Schymanski, Bertram Smolny, and Ulrike Stahl.

My research would also not have been possible without the normally unrecognized MPI-BGC IT Department — I exploited you and we were both somehow always happy about it, thank you.

All of the above have altered my life and this PhD thesis for the better. My future will be perpetually biased by these interactions and I feel very fortunate to be in that position.

Eidesstattliche Erklärung

Hiermit versichere ich, dass ich diese Arbeit selbständig verfasst habe und keine anderen als die angegebenen Quellen und Hilfsmittel benutzt habe.

Lee Miller