

Fluorescent Photoswitchable Diarylethenes for Biolabeling and Single Molecule Localization Microscopies with Optical Superresolution

Benoît Roubinet^a, Michael Weber^a, Heydar Shojaei^a, Mark Bates^a, Mariano L. Bossi^a, Vladimir N. Belov^{a*}, Masahiro Irie^{b*}, and Stefan W. Hell^{a*}

^aDepartment of Nanobiophotonics, Max Planck Institute for Biophysical Chemistry, Am Fassberg 11, 37077 Göttingen, Germany

^bResearch Center for Smart Molecules, Department of Chemistry, Rikkyo University, Nishi-Ikebukuro 3-34-1, Toshimaku, Tokyo, Japan

Supporting information

| | |
|---|----|
| 1. Abbreviations | 3 |
| 2. Synthesis..... | 3 |
| 2.1 Liquid chromatography | 3 |
| 2.2 Preparation of boronic esters..... | 4 |
| Di- <i>tert</i> -butyl 5-bromo-2-methoxyisophthalate (S1)..... | 4 |
| 3,5-Di(<i>tert</i> -butoxycarbonyl)-4-methoxyphenylboronic acid pinacol ester (C)..... | 4 |
| Tetra- <i>tert</i> -butyl 5-bromo-2-methoxybenzene 1,3-bis-(carbonyl- <i>N</i> -iminodiacetate) (S2)..... | 5 |
| 2.3 Symmetric DAE derivative | 6 |
| Compound 3 | 6 |
| 2.4 Asymmetric DAEs | 8 |
| General Procedure A1 (GP A1): “the first Suzuki-Miyaura cross-coupling” | 10 |
| General Procedure A2 (GP A2): “the second Suzuki-Miyaura cross-coupling” | 10 |
| General Procedure B (GP B): “Benzothiophene oxidation” | 10 |
| General Procedure C (GP C): “Cleavage of <i>tert</i> -butyl esters” | 10 |
| Compound S3b | 11 |
| Compound S4a | 11 |
| Compound S4b | 12 |
| Compound S5a | 12 |
| Compound S5b | 13 |
| Compound S6a | 13 |
| Compound S6b | 14 |
| Compound 7-Me..... | 14 |
| Compound 7-Et | 15 |
| Compound S7 | 16 |
| Compound S8..... | 16 |

| | |
|--|----|
| Compound 8 | 17 |
| Compound S9 | 17 |
| Compound S10 | 18 |
| Compound S11 | 18 |
| Compound 10 | 19 |
| Compound S12 | 20 |
| Compound S13 | 20 |
| 3. Immunolabeling and fluorescence imaging | 22 |
| 3.2 Photoswitching of bioconjugates | 22 |
| 3.3 Immunolabeling protocol | 22 |
| 3.4 Confocal images | 23 |
| 3.5 Superresolution (PALM/STORM) imaging | 24 |
| 3.5.1 STORM Microscope: | 24 |
| 3.5.2 Detected photons per switching event | 26 |
| 3.5.3 Photoinduced control of the amount of events per frame Fourier ring correlation analysis of the images | 29 |
| 3.6 Photoswitching fatigue resistance of compounds 4-Et and 11 at the ensemble level, in methanol and aqueous buffered solutions | 28 |
| 3.7 Fourier ring correlation analysis of the images | 29 |
| 3.8 Imaging in "blinking buffer" | 29 |
| 4. NMR spectra and RP-HPLC traces of symmetric dimethoxy DAEs derivatives: compounds 3, 4-Me and 4-Et | 30 |
| Compound 3 | 30 |
| Compound 4-Me | 32 |
| Compound 4-Et | 34 |
| 5. NMR spectra and RP-HPLC traces of asymmetric DAEs derivatives | 38 |
| Compound S5a | 38 |
| Compound S5b | 40 |
| Compound S6a | 41 |
| Compound S6b | 43 |
| Compound 7-Me | 44 |
| Compound 7-Et | 46 |
| Compound S7 | 48 |
| Compound S8 | 49 |
| Compound 8 | 51 |

| | |
|---------------------|----|
| Compound S10 | 53 |
| Compound S11 | 54 |
| Compound 10 | 56 |
| Compound S12 | 58 |
| Compound S13 | 59 |
| Compound 11 | 61 |
| 6. References | 64 |

1. Abbreviations

The following abbreviations are used in the text of the *Supplementary Information*: anti-parallel (*ap*), aqueous (aq.), argon (Ar), bis(pinacolato)diboron (b(pin)₂), di-*tert*-butyl dicarbonate (Boc₂O), broad (br.), closed form (CF), 3-chloroperbenzoic acid (*m*-CPBA), diarylethene (DAE), dichloromethane (DCM), 4-(*N,N*-dimethylamino)pyridine (DMAP), *N,N*-dimethylformamide (DMF), dimethyl sulfoxide (DMSO), degree of labeling (DOL), 1-ethyl-3-(3-dimethylaminopropyl)carbodiimide (EDC), electrospray ionization (ESI), ethyl acetate (EtOAc), ethanol (EtOH), high performance liquid chromatography (HPLC), high resolution mass spectrometry (HR-MS), potassium acetate (KOAc), *N*-hydroxysuccinimide (NHS), nuclear magnetic resonance (NMR), open form (OF), parallel (*p*), phosphate buffer saline (PBS), reverse phase (RP), room temperature (r.t.), saturated (sat.), 2-dicyclohexylphosphino-2',6'-dimethoxybiphenyl (SPhos), triethylamine (TEA), tetrahydrofuran (THF), trifluoroacetic acid (TFA), thin layer chromatography (TLC), ultraviolet (UV), visible (vis).

2. Synthesis

2.1 Liquid chromatography

The following columns (cartridges) and solvent systems were used for analytical and preparative separations. **System A:** RP-HPLC (Eurosphere II, 100-5 C₁₈ column, 5 μm, 4.0×150 mm) with CH₃CN and 0.05% aq. TFA (pH ~ 2.0) [linear gradient from 30% to 70% of CH₃CN in 20 min] at a flow rate of 1.2 mL/min; UV-vis detection with diode array and at 254 nm (OF) and 460 nm (CF). **System B:** automated flash purification on Biotage Isolera One (ISO-1EW) device (cartridge PF-C₁₈-HC, 30 μM, with 20 g of RP-C₁₈ silica gel) with the following eluent: 0.1% aq. TFA / CH₃CN, 7:3, at a flow rate of 20 mL/min for 15 min; UV detection at 254 nm. **System C:** System A with a linear gradient from 60% to 90% of CH₃CN in 15 min at a flow rate of 1.2 mL/min. **System D:** System B with the following eluent: 0.1% aq. TFA / CH₃CN, 3:7, at a flow rate of 20 mL/min for 15 min. **System E:** System B with the following eluent: 0.1% aq. TFA / CH₃CN, 1:1, at a flow rate of 20 mL/min for 15 min. **System F:** RP-HPLC (Eurosphere II, 100-5 C₁₈ column, 5 μm, 4.0×150 mm) with CH₃CN and 0.1% aq. TFA (pH ~ 1.5) [30% ACN: 0 – 3 min, then linear gradient from 30% to 100% of CH₃CN in 12 min] at a flow rate of 1.2 mL/min; UV-vis detection with diode array and at 254 nm (OF) and 470 nm (CF).

2.2 Preparation of boronic esters

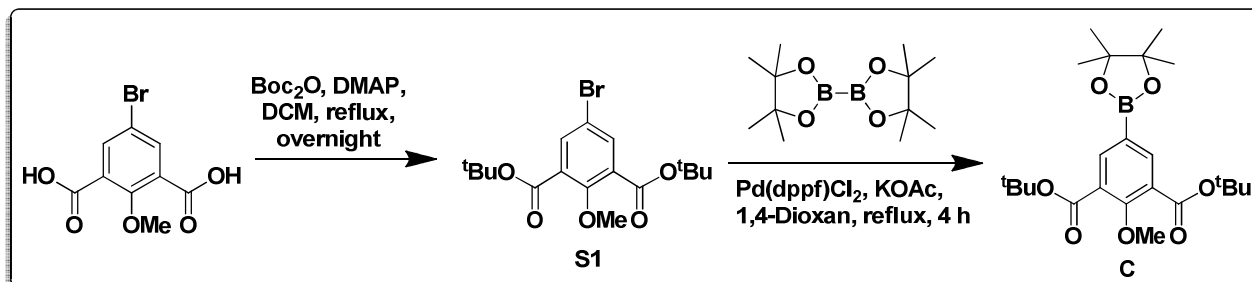

Scheme S1. Preparation of pinacol ester of 3,5-di(*tert*-butoxycarbonyl)-4-methoxyphenylboronic acid.

Di-*tert*-butyl 5-bromo-2-methoxyisophthalate (S1)

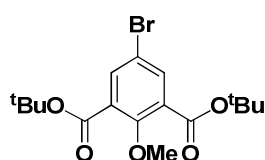

To a solution of 5-bromo-2-methoxyisophthalic acid¹ (300 mg, 1.10 mmol) and DMAP (27 mg, 0.22 mmol, 0.2 equiv.) in a mixture of DCM (5 mL) and DMF (0.2 mL), Boc_2O (720 mg, 3.30 mmol, 3 equiv.) was added in one portion, and stirred at reflux overnight. Then, the resulting mixture was washed thrice with a sat. NaHCO_3 solution (3×35 mL), brine (50 mL), dried over MgSO_4 and concentrated under vacuum. The residue was purified by flash chromatography on a silica gel (*n*-hexane/EtOAc, with a gradient from 100:0 to 90:10) to afford the title compound **S1** as viscous colorless oil (327 mg, 77% yield). R_f (*n*-hexane/EtOAc, 9:1, v/v) = 0.8. ^1H NMR (400 MHz, CDCl_3): δ = 7.86 (s, 2 H), 3.89 (s, 3 H), 1.59 (s, 18 H). ^{13}C NMR (101 MHz, CDCl_3): δ = 164.0, 157.7, 136.5, 130.5, 115.9, 82.7, 63.7, 28.3. HR-MS (ESI, positive mode): 409.0627 [$\text{M}+\text{Na}$, ^{79}Br]⁺, 411.0609 [$\text{M}+\text{Na}$, ^{81}Br]⁺ (found), 411.0601 (calculated for $\text{C}_{17}\text{H}_{23}\text{BrNaO}_5$, [$\text{M}+\text{Na}$, ^{81}Br]⁺).

3,5-Di(*tert*-butoxycarbonyl)-4-methoxyphenylboronic acid pinacol ester (C)

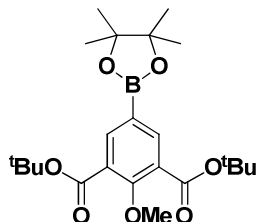

In a sealed tube purged with Ar, compound **S1** (300 mg, 0.78 mmol), bis-pinacolato diboron ($\text{b}(\text{pin})_2$; 237 mg, 0.93 mmol, 1.2 equiv.), KOAc (23 mg, 2.40 mmol, 3 equiv.), $\text{Pd}(\text{dppf})\text{Cl}_2$ (19 mg, 23 μmol , 0.03 equiv.) were combined, and dry 1,4-dioxane (5 mL) was added. The reaction mixture was purged with Ar for further 5 min (Ar bubbling) and stirred at reflux (bath temp. 80 °C) for 2 h. After removal of volatile materials in vacuum, EtOAc (30 mL) was added, and

the reaction mixture was washed with brine (2×30 mL), dried over Na₂SO₄, concentrated under reduced pressure and subjected to column chromatography on silica gel (*n*-hexane/EtOAc, with a gradient from 100:0 to 70:30) to afford the boronic pinacol ester **C** as a white solid (201 mg, 60% yield). *R*_f (*n*-hexane/EtOAc, 4:1, v/v) = 0.8. ¹H NMR (400 MHz, CDCl₃): δ = 8.13 (s, 2 H), 3.90 (s, 3 H), 1.59 (s, 18 H), 1.33 (s, 12 H). ¹³C NMR (101 MHz, CDCl₃): δ = 165.8, 160.4, 139.9 (overlap of 2 signals), 128.3, 84.3, 82.0, 63.5, 28.3, 25.0. ESI-MS, positive mode: *m/z* (rel. int., %) = 457.1 (100) [M+Na]⁺ (found), 457.3 (calculated for C₂₃H₃₅BNaO₇, [M+Na]⁺).

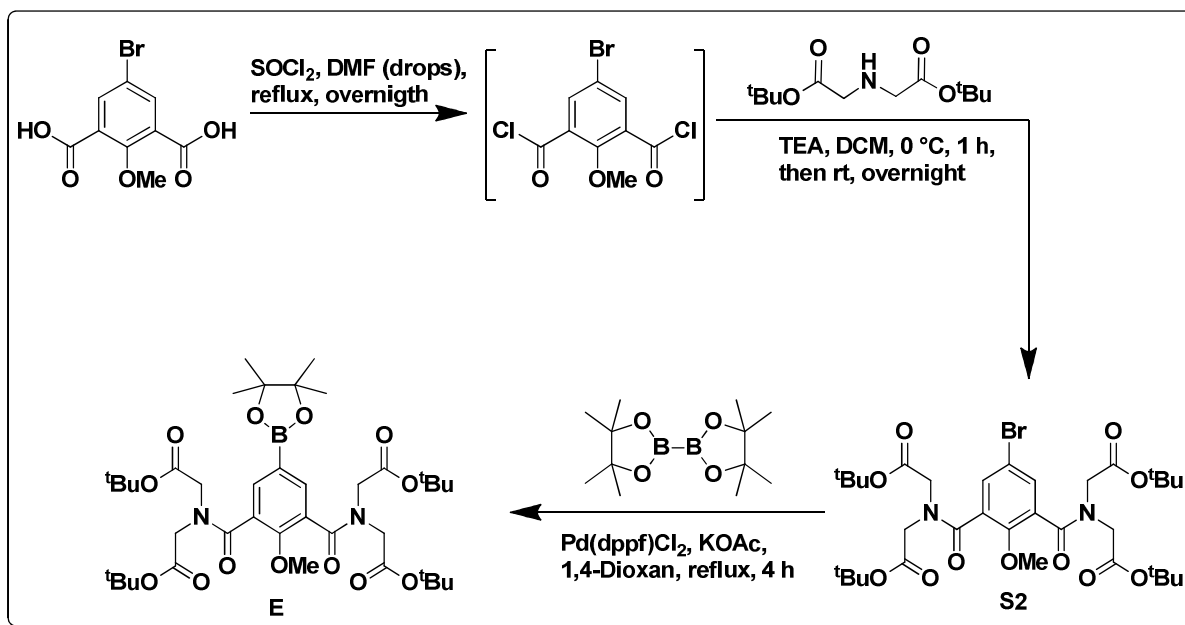

Scheme S2. Pinacolato 3,5-bis[*N,N*-di-(*tert*-butoxycarbonylmethyl)]carbamoyl-4-methoxyphenyl boronate.

Tetra-*tert*-butyl 5-bromo-2-methoxybenzene 1,3-bis-(carbonyl-*N*-iminodiacetate) (**S2**)

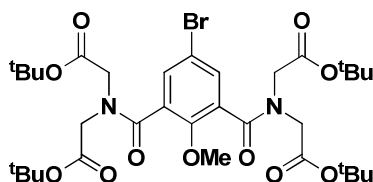

To a solution of 5-bromo-2-methoxyisophthalic acid¹ (552 mg, 2.0 mmol), SOCl₂ (1.5 mL, 20.0 mmol, 10 equiv.) and few drops of DMF were added, and the reaction mixture was refluxed overnight with stirring. An excess of thionyl chloride was removed by distillation, the residue co-evaporated twice with DCM was used directly in the next step. This acyl chloride was dissolved in 35 mL of dry DCM, and a solution of TEA (0.81 mL, 6.0 mmol, 3 equiv.) and di-*tert*-butyl iminodiacetate² (1.03 g, 4.2 mmol, 2.1 equiv.) was added dropwise at 0 °C. After stirring overnight at r.t., the mixture was filtered, the filtrate was washed thrice with a saturated aq. solution of NaHCO₃ (3×35 mL), dried over MgSO₄, concentrated under reduced pressure and subjected to flash chromatography on silica gel (*n*-hexane/EtOAc, with a gradient from 100:0 to

80:20). The title compound **S2** was isolated as a white solid (1.0 g, 69% yield). R_f (*n*-hexane/EtOAc, 7:3, v/v) = 0.67. $^1\text{H NMR}$ (400 MHz, CDCl_3): δ = 7.43 (s, 2 H), 4.54 (m, 2 H), 3.90 (m, 9 H), 1.48 (s, 18 H), 1.42 (s, 18 H). $^{13}\text{C NMR}$ (101 MHz, CDCl_3): δ = 167.6, 167.4, 164.4, 133.4, 132.4, 130.4, 115.7, 82.4, 82.3, 51.7, 50.6, 47.7, 28.2, 28.1. ESI-MS, positive mode: m/z (rel. int., %; *the octa-carboxylic acid was also detected*), 505.1 (100) $[\text{M}+\text{H}, ^{79}\text{Br}]^+$, 506.9 (100) $[\text{M}+\text{H}, ^{81}\text{Br}]^+$ (found), 506.2 (calculated for $\text{C}_{17}\text{H}_{18}\text{BrN}_2\text{O}_{11}$, $[\text{M}+\text{H}, ^{81}\text{Br}]^+$), 751.2 (60) $[\text{M}+\text{Na}, ^{79}\text{Br}]^+$, 753.3 (60) $[\text{M}+\text{Na}, ^{81}\text{Br}]^+$ (found), 752.6 (calculated for $\text{C}_{33}\text{H}_{49}\text{BrN}_2\text{NaO}_{11}$, $[\text{M}+\text{Na}, ^{81}\text{Br}]^+$).

Pinacolato 3,5-bis[*N,N*-di(*tert*-butoxycarbonylmethyl)]carbamoyl-4-methoxyphenyl boronate (**E**)

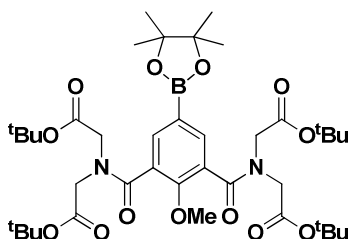

In a sealed tube purged with Ar, compound **S2** (300 mg, 0.41 mmol), bis-pinacolato diboron (b(pin)_2 ; 125 mg, 0.50 mmol, 1.2 equiv.), KOAc (121 mg, 1.23 mmol, 3 equiv.), and $\text{Pd}(\text{dppf})\text{Cl}_2$ (10 mg, 12 μmol , 0.03 equiv.) were combined in dry 1,4-dioxan (5 mL). The reaction mixture was purged with Ar for 5 min (Ar bubbling) and stirred at reflux (bath temp. 80 $^\circ\text{C}$) for 4 h. After removal of volatile materials in vacuum, EtOAc (30 mL) was added, and the reaction mixture was washed with brine (2 \times 30 mL), dried over Na_2SO_4 , concentrated under reduced pressure and subjected to column chromatography on silica gel (*n*-hexane/EtOAc, with a gradient from 100:0 to 70:30) to afford the title compound **E** as a white solid (186 mg, 58% yield). R_f (*n*-hexane/EtOAc, 7:3, v/v) = 0.51. $^1\text{H NMR}$ (400 MHz, CDCl_3): δ = 7.72 (s, 2 H), 4.53 (m, 2 H), 3.93 (m, 9 H), 1.47 (s, 18 H), 1.40 (s, 18 H), 1.23 (s, 12 H). $^{13}\text{C NMR}$ (101 MHz, CDCl_3): δ = 169.6, 168.0, 137.2, 136.3, 128.7, 127.4, 84.0, 82.6, 82.0, 51.7, 47.9, 28.2, 28.1, *methyl signals of pinacol residue are masked by strong singlets of tert-butyl groups*. ESI-MS, positive mode: m/z (rel. int., %) = 799.7 (100) $[\text{M}+\text{Na}]^+$ (found), 799.7 (calculated for $\text{C}_{39}\text{H}_{61}\text{BN}_2\text{NaO}_{13}$, $[\text{M}+\text{Na}]^+$).

2.3 Symmetric DAE derivative

Compound 3

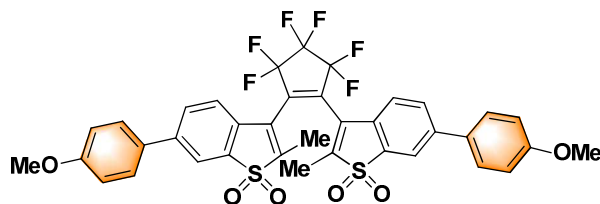

To a solution of 1,2-bis(2-methyl-6-iodobenz[a]thiophen-1,1-dioxide-3-yl)perfluorocyclopentene³ (123 mg, 0.16 mmol) in a mixture of Toluene/EtOH (3.5 mL, 6:1, v/v), (*p*-methoxyphenyl)boronic acid (68 mg, 0.45 mmol, 2.8 equiv.), Na₂CO₃ solution (2 M, 0.2 mL, 2.5 equiv.), and Pd(PPh₃)₄ (9 mg, 7.80 μmol, 5 mol %) were added; the suspension was purged for 5 min with Ar (Ar “bubbling”) and stirred 12 h at reflux (bath temperature = 100 °C). After cooling down, the reaction mixture was filtered through a pad of Silica, washed with Et₂O, and concentrated under reduced pressure. The residue was then purified by flash chromatography on silica gel (*n*-hexane/EtOAc, with a gradient from 90:10 to 70:30) to afford compound **3** as a red solid (53 mg, 45% yield). *The closed isomer (≈ 10%) is produced during the preparation of this dye (see NMR spectra).* *ap:p* = 55:45. ¹H NMR (400 MHz, CDCl₃): δ = 7.93 (s, 1.1 H, *ap*), 7.88 (s, 0.9 H, *p*), 7.75 (d, *J* = 8.0 Hz, 1.1 H, *ap*), 7.59 (d, *J* = 8.0 Hz, 0.9 H, *p*), 7.53 (d, *J* = 8.5 Hz, 2.2 H, *ap*), 7.45 (d, *J* = 8.5 Hz, 1.8 H, *p*), 7.21 (s, 1.1 H, *ap*), 7.19 (s, 0.9 H, *p*), 7.03 (d, *J* = 8.5 Hz, 2.2 H, *ap*), 6.96 (d, *J* = 8.5 Hz, 1.8 H, *p*), 3.87 (s, 3.3 H, *ap*), 3.84 (s, 2.7 H, *p*), 2.23 (s, 2.8 H, *p*), 2.09 (s, 3.2 H, *ap*). ¹³C NMR (126 MHz, CDCl₃): δ = 160.6 *ap*, 160.6 *p*, 144.2 *ap*, 144.0 *p*, 143.0 *p*, 142.8 *ap*, 136.1 *ap*, 136.1 *p*, 131.6 *ap*, 131.4 *p*, 130.5 *ap*, 130.5 *p*, 128.4 *ap*, 128.4 *p*, 127.5 *p*, 127.3 *ap*, 124.1 *ap*, 124.0 *p*, 122.9 *ap*, 122.8 *p*, 121.0 *ap*, 120.9 *p*, 114.9 *ap*, 114.8 *p*, 55.6 *p/ap*, 9.1 *ap*, 9.0 *p*. ¹⁹F NMR (376 MHz, CDCl₃): δ = -109.86 (m, 4.0 F, *p/ap*), -131.97 (m, 2.0 F, *p/ap*). HR-MS (ESI, positive mode): 762.1388 [M+NH₄]⁺ (found), 762.1413 (calculated for C₃₇H₃₀F₆NO₆S₂, [M+NH₄]⁺).

2.4 Asymmetric DAEs

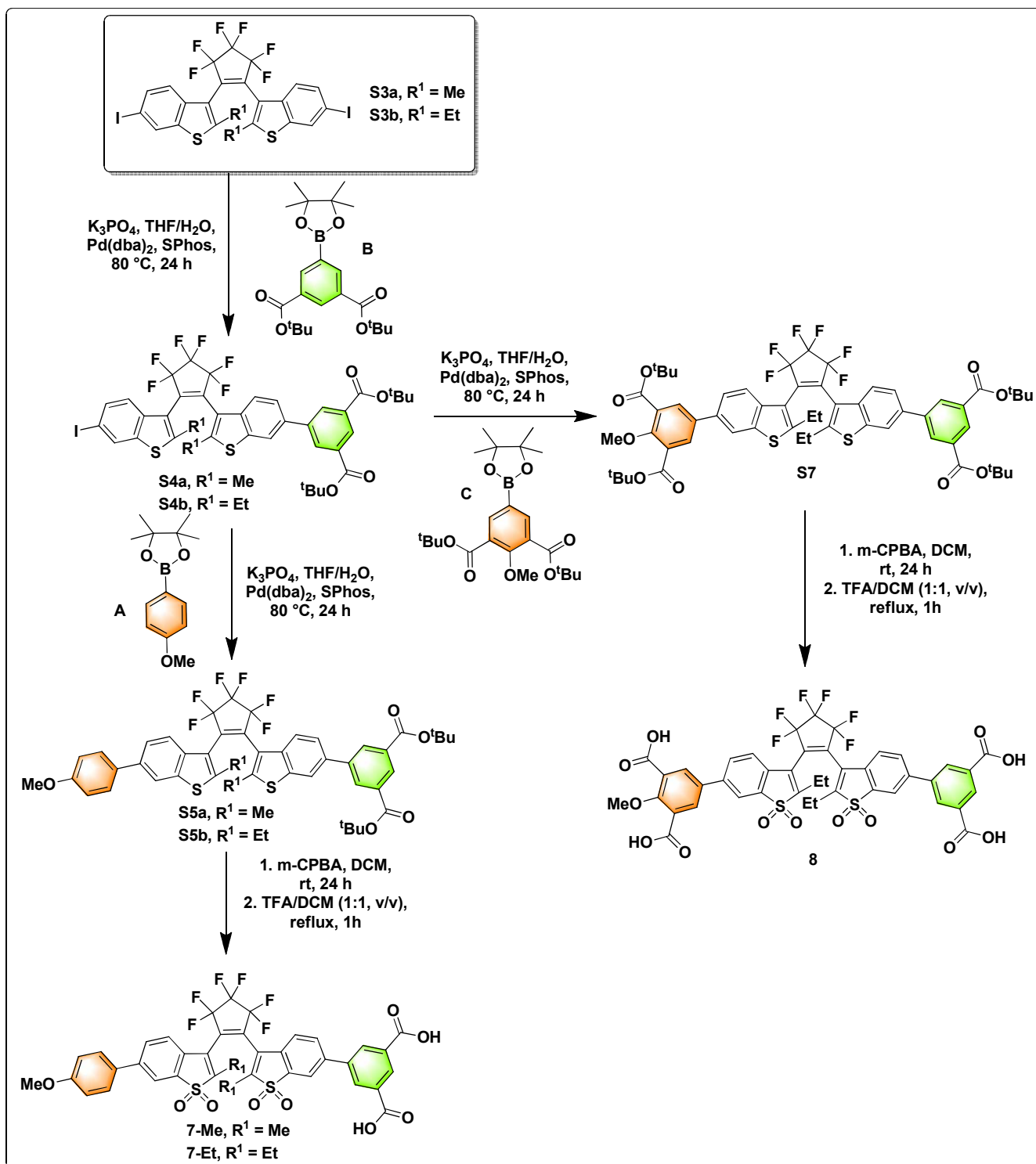

Scheme S3. Synthesis of asymmetric DAEs as “di- and tetra-acids”

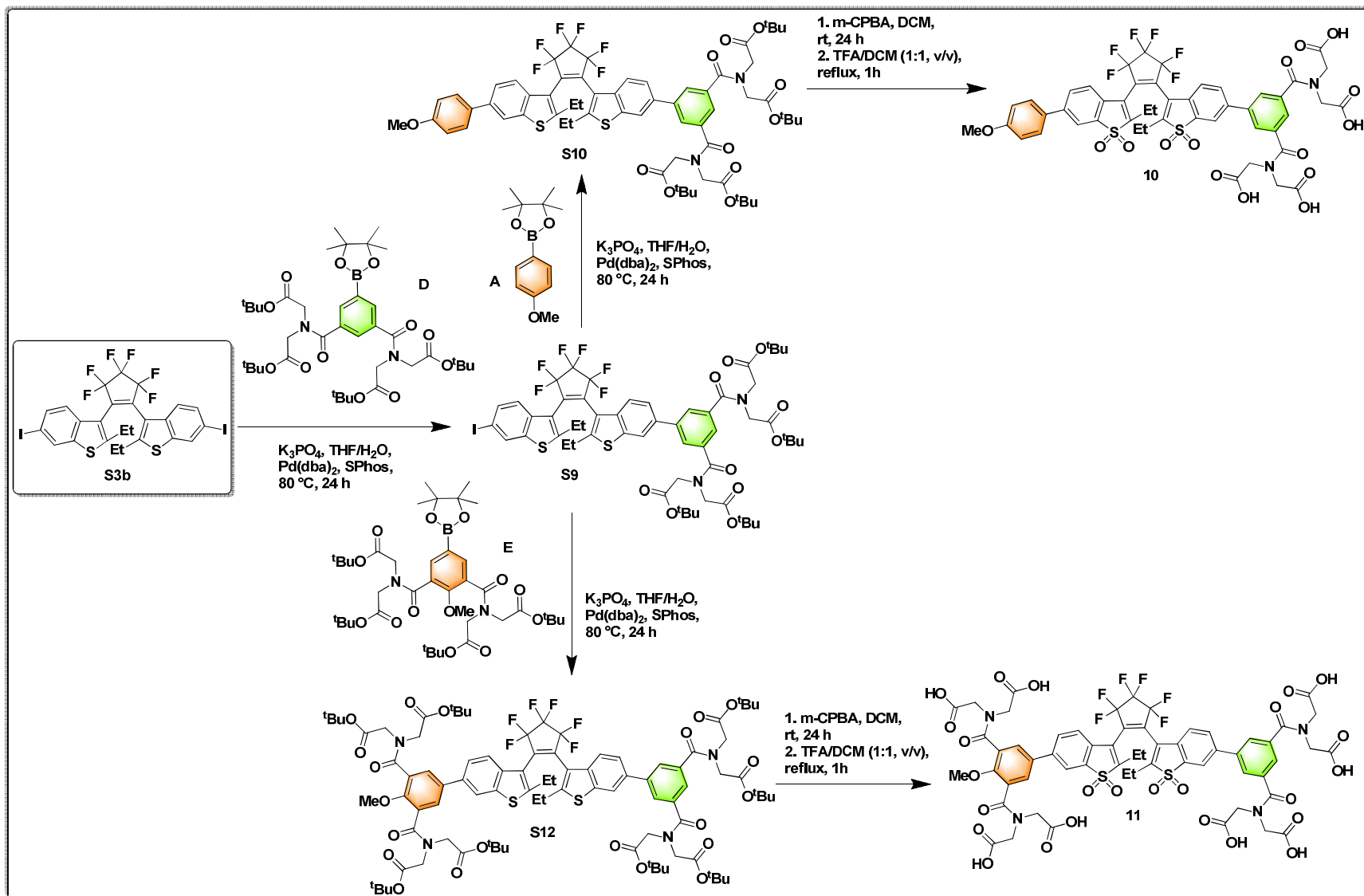

Scheme S4. Synthesis of asymmetric DAEs as “tetra- and octa-acids”

General Procedure A1 (GP A1): “the first Suzuki-Miyaura cross-coupling”

To a solution of 1,2-bis(2-alkyl-6-iodobenz[a]thiophen-3-yl)perfluorocyclopentene³⁻⁴ (1 equiv., amount: 0.1 – 0.2 mmol) in a mixture of THF/H₂O (4 mL, 3:1, v/v), arylboronic ester (1 equiv.), K₃PO₄ (3 equiv.), SPhos (0.1 equiv.) and Pd(dba)₂ (0.1 equiv.) were added; the suspension was purged for 5 min with Ar (Ar “bubbling”) and stirred 4 h at reflux (bath temperature = 80 °C). Then, the reaction mixture was diluted with EtOAc, washed with brine (3 × 25 mL), dried over Na₂SO₄ and concentrated under reduced pressure. The residue was purified by flash chromatography on silica gel (*n*-hexane/EtOAc) to afford the desired “mono-substituted monoiodide” DAE as a purple viscous semi-solid.

General Procedure A2 (GP A2): “the second Suzuki-Miyaura cross-coupling”

To a solution of “mono-substituted monoiodide” (GP A1) (amount: 20 - 70 μmol) in a mixture of THF/H₂O (4 mL, 3:1, v/v), arylboronic ester (3 equiv.), K₃PO₄ (3 equiv.), SPhos (0.1 equiv.) and Pd(dba)₂ (0.095 equiv.) were added; the suspension was purged for 5 min with Ar (Ar “bubbling”) and stirred 4 h at reflux (bath temperature = 80 °C). Then, the reaction mixture was diluted with EtOAc, washed with brine (3 × 25 mL), dried over Na₂SO₄ and concentrated under reduced pressure. The residue was purified by flash chromatography on silica gel (*n*-hexane/EtOAc) to afford the desired asymmetric DAE as a white solid.

General Procedure B (GP B): “Benzothiophene oxidation”

To a solution of asymmetric DAE (GP A2) (amount: 10 - 40 μmol) in DCM (2 mL), *m*-CPBA (9 equiv.) was added, and the reaction mixture was stirred 24 h at r.t. Then the reaction mixture was diluted with DCM, washed with a *sat.* NaHCO₃ solution (20 mL), brine (35 mL), dried over MgSO₄, and concentrated under reduced pressure. The residue was purified by flash chromatography on silica gel (*n*-hexane/EtOAc) to afford the desired oxidized compound as an orange solid.

General Procedure C (GP C): “Cleavage of *tert*-butyl esters”

The oxidized DAE (amount: 10 - 30 μmol) was dissolved in a mixture of TFA/DCM (4 mL, 1:1, v/v) and stirred for 1 h at reflux. Then the reaction mixture was concentrated in vacuum and subjected to flash chromatography using a RP-C₁₈ cartridge. The product-containing fractions were pooled and lyophilized to give the desired compound as an amorphous orange solid.

Compound S3b

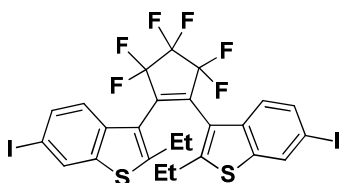

The synthesis of this diiodide DAE was performed according to a published procedure⁵. Iodine (258 mg, 1.02 mmol, 0.9 equiv.) and H₅IO₆ (35 mg, 0.39 mmol, 0.35 equiv.) was added to a stirred solution of 1,2-bis(2-ethyl-benz[a]thiophen-3-yl)perfluorocyclopentene (560 mg, 1.13 mmol) in AcOH (37.5 mL), H₂SO₄ (750 μL), and water (1.8 mL), and the mixture was stirred for 3 h at 70 °C in the open air. The reaction mixture was poured into 100 mL of ice-water, diluted with EtOAc (100 mL), washed with a sat. solution of NaHCO₃ and brine, dried over MgSO₄, and concentrated under reduced pressure. The residue was purified by column chromatography on silica gel (100 % *n*-hexane) to afford the “diiodo-sulfide” DAE as a white solid (306 mg, 36%). *ap:p* = 60:40. This compound was used in the next step without further purification (purity over 85% determined by NMR). *R*_f (*n*-hexane) = 0.40. HR-MS (ESI, negative mode): 746.8599 [M-H]⁻ (found), 746.8614 (calculated for C₂₅H₁₅F₆I₂S₂, [M-H]⁻).

Compound S4a

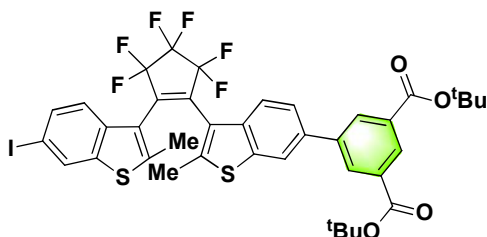

Compound **S4a** was synthesized from 1,2-bis(2-methyl-6-iodobenz[a]thiophen-3-yl)perfluorocyclopentene³ (100 mg, 0.14 mmol) according to GP A1, and purified by column chromatography on silica gel (*n*-hexane/EtOAc, with a gradient from 100:0 to 90:10); 43 mg, 36% yield. This compound was used in the next step without further purification (purity over 85% determined by NMR). *R*_f (*n*-hexane/EtOAc, 9:1, v/v) = 0.30. HR-MS (ESI, positive mode): 893.0659 [M+Na]⁺ (found), 893.0661 (calculated for C₃₉H₃₃F₆INaO₄S₂, [M+Na]⁺).

Compound S4b

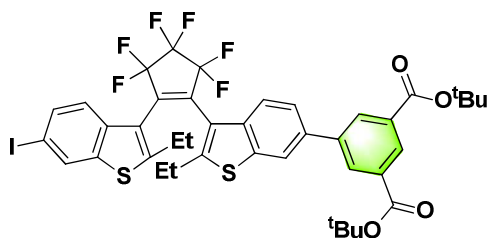

Compound **S4b** was synthesized from 1,2-bis(2-ethyl-6-iodobenz[a]thiophen-3-yl)perfluorocyclopentene⁴ (120 mg, 0.16 mmol) according to GP A1, and purified by column chromatography on silica gel gel (*n*-hexane/EtOAc, with a gradient from 100:0 to 90:10); 60 mg, 42% yield. This compound was used in the next step without further purification (purity over 85% determined by NMR). R_f (*n*-hexane/EtOAc, 9:1, v/v) = 0.35. HR-MS (ESI, positive mode): 921.0963 [M+Na]⁺ (found), 921.0974 (calculated for C₄₁H₃₇F₆INaO₄S₂, [M+Na]⁺).

Compound S5a

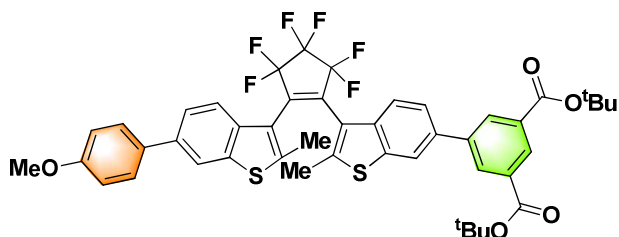

Compound **S5a** was synthesized from compound **S4a** (43 mg, 0.049 mmol) according to GP A2, and purified by column chromatography on silica gel gel (*n*-hexane/EtOAc, with a gradient from 100:0 to 80:20); 26 mg, 62% yield. R_f (*n*-hexane/EtOAc, 9:1, v/v) = 0.24. $ap:p = 65:35$. ¹H NMR (400 MHz, CDCl₃): $\delta = 8.57$ (br. t, $J = 1.6$ Hz, 0.6 H, *ap*), 8.52 (br. t, $J = 1.6$ Hz, 0.4 H, *p*), 8.41 (d, $J = 1.6$ Hz, 1.2 H, *ap*), 8.31 (d, $J = 1.6$ Hz, 0.8 H, *p*), 7.98 (d, $J = 1.6$ Hz, 0.6 H, *ap*), 7.88 (d, $J = 1.6$ Hz, 0.4 H, *p*), 7.86 (d, $J = 1.6$ Hz, 0.6 H, *ap*), 7.78 – 7.39 (m, 6.4 H, *p/ap*), 7.00 (d, $J = 8.6$ Hz, 1.2 H, *ap*), 6.93 (d, $J = 8.6$ Hz, 0.8 H, *p*), 3.86 (s, 1.9 H, *ap*), 3.82 (s, 1.1 H, *p*), 2.54 (s, 1.0 H, *p*), 2.52 (s, 1.0 H, *p*), 2.28 (s, 2.0 H, *ap*), 2.26 (s, 2.0 H, *ap*), 1.65 (s, 12.0 H, *ap*), 1.61 (s, 6.0 H, *p*). ¹³C NMR (101 MHz, CDCl₃): $\delta = 165.1, 159.4, 159.4, 144.0, 143.5, 142.8, 141.0, 139.2, 139.2, 138.1, 137.6, 137.1, 136.1, 133.2, 133.1, 133.0, 131.9, 130.6, 129.4, 129.3, 129.1, 128.5, 128.4, 128.4, 124.3, 124.2, 124.1, 122.7, 122.7, 122.5, 122.4, 122.2, 120.8, 120.6, 120.0, 119.8, 119.4, 119.2, 119.1, 114.5, 114.5, 114.4, 82.0, 81.9, 55.5, 55.5, 28.3, 28.3, 15.5, 15.4$. ¹⁹F NMR (376 MHz, CDCl₃): $\delta = -110.0$ (m, 4.0 F, *p/ap*), -132.8 (m, 2.0 F, *p/ap*). HR-MS (ESI, positive mode): 873.2126 [M+Na]⁺ (found), 873.2114 (calculated for C₄₆H₄₀F₆NaO₅S₂, [M+Na]⁺).

Compound S5b

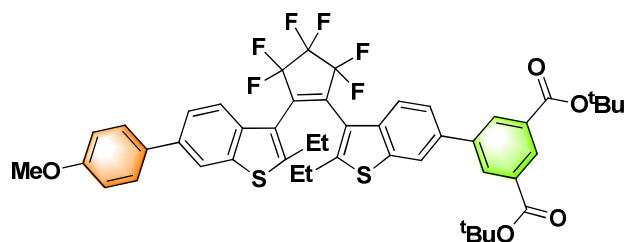

Compound **S5b** was synthesized from compound **S4b** (60 mg, 0.067 mmol) according to GP A2, and purified by column chromatography on silica gel gel (*n*-hexane/EtOAc, with a gradient from 100:0 to 80:20); 36 mg, 61% yield. R_f (*n*-hexane/EtOAc, 9:1, v/v) = 0.32. *ap:p* = 60:40. ^1H NMR (400 MHz, CDCl_3): δ = 8.57 (br. t, J = 1.6 Hz, 0.6 H, *ap*), 8.52 (br. t, J = 1.6 Hz, 0.4 H, *p*), 8.41 (d, J = 1.6 Hz, 1.2 H, *ap*), 8.31 (d, J = 1.6 Hz, 0.8 H, *p*), 8.01 (d, J = 1.6 Hz, 0.6 H, *ap*), 7.90 (d, J = 1.6 Hz, 0.4 H, *p*), 7.88 (d, J = 1.6 Hz, 0.6 H, *ap*), 7.80 – 7.39 (m, 6.4 H, *p/ap*), 6.99 (d, J = 8.8 Hz, 1.2 H, *ap*), 6.93 (d, J = 8.8 Hz, 0.8 H, *p*), 3.86 (s, 2.2 H, *ap*), 3.82 (s, 0.8 H, *p*), 2.96 (m, 0.6 H, *p/ap*), 2.77 (m, 2.0 H, *p/ap*), 2.50 (m, 1.4 H, *p/ap*), 1.65 (s, 12.0 H, *ap*), 1.61 (s, 6.0 H, *ap*), 1.34 (m, 2.4 H, *p*), 0.87 (m, 3.6 H, *ap*). ^{13}C NMR (101 MHz, CDCl_3): δ = 165.1, 165.1, 159.5, 159.4, 151.8, 151.2, 150.6, 150.1, 143.5, 141.1, 141.0, 139.1, 139.1, 139.0, 138.9, 138.2, 137.9, 137.6, 137.5, 137.1, 136.9, 136.0, 134.9, 133.2, 133.2, 133.1, 133.0, 131.9, 131.9, 130.6, 129.4, 129.4, 129.3, 129.3, 129.1, 128.5, 128.5, 128.4, 128.4, 125.6, 124.3, 124.2, 124.1, 124.0, 122.7, 122.7, 122.4, 122.4, 122.3, 120.9, 120.8, 120.1, 120.0, 118.1, 117.9, 117.8, 114.5, 114.4, 82.0, 81.9, 55.5, 55.5, 28.3, 28.3, 23.6, 23.5, 23.3, 23.2, 16.1, 16.1, 15.6, 15.6. ^{19}F NMR (376 MHz, CDCl_3): δ = -110.3 (m, 4.0 F, *p/ap*), -132.7 (m, 2.0 F, *p/ap*). HR-MS (ESI, positive mode): 901.2389 $[\text{M}+\text{Na}]^+$ (found), 901.2427 (calculated for $\text{C}_{48}\text{H}_{44}\text{F}_6\text{NaO}_5\text{S}_2$, $[\text{M}+\text{Na}]^+$).

Compound S6a

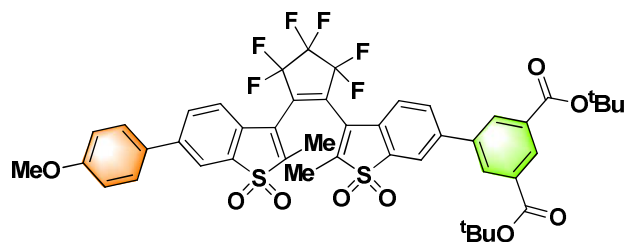

Compound **S6a** was synthesized from **S5a** (26 mg, 0.031 mmol) according to GP B, and purified by column chromatography on silica gel gel (*n*-hexane/EtOAc, with a gradient from 100:0 to 80:20); 21 mg, 75% yield. R_f (*n*-hexane/EtOAc, 4:1, v/v) = 0.35. *ap:p* = 50:50. ^1H NMR (400 MHz, CDCl_3): δ = 8.63 (s, 0.5 H, *ap*), 8.58 (s, 0.5 H, *p*), 8.35 (d, J = 1.6 Hz, 1.0 H, *ap*), 8.27 (d, J = 1.6 Hz, 1.0 H, *p*), 8.01 - 7.85 (m, 3.0 H, *p/ap*), 7.76 (dd, J = 1.6 Hz and 7.7 Hz, 0.5 H, *p*), 7.71 (dd, J = 1.6 Hz and 7.7 Hz, 0.5 H, *ap*), 7.64 – 7.39 (m, 3.0 H, *p/ap*), 7.20 (d, J = 8.0 Hz, 1.0 H, *p/ap*), 7.00 (d, J = 8.0 Hz, 1.0 H, *p*), 6.95 (d, J = 8.0 Hz, 1.0 H, *ap*), 3.87 (s, 1.5 H, *ap*), 3.83 (s, 1.5 H, *p*), 2.26 (s, 1.5 H, *p*), 2.23 (s, 1.5 H, *p*), 2.12 (s, 1.5 H, *ap*), 2.10 (s, 1.5 H, *ap*), 1.65 (s, 9.0 H, *ap*), 1.61 (s, 9.0 H, *p*). ^{13}C NMR (101 MHz, CDCl_3): δ = 164.6, 160.6, 144.5, 144.3,

144.1, 143.9, 143.6, 142.8, 142.6, 138.5, 136.3, 136.1, 134.8, 133.9, 133.6, 133.5, 132.6, 132.4, 131.6, 131.6, 131.5, 131.5, 130.8, 130.8, 130.5, 130.4, 130.0, 129.1, 128.9, 128.4, 128.4, 127.5, 127.3, 124.0, 123.8, 123.1, 122.9, 122.7, 121.7, 121.5, 121.1, 120.9, 114.9, 114.8, 82.4, 55.6, 28.3, 14.3, 14.3. ^{19}F NMR (376 MHz, CDCl_3): $\delta = -109.6$ (m, 4.0 F, *p/ap*), -132.0 (m, 2.0 F, *p/ap*). HR-MS (ESI, positive mode): 937.1917 $[\text{M}+\text{Na}]^+$ (found), 937.1910 (calculated for $\text{C}_{46}\text{H}_{40}\text{F}_6\text{NaO}_9\text{S}_2$, $[\text{M}+\text{Na}]^+$).

Compound S6b

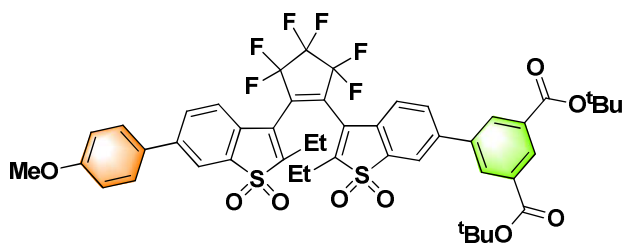

Compound **S6b** was synthesized from **S5b** (35 mg, 0.040 mmol) according to GP B, and purified by column chromatography on silica gel gel (*n*-hexane/EtOAc, with a gradient from 100:0 to 80:20); 18 mg, 50% yield. R_f (*n*-hexane/EtOAc, 4:1, v/v) = 0.28. *ap:p* = 55:45. ^1H NMR (400 MHz, CDCl_3): $\delta = 8.63$ (br. t, $J = 1.5$ Hz, 0.6 H, *ap*), 8.58 (br. t, $J = 1.5$ Hz, 0.4 H, *p*), 8.35 (d, $J = 1.6$ Hz, 1.2 H, *ap*), 8.27 (d, $J = 1.6$ Hz, 0.8 H, *p*), 8.04 - 7.85 (m, 3 H, *p/ap*), 7.77 (dd, $J = 1.8$ and 8.0 Hz, 0.6 H, *ap*), 7.70 (dd, $J = 1.8$ and 8.0 Hz, 0.4 H, *p*), 7.64 - 7.39 (m, 3 H, *p/ap*), 7.24 (d, $J = 7.4$ Hz, 0.6 H, *ap*), 7.24 (d, $J = 7.4$ Hz, 0.4 H, *p*), 7.01 (d, $J = 8.8$ Hz, 1.2 H, *ap*), 6.95 (d, $J = 8.8$ Hz, 0.8 H, *p*), 3.87 (s, 1.7 H, *ap*), 3.83 (s, 1.3 H, *p*), 2.63 (m, 2.8 H, *p/ap*), 2.45 (m, 1.2 H, *p/ap*), 1.64 (s, 11 H, *ap*), 1.61 (s, 7 H, *p*), 1.43 (m, 2.7 H, *p*), 1.11 (m, 3.3 H, *ap*). ^{13}C NMR (101 MHz, CDCl_3): $\delta = 164.7$, 164.7, 160.6, 160.6, 149.1, 148.8, 148.2, 147.8, 144.3, 144.2, 142.8, 142.7, 138.5, 138.5, 136.8, 136.8, 136.6, 136.6, 134.8, 134.0, 133.6, 133.5, 132.5, 132.2, 131.6, 131.6, 131.3, 131.1, 130.8, 130.8, 130.5, 130.5, 130.4, 130.0, 129.0, 128.9, 128.5, 128.4, 128.4, 127.4, 127.3, 123.5, 123.4, 123.3, 123.2, 122.9, 121.3, 120.6, 114.9, 114.8, 82.4, 82.4, 55.6, 55.5, 28.3, 28.3, 19.5, 19.4, 19.4, 19.3, 12.1, 12.0, 11.9, 11.8. ^{19}F NMR (376 MHz, CDCl_3): $\delta = -109.9$ (m, 4.0 F, *p/ap*), -132.1 (m, 2.0 F, *p/ap*). HR-MS (ESI, positive mode): 965.2202 $[\text{M}+\text{Na}]^+$ (found), 965.2223 (calculated for $\text{C}_{48}\text{H}_{44}\text{F}_6\text{NaO}_9\text{S}_2$, $[\text{M}+\text{Na}]^+$).

Compound 7-Me

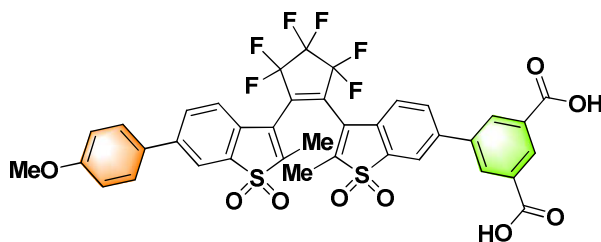

Compound **7-Me** was synthesized from **S6a** (21 mg, 0.023 mmol) according to GP C, and purified by flash chromatography using a RP-C18 cartridge (system D); 8 mg, 43% yield. *ap:p* =

50:50. ^1H NMR (400 MHz, DMF- d_7): δ = 8.71 (br. t, J = 1.6 Hz, 0.5 H, p), 8.66 (m, 1.0 H, p/ap), 8.62 (m, 1.0 H, p/ap), 8.60 (d, J = 1.6 Hz, 0.5 H, ap), 8.54 (m, 1.0 H, p/ap), 8.37 (d, J = 1.6 Hz, 0.5 H, p), 8.31 (m, 1.0 H, p/ap), 8.17 (m, 1.0 H, p/ap), 8.02 (m, 1.5 H, p/ap , masked by the signal of the residual CH-protons in DMF- d_7), 7.89 (m, 2.0 H, p/ap), 7.76 (m, 1.0 H, p/ap), 7.12 (d, J = 8.8 Hz, 1.0 H, ap), 7.05 (d, J = 8.8 Hz, 1.0 H, p), 3.89 (s, 1.2 H, p), 3.85 (s, 1.8 H, ap), 2.39 (s, 1.5 H, p), 2.38 (s, 1.5 H, p), 2.32 (s, 3.0 H, ap). ^{13}C NMR (126 MHz, DMF- d_7): δ = 167.8, 167.8, 162.0, 161.9, 145.5, 144.8, 143.5, 143.4, 140.3, 140.2, 137.4, 137.3, 135.0, 134.7, 134.1, 134.0, 133.4, 133.4, 133.2, 131.7, 131.3, 129.9, 129.9, 128.3, 125.8, 125.7, 125.5, 124.6, 124.5, 123.0, 122.8, 121.6, 121.5, 116.0, 115.9, 56.5, 56.5, 9.8, 9.5. ^{19}F NMR (376 MHz, DMF- d_7): δ = -109.2 (m, 4.0 F, p/ap), -130.2 (m, 2.0 F, p/ap). HR-MS (ESI, negative mode): 801.0671 [M-H] $^-$ (found), 801.0693 (calculated for $\text{C}_{38}\text{H}_{23}\text{F}_6\text{O}_9\text{S}_2$, [M-H] $^-$). HPLC (system C): t_{R} = 9.3 min (93% HPLC area, open form); 11.5 min (1% HPLC area, closed form).

Compound 7-Et

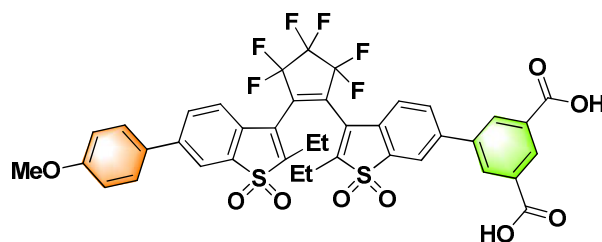

Compound **7-Et** was synthesized from **S6b** (18 mg, 0.019 mmol) according to GP C, and purified by flash chromatography using a RP-C18 cartridge (system D); 9 mg, 57% yield. $ap:p$ = 60:40. ^1H NMR (500 MHz, DMF- d_7): δ = 8.71 (br. t, J = 1.6 Hz, 0.6 H, ap), 8.66 (m, 0.8 H, p), 8.63 (d, J = 1.6 Hz, 0.6 H, ap), 8.56 (d, J = 1.6 Hz, 0.4 H, p), 8.54 (d, J = 1.6 Hz, 0.6 H, p), 8.37 (d, J = 1.8 Hz, 0.6 H, ap), 8.34 (d, J = 1.8 Hz, 0.4 H, p), 8.33 (d, J = 1.8 Hz, 0.4 H, p), 8.25 (d, J = 1.8 Hz, 0.6 H, p), 8.18 (m, 1.0 H, p/ap), 8.02 (m, 2.0 H, p/ap , overlaps with the signal of the residual CH-protons in DMF- d_7), 7.89 (m, 2 H, p/ap), 7.76 (m, 1.0 H, p/ap), 7.13 (d, J = 9.7 Hz, 1.2 H, ap), 7.05 (d, J = 9.7 Hz, 0.8 H, p), 3.90 (s, 1.8 H, ap), 3.85 (s, 1.2 H, p), 2.82 (m, 2.4 H, p/ap), 2.64 (m, 1.6 H, p/ap), 1.41 (m, 2.6 H, p), 1.08 (m, 3.4 H, ap). ^{13}C NMR (126 MHz, DMF- d_7): δ = 167.5, 167.5, 161.7, 161.6, 150.5, 150.2, 149.4, 149.3, 144.7, 144.7, 143.4, 143.3, 140.0, 139.9, 137.6, 137.5, 137.5, 137.3, 134.7, 134.3, 133.8, 133.7, 133.1, 133.1, 132.9, 131.4, 131.4, 131.0, 130.9, 129.6, 129.6, 129.6, 129.5, 128.0, 127.8, 126.1, 125.8, 125.6, 124.1, 124.0, 122.4, 122.2, 121.0, 120.9, 115.7, 115.6, 56.2, 56.2, 20.1, 20.0, 20.0, 19.9, 12.8, 12.7, 12.6, 12.4. ^{19}F NMR (471 MHz, DMF- d_7): δ = -109.8 (m, 4.0 F, p/ap), -130.7 (m, 2.0 F, p/ap). HR-MS (ESI, positive mode): 853.0956 [M+Na] $^+$ (found), 853.0971 (calculated for $\text{C}_{40}\text{H}_{28}\text{F}_6\text{NaO}_9\text{S}_2$, [M+Na] $^+$). HPLC (system B): t_{R} = 10.8 min (91% HPLC area, open form); 12.5 min (1% HPLC area, closed form).

Compound S7

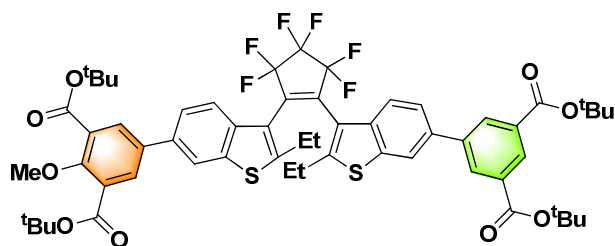

Compound **S7** was synthesized from **S4b** (42 mg, 48.2 μmol) according to GP A2, and purified by column chromatography on silica gel (*n*-hexane/EtOAc, with a gradient from 100:0 to 80:20); 28 mg, 54% yield. R_f (*n*-hexane/EtOAc, 9:1, v/v) = 0.20. *ap:p* = 65:35. ^1H NMR (400 MHz, CDCl_3): δ = 8.55 (bt, J = 1.6 Hz, 0.6 H, *ap*), 8.50 (bt, J = 1.6 Hz, 0.4 H, *p*), 8.40 (d, J = 1.6 Hz, 1.2 H, *ap*), 8.31 (d, J = 1.6 Hz, 0.8 H, *p*), 8.03 - 7.99 (m, 2.0 H, *p/ap*), 7.96 - 7.91 (m, 2.0 H, *p/ap*), 7.85 - 7.60 (m, 3.0 H, *p/ap*), 7.50 (dd, J = 1.8 Hz & 8.5 Hz, 0.6 H, *ap*), 7.43 (dd, J = 1.8 Hz & 8.5 Hz, 0.4 H, *ap*), 3.95 (s, 1.0 H, *p*), 3.94 (s, 2.0 H, *ap*), 2.95 (m, 0.6 H, *p/ap*), 2.78 (m, 2.0 H, *p/ap*), 2.50 (m, 1.4 H, *p/ap*), 1.64 (m, 38.4 H, *p/ap*), 0.88 (t, J = 6.6 Hz, 3.6 H, *ap*). ^{13}C NMR (101 MHz, CDCl_3): Due to co-elution of this compound with the starting boronic ester (compound C), it was not possible to interpret the ^{13}C NMR spectrum. ^{19}F NMR (376 MHz, CDCl_3): δ = -110.2 (m, 4.0 F, *p/ap*), -130.7 (m, 2.0 F, *p/ap*). ESI-MS, negative mode: m/z (rel. int., %) = 465.7 (100) $[\text{M}-2\text{H}+\text{K}]^-$ (found), 465.5 (calculated for $\text{C}_{42}\text{H}_{27}\text{KF}_6\text{O}_9\text{S}_2$, $[\text{M}-2\text{H}+\text{K}]^-$, premature cleavage of *tert*-butyl substituents occurred during this analysis).

Compound S8

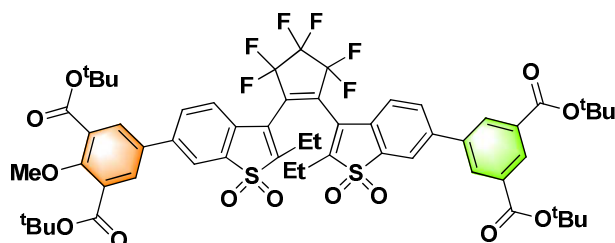

Compound **S8** was synthesized from compound **S7** (28 mg, 25.9 μmol) according to GP B, and purified by column chromatography on silica gel (*n*-hexane/EtOAc, with a gradient from 100:0 to 80:20); 18 mg, 60% yield. R_f (*n*-hexane/EtOAc, 9:1, v/v) = 0.15. *ap:p* = 60:40. ^1H NMR (400 MHz, CDCl_3): δ = 8.62 (bt, J = 1.6 Hz, 0.6 H, *ap*), 8.58 (bt, J = 1.6 Hz, 0.4 H, *p*), 8.35 (d, J = 1.6 Hz, 1.2 H, *ap*), 8.27 (d, J = 1.6 Hz, 0.8 H, *p*), 8.10 - 7.95 (m, 4.0 H, *p/ap*), 7.92 - 7.86 (m, 1.4 H, *p/ap*), 7.82 (dd, J = 1.7 and 8.0 Hz, 0.6 H, *ap*), 7.72 (dd, J = 1.8 and 8.0 Hz, 0.4 H, *p*), 7.66 (dd, J = 1.8 and 8.0 Hz, 0.4 H, *p*), 7.59 (m, 1.2 H, *p/ap*), 3.96 (s, 1.8 H, *ap*), 3.91 (s, 1.2 H, *p*), 2.62 (m, 2.7 H, *p/ap*), 2.45 (m, 1.3 H, *p/ap*), 1.65 (s, 11.0 H, *ap*), 1.63 (s, 11.0 H, *ap*), 1.60 (s, 7.0 H, *p*), 1.58 (s, 7.0 H, *p*), 1.44 (m, 2.6 H, *p*), 1.11 (m, 3.4 H, *ap*). ^{13}C NMR (101 MHz, CDCl_3): δ = 165.0, 165.0, 164.7, 164.6, 159.1, 159.0, 149.2, 149.0, 148.8, 148.8, 142.8, 142.7, 142.5, 142.4, 138.5, 138.4, 136.8, 136.8, 134.8, 133.9, 133.6, 133.5, 133.2, 133.2, 132.5, 132.3, 132.2, 132.1, 132.0, 131.6, 131.6, 130.9, 130.8, 130.4, 130.0, 129.8, 129.6, 129.0, 128.8, 128.6,

128.5, 123.4, 123.3, 123.1, 123.0, 121.3, 121.3, 121.0, 121.0, 82.8, 82.7, 82.4, 82.4, 63.8, 63.7, 28.3, 28.3, 19.5, 19.4, 12.0, 11.8. ^{19}F NMR (376 MHz, CDCl_3): $\delta = -109.9$ (m, 4.0 F, *p/ap*), -132.2 (m, 2 F, *p/ap*). ESI-MS, positive mode: m/z (rel. int., %) = 1166.2 (100) $[\text{M}+\text{Na}]^+$ (found), 1166.2 (calculated for $\text{C}_{58}\text{H}_{60}\text{F}_6\text{NaO}_{13}\text{S}_2$ $[\text{M}+\text{Na}]^+$).

Compound 8

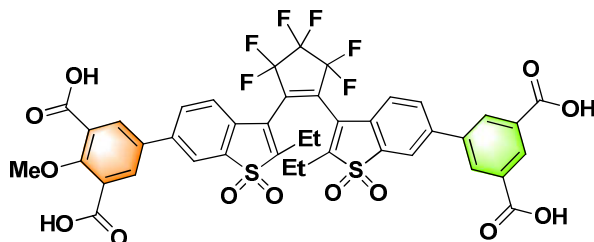

Compound **8** was synthesized from compound **S8** (18 mg, 15.7 μmol) according to GP C, and purified by flash chromatography using a RP-C18 cartridge (system E); 5 mg, 35% yield. *ap:p* = 60:40. ^1H NMR (500 MHz, DMF-d_7): $\delta = 8.71$ (br. t, $J = 1.6$ Hz, 0.6 H, *ap*), 8.64 (m, 2.4 H, *p/ap*), 8.60 (d, $J = 1.8$ Hz, 0.6 H, *ap*), 8.56 (d, $J = 1.8$ Hz, 0.4 H, *ap*), 8.53 – 8.48 (m, 1.0 H, *p/ap*), 8.36 (m, 1.0 H, *p/ap*), 8.33 (dd, $J = 1.8$ and 8.0 Hz, 0.6 H, *ap*), 8.29 (dd, $J = 1.8$ and 8.0 Hz, 0.4 H, *p*), 8.23 (m, 1.0 H, *p/ap*), 8.17 (dd, $J = 1.8$ and 8.0 Hz, 0.4 H, *p*), 8.12 (dd, $J = 1.8$ and 8.0 Hz, 0.6 H, *ap*), 8.02 (m, 1.0 H, *p/ap*, overlaps with the residual proton signals of DMF-d_7), 7.90 (d, $J = 8.0$ Hz, 0.6 H, *ap*), 7.86 (d, $J = 8.0$ Hz, 0.4 H, *p*), 4.00 (s, 1.8 H, *ap*), 3.94 (s, 1.2 H, *p*), 2.87 - 2.62 (m, 4.0 H, *p/ap*, overlaps with the residual proton signals of DMF-d_7), 1.42 (m, 2.4 H, *p*), 1.09 (m, 3.6 H, *ap*). ^{13}C NMR (126 MHz, DMF-d_7): $\delta = 167.9, 167.5, 159.8, 150.5, 150.3, 150.2, 150.0, 143.4, 143.2, 142.9, 142.8, 141.0, 140.0, 139.8, 137.6, 137.6, 137.4, 137.4, 134.7, 134.4, 134.2, 134.0, 133.9, 133.8, 133.8, 133.1, 133.0, 131.3, 130.6, 130.5, 130.1, 129.6, 129.4, 129.2, 129.0, 125.8, 123.9, 123.9, 122.4, 122.3, 122.2, 121.9, 121.9, 64.2, 64.1, 20.1, 20.0, 12.7, 12.5, 12.5, 12.4$. ^{19}F NMR (471 MHz, DMF-d_7): $\delta = -109.7$ (m, 4.0 F, *p/ap*), -130.8 (m, 2.0 F, *p/ap*). HR-MS (ESI, positive mode): 941.0748 $[\text{M}+\text{Na}]^+$ (found), 941.0768 (calculated for $\text{C}_{42}\text{H}_{28}\text{F}_6\text{NaO}_{13}\text{S}_2$, $[\text{M}+\text{Na}]^+$). HPLC (system A): $t_R = 13.1$ min (4% peak area, closed form), 13.7 min (96% peak area, open form).

Compound S9

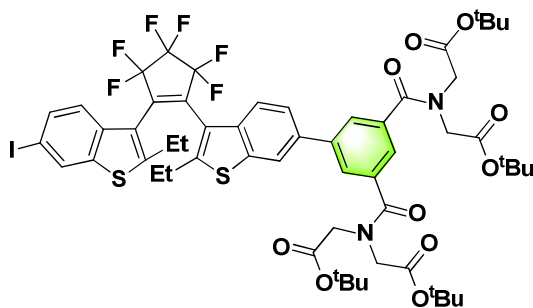

Compound **S9** was synthesized from 1,2-bis(2-ethyl-6-iodobenz[a]thiophen-3-yl)perfluorocyclopentene⁴ (100 mg, 0.134 mmol) according to GP A1, and purified by column

chromatography on silica gel gel (*n*-hexane/EtOAc, with a gradient from 100:0 to 70:30); 42 mg, 25% yield. *This compound was used in the next step without further purification (HPLC area of the main peak 85%).* R_f (*n*-hexane/EtOAc, 4:1, v/v) = 0.5. HR-MS (ESI, positive mode): 1263.2767 $[M+Na]^+$ (found), 1263.2765 (calculated for $C_{57}H_{63}F_6IN_2NaO_{10}S_2$, $[M+Na]^+$).

Compound S10

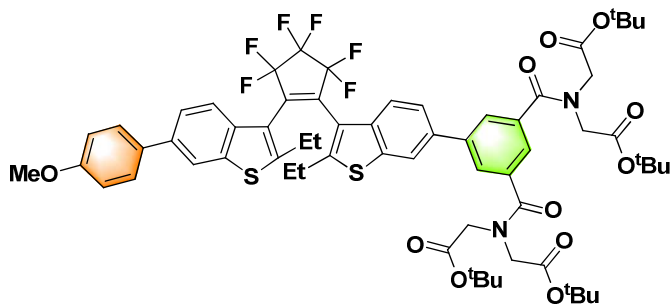

Compound **S10** was synthesized from compound **S9** (39 mg, 24.2 μ mol) according to GP A2, and purified by column chromatography on silica gel gel (*n*-hexane/EtOAc, with a gradient from 100:0 to 60:40); 20 mg, 53% yield. R_f (*n*-hexane/EtOAc, 4:1, v/v) = 0.35. *ap:p* = 70:30. 1H NMR (400 MHz, $CDCl_3$): δ = 7.92 (d, J = 1.6 Hz, 0.7 H, *ap*), 7.88 (d, J = 1.6 Hz, 0.7 H, *ap*), 7.83 (d, J = 1.6 Hz, 0.3 H, *p*), 7.79 (m, 1.0 H, *p/ap*), 7.78 (d, J = 1.6 Hz, 0.3 H, *p*), 7.71 (d, J = 2.2 Hz, 0.7 H, *ap*), 7.69 (m, 1.3 H, *p/ap*), 7.65-7.54 (m, 4.0 H, *p/ap*), 7.50 – 7.38 (m, 2.0 H, *p/ap*), 7.00 (d, J = 8.8 Hz, 1.4 H, *ap*), 7.93 (d, J = 8.8 Hz, 0.6 H, *p*), 4.21 (s, 1.1 H, *ap*), 4.20 (s, 1.1 H, *ap*) 4.18 (s, 0.4 H, *p*), 4.16 (s, 0.4 H, *p*), 3.99 (s, 2.7 H, *p/ap*), 3.93 (s, 1.0 H, *p/ap*), 3.86 (s, 2.0 H, *p/ap*), 3.81 (s, 0.8 H, *p/ap*), 2.95 - 2.74 (m, 2.6 H, *p/ap*), 2.45 (m, 1.4 H, *p/ap*), 1.50 (s, 13.0 H, *ap*), 1.48 (s, 5.0 H, *p*), 1.37 (s, 13.0 H, *ap*), 1.32 (m, 1.8 H, *p*), 1.27 (s, 5.0 H, *p*), 0.84 (m, 4.2 H, *ap*). ^{13}C NMR (126 MHz, $CDCl_3$): δ = 171.5, 168.7, 168.6, 168.3, 168.2, 159.8, 159.7, 152.3, 151.0, 142.0, 142.0, 139.4, 139.4, 139.3, 139.2, 138.6, 137.9, 137.9, 137.4, 137.0, 136.9, 135.8, 135.8, 133.5, 133.5, 128.8, 128.7, 127.5, 127.5, 124.5, 124.5, 124.4, 124.3, 124.2, 124.0, 123.0, 123.0, 122.8, 122.7, 122.5, 121.1, 121.0, 120.4, 120.3, 118.2, 118.1, 114.8, 114.7, 83.4, 83.3, 82.6, 82.6, 55.9, 55.8, 52.9, 52.8, 48.9, 28.6, 28.6, 28.4, 28.2, 23.9, 23.6, 23.5, 16.5, 16.4, 16.0, 15.8. ^{19}F NMR (376 MHz, $CDCl_3$): δ = -110.3 (m, 4.0 F, *p/ap*), -132.8 (m, 2.0 F, *p/ap*). HR-MS (ESI, positive mode): 1243.4219 $[M+Na]^+$ (found), 1243.4217 (calculated for $C_{64}H_{70}F_6N_2NaO_{11}S_2$, $[M+Na]^+$).

Compound S11

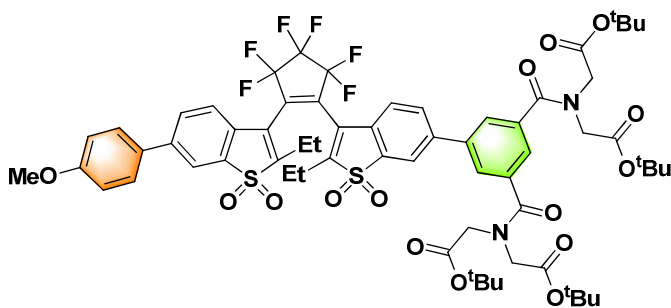

Compound **S11** was prepared from **S10** (20 mg, 16.4 μmol) according to GP B, and purified by column chromatography on silica gel gel (*n*-hexane/EtOAc, with a gradient from 100:0 to 60:40) 18 mg, 86% yield. R_f (*n*-hexane/EtOAc, 4:1, v/v) = 0.28. $ap:p = 60:40$. ^1H NMR (400 MHz, CDCl_3): $\delta = 8.06$ (bt, $J = 1.8$ Hz, 0.6 H, *ap*), 7.98 (bt, $J = 1.8$ Hz, 0.4 H, *p*), 7.96 (d, $J = 1.7$ Hz, 0.6 H, *ap*), 7.93 (d, $J = 1.7$ Hz, 0.4 H, *p*), 7.88 (d, $J = 1.7$ Hz, 0.6 H, *ap*), 7.85 (d, $J = 1.7$ Hz, 0.6 H, *ap*), 7.84 (d, $J = 1.7$ Hz, 0.4 H, *p*), 7.82 (d, $J = 1.7$ Hz, 0.4 H, *p*), 7.78 (m, 1.6 H, *p/ap*), 7.75 (d, $J = 1.7$ Hz, 0.4 H, *p*), 7.70 (d, $J = 1.5$ Hz, 0.6 H, *ap*), 7.66 (dd, $J = 1.7$ Hz & 8.0 Hz, 0.4 H, *p*), 7.62 – 7.60 (m, 3.0 H, *p/ap*), 7.45 (m, 1.0 H, *p/ap*), 7.01 (d, $J = 8.8$ Hz, 1.2 H, *ap*), 6.96 (d, $J = 8.8$ Hz, 0.8 H, *p*), 4.18 (m, 4.4 H, *p/ap*), 3.96 (s, 2.6 H, *ap*), 3.90 (s, 1.0 H, *p*), 3.87 (s, 1.8 H, *ap*), 3.83 (s, 1.2 H, *p*), 2.68 - 2.52 (m, 3.0 H, *p/ap*), 2.43 – 2.35 (m, 1.0 H, *p/ap*), 1.50 (s, 11.0 H, *ap*), 1.48 (s, 7.0 H, *p*), 1.41 (m, 13.4 H, *p/ap*), 1.32 (s, 7.0 H, *p*), 1.07 (m, 3.6 H, *ap*). ^{13}C NMR (126 MHz, CDCl_3): $\delta = 170.7$, 168.3, 168.2, 167.8, 167.8, 160.6, 160.6, 149.4, 149.1, 148.2, 147.8, 144.3, 142.2, 142.1, 139.1, 139.1, 137.2, 137.1, 137.0, 137.0, 136.6, 136.5, 134.8, 133.8, 132.4, 132.1, 131.6, 131.3, 131.2, 130.5, 130.4, 130.3, 130.0, 129.2, 128.4, 128.4, 128.4, 125.3, 125.1, 123.5, 123.4, 123.2, 123.1, 123.0, 122.8, 120.9, 120.7, 120.6, 114.9, 114.8, 83.3, 83.2, 82.4, 55.6, 55.5, 52.6, 52.5, 48.6 48.6, 28.3, 28.3, 28.1, 28.0, 19.5, 19.4, 19.3, 19.2, 12.1, 12.0, 11.9, 11.7. ^{19}F NMR (376 MHz, CDCl_3): $\delta = -109.9$ (m, 4.0 F, *p/ap*), -132.3 (m, 2.0 F, *p/ap*). HR-MS (ESI, positive mode): 1307.4004 $[\text{M}+\text{Na}]^+$ (found), 1307.4014 (calculated for $\text{C}_{64}\text{H}_{70}\text{F}_6\text{N}_2\text{NaO}_{15}\text{S}_2$, $[\text{M}+\text{Na}]^+$).

Compound 10

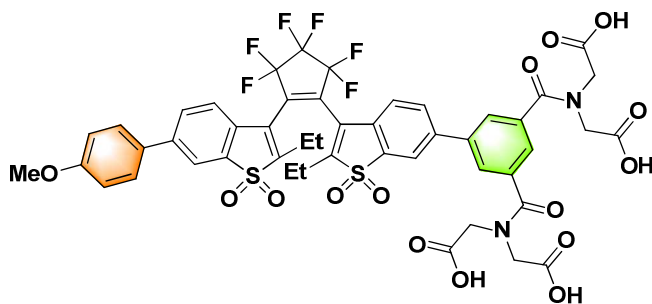

Compound **10** was prepared from **S11** (18 mg, 14.0 μmol) according to GP C, and purified by flash chromatography using a RP-C18 cartridge (system E); 7 mg, 47% yield). $ap:p = 60:40$. ^1H NMR (500 MHz, DMF-d_7): $\delta = 8.49$ (d, $J = 1.8$ Hz, 0.6 H, *ap*), 8.38 (m, 1.0 H, *p/ap*), 8.23 (m, 0.8 H, *p/ap*), 8.17 (dd, $J = 8.1$ and 1.8 Hz, 0.6 H, *ap*), 8.11 (dd, $J = 8.0$ and 1.8 Hz, 0.4 H, *ap*), 8.03 – 7.94 (m, 2.6 H, *p/ap*, overlaps with the signal of the residual CH-protons in DMF-d_7), 7.89 (m, 2.0 H, *p/ap*), 7.84 (m, 1.0 H, *p/ap*), 7.79 (d, $J = 8.1$ Hz, 0.4 H, *p*), 7.74 (d, $J = 8.1$ Hz, 0.6 H, *ap*), 7.55 (br. t, $J = 1.5$ Hz, 0.6 H, *ap*), 7.51 (br. t, $J = 1.5$ Hz, 0.4 H, *ap*), 7.14 (d, $J = 8.9$ Hz, 1.2 H, *ap*), 7.05 (d, $J = 8.9$ Hz, 0.8 H, *p*), 4.36 (s, 2.5 H, *ap*), 4.35 (m, 1.5 H, *p*), 4.33 (s, 2.5 H, *ap*), 4.27 (s, 1.5 H, *p*), 3.90 (s, 1.7 H, *ap*), 3.85 (s, 1.3 H, *p*), 2.85 – 2.70 (m, 2.5 H, *p/ap*, overlaps with the signal of the residual CH_3 -protons in DMF-d_7), 2.61 (m, 1.5 H, *p/ap*), 1.41 (m, 2.5 H, *p*), 1.03 (m, 3.5 H, *ap*). ^{13}C NMR (126 MHz, DMF-d_7): $\delta = 172.4$, 171.8, 171.7, 171.5, 162.0, 161.9, 150.7, 150.4, 149.6, 149.5, 144.9, 143.6, 143.4, 139.9, 139.8, 138.7, 138.6, 137.8,

137.8, 137.6, 137.5, 134.8, 134.4, 133.4, 133.1, 131.2, 131.1, 129.9, 129.8, 129.8, 129.7, 128.2, 127.9, 127.9, 126.7, 126.6, 126.3, 126.0, 125.8, 124.3, 124.2, 122.3, 122.1, 121.2, 121.1, 116.0, 115.9, 56.4, 56.4, 53.1, 53.0, 49.3, 49.2, 20.3, 20.3, 20.1, 20.1, 13.0, 12.9, 12.7, 12.6. ^{19}F NMR (471 MHz, DMF- d_7): $\delta = -109.7$ (m, 4.0 F, *p/ap*), -130.7 (m, 2.0 F, *p/ap*). HR-MS (ESI, negative mode): 1059.1510 $[\text{M}-\text{H}]^-$ (found), 1059.1545 (calculated for $\text{C}_{48}\text{H}_{37}\text{F}_6\text{N}_2\text{O}_{15}\text{S}_2$, $[\text{M}-\text{H}]^-$). HPLC (system A): $t_{\text{R}} = 15.4$ min (90% peak area, open form); 16.7 min (2% peak area, closed form).

Compound S12

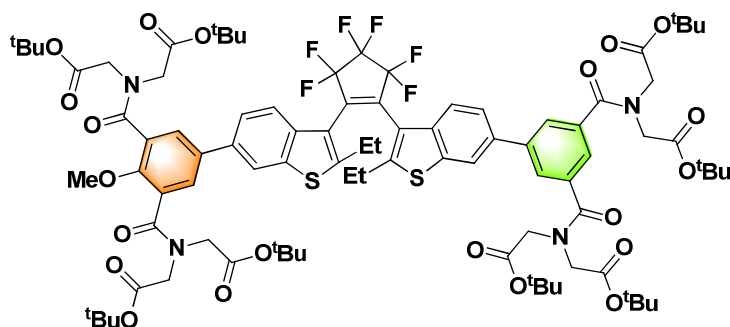

Compound **S12** was prepared from **S9** (90 mg, 72.5 μmol) according to GP A2, and purified by column chromatography on silica gel (*n*-hexane/EtOAc, with a gradient from 100:0 to 60:40) 83 mg, 65% yield. R_{f} (*n*-hexane/EtOAc, 3:2, v/v) = 0.52. *ap:p* = 70:30. ^1H NMR (400 MHz, CDCl_3): $\delta = 7.92$ (d, $J = 1.7$ Hz, 0.7 H, *ap*), 7.84 (m, 0.6 H, *p*), 7.79 (d, $J = 1.6$ Hz, 1.4 H, *ap*), 7.72 - 7.43 (m, 6.0 H, *p/ap*), 7.40 - 7.29 (m, 1.6 H, *p/ap*), 7.11 - 7.04 (m, 0.7 H, *p/ap*), 4.64 - 4.45 (m, 2.0 H, *p/ap*), 4.26 - 4.15 (m, 3.0 H, *p/ap*), 4.07 - 3.80 (m, 14.0 H, *p/ap*), 3.00 - 2.62 (m, 2.0 H, *p/ap*), 2.47 - 2.33 (m, 1.5 H, *p/ap*), 1.51 - 1.46 (m, 36.0 H, *p/ap*), 1.42 - 1.30 (m, 37.6 H, *p/ap*), 0.90 - 0.80 (m, 4.4 H, *ap*). ^{13}C NMR (126 MHz, CDCl_3): $\delta = 171.0$, 169.2, 168.2, 168.0, 168.0, 167.9, 167.8, 167.8, 151.4, 141.5, 138.9, 138.9, 138.1, 136.5, 135.3, 129.8, 127.1, 124.0, 123.7, 122.5, 122.4, 120.6, 117.6, 82.9, 82.1, 82.1, 81.9, 52.4, 51.6, 51.6, 48.4, 23.0, 23.0, 15.4, 15.4. ^{19}F NMR (471 MHz, CDCl_3): $\delta = -110.2$ (m, 4.0 F, *p/ap*), -132.9 (m, 2.0 F, *p/ap*). HR-MS (ESI, positive mode): 1785.7057 $[\text{M}+\text{Na}]^+$ (found), 1785.7057 (calculated for $\text{C}_{90}\text{H}_{112}\text{F}_6\text{N}_4\text{NaO}_{21}\text{S}_2$, $[\text{M}+\text{Na}]^+$).

Compound S13

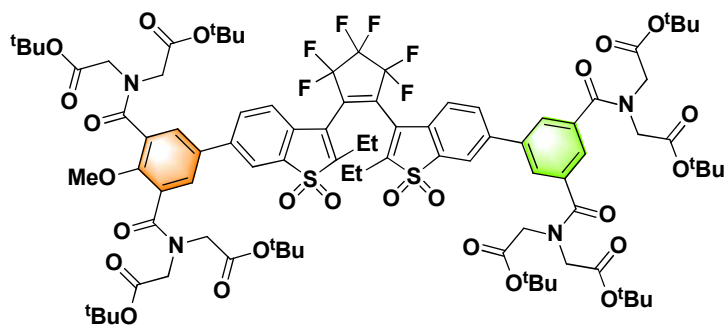

Compound **S13** was synthesized from **S12** (70 mg, 39.7 μmol) according to GP B, and purified by column chromatography on silica gel gel (*n*-hexane/EtOAc, with a gradient from 100:0 to 60:40); 36 mg, 50% yield. R_f (*n*-hexane/EtOAc, 3:2, v/v) = 0.45. *ap:p* = 65:35. ^1H NMR (400 MHz, CDCl_3): δ = 8.03 - 7.70 (m, 6.35 H, *p/ap*), 7.66 - 7.47 (m, 3.65 H, *p/ap*), 7.28 - 7.19 (m, 1.0 H, *p/ap*, overlaps with the signal of the residual CH-protons in CDCl_3), 4.61 - 4.41 (m, 2.0 H, *p/ap*), 4.26 - 4.13 (m, 4.0 H, *p/ap*), 4.05 - 3.81 (m, 13.0 H, *p/ap*), 2.67 - 2.47 (m, 2.4 H, *p/ap*), 2.39 - 2.26 (m, 1.6 H, *p/ap*), 1.52 - 1.44 (m, 38.0 H, *p/ap*), 1.40 - 1.28 (m, 36 H, *p/ap*), 1.07 - 0.97 (m, 4.0 H, *ap*). ^{19}F NMR (376 MHz, CDCl_3): δ = -109.8 (m, 4.0 F, *p/ap*), -132.2 (m, 2.0 F, *p/ap*). HR-MS (ESI, positive mode): 1849.6860 $[\text{M}+\text{Na}]^+$ (found), 1849.6853 (calculated for $\text{C}_{90}\text{H}_{112}\text{F}_6\text{N}_4\text{NaO}_{25}\text{S}_2$, $[\text{M}+\text{Na}]^+$).

3. Immunolabeling and fluorescence imaging

3.2 Photoswitching of bioconjugates

To ensure that the DAEs bound to proteins were still photochemically active, diluted samples (in MeOH and PBS; pH = 7.4) of the bioconjugates were placed into a 1 cm path quartz cuvette and irradiated under conditions similar to the conditions used for photoswitching of the free dyes, in MeOH and PBS. Photoisomerizations of the probes in both directions (with 365 nm light (OF→CF) and 470 nm (CF→OF) light) were observed, with the concomitant changes in fluorescence emission (Figure S1).

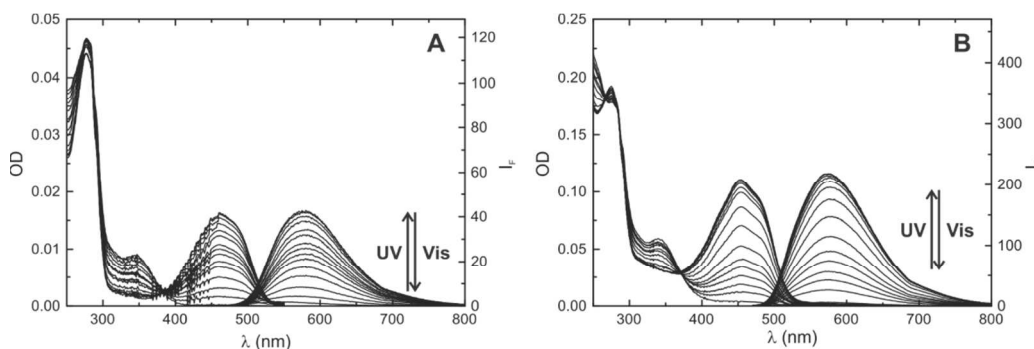

Figure S1. Absorption and emission changes upon irradiation of two representative bioconjugates of **4-Et** (DOL = 3, A) and **11** (DOL = 5, B) in PBS (pH = 7.4). Diluted samples in a 1 cm-path quartz cuvette were irradiated under continuous stirring. Typical irradiation light powers were around 20–30 mW. Absorption and emission spectra were recorded after each irradiation step (10–60 s).

3.3 Immunolabeling protocol

Vero cell samples cells were grown on standard cover slips and then fixed with previously cooled (-20 °C) methanol for 5 min, and blocked with 5% (w/v) BSA in PBS pH = 7.4 (blocking buffer). Then the cells were incubated with a primary antibody at r.t. for 1 h, followed by three washing steps of 5 min each with blocking buffer. The cells were then incubated at r.t. for 1 h with the labelled bioconjugates (typical dilutions of 1:50 to 1:100 from the purified bioconjugate), washed again (5 min each step) three times with blocking buffer and, finally, with mounting medium (PBS, pH 7.4). The samples were mounted with PBS (pH = 7.4) in concave microscopy slides and sealed with a silicone resin (Picodent Twinsil) to prevent leakage. As primary antibodies (Abcam, Cambridge, UK), mouse and rabbit anti- α -tubulin, mouse anti-NUP 153, and rabbit anti-vimentin were used.

3.4 Confocal images

Standard confocal images were acquired in a commercial Leica TCS SP5 confocal microscope. Images (Figures S2 and S3) were recorded with 488 nm excitation, after a short (ca. 1-5 s) and low-intensity wide-field pre-activation with ~366 nm light, from the mercury lamp. Detection was collected between 520 and 670 nm. A fading of the signal was observed after one or several consecutive scans of the same area, due to the isomerization (CF→OF) induced by the excitation light (a process competing with fluorescence emission of the probe). The signal can be recovered with another pre-activation pulse, and thus further imaging of the same area can be repeated several times.

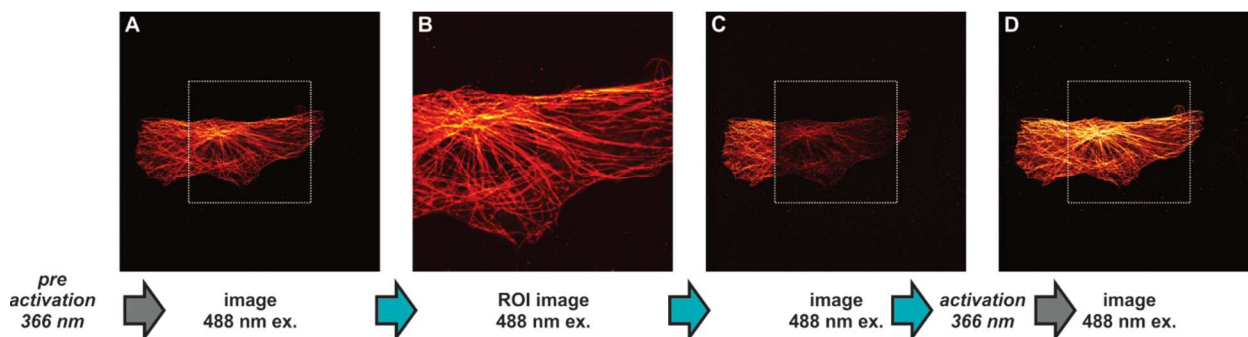

Figure S2. Confocal imaging with a **4-Et** bioconjugate. First, an overview of a cell was recorded (A). Then, an image of the ROI (boxed area in A) was acquired (B). The pixel size in B is smaller than in A, C-D, and thus markers received a higher light dose. The following overview image (C) shows the fading of the signal in the ROI. The signal is recovered (D) after a short exposition (a few seconds) to UV light (wide-field illumination of a Hg lamp selected with a filter), which demonstrates that the fading was due to the cycloreversion of the DAE markers.

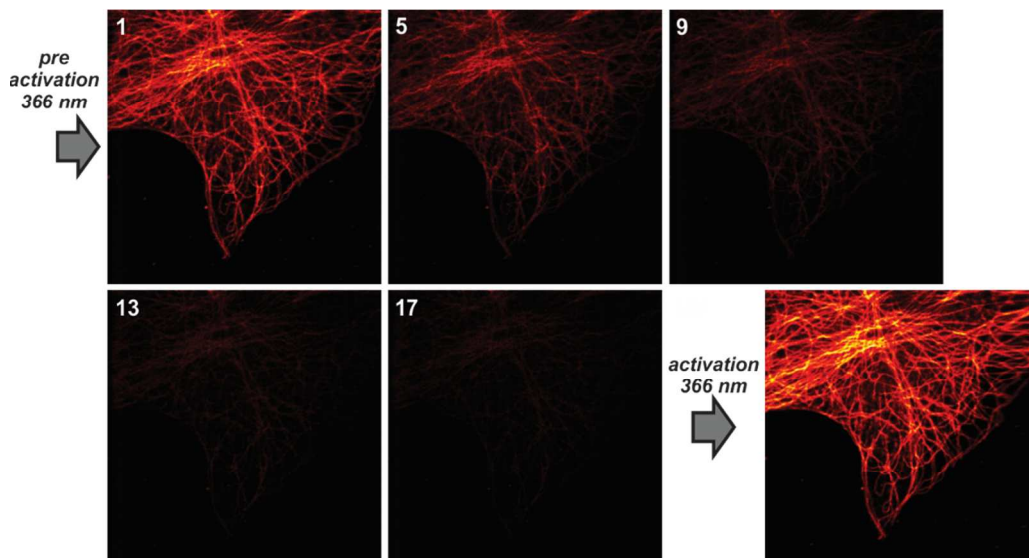

Figure S3. Confocal imaging with a **11** bioconjugate. A total of 17 frames were successively acquired on the same FOV (frames 1, 5, 9, 13, and 17 are shown). The sample was then exposed for a few seconds to UV light (wide-field illumination of a Hg lamp selected with a filter), and a new frame was acquired. Exact same imaging settings were used for all frames.

3.5 Superresolution (PALM/STORM) imaging

3.5.1 STORM Microscope:

The microscope (Figure S4) is based on a commercial microscope stand (Olympus IX71) and imaging was carried out using a 100 x 1.4 NA oil-immersion objective (OB: Olympus UPLSAPO 100XO). Excitation light sources included a 488 nm Argon laser (L 488: Innova 70C Argon filled, Coherent, ~ 0.5 kW/cm²), and a 375 nm laser diode (L 375: CUBE 375, Coherent, ~ 13 W/cm²). The 488 nm was modulated using an acousto-optic tunable filter (AOTF: PCAOM VIS, Crystal Technology). The 375 nm beam was combined into the excitation beam path after the AOTF by a dichroic mirror (Di01-R405-25x36, Semrock), and was modulated using its own digital & analog modulation inputs. The combined beams were expanded and cropped using an aperture, in order to achieve a relatively flat illumination profile, before being focused to the back focal plane of the objective lens, such that the light beam reaching the sample is collimated. The lateral position of the excitation beam focus in the objective was adjusted using a translation stage in the excitation beam path, such that the illumination could be brought in to a total-internal-reflection (TIRF) configuration.

A quad band dichroic mirror (ZT405/488/561/640rpc, Chroma) was used to separate the incoming excitation light from the outgoing fluorescence. The fluorescence was further filtered using a quad band notch filter (NF01-405/488/557/640-25x5.0-D, Semrock) and a band-pass filter (FF01-582/75-25, Semrock). The fluorescence image of the sample was relayed through a telescope and detected using an EMCCD camera (IXON+ DU860, Andor Technologies).

Sample focus was maintained during imaging using a custom-built focus lock system. An infrared laser beam was introduced into the microscope through the right side port and coupled into the optical path using a dichroic mirror (900SPRDC, Chroma). The beam was focused to the back focal plane of the objective and the focal position was adjusted to bring the beam into TIRF at the water-glass interface in the sample. The position of the reflected beam was monitored using a quadrant-photodiode and this provided a measure of the sample position above the objective lens. The objective lens position was then continuously adjusted using a piezo positioner (MIPOS 250, Piezo Jena). Residual infrared light was blocked in the detection path using a short-pass filter (FF01-842/SP-25, Semrock).

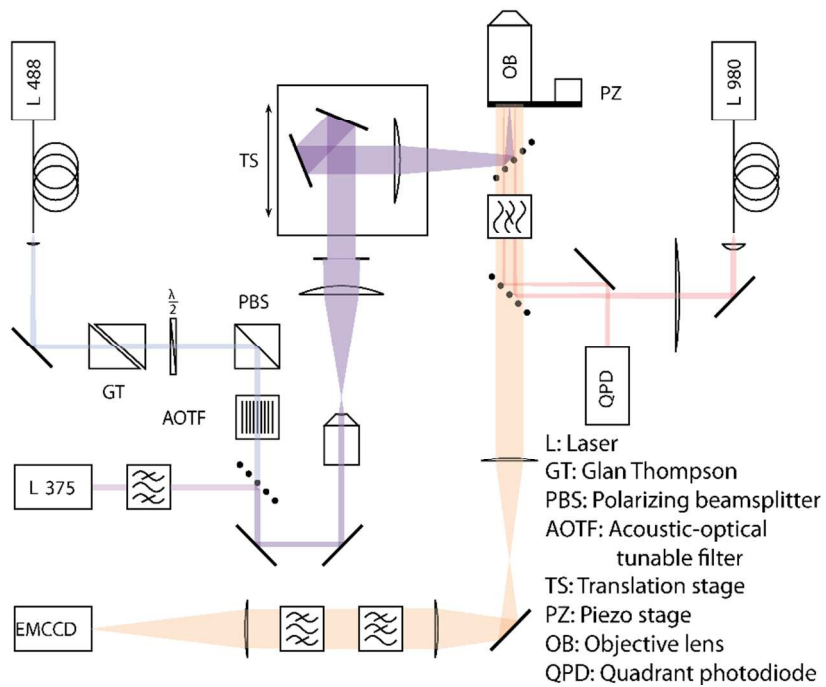

Figure S4. Schematic representation of the microscope used, a custom-build wide field microscope with a TIRF illumination system.

3.5.2 Detected photons per switching event

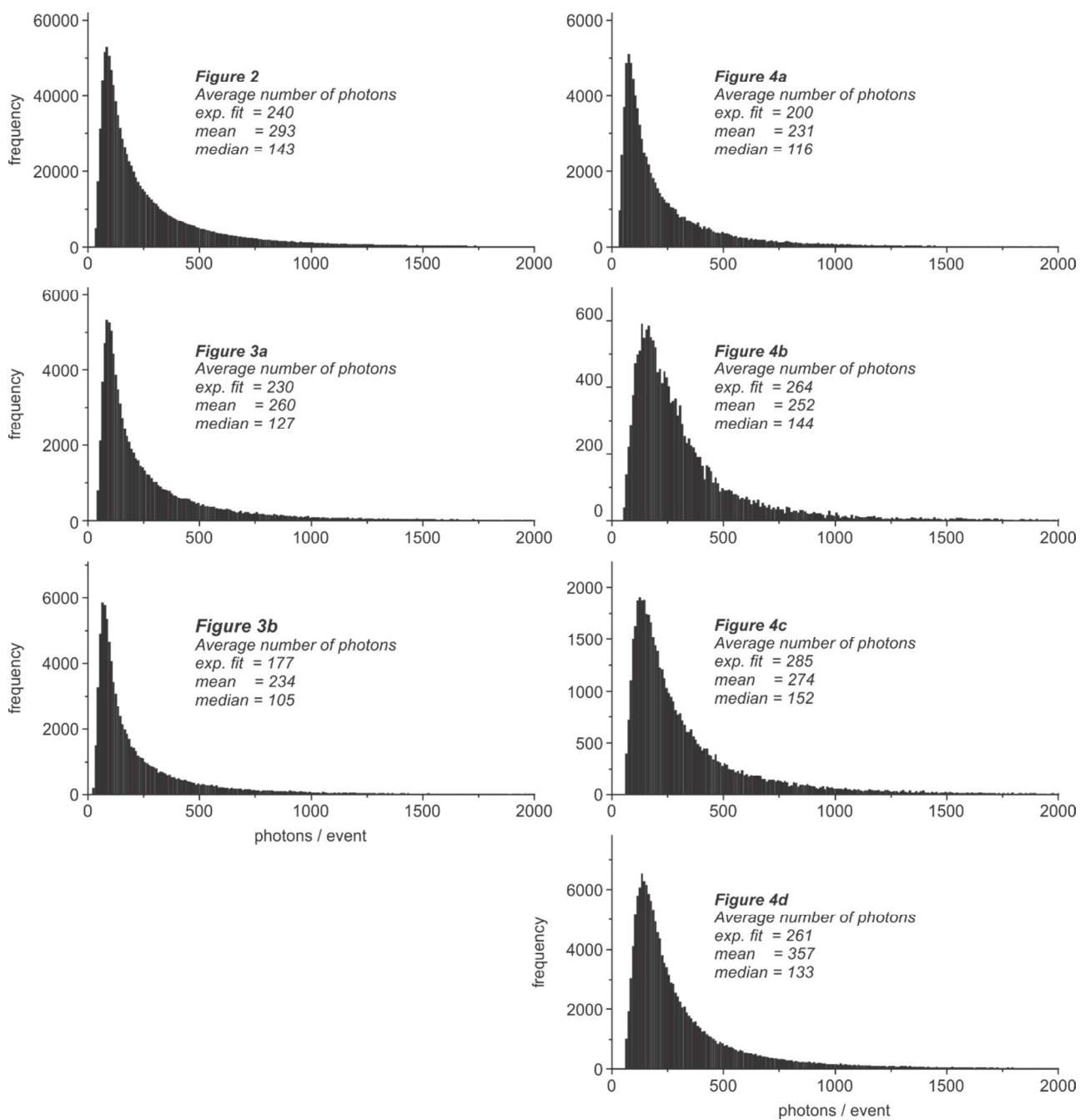

Figure S5. Histogram of detected photons per switching event, generated from every single molecule localized and used to reconstruct superresolution images presented in the text (Figures 2 – 4). The average values reported for each case were calculated from a mono-exponential fit, as in Dempsey *et al.* (6). When calculating the mean or median value, only photon counts on the right side of the distribution (larger than the maximum of the histogram) were considered.

3.5.3 Photoinduced control of the amount of events per frame

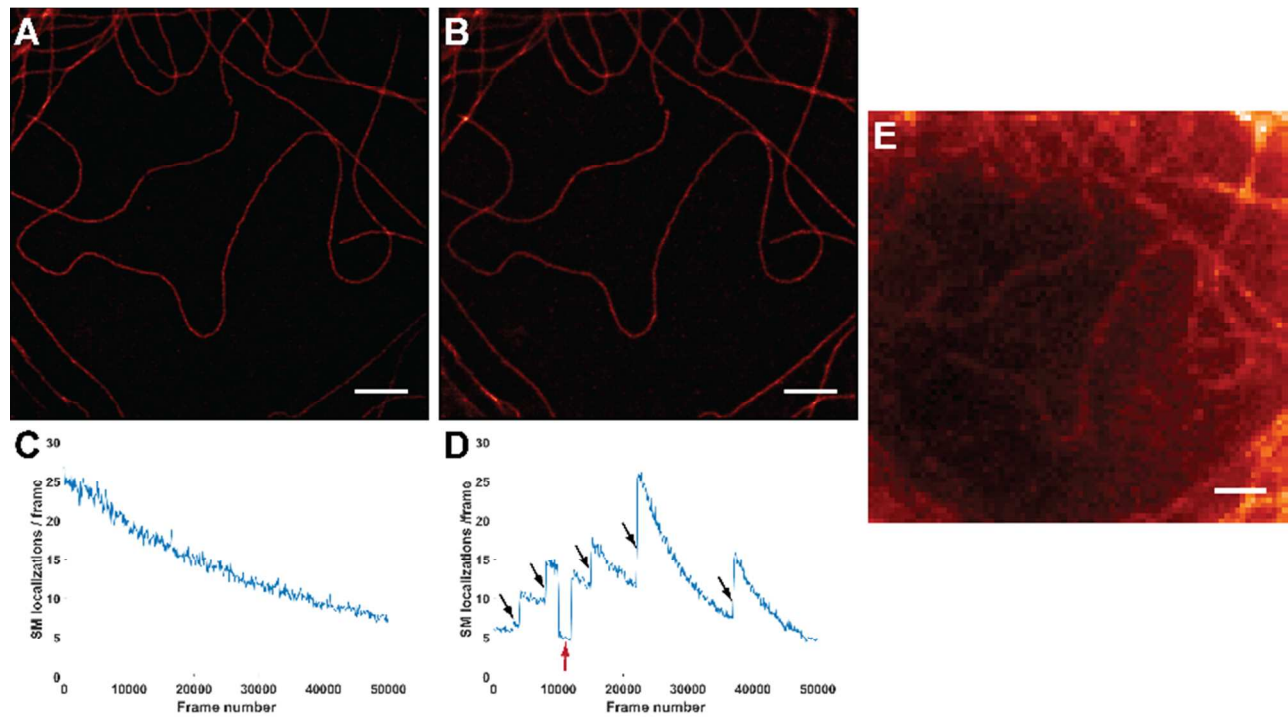

Figure S6. Superresolution images (STORM) without (A) and with activation light of 375 nm (B), of Vero cells immunostained with a primary antibody against tubulin and a secondary antibody labelled with compound **4-Et** (DOL = 3.5). Mounting media used was PBS pH = 7.4. No photoactivation (only excitation at 488 nm) was used in the first 50000 frames; slow photobleaching is evidenced by an exponential decay of the detected events per frame (C). Then, the activation laser was enabled at low power and increased stepwise, as indicated by black arrows in (D). The activation laser was disabled for ca. 2000 frames (red arrow); spontaneous activations is still present, but at a lower rate than in the presence of photoactivation (the latter is ~3-fold higher). At the end of the image acquisition, the activation laser was considerable increased beyond the condition to achieve a sparse distribution but enough to achieve a wide field image; a frame (only 10 ms integration) is shown in (E). This demonstrates the remaining amount of usable markers after 100000 frames. The inhomogeneity of the bleaching is also appreciated. Scale-bars: 2 μ m.

3.6 Photoswitching fatigue resistance of compounds 4-Et and 11 at the ensemble level, in methanol and aqueous buffered solutions

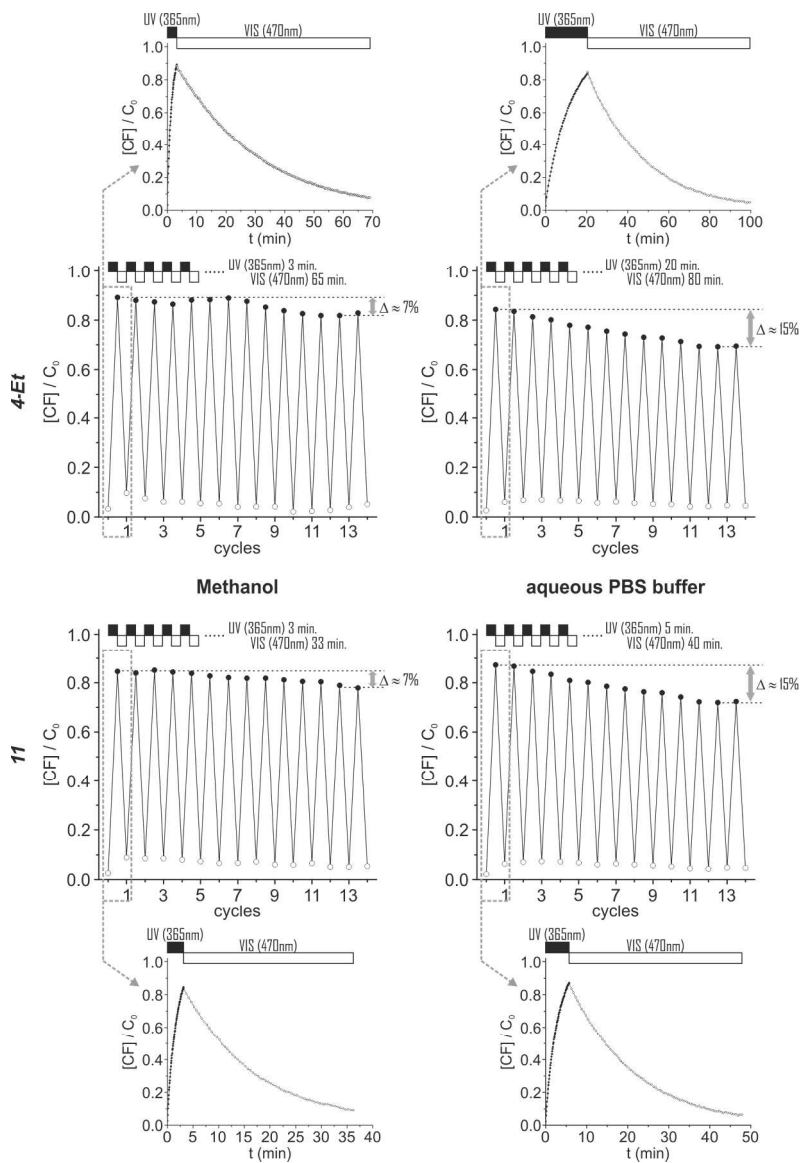

Figure S7. Photoswitching fatigue resistance of compounds 4-Et and 11 in methanol and aqueous PBS. Solutions of each compound (OF) were freshly prepared ($c_0 = 4\text{--}5\ \mu\text{M} = [\text{OF}] + [\text{CF}]$). The samples (3 mL) were irradiated under continuous stirring with UV light (365 nm), until 85–90% conversion to the CF ($\alpha_{\text{CF}} = [\text{CF}]/c_0 > 0.85$) was achieved, and then irradiated with visible light (470 nm), until the reaction was reversed to a conversion below 10 % ($\alpha_{\text{CF}} < 0.10$). The intensity of the irradiation sources (20 mW/cm² and 35 mW/cm² for UV and visible light, respectively) was the same in all experiments. The time required for each semi-cycle was found ($t_{\text{UV}} = 3\text{--}20$ min and $t_{\text{VIS}} = 33\text{--}80$ min) and used for repeating the photoconversion for 14 full cycles (in total, 8 – 23 hours of irradiation was required for each solution). The degree of conversion was evaluated by measuring the absorption of the closed form in the visible range using a single beam spectrometer. The amount of compound irreversibly photobleached after 14 cycles was very similar for both compounds, and amounted to 7% in methanol, and 15 % in PBS ($\pm 2\%$). From this experiment, we can conclude that these compounds can endure in average several tens of cycles, determined from the number of cycles needed to photobleach half of the initial dye amount.

3.7 Fourier ring correlation analysis of the images

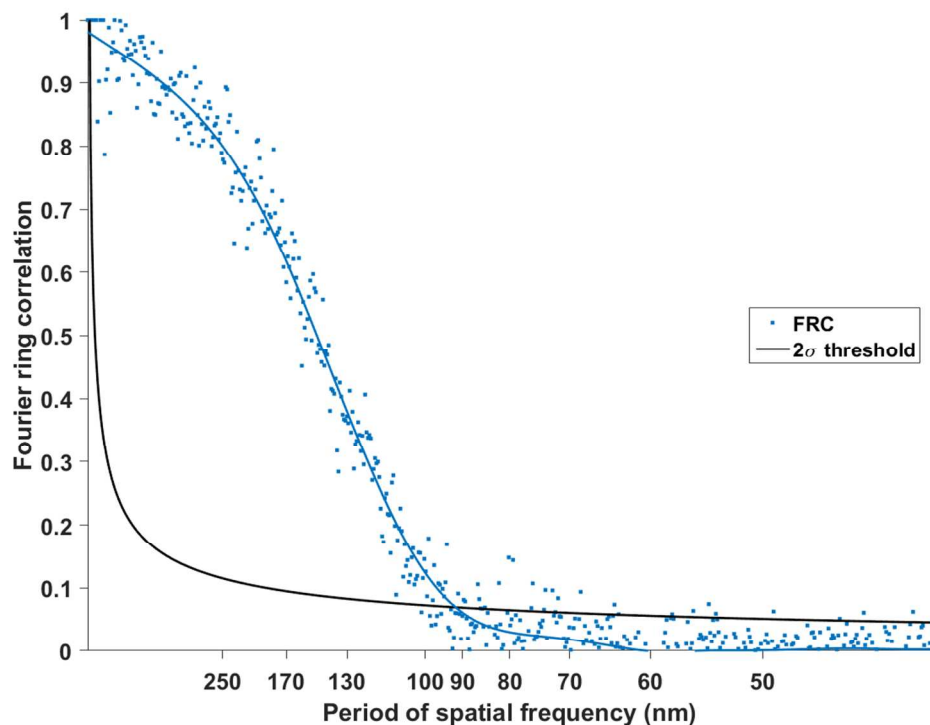

Figure S8. Fourier ring correlation (FRC) of the localizations presented in Figure 2; a smoothed FRC curve is shown as a solid blue line within the noisy FRC data (blue dots). The resolution of the image is estimated from the intersection between the FRC and the 2σ threshold, yielding a value of around 90 nm.

3.8 Imaging in “blinking buffer”

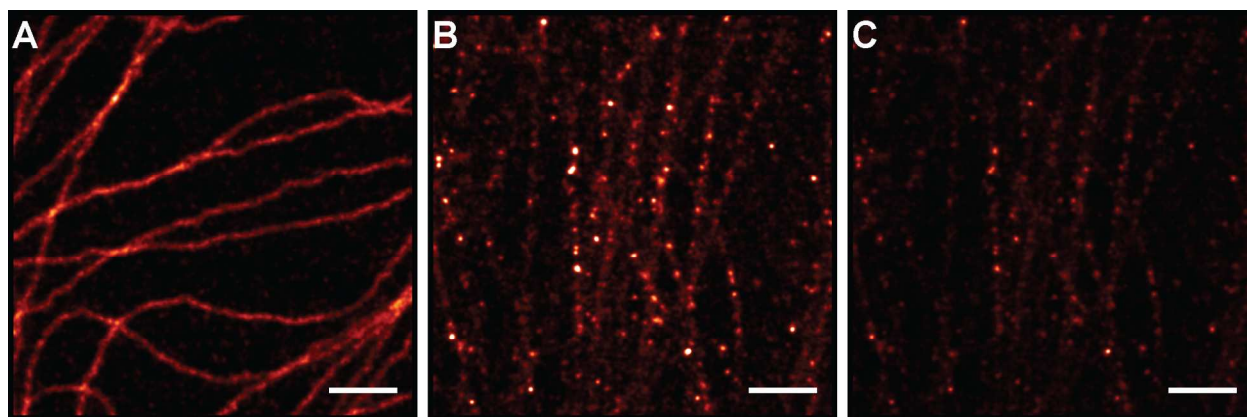
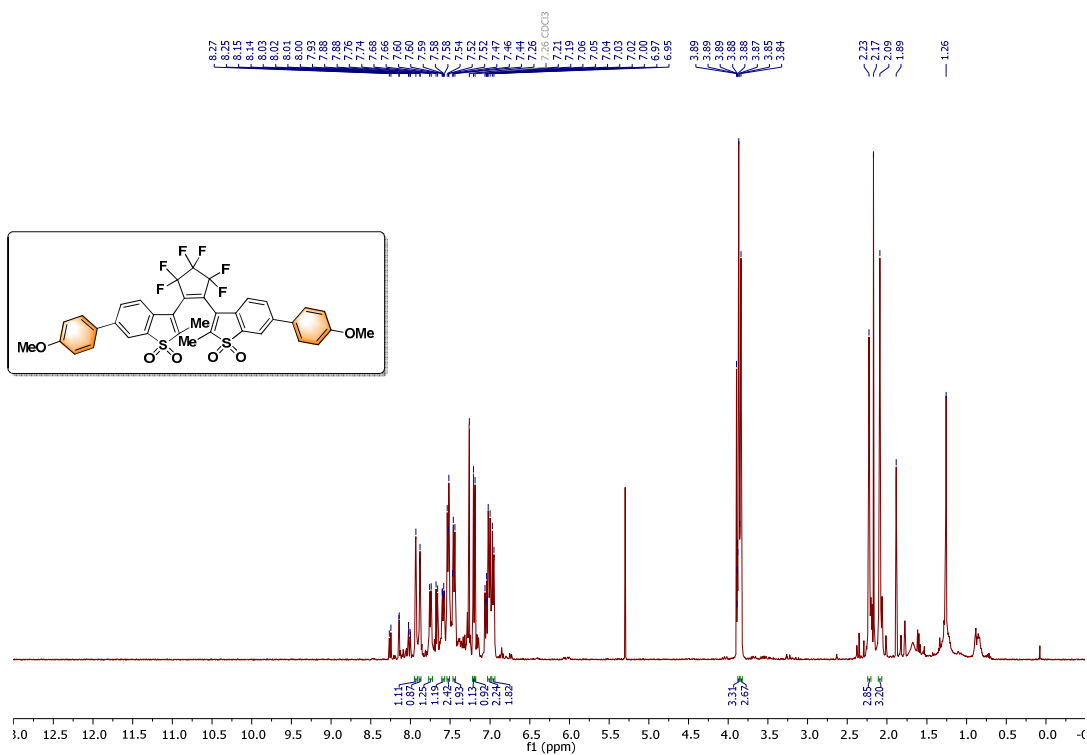

Figure S9. Superresolution images (STORM) of Vero cells immunolabeled with primary antibody against tubulin and secondary antibodies conjugated with compound **4-Et** in (A) PBS pH = 7.4 and (B-C) in blinking buffer without UV activation. The image in B is the same as in C, with a saturated colormap. The blinking buffer (TRIS pH = 8.0) contained an enzymatic oxygen scavenger system and β -mercaptoethylamine. Scale-bars: 1 μ m.

4. NMR spectra and RP-HPLC traces of symmetric dimethoxy DAEs derivatives: compounds 3, 4-Me and 4-Et

Compound 3

^1H NMR spectrum in CDCl_3 (400 MHz)



^{13}C NMR spectrum in CDCl_3 (500 MHz)

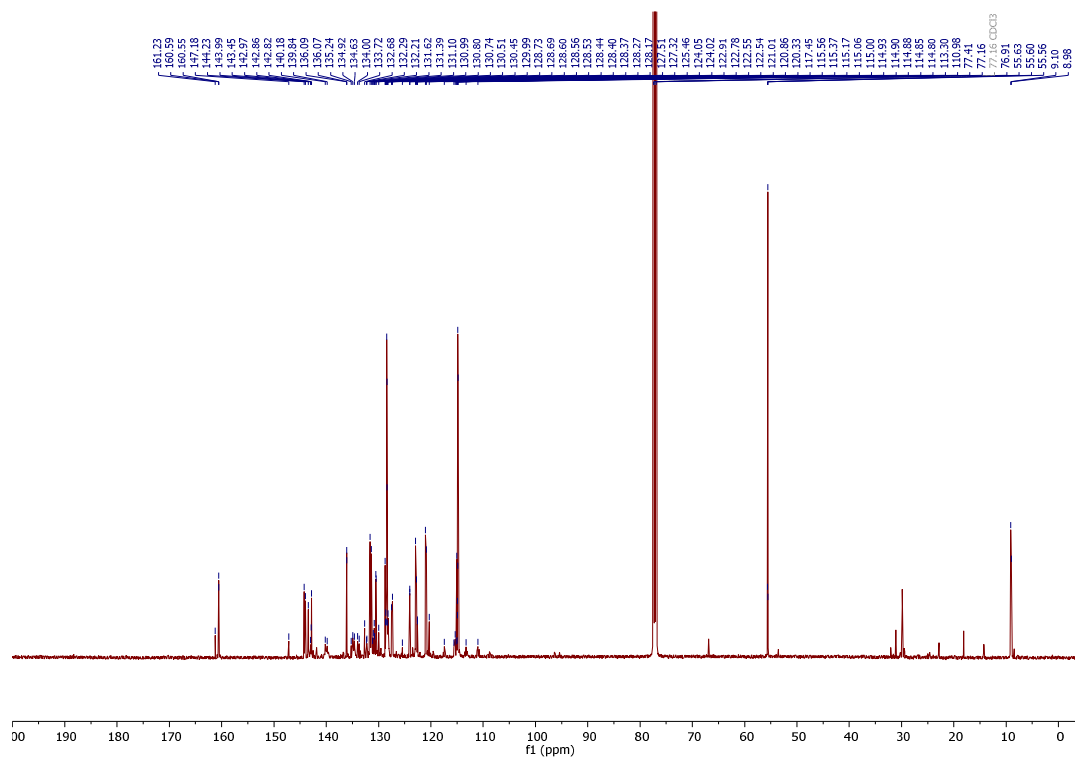

^{19}F NMR spectrum in CDCl_3 (471 MHz)

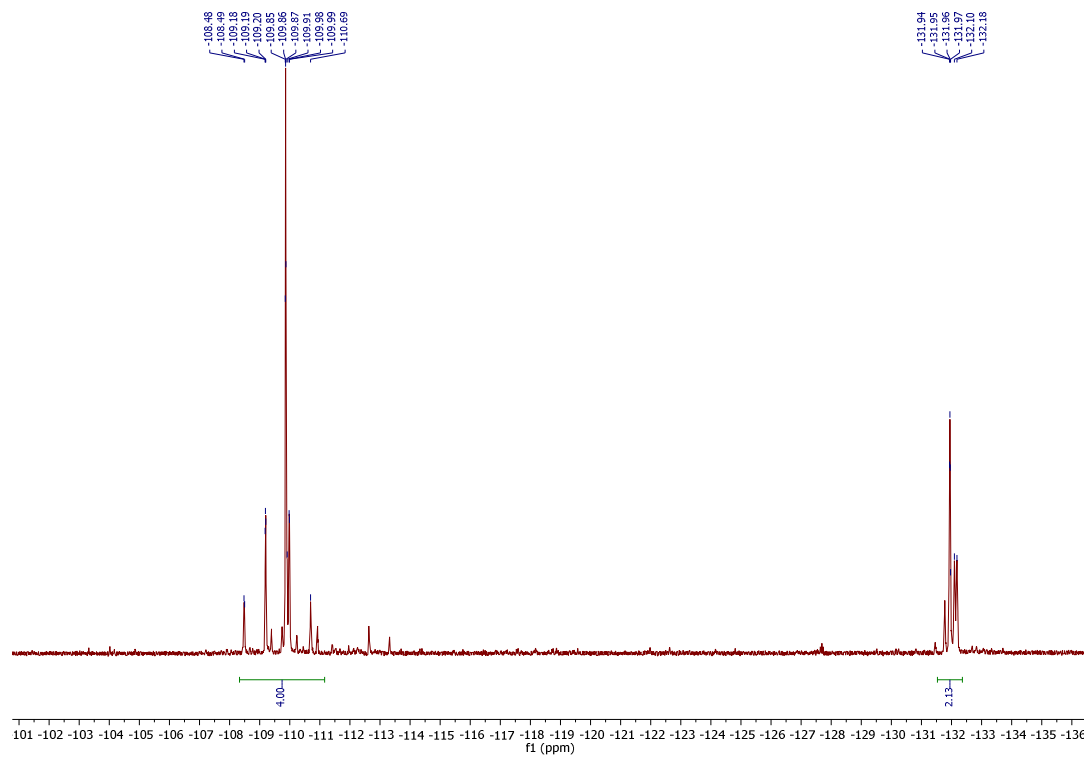

Compound 4-Me

^1H NMR spectrum in DMF- d_7 (400 MHz)

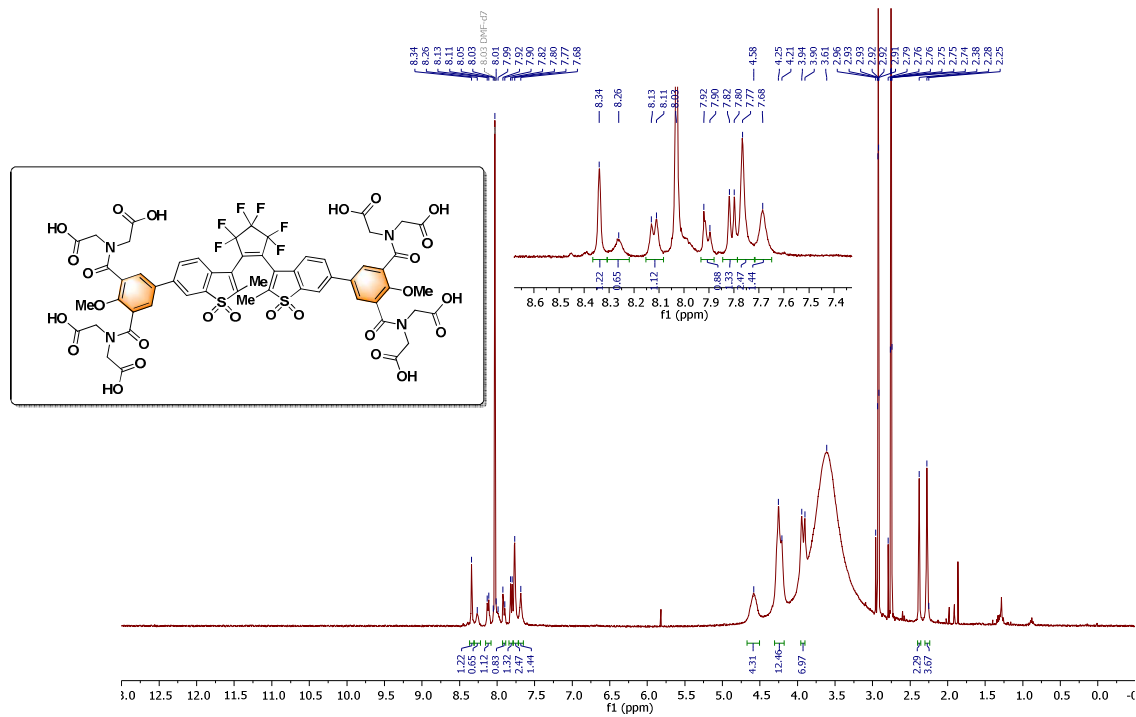

^{13}C NMR spectrum in DMF- d_7 (500 MHz)

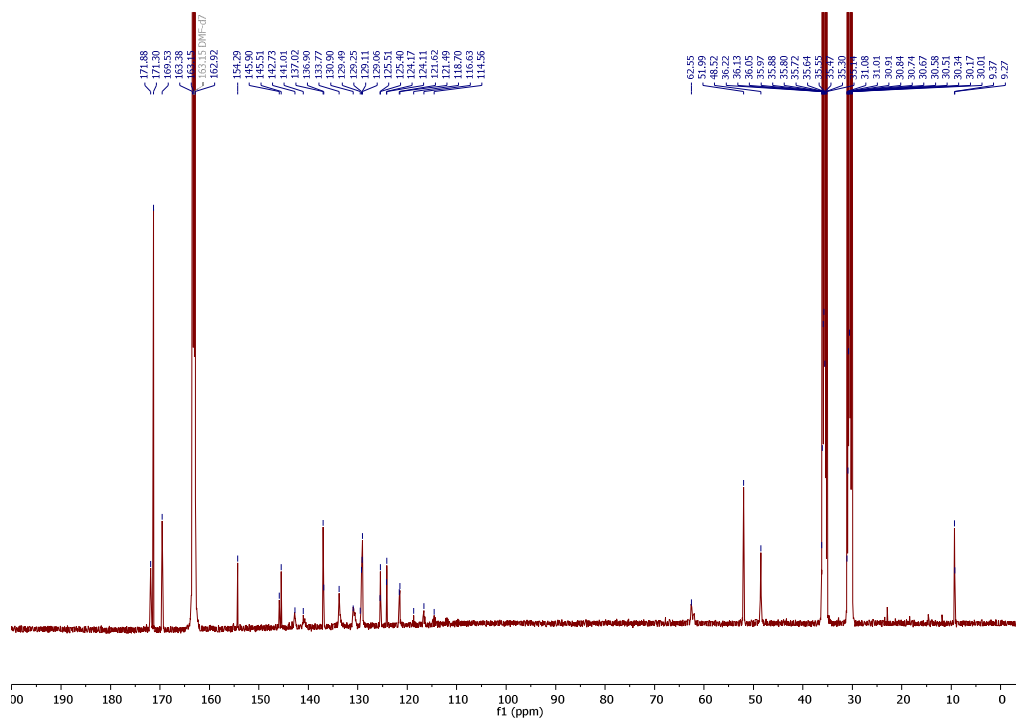

^{19}F NMR spectrum in DMF- d_7 (376 MHz)

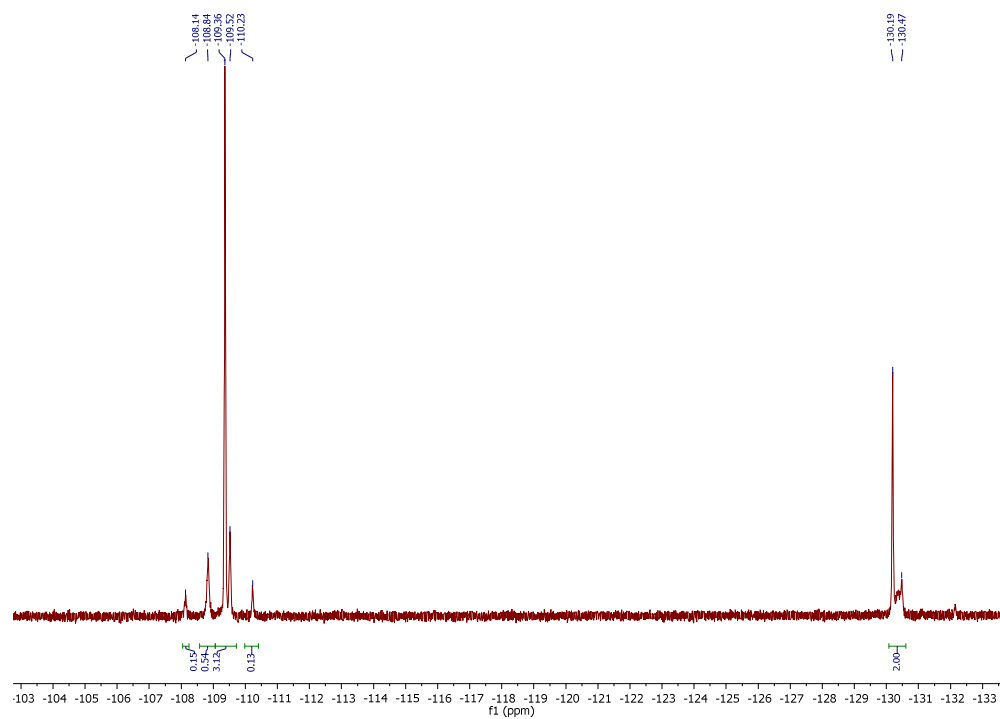

RP-HPLC elution profile (system A)

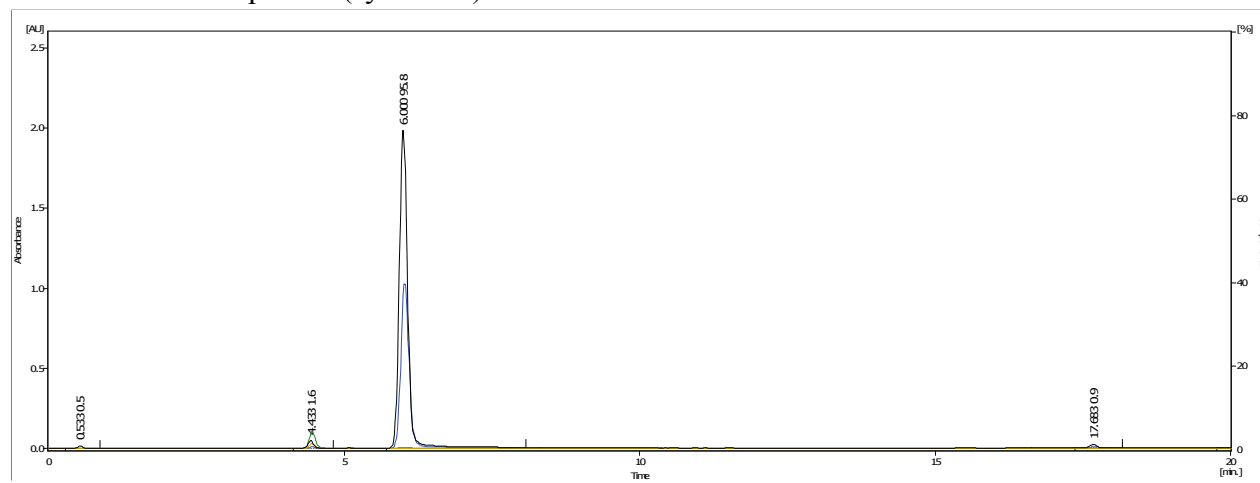

Compound 4-Et

¹H NMR spectrum in DMF-d₇ (400 MHz)

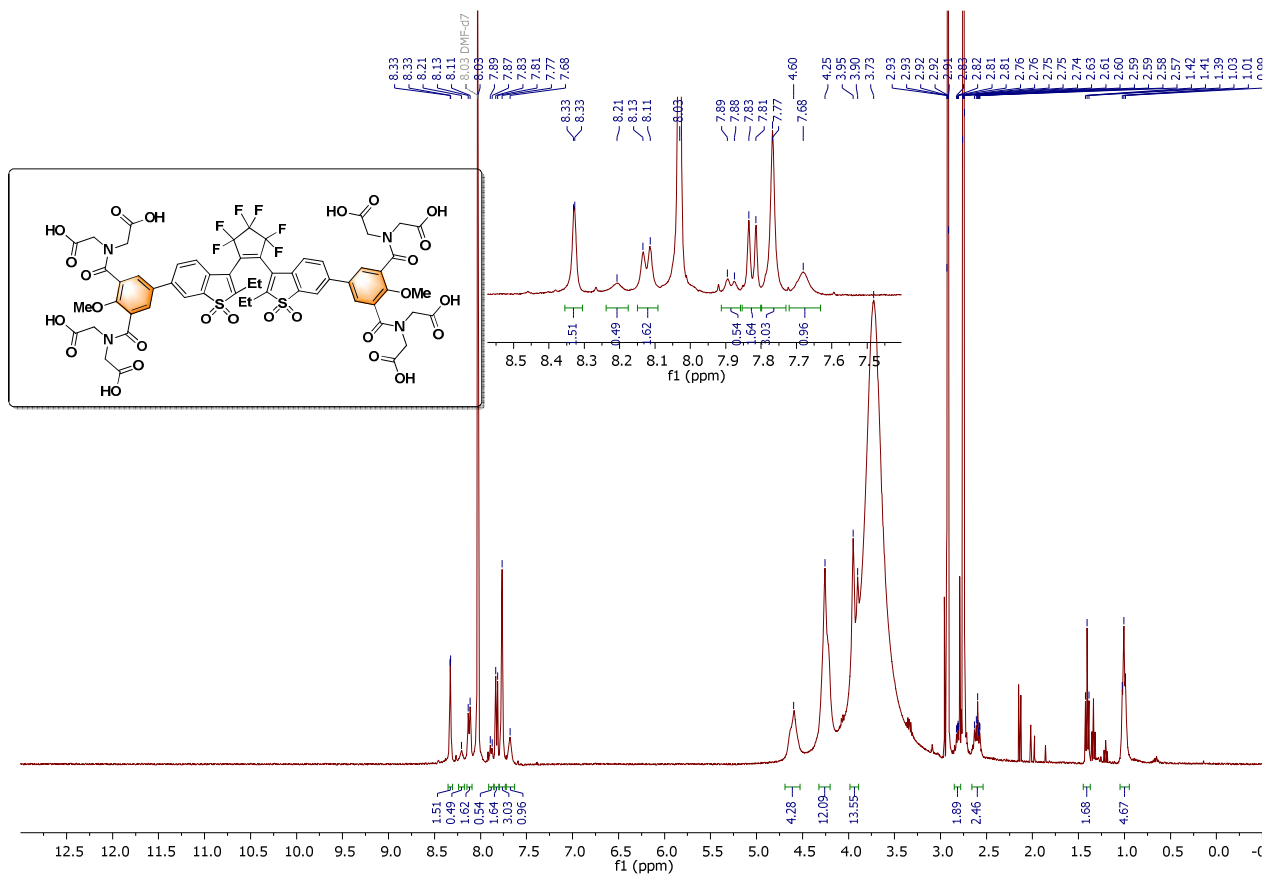

^{13}C NMR spectrum in DMF- d_7 (126 MHz)

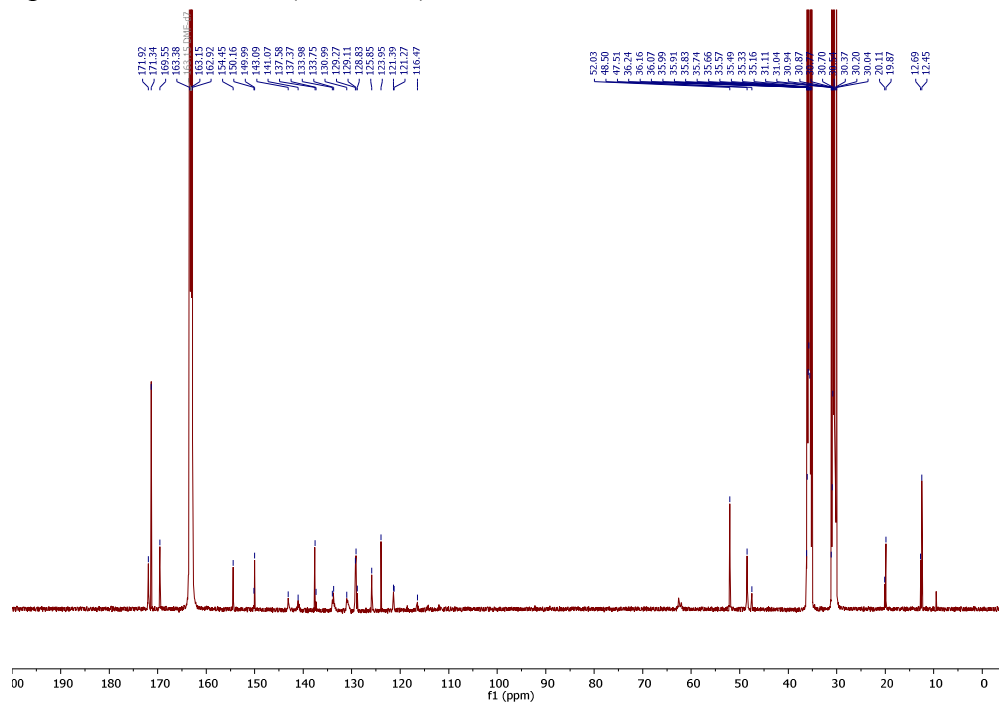

^{19}F NMR spectrum in DMF- d_7 (376 MHz)

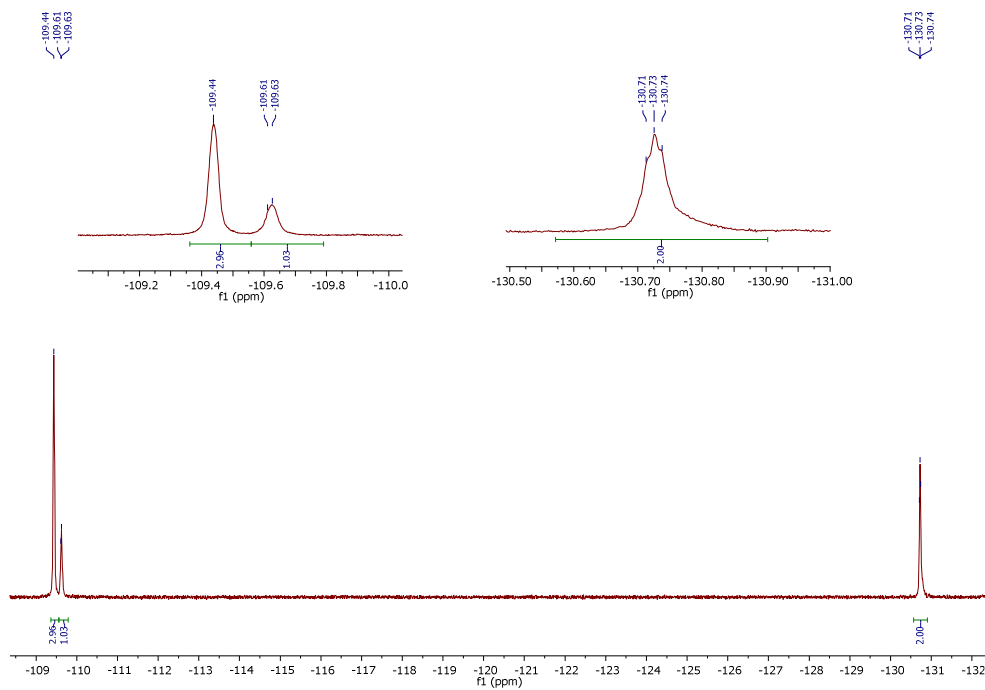

RP-HPLC elution profile (system F); “open-ring” isomer – red trace (254 nm), “closed-ring” isomer – blue trace (470 nm):

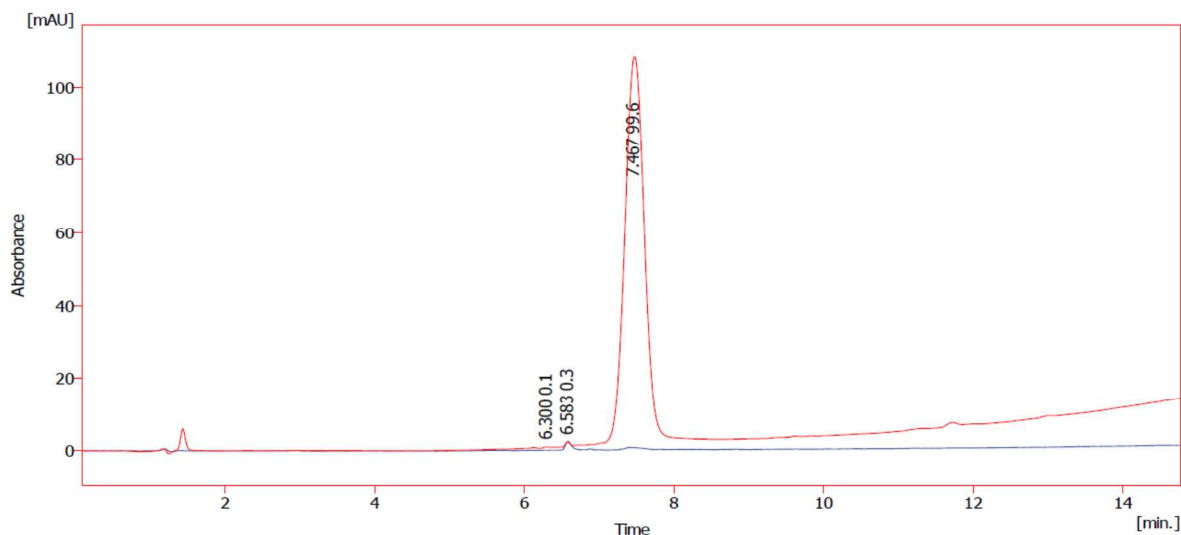

RP-HPLC elution profile (system F); “closed-ring” isomer showing green trace (254 nm) and black trace (470 nm) was isolated by HPLC and immediately analyzed in CD₃OD:

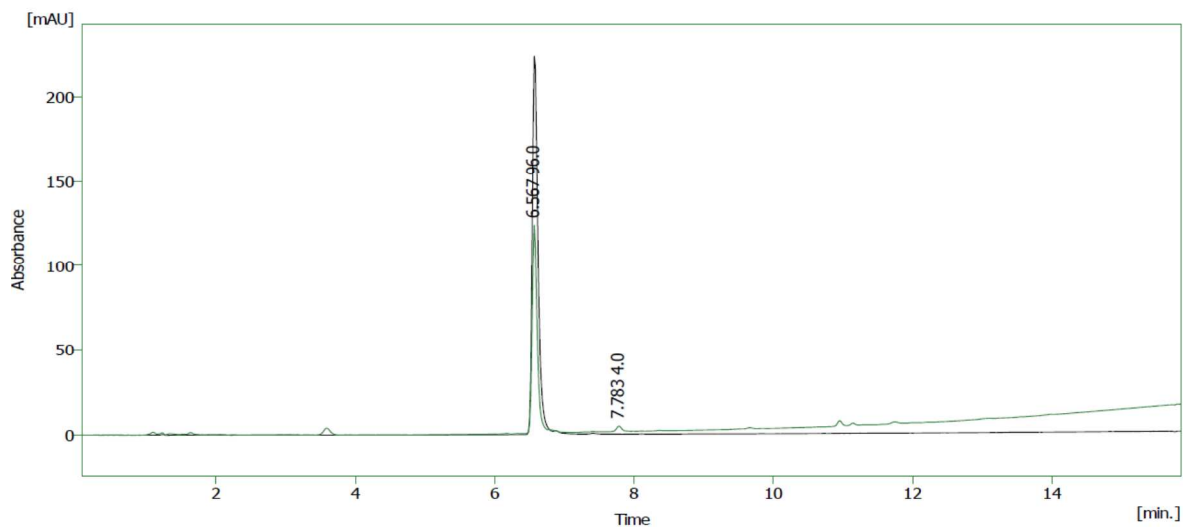

RP-HPLC elution profile (system F): “closed-ring” isomer in CD₃OD solution after storing for 3 weeks in the dark at room temperature; relative intensities of the red (254 nm) and blue (470 nm) traces indicate that the peak with $t_R = 7.43$ min is not an “open-ring” isomer:

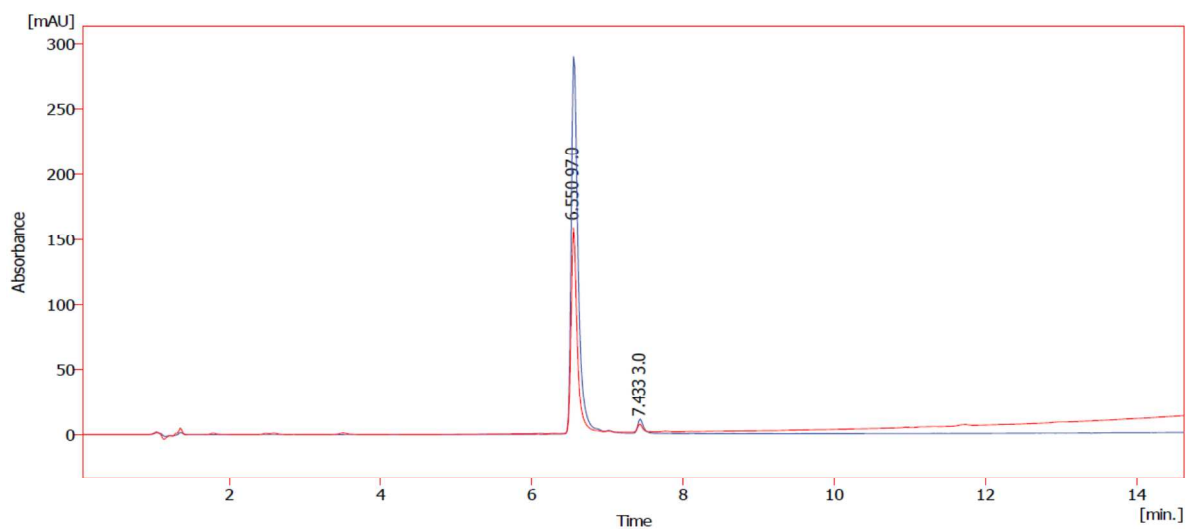

5. NMR spectra and RP-HPLC traces of asymmetric DAEs derivatives

Compound S5a

^1H NMR spectrum in CDCl_3 (400 MHz)

* peaks assigned to residual EtOAc

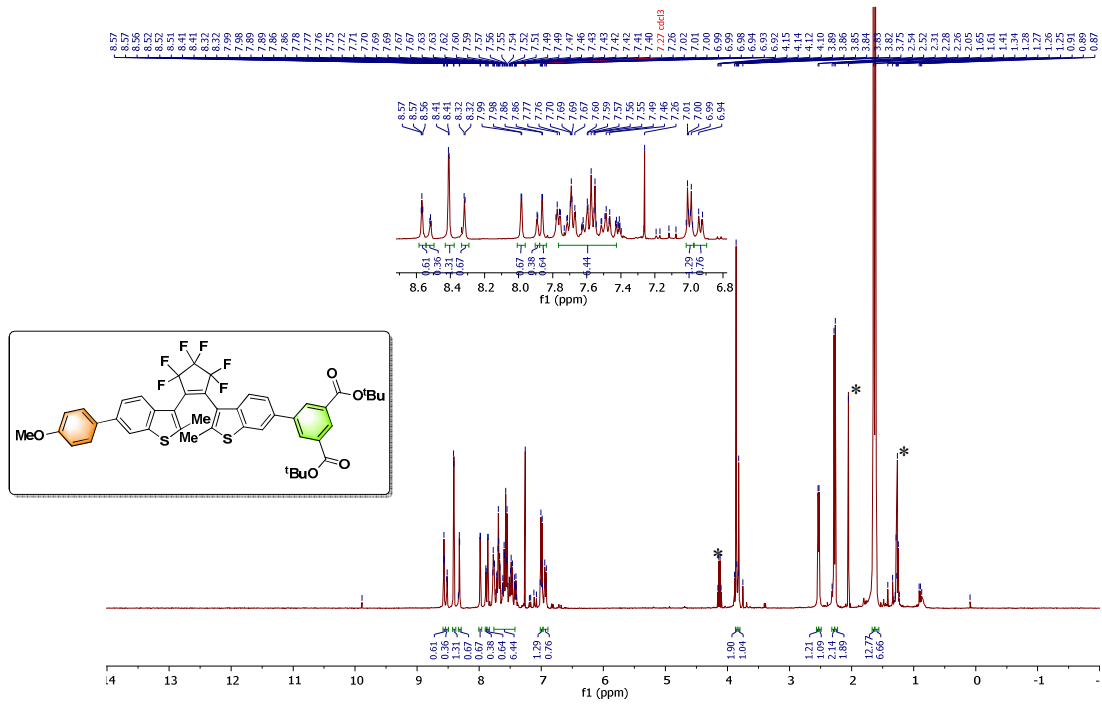

^{13}C NMR spectrum in CDCl_3 (101 MHz)

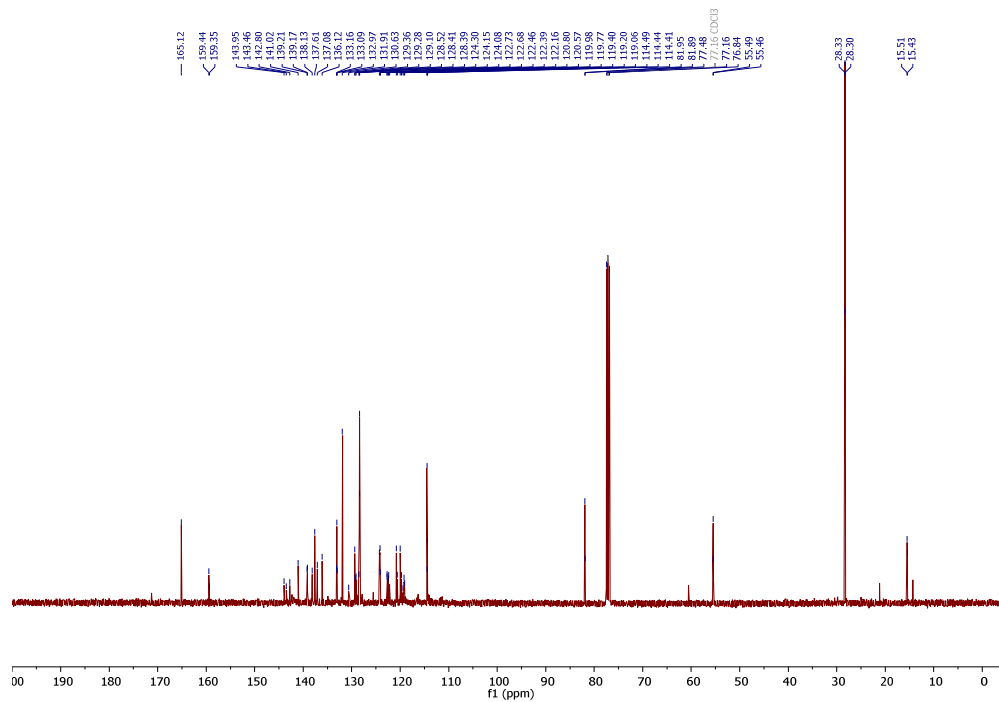

^{19}F NMR spectrum in DMF-d_7 (376 MHz)

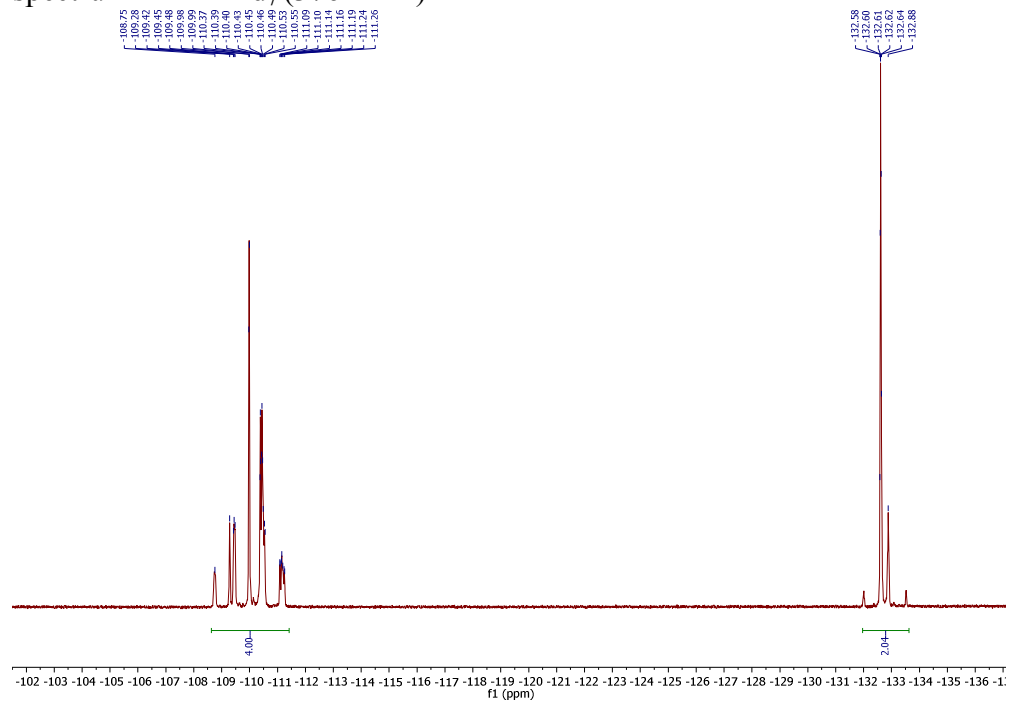

Compound S5b

¹H NMR spectrum in CDCl₃ (400 MHz)

* peaks assigned to residual EtOAc

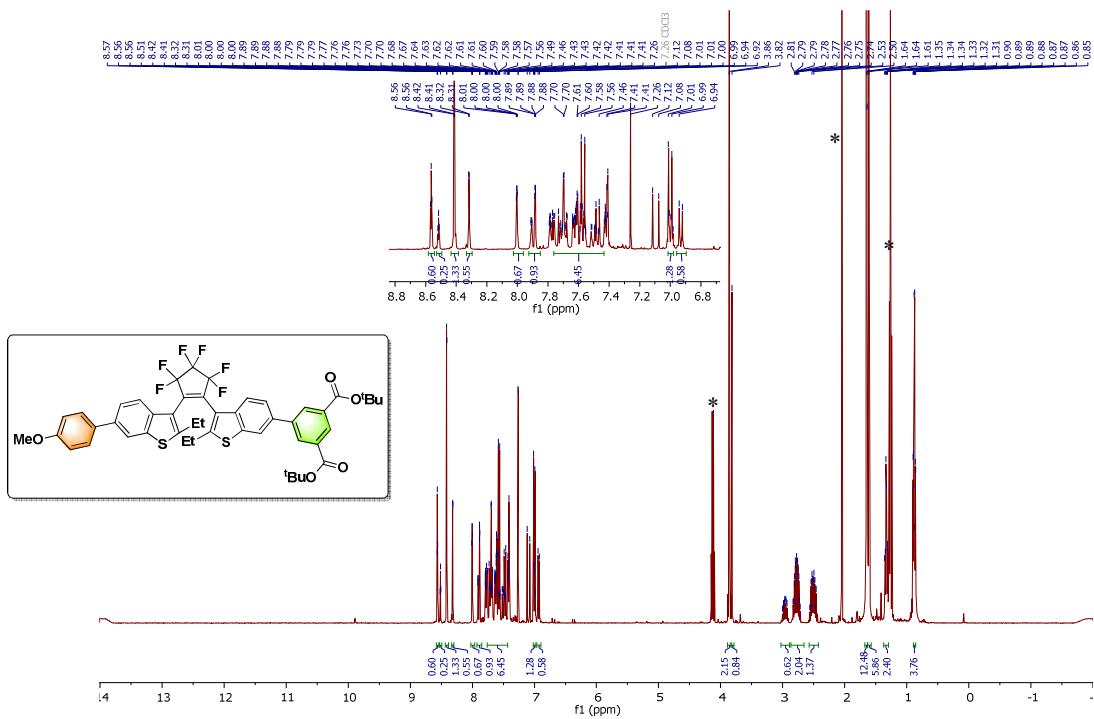

¹³C NMR spectrum in CDCl₃ (101 MHz)

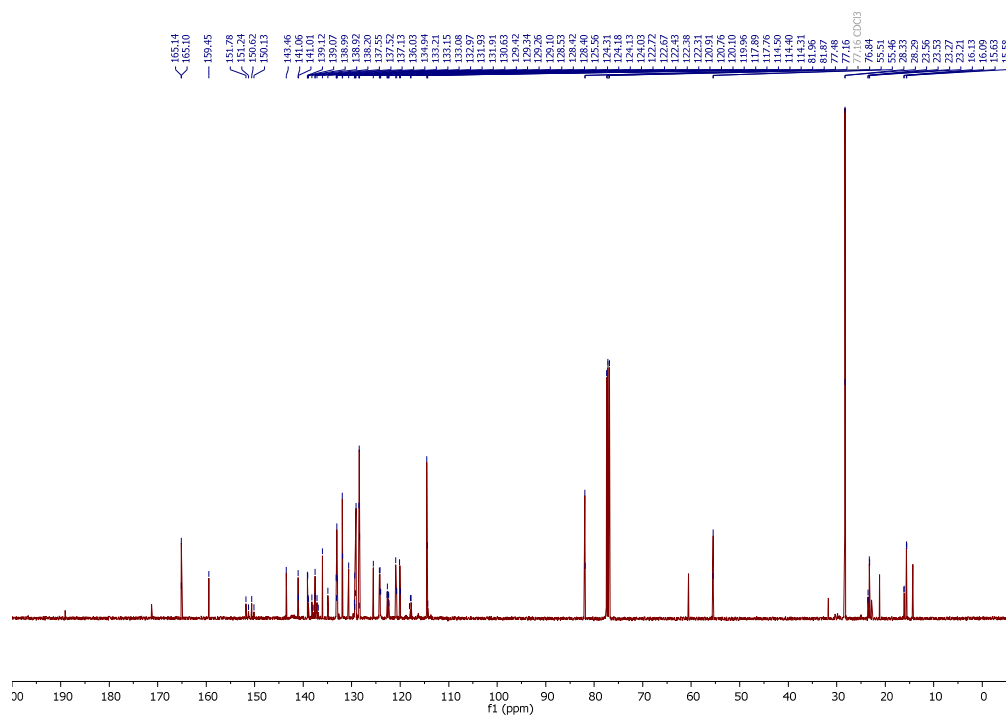

¹⁹F NMR spectrum in DMF-d₇ (376 MHz)

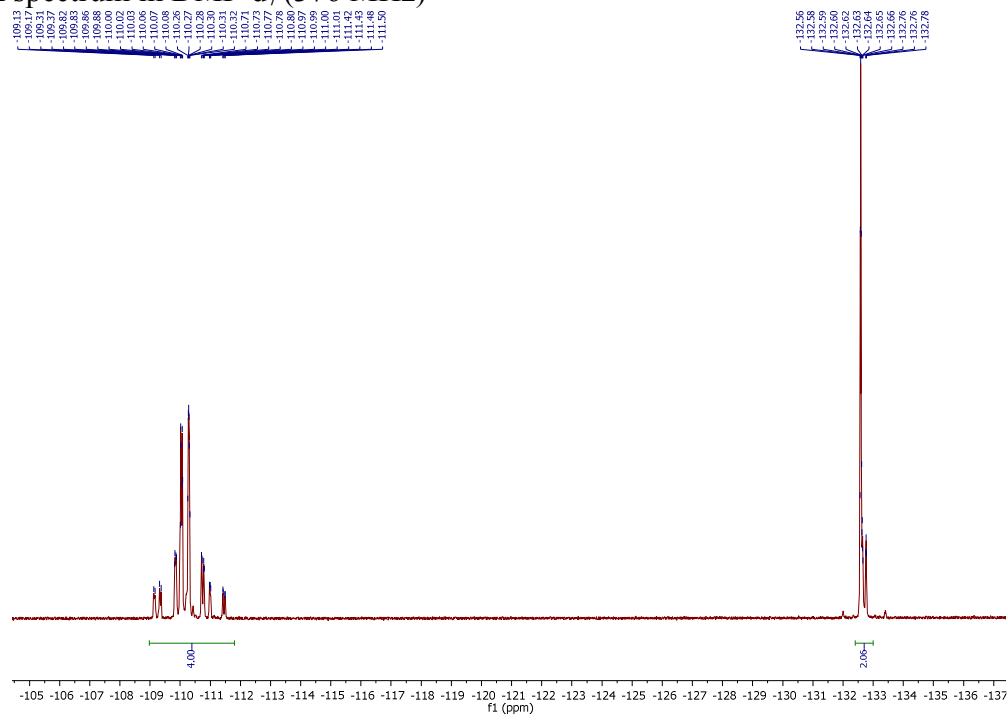

Compound S6a

¹H NMR spectrum in CDCl₃ (400 MHz)

* peaks assigned to residual EtOAc

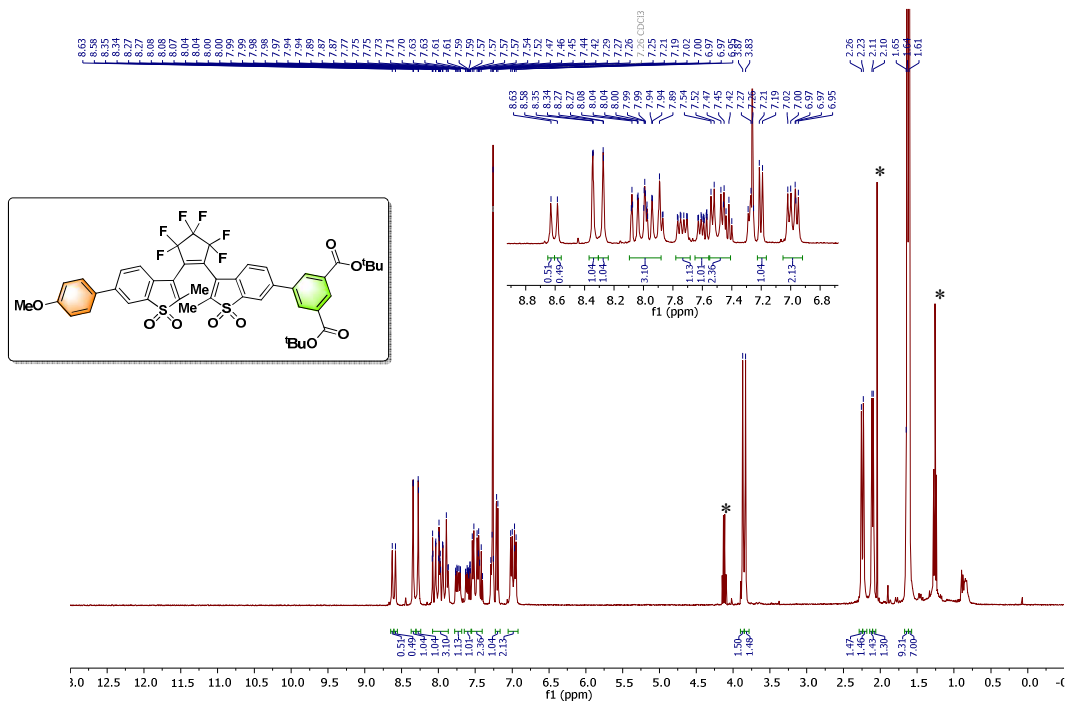

^{13}C NMR spectrum in CDCl_3 (101 MHz)

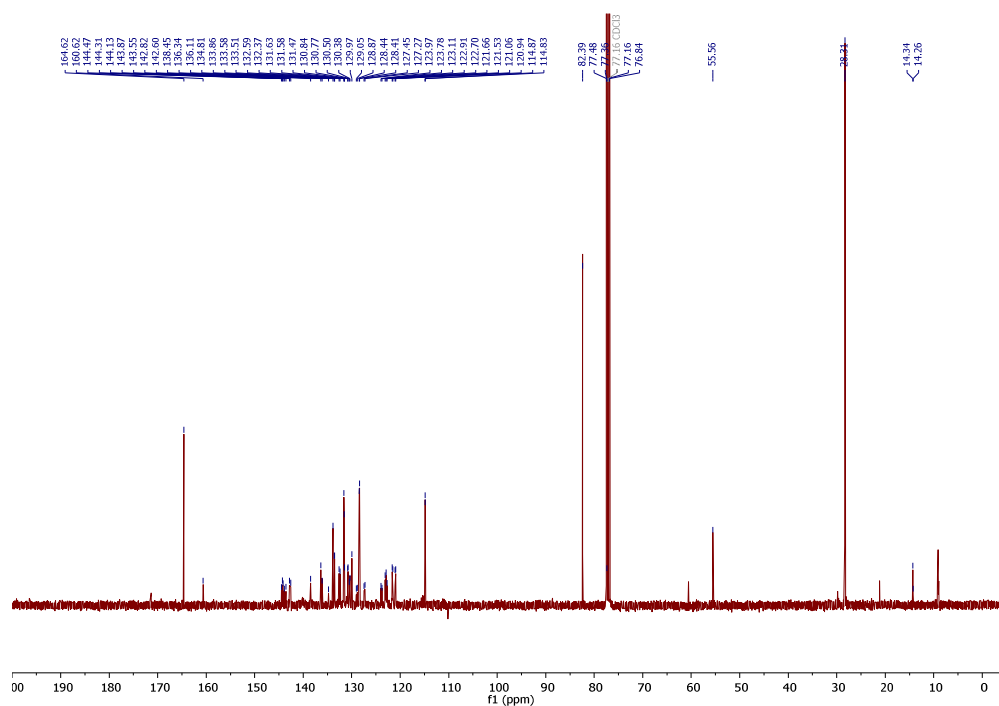

^{19}F NMR spectrum in CDCl_3 (376 MHz)

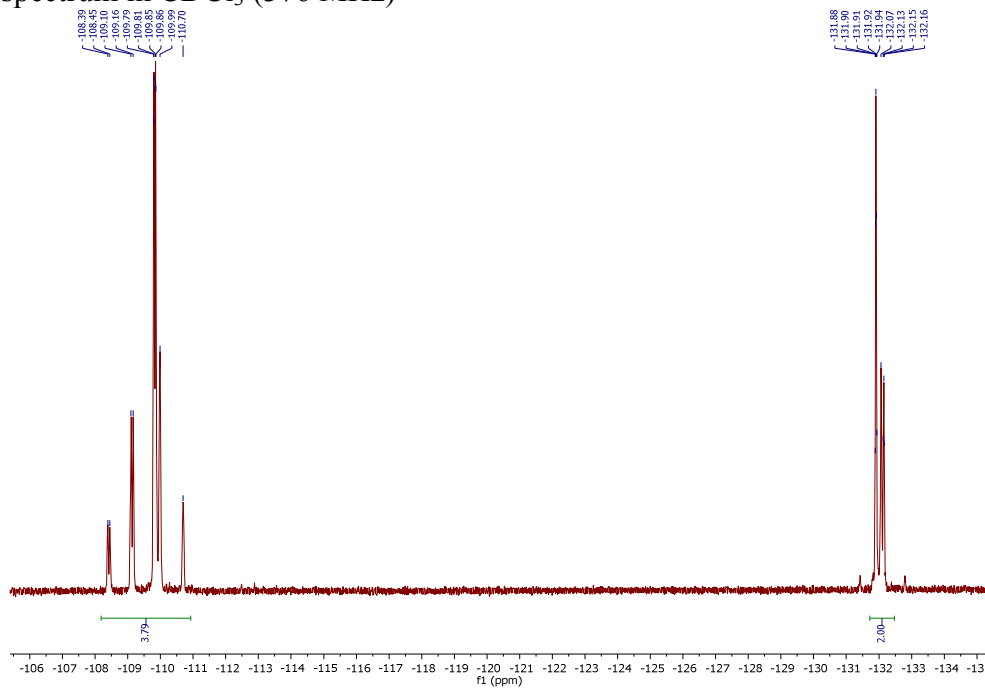

Compound S6b

¹H NMR spectrum in CDCl₃ (400 MHz)

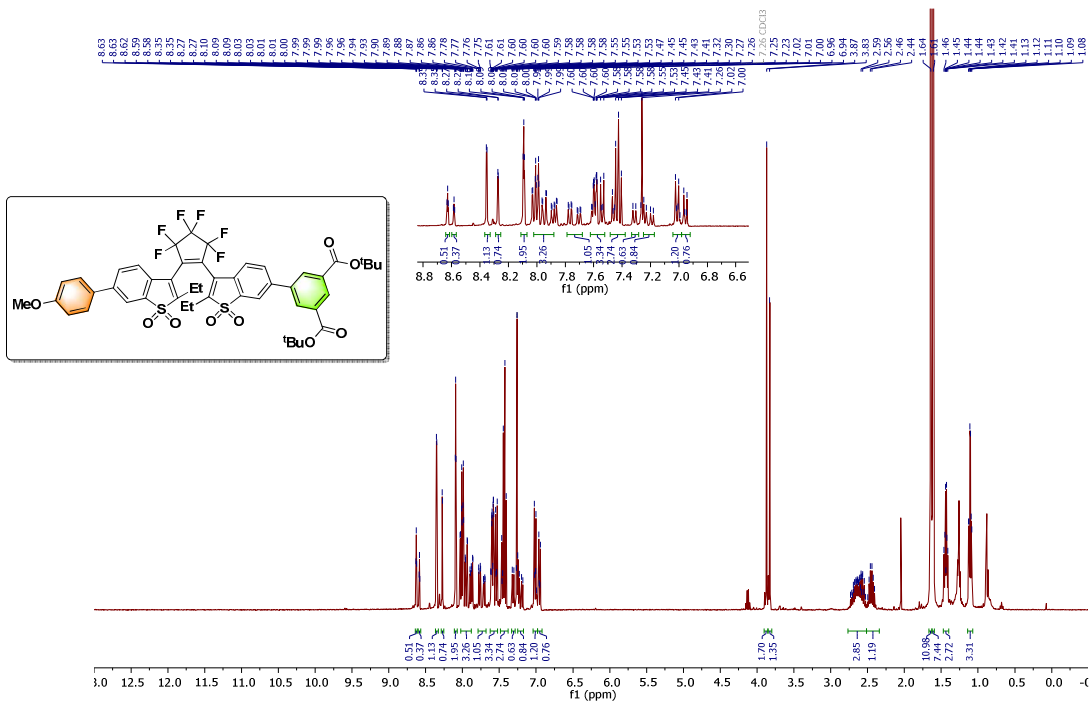

¹³C NMR spectrum in CDCl₃ (101 MHz)

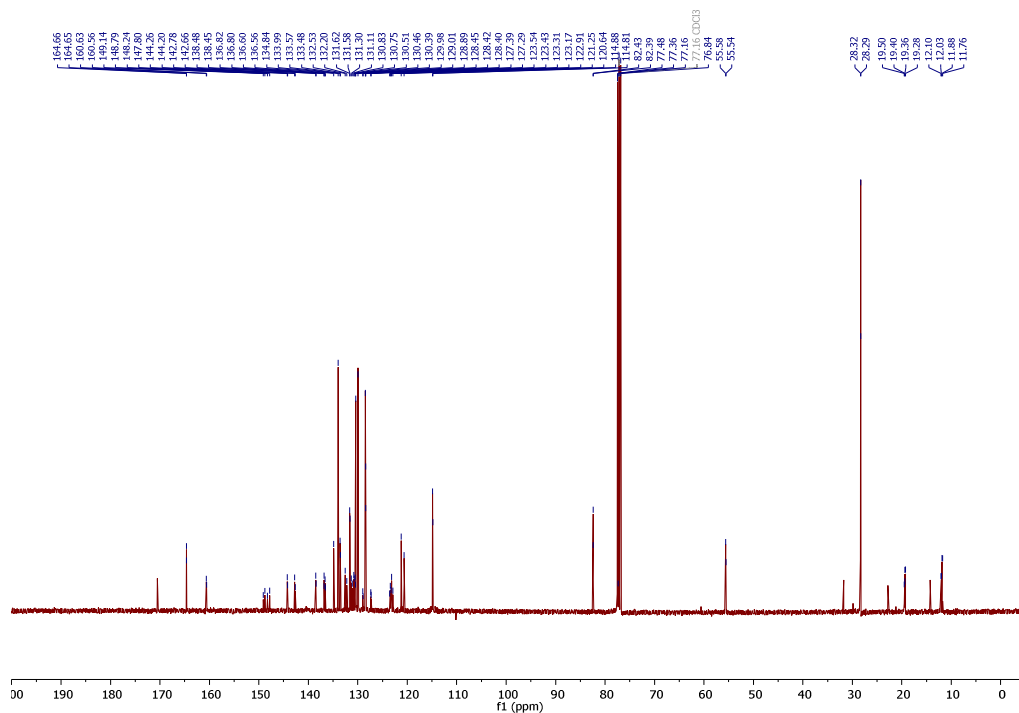

¹⁹F NMR spectrum in CDCl₃ (376 MHz)

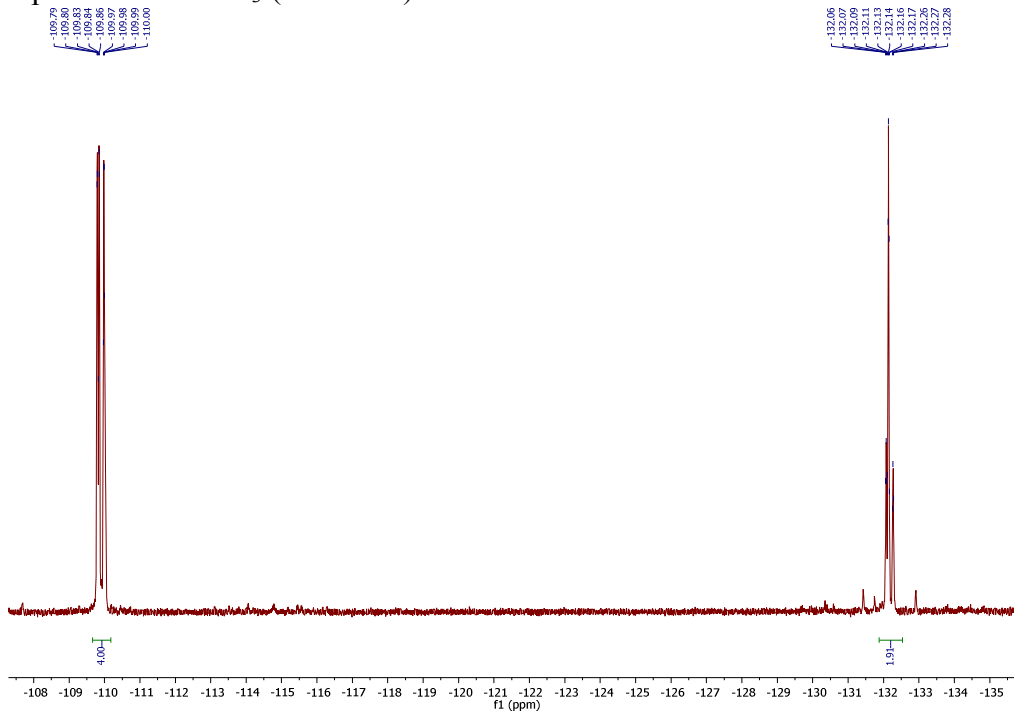

Compound 7-Me

¹H NMR spectrum in DMF-d₇ (400 MHz)

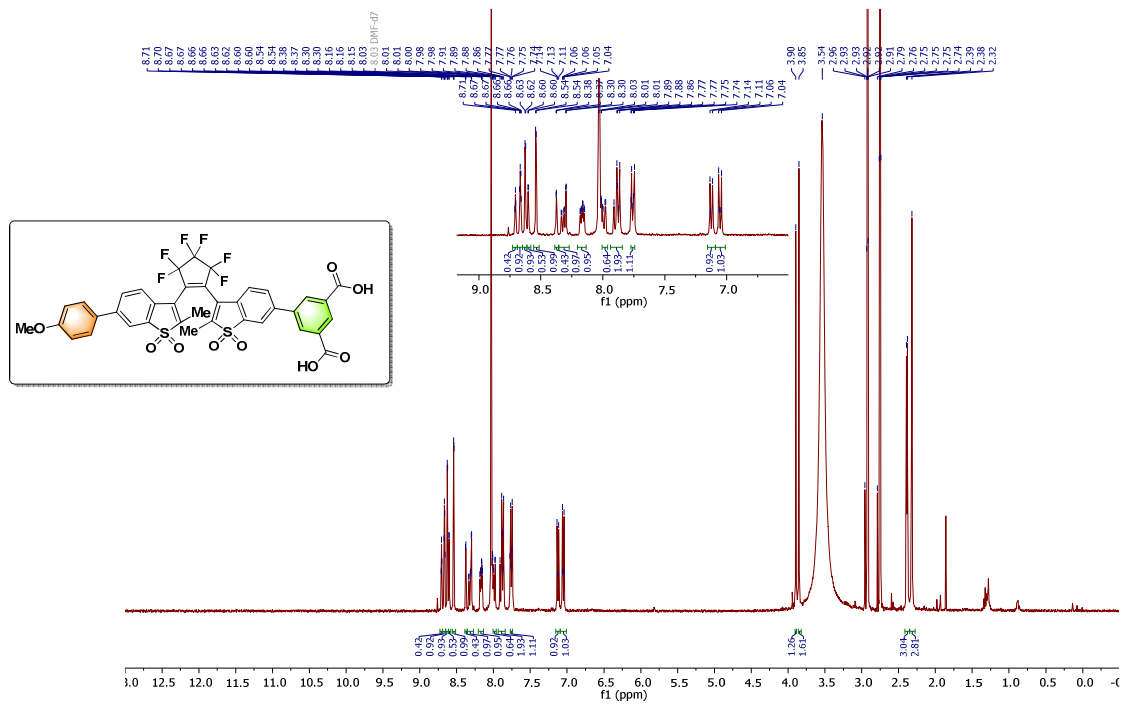

^{13}C NMR spectrum in DMF- d_7 (126 MHz)

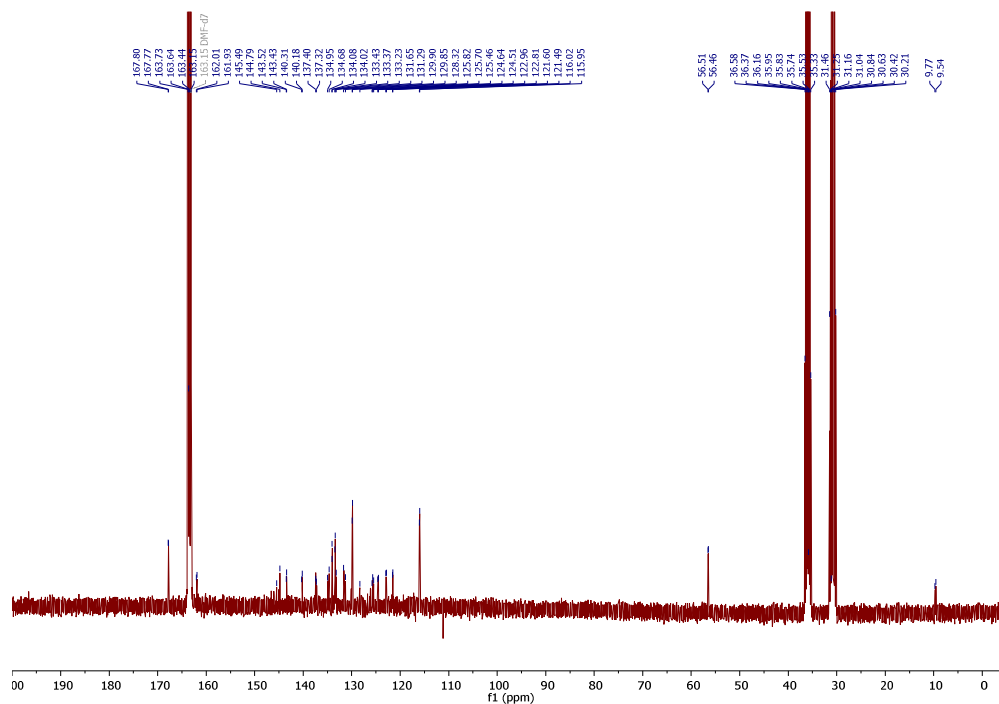

^{19}F NMR spectrum in DMF- d_7 (376 MHz)

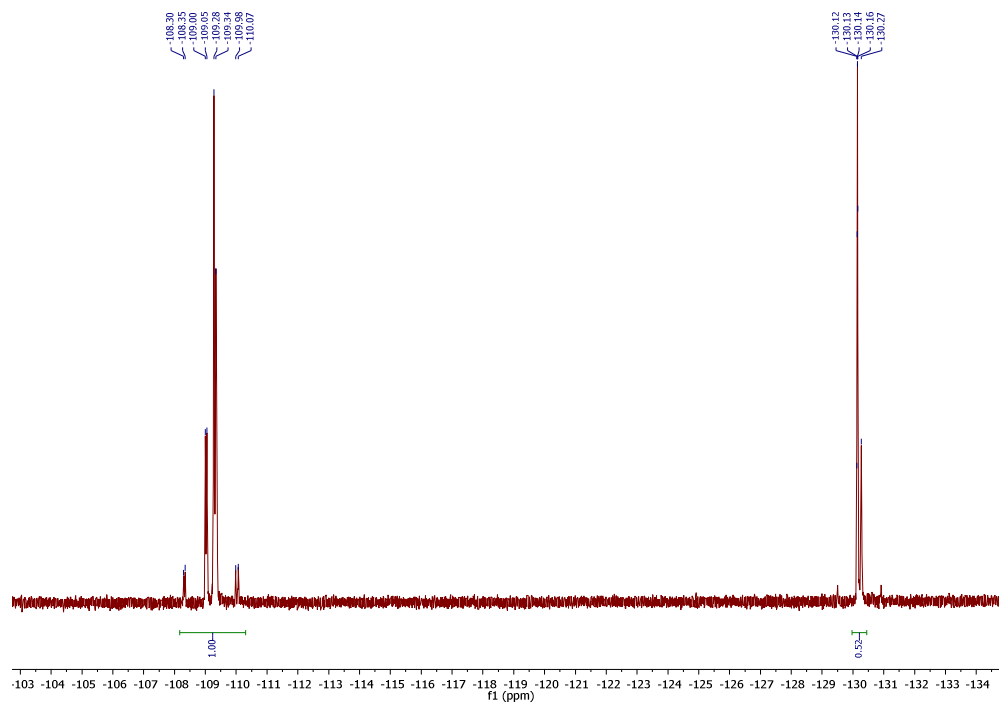

RP-HPLC elution profile (system C)

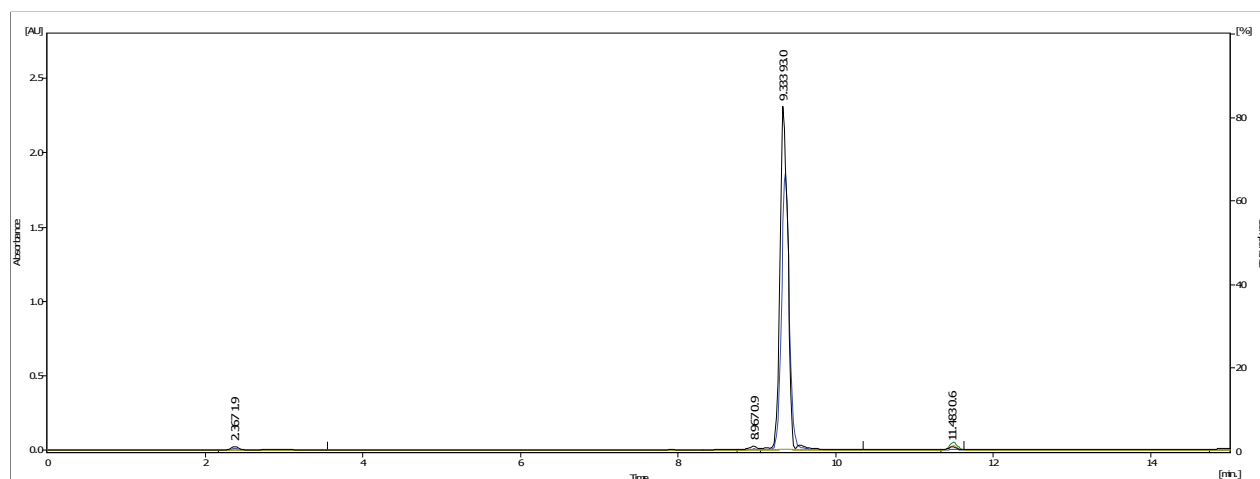

Compound 7-Et

¹H NMR spectrum in DMF-d₇ (500 MHz)

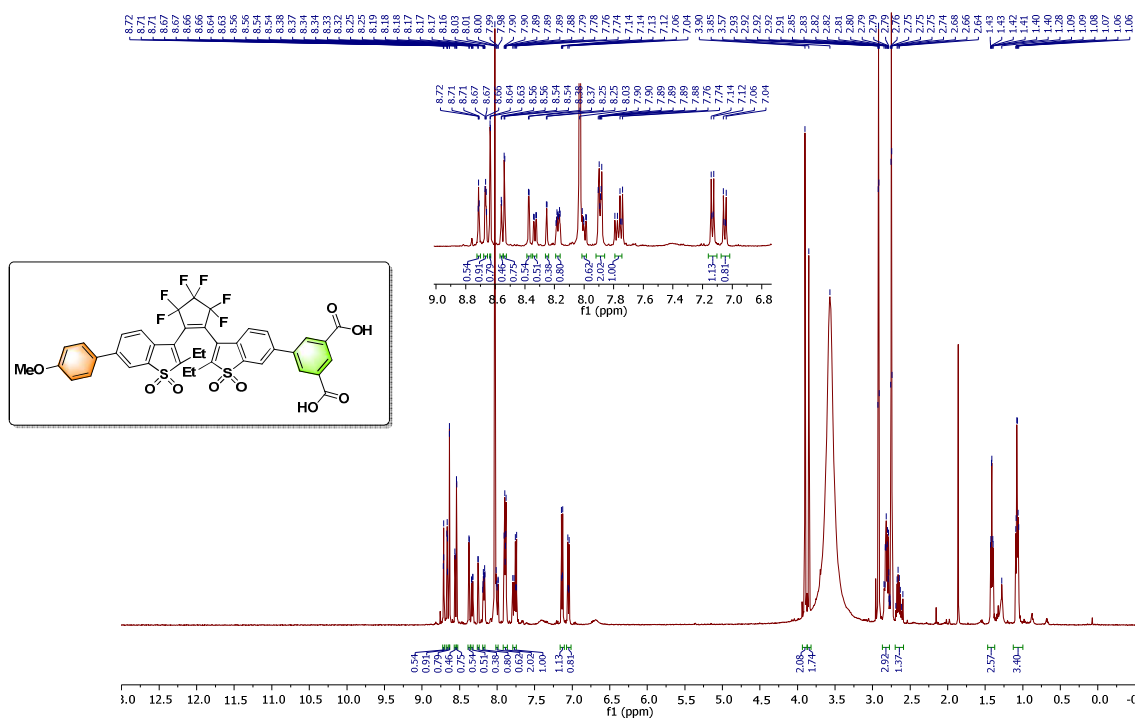

^{13}C NMR spectrum in DMF- d_7 (126 MHz)

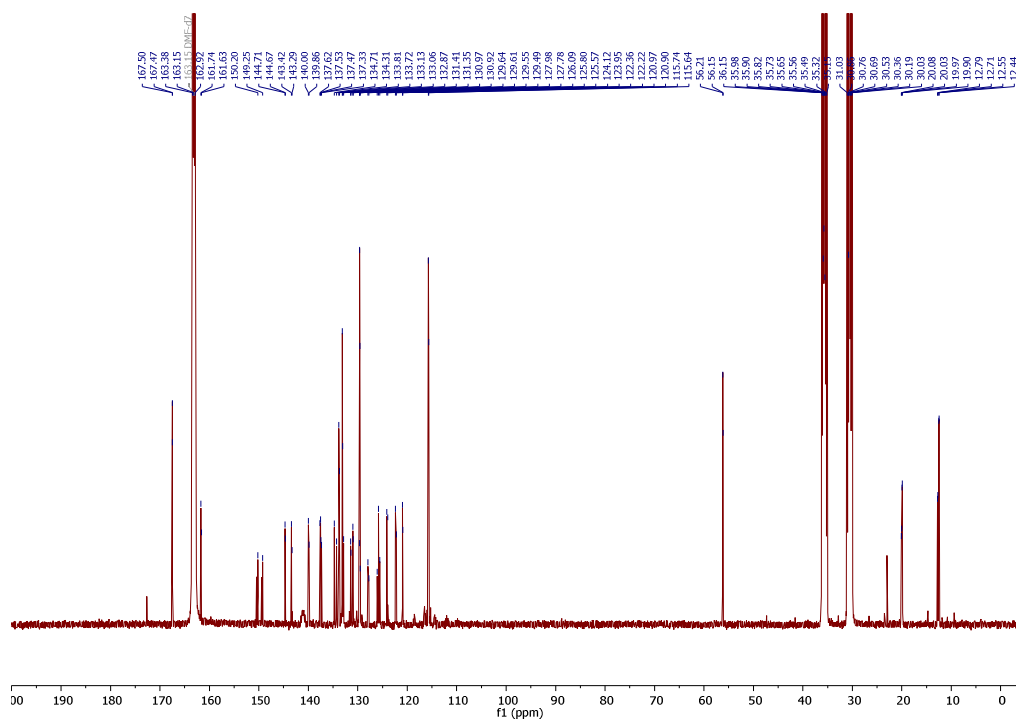

^{19}F NMR spectrum in DMF- d_7 (471 MHz)

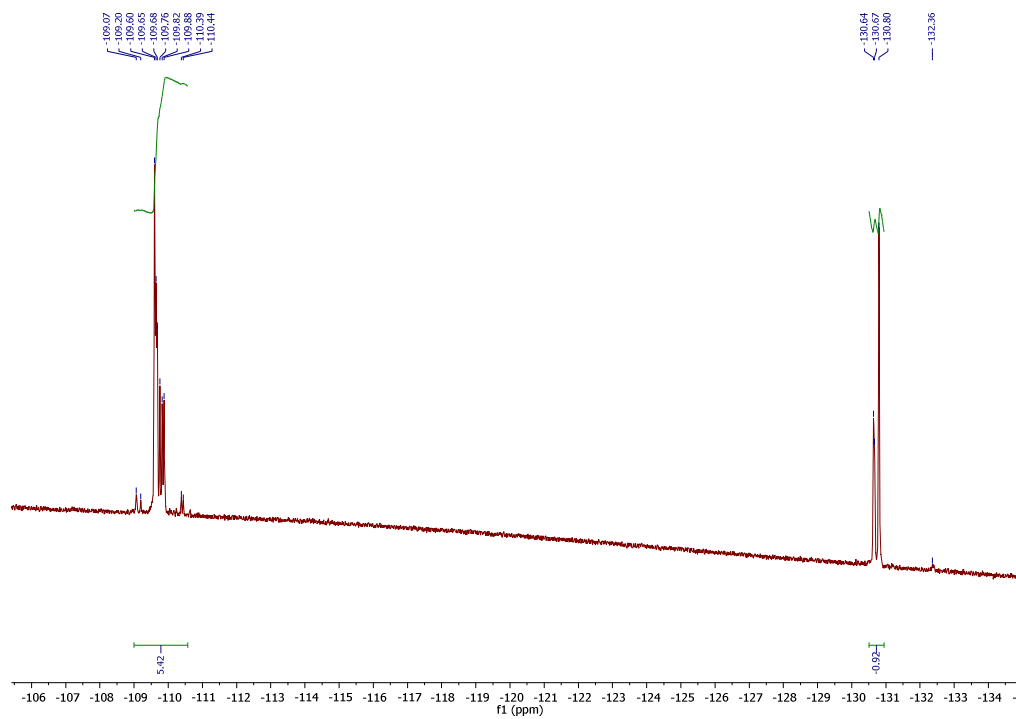

RP-HPLC elution profile (system C)

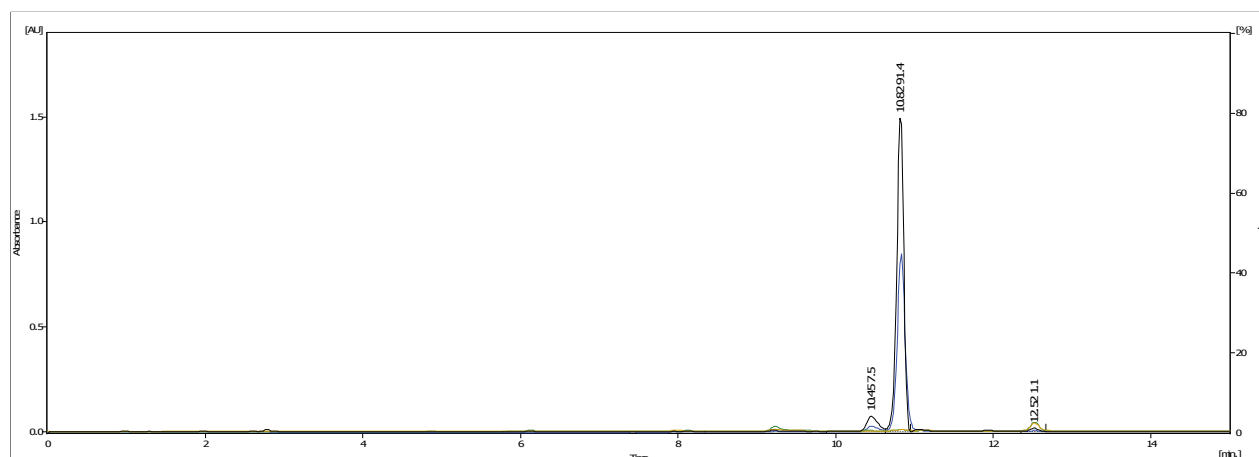

Compound S7

¹H NMR spectrum in CDCl₃ (400 MHz)

* peaks assigned to residual boronic ester

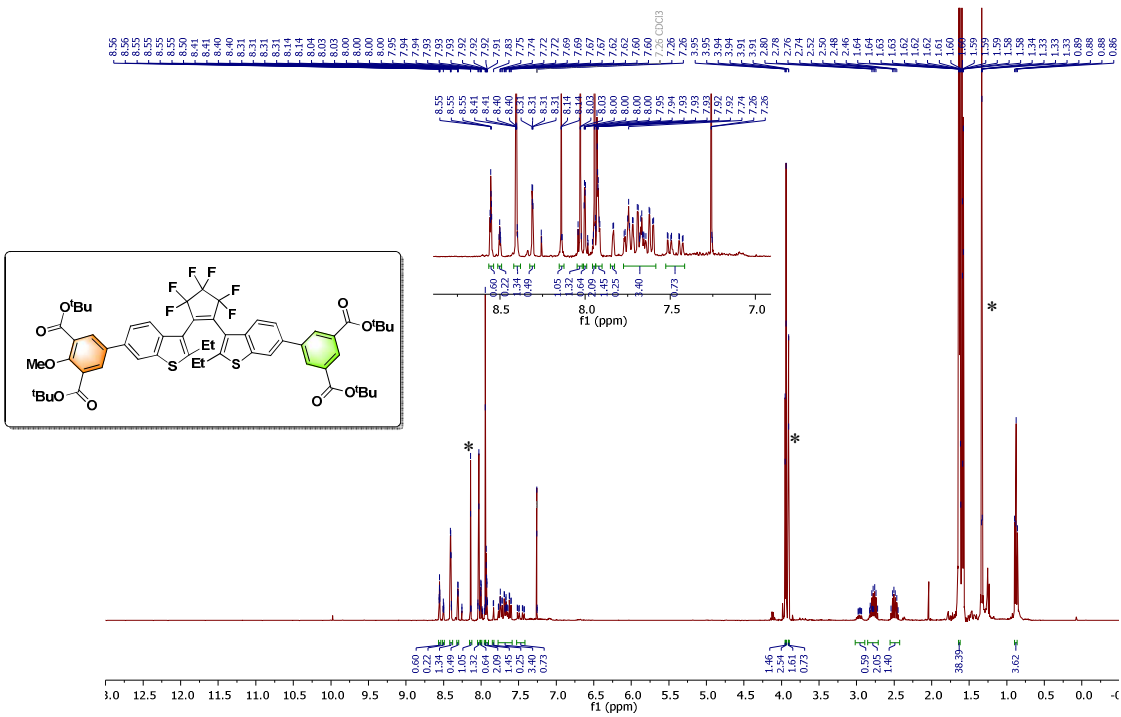

^{19}F NMR spectrum in CDCl_3 (376 MHz)

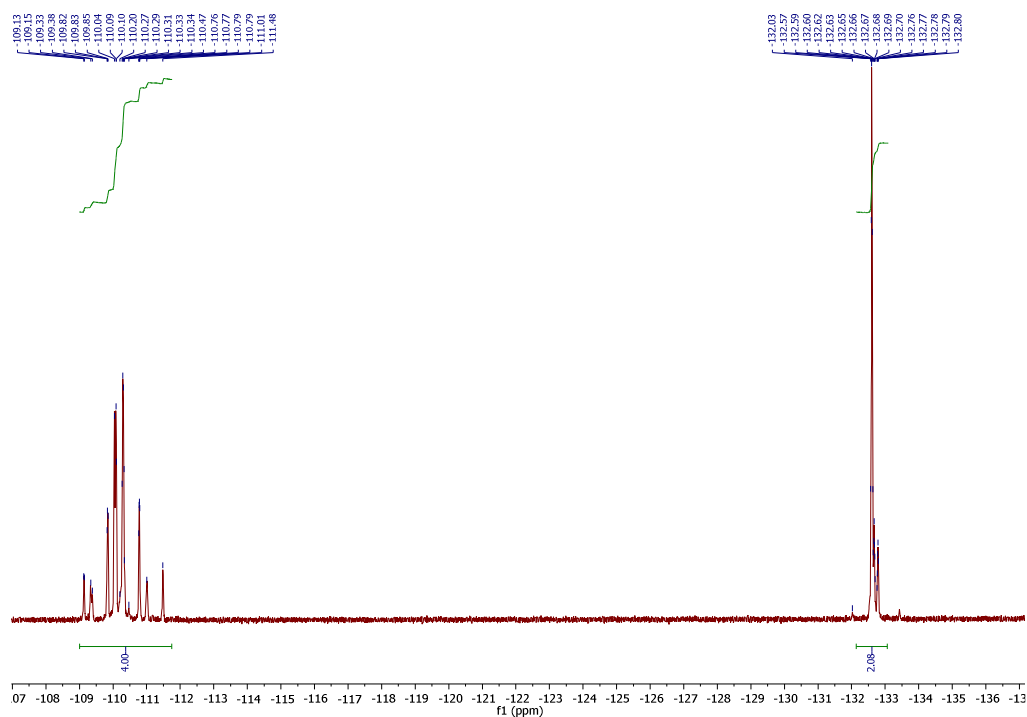

Compound S8

^1H NMR spectrum in CDCl_3 (400 MHz)

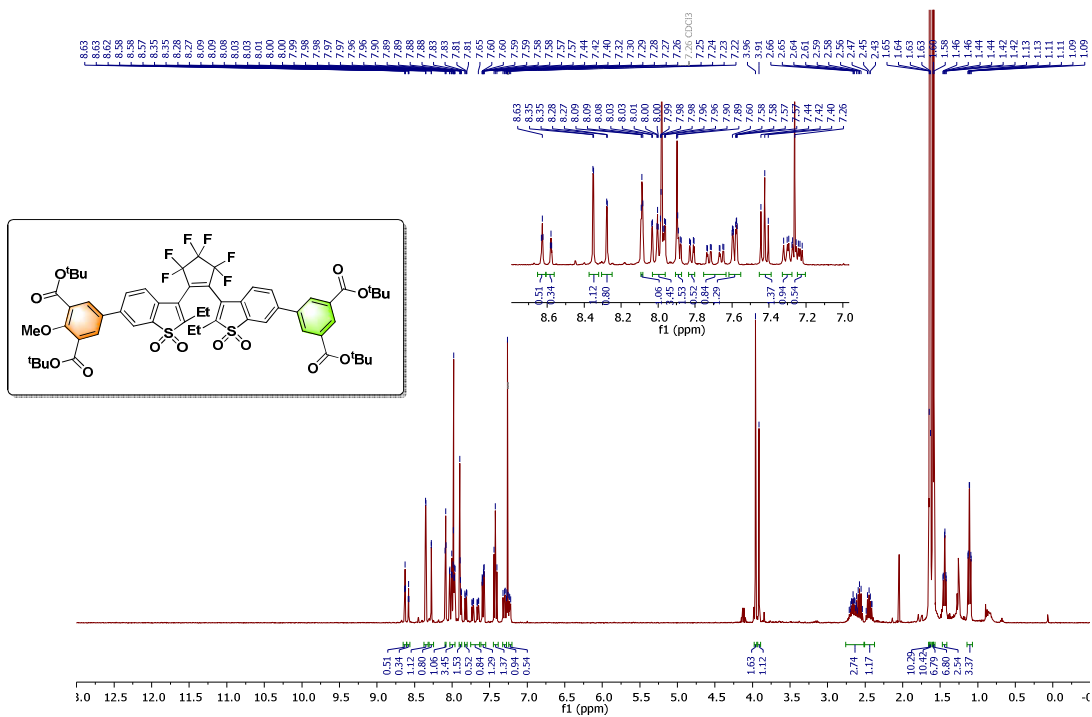

^{13}C NMR spectrum in CDCl_3 (101 MHz)

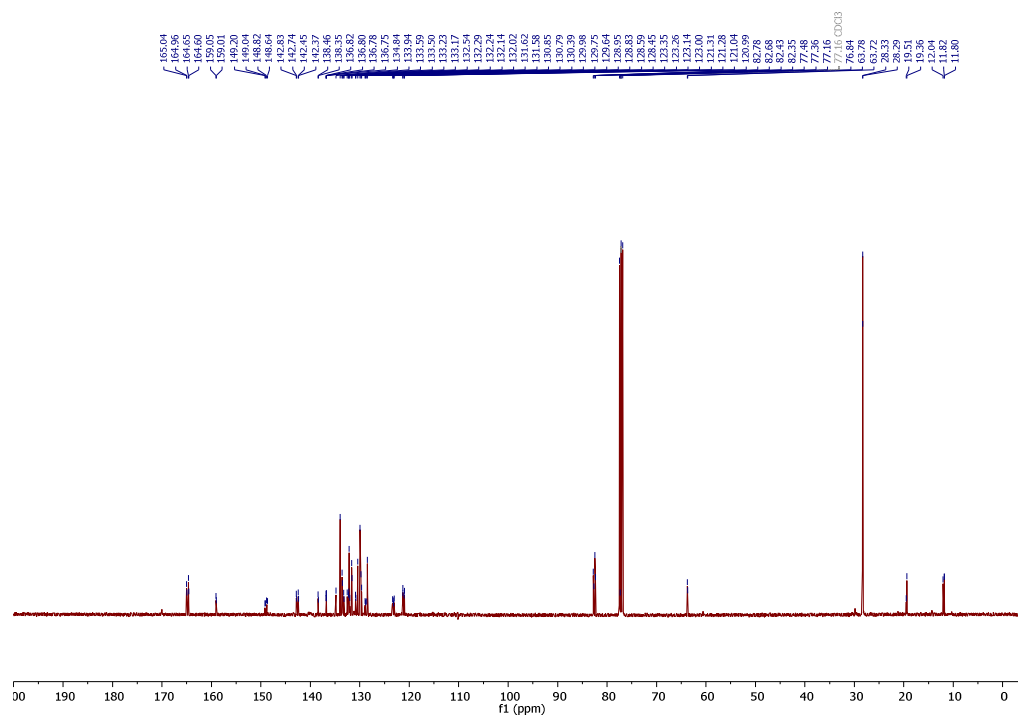

^{19}F NMR spectrum in CDCl_3 (376 MHz)

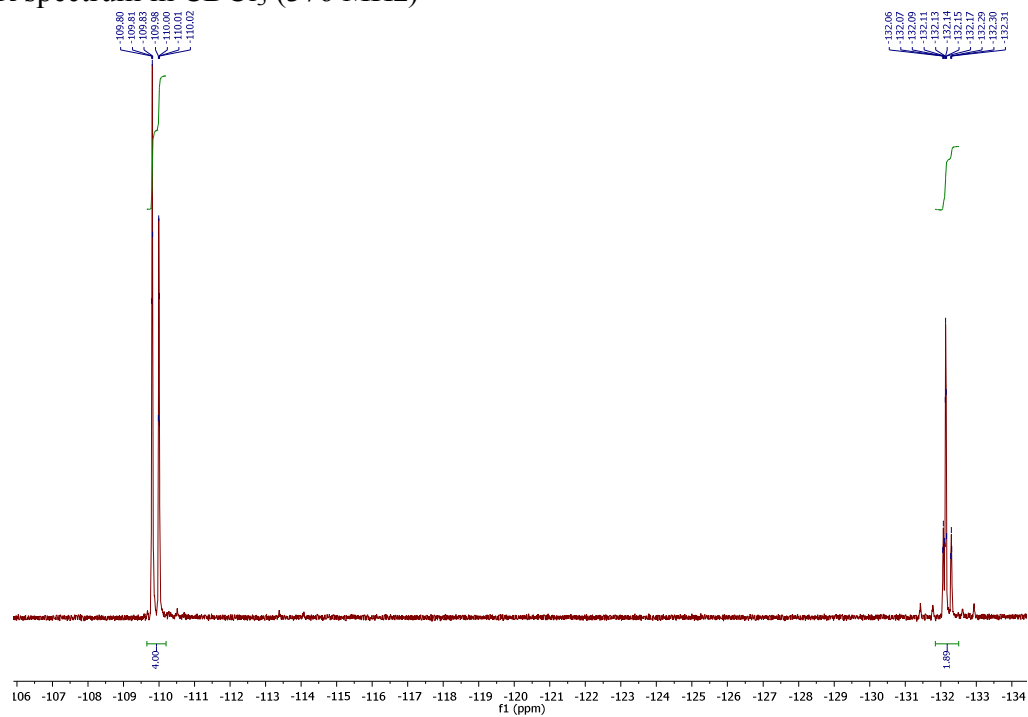

Compound 8

¹H NMR spectrum in DMF-d₇ (500 MHz)

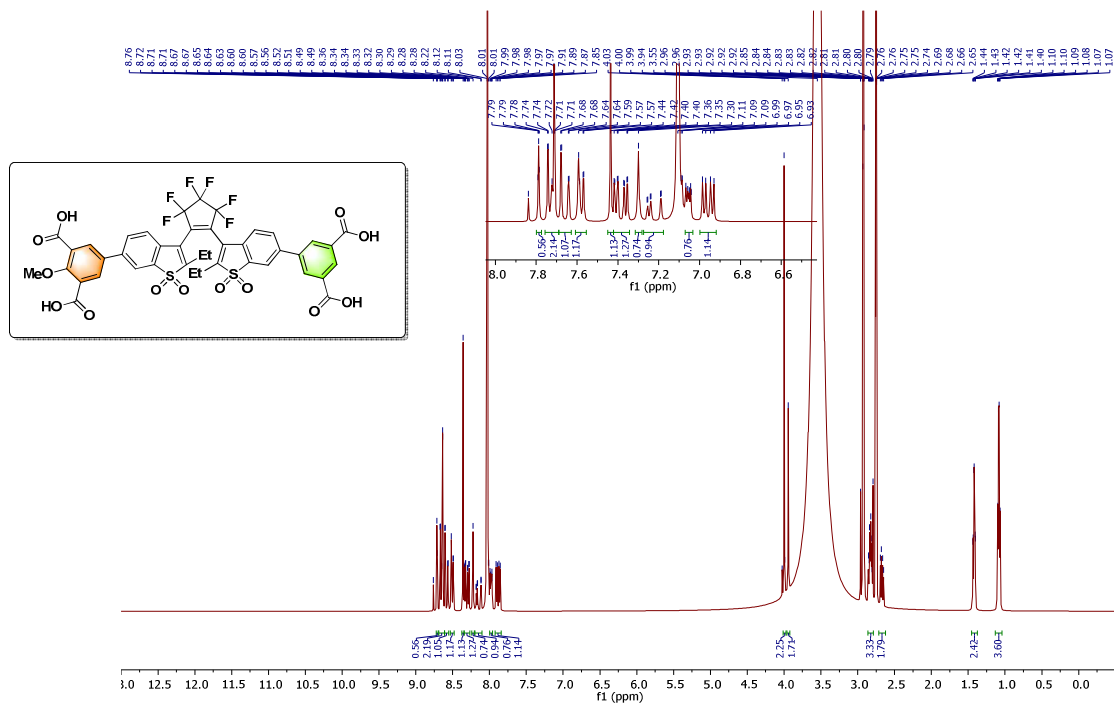

¹³C NMR spectrum in DMF-d₇ (126 MHz)

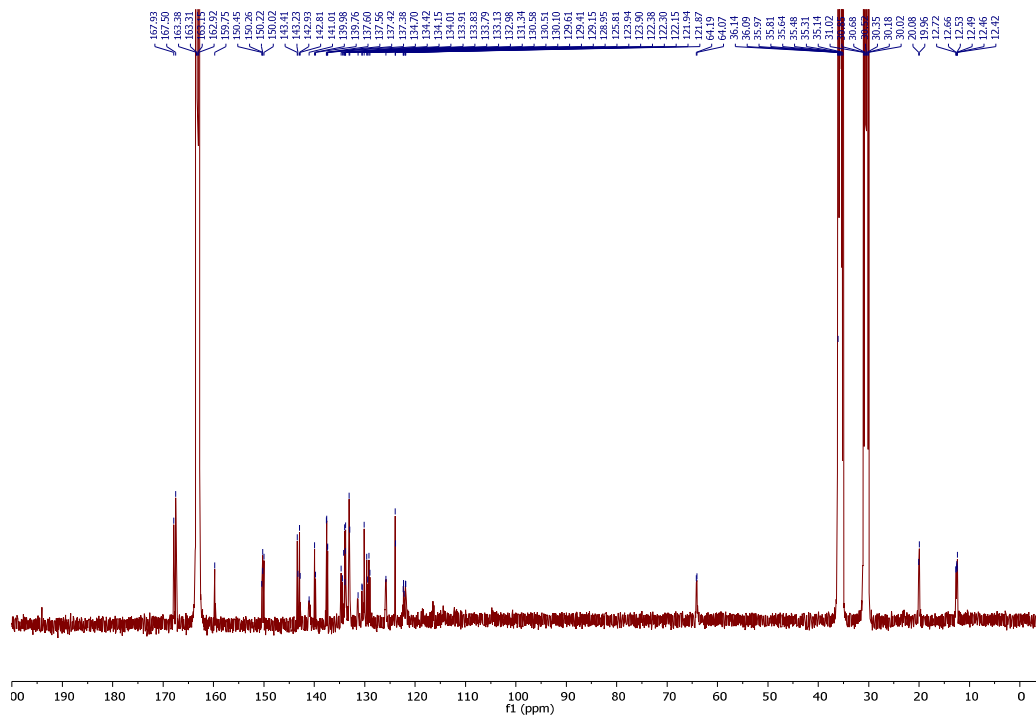

^{19}F NMR spectrum in DMF- d_7 (471 MHz)

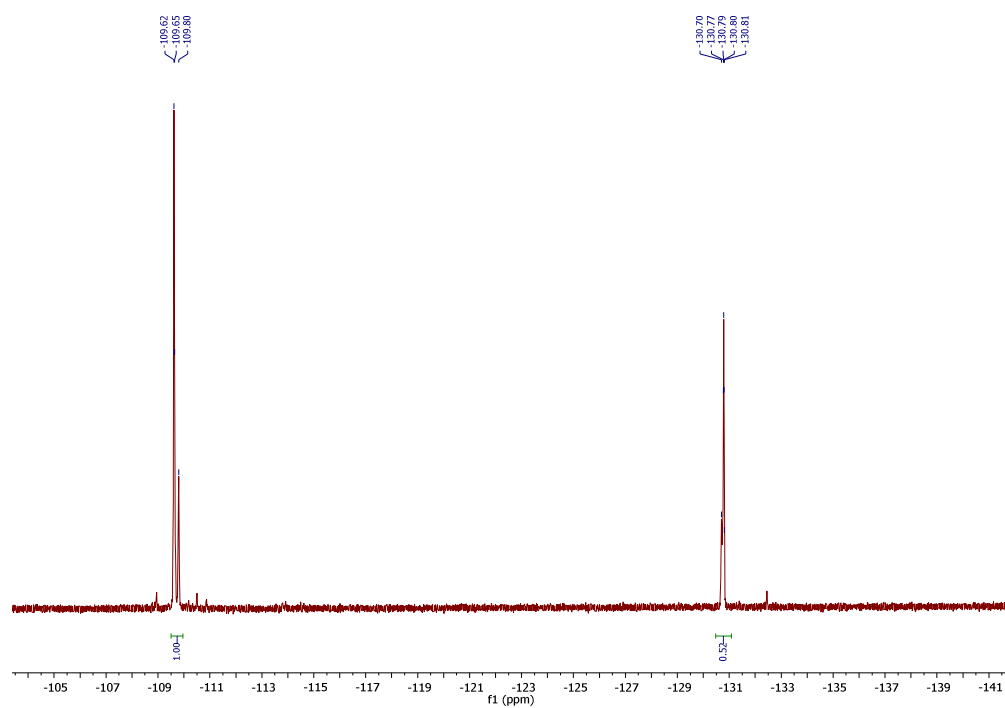

RP-HPLC elution profile (system A)

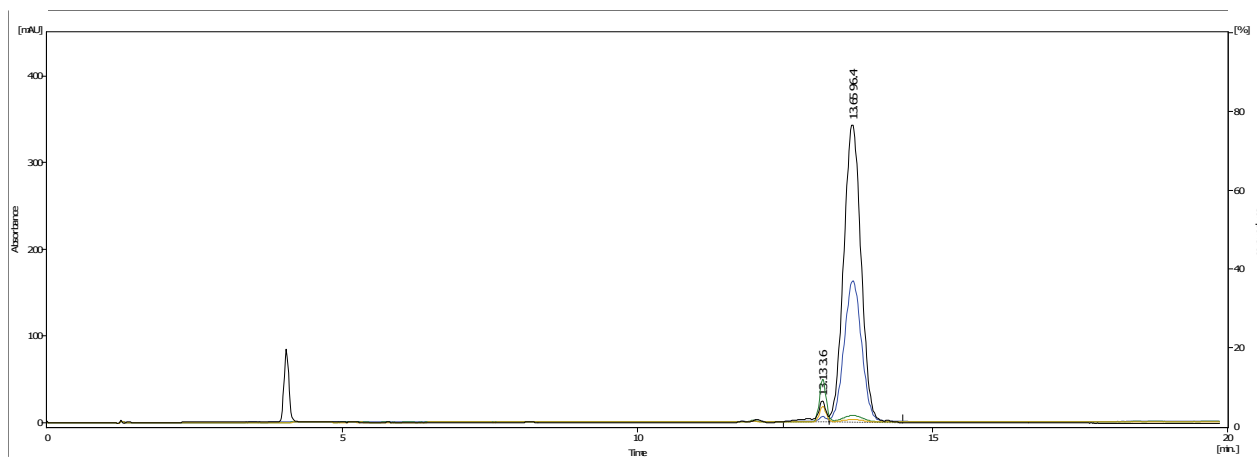

Compound S10

^1H NMR spectrum in CDCl_3 (400 MHz)

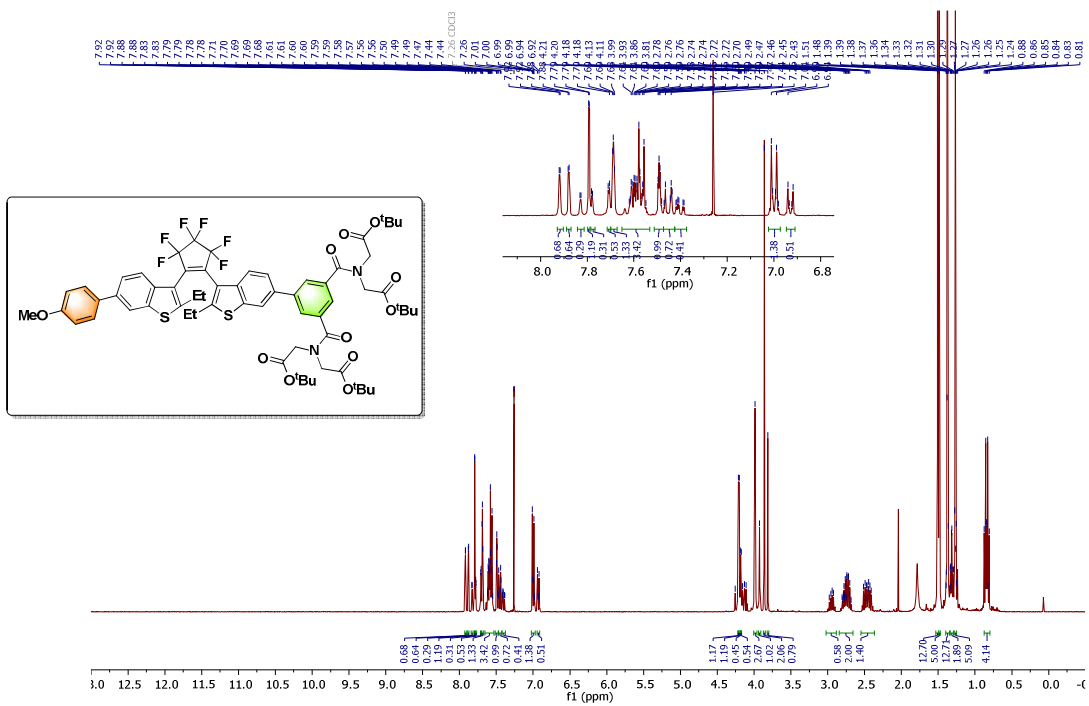

^{13}C NMR spectrum in CDCl_3 (101 MHz)

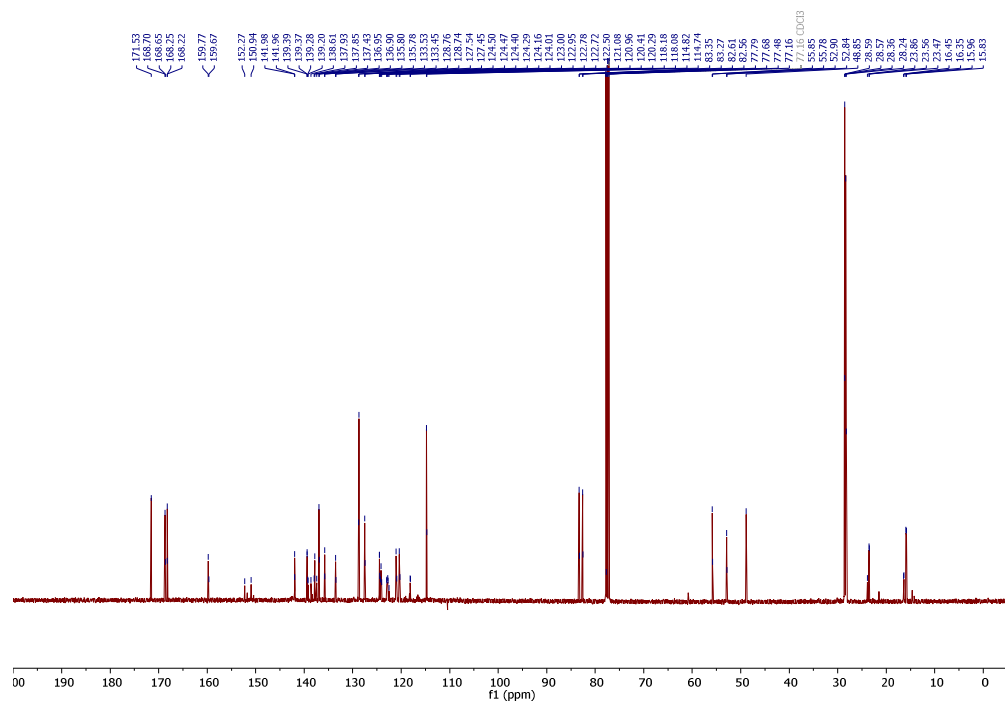

^{19}F NMR spectrum in CDCl_3 (376 MHz)

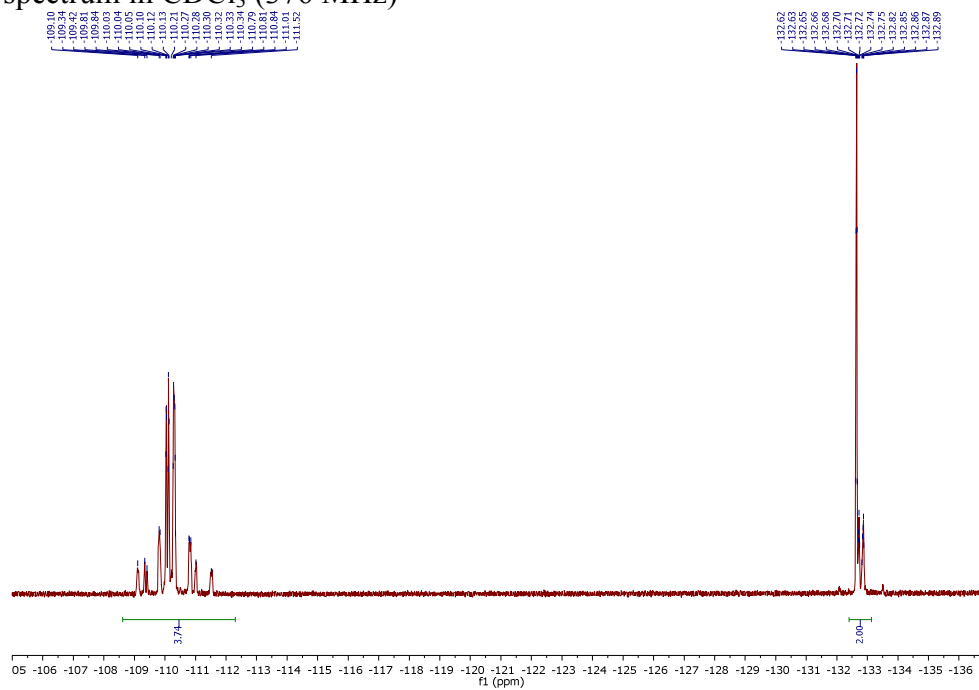

Compound S11

^1H NMR spectrum in CDCl_3 (400 MHz)

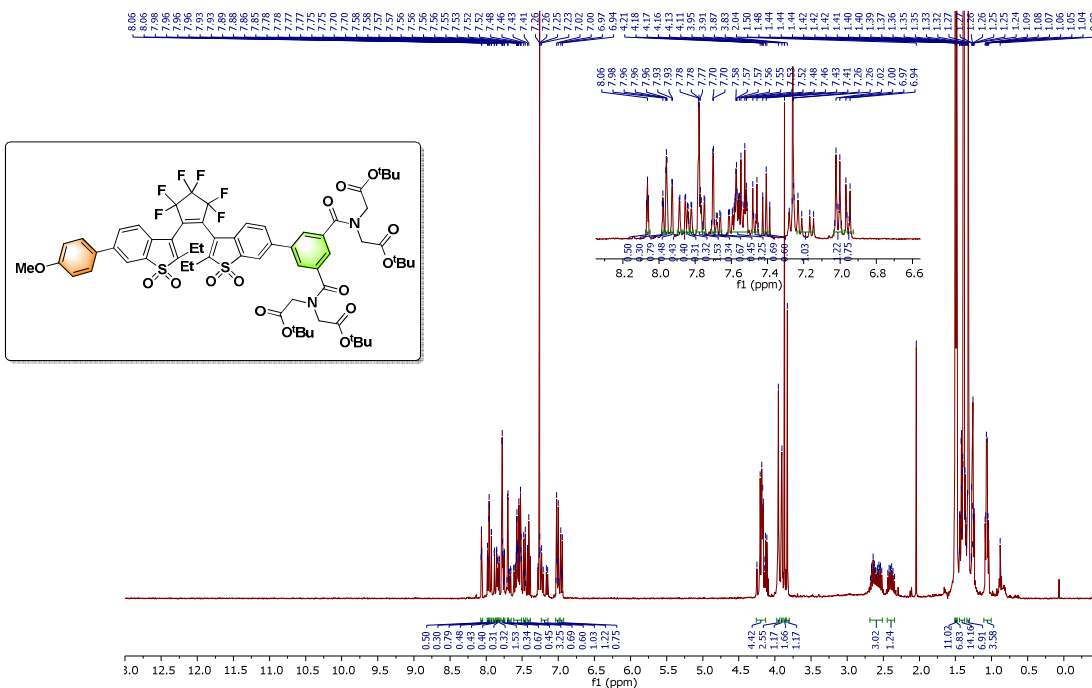

^{13}C NMR spectrum in CDCl_3 (101 MHz)

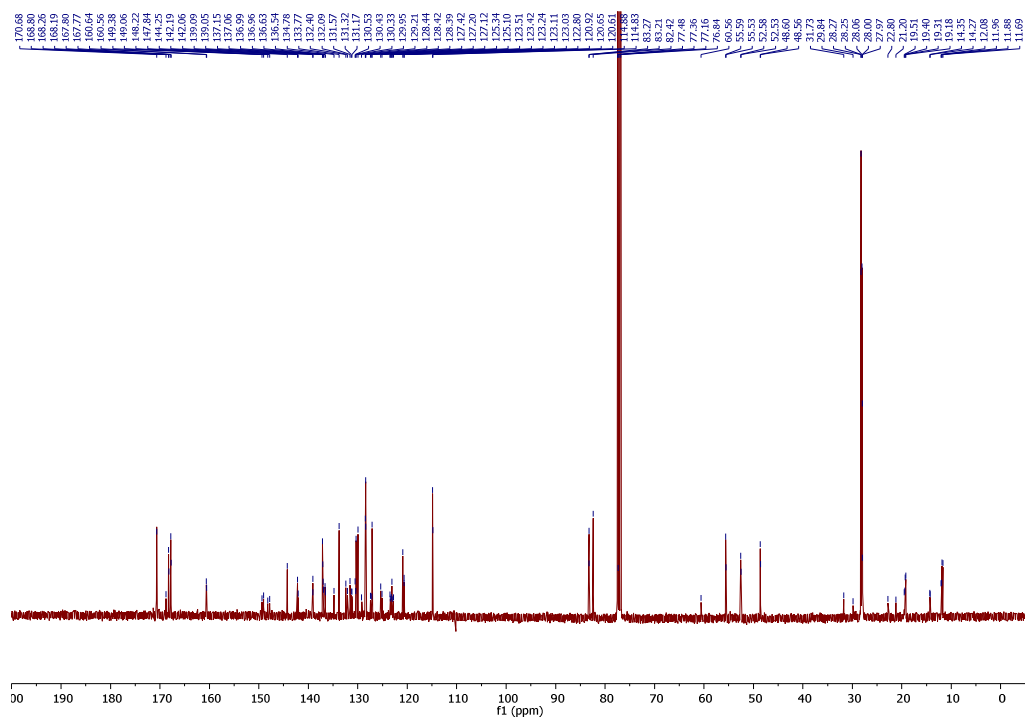

^{19}F NMR spectrum in CDCl_3 (376 MHz)

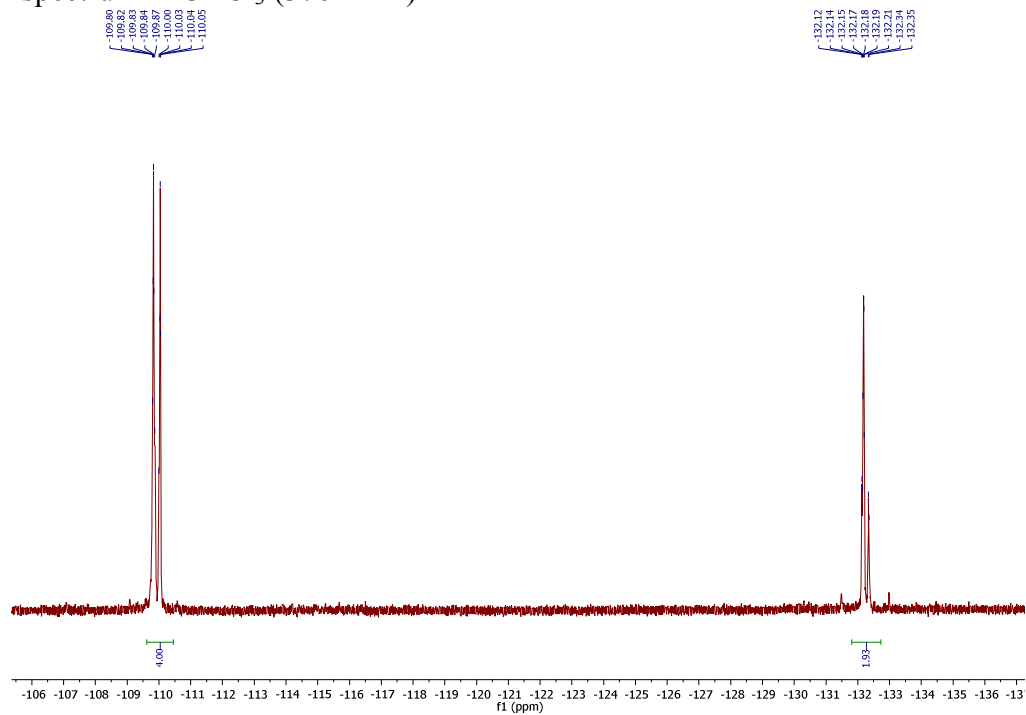

Compound 10

¹H NMR spectrum in DMF-d₇ (500 MHz)

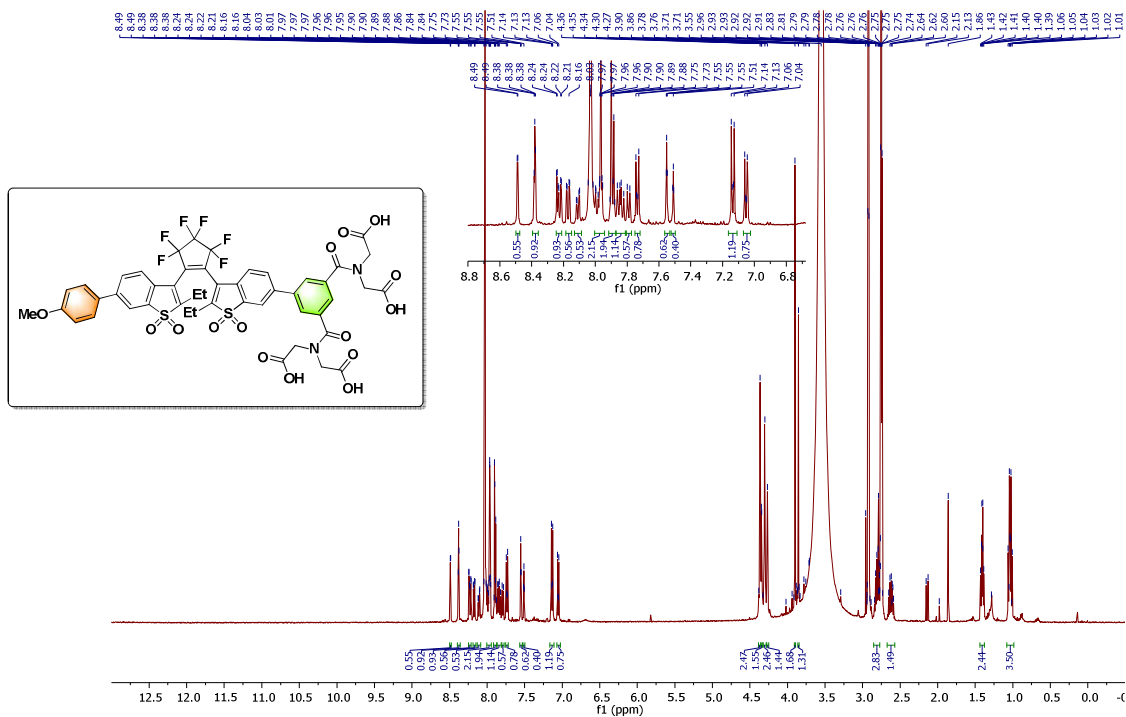

¹³C NMR spectrum in DMF-d₇ (126 MHz)

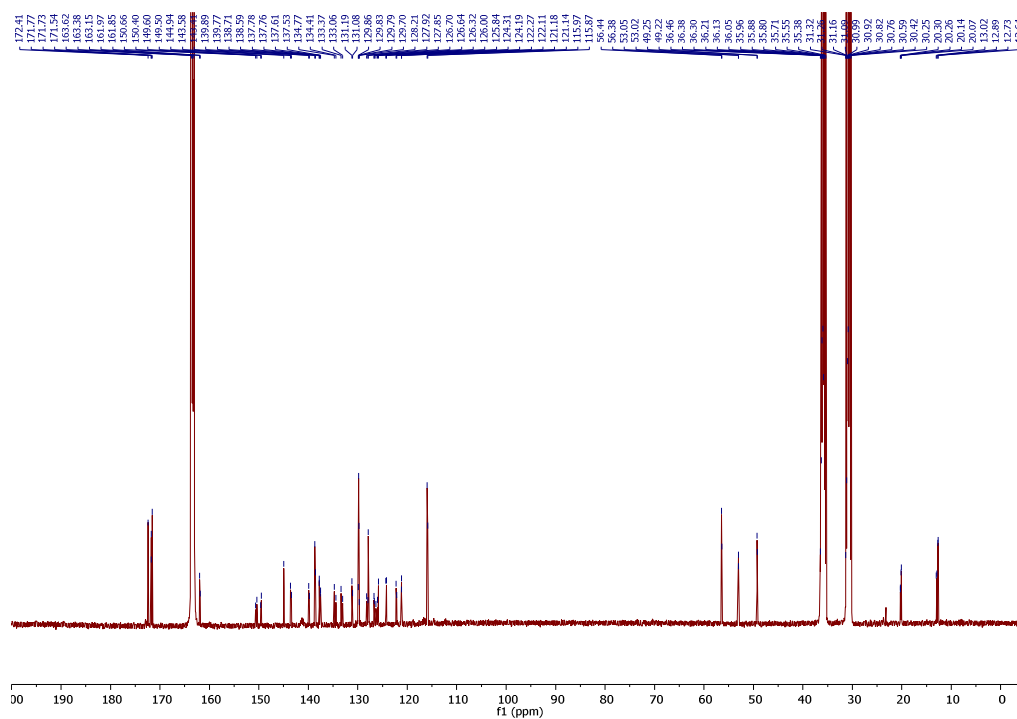

^{19}F NMR spectrum in DMF- d_7 (471 MHz)

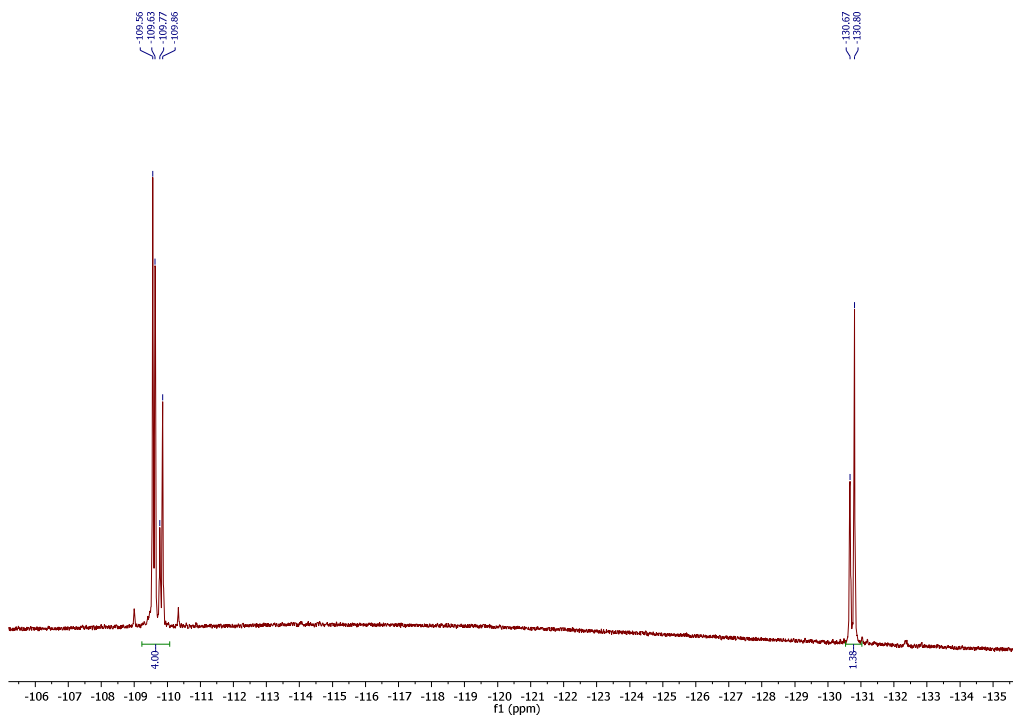

RP-HPLC elution profile (system A)

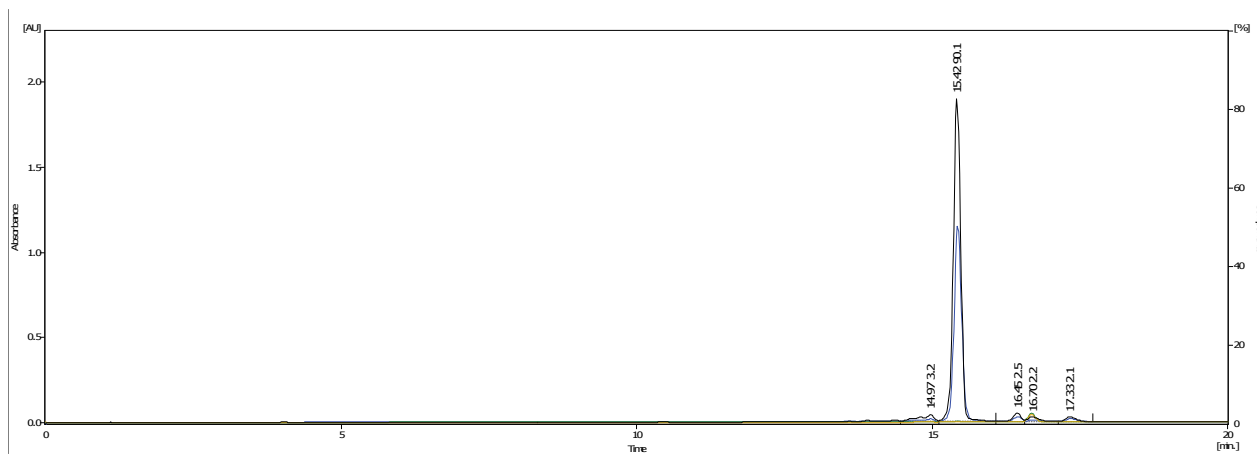

¹⁹F NMR spectrum in CDCl₃ (471 MHz)

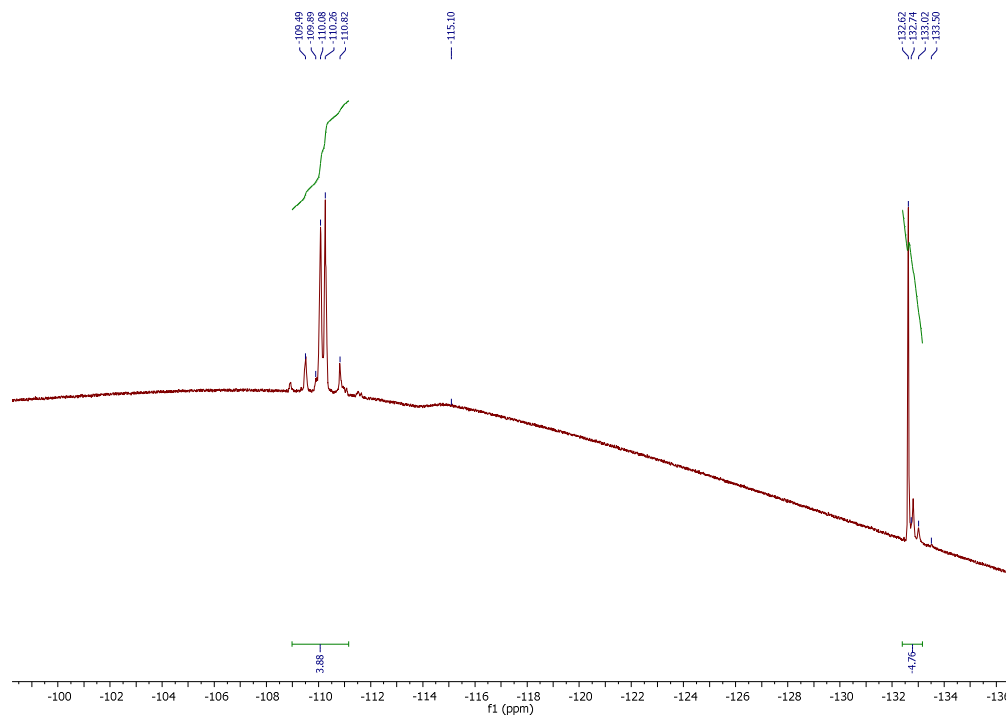

Compound S13

¹H NMR spectrum in CDCl₃ (400 MHz)

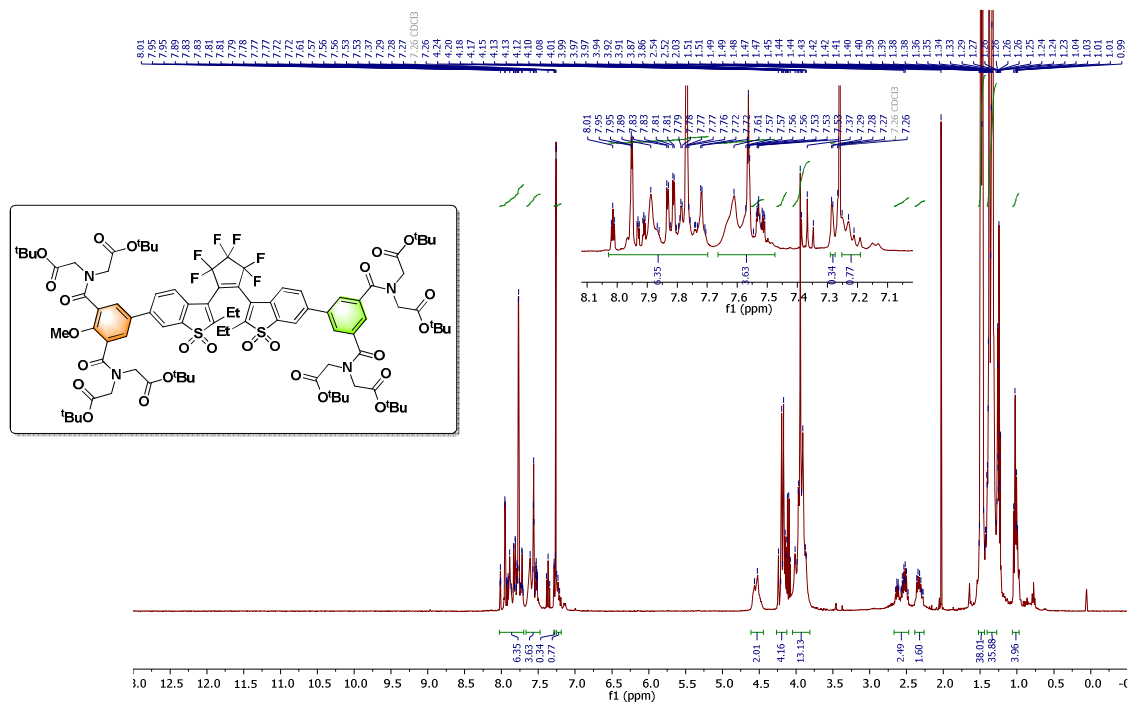

^{19}F NMR spectrum in CDCl_3 (376 MHz)

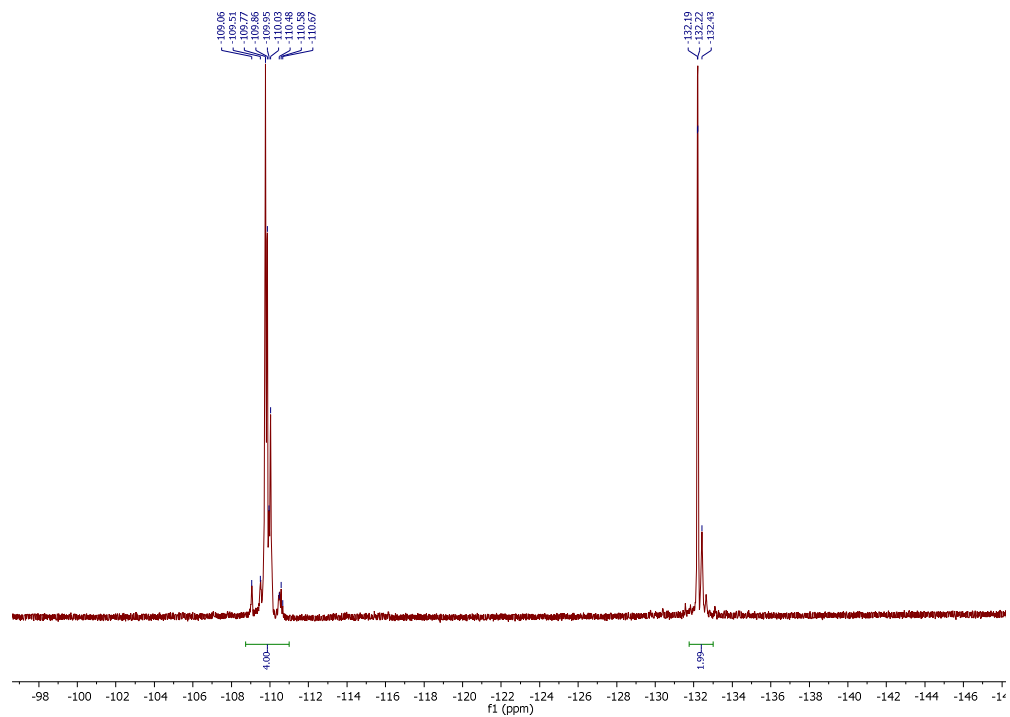

Compound 11

^1H NMR spectrum in DMF- d_7 (500 MHz)

*,** peaks assigned to residual solvent (DCM, CH_3CN)

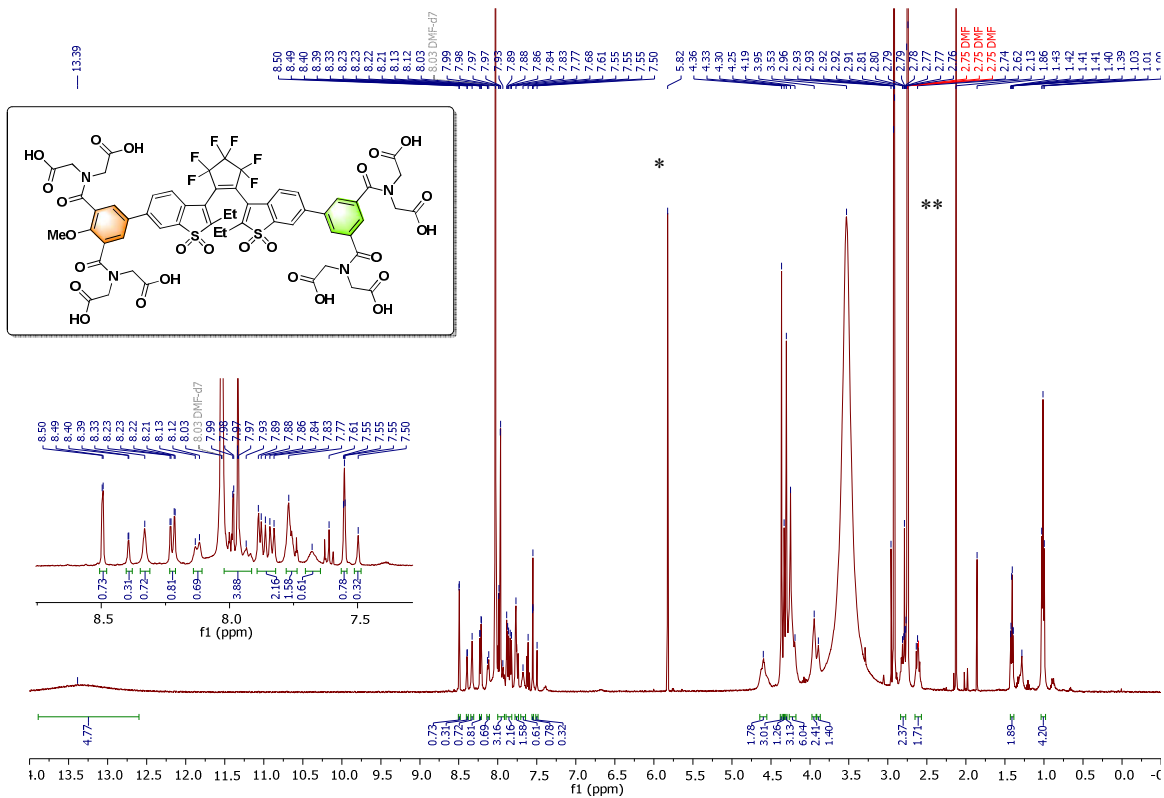

^{19}F NMR spectrum in DMF- d_7 (471 MHz)

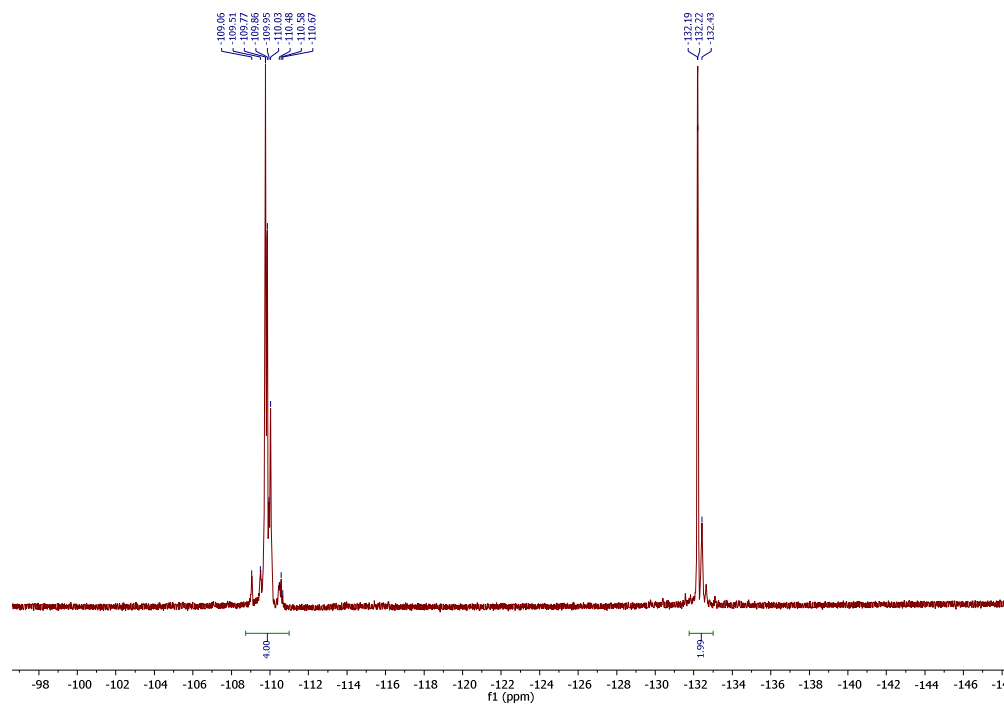

^{13}C NMR spectrum in DMF- d_7 (126 MHz)

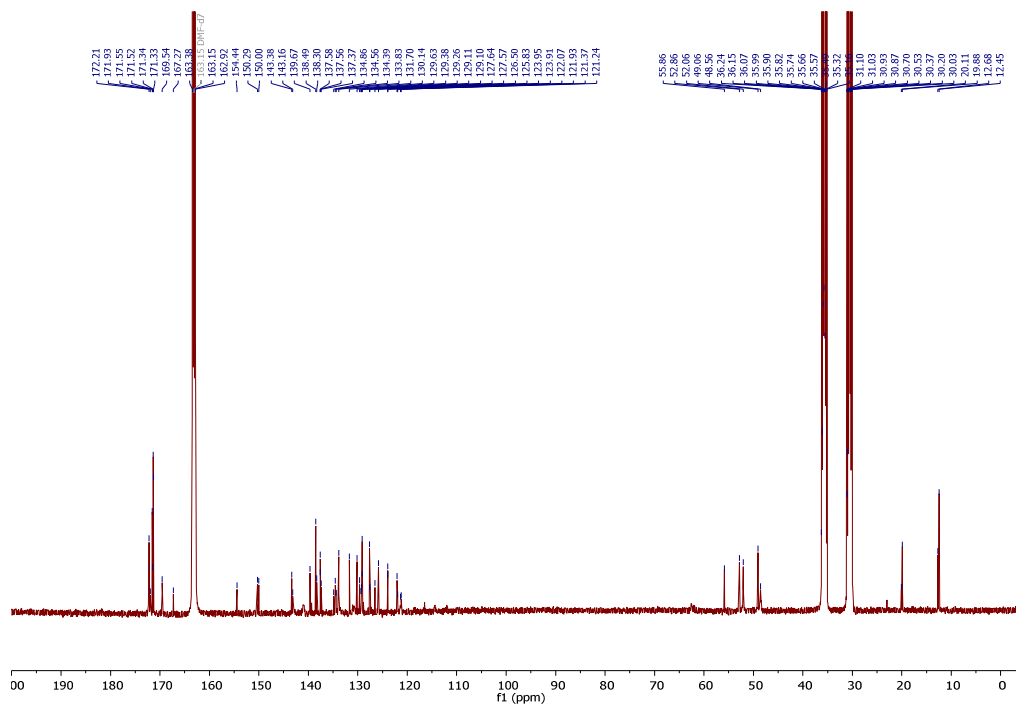

^{19}F NMR spectrum in DMF- d_7 (471 MHz)

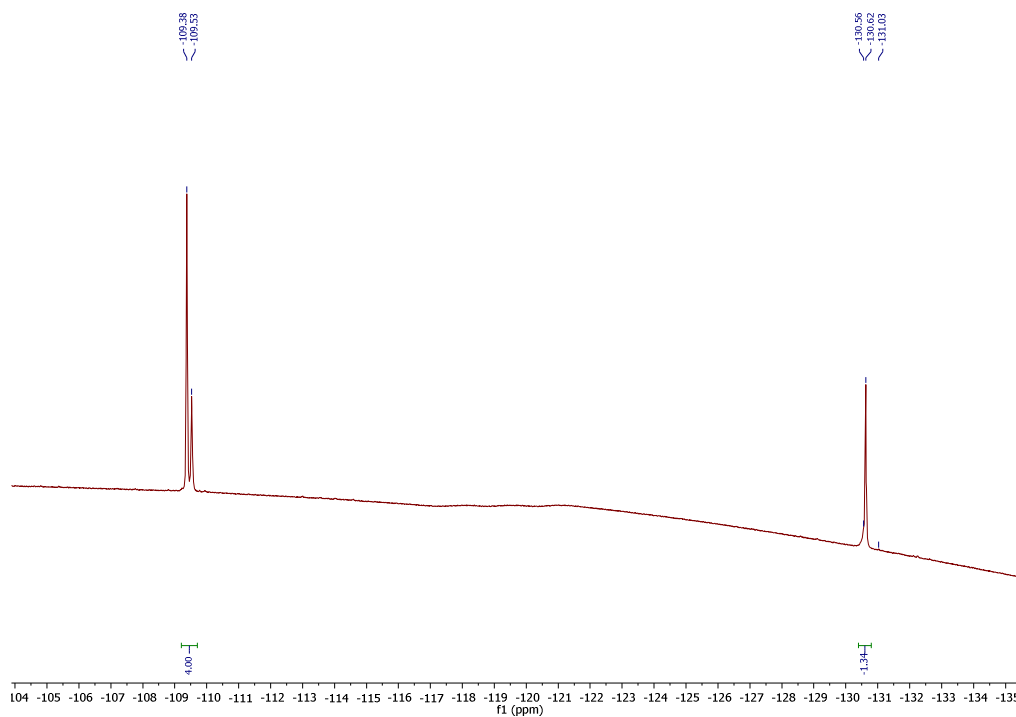

RP-HPLC elution profile (system F); “open-ring” isomer – red trace (254 nm); “closed-ring” isomer – blue trace (470 nm):

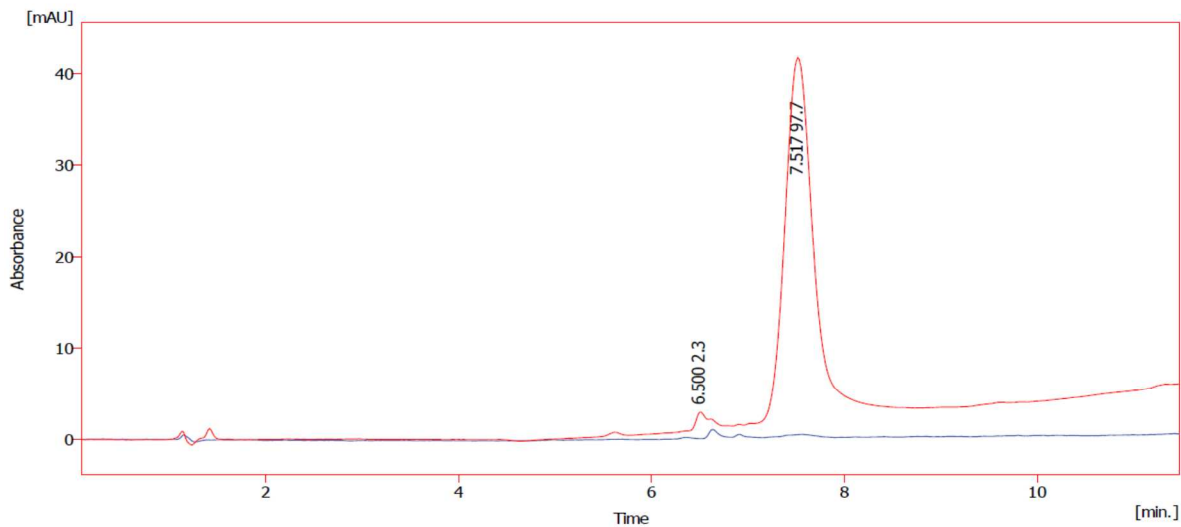

RP-HPLC elution profile (system F); “closed-ring” isomer, which shows green trace (254 nm) and black trace (470 nm), was isolated by HPLC and immediately analyzed in CD₃OD:

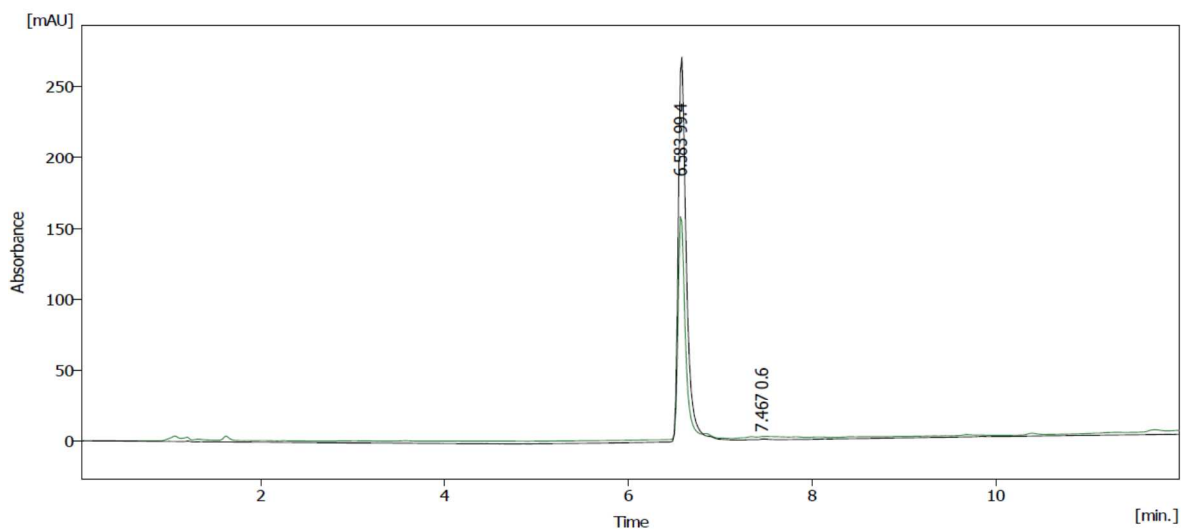

RP-HPLC elution profile (system F): “closed-ring” isomer dissolved in CD₃OD after storing for 3 weeks in the dark at room temperature; red trace (254 nm) and blue trace (470 nm)

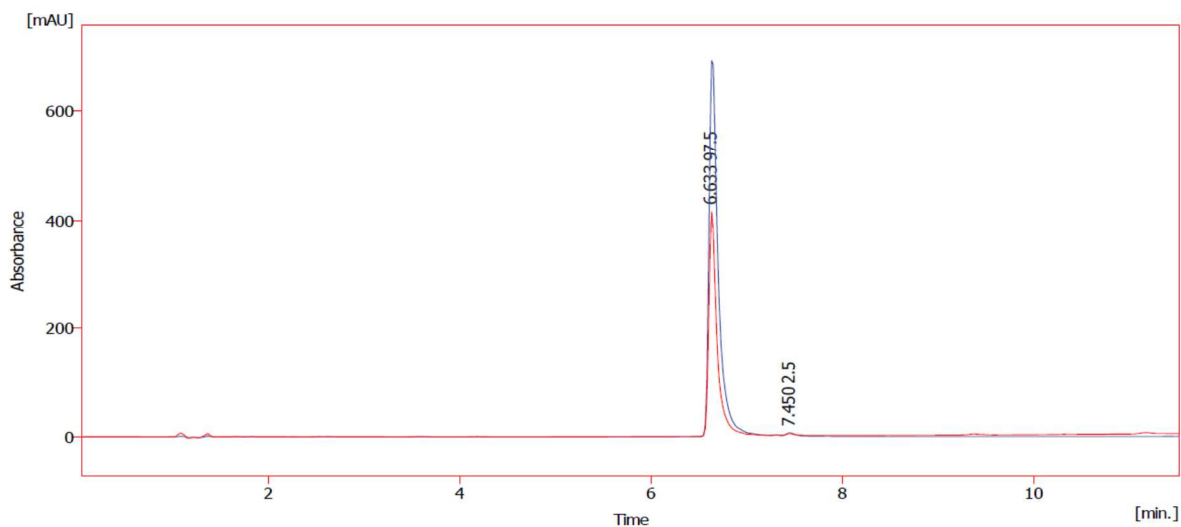

6. References

- (1) Li, F.; Basile, V. M.; Pekarek, R. T.; Rose, M. J., *ACS Appl. Mater. Interfaces* **2014**, *6*, 20557-20568.
- (2) Paramelle, D.; Cantel, S.; Enjalbal, C.; Amblard, M.; Forest, E.; Heymann, M.; Geourjon, C.; Martinez, J.; Subra, G., *Proteomics* **2009**, *9*, 5384-5388.
- (3) Gillanders, F.; Giordano, L.; Diaz, S. A.; Jovin, T. M.; Jares-Erijman, E. A., *Photochem. Photobiol. Sci.* **2014**, *13*, 603-612.
- (4) Uno, K.; Niikura, H.; Morimoto, M.; Ishibashi, Y.; Miyasaka, H.; Irie, M., In situ preparation of highly fluorescent dyes upon photoirradiation. *J. Am. Chem. Soc.* **2011**, *133* (34), 13558-13564.
- (5) Matsuda, K.; Irie, M., *Chem. Eur. J.* **2001**, *7*, 3466-3473.
- (6) Dempsey, G. T.; Vaughan, J. C.; Chen, K. H.; Bates, M.; Zhuang, X. W. *Nat. Methods* **2011**, *8*, 1027-1036.