

Microbial nitrous oxide production and nitrogen cycling associated with aquatic invertebrates

Dissertation
zur Erlangung des Doktorgrades
der Naturwissenschaften
-Dr.rer.nat.-

dem Fachbereich Biologie/Chemie
der Universität Bremen
vorgelegt von

Ines Heisterkamp

Bremen
Juni 2012

Die vorliegende Arbeit wurde in der Zeit von Januar 2009 bis Juni 2012 am Max-Planck-Institut für marine Mikrobiologie in Bremen angefertigt.

1. Gutachter: Prof. Dr. Bo Barker Jørgensen
2. Gutachter: Prof. Dr. Ulrich Fischer

Prüfer:

Dr. Peter Stief

Prof. Dr. Victor Smetacek

Tag des Promotionskolloquiums: 6. August 2012

Table of contents

Summary	5
Zusammenfassung	7
Chapter 1	11
General introduction	12
Aims of the thesis	44
Overview of manuscripts	46
References	49
Chapter 2	63
Nitrous oxide production associated with coastal marine invertebrates	
Chapter 3	85
Shell biofilm-associated nitrous oxide production in marine molluscs: processes, precursors and relative importance	
Chapter 4	117
Shell biofilm nitrification and gut denitrification contribute to emission of nitrous oxide by the invasive freshwater mussel <i>Dreissena polymorpha</i> (Zebra Mussel)	
Chapter 5	133
Incomplete denitrification in the gut of the aquacultured shrimp <i>Litopenaeus vannamei</i> as source of nitrous oxide	
Chapter 6	155
Indirect control of the intracellular nitrate pool of intertidal sediment by the polychaete <i>Hediste diversicolor</i>	
Chapter 7	183
Conclusion and perspectives	
Contributed works.....	203
Danksagung.....	211

Summary

Nitrogen cycling is intimately linked to the activity of microorganisms that mediate the diverse nitrogen transformations and play a fundamental role in regulating the fate of nitrogen in the Earth's terrestrial and aquatic ecosystems. Microbial activity is influenced by physical, chemical, and biological factors that can be profoundly shaped by macrofaunal organisms, especially in benthic aquatic systems. This thesis therefore aimed at investigating the interactions between microorganisms and benthic aquatic invertebrates and their role in biogeochemical nitrogen cycling, especially regarding the production of nitrous oxide (N₂O). This intermediate and by-product of microbial nitrogen cycling processes (mainly nitrification and denitrification) is of great importance as a greenhouse gas and ozone-depleting substance in the atmosphere. To date, the biogenic N₂O sources remain poorly quantified in the global N₂O budget. Natural N₂O production mainly takes place in soils, sediments, and water bodies, but also occurs in the anoxic gut of earthworms and freshwater invertebrates.

This thesis investigated for the first time the N₂O emission potential of marine invertebrates that densely colonize coastal benthic ecosystems. An initial screening effort in the German Wadden Sea and Aarhus Bay, Denmark, revealed a large variety of marine invertebrate species as N₂O emitters (Chapter 2). Statistical analysis showed that the N₂O emission potential is not restricted to a certain taxonomic group or feeding guild, but rather correlates with body weight, habitat, and the presence of microbial biofilms on the shell or exoskeleton of the animals. This suggests that N₂O emission from marine invertebrates is not necessarily due to denitrification in the gut, but may also result from microbial activity on the external surfaces of the animal.

The novel pathway of N₂O production in shell biofilms was investigated in detail by a combination of short-term and long-term incubation experiments, stable isotope experiments, microsensors measurements, and molecular analysis (Chapters 3 and 4). Investigations on three marine (*Mytilus edulis*, *Littorina littorea*, *Hinia reticulata*) and one freshwater mollusc species (*Dreissena polymorpha*) revealed that shell biofilms significantly contribute to the total animal-associated N₂O production via both denitrification and nitrification. Ammonium excretion by the molluscs was sufficient to

sustain nitrification-derived N₂O production in the shell biofilms and thus potentially decouples invertebrate-associated N₂O production from environmental nitrogen concentrations. This was demonstrated in detail for the snail *H. reticulata*, which promotes growth and N₂O production of its shell biofilm by enriching its immediate surroundings with dissolved inorganic nitrogen.

The shrimp *Litopenaeus vannamei*, the most important crustacean species in aquaculture worldwide, was found to emit N₂O at the highest rate recorded for any marine invertebrate so far (Chapter 5). The shrimp gut represents a transient anoxic habitat in which ingested bacteria produce N₂O due to incomplete denitrification. At high stocking densities, *L. vannamei* may significantly contribute to the N₂O supersaturation observed in the rearing tank of the shrimp aquaculture.

In an additional study, the fate of nitrogen was investigated in an animal-bacteria-microalgae interaction occurring in intertidal flats (Chapter 6). Diatoms were found to store more nitrate intracellularly when the polychaete *Hediste diversicolor* stimulated the activity of nitrifying bacteria by excretion of ammonium and oxygenation of the sediment. This intricate interplay alters the forms and availability of the important nutrient nitrogen in marine sediments.

Conceptually, benthic invertebrates represent “hotspots” of microbial nitrogen cycling that add specific features to the general marine nitrogen cycle, such as the noticeable N₂O production and the partial decoupling of microbial activity from ambient nutrient supply. In particular, this thesis revealed that invertebrate-associated N₂O production constitutes an important link between reactive nitrogen in aquatic environments and atmospheric N₂O and is controlled by environmental, autecological, and physiological factors.

Zusammenfassung

Der Stickstoffkreislauf ist aufs Engste mit der Aktivität von Mikroorganismen verknüpft, die verschiedenste Stickstoffumwandlungen durchführen und eine entscheidende Rolle für die Umsetzung sowie den Verbleib von Stickstoffverbindungen in terrestrischen und aquatischen Ökosystemen spielen. Die mikrobielle Aktivität wird durch verschiedene physikalische, chemische und biologische Faktoren reguliert, welche maßgeblich durch wirbellose Tiere (Invertebraten) beeinflusst werden können. Dies gilt in besonderer Weise für das Benthos aquatischer Ökosysteme. Das Ziel der vorliegenden Arbeit war es daher, die Interaktionen zwischen Mikroorganismen und benthischen Invertebraten sowie ihre Rolle im biogeochemischen Stickstoffkreislauf zu erforschen. Schwerpunktmäßig wurde dabei die Produktion von Distickstoffmonoxid (N_2O), auch bekannt als Lachgas, untersucht. Dieses Zwischen- und Nebenprodukt zahlreicher mikrobieller Stickstoffumwandlungen (hauptsächlich Nitrifikation und Denitrifikation) ist von globaler Bedeutung, da es in der Erdatmosphäre signifikant zum Treibhauseffekt und zum Ozonabbau beiträgt. Im globalen N_2O -Budget sind die biogenen Quellen von N_2O allerdings bis heute nur unvollständig quantifiziert. Biogene Produktion von N_2O findet hauptsächlich im Boden sowie in den Sedimenten und der Wassersäule aquatischer Ökosysteme statt, wurde aber auch in den sauerstofffreien Därmen von Regenwürmern und Süßwasser-Invertebraten beobachtet.

In der vorliegenden Arbeit wurde nun zum ersten Mal das N_2O -Emissionspotenzial mariner Invertebraten untersucht, die küstennahe Sedimente dicht besiedeln. Zu Beginn der Arbeit wurde ein Screening verschiedener Tierarten aus dem deutschen Wattenmeer und der Bucht von Aarhus in Dänemark durchgeführt (Kapitel 2). Dabei erwiesen sich zahlreiche marine Invertebraten-Arten als N_2O -Emittenten. Eine statistische Analyse zeigte, dass ein vorliegendes N_2O -Emissionspotenzial nicht auf bestimmte taxonomische Gruppen und Ernährungstypen beschränkt ist, sondern mit dem Körpergewicht, dem Habitat und dem Vorhandensein von mikrobiellen Biofilmen auf der Schale oder dem Exoskelett der Tierarten korreliert. Diese Befunde deuteten erstmals darauf hin, dass die N_2O -Emission mariner Invertebraten nicht zwangsläufig durch Denitrifikation im Darm bedingt ist, sondern auch auf mikrobielle Aktivitäten auf der Oberfläche des Tieres zurückgehen kann.

Dieser neue N_2O -Produktionsweg in „Schalen-Biofilmen“ wurde im Detail mit Kurzzeit- und Langzeit-Inkubationsexperimenten, stabilen Isotopen-Experimenten, Mikrosensormessungen und molekularbiologischen Analysen untersucht (Kapitel 3 und 4). Untersuchungen von drei marinen (*Mytilus edulis*, *Littorina littorea*, *Hinia reticulata*) und einer Süßwasser-Molluskenart (*Dreissena polymorpha*) ergaben, dass „Schalen-Biofilme“ signifikant zur N_2O -Emission des gesamten Tieres beitragen, und zwar sowohl aufgrund von Denitrifikation als auch Nitrifikation. Die Exkretion von Ammonium durch die Mollusken war stets ausreichend, um die N_2O -Produktion durch Nitrifikation aufrechtzuerhalten, und kann demnach die mit dem Tier assoziierte N_2O -Emission von der Stickstoffkonzentration im umgebenden Wasser entkoppeln. Dieses wurde im Detail für die Schneckenart *H. reticulata* nachgewiesen, welche das Wachstum und die N_2O -Produktion von „Schalen-Biofilmen“ fördert, indem sie ihre eigene unmittelbare Umgebung mit gelöstem inorganischem Stickstoff anreichert.

Die Garnele *Litopenaeus vannamei* ist die weltweit wichtigste Crustaceen-Art in Aquakultur und emittiert N_2O mit der höchsten Rate, die bislang für marine Invertebraten gemessen werden konnte (Kapitel 5). Der Darm der Garnele stellt für ingestierte Bakterien ein anoxisches Kurzzeithabitat dar, in dem sie N_2O durch unvollständige Denitrifikation produzieren. Bei hoher Besatzdichte trägt *L. vannamei* vermutlich signifikant zu der in den Zuchtbecken beobachteten N_2O -Übersättigung bei.

In einer weiteren Studie wurde untersucht, wie eine Tier-Mikroben-Mikroalgen Interaktion den Stickstoffkreislauf in Wattsedimenten beeinflusst (Kapitel 6). Es zeigte sich, dass Diatomeen dann mehr Nitrat intrazellulär speichern, wenn die Polychaeten-Art *Hediste diversicolor* die Aktivität nitrifizierender Bakterien durch Exkretion von Ammonium und Oxygenierung des Sedimentes stimuliert. Dieses komplexe Zusammenspiel führt dazu, dass Form und Verfügbarkeit von Stickstoff als überaus wichtigem Nährstoff in marinen Sedimenten verändert werden.

Konzeptionell stellen benthische Invertebraten „hotspots“ mikrobieller Stickstoffumsetzungen dar, die den allgemeinen Stickstoffkreislauf mit besonderen Leistungen ergänzen, wie z.B. mit einer beachtlichen N_2O -Produktion und einer teilweisen Entkopplung mikrobieller Aktivität von der Nährstoffzufuhr in der Umwelt. Insbesondere konnte in der vorliegenden Arbeit gezeigt werden, dass die Invertebraten-

assoziierte N_2O -Produktion eine wichtige Verbindung zwischen reaktiven Stickstoffverbindungen in aquatischen Ökosystemen und dem atmosphärischen N_2O darstellt, die maßgeblich durch autökologische, physiologische und Umweltfaktoren bestimmt wird.

Chapter 1

General introduction

This thesis aimed at investigating interactions between microorganisms and benthic aquatic invertebrates and their role in biogeochemical nitrogen cycling. The primary objective of this thesis was to unravel the potential and the underlying mechanisms of microbial N₂O production associated with aquatic invertebrates (Chapters 2 to 5). In addition, the impact of an invertebrate-bacteria-microalgae interaction on the intracellular nitrate pool in marine sediment was investigated (Chapter 6). To give a background for the following Chapters the general introduction will give an overview on 1) the major processes of the nitrogen cycle and the role of nitrogen as important nutrient, 2) the effects of nitrous oxide, its sources and sinks, and the estimated global N₂O-budget, 3) the pathways of microbial N₂O production and their controlling factors, 4) nitrogen cycling and important sites and processes of N₂O production in aquatic environments, 5) the effects of invertebrates on nitrogen turnover in aquatic environments, and finally on 6) N₂O emission by benthic macrofauna and other organisms.

The nitrogen cycle – processes, environmental importance and anthropogenic alteration

Nitrogen (N) is a key element for life on Earth, as all living organisms require nitrogen for the synthesis of proteins, nucleic acids, and other important N-containing biomolecules. It exists in a multiplicity of organic and inorganic forms and in a wide range of oxidation states, ranging from –III in ammonium (NH₄⁺) and organic matter to +V in nitrate (NO₃⁻) (Hulth et al. 2005, Gruber 2008). The N cycle is almost entirely dependent on redox reactions (Figure 1). These chemical transformations are primarily mediated by microorganisms that use nitrogen to synthesize biomass or to gain energy for growth (Zehr & Ward 2002, Canfield et al. 2010). Microorganisms are therefore key players in biogeochemical cycling of nitrogen, which mainly takes place in soils, sediments and water bodies.

Processes of the nitrogen cycle

N_2 -fixing microorganisms play a fundamental role in the nitrogen cycle, since they are the only organisms that can use the huge reservoir of dinitrogen gas (N_2) in the atmosphere (Carpenter & Capone 2008). With help of their nitrogenase enzyme complex, they break the very strong triple bond of N_2 and reduce N_2 to NH_4^+ that is incorporated into particulate organic nitrogen (PON). All other organisms rely on the supply of fixed nitrogen forms, also referred to as reactive nitrogen (N_r). Microorganisms and plants take up dissolved inorganic nitrogen (DIN = NH_4^+ , nitrite (NO_2^-), and NO_3^-) from the environment and assimilate it into PON (Oaks 1992, Mulholland & Lomas 2008). In addition, microorganisms and some plants can use dissolved organic nitrogen (DON) compounds (e.g., urea and amino acids, Jones et al. 2004, Bradley et al. 2010). Animals meet their nitrogen requirements by feeding on PON. The organic nitrogen in living and dead organisms is recycled back to inorganic nitrogen by remineralization processes. Heterotrophic microbes and animals degrade the N-containing macromolecules and subsequently release NH_4^+ and DON (Canfield et al. 2005).

In the presence of oxygen (O_2), NH_4^+ is oxidized over NO_2^- to NO_3^- by chemolithotrophic bacteria and archaea in a process known as nitrification (Ward 2008). The gas nitrous oxide (N_2O) is produced as a by-product in this process. The resulting oxidized compounds NO_2^- and NO_3^- (NO_x^-) are used as electron acceptors by diverse groups of microorganisms when the terminal electron acceptor O_2 is limiting. NO_x^- is either reduced to NH_4^+ by a process called dissimilatory nitrate reduction to ammonium (DNRA) or to N_2 by the process of denitrification (Lam & Kuypers 2011). Both processes are mainly carried out by heterotrophic bacteria, but nitrate reduction can also be coupled to the oxidation of inorganic compounds by chemolithotrophs. Denitrification produces N_2O as an intermediate (Knowles 1982), whereas DNRA is thought to produce trace amounts of N_2O as by-product (Kelso et al. 1997, Cruz-Garcia et al. 2007). Besides denitrification, N_2 is also produced by anaerobic ammonium oxidation (Mulder et al. 1995, Strous et al. 1999). During this so-called anammox process, anaerobic chemoautotrophic bacteria within the group of planctomycetes produce N_2 by coupling the reduction of NO_2^- with the oxidation of NH_4^+ . The

anammox- and DNRA-bacteria are generally strict anaerobes, while most denitrifying bacteria are facultative anaerobes. Denitrification and anammox play a fundamental role in the N cycle by returning N_2 gas back to the atmosphere and thus reducing the amount of biologically available nitrogen (Devol 2008). The N_2O produced during nitrogen cycling is either consumed by denitrification or escapes to the atmosphere.

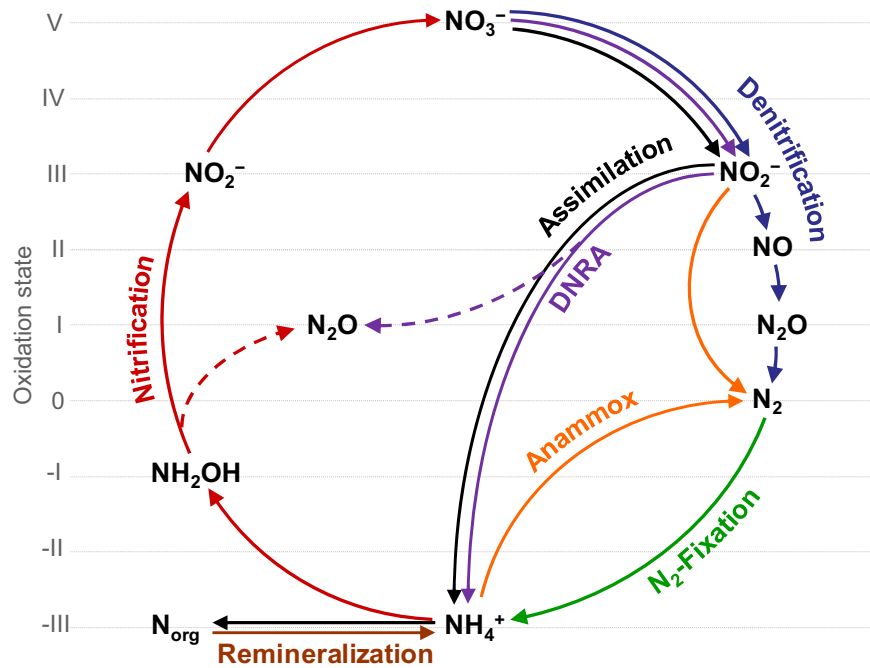

Figure 1: Major chemical species and transformations of the nitrogen cycle. The various chemical N-species are plotted versus their oxidation state. Major processes involved in N cycling: fixation of N_2 to NH_4^+ (green); assimilation of NO_3^- , NO_2^- , and NH_4^+ to organic nitrogen (N_{org}) (black); remineralization of N_{org} to NH_4^+ (brown); oxidation of NH_4^+ to NO_3^- via nitrification (red), reduction of NO_3^- to N_2 via denitrification (blue); dissimilatory reduction of NO_3^- to NH_4^+ (DNRA, purple); and anaerobic oxidation of NH_4^+ to N_2 (anammox, orange). N_2O is produced as by-product during nitrification and DNRA (dashed lines) and as intermediate in denitrification.

Environmental importance and anthropogenic alteration of the N cycle

The nitrogen cycle is of particular interest, as the availability of nitrogen influences the rate of key processes in terrestrial and aquatic ecosystems, such as primary production and decomposition of organic matter. It thereby interacts with biogeochemical cycles of many other elements, in particular carbon (Gruber & Galloway 2008). The scarcity of fixed inorganic nitrogen limits primary production in many marine and terrestrial ecosystems (Falkowski 1997, Vitousek et al. 2002). The nitrogen availability

consequently controls the amount of carbon dioxide (CO₂) that is fixed by plants or phytoplankton and thereby strongly influences the short-term sequestration of the greenhouse gas CO₂ in terrestrial ecosystems and the deep oceans (Falkowski et al. 1998, Zaehle et al. 2011). The global N cycle is thus fundamental to the functioning of the Earth's climate (Vitousek et al. 1997, Holland et al. 2005).

Over the last century, human activities have substantially altered the global N cycle by tremendously increasing the amount of reactive nitrogen in the biosphere (Galloway et al. 2008). The increase in N_r is largely due to two anthropogenic activities: (i) food production promoted by application of synthetic fertilizers and cultivation of N₂-fixing crops, and (ii) energy production by fossil fuel combustion (Vitousek et al. 1997, Galloway et al. 2004). Anthropogenic N_r sources provide nowadays almost 50% of the total fixed nitrogen produced annually on Earth (Canfield et al. 2010 and references therein). A significant fraction of the N_r applied on agricultural soils leaks into rivers, lakes, and aquifers, and is transported to coastal ecosystems (Boyer et al. 2006, Schlesinger 2009, Seitzinger et al. 2010), or evaporates as NH₃ or NO_x (NO + NO₂) and is globally distributed through atmospheric transport and subsequent deposition (Galloway & Cowling 2002). Anthropogenic N thus influences biogeochemical processes in terrestrial, freshwater, coastal, and oceanic ecosystems (Galloway et al. 2004, Duce et al. 2008).

The anthropogenic perturbation of the N cycle causes substantial and manifold environmental problems (Vitousek et al. 1997, Matson et al. 2002, Rabalais 2002). Among these are eutrophication of terrestrial and aquatic systems, acidification of soils and freshwaters, and increased emission of the greenhouse gas nitrous oxide. The massive acceleration of the N cycle is projected to further increase to sufficiently meet the human dietary and energy demands of a growing world population (Galloway et al. 2008). Efficient management in food and energy production and improved understanding of mechanisms controlling the fate of N_r in the environment are urgently needed to reduce the adverse effects of N_r on the Earth's biosphere and climate. This especially includes the pathways and mechanisms leading to the emission of the greenhouse gas N₂O, which are to date not satisfactorily understood (Galloway et al. 2008, Davidson 2009, Butterbach-Bahl & Dannenmann 2011).

Nitrous oxide – its properties, sources and sinks

Properties of nitrous oxide

Nitrous oxide (dinitrogen monoxide), also known as laughing gas, is a natural atmospheric trace gas with the molecular formula N_2O and a molar mass of 44 g mol^{-1} . Its solubility in water is very high with 24.1 mmol L^{-1} at a salinity of 34 and temperature of 20°C (Weiss & Price 1980). The present atmospheric concentration of N_2O is far higher than at any time during the past 140,000 years (Schilt et al. 2010). Within the past 10,000 years, changes in atmospheric N_2O concentration were relatively small until the beginning of the industrial era (Figure 2, Forster et al. 2007). Since then the atmospheric N_2O concentration has increased tremendously from 270 ppb in 1750 to 320 ppb in 2005. Within the last few decades, the concentration increased with a rate of 0.2–0.3% per year (Forster et al. 2007).

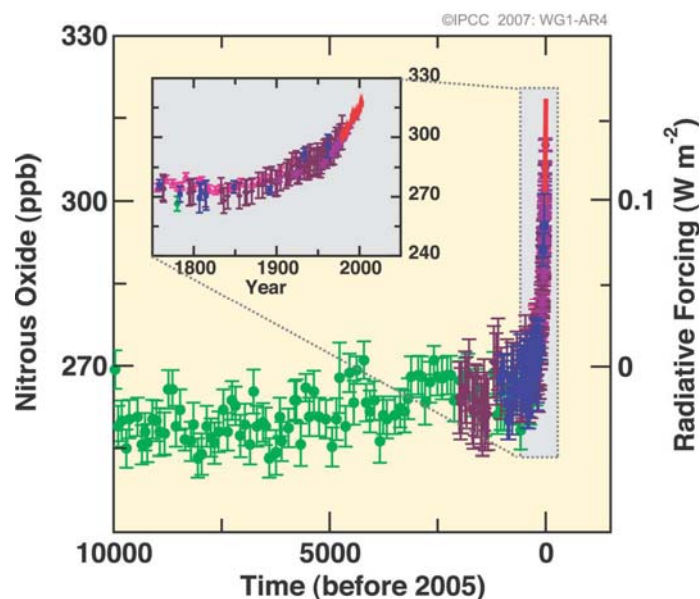
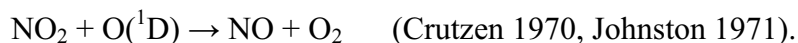
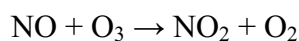

Figure 2: Atmospheric concentrations of nitrous oxide over the last 10,000 years (large panel) and since 1750 (inset panel). Measurements are shown from ice cores (symbols with different colours for different studies) and atmospheric samples (red lines). The corresponding radiative forcing is shown on the right hand axis of the large panel. The radiative forcing is a measure of the influence a factor has in altering the balance of incoming and outgoing energy in the Earth-atmosphere system and is an index of the importance of the factor as a potential climate change mechanism. A positive forcing (more incoming energy) tends to warm the system. Figure and text are taken from the Fourth Assessment Report of the Intergovernmental Panel on Climate Change (IPCC 2007).

The increasing atmospheric N₂O concentration is of particular interest, since N₂O greatly impacts the chemistry of the Earth's troposphere and stratosphere (Figure 3). In the troposphere, N₂O acts as a strong greenhouse gas by absorbing and re-emitting part of the infrared radiation coming from the Earth's surface and thereby heating the Earth system (Forster et al. 2007, Wuebbles 2009). Per molecule N₂O has an approximately 300 times higher global warming potential over a 100-year timescale than CO₂ and a particularly long atmospheric lifetime of about 120 years (Forster et al. 2007). It accounts for approximately 7-10% of the overall anthropogenic greenhouse effect and is the third most important human-induced greenhouse gas after CO₂ and methane (CH₄) (IPCC 2007).

In addition to its global warming effect in the troposphere, N₂O also plays a key role in the destruction of the stratospheric ozone layer (Ravishankara et al. 2009). Since N₂O is not removed from the troposphere by chemical reactions, it reaches the stratosphere where it reacts with excited oxygen (O(¹D)) to form nitric oxide (NO) (Schlesinger 1997, Olsen et al. 2001). NO in turn reacts with ozone (O₃) to form nitrogen dioxide (NO₂). The produced nitrogen oxides (NO + NO₂) destroy ozone via following reactions



Nearly all stratospheric NO is produced from N₂O, which is currently the most important ozone-depleting substance and is expected to remain the largest one throughout the 21st century (Ravishankara et al. 2009).

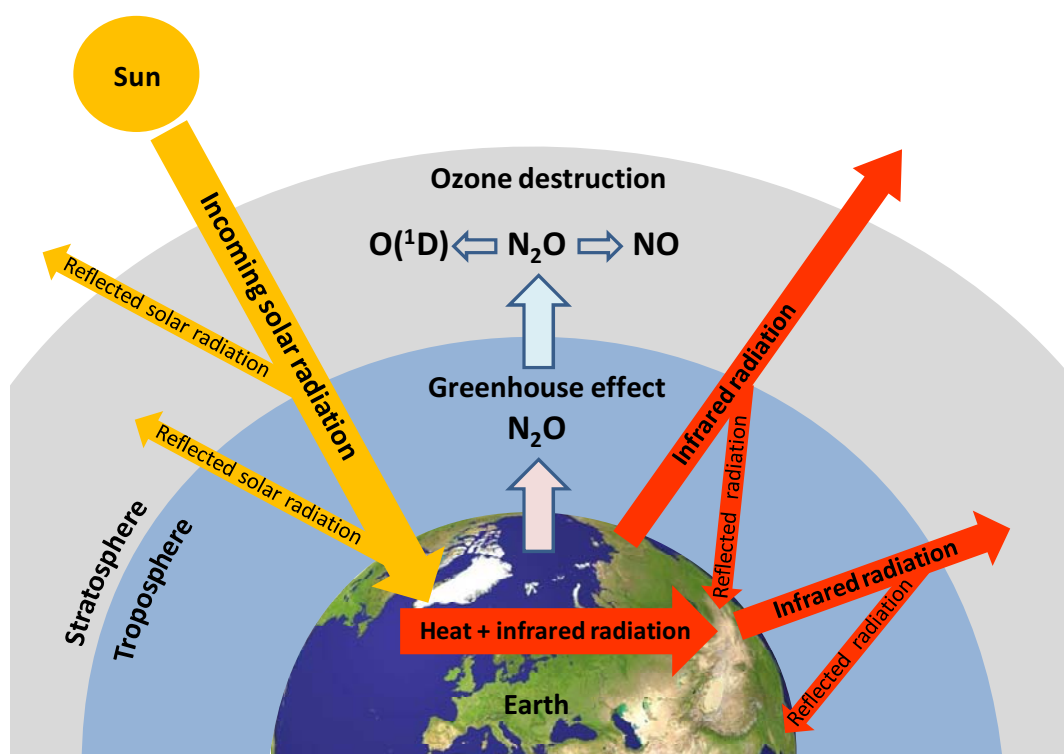

Figure 3: The impact of N₂O on the greenhouse effect and the destruction of the ozone layer. Solar radiation passes through the atmosphere, some radiation is reflected back, the remainder is absorbed by the Earth's surface. Here, it is converted into heat causing the emission of long-wave (infrared) radiation back to the atmosphere. In the troposphere, N₂O and other greenhouse gases absorb part of the infrared radiation and re-emit it back to the Earth's surface, thus warming up the Earth and the troposphere. The reflected radiation is re-emitted from the Earth's surface and is lost in space when it passes through the troposphere. In the stratosphere, N₂O is oxidized to NO or photolysed to N₂ and O(¹D) species. NO and O(¹D) react with O₃ and destroy the ozone layer.

Sources and sinks of nitrous oxide

A wide range of N₂O sources of natural and anthropogenic origin have been identified within the last few decades. However, the uncertainty ranges of the individual sources are high and there still remain unknown sites, mechanisms of production and regulating factors that need to be identified to refine the global N₂O budget (Forster et al. 2007, Rubasinghege et al. 2011). Syakila & Kroeze (2011) present the most recent estimates on the global N₂O budget and calculated the global N₂O emission to be 18.3 Tg N yr⁻¹ in the year 2000 (Table 1). Global N₂O emissions thus increased compared to the estimates for the 1990s (Table 1, Denman et al. 2007). Natural sources are estimated to account for 60% and anthropogenic sources for 40% of the global N₂O emissions

(Denman et al. 2007, Syakila & Kroeze 2011). Natural N₂O emissions derive primarily from soils (~ 60%) and oceans (~ 35%) via microbial N conversion processes (Denman et al 2007, Syakila & Kroeze 2011). Agriculture is the most important anthropogenic source and is responsible for 60–70% of the anthropogenic N₂O emissions (recent detailed inventories of agricultural emissions are available in Davidson 2009). The remaining 30–40% of the anthropogenic N₂O emissions arise from fossil fuel combustion, industrial processes, biomass and biofuel burning (Crutzen et al. 2008).

Agricultural activities do not only lead to direct N₂O emissions from fertilized soils and from animal production, but also to indirect N₂O emissions when fixed nitrogen applied to agricultural systems is released to natural environments by leaching, sewage, and atmospheric deposition of nitrogen oxides and ammonia (NH₃) (Mosier et al. 1998). Enhanced N₂O production in rivers, estuaries and coastal zones due to anthropogenic N input represent an important source of N₂O and are estimated to be 1.7 Tg N yr⁻¹ (Denman et al. 2007). However, the estimates for N₂O emissions from aquatic ecosystems remain highly uncertain (Nevison et al. 2004, Baulch et al. 2011). Beaulieu and coworkers (2010), for instance, calculated N₂O emission from river networks to be 0.68 Tg N yr⁻¹, which is three times higher than the emissions estimated by Denman et al. 2007. Seitzinger et al. (2000) calculated that rivers, estuaries, and continental shelves make up 35% of the total aquatic N₂O emissions and the open oceans the remaining 65%, while Bange et al. (1996) proposed that estuaries and continental shelves contribute as much as 60% to the total oceanic N₂O emission. Since anthropogenic N even reaches the open oceans and increases oceanic N₂O emission (Duce et al. 2008, Suntharalingam et al. 2012), oceans are included as both natural and anthropogenic sources in the updated N₂O budget (Table 1, Syakila & Kroeze 2011). Another source that is not yet included in the global N₂O budget is the N₂O emission from aquaculture. William and Crutzen (2010) estimated that N₂O emission from aquaculture accounts for 0.12 Tg N yr⁻¹ and argued that this emission is likely to increase to 1.01 Tg N yr⁻¹ within the next 20 years due to the rapid global growth rate of aquaculture industry. This estimate is solely based on theoretical N₂O emissions from nitrogenous waste of aquacultures. However, in Chapter 5 of this thesis, it is shown that also the aquacultured animals themselves can emit N₂O and thus represent an additional source of N₂O emission from aquacultures.

In contrast to the various sources of N₂O, the only major sinks of N₂O are the oxidation to NO or the photolysis to N₂ and O(¹D) in the stratosphere (Khalil et al. 2002). In addition, denitrification can act as a net sink of N₂O in forest soils, some aquatic systems, and riparian zones (reviewed in Chapuis-Lardy et al. 2007, Billings 2008). However, this surface uptake of N₂O is estimated to be about 0.01 Tg N yr⁻¹ and thus of minor importance for the global N₂O budget (Syakila & Kroeze 2011).

Table 1: Estimates of the global N₂O budget for the 1990s from the Fourth Assessment Report of the Intergovernmental Panel on Climate Change (IPCC, Denman et al 2007) and newest available estimates from Syakila & Kroeze (2011) for the year 2000 (Tg N yr⁻¹). Ranges of estimates are presented in brackets.

	1990s	2000
Sources of N₂O		
<i>Natural</i>	11	10.5
Soil	6.6 (3.3–9.0)	6–7
Ocean	3.8 (1.8–5.8)	3–4
Atmospheric chemistry	0.6 (0.3–1.2)	<1
<i>Anthropogenic</i>	6.7	7.8
Energy, industry, biomass burning	2.0 (0.7–3.7) ^a	1.9
Agriculture (including animal production)	4.7 (2.3–8.0)	4.9
Direct emissions	2.8 (1.7–4.8)	3.8
Indirect emissions	1.9 (0.6–3.2)	1.1
Human excreta/sewage	0.2 (0.1–0.3)	–
Rivers, estuaries and coastal zones	1.7 (0.5–2.9)	–
Oceans	–	1.0
Total	17.7 (8.5–27.7)	18.3
Sinks of N₂O		
Surface sink	–	0.01
Stratospheric sink	12.5 (10.0–15.0)	
Net atmospheric increase		6.8

^a Including N₂O from atmospheric deposition, which is in part agricultural

Pathways of microbial nitrous oxide production

Biogenic N₂O production in natural and anthropogenically influenced ecosystems originates primarily from microbial processes. Although a wide range of microbial pathways has the potential to produce N₂O, its production in soils, sediments and water bodies is mainly ascribed to two processes: denitrification and nitrification (Bange 2008, Kool et al. 2011).

Denitrification

Denitrification, the respiratory reduction of NO₃⁻ or NO₂⁻ to N₂, is typically considered to be the dominant N₂O source in soils, sediments and anoxic water bodies, as it is induced under low O₂ or anoxic conditions (Codispoti et al. 2001, Bouwman et al. 2002). This facultative anaerobic respiration process is phylogenetically widespread, occurring in the domains Bacteria (Zumft 1997), Archaea (Cabello et al. 2004), and few Eukaryota such as fungi (Shoun et al. 1992) and foraminifera (Risgaard-Petersen et al. 2006). Most research has focused on denitrifiers within the proteobacteria (alpha, beta, gamma, and epsilon divisions), since these are generally believed to be the dominant denitrifying organisms in most environments (Wallenstein et al. 2006).

The complete denitrification pathway (NO₃⁻ → NO₂⁻ → NO → N₂O → N₂) involves four enzymatically catalyzed reduction steps (Figure 4 and 6). In bacteria, the dissimilatory reduction of NO₃⁻ to NO₂⁻ is mediated either by the membrane-bound nitrate reductase (NAR) that has its active site in the cytoplasm or by the periplasmic nitrate reductase (NAP) (Gonzalez et al. 2006). These nitrate reductases are, however, also present in nitrate-reducing bacteria that do not denitrify (e.g., DNRA bacteria) (Zumft 1997, Wallenstein et al. 2006, Richardson et al. 2009). The NO₂⁻ produced is then reduced to NO by a periplasmic nitrite reductase (NIR). Two evolutionarily unrelated forms of the NIR enzyme exist, a copper-containing reductase, encoded by the *nirK* gene, and a cytochrome *cd1*-nitrite reductase, encoded by the *nirS* gene (Zumft 1997). Reduction of the highly reactive and toxic NO to the non-toxic N₂O is catalyzed by the nitric oxide reductase (NOR), an integral membrane protein with its active site in the periplasm. NIR and NOR are controlled interdependently at both the transcriptional

and enzyme level to prevent accumulation of NO (Ferguson 1994, Zumft 1997). The periplasmic nitrous oxide reductase (NOS) mediates the reduction of N_2O to N_2 and is thus crucial for determining whether denitrification acts as a source or sink of N_2O . The described anaerobic reaction chain is split over the periplasmic and cytoplasmic compartments, which allows the formation of a proton gradient across the bacterial membrane that is used for synthesis of ATP and NADH (Zumft 1997, Kraft et al. 2011).

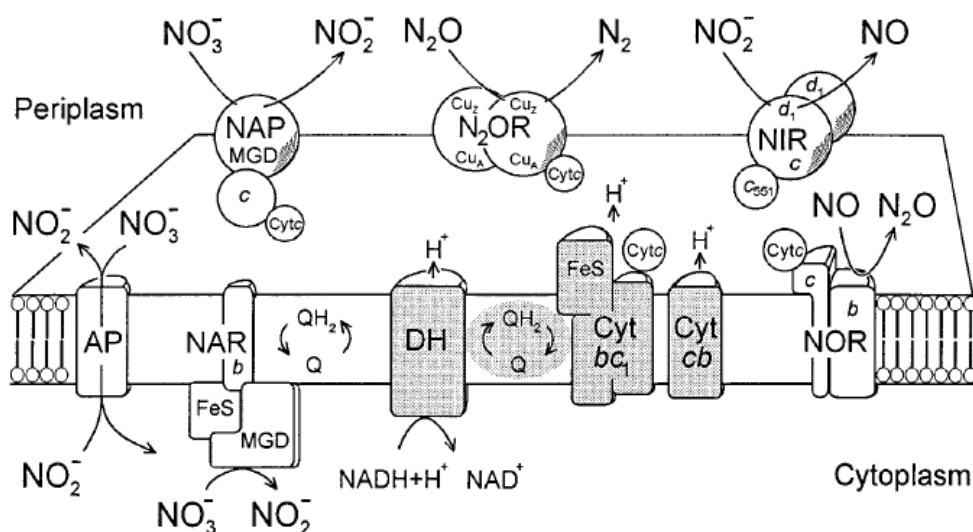

Figure 4: Organization and sidedness of the anaerobic electron transfer chain of the denitrifying bacterium *Pseudomonas stutzeri*. The shaded areas represent the components of the constitutive aerobic respiratory chain consisting of an NADH dehydrogenase complex (DH), quinone cycle (Q, QH_2), cytochrome bc_1 complex (Cyt bc_1), and the cytochrome cb terminal oxidase complex (Cyt cb). The respiratory denitrification system comprises membrane-bound (NAR) and periplasmic (NAP) NO_3^- reductases, NO_2^- reductase (NIR), NO reductase (NOR), and N_2O reductase (N_2OR). Abbreviations: FeS, iron-sulfur centers; b , c , and d_1 , heme B, heme C, and heme D_1 , respectively; cyt c , unspecified c -type cytochromes accepting electrons from the bc_1 complex and acting on N_2OR and NOR; cyt c_{551} , cytochrome c_{551} ; AP, postulated $\text{NO}_3^-/\text{NO}_2^-$ antiporter. Figure and text are taken from Zumft (1997).

Denitrification is coupled to the oxidation of organic carbon (C_{org}) in heterotrophic denitrifiers or to the oxidation of inorganic compounds such as ferrous iron, reduced sulfur compounds, and hydrogen in autotrophic denitrifiers (Knowles 1982, Zumft 1997, Straub & Buchholz-Cleven 1998). Overall, denitrification enzymes are induced when O_2 concentrations are low and oxidized inorganic N compounds as well as appropriate organic or inorganic electron donors are available (Tiedje 1988). Denitrification can, however, also occur under oxic conditions, as has been shown for several isolated bacterial species (Robertson & Kuenen 1984, Robertson et al. 1989, Patureau et al.

2000), and for microbial communities in aquatic (Trevors & Starodub 1987, Gao et al. 2010) and terrestrial environments (Lloyd 1993). This aerobic denitrification often results in the accumulation of N_2O as do shifts from anoxic to oxic conditions, since the NOS enzyme of many denitrifiers shows a higher sensitivity towards O_2 than the other denitrification enzymes (Bonin & Raymond 1990, Frette et al. 1997, Patureau et al. 2000). Furthermore, it is common that denitrifying bacteria do not possess all four reductases and are consequently not capable to perform the complete denitrification process. It is estimated that the percentage of N_2O -respiring taxa is only 10–15% of all known denitrifying taxa (Zumft & Kroneck 2007). Therefore, N_2O is also primarily produced when bacterial strains containing NOS are underrepresented in the bacterial community (Zumft 1997, Gregory et al. 2003).

Nitrification

Nitrification is the stepwise aerobic oxidation of NH_4^+ to NO_2^- and further to NO_3^- . The oxidation of NH_4^+ to NO_2^- is performed by chemolithoautotrophic ammonia-oxidizing bacteria (AOB) and, as recently discovered, by ammonia-oxidizing archaea (AOA) (Kowalchuk & Stephen 2001, Konneke et al. 2005). The second step, the oxidation of NO_2^- to NO_3^- , is mediated by a separate group of chemolithoautotrophic bacteria known as nitrite-oxidizing bacteria (NOB) (Ward 2008). Both oxidation steps require molecular oxygen. Nitrification is thus an obligatory aerobic pathway.

Ammonia-oxidizing bacteria

Ammonia-oxidizing bacteria are ubiquitous in soils, freshwater, and marine environments (Koops & Pommerening-Röser 2005). They are found exclusively in three groups of Proteobacteria: the beta-proteobacterial *Nitrosomonas* and *Nitrospira*, and the gamma-proteobacterial *Nitrosococcus* (Head et al. 1993, Purkhold et al. 2000). AOB metabolize NH_4^+ in the form of NH_3 and oxidize it to NO_2^- in a two-step process (Figure 5, Kowalchuk & Stephen 2001). NH_3 is first oxidized to hydroxylamine (NH_2OH) by the membrane-bound, multisubunit enzyme ammonia monooxygenase (AMO). In the second step, NH_2OH is oxidized to NO_2^- via the periplasmic enzyme hydroxylamine oxidoreductase (HAO) (Arp et al. 2002). This second oxidation step releases four electrons, of which two are returned to AMO and the other two are passed

via an electron transport chain to the terminal oxidase, thereby generating an electrochemical H^+ gradient over the cytoplasmic membrane (Figure 5). This proton motive force is used for ATP-synthesis and for the formation of NADH by reverse electron flow and provides the energy and reducing equivalents for CO_2 fixation (Arp & Stein 2003, Ferguson et al. 2007).

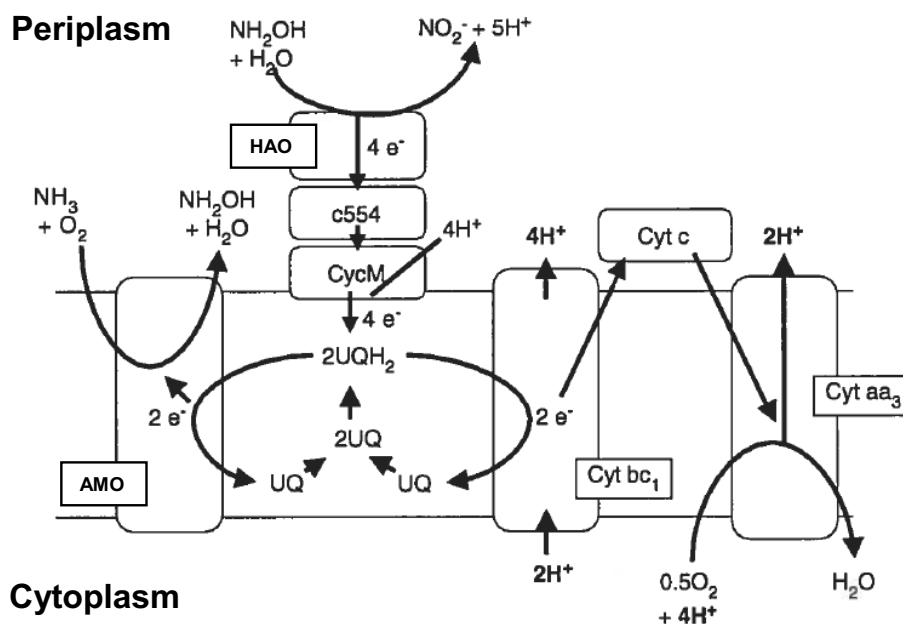

Figure 5: A scheme for electron transport pathways in the ammonia-oxidizing bacterium *Nitrosomonas europaea*. It is assumed that electrons derived from NH_2OH are delivered from NH_2OH dehydrogenase (HAO) to ubiquinone (UQ) via cytochrome c_{554} and cytochrome c_m . It is assumed that cytochrome c_m catalyses ubiquinol formation with concomitant uptake of H^+ from the periplasmic side. The active site of the ammonia mono-oxygenase (AMO) is positioned on the periplasmic side. Protons released upon the putative oxidation of UQH_2 by AMO are not shown but probably are released to the periplasm. Modified after Ferguson et al. (2007).

AOB are currently recognized as the main N_2O producers under oxic conditions (Kool et al. 2011). They produce N_2O as a by-product during the oxidation of NH_2OH to NO_2^- (Figure 1 and 6). This is especially the case when the turnover of AMO and HAO are not in balance and the concentration of NH_2OH is increased (Cantera & Stein 2007, Yu et al. 2010). The produced NH_2OH can be reduced to NO and N_2O either enzymatically via HAO and NOR or chemically via chemodenitrification (Hooper & Terry 1979, Stuvén et al. 1992, Stein 2011).

Apart from this aerobic hydroxylamine oxidation pathway, AOB were shown to produce N_2O via a second distinct pathway, namely nitrifier denitrification. In this process, AOB oxidize NH_3 to NO_2^- that is subsequently reduced to NO , N_2O and N_2 (Ritchie & Nicholas 1972, Poth & Focht 1985, Bock et al. 1995). The reduction of NO_2^- is analogous to that in canonical denitrification, with the denitrification enzymes NIR, NOR and possibly also NOS being involved (Wrage 2001). Genes encoding the copper-containing NIR (*nirK*) and the small and large subunits of NOR (*norB* and *norC*) have been identified in various AOB strains, and it has been suggested that nitrifier denitrification is a universal trait in the beta-proteobacterial AOB (Casciotti & Ward 2001, Schmidt et al. 2004, Shaw et al. 2006, Cantera & Stein 2007). However, genes encoding the canonical NOS reductase of denitrifying bacteria have not been identified in AOB genomes yet (Kim et al. 2010).

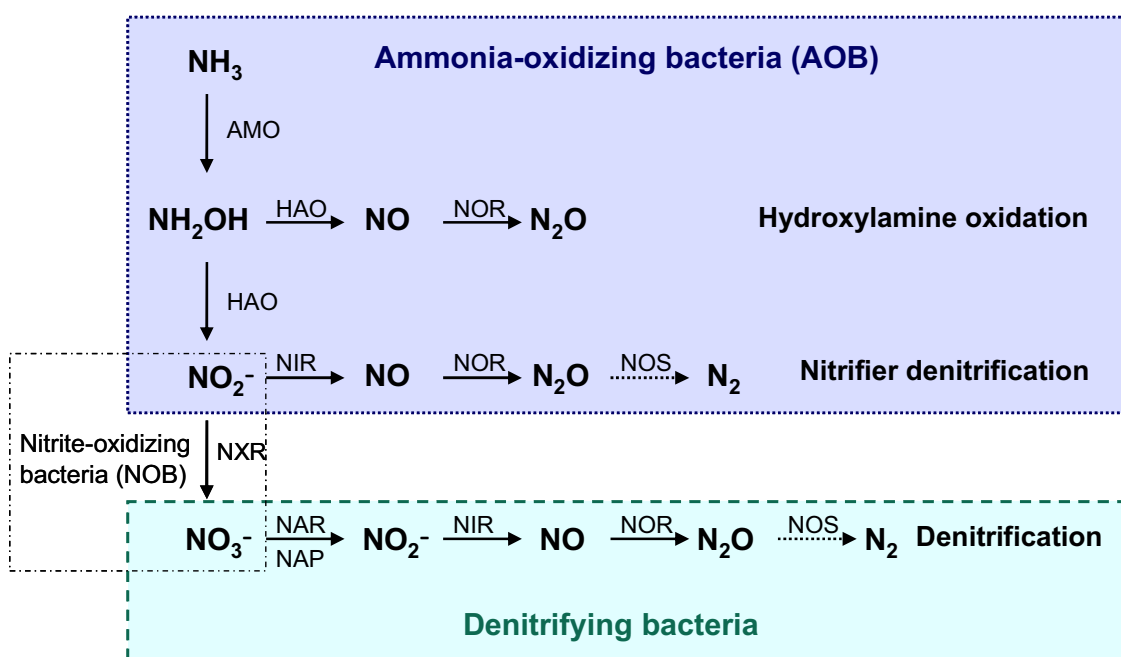

Figure 6: Major N_2O producing pathways of nitrifying and denitrifying bacteria. Ammonia-oxidizing bacteria produce N_2O via the hydroxylamine oxidation and the nitrifier denitrification pathway. Dashed lines indicate necessary reduction steps to consume N_2O . AMO, ammonia monooxygenase; HAO, hydroxylamine oxidoreductase; NXR, nitrite oxidoreductase of nitrite-oxidizing bacteria (NOB); NAR and NAP, different types of nitrate reductase; NIR, nitrite reductase; NOR, nitric oxide reductase; NOS, nitrous oxide reductase. Modified after Stein (2011).

Although a rising number of studies suggests that nitrifier denitrification significantly contributes to N₂O production from soil, its verification remains difficult because of methodological constraints (Kool et al. 2011 and references therein). AOB from pure cultures and complex biofilms were shown to produce high amounts of N₂O under low O₂ concentrations and/or high NO₂⁻ concentrations (Beaumont et al. 2004, Shaw et al. 2006, Schreiber et al. 2009). It is therefore suggested that the nitrifier denitrification pathway is used to gain energy from the reduction of NO₂⁻ at O₂-limiting conditions or it is used to detoxify NO₂⁻ that is produced during nitrification (Poth & Focht 1985, Bock et al. 1995, Beaumont et al. 2004).

Ammonia-oxidizing archaea

The oxidation of NH₄⁺ to NO₂⁻ was for more than a century exclusively attributed to chemolithoautotrophic bacteria (Pester et al. 2011). The recent discovery of ammonia-oxidizing archaea (AOA) within the novel phylum Thaumarchaeota radically changed the view on the microbiology of nitrification (Konneke et al. 2005, Pester et al. 2011). Metagenomic surveys targeting archaeal 16S rRNA genes and ammonia monooxygenase genes (*amoA*) revealed the widespread distribution of archaea with the potential capacity to oxidize NH₃ as well as their numerical dominance over AOB in many marine and terrestrial environments (Francis et al. 2005, Leininger et al. 2006, Wuchter et al. 2006). These studies provide increasing evidence for the importance of AOA in global biogeochemical cycles, but our knowledge about physiology and ecosystem function of AOA is still in its infancy (Pester 2011). The biochemistry of archaeal NH₃ oxidation was proposed to be distinctively different from bacterial NH₃ oxidation. Walker et al. (2010) suggested that AOA either use different enzymes for NH₃ oxidation via NH₂OH to NO₂⁻, or oxidize NH₃ via nitroxyl (HNO) to NO₂⁻. The latter hypothetical pathway would suggest that AOA do not produce N₂O (Schleper & Nicol 2010). However, Santoro et al. (2011) showed that AOA indeed produce N₂O and proposed that N₂O production most likely arises from a process akin to nitrifier denitrification. The authors conclude that AOA could play an important role in N₂O production in the near-surface ocean. Whether the ubiquitous AOA significantly contribute to N₂O production in terrestrial and marine environments awaits further investigation.

Nitrite-oxidizing bacteria

Nitrite-oxidizing bacteria oxidize NO_2^- to NO_3^- by the nitrite oxidoreductase (NXR) (Figure 6). This oxidation step does not produce N_2O . The resulting transfer of two electrons to the terminal electron acceptor O_2 generates a proton gradient that is used for the synthesis of ATP and NADH reducing equivalents for CO_2 -fixation (Freitag & Bock 1990). The NO_3^- produced by NOB can be used directly by denitrifying bacteria in environments with oxic-anoxic transition zones that allow nitrification and denitrification to occur in close proximity (Figure 6).

Other pathways of nitrous oxide production

Besides N_2O production through autotrophic nitrification, canonical denitrification and nitrifier denitrification, several other N_2O -producing processes exist. NO detoxification pathways are broadly distributed throughout the bacteria and result in N_2O production via the enzymes flavohemoglobin (Hmp) and flavorubredoxin (NorVW) (Gardner et al. 2003, Stein 2011). Furthermore, ammonia-oxidation is not restricted to autotrophic organisms, but can also be performed by a wide range of heterotrophic nitrifiers that do not gain energy from the oxidation of NH_3 (Robertson & Kuenen 1990, Wrage 2001). Methane-oxidizing bacteria (MOB), which are closely related to AOB (Holmes et al. 1995), have also been shown to aerobically oxidize NH_3 to NO_2^- , thereby releasing NO and N_2O (Campbell et al. 2011). DNRA is thought to produce low amounts of N_2O as a by-product (Kaspar & Tiedje 1981, Kelso et al. 1997, Cruz-Garcia et al. 2007) and is increasingly recognized to be an important process in various environments (Silver et al. 2001, Lam et al. 2009, Koop-Jakobsen & Giblin 2010, Schmidt et al. 2011). In soils, for instance, DNRA is suggested to significantly contribute to N_2O production (Senga et al. 2006, Baggs 2011). So far, there is no evidence that N_2O is produced by the anammox process itself (Strous et al. 2006, Kuenen 2008, van der Star et al. 2008). However, anammox bacteria were shown to produce trace amounts of N_2O probably by detoxification of NO, activity of NH_2OH reductase or by reducing NO_3^- to NH_4^+ (Kartal et al. 2007). The potential significance of these diverse pathways as N_2O sources in various environments is, however, still unknown and needs further investigations (Stein 2011).

Environmental factors influencing nitrous oxide production

The amount of N₂O released by nitrification and denitrification depends on the total rate and the N₂O yield of the process (fraction of N₂O produced per NH₄⁺ or NO₃⁻ consumed). Both are regulated by a suite of physiological and ecological factors, of which oxygen concentration and substrate availability are of particular importance (Stein 2011).

Low O₂ concentrations generally lead to high N₂O yields from both nitrification and denitrification (Goreau et al. 1980, Betlach & Tiedje 1981, Codispoti 2010). The N₂O yield from nitrification increases with decreasing O₂ concentration mainly because of an increased rate of nitrifier denitrification (Wrage 2001 and references therein). The N₂O production from nitrification is usually favoured at hypoxic conditions when the N₂O yield is increased and enough O₂ is present to sustain a reasonably high process rate (Codispoti 2010). In denitrification, the increase in N₂O yield under low O₂ conditions is due to decreased activity of the oxygen-sensitive N₂O reductase (Bonin & Raymond 1990). The overall rate of denitrification is likely to slow down with increasing oxygen concentration, as the facultative anaerobic denitrifiers will prefer O₂ over NO₃⁻ as terminal electron acceptor (Bonin & Raymond 1990). Therefore, the N₂O production from denitrification is particularly high under close to anoxic conditions when the process rate of denitrification is still high and the N₂O yield is increased compared to completely anoxic conditions. Very high N₂O production rates were observed for AOB and denitrifiers in pure cultures, a nitrifying reactor system, and an artificially grown biofilm under rapidly changing oxygen conditions (Kester et al. 1997, Bergaust et al. 2008, Schreiber et al. 2009). The transient increase in N₂O production was due to unbalanced enzyme activity of AOB and denitrifiers in response to the shifts in oxygen concentration.

Increased substrate availability generally stimulates the rates of nitrification and denitrification according to Michaelis-Menten-kinetics (Barnard et al. 2005, Canfield et al. 2005). Furthermore, high concentrations of NO₃⁻ can increase the N₂O yield of denitrification, if NO₃⁻ is preferred as an electron acceptor over N₂O or even inhibits the N₂O-reductase (Blackmer & Bremner 1978, Firestone et al. 1979, Gaskell et al. 1981).

The rate and N₂O yield of denitrification are also highly dependent on the availability of electron donors. Increased availability of C_{org} stimulates the denitrification rates of heterotrophic bacteria (Stehfest & Bouwman 2006). Furthermore, the balance between the available electron donor and acceptor is important. A low C/NO₃⁻ ratio increases the N₂O yield, as C_{org} limits the final reduction step of denitrification (Knowles 1982, Tiedje 1988, Morley & Baggs 2010).

Other important environmental factors that affect N₂O production from nitrification and denitrification are concentrations of intermediates, pH, and temperature (Stein & Yung 2003, Stein 2011). Elevated concentration of NO₂⁻, for instance, increases N₂O production from AOB in microbial biofilms and from denitrification in an eutrophic estuary (Dong et al. 2002, Schreiber et al. 2009). With decreasing pH, N₂O production increases from both nitrification and denitrification, as was, for instance, shown in soils and riparian zones (van den Heuvel et al. 2011, Stehfest & Bouwman 2006, Richardson et al. 2009). Temperature is generally a key factor controlling the metabolic rate of microorganisms. The temperature response of nitrifiers and denitrifiers are bell-shaped with typically highest metabolic rates between 20 and 35°C for mesophilic species (Barnard et al. 2005 and references therein). In many environments, an increase in the rates of nitrification, denitrification, and N₂O emission has been observed with increasing temperature (Avrahami et al. 2002, Braker et al. 2010).

Environmental controlling factors directly affect the process rates and N₂O yields of nitrification and denitrification through the short-term response of the existing microbial communities. In addition, these factors also act as long-term environmental drivers and influence the abundance and composition of microbial communities (Wallenstein et al. 2006). Since different nitrifier and denitrifier species can vary in their response to environmental factors (e.g., different induction patterns of gene expression, enzyme kinetics, and O₂-dependence of N₂O formation), the composition of nitrifying and denitrifying communities have an impact on N₂O production rates (Zumft 1997, Cavigelli & Robertson 2000, Bange 2008). This impact is, however, difficult to resolve and molecular investigations are needed to shed light upon the relationship between microbial community structure and N₂O production rates in natural environments.

Nitrogen cycling and nitrous oxide production in aquatic environments

Nitrogen cycling in aquatic environments

The nitrogen turnover rates in shallow aquatic environments are particularly high compared to process rates in the open oceans or deep oceanic sediments. In shallow aquatic systems, particulate organic nitrogen is built up by both pelagic and benthic primary producers that assimilate NH_4^+ or NO_x^- , or fix N_2 (Figure 7). Benthic and pelagic processes in these shallow aquatic environments are tightly coupled due to their close proximity (MacIntyre et al. 1996). A large fraction of the PON from the water column can thus reach the sediment surface (Suess 1980, Ferron et al. 2009). In addition, freshwater and coastal ecosystems receive PON and especially DIN (mainly in the form of nitrate) from terrestrial ecosystems by runoff (Boyer et al. 2006, Seitzinger et al. 2006, Schlesinger 2009). Due to intensive use of fertilizers on agricultural land, the input of reactive nitrogen can be enormous, leading to very high nitrate concentrations in the water column of many freshwater and coastal ecosystems (van Beusekom et al. 2008, Schlesinger 2009). Hence, sediments in freshwater, estuaries, and continental shelf environments are characterized by high concentrations of organic and inorganic nutrients, which sustain a dense and diverse community of organisms (Beukema 1991, Herbert 1999). The benthic heterotrophic organisms play a key role in mineralizing PON in the sediment and supplying inorganic nutrients for the benthic as well as pelagic community (Herbert 1999, Nixon & Buckley 2002). Despite the high mineralization rates, NH_4^+ rarely occurs at high concentrations in oxic environments, as it is either readily re-assimilated into biomass, or oxidized to NO_3^- by nitrification (Canfield et al. 2005, Ward 2008).

Nitrification, a strictly aerobic process, only occurs in oxygenated water columns and in oxic surface layers of sediments (Figure 7). The rates of nitrification reported for the open ocean are in the range of a few to a few hundred $\text{nmol L}^{-1} \text{ day}^{-1}$, whereas the rates in sediments, intertidal biofilms, and the water column of estuaries are often in the range of μmol to mmol per m^2 or L and day due to higher numbers of nitrifiers and higher nutrient concentrations than in the oceans (Henriksen & Kemp 1988, de Wilde &

de Bie 2000, Magalhaes et al. 2005, Ward 2008). The depth to which nitrification occurs in sediments is constrained by the limits of downward O_2 diffusion, which is typically a few mm depending upon sediment type, organic matter content, benthic photosynthesis, and degree of mixing and bioturbation (Revsbech et al. 1980, Herbert 1999).

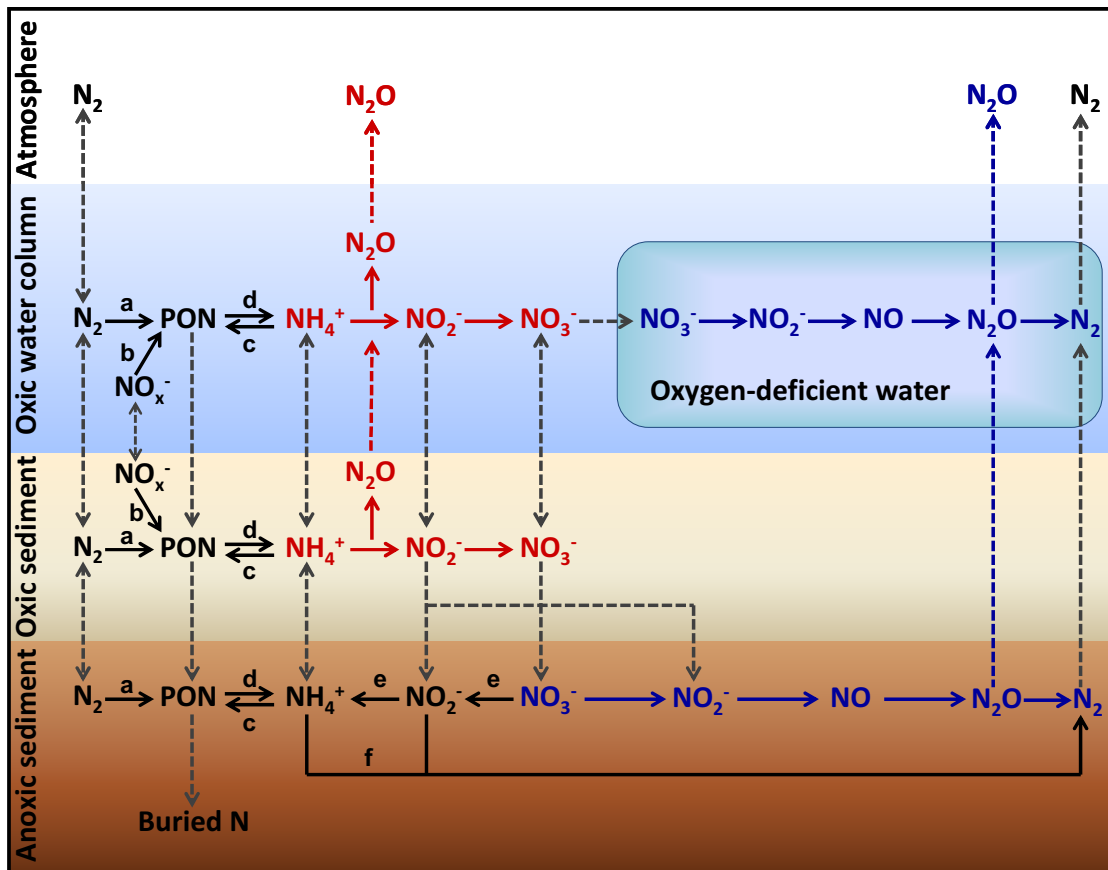

Figure 7: Nitrogen cycling in aquatic environments showing the major N transformations and the N_2O producing processes within the water column and the sediment. **Solid lines** indicate biological conversions of N compounds. **Dashed lines** indicate transport processes via diffusion or mixing by advection or bioturbation. **Red lines** represent N transformation and N_2O emission by nitrification. **Blue lines** represent N transformation and N_2O emission during denitrification. Nitrification prevails in the oxic water column and the upper oxic sediment layer, whereas denitrification prevails in oxygen-deficient water masses and deeper anoxic sediment layers. Other processes involved: (a) N_2 fixation, (b) assimilation of NO_3^- and NO_2^- , (c) NH_4^+ assimilation, (d) remineralization, (e) DNRA, (f) anammox. DNRA and anammox can also prevail in hypoxic waters, but have so far not been identified as significant N_2O source.

The dissimilatory reduction of nitrate can be fuelled by the supply of NO_3^- from nitrification or from the water column and requires transport of NO_3^- into anoxic zones or temporal separation of oxic production and anoxic consumption of NO_3^- (e.g., day-time NO_x^- production followed by night-time dissimilation) (Seitzinger et al. 2006). Denitrification, DNRA and anammox therefore prevail at high rates in environments with oxic-anoxic interfaces (in space or time), such as aquatic sediments or hypoxic zones in otherwise oxic water columns (Figure 7).

Denitrification is especially important in coastal areas, where it removes a large fraction of terrestrial DIN inputs as N_2 gas (Seitzinger & Kroeze 1998, Galloway et al. 2004, Seitzinger et al. 2006). The rates of denitrification in the sediment typically range from 0.1 to 10 $\text{mmol m}^{-2} \text{d}^{-1}$ (Joye & Anderson 2008). In sediments, the coupling of nitrification and denitrification can be very close and nitrification can supply up to 100% of the NO_3^- consumed by denitrification (Ward 2008). The water-column NO_3^- is especially an important driver for sedimentary denitrification in eutrophic environments where high NO_3^- concentrations in the water column support NO_3^- diffusion into the sediment (Joye & Anderson 2008). In oceanic oxygen minimum zones, denitrification rates are in the range of nanomolar per day (Lam & Kuypers 2011).

Nitrous oxide production in aquatic environments

Nitrification and denitrification are recognized as the primary N_2O -producing processes in aquatic environments (Ivens et al. 2011). Their relative importance for aquatic N_2O emissions is, however, still a matter of debate. This is mainly due to the facts that experimental studies on aquatic emissions of N_2O are scarce and quantification is complicated due to the complex network of N cycling processes, the close proximity of nitrification and denitrification activities in sediments, and the large spatial and temporal variability of N_2O emissions (Gruber 2008, Ivens et al. 2011). Sedimentary denitrification and water-column nitrification seem to be the major N_2O -producing processes in coastal areas (Bange 2006, 2008), while in the open oceans, the majority of N_2O emissions is attributed to water-column nitrification (Suntharalingam & Sarmiento 2000, Nevison et al. 2003, Bange 2008).

The N₂O yields from nitrification and denitrification in aquatic systems are usually lower than 1% (Seitzinger 1988, Bange 2008). High N₂O production rates therefore occur only in environments with high process rates of nitrification and denitrification. How much of the N₂O produced in aquatic environments is finally emitted to the atmosphere depends on the distance of the N₂O production site to the atmosphere and the prevailing hydrodynamics. Consequently, freshwater and coastal areas as sites of high N turnover in close proximity to the atmosphere have much higher areal N₂O emission rates than the open oceans (Seitzinger et al. 2000, 2006). Therefore, they significantly contribute to the global aquatic N₂O emission despite their relatively small surface area. Intense sites of N₂O production in the oceans are oxygen minimum zones (Codispoti et al. 2001). They make up less than 1 % of the ocean's volume, but they are estimated to account for 25–50% of the total oceanic N₂O emissions (Suntharalingam & Sarmiento 2000). Highest rates of N₂O emission occur in coastal upwelling regions and estuaries where N₂O production is stimulated due to very high nutrient concentrations and oxygen-deficient conditions close to the water surface (Codispoti 2010, Naqvi et al. 2010). Here, N₂O supersaturations of up to 8000% at the water-atmosphere interface result from the upwelling of subsurface water (Naqvi 2000, Bange 2006, Naqvi et al. 2010). It is assumed that periodic aeration due to turbulence in these shallow hypoxic to anoxic zones leads to “stop and go” denitrification. The frequent changes in oxygen concentration result in the accumulation of N₂O due to a more pronounced inhibition of the N₂O reductase by oxygen and/or due to a delayed expression of the N₂O reductase during the onset of denitrification (Naqvi et al. 2000, Codispoti et al. 2001).

The total volume of oxygen-deficient zones is expected to increase in the future due to increased eutrophication leading to higher productivity and consequently higher O₂ consumption during organic matter degradation (Diaz & Rosenberg 2008). Anthropogenic nutrient inputs thus indirectly increase N₂O emission from aquatic environments by stimulating the rate of nitrification and denitrification and by causing hypoxia in eutrophic regions and thereby extending the area of high N₂O production by denitrification.

Effects of benthic macrofauna on nitrogen cycling

Benthic macrofauna directly affect nitrogen cycling by ingesting PON and excreting ammonium and feces (Christensen et al. 2000, Michaud 2006). Moreover, they also indirectly influence biogeochemical nitrogen cycling by affecting the distribution, metabolism and composition of microbial communities in aquatic environments (Harris 1993, Papaspyrou et al. 2006, Bertics & Ziebis 2009). The impact of macrofauna on microbial nitrogen cycling is especially strong in aquatic sediments that are densely inhabited by diverse communities of epi- and infaunal invertebrates (Cadée 2001). These macrofaunal communities can significantly alter the physicochemical properties of the sediment through their bioturbation, bioirrigation, and feeding activities, and create a three-dimensional temporally and spatially dynamic mosaic of micro-environments (Aller & Aller 1998, Kristensen 2000).

Bioturbation and bioirrigation

Invertebrates living inside the sediment (infauna) redistribute large amounts of sediment and construct burrows and tubes deep into the sediment (bioturbation, Aller & Aller 1998). These structures enlarge the area of the sediment-water interface and extend the oxic-anoxic transition zone into otherwise anoxic sediment layers (Reise 2002). They thus increase the area for diffusive solute exchange between anoxic porewater and the overlying water, and are sites of intense microbial colonization and activity (Papaspyrou et al. 2006). Burrow-dwelling species further stimulate microbial metabolism by periodically flushing and ventilating their burrows with the overlying water (bioirrigation, Aller et al. 2001). Thereby, they introduce oxygenated water into deeper sediment layers and enhance particle and solute fluxes across the sediment-water interface. The resulting increased availability of oxygen, alternative electron acceptors, inorganic nutrients, and organic matter in deeper sediment layers supports aerobic metabolism, coupled redox reactions, and remineralization of fresh and aged PON (Henriksen et al. 1983, Mortimer et al. 1999, Kristensen & Mikkelsen 2003, Wenzhofer & Glud 2004).

The increased supply of O₂ due to burrow ventilation and of NH₄⁺ due to the animal's excretion and stimulated remineralization rates enhances nitrification in the burrow environment. Increased nitrification in turn enhances dissimilatory nitrate reduction in adjacent anoxic zones by the increased supply of nitrate (Pelegri & Blackburn 1994, Nielsen et al. 2004, Stief & de Beer 2006). The lining and walls of burrows are thus particularly favourable sites for coupled nitrification-denitrification. Furthermore, the burrow walls are usually enriched in organic matter originating from mucus secretion by the inhabitants and trapped detritus particles, and are characterized by fluctuating redox conditions due to the periodic irrigation of the burrows (Nielsen et al. 2004, Papaspyrou et al. 2006). Burrow walls therefore provide unique microenvironments that often promote higher abundance and activity of N-converting microorganisms than the oxic-anoxic interface in the ambient sediment.

The impact of benthic invertebrates on microbial activities and biogeochemical processes varies with species and depends on the animal's abundance, size, metabolic activity, feeding type, mode of sediment mixing, irrigation, and biogenic structure building (Mermillod-Blondin & Rosenberg 2006). Species that modify the physical environment and thereby regulate the availability of resources for other organisms are referred to as ecosystem engineers (Jones et al. 1994). One of the most important ecosystem engineers in temperate coastal marine sediments is the common ragworm *Hediste diversicolor*, formerly known as *Nereis diversicolor* (Figure 8, Kristensen 2001). This abundant polychaete strongly alters the physicochemical properties of intertidal sediments by its vigorous burrow ventilation, contributes to mechanical breakdown and mixing of PON as deposit feeder, and increases the input of organic matter to the sediment surface when filter feeding. These worms consequently affect the entire biological community in soft-bottom habitats and play an important role in enhancing organic matter decomposition and removal of bioavailable nitrogen through simultaneous stimulation of nitrification and denitrification (Kristensen & Mikkelsen 2003, Nielsen et al. 2004, Papaspyrou et al. 2006). In Chapter 6 of this thesis, it is shown that this polychaete also exerts a strong control on the pool of intracellular nitrate in intertidal sediments, and thus on the fate and availability of nitrogen in benthic systems.

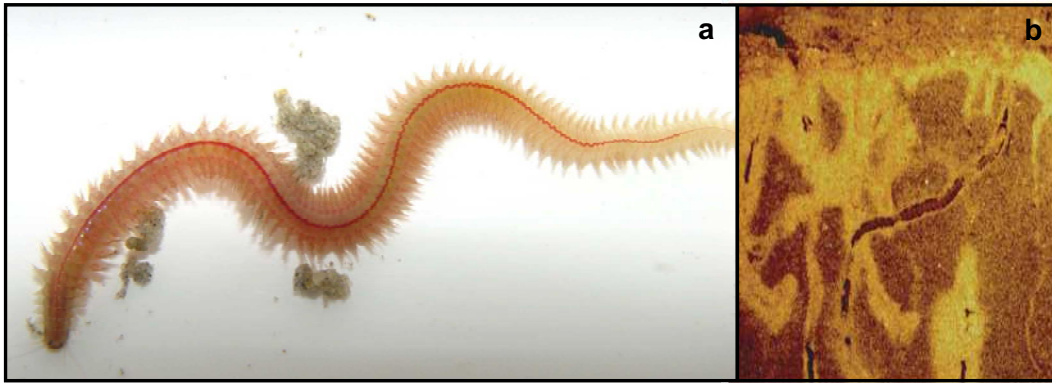

Figure 8: (a) The polychaete *Hediste diversicolor*, (b) cross section of sediment bioturbated by *H. diversicolor*. Light patches are oxidized sediment surrounding older burrows. Note that the worm in the centre inhabits a newly constructed burrow without noticeable oxidized sediment. Panel b was taken from Kristensen (2001).

Colonization of benthic invertebrates

The internal and external surfaces of benthic invertebrates can be colonized by microorganisms (Wahl 1989, Carman & Dobbs 1997, Welsh & Castadelli 2004). Especially the hard external surface of invertebrates that live on the sediment surface or on hard substrates (epifauna) can be covered by thick microbial biofilms. Among the dominant epifaunal species in coastal regions that provide such colonization surfaces is the blue mussel *Mytilus edulis* (Figure 9, Bouma et al. 2009). This common bivalve forms stable, permanent beds with individuals attached to each other by byssus threads. Its shell surface serves as habitat for a highly diverse epibiont community, including many microorganisms (Asmus 1987, Dittmann 1990). The mussel beds are highly enriched in nutrients due to the efficient filter-feeding and high ammonium excretion rate of the mussel (Prins et al. 1996, Smaal & Zurburg 1997).

Like *M. edulis*, many invertebrate species excrete high amounts of ammonium and thereby significantly contribute to the overall NH_4^+ production in sediments (Blackburn & Henriksen 1983, Dame & Dankers 1988, Smaal & Zurburg 1997). By supplying ammonium and providing a colonization surface, invertebrates represent a suitable habitat for nitrifying bacteria (Welsh & Castadelli 2004). Indeed, high potential nitrification rates were found for different epi- and infaunal invertebrate species (Welsh & Castadelli 2004). Increased nitrogen turnover seems thus not only to be linked to

microbial activity in the animal's burrows, but also to microbial activity on the surfaces of invertebrates. However, studies on nitrogen cycling in biofilms on external surfaces of invertebrates are scarce. This thesis therefore investigated for the first time the potential and mechanisms of microbial N₂O production in exoskeletal biofilms on aquatic invertebrates (Chapters 2 to 4).

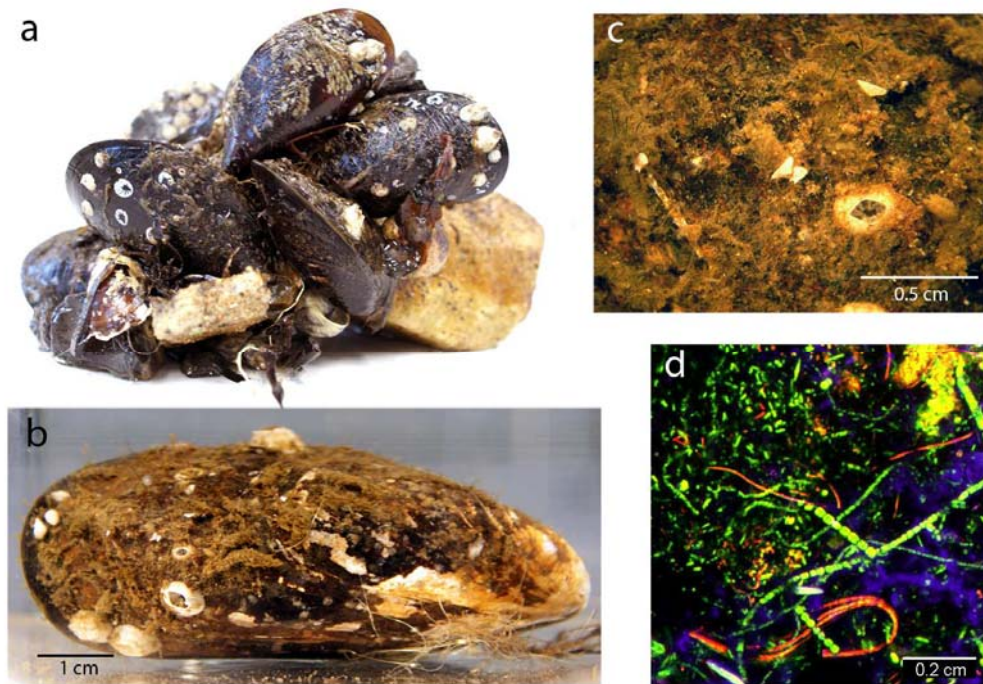

Figure 9: The Blue Mussel *Mytilus edulis*, (a) small part of the mussel colony in which individuals are attached to each other by byssus threads, (b) the shell surface of *M. edulis* is usually colonized by a diverse community of epibionts, (c) close-up on the biofilm community, (d) confocal laser scanning microscope picture of the microbial community in the shell biofilm of *M. edulis*, overlay of the top 400 μm of the biofilm (blue: DAPI staining, green: chlorophyll, red: phycocyanin).

Trophic interactions

Macrofauna also directly affect the biomass, activity and community composition of microbes by ingesting free-living or particle-attached microorganisms (Plante & Wilde 2004). Many invertebrates possess enzymes in their gut to lyse and digest at least part of the ingested bacteria and use them as a food source (McHenery & Birkbeck 1985, Plante & Shriver 1998). The ingestion of microbes by invertebrates is, however, often not a simple consumption of food. Different functional and phylogenetic groups of

microorganisms experience different fates during gut passage (Harris 1993). Depending on their ability to resist digestion and adapt to the prevailing conditions in the animal's gut, subgroups of ingested microbes might be lysed, survive, get metabolically activated or even grow during gut passage (Plante & Jumars 1992, Harris 1993). The gut microenvironment of invertebrates can be very distinct from the ambient environment from which the microbes were ingested. The gut of invertebrates can be anoxic or O₂-limited and enriched in nutrients (Horn et al 2003, Plante & Jumars 1992, Stief & Eller 2006). These guts provide suitable habitats for anaerobic microbes such as denitrifying bacteria that will remain or become metabolically active while passing the gut or even permanently colonize the gut (Drake & Horn 2007). The viable microbes can be of advantage for the host by producing exoenzymes that help digesting complex organic matter (Harris 1993). On the other hand, viable microbes in the gut can also be of disadvantage if they compete with the host for limiting nutrients (Harris 1993, Drake & Horn 2007). As a consequence of these different responses of ingested microbes to the specific conditions in the invertebrate gut, the gut passage leads to changes in the composition and activity of the microbial community compared to that found in the surrounding sediment (Harris 1993).

Nitrous oxide emission from macrofauna

Biogenic N₂O emission is classically linked to microbial activities in soils, sediments and water bodies. However, in addition to these sources, N₂O emission was also reported for earthworms and freshwater invertebrates (Karsten & Drake 1997, Stief et al. 2009). These animals host microorganisms that produce N₂O and are thus N₂O-emitters, but not N₂O-producers.

Nitrous oxide emission from earthworms

Different earthworm species were found to emit N₂O with an average rate of 1.5 nmol g⁻¹ (fresh weight) h⁻¹, and global N₂O emission from earthworms were estimated to be 0.19 Tg N yr⁻¹ compared to the total global emission of 17.7 Tg N yr⁻¹ (Drake et al. 2006, Drake & Horn 2007, Denman et al. 2007). The emission rates on a dry weight

basis can be far higher from earthworms than from bulk soils (Depkat-Jakob et al. 2010 and references therein) and earthworms can contribute up to 56% of the *in situ* N₂O emission from certain soils (Karsten & Drake 1997, Matthies et al. 1999, Borken et al. 2000). The N₂O emission by earthworms was found to be due to the activation of ingested denitrifiers by the specific *in situ* conditions in the gut (Drake & Horn 2006, Horn et al. 2006). In contrast to the ambient soil, the gut microenvironment is characterized by anoxia, high water content, high concentration of readily degradable C_{org}, and presence of NO₃⁻ and NO₂⁻ (Figure 10, Horn et al. 2003, Drake et al. 2006). The earthworm gut thus constitutes a unique microsite in aerated soils that provides ideal conditions for denitrifiers and other microorganisms capable of anaerobic growth (Drake & Horn 2007). Denitrification in the gut of earthworms results in the emission of about equal amounts of N₂O and N₂ (Drake & Horn 2007). It has been suggested that this very high N₂O yield is due to a delay in the synthesis of N₂O reductase or high concentrations of NO₂⁻ (Horn et al. 2003, Ihssen et al. 2003). Although soil-derived denitrifiers are recognized as the main N₂O-producing microbes in the earthworm gut, non-denitrifying dissimilatory NO₃⁻ reducers might indirectly contribute to N₂O production by providing high concentrations of NO₂⁻, which has been shown to stimulate N₂O production more effectively than NO₃⁻ (Matthies et al. 1999, Ihssen et al. 2003, Drake & Horn 2007).

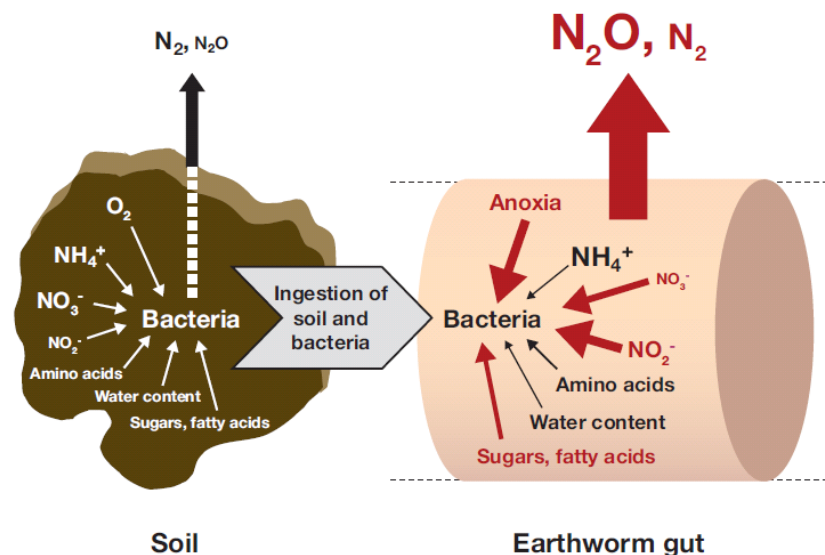

Figure 10: Hypothetical model illustrating which factors stimulate the production of N₂O and N₂ by bacteria ingested into the earthworm gut. The relative concentrations of compounds are reflected in the font size, and the relative effect of each compound on the production of N₂O and N₂ in the gut is indicated by the thickness of the arrows. The main factors that appear to stimulate ingested denitrifiers in the gut are in red. Taken from Drake & Horn (2007) who modified the scheme after Horn et al. (2003) and Drake et al. (2006).

Nitrous oxide emission from freshwater invertebrates

Similar to earthworms, diverse freshwater invertebrate species were found to emit N_2O with emission rates ranging from 0 to $93.1 \text{ nmol g}^{-1} (\text{dry weight}) \text{ h}^{-1}$ (Stief et al. 2009). N_2O emission was, like for earthworms, ascribed to the denitrification activity of ingested bacteria in the anoxic animal gut. The N_2O emission rates of freshwater invertebrates largely depend on the amount of ingested bacteria, which is influenced by the animal's diet. Filter feeders and deposit feeders that prefer a bacteria-rich detritus diet show the highest rates, shredders and grazers intermediate, and predators ingesting a bacteria-poor carnivorous diet very low N_2O emission rates (Stief et al. 2009, Stief & Schramm 2010). Like in earthworms, the N_2O yield of denitrification in the guts of two abundant filter- and deposit-feeding insect larvae were exceptionally high, ranging from 15 to 68% of the N gas flux (Stief et al. 2009). Since aquatic filter- and deposit-feeders typically ingest particle-attached or free-living bacteria from the oxic water column or oxic surface sediment layer, bacteria probably experience an oxic-anoxic shift when being ingested into the anoxic animal gut. It is hypothesized that this shift activates ingested facultative denitrifiers and that during the onset of denitrification the induction of the N_2O reductase is delayed, leading to the accumulation and emission of N_2O from the animal gut (Figure 11, Stief et al. 2009).

In addition to direct stimulation of N_2O production in the animal gut, burrowing invertebrates were shown to enhance N_2O and N_2 emission from the surrounding sediments (Figure 11, Svensson 1998, Stief et al. 2009, Stief & Schramm 2010). This indirect stimulation of N_2O emission is probably due to the animal's bioirrigation activity causing periodic changes between oxic and anoxic conditions in the burrows and increased nutrient supply, thus enhancing the rates of N transformation and N_2O production. The excretion of fecal pellets that contain active denitrifiers might further enhance the capacity of the sediment to produce N_2O . Invertebrates that do not emit N_2O themselves may thus indirectly contribute to the stimulation of N_2O emission from sediments by their bioirrigation activities (Stief & Schramm 2010). On the other hand, N_2O emitted by infaunal species might be partially consumed by denitrification in the surrounding sediment. For infaunal invertebrates, the sediment might thus act as an additional source or sink of N_2O (Stief et al. 2009, Stief & Schramm 2010).

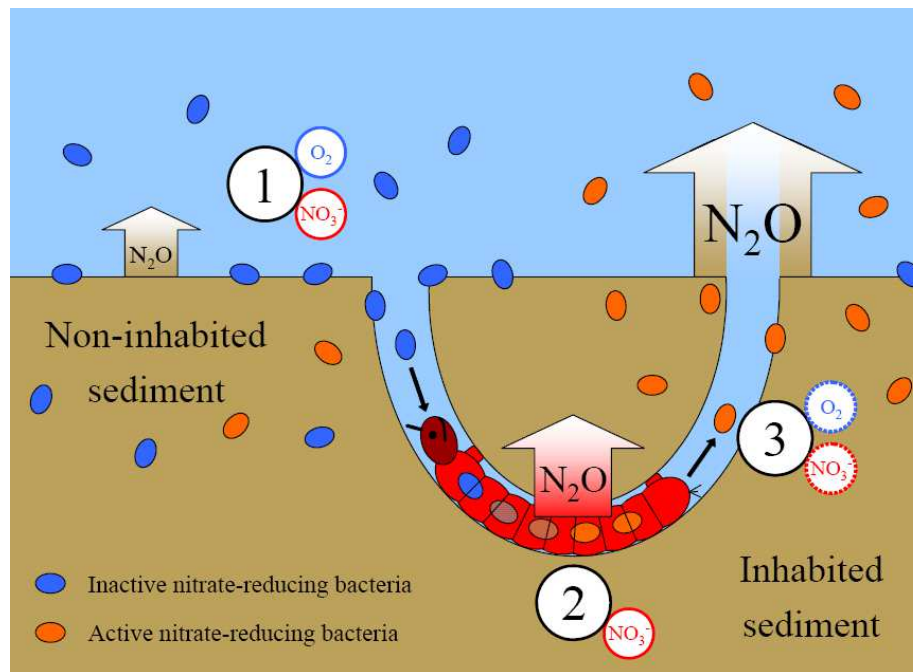

Figure 11: Conceptual model of the activation of ingested denitrifying bacteria in the gut of aquatic invertebrates and the resulting enhancement of N₂O emission from sediment. (1) Bacteria in the water column or in the surface sediment are exposed to oxic conditions and therefore do not exhibit NO₃⁻ reduction activity (blue ovals). (2) Invertebrates that feed on organic particles to which bacteria are attached transfer the bacteria to anoxic conditions in their guts. Anoxia and the presence of NO₃⁻ lead to the activation of ingested denitrifying bacteria in the gut of the invertebrate (orange ovals) that reduce NO₃⁻ to N₂O and N₂. The produced N₂O diffuses through the gut wall of the invertebrates into the surrounding sediment or is pumped out of the tube by ventilation activity of the invertebrate. (3) Animal burrows in which O₂ and NO₃⁻ concentrations fluctuate (stippled circles) are inoculated with actively NO₃⁻-reducing bacteria. As a consequence, NO₃⁻ reduction and concomitant N₂O production in animal guts and in animal-influenced sediment are higher than in non-inhabited sediment. Kindly provided by P. Stief.

Important environmental factors that influence N₂O emission from freshwater invertebrates are the ambient NO₃⁻ concentration and the temperature (Stief et al. 2010, Stief & Schramm 2010). However, one of the factors must exceed a certain threshold value before the other factor can stimulate N₂O emission. For instance, N₂O emission rate of the insect larvae *Chironomus plumosus* is only increased by temperature when the NO₃⁻ concentration exceeds 25–50 μmol L⁻¹, and by NO₃⁻ when the temperature is above 4–10°C (Stief et al 2010). Accordingly, rates of N₂O emission from this insect larvae vary seasonally depending on the prevailing temperature and NO₃⁻ concentration like it is known for denitrification rates in sediments (Jørgensen & Sorensen 1985, Jørgensen & Sorensen 1988). In temperate freshwater and coastal waters, NO₃⁻

availability and temperature are mostly antagonistic during the year with highest NO_3^- concentrations in winter and lowest concentrations in summer. Highest rates of sedimentary denitrification and N_2O emission are therefore observed in spring and autumn when moderate NO_3^- concentrations coincide with moderate temperatures. N_2O emission rates of freshwater invertebrates appear to undergo the same seasonal changes as typically found in aquatic sediments unless other factors (e.g., larval development or type and rate of feeding) limit N_2O production in the gut of the animal (Stief & Schramm 2010).

Nitrous oxide emission from other organisms

Besides benthic macrofauna, a variety of other organisms were shown to emit N_2O . High amounts of N_2O are produced by cattle production. However, the majority of this N_2O derives from microbial processes in the animal waste (Oenema et al. 2005). The bovine digestive track may be only a very small source of N_2O , since here dissimilatory nitrate reduction to ammonium takes place which might produce trace amounts of N_2O that could escape to the atmosphere during rumination (Kaspar & Tiedje 1981). In a contributed work, it is shown that N_2O is produced in the human oral cavity via denitrifying bacteria in the dental plaque. The average rate of oral N_2O emission was 80 nmol h^{-1} per individual. Extrapolated to the world population, humans produce about $0.00013 \text{ Tg N yr}^{-1}$, which represents a rather insignificant amount of the global annual N_2O emissions. In contrast, the N_2O emission by plants might be of global importance despite their relatively low N_2O emission rates because of their huge biomass (Smart & Bloom 2001). The ability to produce N_2O seems to be widespread among different plant species (Smart & Bloom 2001, Hakata et al. 2003). Very recently, also two different soil-feeding termite species were shown to emit N_2O (Ngugi & Brune 2012). The N_2O and N_2 emission rates per gram fresh weight are in the same range as those reported for earthworms, and their production was associated with the nutrient-rich gut of the animals. Denitrification mainly takes place in the posterior hindgut, while dissimilatory reduction of NO_3^- to NH_4^+ occurs throughout the gut at far higher rates than denitrification. It is hypothesized that both denitrification and DNRA might be involved in N_2O emission from termites, since N_2O is not only produced in the posterior hindgut, but also in other sections of the termite gut (Ngugi & Brune 2012).

The list of microbial processes that produce N_2O and of organisms that act as N_2O emitters is long. However, marine invertebrates, which densely colonize marine sediments, have not been investigated so far.

Aims of the thesis

This thesis aimed at improving our knowledge about invertebrate-microbe interactions and their role in biogeochemical nitrogen cycling and the production of the greenhouse gas N₂O in aquatic environments.

As outlined in the previous sections, macrofauna strongly interact with microbes and thereby influence biogeochemical nitrogen cycling, leading to increased rates of nitrification and denitrification, and concomitant production and emission of N₂O to the atmosphere. Terrestrial and freshwater invertebrates were reported to be emitters of this important greenhouse gas. N₂O emission by marine invertebrates, however, has not been studied so far. The major focus of this thesis was therefore to unravel the potential and the underlying mechanisms of microbial N₂O production associated with marine invertebrates. According to previous studies on terrestrial and freshwater macrofauna, coastal benthic invertebrates were assumed to be suitable candidates for high N₂O emission potentials, since they inhabit nitrate- and organic-carbon-rich environments and comprise many filter- and deposit-feeding species. Therefore, in two studies of this thesis, macrofauna was collected from two coastal field sites that are representative for many tidal and subtidal habitats in temperate regions: an intertidal flat in the German Wadden Sea and the shallow Aarhus Bay in Denmark. Further studies included in this thesis investigated the potential and mechanisms of N₂O emission from a highly abundant freshwater species, the Zebra Mussel *Dreissena polymorpha*, and an important aquaculture species, the Pacific White Shrimp *Litopenaeus vannamei*, which is typically reared under highly nutrient-enriched conditions and therefore was assumed to be a strong N₂O-emitter.

The main research questions of this thesis were:

- Do marine invertebrates emit N₂O?
- Is the ability to emit N₂O restricted to a certain taxonomic group or is it a widespread trait among marine invertebrates?
- Which environmental factors and species characteristics influence the rates of N₂O emission?

- Does the N₂O emission potential depend on the feeding guild like in freshwater invertebrates?
- At which site(s) is the N₂O produced in the animal body? Is it only produced in the gut or are there other N₂O-producing animal compartments? If yes, how important are they?
- Which microbial N-cycling processes are involved in N₂O production and how much do they contribute to the total N₂O emission?
- How does the gut microenvironment affect the composition and activity of ingested microorganisms?

These research questions were addressed by a combination of (i) incubation and stable isotope experiments with subsequent measurements of N₂O emission rates by gas chromatography or mass spectrometry, (ii) investigations of the animal-associated microbial community by molecular analysis, and (iii) analysis of the driving environmental factors by microsensor measurements and statistical analysis.

An additional study investigated the origin and ecological controls of a large sedimentary pool of intracellular nitrate that was discovered at the sampling site in the Wadden Sea. Since the sediment was densely colonized by the polychaete *Hediste diversicolor*, it was hypothesized that the worm stimulates the formation of intracellular nitrate by interacting with nitrifying bacteria and nitrate-storing diatoms through its bioturbation activities. This hypothesis was investigated in a long-term microcosm experiment.

Overview of manuscripts

Chapter 2:

Nitrous oxide production associated with coastal marine invertebrates

Ines M. Heisterkamp, Andreas Schramm, Dirk de Beer, Peter Stief

The study was initiated by P. Stief and A. Schramm. The concept and design of the study was developed by P. Stief, I.M. Heisterkamp, and A. Schramm. I.M. Heisterkamp performed sampling, rate measurements, and statistical analysis with help of P. Stief. The manuscript was written by I.M. Heisterkamp with editorial help and input from the co-authors.

The manuscript is published as Feature Article in *Marine Ecology Progress Series* 415: 1-9, 2010

Chapter 3:

Shell biofilm-associated nitrous oxide production in marine molluscs: processes, precursors and relative importance

Ines M. Heisterkamp, Andreas Schramm, Lone H. Larsen, Nanna B. Svenningsen, Gaute Lavik, Dirk de Beer, Peter Stief

The concept and experimental design of the study were developed by I.M. Heisterkamp, P. Stief, and A. Schramm. The design of the stable isotope experiments was conceived by P. Stief together with G. Lavik. I.M. Heisterkamp carried out the sampling and the laboratory work including short-term and long-term incubation experiments, stable isotope experiments, rate measurements with gas chromatography and mass spectrometry, microsensor measurements, analysis of nutrients, protein contents and ammonium excretion. L.H. Larsen and N.B. Svenningsen contributed to measurements of the N₂O emission rates and ammonium excretion rates and P. Stief to the stable isotope experiments. Analysis and evaluation of the data was done by I.M. Heisterkamp. G. Lavik helped with evaluating the mass spectrometry data. I.M. Heisterkamp

conceived and wrote the manuscript with input from P. Stief, A. Schramm, G. Lavik, and D. de Beer.

The manuscript is accepted in *Environmental Microbiology*

Chapter 4:

Shell biofilm nitrification and gut denitrification contribute to emission of nitrous oxide by the invasive freshwater mussel *Dreissena polymorpha* (Zebra Mussel)

Nanna B. Svenningsen, Ines M. Heisterkamp, Maria Sigby-Clausen, Lone H. Larsen, Lars Peter Nielsen, Peter Stief, Andreas Schramm

I.M. Heisterkamp contributed to the development of the concept and experimental design and helped with rate measurements.

The manuscript is published in *Applied and Environmental Microbiology* 78(12):4505-4509, 2012

Chapter 5:

Incomplete denitrification in the gut of the aquacultured shrimp *Litopenaeus vannamei* as source of nitrous oxide

Ines M. Heisterkamp, Andreas Schramm, Dirk de Beer, Peter Stief

The study was conceived by I.M. Heisterkamp, P. Stief, and A. Schramm. All experiments, rate measurements, and microsensor measurements were conducted by I.M. Heisterkamp. The preliminary manuscript was written by I.M. Heisterkamp with editorial help of P. Stief.

Chapter 5 presents the preliminary data on microbial N₂O production associated with the aquacultured shrimp *Litopenaeus vannamei*. Molecular analysis of the abundance

and expression of denitrification genes in different sections of the gut and in the water of the aquaculture farm is still in progress.

Chapter 6:

Indirect control of the intracellular nitrate pool of intertidal sediment by the polychaete *Hediste diversicolor*

Ines M. Heisterkamp, Anja Kamp, Angela T. Schramm, Dirk de Beer, Peter Stief

The concept and experimental design of the study were developed by P. Stief, I.M. Heisterkamp, and A. Kamp. I.M. Heisterkamp was responsible for sampling of animals and sediment, the set-up and implementation of the experiment, and nutrient analysis. A. Kamp analyzed the intracellular nitrate and A.T. Schramm the photopigments. Microsensor measurements, depth-integration of data and statistical analysis was done by P. Stief. I.M. Heisterkamp wrote the manuscript mainly in collaboration with P. Stief and input from A. Kamp and D. de Beer.

This manuscript is published in *Marine Ecology Progress Series* 445:181-192, 2012

References

- Aller RC, Aller JY (1998) The effect of biogenic irrigation intensity and solute exchange on diagenetic reaction rates in marine sediments. *Journal of Marine Research* 56:905-936
- Aller RC, Aller JY, Kemp PF (2001) Effects of particle and solute transport on rates and extent of remineralization in bioturbated sediments. In: *Organism-Sediment Interactions*, p 315-333
- Arp DJ, Sayavedra-Soto LA, Hommes NG (2002) Molecular biology and biochemistry of ammonia oxidation by *Nitrosomonas europaea*. *Archives of Microbiology* 178:250-255
- Arp DJ, Stein LY (2003) Metabolism of inorganic N compounds by ammonia-oxidizing bacteria. *Critical Reviews in Biochemistry and Molecular Biology* 38:471-495
- Asmus H (1987) Secondary production of an intertidal mussel bed community related to its storage and turnover compartments. *Marine Ecology-Progress Series* 39:251-266
- Avrahami S, Conrad R, Braker G (2002) Effect of soil ammonium concentration on N₂O release and on the community structure of ammonia oxidizers and denitrifiers. *Applied and Environmental Microbiology* 68:5685-5692
- Baggs EM (2011) Soil microbial sources of nitrous oxide: recent advances in knowledge, emerging challenges and future direction. *Current Opinion in Environmental Sustainability* 3:321-327
- Bange HW (2006) Nitrous oxide and methane in European coastal waters. *Estuarine Coastal and Shelf Science* 70:361-374
- Bange HW (2008) Gaseous nitrogen compounds (NO, N₂, NH₃) in the ocean. In: Douglas G Capone, Deborah A Bronk, Margaret R Mulholland and Edward J Carpenter (eds) *Nitrogen in the marine environment*. Elsevier Inc., pp 51-94
- Bange HW, Rapsomanikisa, S., Andreae, M.O. (1996) Nitrous oxide in coastal waters. *Global Biogeochemical Cycles* 10:197-207
- Barnard R, Leadley PW, Hungate BA (2005) Global change, nitrification, and denitrification: A review. *Global Biogeochemical Cycles* 19
- Baulch HM, Schiff SL, Maranger R, Dillon PJ (2011) Nitrogen enrichment and the emission of nitrous oxide from streams. *Global Biogeochemical Cycles* 25
- Beaulieu JJ, Shuster WD, Rebholz JA (2010) Nitrous Oxide Emissions from a Large, Impounded River: The Ohio River. *Environmental Science & Technology* 44:7527-7533
- Beaumont HJE, Lens SI, Reijnders WNM, Westerhoff HV, van Spanning RJM (2004) Expression of nitrite reductase in *Nitrosomonas europaea* involves NsrR, a novel nitrite-sensitive transcription repressor. *Molecular Microbiology* 54:148-158
- Bergaust L, Shapleigh J, Frostegard A, Bakken L (2008) Transcription and activities of NO_x reductases in *Agrobacterium tumefaciens*: the influence of nitrate, nitrite and oxygen availability. *Environmental Microbiology* 10:3070-3081
- Bertics VJ, Ziebis W (2009) Biodiversity of benthic microbial communities in bioturbated coastal sediments is controlled by geochemical microniches. *Isme Journal* 3:1269-1285
- Betlach MR, Tiedje JM (1981) Kinetic explanation for accumulation of nitrite, nitric oxide, and nitrous oxide during bacterial denitrification. *Applied and Environmental Microbiology* 42:1074-1084
- Beukema JJ (1991) Changes in composition of bottom fauna of a tidal flat area during a period of eutrophication *Marine Biology* 111:293-301

- Billings SA (2008) Biogeochemistry, Nitrous oxide in flux. *Nature* 456:888-889
- Blackburn TH, Henriksen K (1983) Nitrogen cycling in different types of sediments from danish waters. *Limnology and Oceanography* 28:477-493
- Blackmer AM, Bremner JM (1978) Inhibitory effect of nitrate on reduction of N₂O to N₂ by soil microorganisms *Soil Biology & Biochemistry* 10:187-191
- Bock E, Schmidt I, Stüven R, Zart D (1995) Nitrogen loss caused by denitrifying *Nitrosomonas* cells using ammonium or hydrogen as electron donors and nitrite as electron acceptor *Archives of Microbiology* 163:16-20
- Bonin P, Raymond N (1990) Effects of Oxygen on Denitrification in Marine-Sediments. *Hydrobiologia* 207:115-122
- Borken W, Grundel S, Beese F (2000) Potential contribution of *Lumbricus terrestris* L. to carbon dioxide, methane and nitrous oxide fluxes from a forest soil. *Biology and Fertility of Soils* 32:142-148
- Bouma TJ, Olenin S, Reise K, Ysebaert T (2009) Ecosystem engineering and biodiversity in coastal sediments: posing hypotheses. *Helgoland Marine Research* 63:95-106
- Bouwman AF, Boumans LJM, Batjes NH (2002) Emissions of N₂O and NO from fertilized fields: Summary of available measurement data. *Global Biogeochemical Cycles* 16
- Boyer EW, Howarth RW, Galloway JN, Dentener FJ, Green PA, Vorosmarty CJ (2006) Riverine nitrogen export from the continents to the coasts. *Global Biogeochemical Cycles* 20
- Bradley PB, Sanderson MP, Frischer ME, Brofft J, Booth MG, Kerkhof LJ, Bronk DA (2010) Inorganic and organic nitrogen uptake by phytoplankton and heterotrophic bacteria in the stratified Mid-Atlantic Bight. *Estuarine Coastal and Shelf Science* 88:429-441
- Braker G, Schwarz J, Conrad R (2010) Influence of temperature on the composition and activity of denitrifying soil communities. *Fems Microbiology Ecology* 73:134-148
- Butterbach-Bahl K, Dannenmann M (2011) Denitrification and associated soil N₂O emissions due to agricultural activities in a changing climate. *Current Opinion in Environmental Sustainability* 3:389-395
- Cabello P, Roldan MD, Moreno-Vivian C (2004) Nitrate reduction and the nitrogen cycle in archaea. *Microbiology-Sgm* 150:3527-3546
- Cadée GC (2001) Sediment dynamics by bioturbating organisms. In: Reise K (ed) *Ecological comparisons of sedimentary shores*. Springer, pp 127–236
- Campbell MA, Nyerges G, Kozłowski JA, Poret-Peterson AT, Stein LY, Klotz MG (2011) Model of the molecular basis for hydroxylamine oxidation and nitrous oxide production in methanotrophic bacteria. *Fems Microbiology Letters* 322:82-89
- Canfield DE, Glazer AN, Falkowski PG (2010) The Evolution and Future of Earth's Nitrogen Cycle. *Science* 330:192-196
- Canfield DE, Kristensen E, Thamdrup B (2005) *Aquatic Geomicrobiology*, Elsevier Academic Press
- Cantera JLL, Stein LY (2007) Molecular diversity of nitrite reductase genes (*nirK*) in nitrifying bacteria. *Environmental Microbiology* 9:765-776
- Carman KR, Dobbs FC (1997) Epibiotic microorganisms on copepods and other marine crustaceans. *Microscopy Research and Technique* 37:116-135
- Carpenter EJ, Capone DG (2008) Nitrogen fixation in the marine environment. In: Douglas G Capone, Deborah A Bronk, Margaret R Mulholland and Edward J

- Carpenter (eds) *Nitrogen in the marine environment*. Elsevier Academic Press, pp 141-198
- Casciotti KL, Ward BB (2001) Dissimilatory nitrite reductase genes from autotrophic ammonia-oxidizing bacteria. *Applied and Environmental Microbiology* 67:2213-2221
- Cavigelli MA, Robertson GP (2000) The functional significance of denitrifier community composition in a terrestrial ecosystem. *Ecology* 81:1402-1414
- Chapuis-Lardy L, Wrage N, Metay A, Chotte JL, Bernoux M (2007) Soils, a sink for N₂O? A review. *Global Change Biology* 13:1-17
- Christensen B, Vedel A, Kristensen E (2000) Carbon and nitrogen fluxes in sediment inhabited by suspension-feeding (*Nereis diversicolor*) and non-suspension-feeding (*N. virens*) polychaetes. *Marine Ecology-Progress Series* 192:203-217
- Codispoti LA (2010) Interesting Times for Marine N₂O. *Science* 327:1339-1340
- Codispoti LA, Brandes JA, Christensen JP, Devol AH, Naqvi SWA, Paerl HW, Yoshinari T (2001) The oceanic fixed nitrogen and nitrous oxide budgets: Moving targets as we enter the anthropocene? *Scientia Marina* 65:85-105
- Crutzen PJ (1970) Influence of nitrogen oxides on atmospheric ozone content. *Quarterly Journal of the Royal Meteorological Society* 96:320-&
- Crutzen PJ, Mosier AR, Smith KA, Winiwarter W (2008) N₂O release from agro-biofuel production negates global warming reduction by replacing fossil fuels. *Atmospheric Chemistry and Physics* 8:389-395
- Cruz-Garcia C, Murray AE, Klappenbach JA, Stewart V, Tiedje JM (2007) Respiratory nitrate ammonification by *Shewanella oneidensis* MR-1. *Journal of Bacteriology* 189:656-662
- Dame RF, Dankers N (1988) Uptake and release of materials by a Wadden Sea mussel bed. *Journal of Experimental Marine Biology and Ecology* 118:207-216
- Davidson EA (2009) The contribution of manure and fertilizer nitrogen to atmospheric nitrous oxide since 1860. *Nature Geoscience* 2:659-662
- de Wilde HPJ, de Bie MJM (2000) Nitrous oxide in the Schelde estuary: production by nitrification and emission to the atmosphere. *Marine Chemistry* 69:203-216
- Denman KL, Brasseur G, Chidthaisong A, Ciais P, Cox PM, Dickinson RE, Hauglustaine D, Heinze C, Holland E, Jacob D, Lohmann U, Ramachandran S, da Silva Dias PL, Wofsy SC, and Zhang X (2007): Couplings Between Changes in the Climate System and Biogeochemistry. In: *Climate Change 2007: The Physical Science Basis. Contribution of Working Group I to the Fourth Assessment Report of the Intergovernmental Panel on Climate Change* [Solomon S, Qin D, Manning M, Chen Z, Marquis M, Averyt KB, Tignor M, and Miller HL (eds.)]. Cambridge University Press, Cambridge, United Kingdom and New York, NY, USA
- Depkat-Jakob PS, Hilgarth M, Horn MA, Drake HL (2010) Effect of Earthworm Feeding Guilds on Ingested Dissimilatory Nitrate Reducers and Denitrifiers in the Alimentary Canal of the Earthworm. *Applied and Environmental Microbiology* 76:6205-6214
- Devol AH (2008) Denitrification including anammox. In: Douglas G Capone, Deborah A Bronk, Margaret R Mulholland and Edward J Carpenter (eds) *Nitrogen in the marine environment*. Elsevier Academic Press, pp 263-301
- Diaz RJ, Rosenberg R (2008) Spreading dead zones and consequences for marine ecosystems. *Science* 321:926-929
- Dittmann S (1990) Mussel beds – amensalism or amelioration for intertidal fauna. *Helgolander Meeresuntersuchungen* 44:335-352

- Dong LF, Nedwell DB, Underwood GJC, Thornton DCO, Rusmana I (2002) Nitrous oxide formation in the Colne estuary, England: The central role of nitrite. *Applied and Environmental Microbiology* 68:1240-1249
- Drake HL, Horn MA (2006) Earthworms as a transient heaven for terrestrial denitrifying microbes: A review. *Engineering in Life Sciences* 6:261-265
- Drake HL, Horn MA (2007) As the worm turns: The earthworm gut as a transient habitat for soil microbial biomes. *Annual Review of Microbiology* 61:169-189
- Drake HL, Schramm A, Horn MA (2006) Earthworm gut microbial biomes: their importance to soil microorganisms, denitrification, and the terrestrial production of the greenhouse gas N₂O. In: König H, Varma A (eds) *Soil biology, Vol 6. Intestinal microorganisms of soil invertebrates*. Springer-Verlag, Heidelberg, pp 65-87
- Duce RA, LaRoche J, Altieri K, Arrigo KR, Baker AR, Capone DG, Cornell S, Dentener F, Galloway J, Ganeshram RS, Geider RJ, Jickells T, Kuypers MM, Langlois R, Liss PS, Liu SM, Middelburg JJ, Moore CM, Nickovic S, Oschlies A, Pedersen T, Prospero J, Schlitzer R, Seitzinger S, Sorensen LL, Uematsu M, Ulloa O, Voss M, Ward B, Zamora L (2008) Impacts of atmospheric anthropogenic nitrogen on the open ocean. *Science* 320:893-897
- Falkowski PG (1997) Evolution of the nitrogen cycle and its influence on the biological sequestration of CO₂ in the ocean. *Nature* 387:272-275
- Falkowski PG, Barber RT, Smetacek V (1998) Biogeochemical controls and feedbacks on ocean primary production. *Science* 281:200-206
- Ferguson SJ (1994) Denitrification and its control. *Antonie Van Leeuwenhoek International Journal of General and Molecular Microbiology* 66:89-110
- Ferguson SJ, Richardson DJ, Spanning RJM (2007) Biochemistry and molecular biology of nitrification. In: Bothe H, Ferguson SJ, Newton WE (eds) *Biology of the Nitrogen Cycle*. Elsevier, pp 209-223
- Ferron S, Alonso-Perez F, Anfuso E, Murillo FJ, Ortega T, Castro CG, Forja JM (2009) Benthic nutrient recycling on the northeastern shelf of the Gulf of Cadiz (SW Iberian Peninsula). *Marine Ecology-Progress Series* 390:79-95
- Firestone MK, Smith MS, Firestone RB, Tiedje JM (1979) Influence of nitrate, nitrite, and oxygen on the composition of the gaseous products of denitrification in soil. *Soil Science Society of America Journal* 43:1140-1144
- Forster P, Ramaswamy V, Artaxo P, Bernsten T, Betts T, Fahey DW, Haywood J, Lean J, Lowe DC, Myhre G, Nganga J, Prinn R, Raga G, Schulz M, and Van Dorland R (2007): Changes in Atmospheric Constituents and in Radiative Forcing. In: *Climate Change 2007: The Physical Science Basis. Contribution of Working Group I to the Fourth Assessment Report of the Intergovernmental Panel on Climate Change* [Solomon S, Qin D, Manning M, Chen Z, Marquis M, Averyt KB, Tignor M, and Miller HL (eds.)]. Cambridge University Press, Cambridge, United Kingdom and New York, NY, USA
- Francis CA, Roberts KJ, Beman JM, Santoro AE, Oakley BB (2005) Ubiquity and diversity of ammonia-oxidizing archaea in water columns and sediments of the ocean. *Proceedings of the National Academy of Sciences of the United States of America* 102:14683-14688
- Freitag A, Bock E (1990) Energy conservation in *Nitrobacter*. *Fems Microbiology Letters* 66:157-162
- Frette L, Gejlsbjerg B, Westermann P (1997) Aerobic denitrifiers isolated from an alternating activated sludge system. *Fems Microbiology Ecology* 24:363-370

- Galloway JN, Cowling EB (2002) Reactive nitrogen and the world: 200 years of change. *Ambio* 31:64-71
- Galloway JN, Dentener FJ, Capone DG, Boyer EW, Howarth RW, Seitzinger SP, Asner GP, Cleveland CC, Green PA, Holland EA, Karl DM, Michaels AF, Porter JH, Townsend AR, Vorosmarty CJ (2004) Nitrogen cycles: past, present, and future. *Biogeochemistry* 70:153-226
- Galloway JN, Townsend AR, Erisman JW, Bekunda M, Cai ZC, Freney JR, Martinelli LA, Seitzinger SP, Sutton MA (2008) Transformation of the nitrogen cycle: Recent trends, questions, and potential solutions. *Science* 320:889-892
- Gao H, Schreiber F, Collins G, Jensen MM, Kostka JE, Lavik G, de Beer D, Zhou HY, Kuypers MMM (2010) Aerobic denitrification in permeable Wadden Sea sediments. *Isme Journal* 4:417-426
- Gardner AM, Gessner CR, Gardner PR (2003) Regulation of the nitric oxide reduction operon (*norRVW*) in *Escherichia coli* - Role of *norR* and *sigma(54)* in the nitric oxide stress response. *Journal of Biological Chemistry* 278:10081-10086
- Gaskell JF, Blackmer AM, Bremner JM (1981) Comparison of effects of nitrate, nitrite, and nitric oxide on reduction of nitrous oxide to dinitrogen by soil microorganisms *Soil Science Society of America Journal* 45:1124-1127
- Gonzalez PJ, Correia C, Moura I, Brondino CD, Moura JJG (2006) Bacterial nitrate reductases: Molecular and biological aspects of nitrate reduction. *Journal of Inorganic Biochemistry* 100:1015-1023
- Goreau TJ, Kaplan WA, Wofsy SC, McElroy MB, Valois FW, Watson SW (1980) Production of NO_2^- and N_2O by Nitrifying Bacteria at Reduced Concentrations of Oxygen. *Applied and Environmental Microbiology* 40:526-532
- Gregory LG, Bond PL, Richardson DJ, Spiro S (2003) Characterization of a nitrate-respiring bacterial community using the nitrate reductase gene (*narG*) as a functional marker. *Microbiology-Sgm* 149:229-237
- Gruber N (2008) The marine nitrogen cycle: overview and challenges. In: Douglas G Capone, Deborah A Bronk, Margaret R Mulholland and Edward J Carpenter (eds) *Nitrogen in the marine environment*. Elsevier Academic Press, pp 1-50
- Gruber N, Galloway JN (2008) An Earth-system perspective of the global nitrogen cycle. *Nature* 451:293-296
- Hakata M, Takahashi M, Zumft W, Sakamoto A, Morikawa H (2003) Conversion of the nitrate nitrogen and nitrogen dioxide to nitrous oxides in plants. *Acta Biotechnologica* 23:249-257
- Harris JM (1993) The presence, nature, and role of gut microflora in aquatic invertebrates - a synthesis. *Microbial Ecology* 25:195-231
- Head IM, Hiorns WD, Embley TM, McCarthy AJ, Saunders JR (1993) The phylogeny of autotrophic ammonia-oxidizing bacteria as determined by analysis of 16S ribosomal RNA gene sequences. *Journal of General Microbiology* 139:1147-1153
- Henriksen K, Kemp WM (1988) Nitrification in estuarine and coastal marine sediments. In Blackburn TH, Sorensen J (eds) *Nitrogen cycling in coastal marine environments*. Wiley, pp 201-249
- Henriksen K, Rasmussen MB, Jensen A (1983) Effect of bioturbation on microbial nitrogen transformations in the sediment and fluxes of ammonium and nitrate to the overlying water *Ecological Bulletins*:193-205
- Herbert RA (1999) Nitrogen cycling in coastal marine ecosystems. *Fems Microbiology Reviews* 23:563-590

- Holland EA, Braswell BH, Sulzman J, Lamarque JF (2005) Nitrogen deposition onto the United States and western Europe: Synthesis of observations and models. *Ecological Applications* 15:38-57
- Holmes AJ, Costello A, Lidstrom ME, Murrell JC (1995) Evidence that particulate methane monooxygenase and ammonia monooxygenase may be evolutionarily related. *Fems Microbiology Letters* 132:203-208
- Hooper AB, Terry KR (1979) Hydroxylamine oxidoreductase of *Nitrosomonas* production of nitric oxide from hydroxylamine. *Biochimica Et Biophysica Acta* 571:12-20
- Horn MA, Drake HL, Schramm A (2006) Nitrous oxide reductase genes (*nosZ*) of denitrifying microbial populations in soil and the earthworm gut are phylogenetically similar. *Applied and Environmental Microbiology* 72:1019-1026
- Horn MA, Schramm A, Drake HL (2003) The earthworm gut: An ideal habitat for ingested N₂O-producing microorganisms. *Applied and Environmental Microbiology* 69:1662-1669
- Hulth S, Aller RC, Canfield DE, Dalsgaard T, Engstrom P, Gilbert F, Sundback K, Thamdrup B (2005) Nitrogen removal in marine environments: recent findings and future research challenges. *Marine Chemistry* 94:125-145
- Ihssen J, Horn MA, Matthies C, Gossner A, Schramm A, Drake HL (2003) N₂O-producing microorganisms in the gut of the earthworm *Aporrectodea caliginosa* are indicative of ingested soil bacteria. *Applied and Environmental Microbiology* 69:1655-1661
- IPCC: In Climate Change 2007: The Physical Science Base. Contribution of Working Group I to the Fourth Assessment Report of the Intergovernmental Panel on Climate Change. Edited by Solomon S, Qin D, Manning M, Chen Z, Marquis M, Averyt KB, Tignor M, Miller HL. Cambridge, United Kingdom and New York, NY, USA: Cambridge University Press; 2007
- Ivens W, Tysmans DJJ, Kroeze C, Lohr AJ, van Wijnen J (2011) Modeling global N₂O emissions from aquatic systems. *Current Opinion in Environmental Sustainability* 3:350-358
- Johnston H (1971) Reduction of stratospheric ozone by nitrogen oxide catalysts from supersonic transport exhaust. *Science* 173:517-522
- Jones CG, Lawton JH, Shachak M (1994) Organisms as ecosystem engineers *Oikos* 69:373-386
- Jones DL, Healey JR, Willett VB, Farrar JF, Hodge A (2005) Dissolved organic nitrogen uptake by plants - an important N uptake pathway? *Soil Biology & Biochemistry* 37:413-423
- Jørgensen BB, Sorensen J (1985) Seasonal cycles of O₂, NO₃⁻ and SO₄²⁻ reduction in estuarine sediments - the significance of an NO₃⁻ reduction maximum in spring *Marine Ecology-Progress Series* 24:65-74
- Jørgensen KS, Sorensen J (1988) 2 annual maxima of nitrate reduction and denitrification in estuarine sediment (Norsminde Fjord, Denmark). *Marine Ecology-Progress Series* 48:147-154
- Joye SB, Anderson IC (2008) Nitrogen cycling in coastal sediments. In: Douglas G Capone, Deborah A Bronk, Margaret R Mulholland and Edward J Carpenter (eds) *Nitrogen in the marine environment*. Elsevier Academic Press, pp 868-915
- Karsten GR, Drake HL (1997) Denitrifying bacteria in the earthworm gastrointestinal tract and in vivo emission of nitrous oxide (N₂O) by earthworms. *Applied and Environmental Microbiology* 63:1878-1882

- Kartal B, Kuypers MMM, Lavik G, Schalk J, den Camp H, Jetten MSM, Strous M (2007) Anammox bacteria disguised as denitrifiers: nitrate reduction to dinitrogen gas via nitrite and ammonium. *Environmental Microbiology* 9:635-642
- Kaspar HF, Tiedje JM (1981) Dissimilatory reduction of nitrate and nitrite in the bovine rumen - nitrous oxide production and effect of acetylene. *Applied and Environmental Microbiology* 41:705-709
- Kelso BHL, Smith RV, Laughlin RJ, Lennox SD (1997) Dissimilatory nitrate reduction in anaerobic sediments leading to river nitrite accumulation. *Applied and Environmental Microbiology* 63:4679-4685
- Kester RA, deBoer W, Laanbroek HJ (1997) Production of NO and N₂O by pure cultures of nitrifying and denitrifying bacteria during changes in aeration. *Applied and Environmental Microbiology* 63:3872-3877
- Khalil MAK, Rasmussen RA, Shearer MJ (2002) Atmospheric nitrous oxide: patterns of global change during recent decades and centuries. *Chemosphere* 47:807-821
- Kim SW, Miyahara M, Fushinobu S, Wakagi T, Shoun H (2010) Nitrous oxide emission from nitrifying activated sludge dependent on denitrification by ammonia-oxidizing bacteria. *Bioresource Technology* 101:3958-3963
- Knowles R (1982) Denitrification. *Microbiological Reviews* 46:43-70
- Konneke M, Bernhard AE, de la Torre JR, Walker CB, Waterbury JB, Stahl DA (2005) Isolation of an autotrophic ammonia-oxidizing marine archaeon. *Nature* 437:543-546
- Kool DM, Dolfing J, Wrage N, Van Groenigen JW (2011) Nitrifier denitrification as a distinct and significant source of nitrous oxide from soil. *Soil Biology & Biochemistry* 43:174-178
- Koop-Jakobsen K, Giblin AE (2010) The effect of increased nitrate loading on nitrate reduction via denitrification and DNRA in salt marsh sediments. *Limnology and Oceanography* 55:789-802
- Koops HP, Pommerening-Röser A (2005) The lithoautotrophic ammonia-oxidizing bacteria. In: Brenner DJ, Krieg NR, Staley JT, Garrity GM (eds) *Bergey's manual of systematic bacteriology, volume two: the proteobacteria, part A introductory essays*, Springer, pp 141-147
- Kowalchuk GA, Stephen JR (2001) Ammonia-oxidizing bacteria: A model for molecular microbial ecology. *Annual Review of Microbiology* 55:485-529
- Kraft B, Strous M, Tegetmeyer HE (2011) Microbial nitrate respiration - Genes, enzymes and environmental distribution. *Journal of Biotechnology* 155:104-117
- Kristensen E (2000) Organic matter diagenesis at the oxic/anoxic interface in coastal marine sediments, with emphasis on the role of burrowing animals. *Hydrobiologia* 426:1-24
- Kristensen E (2001) Impact of polychaetes (*Nereis* spp. and *Arenicola marina*) on carbon biogeochemistry in coastal marine sediments. *Geochemical Transactions* 2: 92-103
- Kristensen E, Mikkelsen OL (2003) Impact of the burrow-dwelling polychaete *Nereis diversicolor* on the degradation of fresh and aged macroalgal detritus in a coastal marine sediment. *Marine Ecology-Progress Series* 265:141-153
- Kuenen JG (2008) Anammox bacteria: from discovery to application. *Nature Reviews Microbiology* 6:320-326
- Lam P, Kuypers MMM (2011) Microbial Nitrogen Cycling Processes in Oxygen Minimum Zones. In: *Annual Review of Marine Science, Vol 3, Vol 3*, p 317-345

- Lam P, Lavik G, Jensen MM, van de Vossenberg J, Schmid M, Woebken D, Dimitri G, Amann R, Jetten MSM, Kuypers MMM (2009) Revising the nitrogen cycle in the Peruvian oxygen minimum zone. *Proceedings of the National Academy of Sciences of the United States of America* 106:4752-4757
- Leininger S, Urich T, Schloter M, Schwark L, Qi J, Nicol GW, Prosser JI, Schuster SC, Schleper C (2006) Archaea predominate among ammonia-oxidizing prokaryotes in soils. *Nature* 442:806-809
- Lloyd D (1993) Aerobic denitrification in soils and sediments - from fallacies to facts *Trends in Ecology & Evolution* 8:352-356
- MacIntyre HL, Geider RJ, Miller DC (1996) Microphytobenthos: The ecological role of the "secret garden" of unvegetated, shallow-water marine habitats .1. Distribution, abundance and primary production. *Estuaries* 19:186-201
- Magalhaes CM, Wiebe WJ, Joye SB, Bordalo AA (2005) Inorganic nitrogen dynamics in intertidal rocky biofilms and sediments of the Douro River estuary (Portugal). *Estuaries* 28:592-607
- Matson P, Lohse KA, Hall SJ (2002) The globalization of nitrogen deposition: Consequences for terrestrial ecosystems. *Ambio* 31:113-119
- Matthies C, Griesshammer A, Schmittroth M, Drake HL (1999) Evidence for involvement of gut-associated denitrifying bacteria in emission of nitrous oxide (N₂O) by earthworms obtained from garden and forest soils. *Applied and Environmental Microbiology* 65:3599-3604
- McHenry JG, Birkbeck TH (1985) Uptake and processing of cultured microorganisms by bivalves. *Journal of Experimental Marine Biology and Ecology* 90:145-163
- Mermillod-Blondin F, Rosenberg R (2006) Ecosystem engineering: the impact of bioturbation on biogeochemical processes in marine and freshwater benthic habitats. *Aquatic Sciences* 68:434-442
- Michaud E (2006) The functional group approach to bioturbation: II. The effects of the *Macoma balthica* community on fluxes of nutrients and dissolved organic carbon across the sediment-water interface. *Journal of Experimental Marine Biology and Ecology* 337:178-189
- Morley N, Baggs EM (2010) Carbon and oxygen controls on N₂O and N₂ production during nitrate reduction. *Soil Biology & Biochemistry* 42:1864-1871
- Mortimer RJG, Davey JT, Krom MD, Watson PG, Frickers PE, Clifton RJ (1999) The effect of macrofauna on porewater profiles and nutrient fluxes in the intertidal zone of the Humber Estuary. *Estuarine Coastal and Shelf Science* 48:683-699
- Mosier A, Kroeze C, Nevison C, Oenema O, Seitzinger S, van Cleemput O (1998) Closing the global N₂O budget: nitrous oxide emissions through the agricultural nitrogen cycle - OECD/IPCC/IEA phase II development of IPCC guidelines for national greenhouse gas inventory methodology. *Nutrient Cycling in Agroecosystems* 52:225-248
- Mulder A, Vandegraaf AA, Robertson LA, Kuenen JG (1995) Anaerobic ammonium oxidation discovered in a denitrifying fluidized bed reactor. *Fems Microbiology Ecology* 16:177-183
- Mulholland MR, Lomas MW (2008) Nitrogen uptake and assimilation. In: Douglas G Capone, Deborah A Bronk, Margaret R Mulholland and Edward J Carpenter (eds) *Nitrogen in the marine environment*. Elsevier Academic Press, pp 303-384
- Naqvi SWA (2000) Increased marine production of N₂O due to intensifying anoxia on the Indian continental shelf. *Nature* 408:346-349

- Naqvi SWA, Bange HW, Farias L, Monteiro PMS, Scranton MI, Zhang J (2010) Marine hypoxia/anoxia as a source of CH₄ and N₂O. *Biogeosciences* 7:2159-2190
- Naqvi SWA, Jayakumar DA, Narvekar PV, Naik H, Sarma V, D'Souza W, Joseph S, George MD (2000) Increased marine production of N₂O due to intensifying anoxia on the Indian continental shelf. *Nature* 408:346-349
- Nevison C, Butler JH, Elkins JW (2003) Global distribution of N₂O and the Delta N₂O-AOU yield in the subsurface ocean. *Global Biogeochemical Cycles* 17
- Nevison CD, Lueker TJ, Weiss RF (2004) Quantifying the nitrous oxide source from coastal upwelling. *Global Biogeochemical Cycles* 18
- Ngugi DK, Brune A (2012) Nitrate reduction, nitrous oxide formation, and anaerobic ammonia oxidation to nitrite in the gut of soil-feeding termites (*Cubitermes* and *Ophiotermes* spp.). *Environmental Microbiology* 14:860-871
- Nielsen OI, Gribsholt B, Kristensen E, Revsbech NP (2004) Microscale distribution of oxygen and nitrate in sediment inhabited by *Nereis diversicolor*: spatial patterns and estimated reaction rates. *Aquatic Microbial Ecology* 34:23-32
- Nixon SW, Buckley BA (2002) "A strikingly rich zone" - Nutrient enrichment and secondary production in coastal marine ecosystems. *Estuaries* 25:782-796
- Oaks A (1992) A reevaluation of nitrogen assimilation in roots. *Bioscience* 42:103-111
- Oenema O, Wrage N, Velthof GL, van Groenigen JW, Dolfing J, Kuikman PJ (2005) Trends in global nitrous oxide emissions from animal production systems. *Nutrient Cycling in Agroecosystems* 72:51-65
- Olsen SC, McLinden CA, Prather MJ (2001) Stratospheric N₂O -NO(y) system: Testing uncertainties in a three-dimensional framework. *Journal of Geophysical Research-Atmospheres* 106:28771-28784
- Papaspyrou S, Gregersen T, Kristensen E, Christensen B, Cox RP (2006) Microbial reaction rates and bacterial communities in sediment surrounding burrows of two nereidid polychaetes (*Nereis diversicolor* and *N-virens*). *Marine Biology* 148:541-550
- Patureau D, Zumstein E, Delgenes JP, Moletta R (2000) Aerobic denitrifiers isolated from diverse natural and managed ecosystems. *Microbial Ecology* 39:145-152
- Pelegri SP, Blackburn TH (1994) Bioturbation Effects of the Amphipod *Corophium Volutator* on Microbial Nitrogen Transformations in Marine-Sediments. *Marine Biology* 121:253-258
- Pester M, Schleper C, Wagner M (2011) The Thaumarchaeota: an emerging view of their phylogeny and ecophysiology. *Current Opinion in Microbiology* 14:300-306
- Plante C, Jumars P (1992) The microbial environment of marine deposit feeder guts characterized via microelectrodes. *Microbial Ecology* 23:257-277
- Plante CJ, Shriver AG (1998) Patterns of differential digestion of bacteria in deposit feeders: a test of resource partitioning. *Marine Ecology-Progress Series* 163:253-258
- Plante CJ, Wilde SB (2004) Biotic disturbance, recolonization, and early succession of bacterial assemblages in intertidal sediments. *Microbial Ecology* 48:154-166
- Poth M, Focht DD (1985) N-15 kinetic analysis of N₂O production by *Nitrosomonas europaea* - an examination of nitrifier denitrification *Applied and Environmental Microbiology* 49:1134-1141
- Prins TC, Smaal AC, Pouwer AJ, Dankers N (1996) Filtration and resuspension of particulate matter and phytoplankton on an intertidal mussel bed in the

- Oosterschelde estuary (SW Netherlands). *Marine Ecology-Progress Series* 142:121-134
- Purkhold U, Pommerening-Roser A, Juretschko S, Schmid MC, Koops HP, Wagner M (2000) Phylogeny of all recognized species of ammonia oxidizers based on comparative 16S rRNA and amoA sequence analysis: Implications for molecular diversity surveys. *Applied and Environmental Microbiology* 66:5368-5382
- Rabalais NN (2002) Nitrogen in aquatic ecosystems. *Ambio* 31:102-112
- Ravishankara AR, Daniel JS, Portmann RW (2009) Nitrous Oxide (N₂O): The Dominant Ozone-Depleting Substance Emitted in the 21st Century. *Science* 326:123-125
- Reise K (2002) Sediment mediated species interactions in coastal waters. *Journal of Sea Research* 48:127-141
- Revsbech NP, Sorensen J, Blackburn TH, Lomholt JP (1980) Distribution of oxygen in marine sediments measured with microelectrodes. *Limnology and Oceanography* 25:403-411
- Richardson D, Felgate H, Watmough N, Thomson A, Baggs E (2009) Mitigating release of the potent greenhouse gas N₂O from the nitrogen cycle - could enzymic regulation hold the key? *Trends in Biotechnology* 27:388-397
- Risgaard-Petersen N, Langezaal AM, Ingvarlsen S, Schmid MC, Jetten MSM, Op den Camp HJM, Derksen JWM, Pina-Ochoa E, Eriksson SP, Nielsen LP, Revsbech NP, Cedhagen T, van der Zwaan GJ (2006) Evidence for complete denitrification in a benthic foraminifer. *Nature* 443:93-96
- Ritchie GAF, Nicholas DJ (1972) Identification of sources of nitrous-oxide produced by oxidative and reductive processes in *Nitrosomonas europaea*. *Biochemical Journal* 126:1181-1191
- Robertson LA, Cornelisse R, Devos P, Hadjioetomo R, Kuenen JG (1989) Aerobic denitrification in various heterotrophic nitrifiers. *Antonie Van Leeuwenhoek Journal of Microbiology* 56:289-299
- Robertson LA, Kuenen JG (1984) Aerobic denitrification - a controversy revived. *Archives of Microbiology* 139:351-354
- Robertson LA, Kuenen JG (1990) Combined heterotrophic nitrification and aerobic denitrification in *Thiosphaera pantotropha* and other bacteria. *Antonie Van Leeuwenhoek International Journal of General and Molecular Microbiology* 57:139-152
- Rubasinghe G, Spak SN, Stanier CO, Carmichael GR, Grassian VH (2011) Abiotic Mechanism for the Formation of Atmospheric Nitrous Oxide from Ammonium Nitrate. *Environmental Science & Technology* 45:2691-2697
- Santoro AE, Buchwald C, McIlvin MR, Casciotti KL (2011) Isotopic Signature of N₂O Produced by Marine Ammonia-Oxidizing Archaea. *Science* 333:1282-1285
- Schilt A, Baumgartner M, Blunier T, Schwander J, Spahni R, Fischer H, Stocker TF (2010) Glacial-interglacial and millennial-scale variations in the atmospheric nitrous oxide concentration during the last 800,000 years. *Quaternary Science Reviews* 29:182-192
- Schleper C, Nicol GW (2010) Ammonia-Oxidising Archaea - Physiology, Ecology and Evolution. In: *Advances in Microbial Physiology*, Vol 57, Vol 57, p 1-41
- Schlesinger WH (1997) *Biogeochemistry: an analysis of global change*. 2nd edition. Academic Press, California, USA
- Schlesinger WH (2009) On the fate of anthropogenic nitrogen. *Proceedings of the National Academy of Sciences of the United States of America* 106:203-208

- Schmidt CS, Richardson DJ, Baggs EM (2011) Constraining the conditions conducive to dissimilatory nitrate reduction to ammonium in temperate arable soils. *Soil Biology & Biochemistry* 43:1607-1611
- Schmidt I, van Spanning RJM, Jetten MSM (2004) Denitrification and ammonia oxidation by *Nitrosomonas europaea* wild-type, and NirK- and NorB-deficient mutants. *Microbiology-Sgm* 150:4107-4114
- Schreiber F, Loeffler B, Polerecky L, Kuypers MMM, de Beer D (2009) Mechanisms of transient nitric oxide and nitrous oxide production in a complex biofilm. *Isme Journal* 3:1301-1313
- Seitzinger SP (1988) Denitrification in Fresh-Water and Coastal Marine Ecosystems - Ecological and Geochemical Significance. *Limnology and Oceanography* 33:702-724
- Seitzinger SP, Kroeze C (1998) Global distribution of nitrous oxide production and N inputs in freshwater and coastal marine ecosystems. *Global Biogeochemical Cycles* 12:93-113
- Seitzinger SP, Kroeze C, Styles RV (2000) Global distribution of N₂O emissions from aquatic systems: natural emissions and anthropogenic effects. *Chemosphere - Global Change Science* 2, pp 267-279
- Seitzinger SP, Harrison JA, Bohlke JK, Bouwman AF, Lowrance R, Peterson B, Tobias C, Van Drecht G (2006) Denitrification across landscapes and waterscapes: A synthesis. *Ecological Applications* 16:2064-2090
- Seitzinger SP, Mayorga E, Bouwman AF, Kroeze C, Beusen AHW, Billen G, Van Drecht G, Dumont E, Fekete BM, Garnier J, Harrison JA (2010) Global river nutrient export: A scenario analysis of past and future trends. *Global Biogeochemical Cycles* 24
- Senga Y, Mochida K, Fukumori R, Okamoto N, Seike Y (2006) N₂O accumulation in estuarine and coastal sediments: The influence of H₂S on dissimilatory nitrate reduction. *Estuarine Coastal and Shelf Science* 67:231-238
- Shaw LJ, Nicol GW, Smith Z, Fear J, Prosser JI, Baggs EM (2006) *Nitrosospora* spp. can produce nitrous oxide via a nitrifier denitrification pathway. *Environmental Microbiology* 8:214-222
- Shoun H, Kim DH, Uchiyama H, Sugiyama J (1992) Denitrification by fungi. *Fems Microbiology Letters* 94:277-281
- Silver WL, Herman DJ, Firestone MK (2001) Dissimilatory nitrate reduction to ammonium in upland tropical forest soils. *Ecology* 82:2410-2416
- Smaal AC, Zurburg W (1997) The uptake and release of suspended and dissolved material by oysters and mussels in Marennes-Oleron Bay. *Aquatic Living Resources* 10:23-30
- Smart DR, Bloom AJ (2001) Wheat leaves emit nitrous oxide during nitrate assimilation. *Proceedings of the National Academy of Sciences of the United States of America* 98:7875-7878
- Stehfest E, Bouwman L (2006) N₂O and NO emission from agricultural fields and soils under natural vegetation: summarizing available measurement data and modeling of global annual emissions. *Nutrient Cycling in Agroecosystems* 74:207-228
- Stein LY (2011) Surveying N₂O-producing pathways in bacteria. In: Klotz MG (ed) *Methods in Enzymology*, Elsevier Academic Press; pp 131-152
- Stein LY, Yung YL (2003) Production, isotopic composition, and atmospheric fate of biologically produced nitrous oxide. *Annual Review of Earth and Planetary Sciences* 31:329-356

- Stief P, de Beer D (2006) Probing the microenvironment of freshwater sediment macrofauna: Implications of deposit-feeding and bioirrigation for nitrogen cycling. *Limnology and Oceanography* 51:2538-2548
- Stief P, Eller G (2006) The gut microenvironment of sediment-dwelling *Chironomus plumosus* larvae as characterised with O₂, pH, and redox microsensors. *Journal of Comparative Physiology B-Biochemical Systemic and Environmental Physiology* 176:673-683
- Stief P, Polerecky L, Poulsen M, Schramm A (2010) Control of nitrous oxide emission from *Chironomus plumosus* larvae by nitrate and temperature. *Limnology and Oceanography* 55:872-884
- Stief P, Poulsen M, Nielsen LP, Brix H, Schramm A (2009) Nitrous oxide emission by aquatic macrofauna. *Proceedings of the National Academy of Sciences of the United States of America* 106:4296-4300
- Stief P, Schramm A (2010) Regulation of nitrous oxide emission associated with benthic invertebrates. *Freshwater Biology* 55:1647-1657
- Straub KL, Buchholz-Cleven BEE (1998) Enumeration and detection of anaerobic ferrous iron-oxidizing, nitrate-reducing bacteria from diverse European sediments. *Applied and Environmental Microbiology* 64:4846-4856
- Strous M, Fuerst JA, Kramer EHM, Logemann S, Muyzer G, van de Pas-Schoonen KT, Webb R, Kuenen JG, Jetten MSM (1999) Missing lithotroph identified as new planctomycete. *Nature* 400:446-449
- Strous M, Pelletier E, Mangenot S, Rattei T, Lehner A, Taylor MW, Horn M, Daims H, Bartol-Mavel D, Wincker P, Barbe V, Fonknechten N, Vallenet D, Segurens B, Schenowitz-Truong C, Medigue C, Collingro A, Snel B, Dutilh BE, Op den Camp HJM, van der Drift C, Cirpus I, van de Pas-Schoonen KT, Harhangi HR, van Niftrik L, Schmid M, Keltjens J, van de Vossenberg J, Kartal B, Meier H, Frishman D, Huynen MA, Mewes HW, Weissenbach J, Jetten MSM, Wagner M, Le Paslier D (2006) Deciphering the evolution and metabolism of an anammox bacterium from a community genome. *Nature* 440:790-794
- Stuven R, Vollmer M, Bock E (1992) The impact of organic matter on nitric oxide formation by *Nitrosomonas europaea*. *Archives of Microbiology* 158:439-443
- Suess E (1980) Particulate organic carbon flux in the oceans - surface productivity and oxygen utilization *Nature* 288:260-263
- Suntharalingam P, Buitenhuis E, Le Quere C, Dentener F, Nevison C, Butler JH, Bange HW, Forster G (2012) Quantifying the impact of anthropogenic nitrogen deposition on oceanic nitrous oxide. *Geophysical Research Letters* 39
- Suntharalingam P, Sarmiento JL (2000) Factors governing the oceanic nitrous oxide distribution: Simulations with an ocean general circulation model. *Global Biogeochemical Cycles* 14:429-454
- Svensson JM (1998) Emission of N₂O, nitrification and denitrification in a eutrophic lake sediment bioturbated by *Chironomus plumosus*. *Aquatic Microbial Ecology* 14:289-299
- Syakila A, Kroeze C: The global N₂O budget revisited. *Greenhouse Gas Measurement & Management* 2011, 1:17-26
- Tiedje J (1988) Ecology of denitrification and dissimilatory nitrate reduction to ammonium. In: *Biology of anaerobic microorganisms*. Wiley, New York, p 179-244
- Trevors JT, Starodub ME (1987) Effect of oxygen concentration on denitrification in freshwater sediment. *Journal of Basic Microbiology* 27:387-391

- van Beusekom JEE, Weigelt-Krenz S, Martens P (2008) Long-term variability of winter nitrate concentrations in the Northern Wadden Sea driven by freshwater discharge, decreasing riverine loads and denitrification. *Helgoland Marine Research* 62:49-57
- van den Heuvel RN, Bakker SE, Jetten MSM, Hefting MM (2011) Decreased N₂O reduction by low soil pH causes high N₂O emissions in a riparian ecosystem. *Geobiology* 9:294-300
- van der Star WRL, van de Graaf MJ, Kartal B, Picioreanu C, Jetten MSM, van Loosdrecht MCM (2008) Response of anaerobic ammonium-oxidizing bacteria to hydroxylamine. *Applied and Environmental Microbiology* 74:4417-4426
- Vitousek PM, Aber JD, Howarth RW, Likens GE, Matson PA, Schindler DW, Schlesinger WH, Tilman DG (1997) Human alteration of the global nitrogen cycle: Sources and consequences. *Ecological Applications* 7:737-750
- Vitousek PM, Hattenschwiler S, Olander L, Allison S (2002) Nitrogen and nature. *Ambio* 31:97-101
- Wahl M (1989) Marine epibiosis. 1. Fouling and antifouling - some basic aspects *Marine Ecology-Progress Series* 58:175-189
- Walker CB, de la Torre JR, Klotz MG, Urakawa H, Pinel N, Arp DJ, Brochier-Armanet C, Chain PSG, Chan PP, Gollabgir A, Hemp J, Hugler M, Karr EA, Konneke M, Shin M, Lawton TJ, Lowe T, Martens-Habbena W, Sayavedra-Soto LA, Lang D, Sievert SM, Rosenzweig AC, Manning G, Stahl DA (2010) *Nitrosopumilus maritimus* genome reveals unique mechanisms for nitrification and autotrophy in globally distributed marine crenarchaea. *Proceedings of the National Academy of Sciences of the United States of America* 107:8818-8823
- Wallenstein MD, Myrold DD, Firestone M, Voytek M (2006) Environmental controls on denitrifying communities and denitrification rates: Insights from molecular methods. *Ecological Applications* 16:2143-2152
- Ward BB (2008) Nitrification in marine systems In: Douglas G Capone, Deborah A Bronk, Margaret R Mulholland and Edward J Carpenter (eds) *Nitrogen in the marine environment*. Elsevier Academic Press, pp 199-261
- Weiss RF, Price BA (1980) Nitrous-oxide solubility in water and seawater. *Marine Chemistry* 8:347-359
- Welsh DT, Castadelli G (2004) Bacterial nitrification activity directly associated with isolated benthic marine animals. *Marine Biology* 144:1029-1037
- Wenzhofer F, Glud RN (2004) Small-scale spatial and temporal variability in coastal benthic O₂ dynamics: Effects of fauna activity. *Limnology and Oceanography* 49:1471-1481
- Williams J, Crutzen PJ (2010) Nitrous oxide from aquaculture. *Nature Geoscience* 3:143-143
- Wrage N (2001) Role of nitrifier denitrification in the production of nitrous oxide. *Soil Biology & Biochemistry* 33:1723-1732
- Wuchter C, Abbas B, Coolen MJL, Herfort L, van Bleijswijk J, Timmers P, Strous M, Teira E, Herndl GJ, Middelburg JJ, Schouten S, Damste JSS (2006) Archaeal nitrification in the ocean. *Proceedings of the National Academy of Sciences of the United States of America* 103:12317-12322
- Wuebbles DJ (2009) Nitrous Oxide: No Laughing Matter. *Science* 326:56-57
- Yu R, Kampschreur MJ, van Loosdrecht MCM, Chandran K (2010) Mechanisms and Specific Directionality of Autotrophic Nitrous Oxide and Nitric Oxide Generation during Transient Anoxia. *Environmental Science & Technology* 44:1313-1319

- Zaehle S, Ciais P, Friend AD, Prieur V (2011) Carbon benefits of anthropogenic reactive nitrogen offset by nitrous oxide emissions. *Nature Geoscience* 4:601-605
- Zehr JP, Ward BB (2002) Nitrogen cycling in the ocean: New perspectives on processes and paradigms. *Applied and Environmental Microbiology* 68:1015-1024
- Zumft WG (1997) Cell biology and molecular basis of denitrification. *Microbiology and Molecular Biology Reviews* 61:533-616
- Zumft WG, Kroneck PMH (2007) Respiratory transformation of nitrous oxide (N₂O) to dinitrogen by Bacteria and Archaea. In: *Advances in Microbial Physiology*, Vol 52, Vol 52, p 107-227

Chapter 2



Feature Article photograph: N₂O production associated with the snail *Hinia reticulata* partly results from microbial activity in exoskeletal biofilms covering the shell.

Nitrous oxide production associated with coastal marine invertebrates

Ines Maria Heisterkamp¹, Andreas Schramm², Dirk de Beer¹, and Peter Stief¹

¹Max Planck Institute for Marine Microbiology, Microsensor Group,
Celsiusstraße 1, D-28359 Bremen, Germany

²Department of Biological Sciences, Microbiology, Aarhus University,
Ny Munkegade 114, DK-8000 Aarhus C, Denmark

Feature Article in *Marine Ecology Progress Series* 415: 1-9, 2010

Abstract

Several freshwater and terrestrial invertebrate species emit the greenhouse gas nitrous oxide (N₂O). The N₂O production associated with these animals was ascribed to incomplete denitrification by ingested sediment or soil bacteria. The present study shows that many marine invertebrates also emit N₂O at substantial rates. A total of 19 invertebrate species collected in the German Wadden Sea and in Aarhus Bay, Denmark, and 1 aquacultured shrimp species were tested for N₂O emission. Potential N₂O emission rates ranged from 0 to 1.354 nmol individual⁻¹ h⁻¹, with an average rate of 0.320 nmol individual⁻¹ h⁻¹, excluding the aquacultured shrimp *Litopenaeus vannamei*, which showed the highest rate of N₂O emission measured so far for any marine species (3.569 nmol individual⁻¹ h⁻¹), probably due to very high nitrate concentrations in the rearing tanks. N₂O emitted by *L. vannamei* was almost exclusively produced in its gut by incomplete denitrification. Statistical analysis revealed that body weight, habitat, and exoskeletal biofilms were important determinants of animal-associated N₂O production. The snail *Hinia reticulata* emitted about 3.5 times more N₂O with an intact exoskeletal biofilm on its shell than with an experimentally cleaned shell. Thus, N₂O production associated with marine invertebrates is apparently not in every species due to gut denitrification, but may also result from microbial activity on external surfaces of the animals. The high abundance and potential N₂O emission rates of many marine invertebrate species suggest significant contributions to overall N₂O emissions from coastal marine environments and aquaculture facilities.

Introduction

Nitrous oxide (N₂O) is the third most important greenhouse gas after carbon dioxide and methane. Its atmospheric concentration is rapidly increasing, and it contributes significantly to global warming (IPCC 2007) and to the depletion of the stratospheric ozone layer (Ravishankara et al. 2009). Biogenic N₂O emission originates primarily from soils and oceans, where microbial nitrification and denitrification are the major N₂O-producing processes (Mosier et al. 1998, Stein & Yung 2003). During nitrification (the 2-stage oxidation of ammonium to nitrate) N₂O is produced as a byproduct in the first oxidation step (Goreau et al. 1980), whereas in denitrification (the respiratory reduction of nitrate or nitrite to nitrogenous gases) N₂O is produced as a true intermediate (Zumft 1997). The complete denitrification pathway involves 4 enzymes that reduce nitrate to dinitrogen stepwise via the intermediates nitrite, nitric oxide, and N₂O. The 4 reductases are induced sequentially under anoxic conditions when oxidized inorganic nitrogen compounds and appropriate electron donors are available (Tiedje 1988, Zumft 1997). Whether denitrification acts as a source or sink of N₂O depends on the presence and activity of nitrous oxide reductase, which shows a higher sensitivity towards oxygen, lower carbon-to-nitrate ratios, and lower pH than the other 3 enzymes (Tiedje 1988, Bonin & Raymond 1990).

Important sites of N₂O emission are environments that are characterized by high input and turnover rates of inorganic nitrogen, such as fertilized soils and coastal areas (Mosier et al. 1998, Seitzinger & Kroeze 1998, Bange 2006). Microbial nitrogen conversions and concomitant N₂O production are especially stimulated in coastal sediments and in rock biofilms, due to high riverine input of nitrogen (Seitzinger & Nixon 1985, Law et al. 1992, Middelburg et al. 1995, Robinson et al. 1998, Magalhaes et al. 2005). Nitrification activity prevails at the oxic sediment surface and is fuelled by ammonium from organic matter degradation. Denitrification activity prevails in the anoxic subsurface layer and is driven by nitrate from nitrification (i.e. coupled nitrification–denitrification) or the water column (Jenkins & Kemp 1984). Sedimentary denitrification is commonly assumed to be the major source of N₂O to the water column, with benthic N₂O fluxes making up approximately 1% of the dinitrogen fluxes (Seitzinger 1988, Magalhaes et al. 2007, Ferrón et al. 2009). Sedimentary nitrification

can, despite lower N₂O production rates, significantly contribute to benthic N₂O fluxes, due to its proximity to the sediment surface (Meyer et al. 2008). Oversaturation of N₂O in the water column occurs in many coastal areas (Kieskamp et al. 1991, Middelburg et al. 1995, Robinson et al. 1998, Dong et al. 2002).

Besides the microbial N₂O production in soils, sediments, and water bodies, N₂O is also emitted by earthworms and freshwater invertebrates (Karsten & Drake 1997, Drake & Horn 2007, Stief et al. 2009). This animal-associated N₂O production is due to the denitrification activity of ingested bacteria in the anoxic gut. The specific *in situ* conditions of the earthworm gut, including anoxia and high concentrations of easily degradable organic carbon, as well as nitrate or nitrite, stimulate the activity of ingested N₂O-producing soil bacteria (Drake et al. 2006). A similar mechanism has been suggested for freshwater invertebrates, whose N₂O emission is largely explained by their preferred diet: filter- and deposit-feeders show high, shredders and grazers intermediate, and predators very low N₂O emission rates (Stief et al. 2009). This suggests that N₂O emission is caused by bacteria that are coingested with the food taken up by freshwater invertebrates. N₂O emission rates of both terrestrial and freshwater invertebrates increase with nitrate and temperature and decrease with oxygen availability, indicating the important role of these environmental factors for gut denitrification (Karsten & Drake 1997, Matthies et al. 1999, Stief et al. 2009, 2010, Stief & Schramm 2010).

The N₂O emission potential of marine invertebrates has so far been neglected, although coastal marine sediments are presumably hot spots of N₂O emission, since they are densely inhabited by filter- and depositfeeding invertebrates (Williams et al. 2004, Philippart et al. 2007) and exposed to high nitrate concentrations (Kieskamp et al. 1991, Van Beusekom et al. 2008). High N₂O emission can also be expected from aquaculture facilities in which animals are typically reared at high densities and high nitrate concentrations. The present study, therefore, investigated the N₂O emission potential of different marine invertebrate species from coastal sediments of the North Sea and Baltic Sea and of the aquacultured shrimp *Litopenaeus vannamei*. To understand how the N₂O emission potential of marine invertebrates is controlled by abiotic and biotic factors, correlations between potential N₂O emission rates and species-specific traits were investigated by statistical analysis.

Materials and Methods

Sampling of animals

We tested the N₂O emission potential of 19 benthic invertebrate species from the German Wadden Sea and the Aarhus Bay in Denmark, and of the aquacultured shrimp *Litopenaeus vannamei* (provided by Ecomaris Marifarm Kiel, Germany). Sampling was carried out between March and June 2008 at the mixed sediment intertidal flat near Dorum-Neufeld (53°45'N, 8°21'E) and at 3 different sites in Aarhus Bay (56°9.75'N, 10°16.80'E; 56°9.29'N, 10°19.15'E; 56°6.44'N, 10°27.96'E). Animals from the Wadden Sea were sampled at low tide. Epifaunal species were collected by forceps or hand, and infaunal species by digging up the sediment with a spade to a depth of approximately 25 cm and searching it by hand. Animals were placed in beakers filled with a layer of wet sediment from the sampling site until further processing in the laboratory. Sampling in Aarhus Bay was carried out from a research vessel by dredging the sediment with a triangle net. Some animals such as shore crabs and ascidians were sampled from rocks or pontoons in the harbor area of Aarhus. Sampled animals were kept in buckets filled with seawater from the upper water column (15°C) until incubation in the laboratory was started. The temperature of the water was measured at each sampling site, and water samples were filtered (0.2 µm) and stored at -20°C until nitrate concentration was measured using the VCl₃ reduction method (Braman and Hendrix 1989) with a chemiluminescence detector (CLD 66 S NO/NO_x-Analyser, Eco Physics).

Classification of species

The screening included Crustacea, Mollusca, Echinodermata, Polychaeta, and Ascidia (Table 1). For each species, the affiliation to a feeding type and to a benthic habitat was determined (Table 1). Species that feed by several feeding modes were assigned to their dominant feeding mode. The description 'infaunal + epifaunal' refers to infaunal species that feed at the sediment surface or in the water column. Species were further characterized by their wet weight and by the presence/absence of a visible microbial biofilm on exoskeletal surfaces such as molluscan shells, crustacean exoskeletons and

shell plates of polychaetes (Table 1). Most species with sturdy external surfaces carried such exoskeletal biofilms, but some of the crustacean and molluscan species (i.e. *Corophium volutator*, *Pagurus bernhardus*, and *Litopenaeus vannamei*, *Macoma balthica*, *Scrobicularia plana*, *Cerastoderma edule*) did not.

Table 1. List of taxa tested for N₂O emission with sampling details (temperature and nitrate concentration in the overlying water column at the sampling site). Taxa are sorted by descending weight within each taxonomic group. Sampling sites—AB: Aarhus Bay; WS: Wadden Sea; AQ: aquaculture; Feeding types—C: carnivore; DF: deposit-feeder; FF: filter-feeder; G: grazer. Habitat—E: epifaunal; I: infaunal; EI: epifaunal + infaunal

Species	Site	Temp. (°C)	Nitrate (µM)	Wet weight (g)	Feeding type	Habitat	Exoskeletal biofilm
Ascidia							
<i>Ascidia</i> sp.	AB	16	0-4	7.18	FF	E	Yes
Crustacea							
<i>Carcinus maenas</i>	AB	15	0-4	2.95	C	E	Yes
<i>Pagurus bernhardus</i>	AB	7	0-4	2.81	C	E	No
<i>Corophium volutator</i>	WS	8	20	0.01	DF	EI	No
Echinodermata							
<i>Echinocyamus pusillus</i>	AB	7	0-4	0.71	DF	I	No
<i>Echinocardium cordatum</i>	AB	7	0-4	0.27	DF	I	No
Mollusca							
<i>Scrobicularia plana</i>	WS	15	20	4.63	DF	EI	No
<i>Cerastoderma edule</i>	WS	15	20	2.07	FF	EI	No
<i>Mytilus edulis</i>	AB	7	0-4	0.97	FF	E	Yes
<i>Macoma balthica</i>	WS	15	20	0.31	DF	EI	No
Polyplacophora ^a	AB	7	0-4	0.27	G	E	Yes
<i>Littorina littorea</i>	WS	22	20	2.22	G	E	Yes
<i>Hinia reticulata</i>	AB	7	0-4	1.70	C	EI	Yes
<i>Gibbula</i> sp.	AB	7	0-4	0.78	G	E	Yes
<i>Hydrobia ulvae</i>	WS	21	20	0.01	G	E	Yes
Polychaeta							
<i>Arenicola marina</i>	WS	8	20	2.06	DF	I	No
<i>Lepidonotus squamatus</i>	AB	7	0-4	0.49	C	E	Yes
<i>Nephtys hombergii</i>	WS	8	20	0.33	C	I	No
<i>Nereis diversicolor</i>	WS	8	20	0.15	DF	EI	No
Crustacea							
<i>Litopenaeus vannamei</i>	AQ	28-30	1000	21.16	DF	E	No

^a Not determined to genus level

Rate of N₂O emission

N₂O emission of the specimens was determined by incubating freshly collected, living animals (exception: *Litopenaues vannamei*) in gas-tight vials with septa that allowed repeated sampling of the headspace for N₂O. The incubations were standardized regarding the environmental variables temperature (21°C) and oxygen (initially oxic headspace), since the main goal of the screening was to search for species-specific rather than environmental controls of the N₂O emission potential. In many cases, the standardized conditions in the incubation vial were different from those in the natural habitat of the animals. Therefore, the N₂O emission rates measured with this approach represent potential rather than actual or *in situ* rates.

Incubation of animals was started after sampling, transport, and preparation of incubation vials which took 3 to 5 h. Species were incubated in 3, 6, 10 or 100 ml sterile, gas-tight vials, depending on their size and number of individuals. Most species were found in sufficient quantity to prepare several vials per species with different numbers of individuals (Table 2). Bivalves and ascidians were submerged in seawater to allow the individuals to be active and thereby exchange gases with the incubation vial. To the other species only a small volume of seawater was added (0.05-2 ml) to maintain a moist atmosphere in the vials. Species from Aarhus Bay were supplied with 0.2 µm filtered seawater collected while sampling the animals; species from the intertidal flat were supplied with autoclaved seawater from the same site, collected during high tide and stored in an opaque tank until used for incubations. Animals were thus exposed to *in situ* nitrate and ammonium concentrations. The ammonium concentration in the incubation vials was initially below the detection limit of 0.5 µM and may have increased due to excretion of ammonium by the animals, which was in the range of 0.1–1.0 µmol individual⁻¹ h⁻¹ (Heisterkamp unpublished results). The aquacultured shrimp *Litopenaues vannamei* were killed in ice-water before incubating them in 100 ml bottles with 2 ml of 0.2 µm filtered aquarium water that contained 1mM nitrate and 14 µM ammonium. Additionally, dissected guts of *L. vannamei* were incubated in 3 ml exetainers (Labco) supplied with 50 µl of 0.2 µm filtered aquarium water.

Table 2: Potential N₂O emission rates in nmol ind.⁻¹ h⁻¹ and nmol g⁻¹ h⁻¹ of the 20 tested species (mean values). Number of replicates per species and range of individual numbers per incubation vial, as well as the initial N₂O concentration and final N₂O concentration in the incubation vials are listed (mean values).

Species	N ₂ O emission (nmol g ⁻¹ h ⁻¹)	N (range)	N ₂ O conc. (nM)	
			Initial	Highest
<i>Ascidia sp.</i>	0.043 ± 0.024	5(1–4)	5.9	54
<i>Carcinus maenas</i>	0.369 ± 0.137	3(1–3)	12.5	311
<i>Pagurus bernhardus</i>	0.020 ± 0.018	5(1–3)	8.5	167
<i>Corophium volutator</i>	0.955 ± 0.664	2(6–7)	10.2	123
<i>Echinocyamus pusillus</i>	0.040 ± 0.027	3(1–3)	12.7	40
<i>Echinocardium cordatum</i>	0.069	1 (5)	12.2	20
<i>Scrobicularia plana</i>	0.302 ± 0.083	3(2–3)	9.2	263
<i>Cerastoderma edule</i>	0.126	1 (5)	9.5	187
<i>Mytilus edulis</i>	0.269 ± 0.280	7 (1)	10.2	264
<i>Macoma balthica</i>	1.098 ± 1.066	7 (4–30)	9.8	287
Polyplacophora ^a	0.471 ± 0.237	2 (6)	12.5	465
<i>Littorina littorea</i>	0.237 ± 0.208	6 (5–15)	9.7	167
<i>Hinia reticulata</i>	0.608 ± 0.265	7(1–3)	13.1	542
<i>Gibbula sp.</i>	0.107 ± 0.037	2(2–4)	13.1	345
<i>Hydrobia ulvae</i>	5.449 ± 1.822	4 (25 – 50)	10.7	463
<i>Arenicola marina</i>	0.045 ± 0.032	3 (1–2)	11.3	55
<i>Lepidonotus squamatus</i>	0.666	1 (3)	12.5	466
<i>Nephtys hombergii</i>	0.082 ± 0.053	3 (1–2)	0.1	5.6
<i>Nereis diversicolor</i>	0.398 ± 0.319	9 (1–2)	11.7	21
<i>Litopenaeus vannamei</i>	0.183 ± 0.066	6 (1)	12.5	250

^aNot determined to genus level

Animals were cleaned from loosely attached sediment and algal tufts by washing them in autoclaved seawater and drying them on paper tissue; the tightly attached biofilms largely remained on the external surface of the animals. To explicitly test for effects of this exoskeletal biofilm on the N₂O emission potential, the snail *Hinia reticulata* was incubated both with biofilm-covered shells and with shells that were cleaned by thoroughly brushing them with a sterile toothbrush, although cleaning still left residues of biofilm in the grooves of the shell surface.

The accumulation of N₂O in the incubation vial was followed over a period of 4 to 6 h by regularly taking gas samples and analyzing them by gas chromatography. Samples from the Wadden Sea were measured with the GC 7890 (Agilent Technologies) with a CP-PoraPLOT Q column, and samples from Aarhus Bay with the GC-8A (Shimadzu) with a Porapak Q column. Both gas chromatographs were equipped with a ⁶³Ni electron capture detector. Injection volumes were 1 ml for the samples analyzed with the GC 7890, and 0.3 ml for samples analyzed with the GC-8A. After each headspace sampling,

the incubation vials were pressure-equilibrated with air by inserting a hypodermic needle through the septum for 1 s. On both GCs, calibration standards were prepared by adding known amounts of N₂O to N₂-flushed gas-tight bottles of known volume and analyzed repeatedly during the incubation. The linear part of the increase of the N₂O concentration in the incubation vials over time was used to calculate the potential N₂O emission rate per individual and per biomass. The dilution of the gas phase and the equilibrated distribution of N₂O between the gas and water phases (Weiss and Price 1980) were taken into account when calculating the potential N₂O emission rate. This rate corresponds to the net N₂O production rate (i.e., gross production less consumption) and thus also depends on N₂O levels. Since the N₂O reduction rate was not directly assessed, the initial and final N₂O concentrations in the incubation vials are reported in Table 2 so that the experiments can be reproduced.

Rate of total denitrification

To determine the potential rate of total denitrification (i.e., production of N₂+N₂O) in the shrimp gut, freshly killed *Litopenaeus vannamei* were dissected and the guts were incubated in an atmosphere of 10% acetylene and 90% dinitrogen gas. Acetylene inhibits the last step of denitrification (Sørensen 1978) and thus the accumulation of N₂O in the incubation vials is indicative of total denitrification. The linear increase of N₂O concentration in the incubation vials over time was used to calculate the potential total denitrification rate per gut.

Statistical analysis

The potential N₂O emission rates were tested for correlation with the species traits Feeding type, Habitat, Exoskeletal biofilm, and Weight using the statistical analysis software SPSS. The categories within the species traits Feeding type, Habitat, and Exoskeletal biofilm were ranked according to their hypothesized effects on N₂O emission rates and were transformed into a numerical code that could be used for correlation analysis (Table 3). The hypotheses were that the rate of N₂O emission is positively correlated to (1) the amount of ingested bacteria, (2) the availability of nitrate, and (3) the presence of a microbial biofilm growing on external surfaces of the animal. The ranking of the categories was based on the assumptions that (1) the amount

of ingested bacteria is determined by the feeding type and increases from carnivores over grazers and deposit-feeders to filter-feeders; (2) the nitrate concentration varies with habitat, being highest in the water column and lowest in the sediment; and (3) shell and exoskeleton provide colonization surfaces for microbial biofilms. The high rank of filter-feeders regarding the amount of ingested bacteria may be questioned because only few bivalve species filter unattached bacteria (e.g., *Mytilus edulis*, McHenery and Birkbeck 1985). However, species that filter-feed close to the sediment surface, where the concentration of suspended detritus is particularly high, ingest large amounts of attached bacteria (Kach and Ward 2008).

Table 3: Species traits and phenotypes used for statistical analysis of N₂O emission by marine invertebrates. Phenotypes were sorted according to their hypothesized promotion of N₂O production (*Hypothesis*) and then numerically coded (*Value*).

Species trait	Phenotype	Hypothesis	Value
Feeding type	Carnivore (predator + scavenger)	Increasing	0
	Grazer	number of N ₂ O-producing gut bacteria	1
	Deposit-feeder		2
	Filter-feeder		3
Habitat	Infaunal		Increasing nitrate
	Infaunal + epifaunal	availability	1
	Epifaunal		2
Exoskeletal biofilm	No		More biofilm
	Yes	bacteria	1

Results

The potential N₂O emission rates of coastal marine invertebrate species ranged from 0 to 1.354 nmol ind.⁻¹ h⁻¹ (Figure 1, Table 2) with an average rate of 0.320 nmol ind.⁻¹ h⁻¹. The weight-specific emission rates ranged from 0 to 0.598 nmol g⁻¹ h⁻¹ with an average rate of 598 nmol g⁻¹ h⁻¹ (Table 2). The highest potential N₂O emission rate of 3.569 nmol ind.⁻¹ h⁻¹ was found for the aquacultured shrimp *Litopenaeus vannamei* (not included in the above rates) that is exposed to very high

nitrate concentrations (≥ 1 mM) and to high temperatures (28-30°C) in the rearing tanks (Table 1). The N₂O emission rate of dissected guts of *L. vannamei* was almost as high as the N₂O emission rate of the whole animal (Figure 2). Dissected guts showed a total denitrification rate of 12 nmol ind.⁻¹ h⁻¹ under anoxic conditions (Figure 2).

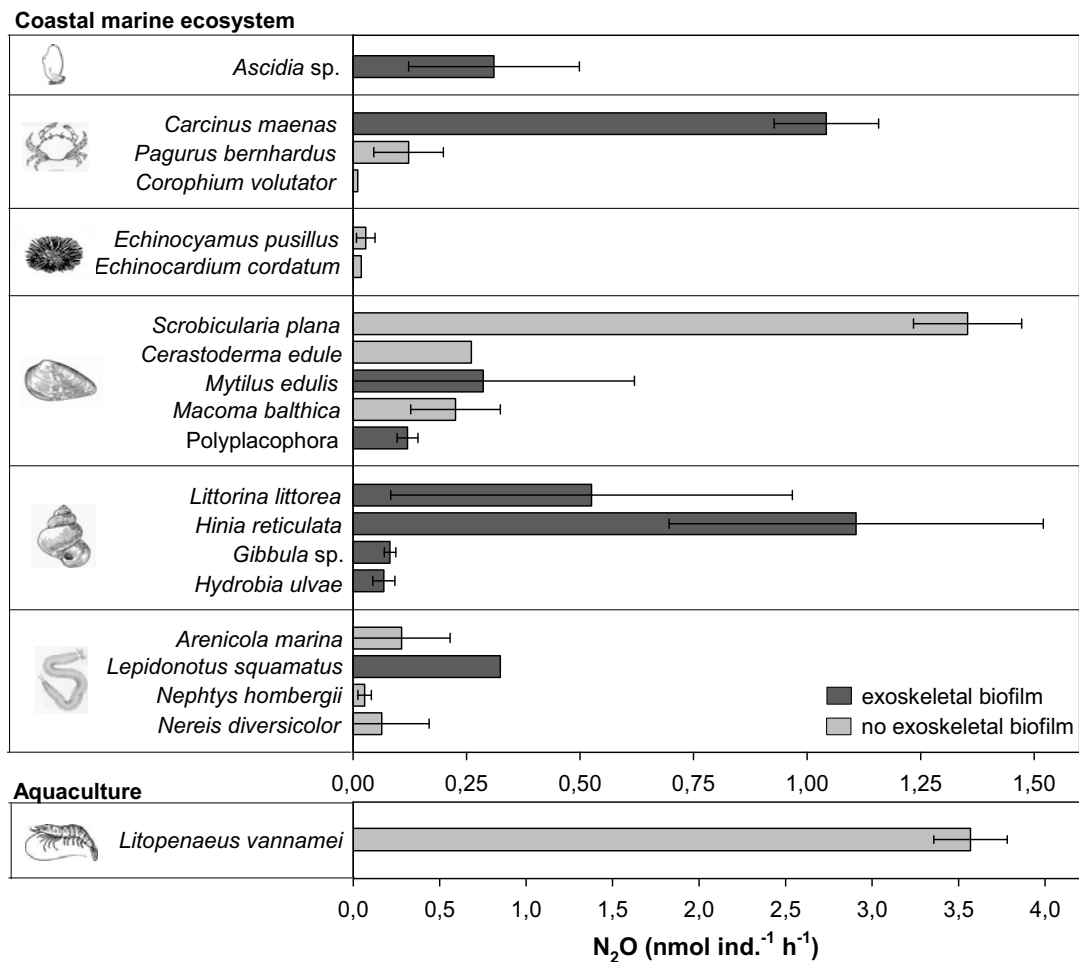

Figure 1: Potential N₂O emission rates of various marine invertebrate taxa. Individuals were incubated in gas-tight vials under oxic conditions at 21°C and N₂O emission was analysed by GC measurements over 4-6 h. Species are grouped taxonomically and within each taxonomic group, species are sorted by descending weight. For species with at least 3 replicates analysed, mean rates + s.d. are shown.

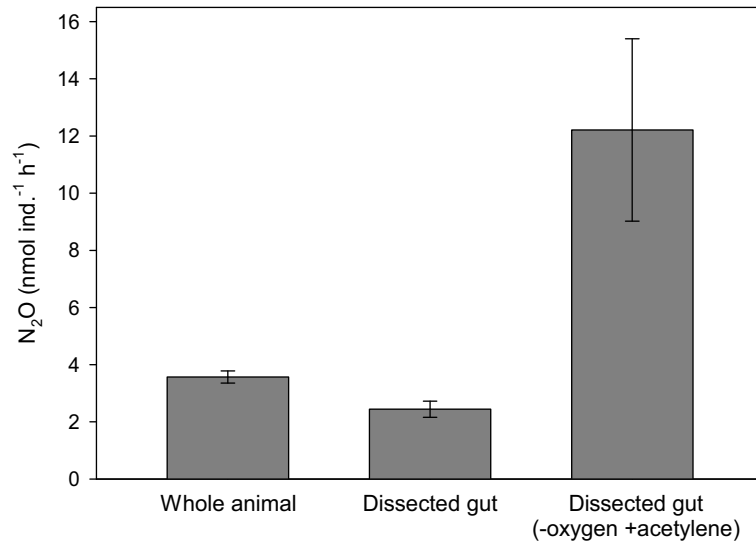

Figure 2: Potential N₂O emission by the shrimp *Litopenaeus vannamei* and its dissected guts under oxic conditions at 21°C. Dissected guts of *L. vannamei* were also incubated under anoxic conditions with 10% acetylene that inhibits the last step of denitrification. The resulting N₂O production indicates total denitrification. Means + s.d. are shown (n=3-6).

The nitrate concentrations at the sampling sites in the Wadden Sea and Aarhus Bay were low (0-20 µM), and temperature was 7-8°C (exception: 15-22°C at the Wadden Sea site in May 2008; Table 1). The capacity to emit N₂O occurred across all taxonomic groups and was not restricted to a certain feeding type (Table 1). Most species possessing a shell or exoskeleton had potential N₂O emission rates higher than the average rates (e.g., the common periwinkle *Littorina littorea* and the shore crab *Carcinus maenas*). These conclusions were also true when the rate of N₂O emission was expressed per gram body weight (Table 2). The potential N₂O emission rates per individual tended to be higher for larger species than for smaller species (e.g. the bivalves *Scrobicularia plana* vs. *Macoma balthica*), while the highest potential N₂O emission rates per gram body weight were shown by the smallest species (e.g. *Hydrobia ulvae*, *Corophium volutator*).

The correlation analysis revealed that the potential N₂O emission rate per individual was significantly positively correlated with the body weight with a Pearson coefficient of $R = 0.506$ ($p = 0.027$) for linear correlation and with a Spearman coefficient of $R = 0.728$ ($p < 0.001$) for non-linear correlation. The species-traits Habitat and Exoskeletal biofilm showed significant positive non-linear correlations with the potential N₂O emission rate per individual with Spearman coefficients of $R = 0.460$ ($p = 0.047$) and $R = 0.481$ ($p = 0.037$), respectively. No correlation between the potential N₂O emission rate and the feeding type was found (Spearman coefficient of $R = -0.135$, $p = 0.581$).

The importance of the species trait Exoskeletal biofilm was further highlighted by the comparison of the N₂O emission rates of the snail *Hinia reticulata*, which was measured both with the natural biofilm on the surface of the shell and with cleaned shell surfaces. The snails with an exoskeletal biofilm emitted more N₂O than the cleaned individuals during the incubation period of 4.5 h (Figure 3). The mean potential N₂O emission rate of the biofilm-covered individuals (1.108 nmol ind.⁻¹ h⁻¹) was about 3.5 times higher than the rate of the cleaned individuals (0.306 nmol ind.⁻¹ h⁻¹). The mean potential N₂O emission rate of biofilm-covered and cleaned individuals were assessed by a t-test and marginally failed significance with $p = 0.057$ ($T = -3.06$ and $df = 2.92$).

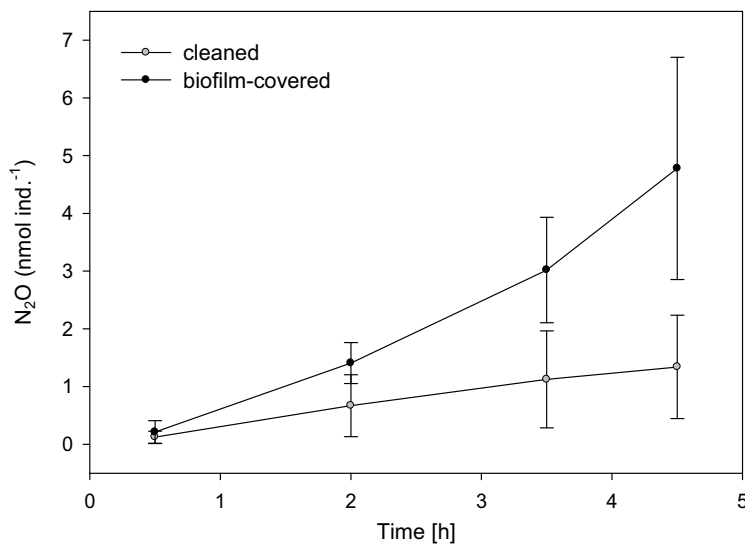

Figure 3: Potential N₂O emission by cleaned and biofilm-covered individuals of the snail *Hinia reticulata* during the incubation period of 4.5 h. Means + s.d. are shown (n=3).

Discussion

The present study revealed that many coastal marine invertebrate species emit N₂O, representing a source that have been overlooked. The average potential N₂O emission rate of 19 marine invertebrate species was 0.320 nmol ind.⁻¹ h⁻¹, excluding the aquacultured shrimp *Litopenaeus vannamei*, which had an exceptionally high rate. For 20 freshwater invertebrate species, an average potential N₂O emission rate of only 0.072 nmol ind.⁻¹ h⁻¹ was reported (Stief et al. 2009). In addition to the higher average rate, the N₂O emission potential of marine invertebrates is apparently influenced by species-specific traits (i.e., body weight, habitat, and presence of an exoskeletal biofilm)

that differ from those that influence the N₂O emission potential of freshwater species (i.e., feeding type) (Stief et al. 2009).

Correlation with species traits

At a first glance, the positive correlation with the body weight suggests that larger animals with presumably larger guts produce more N₂O than smaller animals because of the larger number of microbes passing their gut. This interpretation is consistent with the hypothesis that, in marine invertebrates, N₂O production is also mediated by ingested microbes, as is the case for earthworms and freshwater invertebrates (Drake et al. 2006, Stief et al. 2009). The correlation between potential N₂O emission rate and the presence of an exoskeletal biofilm suggests that N₂O production associated with marine invertebrates is not always due to denitrification in the gut (as proven for the aquacultured shrimp *Litopenaeus vannamei*), but may also result from microbial activity on external surfaces of the animal. Lower potential N₂O emission rates of individuals of the snail *Hinia reticulata* with an experimentally cleaned shell surface further substantiate that N₂O production is also linked to microbial activities in the exoskeletal biofilm. Furthermore, for this type of animal-associated N₂O production, the shell of larger animals is presumably colonized with larger numbers of bacteria involved in N₂O production, which is in line with the weight-dependence of N₂O emission. The microbial pathway for biofilm-associated N₂O production still needs to be identified. Depending on the oxygen availability inside the biofilm, nitrification or denitrification or both might contribute to the production of N₂O (Meyer et al. 2008). Likewise, N₂O production in the exoskeletal biofilm might be driven by ammonium from animal excretion or by nitrate from the water column, or by both. If an oxic-anoxic transition zone prevails in the biofilm, then nitrification and denitrification are probably coupled, as known for sediments in which denitrification is driven by nitrate from nitrification (Jenkins and Kemp 1984). Thick biofilms were not established on the exoskeleton of every molluscan and crustacean species tested in the present study. The exoskeleton of *Corophium volutator*, *Pagurus bernhardus*, and *Litopenaeus vannamei*, for instance, may not allow the formation of a persistent biofilm due to rather short time intervals between molting events, and the shells of infaunal molluscs (i.e., *Macoma balthica*, *Cerastoderma edule* and *Scrobicularia plana*) may not be suitable for the formation of an exoskeletal biofilm due to physical abrasion in the sediment. It remains to be

investigated whether certain freshwater invertebrate species have persistent biofilms on external surfaces of their body that produce N₂O.

Habitat (a proxy for the nitrate availability in the immediate environment of the animal) was also significantly correlated with the N₂O emission rate. The high potential emission rate of the epifaunal shrimp *Litopenaeus vannamei*, which is exposed to very high nitrate concentrations, agrees with this assumption. The effect of the habitat on N₂O emission could be greater during autumn and winter, when nitrate concentrations in the water column at the 2 study sites are higher than in spring and summer (Kieskamp et al. 1991, Sømud 2005) and most of the studied animals are also abundant and active. Additionally, the habitat of marine macrofauna may have an influence on the formation of exoskeletal biofilms. Epifaunal species are expected to carry thicker and more persistent biofilms on their external surfaces than infaunal species because of lower abrasion forces in the water column. This interaction of “habitat” and “exoskeletal biofilm” is supported by our observations on, for instance, *Littorina littorea* (epifaunal, visible biofilm, high N₂O emission potential) vs. *Macoma balthica* (infaunal, no visible biofilm, lower N₂O emission potential).

N₂O emission rate and species feeding type and diet were not correlated, which contrasts with the finding that N₂O emission of freshwater invertebrates is diet-dependent (Stief et al. 2009). Since marine species are usually larger and have longer guts and gut residence times than the freshwater species (Bayne et al. 1987, Navarro et al. 1993), bacteria might be exposed long enough to anoxic conditions in the gut to express the full set of denitrification genes. In that case, complete denitrification will prevail and the main product will be dinitrogen rather than N₂O. Conversely, many of the ingested sediment bacteria might be efficiently digested in the gut of marine detritivorous species due to a high lysozyme activity (Lucas and Bertru 1997, Plante and Mayer 1994), which inhibits microbial N₂O production. Lysozyme activity of dissected guts was approximately 5 times higher for the ragworm *Nereis diversicolor* (a marine non-emitter) than for the mayfly larva *Ephemera danica* (a freshwater emitter) (P. Stief unpublished results).

Ecosystem perspective

Many species tested positive for N₂O emission in the present study are very abundant in coastal soft-bottom habitats; *Macoma balthica* and *Cerastoderma edule* can reach densities of 1000 ind. m⁻² (Fujii 2007), *Scrobicularia plana* 250 ind. m⁻² (Cabral and Murta 2004), and *Arenicola marina* 100 ind. m⁻² (Flach and Beukema 1994). The mud snail *Hydrobia ulvae* can reach densities of up to 100 000 ind. m⁻² in intertidal sediments (Barnes 1999). This epifaunal species emits N₂O directly into the water column or the atmosphere without diffusion through the sediment, as it lives at the sediment surface where it can be exposed to high nitrate concentrations and temperatures. Taking its potential N₂O emission rate of 0.068 nmol ind.⁻¹ h⁻¹, this small snail could emit 6.8 μmol N₂O m⁻² h⁻¹, which is on the same order of magnitude as the benthic N₂O fluxes reported for estuarine intertidal sediments (Middelburg et al. 1995) and intertidal rocky biofilms (Magalhaes et al. 2005). For infaunal species, extrapolations are less robust because N₂O conversion may also take place inside the burrows of the animals (Stief and Schramm 2010). N₂O produced by certain infaunal species might be partially consumed while diffusing towards the sediment surface (Meyer et al. 2008), whereas other infaunal species could increase the benthic N₂O flux much more by their bioirrigation activity than by stimulating N₂O production in their gut or in exoskeletal biofilms (Stief and Schramm 2010). A second difficulty in scaling up animal-associated N₂O production to ecosystem level lies in the discrepancy between potential and *in situ* rates. The contribution of animal-associated N₂O production to overall benthic N₂O emission can be better estimated from rate measurements made at different times of the year at the prevailing environmental conditions (Stief et al. 2010, Stief and Schramm 2010). A rather constant N₂O emission rate can be expected for the aquacultured species *Litopenaeus vannamei*, since it is exposed to the same conditions throughout the year. Given its very high potential N₂O emission rate and the high growth rates of the aquaculture industry, N₂O emission by other aquacultured species should be investigated.

Conceptually, N₂O production associated with marine and freshwater invertebrates constitutes a link between reactive nitrogen (i.e., nitrate and ammonium) in aquatic ecosystems and N₂O in the atmosphere that has been overlooked. Aquatic invertebrates complement the known sites of N₂O production in the sediment with 3 additional

microsites of N₂O production: 1) the anoxic gut, a transient microbial habitat in which denitrification prevails (Stief et al. 2009); 2) the burrow, a microbial habitat with fluctuating conditions in which nitrification and denitrification co-occur (Svensson 1998); and 3) the exoskeletal biofilm, a microbial habitat with a yet unknown microenvironment in which nitrification and/or denitrification might occur (present study). The environmental controls of sedimentary and animal-associated N₂O production might be similar (e.g. higher N₂O production rates at higher temperature and nitrate or ammonium concentrations) and require further investigation.

Acknowledgements

We thank Hans Brix for providing the gas chromatograph. We are grateful for the help and assistance of Torben Vang and Leif Flensburg, the crew of the research vessel ‘Genetica II’ (Aarhus University). This research was supported by the Max Planck Society, the Danish Research Council and the German Science Foundation (STI202/6).

References

- Barnes RSK (1999) What determines the distribution of coastal hydrobiid mudsnails within north-western Europe? *Mar Ecol-Evol Persp* 20:97–110
- Bange HW (2006) New directions: The importance of oceanic nitrous oxide emissions. *Atmos Environ* 40:198–199
- Bayne BL, Hawkins AJS, Navarro E (1987) Feeding and digestion by the mussel *Mytilus edulis* L. (Bivalvia: Mollusca) in mixtures of silt and algal cells at low concentrations. *J Exp Mar Biol Ecol* 3:1-22
- Bonin P, Raymond N (1990) Effects of oxygen on denitrification in marine sediments. *Hydrobiologia* 207:115–122
- Braman RS, Hendrix SA (1989) Nanogram nitrite and nitrate determination in environmental and biological materials by Vanadium(III) reduction with chemiluminescence detection. *Anal Chem* 61:2715-2718
- Cabral HN, Murta AG (2004) Effect of sampling design on abundance estimates of benthic invertebrates in environmental monitoring studies. *Mar Ecol Prog Ser* 276:19-24
- Dong LF, Nedwell DB, Underwood GJC, Thornton DCO, Rusmana I (2002) Nitrous oxide formation in the Colne estuary, England: The central role of nitrite. *Appl Environ Microbiol* 68:1240–1249
- Drake HL, Schramm A, Horn MA (2006) Earthworm gut microbial biomes: Their importance to soil microorganisms, denitrification, and the terrestrial production of the greenhouse gas N₂O. In: *Soil Biology, Volume 6: Intestinal Microorganisms of Soil Invertebrates*, König H, Varma A (Eds.), Springer-Verlag Berlin Heidelberg, p.65-87.
- Drake HL, Horn MA (2007) As the worm turns: The earthworm gut as a transient habitat for soil microbial biomes. *Ann Rev Microbiol* 61:169–189
- Ferrón S, Alonso-Pérez F, Anfuso E, Murillo FJ, Ortega T, Castro CG, Forja JM (2009) Benthic nutrient recycling on the northeastern shelf of the Gulf of Cádiz (SW Iberian Peninsula). *Mar Ecol Prog Ser* 390:79-95
- Flach EC, Beukema JJ (1994) Density-governing mechanisms in populations of the lugworm *Arenicola marina* on tidal flats. *Mar Ecol Prog Ser* 115:139–149
- Fujii T (2007) Spatial patterns of benthic macrofauna in relation to environmental variables in an intertidal habitat in the Humber estuary, UK: Developing a tool for estuarine shoreline management. *Estuar Coast Shelf S* 75:101–119
- Goreau TJ, Kaplan WA, Wofsy SC, McElroy MB, Valois FW, Watson SW (1980) Production of NO₂⁻ and N₂O by nitrifying bacteria at reduced concentrations of oxygen. *Appl Environ Microbiol* 40:526-532
- Intergovernmental Panel on Climate Change (2007) *Climate Change 2007: The Physical Science Basis - Summary for Policy Makers* (World Meteorological Organization/United Nations Environmental Programme, Paris).
- Jenkins MC, Kemp WM (1984) The coupling of nitrification and denitrification in two estuarine sediments. *Limnol Oceanogr* 29:609-619
- Kach DJ, Ward JE (2008) The role of marine aggregates in the ingestion of picoplankton-size particles by suspension-feeding mollusks. *Mar Biol* 153:797-805

- Karsten GR, Drake HL (1997) Denitrifying bacteria in the earthworm gastrointestinal tract and in vivo emission of nitrous oxide (N₂O) by earthworms. *Appl Environ Microbiol* 63:1878–1882
- Kieskamp WM, Lohse L, Epping E, Helder W (1991) Seasonal variation in denitrification rates and nitrous oxide fluxes in intertidal sediments of the western Wadden Sea. *Mar Ecol Prog Ser* 72:145–151
- Law CS, Rees AP, Owens NJP (1992) Nitrous oxide - Estuarine sources and atmospheric flux. *Estuar Coast Shelf S* 35:301-314
- Lucas F, Bertru G (1997) Bacteriolysis in the gut of *Nereis diversicolor* (O.F. Muller) and effect of the diet. *J Exp Mar Biol Ecol* 215:235-245
- Magalhaes CM, Wiebe WJ, Joye SB, Bordalo A (2005) Inorganic nitrogen dynamics in intertidal rocky biofilms and sediments of the Douro River estuary (Portugal) *Estuaries* 28:592-607
- Magalhaes C, Costa J, Teixeira C, Bordalo AA (2007) Impact of trace metals on denitrification in estuarine sediments of the Douro River estuary, Portugal. *Mar Chem* 107:332-341
- Matthies C, Griesshammer A, Schmittroth M, Drake HL (1999). Evidence for involvement of gut-associated denitrifying bacteria in emission of nitrous oxide (N₂O) by earthworms obtained from garden and forest soils. *Appl Environ Microbiol* 65:3599-3604
- McHenry JG, Birkbeck TH (1985) Uptake and processing of cultured microorganisms by bivalves. *J Exp Mar Biol Ecol* 90:145–163
- Meyer RL, Allen DE, Schmidt S (2008) Nitrification and denitrification as sources of sediment nitrous oxide production: A microsensor approach. *Mar Chem* 110:68-76
- Middelburg JJ, Klaver G, Nieuwenhuize J, Markusse RM, Vlug T, Vandernat F (1995) Nitrous oxide emissions from estuarine intertidal sediments. *Hydrobiologia* 311:43-55
- Mosier A, Kroeze C, Nevison C, Oenema O, Seitzinger S, Van Cleemput O (1998) Closing the global N₂O budget: nitrous oxide emissions through the agricultural nitrogen cycle - OECD/IPCC/IEA phase II development of IPCC guidelines for national greenhouse gas inventory methodology. *Nutr Cycl Agroecosys* 52:225-248.
- Navarro E, Iglesias JIP, Ortega MM, Larretxea X (1993) The basis for a functional response to variable food quantity and quality in cockles *Cerastoderma edule* (Bivalvia, Cardiidae) *Physiol Zool* 67:468-496
- Philippart CJM, Beukema JJ, Cadee GC (2007) Impacts of nutrient reduction on coastal communities. *Ecosystems* 10:95–118
- Plante CJ, Mayer LM (1994) Distribution and efficiency of bacteriolysis in the gut of *Arenicola marina* and 3 additional deposit feeders. *Mar Ecol Prog Ser* 109:183–194
- Ravishankara AR, Daniel JS, Portmann RW (2009) Nitrous Oxide (N₂O): The dominant ozone-depleting substance emitted in the 21st century. *Science* 326:123–125
- Robinson AD, Nedwell DB, Harrison RM, Ogilvie BG (1998) Hypernutrified estuaries as sources of N₂O emission to the atmosphere: the estuary of the River Colne, Essex, UK. *Mar Ecol Prog Ser* 164:59-71
- Seitzinger SP (1988) Denitrification in freshwater and coastal marine ecosystems: Ecological and geochemical significance. *Limnol Oceanogr* 33:702-724

- Seitzinger SP, Nixon SW (1985) Eutrophication and the rate of denitrification and N₂O production in coastal marine sediments. *Limnol Oceanogr* 30:1332–1339
- Seitzinger SP, Kroeze C (1998) Global distribution of nitrous oxide production and N inputs in freshwater and coastal marine ecosystems. *Global Biogeochem Cy* 12:93–113
- Sømod B (2005) Århus Bugt Tilstand og udvikling 2004 (*Aarhus Bay state and development 2004*) Aarhus Amt Natur and Miljø, Højbjerg
- Sørensen J (1978) Denitrification rates in a marine sediment as measured by the acetylene inhibition technique. *Appl Environ Microbiol* 36:139–143
- Stein LY, Yung YL (2003) Production, isotopic composition, and atmospheric fate of biologically produced nitrous oxide. *Annu Rev Earth Pl Sc* 31:329–356
- Stief P, Poulsen M, Nielsen LP, Brix H, Schramm A (2009) Nitrous oxide emission by aquatic macrofauna. *Proc Natl Acad Sci U.S.A.* 106:4296–4300
- Stief P, Polerecky L, Poulsen M, Schramm A (2010) Control of nitrous oxide emission from *Chironomus plumosus* larvae by nitrate and temperature. *Limnol Oceanogr* 55:872–884
- Stief P, Schramm A (2010) Regulation of nitrous oxide emission associated with benthic invertebrates. *Freshwat Biol*, *in press*
- Svensson JM (1998) Emission of N₂O, nitrification and denitrification in a eutrophic lake sediment bioturbated by *Chironomus plumosus*. *Aquat Microb Ecol* 14:289–299
- Tiedje JM (1988) Ecology of denitrification and dissimilatory nitrate reduction to ammonium. *Biology of anaerobic microorganisms*. A. J. B. Zehnder. New York, John Wiley and Sons: p. 179–244
- Van Beusekom JEE, Weigelt-Krenz S, Martens P (2008) Long-term variability of winter nitrate concentrations in the Northern Wadden Sea driven by freshwater discharge, decreasing riverine loads and denitrification. *Helgol Mar Res* 62:49–57
- Weiss RF, Price BA (1980) Nitrous oxide solubility in water and seawater. *Mar Chem* 8:347–359
- Williams ID, Van der Meer J, Dekker R (2004) Exploring interactions among intertidal macrozoobenthos of the Dutch Wadden Sea using population growth models. *J Sea Res* 52:307–319
- Zumft WG (1997) Cell biology and molecular basis of denitrification. *Microbiol Mol Biol R* 61:533–616

Chapter 3

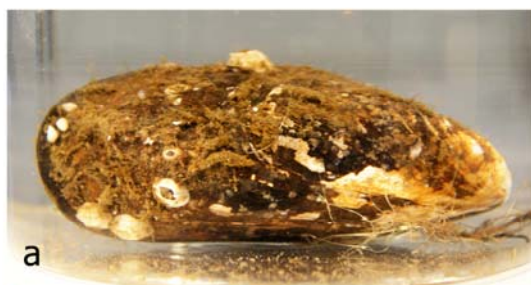

Marine mollusc species that were investigated for nitrous oxide production in shell biofilms

- (a) *Mytilus edulis* (Blue Mussel)
- (b) *Littorina littorea* (Common Periwinkle)
- (c) *Hinia reticulata* (Netted Dog Welk)

**Shell biofilm-associated nitrous oxide
production in marine molluscs:
processes, precursors and relative importance**

Ines M. Heisterkamp¹, Andreas Schramm², Lone H. Larsen²,
Nanna B. Svenningsen², Gaute Lavik¹, Dirk de Beer¹, Peter Stief¹

¹Max Planck Institute for Marine Microbiology, Microsensor Group,
Celsiusstraße 1, 28359 Bremen, Germany

²Department of Bioscience, Microbiology, Aarhus University,
Ny Munkegade 114, DK-8000 Aarhus C, Denmark

Accepted in *Environmental Microbiology*

Abstract

Emission of the greenhouse gas nitrous oxide (N₂O) from freshwater and terrestrial invertebrates has exclusively been ascribed to N₂O production by ingested denitrifying bacteria in the anoxic gut of the animals. Our study of marine molluscs now shows that also microbial biofilms on shell surfaces are important sites of N₂O production. The shell biofilms of *Mytilus edulis*, *Littorina littorea*, and *Hinia reticulata* contributed 18-94% to the total animal-associated N₂O emission. Nitrification and denitrification were equally important sources of N₂O in shell biofilms as revealed by ¹⁵N-stable isotope experiments with dissected shells. Microsensor measurements confirmed that both nitrification and denitrification can occur in shell biofilms due to a heterogeneous oxygen distribution. Accordingly, ammonium, nitrite, and nitrate were important drivers of N₂O production in the shell biofilm of the three mollusc species. Ammonium excretion by the animals was found to be sufficient to sustain N₂O production in the shell biofilm. Apparently, the animals provide a nutrient-enriched microenvironment that stimulates growth and N₂O production of the shell biofilm. This animal-induced stimulation was demonstrated in a long-term microcosm experiment with the snail *H. reticulata*, where shell biofilms exhibited the highest N₂O emission rates when the animal was still living inside the shell.

Introduction

Nitrous oxide (N₂O) is a highly potent greenhouse gas that significantly contributes to global warming (Forster et al., 2007) and to the destruction of the stratospheric ozone layer (Ravishankara et al., 2009). This atmospheric trace gas is mainly produced in soils, sediments and water bodies by nitrifying and denitrifying bacteria (Mosier et al., 1998; Stein and Yung, 2003). Ammonia-oxidizing bacteria and archaea (AOB and AOA) produce N₂O during the oxidation of NH₄⁺ to NO₂⁻ the first step of nitrification (Goreau et al., 1980; Santoro et al., 2011), and during “nitrifier denitrification”, a process in which NH₄⁺ is oxidized to NO₂⁻ that is subsequently reduced to NO, N₂O and sometimes N₂ (Ritchie and Nicholas, 1972; Poth and Focht, 1985; Bock et al., 1995). Heterotrophic denitrifying bacteria produce N₂O as an intermediate when reducing NO₃⁻ or NO₂⁻ via NO and N₂O to N₂ under suboxic or anoxic conditions (Zumft, 1997).

High N₂O emission rates have been reported for earthworms and several freshwater and marine invertebrates (Karsten and Drake, 1997; Stief et al., 2009; Heisterkamp et al., 2010). The N₂O production associated with these invertebrates has been attributed to incomplete denitrification in the gut of the animals. The gut microenvironment of N₂O-emitting animals is characterised by anoxia and the availability of nitrate and labile organic carbon sources, and thus stimulates the denitrification activity of ingested microorganisms (Horn et al., 2003; Stief and Eller, 2006). Accordingly, N₂O emission from freshwater invertebrates largely depends on the amount of ingested bacteria, which varies with the feeding-type of the animal (Stief et al., 2009), and on the nitrate concentration (Stief et al., 2010; Stief and Schramm, 2010). For marine invertebrates, however, N₂O emission rate and feeding type were not correlated (Heisterkamp et al., 2010). Instead, N₂O emission rate was marginally correlated with the presence of a microbial biofilm on external surfaces of the animals (Heisterkamp et al., 2010). These findings suggested that N₂O emission by marine invertebrates may not only be due to N₂O production by denitrifying bacteria in the gut, but also due to N₂O production in microbial biofilms on the shell or exoskeleton of the animals.

The objectives of this study were therefore to (i) quantify the contribution of the shell biofilm to total N₂O emission from marine molluscs, (ii) quantify the contribution of nitrification and denitrification to N₂O production in shell biofilms, and (iii) assess the effect of the animal itself on N₂O production in shell biofilms. To this end, short-term measurements with freshly collected specimens, stable isotope incubations of dissected shells, and long-term sediment-microcosm experiments were conducted with three marine mollusc species, *Mytilus edulis* (Blue Mussel), *Littorina littorea* (Common Periwinkle), and *Hinia reticulata* (Netted Dog Welk). These molluscs typically possess a shell biofilm and are common in marine coastal environments of the North Atlantic and Baltic Sea.

Material and Methods

Sampling of animals

We collected three marine mollusc species that inhabit different habitats in the North Atlantic and Baltic Sea and exhibit distinct feeding-modes (Table 1). The snail *Littorina littorea* was sampled from a mixed intertidal flat near Dorum-Neufeld in the German Wadden Sea (N53° 44' 3.733" E8° 30' 24.201"). The mussel *Mytilus edulis* and the snail *Hinia reticulata* were collected in Aarhus Bay, Denmark. *M. edulis* was taken from the mole of Marselisborg Harbor in Aarhus (N56° 8' 16.875" E10° 13' 3.945") and *H. reticulata* from a very shallow part of Aarhus Bay close to Skaering (N56° 13' 39.045" E10° 18' 51.154"). Animals were kept in buckets filled with aerated seawater and a thin layer of sediment from the sampling site (*M. edulis* only in seawater) until used for experiments in the laboratory. All experiments were performed within 2 days after sampling.

Table 1: Characteristics of the three mollusc species. Wet weight of the whole animal and dissected shell, as well as NH₄⁺ excretion rate of the animal are listed as means (\pm SD), n = 4-62.

	<i>Mytilus edulis</i> (Blue Mussel)	<i>Littorina littorea</i> (Common Periwinkle)	<i>Hinia reticulata</i> (Netted Dog Whelk)
Taxonomic class	Bivalvia	Gastropoda	Gastropoda
Feeding type	Filter-feeder	Grazer	Scavenger
Habitat	Intertidal rocks	Intertidal sediments & rocks	Sublittoral sandy sediments
Weight of whole animal (g)	20.7 (1.8)	1.9 (0.1)	1.5 (0.7)
Weight of dissected shell (g)	13.7 (2.9)	1.4 (0.1)	0.9 (0.3)
NH₄⁺ excretion rate (nmol g⁻¹ h⁻¹)	64 (36)	27 (13)	154 (110)
NH₄⁺ excretion rate (nmol ind⁻¹ h⁻¹)	969 (549)	69 (16)	271 (191)

Nitrous oxide emission rates of whole animals and their dissected shells

N₂O emission rates of freshly collected, living animals and of the animals' shell were measured by incubating whole animals or dissected shells in gas-tight vials and following N₂O production over 4 h. Shells were dissected from living animals by cracking the shell and carefully removing the animal tissue with ethanol-rinsed forceps and scalpels taking care not to damage the shell biofilm. Artificial seawater was prepared by dissolving Red Sea salt (Red Sea Fish Farm Ltd. Eilat, Israel) in autoclaved MilliQ water to the *in situ* salinity of 22 psu, aerated over night, adjusted to pH 8.2, and amended with 50 μ M NH₄⁺ and 50 μ M NO₃⁻. Ammonium concentration was thus higher than the typical water column concentration, but nitrate concentration was in the range of naturally occurring concentrations (van Beusekom and de Jonge, 2002; van Beusekom et al., 2008). Whole animals and dissected shells of *M. edulis* and *L. littorea* were incubated in 100-ml Duran bottles filled with 50 ml and 30 ml of artificial seawater, respectively, and sealed with rubber stoppers. Whole animals and dissected shells of *H. reticulata* were incubated in gas-tight 12-ml Exetainer vials (Labco, High Wycombe, UK), to which 3 ml of seawater was added. The remaining headspace consisted in all cases of atmospheric air. Additionally, dissected shells of the three

species were incubated in artificial seawater that contained 2% of ZnCl₂ (50% w/v) to inhibit biological activity. For each species, 3-8 replicates were run with either 1-2 individuals or dissected shells per incubation vial (*M. edulis* and *H. reticulata*) or 5-8 individuals and 8-11 dissected shells per incubation vial (*L. littorea*). Vials were placed on a shaker during incubation to enforce the equilibration of N₂O between water and headspace and were shaded from direct daylight (light intensity approximately 5 μmol photons m⁻² s⁻¹). All incubations were made in a temperature-controlled laboratory at 21°C. Analysis of N₂O production by gas chromatography (GC 7890 Agilent Technologies) and calculation of N₂O emission rates were performed as described in Heisterkamp et al. (2010).

¹⁵N-stable isotope experiments with dissected shells

For each species, dissected shells were incubated in three different ¹⁵N-tracer treatments that were designed to specifically ascribe the production of the double-labelled ⁴⁶N₂O (¹⁵N¹⁵NO) to nitrification, denitrification of nitrate and denitrification of nitrite (Table 2). To be able to distinguish between N₂O production by nitrification and N₂O production by coupled nitrification-denitrification or nitrifier denitrification, a ten times higher ¹⁴NO₂⁻ than ¹⁵NH₄⁺ concentration was added to the nitrification treatment. Any ¹⁵NO₂⁻ generated from nitrification is thus diluted by the high ¹⁴NO₂⁻ concentration, which makes the combination of two ¹⁵NO₂⁻ and subsequent ⁴⁶N₂O production via coupled nitrification-denitrification or nitrifier denitrification very unlikely. The double-labelled ⁴⁶N₂O can thus be ascribed to the combination of two ¹⁵NH₄⁺ and is indicative of nitrification. The single-labelled ⁴⁵N₂O (¹⁵N¹⁴NO) could have been produced by random pairing of ¹⁵NH₄⁺ with unlabelled ¹⁴NH₄⁺ that were present or produced in the biofilm, or by coupled nitrification-denitrification and nitrifier denitrification that combine one ¹⁵N from ¹⁵NH₄⁺ with one ¹⁴N from ¹⁴NO₃⁻ or ¹⁴NO₂⁻ to form ⁴⁵N₂O. In the denitrification treatment, any ⁴⁶N₂O production must have exclusively resulted from the combination of two ¹⁵NO₃⁻ ions. ⁴⁵N₂O was produced by random pairing of ¹⁵NO₃⁻ and ¹⁴NO₃⁻ or ¹⁴NO₂⁻ that were present or produced in the biofilm.

Table 2: Stable isotope incubations made with dissected shells of *M. edulis*, *L. littorea* and *H. reticulata*. Listed are the concentrations of ¹⁵N and ¹⁴N that were added to each treatment, the required combinations of ¹⁴N and ¹⁵N to form ⁴⁵N₂O and ⁴⁶N₂O, and the probabilities of the formation of ⁴⁴N₂O, ⁴⁵N₂O and ⁴⁶N₂O assuming random isotope pairing of the uniformly mixed ¹⁴N and ¹⁵N species. ¹⁴NO_x⁻ includes ¹⁴NO₂⁻ and ¹⁴NO₃⁻ that were added to the incubations, already present or produced in the shell biofilms. In the nitrification treatment, ⁴⁵N₂O could also have been produced by the combination of labelled ¹⁵NH₄⁺ and unlabelled ¹⁴NH₄⁺ that was already present or produced in the shell biofilms.

Treatment	¹⁵ N tracer	¹⁴ N added	⁴⁵ N ₂ O	⁴⁶ N ₂ O	Random isotope pairing
Nitrification	¹⁵ NH ₄ ⁺ (50 μM)	¹⁴ NO ₂ ⁻ (500 μM)	¹⁴ NH ₄ ⁺ / ¹⁴ NO _x ⁻ + ¹⁵ NH ₄ ⁺	¹⁵ NH ₄ ⁺ + ¹⁵ NH ₄ ⁺	$[500 \times {}^{14}\text{NO}_2^-]^2 + 2[500 \times {}^{14}\text{NO}_2^-][50 \times {}^{15}\text{NH}_4^+] + [50 \times {}^{15}\text{NH}_4^+]^2$
Denitrification of nitrate	¹⁵ NO ₃ ⁻ (50 μM)	–	¹⁴ NO _x ⁻ + ¹⁵ NO ₃ ⁻	¹⁵ NO ₃ ⁻ + ¹⁵ NO ₃ ⁻	$[50 \times {}^{15}\text{NO}_3^-]^2$
Denitrification of nitrite	¹⁵ NO ₂ ⁻ (50 μM)	¹⁴ NO ₃ ⁻ (500 μM)	¹⁴ NO _x ⁻ + ¹⁵ NO ₂ ⁻	¹⁵ NO ₂ ⁻ + ¹⁵ NO ₂ ⁻	$[500 \times {}^{14}\text{NO}_3^-]^2 + 2[500 \times {}^{14}\text{NO}_3^-][50 \times {}^{15}\text{NO}_2^-] + [50 \times {}^{15}\text{NO}_2^-]^2$

In the $^{15}\text{NO}_2^-$ treatment, a ten-fold higher $^{14}\text{NO}_3^-$ than $^{15}\text{NO}_2^-$ concentration was added to dilute the $^{15}\text{NO}_3^-$ generated from nitrification and thereby make random pairing of two $^{15}\text{NO}_3^-$ and subsequent production of $^{46}\text{N}_2\text{O}$ via denitrification of nitrate very unlikely. The $^{46}\text{N}_2\text{O}$ production can thus be ascribed to denitrification of nitrite. The single-labelled $^{45}\text{N}_2\text{O}$ was produced by the combination of $^{15}\text{NO}_2^-$ with $^{14}\text{NO}_3^-$ and/or $^{14}\text{NO}_2^-$ that were present or produced in the biofilms. Assuming random isotope pairing of the uniformly mixed ^{14}N and ^{15}N species, the probabilities of the formation of $^{44}\text{N}_2\text{O}$, $^{45}\text{N}_2\text{O}$ and $^{46}\text{N}_2\text{O}$ can be calculated as follows $[^{14}\text{N}]^2 + 2[^{14}\text{N}][^{15}\text{N}] + [^{15}\text{N}]^2$, in analogy to the formula used by Nielsen (1992) to calculate the production of $^{28}\text{N}_2$ from the $^{29}\text{N}_2$ and $^{30}\text{N}_2$ production ratio. The ^{14}N to ^{15}N ratio of 10 in the $^{15}\text{NH}_4^+$ and $^{15}\text{NO}_2^-$ treatments, should thus result in a $^{44}\text{N}_2\text{O}:$ $^{45}\text{N}_2\text{O}:$ $^{46}\text{N}_2\text{O}$ ratio of 100:20:1 ($[10\ ^{14}\text{N}]^2 + 2[10\ ^{14}\text{N}][^{15}\text{N}] + [1\ ^{15}\text{N}]^2$).

Three replicates per species and treatment were set up by dissecting shells of freshly sampled animals as described above and incubating them in 100-ml Duran bottles that were filled with 100 ml autoclaved and aerated artificial seawater and sealed gas-tight with rubber stoppers. The remaining bottle volume of 25 ml contained atmospheric air to ensure that the oxygen concentration in the vial did not drop below 50% air-saturation (tested by microsensor measurements after incubations). For *L. littorea* and *H. reticulata*, 5-7 shells were incubated per vial, for *M. edulis* one individual shell per vial. Wet weights of dissected shells were determined before starting the incubations. The dissected shells were incubated on a shaker for 6 h at 21°C and low light conditions (approximately $5\ \mu\text{mol photons m}^{-2}\ \text{s}^{-1}$). At time points 0, 1, 2, 3, 4 and 6 h, water samples (3 ml) were taken with a syringe and transferred to 6-ml He-flushed exetainers prefilled with 0.1 ml saturated HgCl_2 . The water volume withdrawn from the incubation vial was replaced with the respective ^{15}N tracer solution to avoid under-pressure in the vials. Each exetainer was spiked with 25 μl non-labelled N_2O to be above the detection limit of the mass spectrometer. The equilibrated headspace of the exetainer was then analyzed for $^{44}\text{N}_2\text{O}$, $^{45}\text{N}_2\text{O}$ and $^{46}\text{N}_2\text{O}$ concentrations by gas chromatography-isotope ratio mass spectrometry (GC-IRMS; VG Optima, Manchester, UK). The excess concentrations of $^{45}\text{N}_2\text{O}$ and $^{46}\text{N}_2\text{O}$ were calculated from the ratios $^{45}\text{N}_2\text{O}:$ $^{44}\text{N}_2\text{O}$ and $^{46}\text{N}_2\text{O}:$ $^{44}\text{N}_2\text{O}$ using a 100% N_2O standard in analogy to the air standard used in the isotope pairing technique of Nielsen (1992) where the excess of $^{29}\text{N}_2$ or $^{30}\text{N}_2$ is determined from the $^{29}\text{N}_2:$ $^{28}\text{N}_2$ and $^{30}\text{N}_2:$ $^{28}\text{N}_2$ ratios, respectively. The linear increase of

excess ⁴⁵N₂O and ⁴⁶N₂O over time was used to calculate ⁴⁵N₂O and ⁴⁶N₂O net production rates taking the dilution of the water phase and the equilibrated distribution of N₂O between the water and gas phases (Weiss and Price, 1980) into account.

Nitrous oxide production in shell biofilms in relation to nitrification and denitrification rates

The N₂O production rates of dissected shells were measured under (a) oxic atmosphere and addition of 50 μM NH₄⁺ (nitrification assay), and (b) anoxic atmosphere and addition of 50 μM NO₃⁻ (denitrification assay). Both assays were set up in 100-ml Duran bottles filled with 20-30 ml aerated or He-flushed artificial seawater and were sealed with rubber stoppers. The headspace of the oxic and anoxic incubation assays was air and He gas, respectively. Analysis of N₂O by gas chromatography and calculation of N₂O production rates were made as described above.

Potential ammonium oxidation rates of shells were measured by incubating freshly dissected shells in 20 ml (60 ml for *M. edulis*) aerated artificial seawater containing 50 μM NH₄⁺ and 20 mM NaClO₃. The oxidation of nitrite to nitrate in nitrification is inhibited by NaClO₃ (Belser and Mays, 1980). Nitrite production is thus indicative of ammonium oxidation, since the produced nitrite is not further oxidized to nitrate. Additionally, a control without inhibitor was run. Incubation assays were aerated via a hypodermic needle and stirred at 100 rpm on a multi-plate stirrer during the incubation period of 4 h. Water samples (1 ml) were taken hourly and immediately frozen at -20°C until nitrite concentration was measured using the NaI reduction method (Braman and Hendrix, 1989) with a chemiluminescence detector (CLD 86 S NO/NO_x-Analyser, Eco Physics, Germany). The resulting nitrite production in the incubation vial was then used to calculate the ammonium oxidation rate.

To determine the potential rate of total denitrification (i.e., production of N₂ + N₂O), dissected shells were incubated in 100-ml Duran bottles filled with 20-30 ml anoxic artificial seawater adjusted to 50 μM NO₃⁻. The bottles were sealed with rubber stoppers and the headspace was purged with He gas. One tenth of the headspace was replaced by acetylene which inhibits the last step of denitrification (Sørensen, 1978) and

thus the accumulation of N₂O in the incubation vials indicates total denitrification. A control without acetylene was also run.

For each of the three species and four assays, three replicates with 1-5 shells per vial were set up. All incubations were made at 21°C. The N₂O yields from nitrification and denitrification were calculated as the percentage of N₂O/NO₂⁻ and N₂O/N₂+N₂O expressed per mol N.

Oxygen concentration in shell biofilms

Oxygen concentrations in the shell biofilms were measured with an oxygen microsensor (Revsbech, 1989). The microsensor was calibrated in artificial seawater (19°C, salinity of 22 psu) at 0 and 100% air-saturation by purging with nitrogen gas and synthetic air, respectively. Small pieces of dissected shells were placed in a flow-cell which was continuously flushed with oxygenated artificial seawater (Stief and Eller, 2006). Aided by a dissection microscope, the microsensor tip was positioned at the shell surface and vertical steady-state concentration profiles were recorded through the biofilm and the diffusion boundary layer to a distance of maximally 2.4 mm from the shell surface in increments of 0.0175 mm or 0.035 mm. Profiles were run at randomly chosen positions during light (1220 μmol photons m⁻² s⁻¹) and dark conditions.

Effect of the animal on N₂O production in shell biofilms

A long-term sediment-microcosm experiment with *H. reticulata* was set up with four treatments: a) animals covered with the natural shell biofilm (A+), b) animals with the shell biofilm removed with sterile scalpels and ethanol (A-), c) intact shells covered with the natural biofilm but the animal removed (S+), and d) intact shells with the biofilm and the animal removed (S-). The experiment was conducted in four recirculating flow-through aquaria (30 cm long × 20 cm wide × 10 cm high) each of which was filled with sediment and some seaweed from the sampling site and continuously supplied from its own 50 L original seawater reservoir for a period of 53 days. The microcosms were illuminated from above (40 μmol photons m⁻² s⁻¹ light intensity at the sediment surface) at a 16 h light to 8 h dark cycle throughout the whole experiment.

The N₂O production of dissected shells was investigated on day 1, 20, 33, and 53 of the experiment. In treatments A⁺ and A⁻, animals were removed from the shells as described above. Four dissected shells per treatment and sampling day were incubated in 6-ml exetainers filled with 1 ml of 0.2- μ m filtered seawater from the respective microcosm. N₂O production was followed over 4 h by taking headspace samples hourly and analysing them as described above.

After the N₂O measurements, dissected shells were immediately frozen at -20°C for later analysis of the protein content of the biofilms (see below). Water samples were taken from the four flow-through microcosms throughout the experiment and stored at -20°C until ammonium concentration was analysed photometrically (Bower and Holm-Hansen, 1980), and nitrate and nitrite concentrations by the VCl₃ and NaI reduction method, respectively (Braman and Hendrix, 1989). Correlation analysis of N₂O production rates and protein contents of dissected shells as well as DIN concentrations in the water column of the microcosms were made with the statistical analysis software SPSS (SPSS Inc., U.S.A.).

Protein content of shell biofilm

Dissected shells were thawed and incubated in 5 ml 0.5 N NaOH in a water bath at 80°C for 20 min to extract the proteins. The supernatant was collected after centrifugation at 3000 rpm (1750 g) for 5 min. This extraction procedure was repeated three times. The supernatants from the three extractions were then analysed by the Lowry protein assay (Lowry et al., 1951).

Ammonium excretion rates

Freshly collected whole animals were weighed and incubated for 3 h in artificial seawater continuously mixed by a magnetic stirrer. Per species, 6 incubations containing from 1 individual (*M. edulis*) to up to 6 individuals (*L. littorea*) were set up. Water samples were taken every 0.5 h and frozen at -20°C. Accumulation of ammonium in the water samples was measured by spectrophotometry (Bower and Holm-Hansen, 1980).

Results

Nitrous oxide emission rates of whole animals and their dissected shells

N₂O was produced during incubation of both whole animals and biofilm-covered dissected shells (Fig. 1). The N₂O emission rate of the whole animal and the relative contribution to the total emission rate by the dissected shells varied between animal species. *M. edulis* as the largest species (Tab. 1) showed the highest N₂O emission rate per individual and its shell biofilm contributed on average 94% to the total emission rate. For *L. littorea* and *H. reticulata*, N₂O emission from the dissected shell contributed on average 18% and 32%, respectively, to the total N₂O emission rate. In the ZnCl₂-treated incubations of dissected shells, N₂O production was not observed (data not shown).

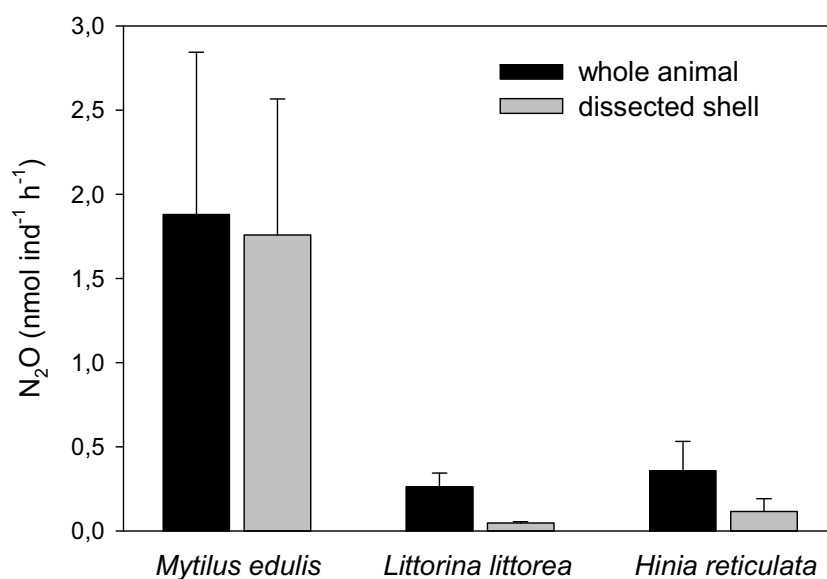

Figure 1: N₂O emission rates of whole animals and dissected shells of *M. edulis*, *L. littorea* and *H. reticulata*. Freshly collected animals and their dissected shells were incubated in gas-tight vials under oxic conditions with NH₄⁺ and NO₃⁻ amended artificial seawater. The N₂O emission rate was derived from the accumulation of N₂O in the incubation vial followed over a period of 4 h. Mean rates ± SD are shown (n = 4-8).

¹⁵N-stable isotope experiments with dissected shells

¹⁵NH₄⁺, ¹⁵NO₃⁻ and ¹⁵NO₂⁻ were all used as precursors for N₂O production, revealing nitrification, denitrification, and denitrification of nitrite as potential sources of N₂O in shell biofilms (Fig. 2, Tab. 3). In the ¹⁵NH₄⁺ incubations (targeting nitrification), ⁴⁶N₂O was produced in biofilms of all three species at average rates ranging from 0.048 to 0.072 nmol g⁻¹ h⁻¹ (Fig. 2a-c, Tab. 3). Nitrification contributed thus 43%, 39% and 47% to the total ⁴⁶N₂O production (i.e., nitrification plus denitrification) in shell biofilms of *M. edulis*, *L. littorea* and *H. reticulata*, respectively. ⁴⁵N₂O production in the shell biofilms of *M. edulis* started after an initial lag phase of 3 h with a rate 1.5 times higher than that for ⁴⁶N₂O. In *H. reticulata* shell biofilms, the ⁴⁵N₂O production rate was 12 times higher than that for ⁴⁶N₂O, whereas in the shell biofilm of *L. littorea* no ⁴⁵N₂O production was observed.

In the ¹⁵NO₃⁻ incubations (targeting denitrification), all three species produced ⁴⁶N₂O at average rates ranging from 0.075 to 0.080 nmol g⁻¹ h⁻¹ (Fig. 2d-f, Tab. 3). Denitrification contributed 57%, 61% and 53% to the total ⁴⁶N₂O production (i.e., nitrification plus denitrification) in shell biofilms of *M. edulis*, *L. littorea* and *H. reticulata*, respectively. Production of ⁴⁵N₂O was detected in *M. edulis* shells at a low rate after a lag phase of 3 h and in *H. reticulata* shells at a rate 4 times higher than the ⁴⁶N₂O production rate, indicating the presence or production of ¹⁴NO₃⁻ and/or ¹⁴NO₂⁻ in the shell biofilm.

In the ¹⁵NO₂⁻ incubations (targeting denitrification of nitrite), both ⁴⁶N₂O and ⁴⁵N₂O production rates of all three species were increased by a factor of 2 to 11 compared to the respective rates in the ¹⁵NO₃⁻ and ¹⁵NH₄⁺ incubations (Fig. 2g-i, Tab. 3). In all ¹⁵N incubations, *H. reticulata* showed the highest N₂O production rates of the three species and ⁴⁵N₂O production rates always exceeded ⁴⁶N₂O production rates, whereas the other two species produced more ⁴⁶N₂O than ⁴⁵N₂O.

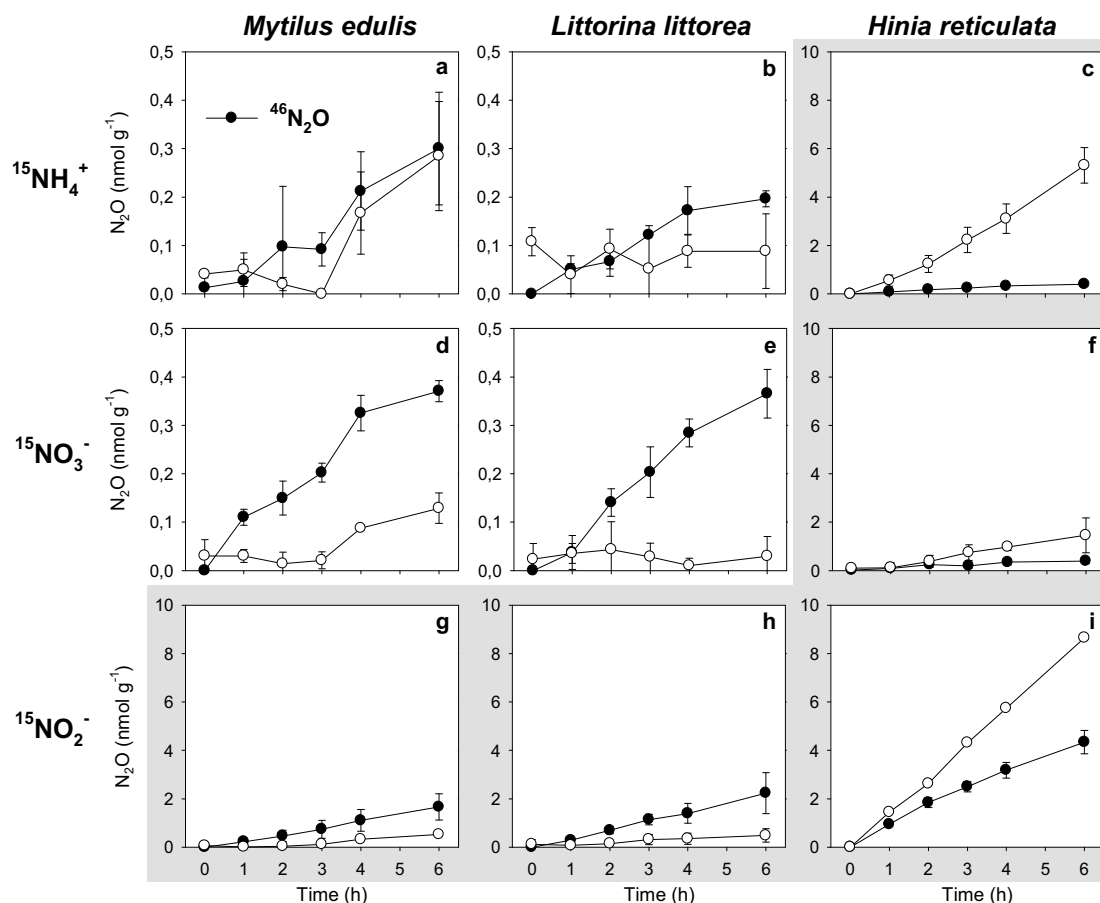

Figure 2: Production of $^{45}\text{N}_2\text{O}$ (white circles) and $^{46}\text{N}_2\text{O}$ (black circles) in shell biofilms of *M. edulis*, *L. littorea* and *H. reticulata*. Dissected shells were incubated in $^{15}\text{NH}_4^+$, $^{15}\text{NO}_3^-$ and $^{15}\text{NO}_2^-$ amended seawater and sampled over a period of 6 h. Averages of three replicate time series \pm SD are shown. Note different scales on y-axis between panels on white and grey background.

Table 3: $^{45}\text{N}_2\text{O}$ and $^{46}\text{N}_2\text{O}$ production rates of dissected shells from incubations with $^{15}\text{NH}_4^+$, $^{15}\text{NO}_3^-$ or $^{15}\text{NO}_2^-$. Mean rates (\pm SD) are shown, $n = 3$, n.d. = not detectable.

Rate (nmol g ⁻¹ h ⁻¹)		<i>Mytilus edulis</i>	<i>Littorina littorea</i>	<i>Hinia reticulata</i>
$^{15}\text{NH}_4^+$	$^{45}\text{N}_2\text{O}$	0.085 (0.043)	n.d.	0.879 (0.216)
	$^{46}\text{N}_2\text{O}$	0.057 (0.020)	0.048 (0.011)	0.072 (0.015)
$^{15}\text{NO}_3^-$	$^{45}\text{N}_2\text{O}$	0.031 (0.014)	n.d.	0.313 (0.041)
	$^{46}\text{N}_2\text{O}$	0.075 (0.002)	0.076 (0.007)	0.080 (0.034)
$^{15}\text{NO}_2^-$	$^{45}\text{N}_2\text{O}$	0.124 (0.002)	0.060 (0.019)	1.426 (0.251)
	$^{46}\text{N}_2\text{O}$	0.282 (0.095)	0.375 (0.140)	0.787 (0.127)

Nitrous oxide production in shell biofilms in relation to nitrification and denitrification

Shells of all three species produced N₂O in both the nitrification and the denitrification assay (Fig. 3a). N₂O yields of denitrification (percentage of N₂O produced per NO₃⁻ consumed) were 13.4%, 11.9% and 5.7%, and of nitrification (percentage of N₂O produced per NH₄⁺ consumed) 3.7%, 7.1% and 4.0% for shells of *M. edulis*, *L. littorea* and *H. reticulata*, respectively (Fig. 3a+b). All potential N₂O production rates were in the range of 0.20 to 1.05 nmol N g⁻¹ h⁻¹, except for the N₂O production rate of *H. reticulata* in the denitrification assay which was 4.84 nmol N g⁻¹ h⁻¹. The potential total denitrification rate of *H. reticulata* shells was also exceptionally high compared to the potential rates of nitrification and denitrification of the other two species (Fig. 3b). *M. edulis* and *L. littorea* exhibited higher nitrification than denitrification potentials, whereas the opposite was found for *H. reticulata*.

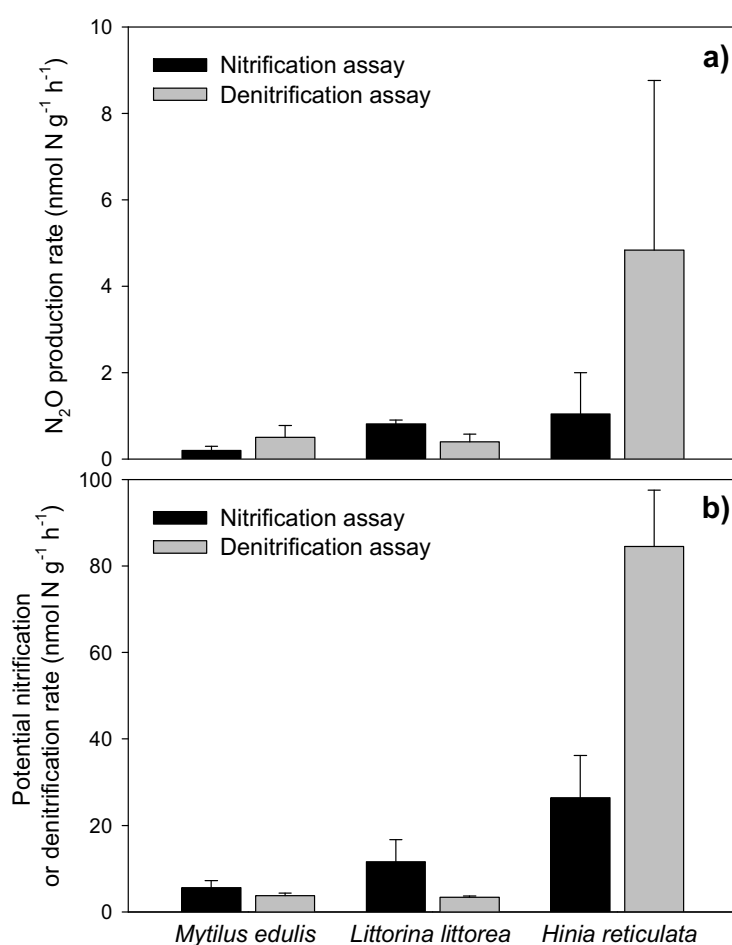

Figure 3: a) Potential N₂O production rates of dissected shells from *M. edulis*, *L. littorea* and *H. reticulata* in nitrification (black bars) and denitrification (grey bars) assays. b) Potential nitrification rates (NO₂⁻ production) (black bars) and denitrification rates (N₂+N₂O production) (grey bars) of dissected shells from the three species. In the nitrification assays, dissected shells were incubated under oxic conditions with 50 μM NH₄⁺ for 4 h, in the denitrification assays under anoxic conditions with 50 μM NO₃⁻ for 4 h. Means ± SD are shown (n = 3). All rates are expressed per mol N. Note different scales on y-axis.

Oxygen concentration in shell biofilms

Oxygen concentration gradients inside the shell biofilm varied depending on the light conditions and thickness of the biofilm (0.05 mm to >1 mm) (Fig. 4). At high light intensity, the oxygen concentration in the shell biofilms corresponded to 100-500% air saturation, indicating net oxygen production inside the biofilms. In the dark, the oxygen concentration in the shell biofilms corresponded to 0-63% air-saturation, indicating net oxygen consumption inside the biofilms.

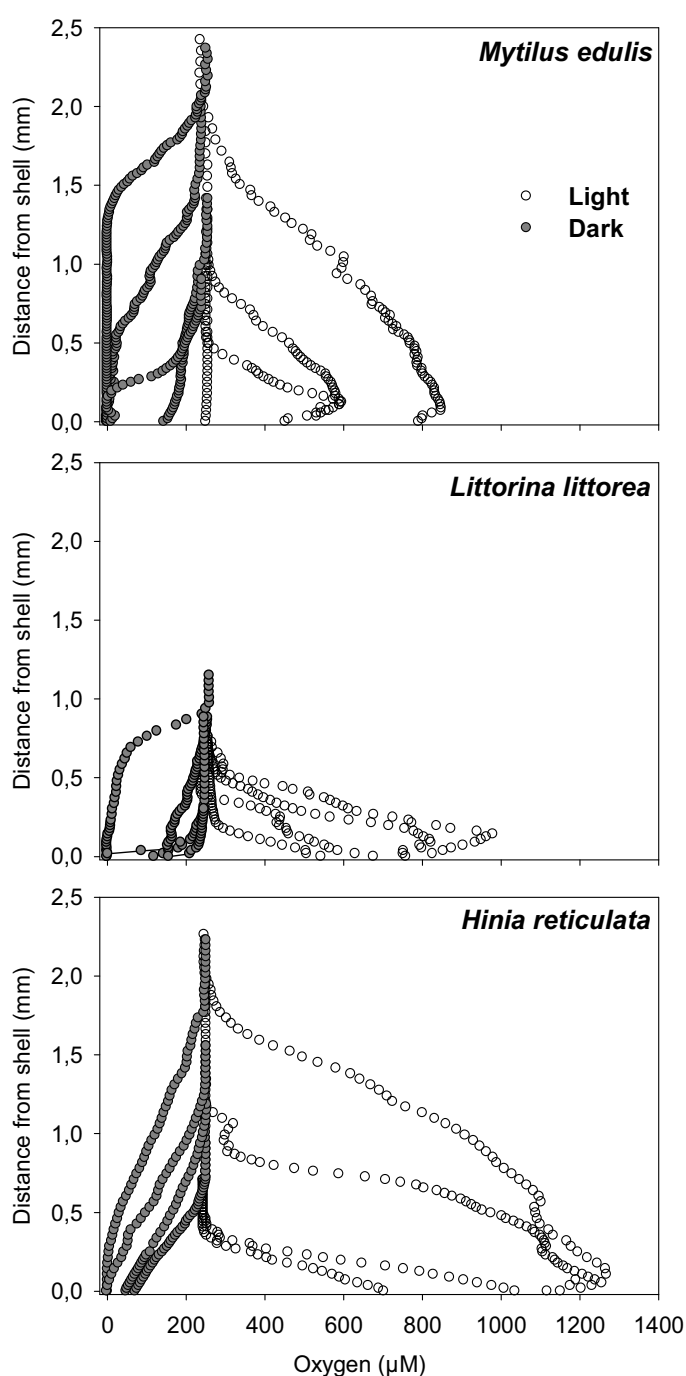

Figure 4: Vertical profiles of the oxygen concentration in shell biofilms of *M. edulis*, *L. littorea* and *H. reticulata* under light (white circles) and dark (grey circles) conditions as measured with microsensors. For each species and light condition, 4 representative profiles are shown that demonstrate the heterogeneity of the oxygen concentration at randomly chosen positions in the shell biofilm.

Effect of the animal on N₂O production in shell biofilms

N₂O production rates of dissected shells of *H. reticulata* showed treatment-specific changes during the incubation in sediment-microcosms for 53 days (Fig. 5, black squares). For animals with a natural shell biofilm at the beginning of the experiment (A+ microcosm), the N₂O production of their dissected shell increased with time. For animals with the shell biofilm removed before the experiment (A- microcosm), a smaller, but steady increase in N₂O production of their dissected shell was observed. In contrast, the N₂O production rate of biofilm-covered shells from which the animal was removed before the experiment (S+ microcosm) remained constant until day 33 and then decreased to the low level of N₂O production of shells from which both the biofilm and the animal were removed before the experiment (S- microcosm). Thus, the presence of the animal increased the N₂O production potential of the shell biofilm over time.

Also the protein content of shell biofilms developed differently in the four sediment-microcosms during the incubation period (Fig. 5, grey circles). In the A+ microcosm, the protein content of the natural shell biofilm stayed constant, whereas in the S+ microcosm, it decreased. In the A- and S- microcosms in which the shell biofilms were removed before the experiment, the protein content increased slightly or remained at a very low level, respectively. Thus, the presence of the animal sustained the growth of the shell biofilm, whereas in the absence of the animal, the biomass of an established biofilm decreased and no significant biofilm formation on clean shell surfaces could be observed. Furthermore, the dissolved inorganic nitrogen (DIN) concentration in the water column increased more in sediment-microcosms with animals than in microcosms with dissected shells only (Fig. 5, white triangles).

The correlation analysis of the complete data set (4 microcosms x 5 sampling days x 4 replicate N₂O measurements, n = 80) revealed that the N₂O production rate of dissected shells was significantly positively correlated with the protein content of the shells (correlation coefficients in Supplementary Table 2). Moreover, the N₂O production rate of dissected shells was significantly positively correlated with the DIN concentration in the water column of the microcosms. Additionally, the protein content and the DIN concentration were also positively correlated with each other.

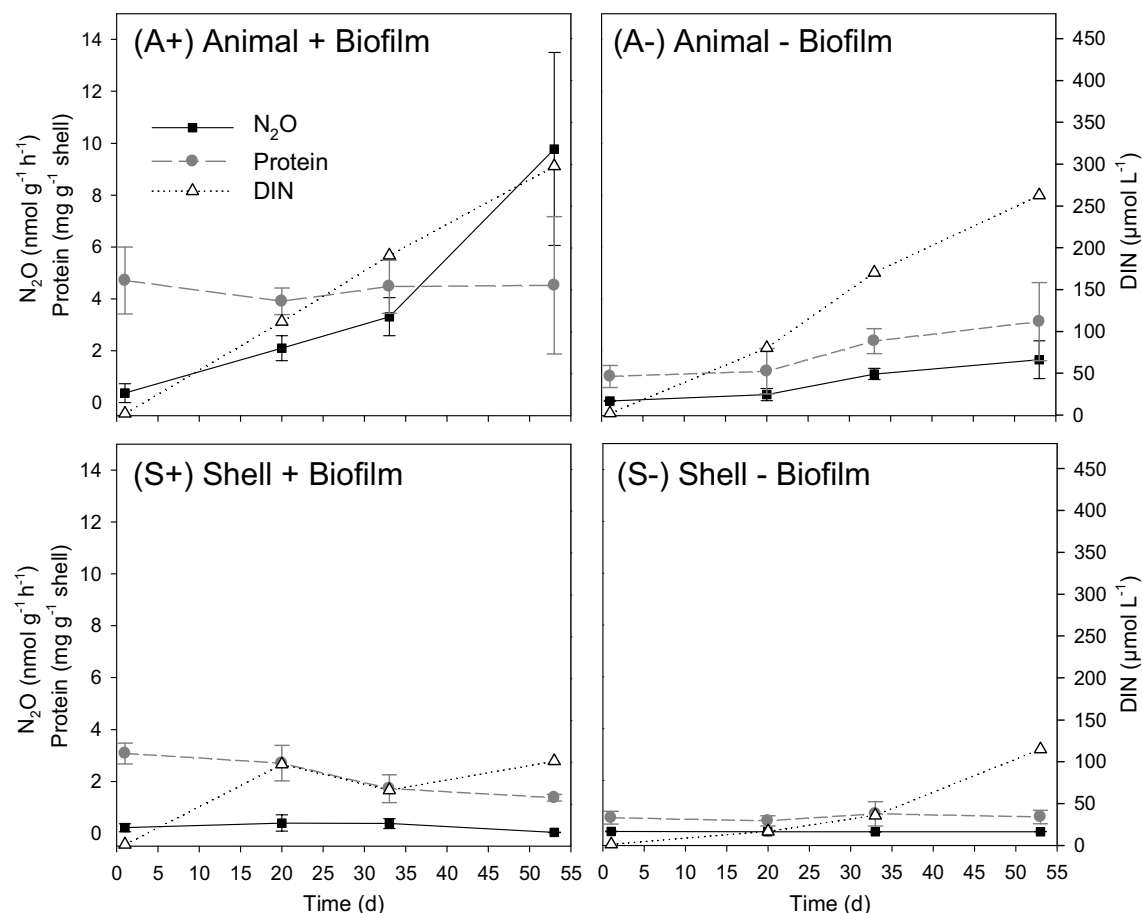

Figure 5: Sediment-microcosm incubation of *H. reticulata*. A+) animals with natural shell biofilm, A-) animals with the shell biofilm removed before the experiment, S+) dissected shells with natural biofilm, and S-) dissected shells with the biofilm removed before the experiment. N₂O production of dissected shells (black squares) was measured on day 1, 20, 33, and 53 by measuring N₂O accumulation in gas-tight vials over a period of 4 h. Mean rates of four replicate N₂O measurements per microcosm ± SD are shown. Protein contents of the shell biofilms are presented as grey circles and the DIN concentration (sum of NH₄⁺, NO₂⁻ and NO₃⁻) in the water column of the sediment-microcosm are presented as white triangles.

Discussion

Contribution of the shell biofilm to total N₂O emission by marine molluscs

The shell biofilm on three marine mollusc species with different life styles and collected in different habitats contributed significantly (18-94%) to the total N₂O emission of the animals. On average, N₂O production in shell biofilms of marine molluscs is thus in the same order of magnitude as N₂O production inside the animal body. This evidence for

substantial N₂O production in shell biofilms of abundant marine molluscs may explain why a recent survey of marine invertebrates revealed a general correlation between the N₂O emission rate and the presence of a microbial biofilm on exoskeleton and shell surfaces (Heisterkamp et al., 2010). These results complement earlier studies on N₂O emission from terrestrial and aquatic invertebrates that ascribed N₂O production exclusively to microbial denitrification activity in the anoxic gut (Drake and Horn, 2007; Stief et al., 2009). The extreme example here is the blue mussel *M. edulis*, in which N₂O production originated almost exclusively from the shell biofilm. Apparently, N₂O production by gut denitrification is negligible in this species. This is surprising, since *M. edulis* is a very efficient filter-feeder that ingests large amounts of bacteria (McHenery and Birkbeck, 1985) and is thus likely to promote high N₂O production in its gut (Stief et al., 2009). However, the high lysozyme activity in the gut of *M. edulis* (Birkbeck and McHenery, 1982) might digest most of the ingested bacteria and thereby inhibit denitrification and concomitant N₂O production in the gut. It can be speculated that also in other aquatic species than *M. edulis* that are listed in Stief et al. 2009 N₂O emission might originate at least partly from shell biofilms. For the freshwater mussel *Dreissena polymorpha*, it has recently been shown that the shell biofilm contributes about 25% to the total N₂O emission of the animal (Svenningsen et al., 2012).

N₂O emission from *L. littorea* and *H. reticulata* derived only partly from N₂O production in the shell biofilm, while the majority of N₂O was produced in other parts of the animal body. Besides the gut, the gills especially may be sites of N₂O production, as they exhibit nitrification activity in various mollusc species (Welsh and Castadelli, 2004).

N₂O-producing pathways in shell biofilms

The stable isotope experiments revealed that nitrification and denitrification produce N₂O in shell biofilms of all three mollusc species. Incubations with the tracers ¹⁵NH₄⁺, ¹⁵NO₃⁻ and ¹⁵NO₂⁻ were designed to specifically ascribe the production of the double-labelled ⁴⁶N₂O to nitrification, denitrification of nitrate and denitrification of nitrite, respectively. Based on the ⁴⁶N₂O production rates in the ¹⁵NH₄⁺ and ¹⁵NO₃⁻ treatments, nitrification contributed on average 43% and denitrification 57% to the total ⁴⁶N₂O production. Both processes are thus almost equally important for N₂O production in

shell biofilms of marine molluscs. Consequently, N₂O emission from marine invertebrates can originate from at least two microbial processes in two different body compartments: denitrification in the gut of the animal (Heisterkamp et al., 2010, Stief et al., 2009), and from denitrification as well as nitrification in the shell biofilms. This means that besides nitrate and nitrite, ammonium also serves as a precursor and consequently as regulating factor for animal-associated N₂O production.

In contrast to the ⁴⁶N₂O production rates, which were similar for all three species, biofilms differed in their ⁴⁵N₂O production rates. In the ¹⁵NH₄⁺ treatment, ⁴⁵N₂O production rates show that only in shell biofilms of *H. reticulata* nitrification and denitrification were tightly coupled and/or that nitrifier denitrification occurred at a significant rate. In shell biofilms of *M. edulis*, coupled nitrification-denitrification and nitrifier denitrification were apparently limited by the ammonium oxidation step, as indicated by the lag-phase in ⁴⁵N₂O production, whereas in shell biofilm of *L. littorea* no mixing of the ¹⁴N and ¹⁵N pools took place. The cell-to-cell connectivity and mixing of products with the ambient pools seem thus to differ between biofilms on different species. Shell biofilms of *H. reticulata* produced also high amounts of ⁴⁵N₂O in the ¹⁵NO₃⁻ treatment, although no additional ¹⁴N pool was added and the background ¹⁴N concentration in the artificial seawater was about 5 μM DI¹⁴N. Provided that random isotope pairing occurred according to the ¹⁴N to ¹⁵N ratio of 1:10 ($[5 \times ^{14}\text{N}]^2 + 2[5 \times ^{14}\text{N}][50 \times ^{15}\text{N}] + [50 \times ^{15}\text{N}]^2$), the ⁴⁵N₂O production rate should be 20% of the ⁴⁶N₂O production rate. The far higher ⁴⁵N₂O production rate in *H. reticulata* shell biofilms suggests that more than 5 μM DI¹⁴N was present. The additional ¹⁴N probably originated from the biofilm itself, either stored in cells or bound to the extracellular matrix of the biofilm or produced by remineralization during the incubation period. Apparently, this internal ¹⁴N pool is more easily available for the cells than the external ¹⁵N pool, thereby enhancing ⁴⁵N₂O production disproportionately despite the much larger ¹⁵NO₃⁻ pool in the incubation medium.

The ¹⁵NO₂⁻ incubations revealed that nitrite strongly increased the rates of ⁴⁶N₂O and ⁴⁵N₂O production of all three species compared to the respective rates in the incubations with equimolar concentrations of ¹⁵NH₄⁺ and ¹⁵NO₃⁻. Furthermore, the low ⁴⁵N₂O/⁴⁶N₂O ratios, despite the ¹⁴N to ¹⁵N ratio of 10:1, show that the nitrite pool is more readily used than the nitrate pool in shell biofilms of all three species. Chemical

conversion of NO₂⁻ to N₂O can be ruled out as an explanation for the higher N₂O production rates in the presence of nitrite, since the negative controls with killed dissected shells incubated in 50 μM and 500 μM NO₂⁻ did not result in a significant accumulation of N₂O (Supplementary Fig. 1). Instead, nitrite might have enhanced biological N₂O production due to increased nitrifier denitrification activity. Ammonia-oxidizing bacteria and complex biofilms produce high amounts of N₂O when denitrifying nitrite at low oxygen concentration or high nitrite concentration (Wrage, 2001; Beaumont et al., 2004; Schreiber et al., 2009). Likewise, nitrifiers in shell biofilms might have been stimulated to reduce nitrite to N₂O by low oxygen concentration or elevated nitrite concentration in the biofilm. A nitrite concentration of 50 μM is unlikely to be toxic to bacteria (Stein and Arp, 1998; Tan et al., 2008), but bacteria may increase nitrite reduction rates already at low nitrite concentrations to avoid that toxic levels are being reached.

The total N₂O production rate is a function of the overall process rate of nitrification and denitrification and the N₂O yield of these processes (percentage of N₂O production per turn-over of substrate). The N₂O yields from nitrification and denitrification in shell biofilms were relatively high (i.e., 3.7-13.4%) compared to N₂O yields from water column nitrification (de Wilde and de Bie, 2000), sedimentary denitrification in eutrophic estuaries (Dong et al., 2006), marine ammonia-oxidizing bacteria (AOB) (Frame and Casciotti, 2010), and marine ammonia-oxidizing archaea (AOA) cultures (Santoro et al., 2011). They were, however, in the same range as N₂O yields of denitrification from rocky biofilms in an intertidal area (Magalhaes et al., 2005). In contrast to the stable isotope experiments in which dissected shells were incubated at initially air-saturated conditions, the potential rates of nitrification and denitrification and their N₂O yields were measured under completely oxic (continuously aerated) or anoxic atmosphere (sealed). These conditions were thus optimal for nitrification or denitrification, leading probably to higher process rates and consequently higher N₂O production rates than in the stable isotope incubations. However, as these potential rates were measured under completely oxic or anoxic conditions, the N₂O yields presented here might be underestimates, since N₂O yields of nitrification and denitrification are generally highest under low oxygen concentrations (Goreau et al., 1980; Jørgensen et al., 1984; Bonin and Raymond, 1990). Conversely, at low oxygen and substrate concentrations, the rates of nitrification and denitrification are likely to slow down

(Jørgensen et al., 1984; Codispoti et al., 2005) and may thus counteract the effect of an increased N₂O yield, leading to an only moderate increase in N₂O production under conditions suboptimal for either process.

The oxygen distribution in the shell biofilm was very heterogeneous, varying with light intensity and thickness of the biofilm. At low light intensities, nitrification and denitrification probably co-occur in the shell biofilm, with nitrification taking place in the (fully) oxic surface layer and denitrification in the hypoxic or anoxic bottom layer of the biofilm. At high light intensities, the biofilm is completely oxic and denitrification only takes place if bacteria capable of aerobic denitrification are present. Several bacterial strains are able to denitrify at or above air saturation (Patureau et al., 2000; Zehr and Ward, 2002; Hayatsu et al., 2008) and high rates of aerobic denitrification were measured in permeable intertidal sediments which are very dynamic environments with changing oxygen concentrations (Gao et al., 2010). The oxygen distribution at high light intensities allows nitrification to occur throughout the complete biofilm, but the rate of nitrification might be reduced as nitrifiers are known to be inhibited by high light intensities (Horrigan and Springer, 1990).

The biofilms on living animals are influenced by the respiration, feeding and migration behaviour of the animal, which expose the shell biofilm to changing environmental conditions, thereby leading to frequent changes in the oxygen concentration inside the shell biofilm. Fluctuations in oxygen concentration result in high transient N₂O production by AOB and denitrifiers in pure cultures and microbial biofilms (Kester et al., 1997; Bergaust et al., 2008; Schreiber et al., 2009). Similarly, shell biofilms are presumably sites of high N₂O production under *in situ* conditions.

Effect of the animal on N₂O production in shell biofilms

The presence of the animal enhanced N₂O production in the shell biofilm by stimulating biofilm growth and providing a nutrient-enriched environment. The protein content of the dissected shells (used as a proxy for biofilm biomass) and the water column DIN concentration were increased in microcosms with animals compared to microcosms with shells only and were both significantly positively correlated with the N₂O production rate of the shell biofilms. The animals increased the water column DIN

concentration probably due to their feeding activity and high ammonium excretion rate as well as stimulation of DIN release from the sediment by bioturbation (Aller et al., 2001). Furthermore, the ammonium excretion rates of *H. reticulata* as well as of *M. edulis* and *L. littorea* (Table 1) are high enough to support the measured total N₂O production in shell biofilms assuming that nitrification and denitrification are tightly coupled. In this case, animal-associated N₂O production can be sustained by the excretion of the animal alone and is thus independent from an ambient DIN source.

A stimulating effect of increased DIN on N₂O production was also reported for rocky biofilms (Magalhaes et al., 2005) and marine sediments (Seitzinger and Kroeze, 1998), and was attributed to increased denitrification rates and/or increased N₂O yields under elevated nutrient concentration. However, only a minor effect of the DIN concentration on the N₂O production rate was observed during short-term incubations (4 h) of dissected shells (Supplementary Information Table 1). Thus, only the long-term exposure to different nutrient concentrations (days to weeks) seems to affect N₂O production in shell biofilms, probably by influencing the microbial abundance and community composition. In intertidal biofilms, elevated nutrient concentrations in the water column increase biofilm density and change the composition of its bacterial community (Chiu et al., 2008). The significant positive correlation between the DIN concentration and the protein content of the shell further substantiates that the elevated DIN concentration due to the presence of the animal determines growth and probably also the microbial composition of the biofilm.

Conclusion

N₂O production in shell biofilms of marine molluscs originates from both nitrification and denitrification and contributes significantly (18-94%) to the total N₂O emission from the different species of marine molluscs tested in this study. Particularly high N₂O production occurs during denitrification of nitrite. Animal-associated N₂O production can thus be fuelled by ammonium, nitrate, and nitrite. The animal stimulates microbial growth on its shell surface and provides a special micro-environment that is characterized by high nutrient availability and dynamic changes of oxygen

concentration. These conditions favour N₂O production by nitrification and denitrification in shell biofilms compared to microbial biofilms not directly affected by animals. Many marine taxa possess a complex microbial biofilm on their external surfaces (Wahl, 1989) and might provide similar habitats in which N₂O production is stimulated. N₂O emission from invertebrates is thus likely to be widespread in marine environments and of particular importance in areas with high animal abundance, such as natural beds or longline farms of the blue mussel *M. edulis*.

Acknowledgements

We are grateful to Anna Behrendt for assistance in the laboratory and to Lars Peter Nielsen for advice and support. This work was financially supported by the DFG grant STI202/6-1 awarded to P.S. and by the Max Planck Society.

Supplementary Information

Dissected shells of *H. reticulata* were incubated for 4 h at different DIN concentrations to test for short-term effects of the DIN concentration on N₂O production rates in shell biofilms. On day 53 of the sediment-microcosm experiment, dissected shells of all four treatments were incubated in filtered seawater from the respective microcosm and N₂O production was followed over 4 h by taking headspace samples. Additionally, dissected shells from the treatments A+ and A- were incubated with filtered seawater from the S-microcosm which contained a DIN concentration of 136 μM (1 μM NH₄⁺, 1 μM NO₂⁻, 134 μM NO₃⁻), while the shells of the treatments S+ and S- were incubated with filtered seawater from the A+ microcosm that contained 456 μM DIN (8 μM NH₄⁺, 22 μM NO₂⁻, 426 μM NO₃⁻). This reciprocal 4h-incubation of A+ and A- shells in S- seawater and of S+ and S- shells in A+ seawater did not result in significant differences in the N₂O production rates of A+, A- and S+ shells (Supplementary Table 1). Only the N₂O production rate of S- shells was significantly higher when incubated with A+ seawater instead of S- seawater. The DIN concentration had thus an only minor effect on the N₂O production rate during short-term incubation of 4 h.

	P	t	Df
A+	0.228	-1.44	3.75
A-	0.925	0.101	3.94
S+	0.850	0.20	4.52
S-	0.044	-2.78	4.52

Supplementary Table 1: t-test comparison of the N₂O production rates in the reciprocal 4h-incubation of A+ and A- shells in seawater from the respective microcosm and in S- seawater, and of S+ and S- shells in seawater from the respective microcosm and in A+ seawater.

Supplementary Table 2: Correlation coefficients between N₂O production rate of dissected shells (nmol g⁻¹ h⁻¹), protein content of dissected shells (mg g⁻¹) and DIN concentration in the water column of the microcosms (μM). n = 80 (4 microcosms x 5 sampling days x 4 replicate N₂O measurements).

	Linear correlation (Pearson coefficient)	Non-parametric correlation (Spearman coefficient)
	N ₂ O	N ₂ O
Protein	0.478 (p < 0.001)	0.684 (p < 0.001)
DIN	0.639 (p < 0.001)	0.596 (p < 0.001)
	Protein	Protein
DIN	0.381 (p < 0.001)	0.335 (p = 0.002)

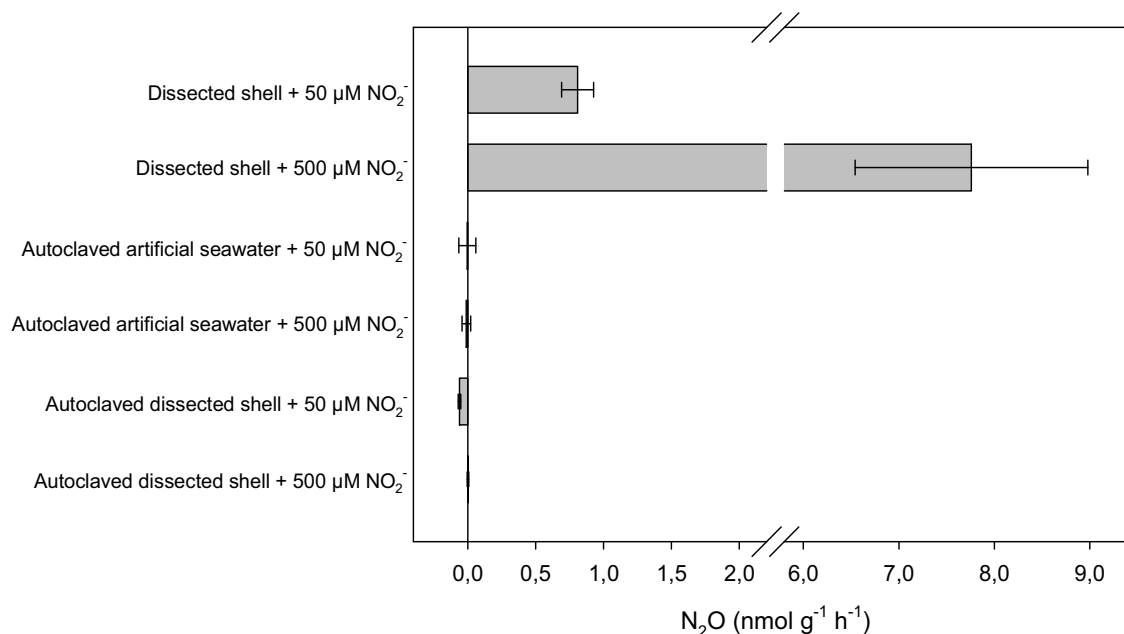

Supplementary Figure 1: Negative controls were performed to test for chemical conversion of NO₂⁻ to N₂O. First, autoclaved artificial seawater amended with either 50 or 500 μM NO₂⁻ was incubated for 6 h and analyzed for N₂O production by gas chromatography. Second, autoclaved dissected shells were added to the autoclaved artificial seawater amended with either 50 or 500 μM NO₂⁻ and then analyzed for N₂O production. In none of the negative controls a significant increase in N₂O could be detected during the incubation period of 6 h. Thus, chemical conversion of NO₂⁻ to N₂O can be ruled out as an explanation for the very high N₂O production by live shell biofilms.

References

- Aller, R.C., Aller, J.Y., and Kemp, P.F. (2001) Effects of particle and solute transport on rates and extent of remineralization in bioturbated sediments. In: *Organism-Sediment Interactions*. Aller, J.Y., Aller, R.C., and Woodin, S. (eds) Univ. So. Carolina Press, Columbia S.C., pp. 315-333.
- Beaumont, H.J.E., Lens, S.I., Reijnders, W.N.M., Westerhoff, H.V., and van Spanning, R.J.M. (2004) Expression of nitrite reductase in *Nitrosomonas europaea* involves NsrR, a novel nitrite-sensitive transcription repressor. *Molecular Microbiology* 54: 148-158.
- Belser, L.W., and Mays, E.L. (1980) Specific inhibition of nitrite oxidation by chlorate and its use in assessing nitrification in soils and sediments. *Applied and Environmental Microbiology* 39: 505-510.
- Bergaust, L., Shapleigh, J., Frostegard, A., and Bakken, L. (2008) Transcription and activities of NO_x reductases in *Agrobacterium tumefaciens*: the influence of nitrate, nitrite and oxygen availability. *Environmental Microbiology* 10: 3070-3081.
- Birkbeck, T.H., and McHenry, J.G. (1982) Degradation of bacteria by *Mytilus edulis*. *Marine Biology* 72: 7-15.
- Bock, E., Schmidt, I., Stuvem, R., and Zart, D. (1995) Nitrogen loss caused by denitrifying *Nitrosomonas* cells using ammonium or hydrogen as electron donors and nitrite as electron acceptor. *Archives of Microbiology* 163: 16-20.
- Bonin, P., and Raymond, N. (1990) Effects of oxygen on denitrification in marine sediments. *Hydrobiologia* 207: 115-122.
- Bower, C.E., and Holm-Hansen, T. (1980) A salicylate-hypochlorite method for determining ammonia in seawater. *Canadian Journal of Fisheries and Aquatic Sciences* 37: 794-798.
- Braman, R.S., and Hendrix, S.A. (1989) Nanogram nitrite and nitrate determination in environmental and biological materials by vanadium(III) reduction with chemiluminescence detection. *Analytical Chemistry* 61: 2715-2718.
- Chiu, J.M.Y., Zhang, R., Wang, H., Thiyagarajan, V., and Qian, P.Y. (2008) Nutrient effects on intertidal community: from bacteria to invertebrates. *Marine Ecology Progress Series* 358: 41-50.
- Codispoti, L.A., Yoshinari, T., and Devol, A.H. (2005) Suboxic respiration in the oceanic water column. In *Respiration in aquatic ecosystems*. Del Giorgio, P.A., and Williams, P.J.L.B. (eds). Oxford: Oxford University Press, pp. 225-247.
- de Wilde, H.P.J., and de Bie, M.J.M. (2000) Nitrous oxide in the Schelde estuary: production by nitrification and emission to the atmosphere. *Marine Chemistry* 69: 203-216.
- Dong, L.F., Nedwell, D.B., and Stott, A. (2006) Sources of nitrogen used for denitrification and nitrous oxide formation in sediments of the hypernutrified Colne, the nutrified Humber, and the oligotrophic Conwy estuaries, United Kingdom. *Limnology and Oceanography* 51: 545-557.
- Drake, H.L., and Horn, M.A. (2007) As the worm turns: the earthworm gut as a transient habitat for soil microbial biomes. *Annual Review of Microbiology* 61: 169-189.
- Frame, C.H., and Casciotti, K.L. (2010) Biogeochemical controls and isotopic signatures of nitrous oxide production by a marine ammonia-oxidizing bacterium. *Biogeosciences* 7: 2695-2709.

- Forster, P., V. Ramaswamy, P. Artaxo, T. Berntsen, R. Betts, D.W. Fahey, J. Haywood, J. Lean, D.C. Lowe, G. Myhre, J. Nganga, R. Prinn, G. Raga, M. Schulz and R. Van Dorland, 2007: Changes in Atmospheric Constituents and in Radiative Forcing. In: *Climate Change 2007: The Physical Science Basis. Contribution of Working Group I to the Fourth Assessment Report of the Intergovernmental Panel on Climate Change* [Solomon, S., D. Qin, M. Manning, Z. Chen, M. Marquis, K.B. Averyt, M. Tignor and H.L. Miller (eds.)]. Cambridge University Press, Cambridge, UK. Pp 129-243
- Gao, H., Schreiber, F., Collins, G., Jensen, M.M., Kostka, J.E., Lavik, G. et al. (2010) Aerobic denitrification in permeable Wadden Sea sediments. *Isme Journal* 4: 417-426.
- Goreau, T.J., Kaplan, W.A., Wofsy, S.C., McElroy, M.B., Valois, F.W., and Watson, S.W. (1980) Production of NO₂⁻ and N₂O by nitrifying bacteria at reduced concentrations of oxygen. *Applied and Environmental Microbiology* 40: 526-532.
- Hayatsu, M., Tago, K., and Saito, M. (2008) Various players in the nitrogen cycle: diversity and functions of the microorganisms involved in nitrification and denitrification. *Soil Science and Plant Nutrition* 54: 33-45.
- Heisterkamp, I.M., Schramm, A., de Beer, D., and Stief, P. (2010) Nitrous oxide production associated with coastal marine invertebrates. *Marine Ecology Progress Series* 415: 1-9.
- Horn, M.A., Schramm, A., and Drake, H.L. (2003) The earthworm gut: an ideal habitat for ingested N₂O-producing microorganisms. *Applied and Environmental Microbiology* 69: 1662-1669.
- Horrigan, S.G., and Springer, A.L. (1990) Oceanic and estuarine ammonium oxidation - effects of light. *Limnology and Oceanography* 35: 479-482.
- Jørgensen, K.S., Jensen, H.B., and Sorensen, J. (1984) Nitrous oxide production from nitrification and denitrification in marine sediment at low oxygen concentrations. *Canadian Journal of Microbiology* 30: 1073-1078.
- Karsten, G.R., and Drake, H.L. (1997) Denitrifying bacteria in the earthworm gastrointestinal tract and in vivo emission of nitrous oxide (N₂O) by earthworms. *Applied and Environmental Microbiology* 63: 1878-1882.
- Kester, R.A., deBoer, W., and Laanbroek, H.J. (1997) Production of NO and N₂O by pure cultures of nitrifying and denitrifying bacteria during changes in aeration. *Applied and Environmental Microbiology* 63: 3872-3877.
- Lowry, O.H., Rosebrough, N.J., Farr, A.L., and Randall, R.J. (1951) Protein measurement with the folin phenol reagent. *Journal of Biological Chemistry* 193: 265-275.
- Magalhaes, C.M., Joye, S.B., Moreira, R.M., Wiebe, W.J., and Bordalo, A.A. (2005) Effect of salinity and inorganic nitrogen concentrations on nitrification and denitrification rates in intertidal sediments and rocky biofilms of the Douro River estuary, Portugal. *Water Research* 39: 1783-1794.
- McHenery, J.G., and Birkbeck, T.H. (1985) Uptake and processing of cultured microorganisms by bivalves. *Journal of Experimental Marine Biology and Ecology* 90: 145-163.
- Mosier, A., Kroeze, C., Nevison, C., Oenema, O., Seitzinger, S., and van Cleemput, O. (1998) Closing the global N₂O budget: nitrous oxide emissions through the agricultural nitrogen cycle - OECD/IPCC/IEA phase II development of IPCC guidelines for national greenhouse gas inventory methodology. *Nutrient Cycling in Agroecosystems* 52: 225-248.

- Nielsen, L.P. (1992) Denitrification in sediment determined from nitrogen isotope pairing. *Fems Microbiology Ecology* 86: 357-362.
- Patureau, D., Zumstein, E., Delgenes, J.P., and Moletta, R. (2000) Aerobic denitrifiers isolated from diverse natural and managed ecosystems. *Microbial Ecology* 39: 145-152.
- Poth, M., and Focht, D.D. (1985) N-15 kinetic analysis of N₂O production by *Nitrosomonas europaea* - an examination of nitrifier denitrification. *Applied and Environmental Microbiology* 49: 1134-1141.
- Ravishankara, A.R., Daniel, J.S., and Portmann, R.W. (2009) Nitrous Oxide (N₂O): the dominant ozone-depleting substance emitted in the 21st Century. *Science* 326: 123-125.
- Revsbech, N.P. (1989) An oxygen microsensor with a guard cathode. *Limnology and Oceanography* 34: 474-478.
- Ritchie, G.A.F., and Nicholas, D.J. (1972) Identification of sources of nitrous-oxide produced by oxidative and reductive processes in *Nitrosomonas europaea*. *Biochemical Journal* 126: 1181-1191.
- Santoro, A.E., Buchwald, C., McIlvin, M.R., and Casciotti, K.L. (2011) Isotopic signature of N₂O produced by marine ammonia-oxidizing Archaea. *Science* 333: 1282-1285.
- Schreiber, F., Loeffler, B., Polerecky, L., Kuypers, M.M.M., and de Beer, D. (2009) Mechanisms of transient nitric oxide and nitrous oxide production in a complex biofilm. *Isme Journal* 3: 1301-1313.
- Seitzinger, S.P., and Kroeze, C. (1998) Global distribution of nitrous oxide production and N inputs in freshwater and coastal marine ecosystems. *Global Biogeochemical Cycles* 12: 93-113.
- Sørensen, J. (1978) Denitrification rates in a marine sediment as measured by acetylene inhibition technique. *Applied and Environmental Microbiology* 36: 139-143.
- Stein, L.Y., and Arp, D.J. (1998) Loss of ammonia monooxygenase activity in *Nitrosomonas europaea* upon exposure to nitrite. *Applied and Environmental Microbiology* 64: 4098-4102.
- Stein, L.Y., and Yung, Y.L. (2003) Production, isotopic composition, and atmospheric fate of biologically produced nitrous oxide. *Annual Review of Earth and Planetary Sciences* 31: 329-356.
- Stief, P., and Eller, G. (2006) The gut microenvironment of sediment-dwelling *Chironomus plumosus* larvae as characterised with O₂, pH, and redox microsensors. *Journal of Comparative Physiology B-Biochemical Systemic and Environmental Physiology* 176: 673-683.
- Stief, P., and Schramm, A. (2010) Regulation of nitrous oxide emission associated with benthic invertebrates. *Freshwater Biology* 55: 1647-1657.
- Stief, P., Polerecky, L., Poulsen, M., and Schramm, A. (2010) Control of nitrous oxide emission from *Chironomus plumosus* larvae by nitrate and temperature. *Limnology and Oceanography* 55: 872-884.
- Stief, P., Poulsen, M., Nielsen, L.P., Brix, H., and Schramm, A. (2009) Nitrous oxide emission by aquatic macrofauna. *Proceedings of the National Academy of Sciences of the United States of America* 106: 4296-4300.
- Svenningsen, N.B., Heisterkamp, I.M., Sigby-Clausen, M., Larsen, L.H., Nielsen, L.P., Stief, P., and Schramm, A. (2012) Shell biofilm nitrification and gut denitrification contribute to emission of nitrous oxide by the invasive freshwater mussel *Dreissena polymorpha* (Zebra Mussel). *Applied and Environmental Microbiology* 78: 4505-4509.

- Tan, N.C.G., Kampschreur, M.J., Wanders, W., van der Pol, W.L.J., van de Vossenberg, J., Kleerebezem, R. et al. (2008) Physiological and phylogenetic study of an ammonium-oxidizing culture at high nitrite concentrations. *Systematic and Applied Microbiology* 31: 114-125.
- van Beusekom, J.E.E., and de Jonge, V.N. (2002) Long-term changes in Wadden Sea nutrient cycles: importance of organic matter import from the North Sea. *Hydrobiologia* 475: 185-194.
- van Beusekom, J.E.E., Weigelt-Krenz, S., and Martens, P. (2008) Long-term variability of winter nitrate concentrations in the Northern Wadden Sea driven by freshwater discharge, decreasing riverine loads and denitrification. *Helgoland Marine Research* 62: 49-57.
- Wahl, M. (1989) Marine epibiosis. 1. Fouling and antifouling - some basic aspects. *Marine Ecology Progress Series* 58: 175-189.
- Weiss, R.F., and Price, B.A. (1980) Nitrous-oxide solubility in water and seawater. *Marine Chemistry* 8: 347-359.
- Welsh, D.T., and Castadelli, G. (2004) Bacterial nitrification activity directly associated with isolated benthic marine animals. *Marine Biology* 144: 1029-1037.
- Wrage, N. (2001) Role of nitrifier denitrification in the production of nitrous oxide. *Soil Biology & Biochemistry* 33: 1723-1732.
- Zehr, J.P., and Ward, B.B. (2002) Nitrogen cycling in the ocean: New perspectives on processes and paradigms. *Applied and Environmental Microbiology* 68: 1015-1024.
- Zumft, W.G. (1997) Cell biology and molecular basis of denitrification. *Microbiology and Molecular Biology Reviews* 61: 533-616.

Chapter 4



Cover photograph (Copyright © 2012, American Society for Microbiology. All Rights Reserved.): Close-up of a zebra mussel (*Dreissena polymorpha*) reef. This species is invasive in North American and European freshwater systems and can form reefs of more than 100,000 individuals per square meter. Nitrification in shell biofilms and denitrification in the mussel's gut may dramatically increase benthic N₂O emissions.

**Shell biofilm nitrification and gut denitrification
contribute to emission of nitrous oxide
by the invasive freshwater mussel *Dreissena
polymorpha* (Zebra Mussel)**

Nanna B. Svenningsen¹, Ines M. Heisterkamp², Maria Sigby-Clausen¹,
Lone H. Larsen¹, Lars Peter Nielsen¹, Peter Stief², and Andreas Schramm¹

¹Department of Bioscience, Microbiology, Aarhus University,
Ny Munkegade 114, DK-8000 Aarhus C, Denmark

²Max Planck Institute for Marine Microbiology, Microsensor Group,
Celsiusstraße 1, 28359 Bremen, Germany

Applied and Environmental Microbiology 78(12): 4505-4509, 2012

Abstract

Nitrification in shell biofilms and denitrification in the gut of the animal accounted for N₂O emission by *Dreissena polymorpha* (Bivalvia), as shown by gas chromatography and gene expression analysis. The mussel's ammonium excretion was sufficient to sustain N₂O production and thus potentially uncouples invertebrate N₂O production from environmental N concentrations.

Introduction

Nitrous oxide (N₂O) is a powerful greenhouse gas that contributes to stratospheric ozone destruction (3, 4). In natural systems, the production of N₂O is primarily associated with the turnover of inorganic nitrogen compounds by nitrifying and denitrifying microorganisms, often in oxic/anoxic transition zones in soil and sediment (34). Nitrifiers (both ammonia-oxidizing bacteria and archaea) produce N₂O as a by-product of ammonia oxidation (6, 28), especially under oxygen limitation, while for denitrifiers N₂O is an intermediate in anaerobic respiration (40). Besides soils and aquatic systems, also invertebrates are sites of a globally significant N₂O production, first discovered for earthworms (15, 19), and subsequently for diverse freshwater and marine invertebrates (11, 36). This animal-associated N₂O production has been attributed to incomplete denitrification by ingested microorganisms in the anoxic invertebrate gut (13, 14, 35). In addition, biofilms covering shells and exoskeletons of marine invertebrates have been identified as sites of N₂O emission (11). Their relative contribution to animal-associated N₂O production, the pathways involved, and their distribution among marine and freshwater invertebrates are still unknown. The objective of the present study was therefore to quantify the biofilm-derived N₂O production and its mechanism(s) using the N₂O-emitting (36) freshwater bivalve *Dreissena polymorpha* (zebra mussel) as model organism. This species is considered invasive in North America and Europe, and can occur at extremely high abundance. Local populations in the Gudenå river system (Denmark) occasionally form large reefs at the sediment surface with more than 100,000 individuals per m² (1).

Methods, Results, and Discussion

Site of N₂O production in *D. polymorpha*

Mussels were sampled in April 2010 in the river Remstrup, which is part of the Gudenå system. Living animals or shells dissected from living animals were pooled in sets of 7-15 individuals for replicate incubations (n = 5-6) at 21°C in gas-tight bags (10) filled with air-saturated artificial freshwater (33) containing NH₄⁺ and NO₃⁻ (50 µM each) and

a headspace of atmospheric air. Shells incubated with 50 % ZnCl₂ to kill biological activity served as negative controls. N₂O emission rates were determined from linear increase of N₂O concentrations in 3-h incubations as previously described (36). In short, water samples were hourly withdrawn from the bags, transferred to N₂-flushed, ZnCl₂-containing exetainers, and N₂O was measured by gas chromatography (36). Bags were still oxidic (>50 %) after the 3-h incubation as confirmed with an O₂ microelectrode (26).

N₂O emission was approximately linear over time both in incubations of whole mussels and biofilm-covered dissected shells; for whole mussels, the rates were similar to *D. polymorpha* collected in August 2006 in the river Rhine (36). The shell biofilm contributed approximately 25% to the total N₂O emission from *D. polymorpha* specimens (Fig. 1). N₂O production was an exclusively biological process, indicated by the linearity of the emissions and confirmed by the absence of N₂O emissions in the killed control.

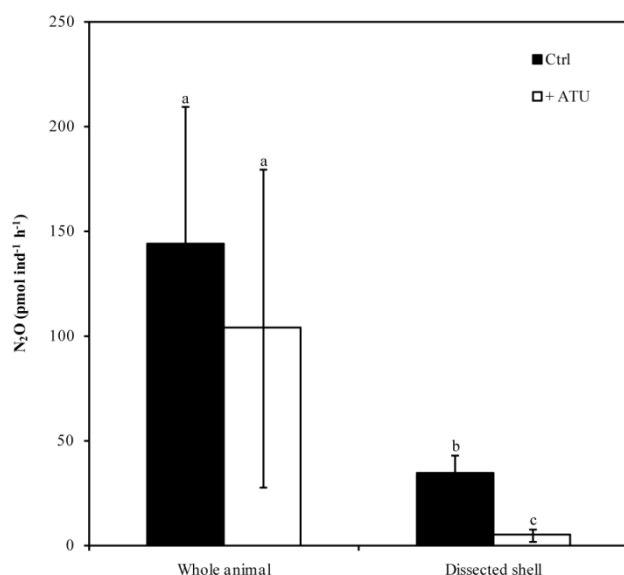

Figure 1: N₂O emission from living animals or shells dissected from living animals incubated in artificial freshwater with (+ ATU) or without inhibition of NH₃ oxidation by ATU (Ctrl). Error bars represent standard deviations (SD) of the mean (n=5-6, each replicate consists of 7-15 animals or shells). Different lowercase letters indicate significant differences between treatments (p < 0.05, t-test)

Pathways of N₂O production

Additional whole animals and dissected shells were incubated with allylthiourea (ATU, 100 µM) to inhibit NH₃ oxidation (8). N₂O emission from ATU-incubated shells was almost completely eliminated, pointing to nitrification as the dominant N₂O-producing pathway in the shell biofilm of *D. polymorpha* (Fig. 1). In contrast, N₂O emission from the animal itself was not reduced by ATU, which indicates that denitrification was responsible for N₂O production inside the animal, in agreement with gut-associated N₂O production via denitrification in other freshwater invertebrates (36).

These results were supported by the detection of transcripts for bacterial ammonia monooxygenase (*amoA*), the key enzyme of ammonia oxidation, and for nitrite reductase (*nirK* and *nirS*), a key enzyme of denitrification. RNA was extracted from dissected, whole guts and from biofilm material (sampled in June 2010) with the FastRNA® Pro Soil-Direct Kit (MP Biomedicals), and DNase-treated (Ambion) for 30 min to remove DNA, as confirmed by (lack of) 16S rRNA gene-specific PCR amplification. Reverse transcription PCR (RT-PCR, 35 cycles) was performed with the OneStep RT-PCR Kit (Qiagen). Published protocols and primers specific for bacterial *amoA*, amoA1F-amoAR-TC (24, 27) and for *nirK* and *nirS*, F1aCu-R3Cu (9) and Cd3aF-R3cd (21, 38), respectively, were used. Bacterial *amoA* mRNA was only detected in biofilm samples, while mRNA of *nirK* and *nirS* were only detected in gut samples (Table 1). Since archaeal *amoA* genes were never detected by PCR (12) in any of the samples (see below), detection of archaeal *amoA* transcripts was not attempted.

Additional animals were collected in December 2010 and analyzed by reverse transcription quantitative PCR (RT-qPCR). Mussels were incubated for 4 hours at similar conditions as during N₂O rate measurements. Then total nucleic acids were extracted in triplicate by a phenol-chloroform protocol (7, 25), and one aliquot of the nucleic acid extract was DNase-treated as described above. cDNA synthesis with the Omniscript Reverse Transcription kit (Qiagen) was primed by random hexamers, and cDNA copy numbers of bacterial *amoA*, *nirK* and *nirS* were quantified in a LightCycler 480 (Roche) as described previously (12). Annealing temperatures were adjusted to 55°C for *nirS* and to 57°C for bacterial *amoA* and *nirK*; detection limit (10-13 cDNA copies) was defined as 3x the standard deviation of the non-template control, while the

limit of quantification was defined by the lower limit of the linear range of the standard curves (85-100 cDNA copies).

Copy numbers of all cDNAs were low (always below the limit of quantification, for *nirS* always below the detection limit), but confirmed the results of the qualitative RT-PCR assay for bacterial *amoA* and *nirK*: bacterial *amoA* cDNA was only detected in biofilm samples, while *nirK* cDNA was only detected in gut samples (Table 1).

Table 1: Expression of genes encoding ammonia monooxygenase (*amoA*) and nitrite reductase (*nirK* and *nirS*) in animals collected in June and December 2010.

Material	Expression of ^a :					
	<i>amoA</i>		<i>nirK</i>		<i>nirS</i>	
	June	December (cDNA copies per mg wet- weight)	June	December (cDNA copies per mg wet- weight)	June	December cDNA copies per mg wet- weight)
Gut	–	–	+	205-1585 ^b	+	< 240 ^c
Shell biofilm	+	200-2000 ^b	–	–	–	–

^a –, not detected by RT-PCR or RT-qPCR; +, detected by RT-PCR.

^b Above limit of detection but below limit of quantification for RT-qPCR.

^c Below limit of detection for RT-qPCR but detected and cloned after RT-PCR.

To test for the metabolic potential of the biofilm and gut microbial community, gene copy numbers of bacterial *amoA*, *nirK* and *nirS* were quantified in the nucleic acid extracts from December 2010. Amplification of archaeal *amoA* (12) was attempted several times, but the result was always negative, indicating that archaeal ammonia oxidizers were not relevant in these samples. qPCR were performed as described above, and functional gene copy numbers were normalized against 16S rRNA gene copy numbers amplified with primer pair 341F-907R (22, 23), with annealing at 57 °C. 16S rRNA gene copy numbers (per mg wet weight) were $4.83 \times 10^6 \pm 6.2 \times 10^5$ in the gut and $3.48 \times 10^8 \pm 1.7 \times 10^7$ in the shell samples. Copy numbers of all functional genes were above the limit of quantification. Relative abundance \pm SD was low in gut samples, i.e., $1.6 \times 10^{-3} \pm 1.5 \times 10^{-3}$ for bacterial *amoA*, $2.7 \times 10^{-1} \pm 6.5 \times 10^{-2}$ for

nirK, and $2.5 \times 10^{-1} \pm 3.8 \times 10^{-2}$ for *nirS*. Biofilm samples showed higher relative abundances, i.e., $2.0 \times 10^{-2} \pm 2.4 \times 10^{-3}$ for bacterial *amoA*, $1.6 \times 10^1 \pm 9.6 \times 10^{-1}$ for *nirK*, and $1.6 \times 10^0 \pm 1.2 \times 10^{-1}$ for *nirS*. These data indicate a potential for ammonia oxidation and denitrification in both gut and biofilm, if environmental conditions allow. Expression of bacterial *amoA*, *nirK* and *nirS* is affected by a variety of environmental factors, including O₂ partial pressure and availability of N-substrates (29, 40). Inside the mussel gut, O₂ will most likely be depleted (35). In accordance with the data presented here, denitrification will therefore be induced, and ammonia oxidation repressed, when denitrifiers and ammonia oxidizers, respectively, enter the gut. Mussel biofilms analyzed in this study, on the other hand, were relatively thin and presumably fully oxic, as indicated by preliminary O₂-microsensor measurements (data not shown). N₂O is therefore mainly produced by nitrification, while denitrification is repressed. However, high *nir* gene abundance indicates that denitrification may contribute to N₂O production, if anoxic microsites develop within the biofilm (30).

Diversity of expressed *amoA*, *nirK*, and *nirS*

To assess the diversity of the active ammonia oxidizers and denitrifiers, clone libraries were constructed from cDNA of bacterial *amoA* (biofilm samples), and *nirK/nirS* (gut samples) of animals collected in June and December 2010. RT-PCR products were cloned using the pGEM-T cloning kit (Promega), and approx. 30 randomly picked clones per sample and gene were sequenced (GATC Biotech; Macrogen); the cDNA clone sequences were deposited in Genbank under accession numbers JF820296-JF820311. Sequences were aligned by the integrated aligner tool in the ARB software (18) together with sequences of their closest relatives found by nucleotide BLAST, translated into amino acid sequences and used for phylogenetic tree construction in ARB using neighbor joining and maximum likelihood analysis with 1000 bootstraps replications. Both methods resulted in identical tree topologies.

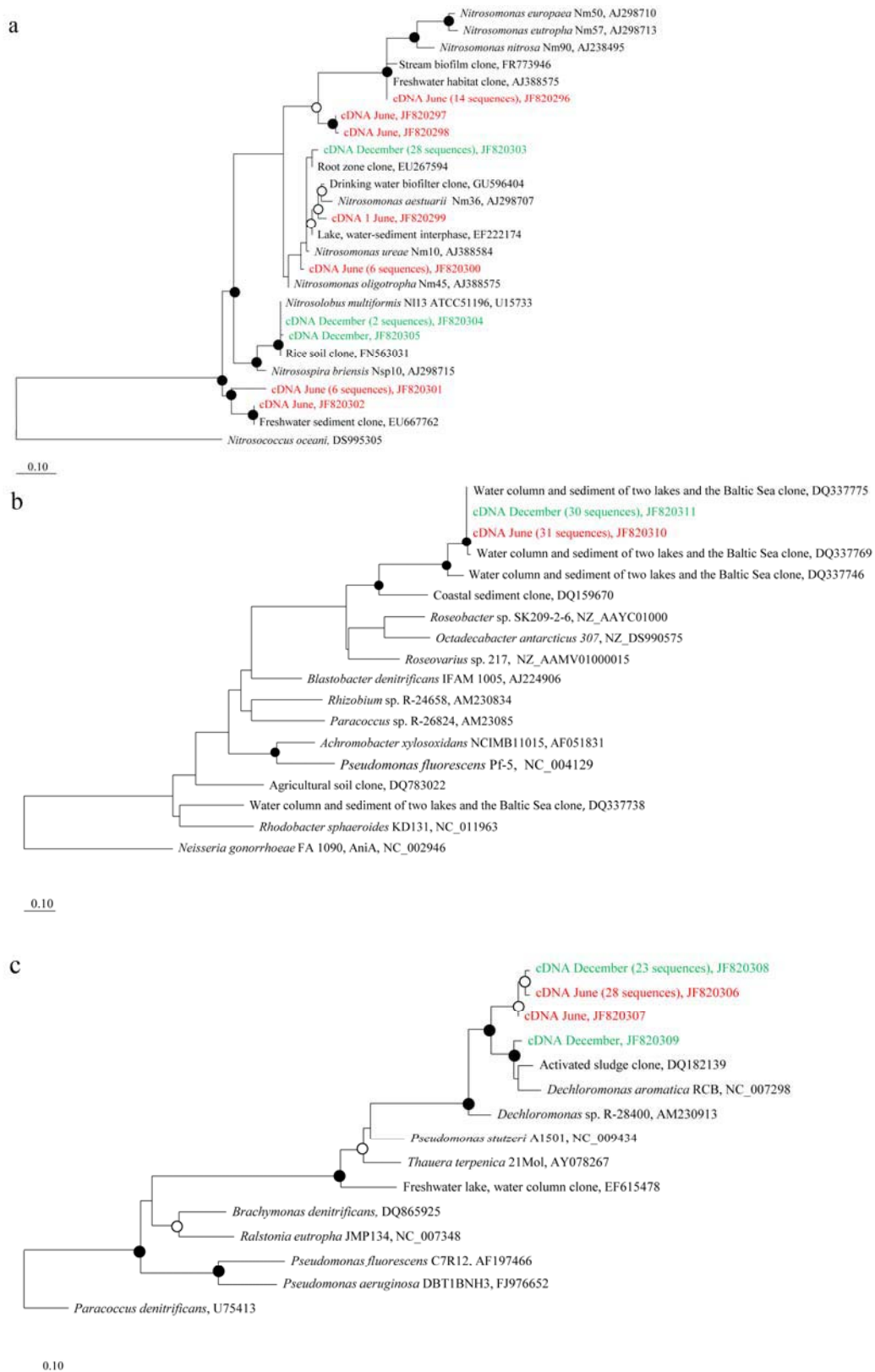

Figure 2: Neighbor joining tree of amino acid sequences deduced from cDNA obtained in June 2010 (red) or December 2010 (green). Sequences of bacterial *amoA* (**a**) are from shell biofilms, while sequences of *nirK* (**b**) and *nirS* (**c**) are from the gut of *D. polymorpha*. The number of identical sequences (at least 97 % nucleotide identity) is shown in brackets. Scale bar, 10% amino acid sequence divergence. Node symbols indicate bootstrap support by maximum likelihood analysis: closed circles, >75%; open circles, >50%.

Sequences of expressed bacterial *amoA* were in June 2010 affiliated with the *Nitrosomonas europaea*- and *N. oligotropha* lineages, and a lineage without cultured relatives, while in December 2010 they were affiliated with the *Nitrospira*- and *N. oligotropha*-lineage (Fig. 2a). Since both clone libraries were well covered (Good's coverage >98% based on a 97% nucleotide similarity threshold), the most probable explanation is differential activity of ammonia oxidizers at the different sampling times, possibly related to their differing substrate affinities (16).

In contrast, diversity of expressed *nirK* and *nirS* was very low, and sequences retrieved from animals collected in June and December were highly similar or identical. *NirK* affiliated with *Dechloromonas aromatica* (87% DNA sequence similarity), while *nirS* were only distantly related (70% DNA sequence similarity) to various Alphaproteobacteria, e.g. *Rhodopseudomonas palustris* or *Rhodobacter spheroides* (Fig. 2b, c). This limited diversity of active denitrifiers in the gut may be explained by the fact that mussels are capable of feeding on a diet of bacteria due to high lysozyme content in their digestive organs (20, 32). Consequently, only a minor part of the ingested denitrifiers may survive and induce their denitrification genes during the gut passage in *D. polymorpha*.

Ammonium excretion by *D. polymorpha*

The availability of NH₃ (as substrate for ammonia oxidation) is usually low in natural freshwater systems but can be high in environments infested with *D. polymorpha* (5, 17). Ammonium excretion rates of *D. polymorpha* were measured by incubating groups of 1-8 living mussels (n = 6) in artificial freshwater without amendment of any N-sources. NH₄⁺ concentrations were quantified spectrophotometrically (2) every half hour for a total of three hours. The average excretion rate ± SD was 0.128 ± 0.063 μmol NH₄⁺ individual⁻¹ h⁻¹, which is >1000 times the N needed to explain the N₂O production by nitrification in shell biofilms. Therefore, a significant part of the mussels' N₂O emission is sustained by the animals' N excretion.

Environmental implications

The results presented here are important on three accounts. First, they provide quantitative data for the contribution of shell biofilms to the overall N₂O emission by a benthic freshwater invertebrate, hence extending earlier qualitative observations on marine invertebrates (11). Second, with a substantial part of N₂O produced via nitrification, which can be entirely fuelled by the mussels' own ammonia excretion, the data suggest that invertebrate-associated N₂O emissions can be decoupled from environmental nitrate concentrations, one of the main drivers of gut denitrification (19, 37, 38). In addition, biofilm nitrification may not only directly produce N₂O but may also provide nitrate for denitrification-derived N₂O production inside the mussel.

The data also show a considerable potential of the invasive *D. polymorpha* to contribute to overall N₂O emissions from zebra mussel-infested ecosystems. Maximum densities of up to 100,000 individuals per m² in the river Gudenå and a potential emission rate of 144 pmol N₂O ind⁻¹ h⁻¹ amount to an emission potential of 28 μmol N₂O-N m⁻² h⁻¹ for *D. polymorpha*, or up to 400 times the areal N₂O fluxes reported for (non-infested) freshwater environments (31). Finally, shell biofilms, ammonium excretion, and coupled nitrification-denitrification are likely to combine also for other freshwater and marine invertebrates into significant N₂O emission potentials (Heisterkamp et al., unpublished data). It should however be noted that for assessing their true environmental impact, in situ studies will be necessary, combining activity measurements and molecular analyses throughout the seasonal cycle.

Nucleotide sequence accession numbers

cDNA clone sequences obtained in this study have been deposited in GenBank under accession no. JF820296 to JF820311.

Acknowledgments

We thank Preben G. Sørensen and Britta Poulsen for expert help in the laboratory. This study was supported by the Danish Research Council and the German Science Foundation (grant STI202/6-1 to P.S.).

References

1. **Andersen, P., P. Grøn, and B. Moeslund.** 2009. Opsummering af foreliggende viden om vandremuslingens biologi og økologi med fokus på forekomsten i Danmark og betydningen for vandløbs- og søforvaltningen i Gudenå-systemet. Project report carried out by Orbicon A/S for the Gudenå committee at the municipality of Randers.
2. **Bower, C.E. and T. Holm-Hansen.** 1980. A salicylate-hypochlorite method for determining ammonia in seawater. *Can J Fish Aquat Sci* **37**:794-798.
3. **Crutzen, P. J.** (1970). The influence of nitrogen oxides on the atmospheric ozone content. *Quart. J. Roy. Met. Soc.* **96**:320-325.
4. **Forster, P. V., V. Ramaswamy, P. Artaxo, T. Berntsen, R. Betts, D. W. Fahey, J. Haywood, J. Lean, D. Lowe, G. Hyhre, J. Nganga, R. Prinn, G. Raga, M. Schulz, and R. Van Dorland.** (2007). Changes in atmospheric constituents and in radiative forcing. In: Solomon, S., Manning, M., Chen, Z., Marquis, M., Averyt, K.B., Tignor, M., Miller, H.L. (Eds.), *Climate Change 2007: The Physical Science Basis. Contribution of Working Group I to the Fourth Assessment Report of the Intergovernmental Panel on Climate Change.* Cambridge University Press, United Kingdom and USA.
5. **Gardner, W. S., J.F. Cavaletto, T.H. Johengen, J. R. Johnson, R. T. Heath, and J. B. Cotner.** 1995. Effects of the zebra mussel, *Dreissena polymorpha*, on community nitrogen dynamics in Saginaw Bay, Lake Huron. *J. Great Lakes Res.* **21**:529-544.
6. **Goreau, T. J., W. A. Kaplan, S. C. Wofsy, M. B. McElroy, F. W. Valois, and S. W. Watson.** 1980. Production of NO₂⁻ and N₂O by nitrifying bacteria at reduced concentrations of oxygen. *Appl. Environ. Microbiol.* **40**:526-532.
7. **Griffiths, R. I., A. S. Whiteley, A. G. O'Donnell, and M. J. Bailey.** 2000. Rapid method for coextraction of DNA and RNA from natural environments for analysis of ribosomal DNA- and rRNA-based microbial community composition. *Appl. Environ. Microbiol.* **66**:5488-5491.
8. **Hall, G. H.** (1984). Comparison of the nitrification inhibitors nitrapyrin and allylthiourea. *Microb. Ecol.* **10**:25-36.
9. **Hallin, S., and P. E. Lindgren.** (1999). PCR detection of genes encoding nitrite reductase in denitrifying bacteria. *Appl. Environ. Microbiol.* **65**:1652-1657.
10. **Hansen, J. W., B. Thamdrup, and B. B. Jørgensen,** 2000. Anoxic incubation of sediment in gas-tight plastic bags: a method for biogeochemical process studies. *Mar. Ecol. Prog. Ser.* **208**:273-282.
11. **Heisterkamp, I. M., A. Schramm, D. de Beer, and P. Stief.** 2010. Nitrous oxide production associated with coastal marine invertebrates. *Mar. Ecol. Prog. Ser.* **415**:1-9.
12. **Herrmann, M., A. M. Saunders, and A. Schramm.** 2009. Effect of lake trophic status and rooted macrophytes on community composition and abundance of ammonia-oxidizing prokaryotes in freshwater sediments. *Appl. Environ. Microbiol.* **75**:3127-3136.
13. **Horn, M. A., A. Schramm, and H. L. Drake.** 2003. The earthworm gut: an ideal habitat for ingested N₂O-producing microorganisms. *Appl. Environ. Microbiol.* **69**:1662-1669.
14. **Ihssen, J., M. Horn, A. Gößner, C. Matthies, A. Schramm, and H. L. Drake.** 2003. N₂O- producing microorganisms in the gut of the earthworm *Aporrectodea*

- caliginosa* are 206 indicative of ingested soil bacteria. Appl. Environ. Microbiol. **69**:1655-1661.
15. **Karsten, G. R., and H. L. Drake.** 1997. Denitrifying bacteria in the earthworm gastrointestinal tract and *in vivo* emission of nitrous oxide (N₂O) by earthworms. Appl. Environ. Microbiol. **63**: 1878-1882.
 16. **Koops, H- P., U. Purkhold, A. Pommerening-Röser, G. Timmermann, and M. Wagner.** 2006. The lithoautotrophic ammonia-oxidizing bacteria, p. 778–811. In: Dworkin, M., S. Falkow, E. Rosenberg, K- H. Schleifer, and E. Stackebrandt, (ed.), The prokaryotes: an evolving electronic resource for the microbiological community, 3rd ed. Springer-Verlag, New York, NY.
 17. **Lavrentyev, P. J., W. S. Gardner, and L. Yuan.** 2000. Effects of the zebra mussel on nitrogen dynamics and the microbial community at the sediment-water interface. Aquat. Microb. Ecol. **21**:187-194.
 18. **Ludwig, W., O. Strunk, R. Westram, L. Richter, H. Meier, Yadhukumar, A. Buchner, T. Lai, S. Steppi, G. Jobb, W. Forster, I. Brettske, S. Gerber, A. W. Ginhart, O. Gross, S. Grumann, S. Hermann, R. Jost, A. König, T. Liss, R. Lussmann, M. May, B. Nonhoff, B. Reichel, R. Strehlow, A. Stamatakis, N. Stuckmann, A. Vilbig, M. Lenke, T. Ludwig, A. Bode, and K.-H. Schleifer.** 2004. ARB: a software environment for sequence data. Nucleic Acids Res. **32**:1363-1371.
 19. **Matthies, C., A. Griebhammer, M. Schmittroth, and H. L. Drake.** (1999). Evidence for involvement of gut-associated denitrifying bacteria in emission of nitrous oxide (N₂O) by earthworms obtained from garden and forest soils. Appl. Environ. Microbiol. **65**: 3599-3604.
 20. **McHenry, J., G. J. Allen and T. H. Birkebeck.** (1986). Distribution of lysozyme-like activity in 30 bivalve species. Comp. Biochem. Physiol. **B 85**:581-584.
 21. **Michotey, V., V. Méjean, and P. Bonini.** 2000. Comparison of methods for quantification of cytochrome *cd1*-denitrifying bacteria in environmental marine samples. Appl. Environ. Microbiol. **66**:1564-1571.
 22. **Muyzer, G., E. D. De Waal, and A. G. Uitierlinden.** 1993. Profiling of complex microbial populations by denaturing gradient gel electrophoresis analysis of polymerase chain reaction-amplified genes coding for 16S rRNA. Appl. Environ. Microbiol. **59**:695-700.
 23. **Muyzer, G., A. Teske, and O. Wirsén.** 1995. Phylogenetic relationships of *Thiomicrospira* species and their identification in deep-sea hydrothermal vent samples by denaturing gradient gel electrophoresis of 16S rDNA fragments. Arch. Microbiol. **164**:165-172.
 24. **Nicolaisen, M. H., and N. B. Ramsing.** 2002. Denaturing gradient gel electrophoresis (DGGE) approaches to study the diversity of ammonia-oxidizing bacteria. J. Microb. Methods **50**:189–203.
 25. **Nicolaisen, M. H., J. Bælum, C. S. Jacobsen, and J. Sørensen.** 2008. Transcription dynamics of the functional *tfdA* gene during MCPA herbicide degradation by *Cupriavidus necator* AEO106 (pRO101) in agricultural soil. Environ. Microbiol. **10**:571-579.
 26. **Revsbech, N. P.** 1989. An oxygen microsensor with a guard cathode. Limnol. Oceanogr. **34**:474-478.
 27. **Rotthauwe, J., K. Witzel, and W. Liesack.** 1997. The ammonia monooxygenase structural gene *amoA* as a functional marker: molecular fine-scale analysis of natural ammonia-oxidizing populations. Appl. Environ. Microbiol. **63**:4704–4712.

28. **Santoro, A. E., C. Buchwald, M. R. McIlwin, and K. L. Casiotti.** 2011. Isotopic signature of N₂O produced by marine ammonia-oxidizing archaea. *Science* **333**:1282-1285.
29. **Sayavedra-soto, L. A., N. G. Hommes, S.A. Russel, and D. J. Arp.** 1996. Induction of ammonia monooxygenase and hydroxylamine oxidoreductase mRNAs by ammonium in *Nitrosomonas europaea*. *Mol. Microbiol.* **20**:541–548.
30. **Schreiber, F., B. Loeffler, L. Polerecky, M. Kuypers, and D. de Beer.** 2009. Mechanisms of transient nitric oxide and nitrous oxide production in a complex biofilm. *ISME J.* **3**:1301-1313.
31. **Seitzinger, S.P.** 1988. Denitrification in freshwater and coastal marine ecosystems: ecological and geochemical significance. *Limnol. Oceanogr.* **33**:702-724.
32. **Silverman, H., E. C. Achberger, J. W. Lynn, and T. H. Diets.** 1995. Filtration and utilization of laboratory-cultured bacteria by *Dreissena polymorpha*, *Corbicula jluminea*, and *Carunculina texasensis*. *Biol. Bull.* **189**:308-319.
33. **Smart, R. M., and J. W. Barko.** 1985. Laboratory culture of submersed freshwater macrophytes on natural sediments. *Aquat. Bot.* **21**:251-263.
34. **Stein, L. Y., and Y. L. Yung.** 2003. Production, isotopic composition, and atmospheric fate of biologically produced nitrous oxide. *Annu. Rev. Earth Planet. Sci.* **31**:329-356.
35. **Stief, P., and G. Eller.** 2006. The gut microenvironment of sediment-dwelling *Chironomus plumosus* larvae as characterised with O₂, pH, and redox microsensors. *J. Comp. Physiol. B* **176**:673–683.
36. **Stief, P., M. Poulsen, L. P. Nielsen, H. Brix, and A. Schramm.** 2009. Nitrous oxide emission by aquatic macrofauna. *Proc. Natl. Acad. Sci. USA* **106**:4296-4300.
37. **Stief, P., L. Polerecky, M. Poulsen, and A. Schramm.** 2010. Control of nitrous oxide emission from *Chironomus plumosus* larvae by nitrate and temperature. *Limnol Oceanogr* **55**:872–884.
38. **Stief, P., and A. Schramm.** 2010. Regulation of nitrous oxide emission associated with benthic invertebrates. *Freshwater Biology* **55**:1647-1657.
39. **Throbäck, I. N., K. Enwall, A. Jarvis, and S. Hallin.** 2004. Reassessing PCR primers targeting *nirS*, *nirK* and *nosZ* genes for community surveys of denitrifying bacteria with DGGE. *FEMS Microbiol. Ecol.* **49**:401–417.
40. **Zumft, W. G.** 1997. Cell biology and molecular basis of denitrification. *Microbiol. Mol. Biol. Rev.* **61**: 533-616.

Chapter 5



The Pacific White Shrimp *Litopenaeus vannamei* is a globally important aquacultured species that emits nitrous oxide at a high rate due to incomplete denitrification of ingested bacteria in its anoxic gut.

**Incomplete denitrification in the gut of
the aquacultured shrimp *Litopenaeus vannamei*
as source of nitrous oxide**

Ines M. Heisterkamp¹, Andreas Schramm², Dirk de Beer¹, Peter Stief¹

¹Microsensor Research Group, Max Planck Institute for Marine Microbiology,
Celsiusstraße 1, 28359 Bremen, Germany.

²Department of Bioscience, Microbiology, Aarhus University,
Ny Munkegade 114, 8000 Aarhus C, Denmark

Preliminary manuscript

Abstract

The Pacific White Shrimp *Litopenaeus vannamei* is a globally important aquaculture species that is reared at high animal densities, temperatures, and nutrient concentrations. This species was found to emit the greenhouse gas nitrous oxide (N₂O) at the highest rate recorded so far for any marine invertebrate species. Under *in situ* conditions of a recirculating aquaculture farm in Northern Germany (i.e. 28°C and 10 mmol L⁻¹ nitrate), *L. vannamei* emitted on average 4.33 nmol N₂O per individual and hour. Nitrous oxide emission of the shrimp derived primarily from N₂O production by ingested denitrifying bacteria in the animal's gut. The mean N₂O yield of gut denitrification (i.e. the fraction of N₂O produced per total nitrogen gas produced) was as high as 36.5%. This high N₂O yield was most probably caused by delayed induction of the N₂O reductase after ingestion of denitrifying bacteria from the oxic water column into the anoxic gut as demonstrated by oxic-anoxic shift experiments. Inhibition of the N₂O reductase by low oxygen concentrations or pH values was ruled out by microsensor measurements which revealed that the gut is completely anoxic and has a slightly alkaline milieu. The short gut passage time of only 1 h apparently prohibits the ingested denitrifiers from establishing complete denitrification to dinitrogen. In fact, the shrimp guts represent abundant microsites of incomplete denitrification that significantly contribute to the N₂O supersaturation of on average 2390% in the rearing tanks. In conclusion, microbial N₂O production directly associated with *L. vannamei* or other aquaculture species should be considered as important sources of N₂O in animal production.

Introduction

Aquaculture systems are usually characterized by high loads of nutrients, especially nitrogen, and accordingly are sites of intense nitrogen turnover, including the microbial processes of nitrification and denitrification (Crab et al. 2007, Hu et al. 2012). Both processes can produce nitrous oxide (N₂O), which is a potent greenhouse gas and the major ozone-depleting substance (Forster et al. 2007, Ravishankara et al. 2009). Aquaculture was therefore recently discussed as an important source of atmospheric N₂O (Williams & Crutzen 2010, Hu et al. 2012). It was estimated that the global N₂O emission from aquaculture currently accounts for 0.09-0.12 Tg N yr⁻¹ and will rise to 0.38-1.01 Tg N yr⁻¹ by 2030 due to the rapidly growing aquaculture industry (William & Crutzen 2010, Hu et al. 2012). Since capture fisheries has leveled off, aquaculture has become an important alternative for production of food fish, including finfishes, crustaceans, molluscs, and other aquatic animals, and has grown with an average annual rate of 8.3% since 1970 to a total production of 52.5 million tons in 2008 (FAO 2010). Crustaceans alone accounted for 5 million tons in 2008 of which 2.3 million tons were made up by one single species, the Pacific White Shrimp *Litopenaeus vannamei* (FAO 2010). The maximal estimated N₂O emission from aquaculture in 2030 would represent 18% and 5.7% of the current estimates of the total aquatic and the global N₂O emissions, respectively (Denman et al. 2007). However, so far direct measurements of N₂O emissions from aquaculture are missing and the current estimates are based on the overall nitrogen load of aquaculture systems and N₂O-emission factors that were derived from wastewater treatment plants (Williams & Crutzen 2010, Hu et al. 2012). It is highly uncertain whether these emission factors reflect the true N₂O yield of nitrogen cycling processes in aquaculture farms, since very little is known about the mechanisms and controlling factors of microbial N₂O production in aquaculture systems. The amount of N₂O produced by nitrification and denitrification depends on diverse factors such as oxygen concentration, pH, temperature, and availability of substrates, which can vary between different aquaculture systems and between different compartments of a single aquaculture system (Crab et al. 2007, Hu et al. 2012). Nitrification takes place in the water of the aerated rearing tanks, whereas denitrification occurs in anoxic niches of the bead bed or in floating organic particles (Holl et al. 2010). In recirculating aquaculture systems (RAS), biological treatment of the water is necessary to prevent

accumulation of nitrogen compounds such as ammonia and nitrite to toxic levels. Similar to waste water treatments plants, the aquaculture water is processed in external biofilters, in which nitrification and denitrification prevail at high rates due to massive microbial biomass in these filters (van Rijn 1996).

Additional microsites of microbial N₂O production that so far have been overlooked in aquaculture systems are represented by the guts of the reared animals. This is in so much surprising since many free-living terrestrial, freshwater, and marine invertebrate species are known as ecologically important N₂O-emitters (Karsten & Drake 1997, Stief et al. 2009, Heisterkamp et al. 2010). For earthworms and insect larvae, it has been shown that the gut microenvironment is characterized by anoxia and the presence of nitrate and labile organic carbon sources, which stimulates the denitrification activity of ingested bacteria (Horn et al. 2003, Stief & Eller 2006). The complete denitrification pathway involves four reduction steps ($\text{NO}_3^- \rightarrow \text{NO}_2^- \rightarrow \text{NO} \rightarrow \text{N}_2\text{O} \rightarrow \text{N}_2$), each of which is catalyzed by a specific enzyme (Zumft 1997). The N₂O reductase plays a key role because the presence/absence and the activity level of this enzyme determine whether denitrification acts as a source or sink of N₂O. A striking feature of denitrification in the gut of invertebrates is the high yield of N₂O that makes up 15 to 68% of the total nitrogen gas production (N₂O+N₂), compared to usually less than 1% in the sediment and water column of rivers, lakes, and coastal aquatic systems (Seitzinger 1988, Drake & Horn 2007, Stief et al. 2009, Beaulieu et al. 2010). Several environmental factors promote incomplete denitrification by acting upon the expression and activity levels of the N₂O reductase relative to the other three denitrification enzymes. In general, the N₂O/N₂ ratio of denitrification will be increased by hypoxic conditions, low pH, low temperature, high nitrate concentration, and low C/N ratio due to a low relative activity of the N₂O reductase (Bonin & Raymond 1990, Richardson et al. 2009, Bergaust et al. 2010, Hu et al. 2012). Furthermore, more N₂O will be produced than consumed, if the denitrifier community comprises many bacterial strains that do not possess the N₂O reductase gene and thus lack the ability to reduce N₂O to N₂ (Zumft 1997, Gregory et al. 2003). Additionally, the delayed induction of the N₂O reductase after sudden shifts from oxic to anoxic conditions may cause (transiently) high N₂O yields (Baumann et al. 1996, Kester et al. 1997). This scenario was hypothesized to occur during the feeding process of invertebrates, which abruptly transfers facultative

denitrifying bacteria from the ambient oxic environment into the anoxic gut (Drake et al. 2006, Stief et al. 2009).

To date, measurements of *in situ* N₂O emission rates from aquacultured invertebrates and detailed investigations on the factors controlling the N₂O yield of denitrification in the invertebrate guts are missing. This study therefore aimed at elucidating the *in situ* N₂O emission rate of the aquacultured Pacific White Shrimp *Litopenaeus vannamei* (also *Penaeus vannamei*, Boone 1931), and the major factors that might regulate the N₂O yield of gut denitrification in this species. The penaeid shrimp *L. vannamei* is the most important crustacean species in aquaculture worldwide and is reared in intensive aquaculture systems at high stocking densities, temperatures, and nutrient concentrations (Cuzon et al. 2004, Browdy & Jory 2009, FAO 2010).

Materials and Methods

Nitrous oxide emission rates from whole animals and dissected guts

L. vannamei specimens were obtained from a RAS in Northern Germany, in which they were reared at a temperature of $29.5 \pm 0.5^\circ\text{C}$, pH of 8.08 ± 0.14 , salinity of 19 ± 2 , dissolved organic carbon concentration of $20.6 \pm 7.0 \text{ mg L}^{-1}$, and a nitrate concentration of $9.13 \pm 3.73 \text{ mmol L}^{-1}$. Individuals with an average wet weight of $20.4 \pm 7.3 \text{ g}$ were kept in original aquaculture water until used for experiments. The animals were killed in ice-water immediately prior to incubation experiments or gut dissection. Whole animals were incubated in 100-mL glass bottles with 30 mL of 0.2- μm filtered aquaculture water that was aerated before use via an airstone. The bottles were sealed gas-tight with rubber stoppers. For incubating intact guts, freshly killed animals were dissected along their dorsal side by scissors and the gut was carefully removed from the animals by ethanol-rinsed forceps. Dissected complete guts (gut content + wall) were incubated in 6-mL exetainer vials (Labco, High Wycombe, UK) that contained 1 mL of aerated, 0.2- μm filtered aquaculture water. The headspace of all incubation vials was taken with atmospheric air. In addition to these oxic incubations, dissected complete guts and gut walls were also incubated under anoxic conditions in 6-mL exetainer vials that

contained 1 mL of N₂-flushed, 0.2- μ m filtered aquaculture water. As control, N₂-flushed, 0.2- μ m filtered aquaculture water was incubated in gas-tight 100-mL glass bottles. The headspace of all anoxic incubations was flushed by dinitrogen gas for 5 to 10 min. For each incubation assay, 4-15 replicates were run with 1 individual or dissected gut per incubation vial. Incubations were conducted at an average temperature of $28 \pm 2^\circ\text{C}$ for maximally 3 h. The incubation vials were placed on a shaker to enforce the equilibration of N₂O between water and headspace. Accumulation of N₂O was followed by regularly taking 1-mL headspace samples through the rubber stopper (every 15 to 60 min). Analysis of N₂O production by gas chromatography (GC 7890 Agilent Technologies) and calculation of N₂O emission rates were made as described in Heisterkamp et al. (2010).

Rate of total denitrification in dissected guts

The potential total denitrification (i.e. the production of N₂O+N₂) of dissected guts was measured with the acetylene inhibition technique (Sørensen 1978). Freshly dissected guts were incubated in 6-mL exetainers with 1 mL of N₂-flushed, 0.2- μ m filtered aquaculture water and were incubated in an atmosphere of 10% acetylene and 90% dinitrogen gas. Sampling, analysis of N₂O, and calculation of N₂O production rates were made as described above.

Microscale distribution of oxygen and pH in dissected guts

Microsensors for oxygen and pH measurements in dissected guts were constructed as previously described (Schulthess et al. 1981, Revsbech 1989). The tip diameters of the sensors were 10–20 μ m. The sensors were calibrated before, during, and after the measurements. Oxygen microsensors were calibrated in Ringer's solution (Merck, Germany) at 0 and 100% air-saturation by purging with dinitrogen gas and synthetic air, respectively. The pH sensors were calibrated in standard solutions of pH 7.0 and 9.0. Freshly dissected guts were fixed on an agarose bottom in a flow-cell, which was continuously flushed with oxygenated Ringer's solution (Stief & Eller 2006). Aided by a dissection microscope, the microsensor tip was positioned at the outer surface of the gut wall, which was then defined as depth zero. Vertical steady-state concentration profiles were recorded through the gut, starting 1 mm above the gut surface in the

oxygenated Ringer's solution and measuring in increments of 0.1 mm to maximal 3 mm below the gut surface into the agarose bottom. Profiles were run in the fore-, mid-, and hind gut at different degrees of gut filling. All measurements and calibrations were made at 28°C.

Nitrous oxide concentration and production rate in aquaculture water

The *in situ* concentration of N₂O in the aquaculture water was determined by filling 100 mL unfiltered aquaculture water into 125-mL gas-tight bottles (n = 10) that contained 4 mL saturated HgCl₂ to inhibit any biological activity. The bottles were shaken for several hours for equilibration of N₂O between water and headspace and afterwards the N₂O concentration in the headspace was analyzed by GC measurements. The N₂O concentration in the water was calculated after Weiss & Price (1980). Furthermore, unfiltered aquaculture water was aerated via an airstone and 100 mL of the oxygenated water was incubated in 100-mL glass bottles (n = 3) that were sealed with rubber stoppers. The water was continuously stirred with a glass-coated magnetic stirring bar. Water samples (3 mL) were taken every 20 min through the rubber stopper and transferred into N₂-flushed 6-mL exetainers. After 1 h of oxic incubation, the water in the bottles was flushed with dinitrogen gas for 10 min, the bottles were sealed again and the remaining headspace was purged with dinitrogen gas. After this oxic-anoxic shift, water samples (3 mL) were taken in regular time intervals for a total incubation period of 16 h. The headspace in the exetainers was analyzed for N₂O by GC measurements after equilibration of N₂O between water and gas phase. Calculation of N₂O production rates were made as described in Heisterkamp et al. (2010).

Results and Discussion

***In situ* rates and origin of nitrous oxide emission from shrimp**

Under *in situ* conditions (28°C, 10 mmol L⁻¹ nitrate), the aquacultured shrimp *L. vannamei* emitted N₂O with a mean rate of 4.33 nmol individual⁻¹ h⁻¹, equivalent to 0.20 nmol g⁻¹ wet weight h⁻¹ (Figure 1). On an individual basis, this is the highest rate

recorded for any aquatic invertebrate so far and is much higher than the average N₂O emission rates of coastal and freshwater invertebrate species from natural habitats that are 0.32 and 0.07 nmol ind.⁻¹ h⁻¹, respectively, at 21°C and *in situ* nitrate concentrations (0-0.45 mmol L⁻¹ nitrate, Stief et al. 2009, Heisterkamp et al. 2010). The *in situ* N₂O emission rate of *L. vannamei* determined in this study is 21% higher than the mean rate measured for *L. vannamei* specimens of the same size, but obtained from a different RAS and incubated at different conditions (21°C, 2 mmol L⁻¹ nitrate) (Heisterkamp et al. 2010). Microbial N₂O production associated with *L. vannamei* may thus be stimulated by temperature and/or nitrate as previously shown for terrestrial and freshwater invertebrate species (Karsten & Drake 1997, Matthies et al. 1999, Stief et al. 2010, Stief & Schramm 2010). The temperature of 28°C is in the typical range of rearing temperatures used for *L. vannamei* and the nitrate concentration was in the upper range of nitrate concentration reported for intensive aquaculture systems (Burford et al. 2003, Holl et al. 2010). The *in situ* rate reported here might therefore represent a typical *in situ* N₂O emission rate of *L. vannamei* in aquaculture systems.

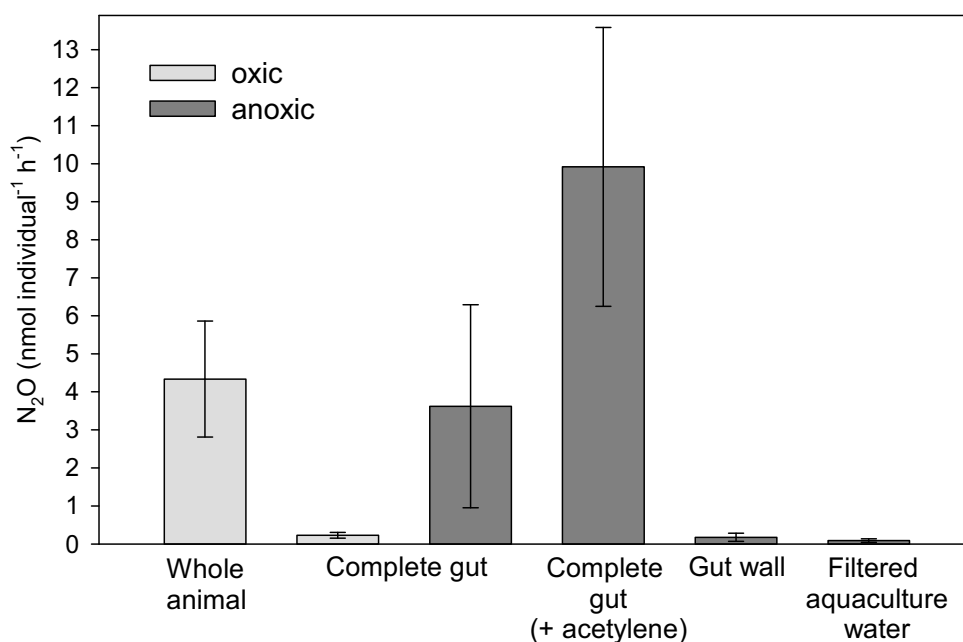

Figure 1: Rates of N₂O emission from the shrimp *Litopenaeus vannamei* and its dissected guts incubated in original 0.2- μ m filtered aquaculture water at 28°C. Whole animals of *L. vannamei* were incubated under oxic conditions; dissected complete guts (content + wall) were incubated under oxic and anoxic conditions; and gut walls only were incubated under anoxic conditions. Dissected complete guts of *L. vannamei* were also incubated under anoxic conditions with 10% acetylene, which inhibits the last step of denitrification. The resulting N₂O production indicates total denitrification. Filtered aquaculture incubated under anoxic conditions served as control (here, the N₂O production rate is presented as nmol L⁻¹ h⁻¹). Means \pm SD of n = 4 to 15 are shown.

The N₂O emitted from the shrimp was mainly produced in the animal's gut (Figure 1). Dissected complete guts (i.e. gut content + gut wall) incubated under anoxic conditions produced N₂O at a rate equivalent to 84% of the total N₂O emission rate of the whole animal. In contrast, the gut walls only produced minute amounts of N₂O under anoxic conditions. It can be ruled out that the filtered aquaculture water that was added to the incubation vials biased the results, as the negative control produced only trace amounts of N₂O (9×10^{-5} nmol mL⁻¹ h⁻¹). Hence, N₂O production mainly took place in the gut contents, which strongly indicates that N₂O production in the shrimp gut is primarily mediated by ingested microbes. Incubation of complete guts under oxic conditions resulted in a N₂O emission rate 16 times lower than that under anoxic conditions. These findings suggest that N₂O production associated with *L. vannamei* is mainly due to denitrification by ingested bacteria in the anoxic gut of the animal. This is in accordance with observations made for freshwater and terrestrial invertebrates where ingested denitrifiers are the key players in N₂O production (Ihssen et al. 2003, Horn et al. 2006, Stief et al. 2009). The bacterial abundance in aquaculture water is generally high due to the copious supply of inorganic and organic nutrients and can reach up to 3.9×10^8 cells mL⁻¹ in RAS (Burford et al. 2003, Browdy & Jory 2009, Holl et al. 2010). *L. vannamei* mainly takes up particle-attached microorganisms by feeding on particulate organic matter and uses these microorganisms as additional food source (Avnimelech 1999, De Schryver et al. 2008). The N₂O production measured in the gut suggests, however, that at least part of the ingested microorganisms survive and remain or even become metabolically active in the gut, including facultative denitrifying bacteria.

We therefore specifically tested for the denitrification potential of the shrimp gut. Under anoxic conditions, the total denitrification rate of complete guts was on average 9.9 nmol ind.⁻¹ h⁻¹ (192 nmol g⁻¹ wet weight h⁻¹) compared to the mean net rate of N₂O production of 3.6 ind.⁻¹ h⁻¹ (70 nmol g⁻¹ wet weight h⁻¹) (Figure 1). The N₂O/N₂ ratio of gut denitrification was thus on average 0.57, resulting in the mean N₂O yield of 36.5% from total denitrification (N₂O/N₂O+N₂). This value is in the same range as observed for denitrification in the gut of freshwater insect larvae and terrestrial earthworms and is much higher than the N₂O yields of usually below 1% in aquatic sediments and water columns (Seitzinger 1988, Drake & Horn 2007, Bange 2008, Stief et al. 2009). Aside from true denitrifiers, also nitrate-reducing (NO₃⁻ → NO₂⁻) and nitrate-ammonifying bacteria (NO₃⁻ → NH₄⁺) might have contributed to the N₂O

production in the anoxic gut. However, these bacteria produce N₂O as by-product at much lower production rates than true denitrifiers (Drake & Horn 2007). Additionally, earthworm guts were shown to exhibit only a minor capacity of nitrate ammonification (Ihssen et al. 2003). Furthermore, it is very unlikely that nitrification contributed to the N₂O production under anoxic conditions, since anoxia generally precludes nitrification activity. Under oxic conditions, the low N₂O production rate might be due to nitrification activity. However, as the gut is probably completely anoxic under *in vivo* conditions (see below), the N₂O emission rates of dissected guts measured under anoxic conditions are very likely to reflect *in vivo* N₂O emission rates and nitrification does not contribute to N₂O production under *in vivo* conditions. The stimulation of the N₂O emission rate of *L. vannamei* by temperature and nitrate concentration can be expected to be controlled in the same way as reported for freshwater invertebrates (Stief et al. 2009). The temperature of 28°C is within the optimal range for *L. vannamei* (Wyban et al. 1995, Ponce-Palafox et al. 1997) and for denitrifying bacteria (Klotz et al. 2011), and is likely to promote high feeding rates of *L. vannamei* and high metabolic rates of denitrifying bacteria. Both parameters have the potential to increase N₂O emission from *L. vannamei* via higher cell numbers of ingested bacteria and/or higher denitrification rates inside the gut (Stief et al. 2009, Stief & Schramm 2010). Since shrimp feed on water-soaked food particles and also drink water at a rate of ca. 10 µL g⁻¹ wet weight h⁻¹ (Dall & Smith 1977), the nitrate concentration in the gut was probably also in the millimolar range. Such high nitrate concentrations may not only stimulate the total denitrification rate, but also specifically inhibit the N₂O reductase and thus increase the N₂O yield of denitrification (Blackmer & Bremner 1978).

Factors controlling the nitrous oxide yield in gut denitrification

The high fraction of incomplete denitrification in the shrimp gut may result from the inhibition of the N₂O reductase by the presence of oxygen or by low pH values in the animal's gut (Zumft 1997, Bergaust et al. 2010). However, microsensor measurements revealed that filled dissected guts of *L. vannamei* rapidly consumed oxygen that diffused from the air-saturated Ringer's solution into the gut, resulting in anoxic conditions throughout almost the entire gut diameter (Figure 2 A). Even in empty guts, the diffusion of oxygen from the air-saturated Ringer's solution could not fully oxygenate the entire gut, since the core of the gut remained hypoxic (Figure 2 B). No

obvious variation in oxygen concentrations along the gut axis was observed in filled and in empty guts (Figure 2 A+B).

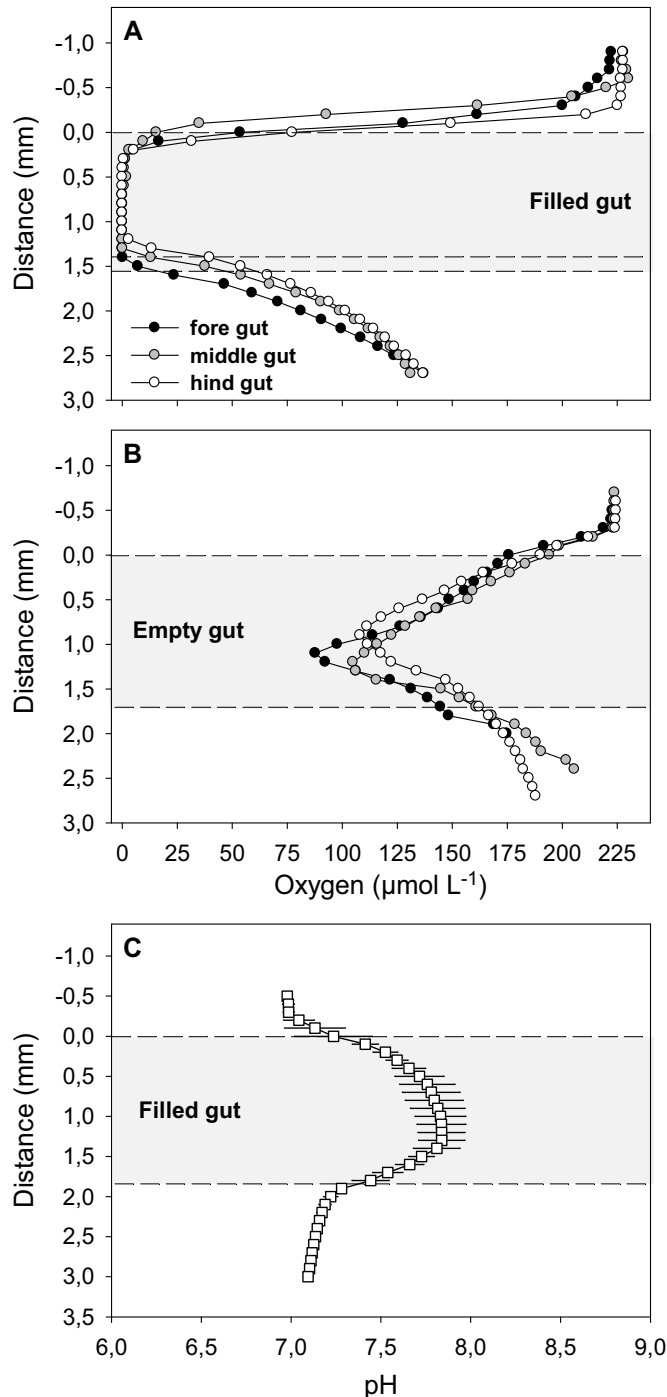

Figure 2: Transversal microprofiles of oxygen and pH through dissected guts of *Litopenaeus vannamei*. Dissected guts were fixed on an agarose bottom in a flow-cell that was continuously supplied with air-saturated Ringer's solution. Grey area indicates gut interior and dashed lines indicate gut walls. Upper and lower white areas indicate Ringer's solution and agarose bottom, respectively. **A:** Oxygen concentration profiles through filled guts at fore, middle, and hind position. **B:** Oxygen concentration profiles through empty guts at fore, middle, and hind position. For A and B, single representative profiles are shown. **C:** pH profile (mean \pm SD, n = 6) through filled guts calculated from pH profiles measured in fore-, mid-, and hind guts.

Under *in vivo* conditions, the oxygen flux into the gut is probably much lower than after dissection. The hemolymph surrounding the shrimp's gut has typically a much lower oxygen concentration (ca. 2-3 $\mu\text{mol L}^{-1}$ O₂) than the air-saturated Ringer's solution

(Chen & Cheng 1995, Lin & Chen 2001). Therefore, it can be assumed that under *in vivo* conditions the entire gut is anoxic even when it is not completely filled. Hypoxic conditions may only prevail in empty guts. The number of bacteria in empty guts is much lower than in filled guts, which is also supported by very low N₂O emission rates (Figure 1). The high N₂O yield of denitrification in the gut of *L. vannamei* is therefore probably not explained by the inhibition of the N₂O reductase by oxygen, since gradients of oxygen along the gut radius or the gut axis are unlikely to occur in filled denitrifying guts. Furthermore, it is unlikely that the N₂O reductase is inhibited by pH, given the fact that the pH in the gut is 7.6-7.8 and thus favourable for complete denitrification and no greater changes in pH were observed along the gut axis (Figure 2 C). A pH of below 6.5-6.8 was reported to be critical for the functioning of the N₂O reductase and a pH of 6.0 almost completely inhibits the reduction of N₂O to N₂ (Baumann et al. 1997, Bergaust et al. 2010).

The high N₂O yield of denitrification in the gut of *L. vannamei* may result from the delayed expression of the N₂O reductase. This scenario seems likely because of the very short gut residence time of ingested bacteria in *L. vannamei* of only about 1 h (Beseres et al. 2005). When water samples (and the microorganisms contained therein) from the rearing tank were experimentally transferred from oxic to anoxic conditions, N₂O production was immediately stimulated and increased by a factor of 4.5 to a rate of $0.92 \pm 0.18 \text{ nmol L}^{-1} \text{ h}^{-1}$ compared to the very low N₂O production rate of $0.20 \pm 0.28 \text{ nmol L}^{-1} \text{ h}^{-1}$ under oxic conditions (Figure 3).

This indicates that the oxic-anoxic shift makes facultative anaerobic bacteria switch metabolically from aerobic respiration to denitrification with at first unbalanced enzyme activities. Immediately after the oxic-anoxic shift, an accumulation of N₂O was observed, which started to disappear after a period of at least 2.5 to 3.5 h, indicating the incipient activity of the N₂O reductase (Figure 3). This strongly suggests that facultative denitrifying bacteria that are ingested by *L. vannamei* get activated in the anoxic gut of the shrimp, but the gut passage time of approximately 1 h does not allow them to balance the expression of the four denitrification genes. It seems that the induction of the N₂O reductase is initially weaker or lags behind that of the other denitrifying enzymes, which consequently causes high N₂O yields of denitrification during the short gut passage time. Similarly high N₂O yields of gut denitrification are reported for the

larvae of the insect *Chironomus plumosus* that has a gut passage time of 2 to 3 h (Stief et al. 2009). The gut passage time seems thus to be an important factor regulating the N₂O yield of denitrification in the gut of invertebrates. The transient accumulation of N₂O after shifts from oxic to anoxic conditions was also shown for several pure cultures of denitrifiers (Baumann et al. 1996, Otte et al. 1996, Kester et al. 1997, Bergaust et al. 2008). The time required to balance denitrification enzyme activity and perform complete denitrification after the oxic-anoxic shift varies with species and culture conditions. The community composition of denitrifiers ingested by *L. vannamei* might therefore play an important role. For some species of denitrifying bacteria, gut passage times of 1-3 h might be too short to express the full set of genes, while other species might switch to complete denitrification within a few minutes. Furthermore, the denitrifying community may comprise many species that are not even capable of complete denitrification because they lack the gene encoding the N₂O reductase. It is estimated that N₂O-respiring taxa make up only 10-15% of all known denitrifying taxa (Zumft & Kroneck 2007). N₂O-reducing taxa might be underrepresented in the highly nitrate-enriched RAS, since the reduction of N₂O is inhibited by high nitrate concentrations (Blackmer & Bremner 1978, Richardson et al. 2009).

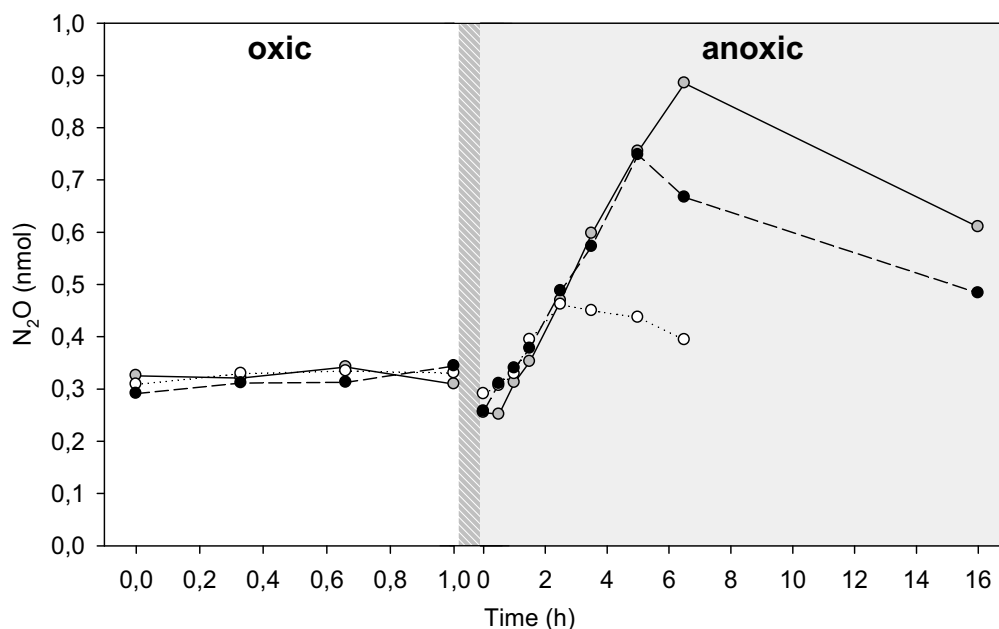

Figure 3: Induction of N₂O production in aquaculture water by anoxia. Left white panel shows N₂O emission in three replicate incubations of aquaculture water under oxic conditions for a period of 1 h. Shaded area indicates shift from oxic to anoxic conditions. Right grey panel shows N₂O emission from aquaculture water in the same three replicates under anoxic conditions during an incubation period of 16 h.

Relevance of nitrous oxide emission from *L. vannamei*

The water in the rearing tanks of *L. vannamei* contained a mean N₂O concentration of $160 \pm 17 \text{ nmol L}^{-1}$, which corresponds to a supersaturation of $2390 \pm 257\%$ compared to the atmospheric equilibrium concentration of 6.67 nmol L^{-1} . The permanent aeration of the shallow rearing tanks leads to continuous water movement and air stripping, which probably results in high N₂O fluxes to the atmosphere. Aquaculture farming of *L. vannamei* thus represents a source of atmospheric N₂O.

Nitrous oxide emission by *L. vannamei* accounted for $2.17 \text{ nmol L}^{-1} \text{ h}^{-1}$ at a density of $0.5 \text{ individuals L}^{-1}$, which is equivalent to $100 \text{ individuals m}^{-2}$ and represents a common stocking density in RAS (Browdy & Jory 2009, Krummenauer et al. 2011). The N₂O production in the aquaculture water under oxic conditions was $0.2 \text{ nmol L}^{-1} \text{ h}^{-1}$ and thus 10 times lower than by the shrimp. Under anoxic conditions, the initial rate of N₂O production in the aquaculture water increased compared to the rate under oxic conditions, but was still less than half of the shrimp-associated N₂O production rate. Hence, denitrification in the aquaculture water under non-steady state conditions obviously produced more N₂O than nitrification under completely oxic conditions. In any case, the microorganisms in the small gut of the shrimp produced more N₂O than the microorganisms contained in 1 Liter of aquaculture water. These findings suggest that the supersaturation of the water is to a considerable extent due to microbial N₂O production associated with *L. vannamei*. The steady-state concentration of 160 nmol L^{-1} N₂O in the water of the rearing tank could theoretically be built up solely from N₂O emission of *L. vannamei* within 3 days, assuming no release of N₂O to the atmosphere, no N₂O consumption in the aquaculture water, and no dilution (the water exchange rate in the RAS was only about 1-3% per day).

However, the N₂O production rate of the aquaculture water measured under fully oxic conditions is probably an underestimate of *in situ* N₂O emission from the rearing tanks. High net N₂O production rates are typically observed under hypoxic conditions, since the N₂O yield of both nitrification and denitrification increases under suboptimal conditions (Goreau et al. 1980, Bonin & Raymond 1990). Oxygen concentrations in aquaculture systems can vary greatly and are often lower than at air saturation due to high respiration rates in the densely colonized rearing tanks (Cuzon et al. 2004). Higher

N₂O production rates than measured under fully oxic conditions might therefore prevail under hypoxic conditions in the water column and especially in the low-oxygen microsites of organic particles. Additionally, the rates of nitrification and denitrification (and concomitant N₂O production) vary greatly between the different compartments of aquaculture systems. About 75-100% of the volume of the aquaculture water is pumped through nitrification biofilters hourly. In these biofilters, nitrification rates and possibly also N₂O production rates are much higher than in the water from the rearing tanks due to a large nitrifying biomass. N₂O production rates of 0.5-4 μmol L⁻¹ h⁻¹ were reported for a nitrifying biofilter in a wastewater treatment plant, although the N₂O yield from nitrification was only 0.4% (Tallec et al. 2006). Whether N₂O production rates in the biofilters of the RAS investigated here are similarly high, still needs to be investigated. In addition, N₂O production might also take place in organic food particles and in floating feces that are probably characterized by steep oxygen gradients and an anoxic core. Feces might be hotspots of N₂O production, since they are enriched in active denitrifiers that once more experience a sudden shift in oxygen concentration when being voided into the oxic rearing water. Taken together, the supersaturation of N₂O in the aquaculture water is probably caused by many different N₂O sources. The high *in situ* N₂O emission rate of *L. vannamei* and its high density in the RAS, however, suggests that the shrimp significantly contributes to the N₂O supersaturation of the aquaculture water and thus to emission of N₂O to the atmosphere.

Conclusion and Outlook

The gut of the aquacultured shrimp *L. vannamei* constitutes an anoxic microsite of massive N₂O production by incomplete denitrification of ingested bacteria. The high N₂O yield of gut denitrification is apparently due to the gut passage time of only 1 h, which may be too short for many of the ingested denitrifiers to establish the complete denitrification pathway. There are no indications that the N₂O reductase of the ingested denitrifiers is inhibited by unfavourable conditions in the gut of *L. vannamei*. Further investigations are underway that assess the relative abundance and expression levels of denitrification genes and the microbial community composition in different sections of the gut and the water column. This is expected to shed light upon the fate and activity of

ingested facultative denitrifiers in the animal's gut. The *in situ* N₂O emission rates of *L. vannamei* suggest that the shrimp significantly contributes to the overall N₂O emission from aquaculture farms. A direct comparison of N₂O production in the different compartments of aquaculture systems, including the aquaculture water, suspended feces and food pellets, animal guts, and the integrated biofilters, would be highly desirable. In the light of the fast-growing aquaculture industry, especially of penaeid shrimp species like *L. vannamei*, it is important to gain insight into the mechanisms and controlling factors of N₂O production in aquacultures.

References

- Avnimelech Y (1999) Carbon nitrogen ratio as a control element in aquaculture systems. *Aquaculture* 176:227-235
- Bange HW (2008) Gaseous nitrogen compounds (NO, N₂, NH₃) in the ocean. In: Douglas G Capone, Deborah A Bronk, Margaret R Mulholland and Edward J Carpenter (eds) *Nitrogen in the marine environment*. Elsevier Academic Press, pp 51-94
- Baumann B, Snozzi M, Zehnder AJB, vanderMeer JR (1996) Dynamics of denitrification activity of *Paracoccus denitrificans* in continuous culture during aerobic-anaerobic changes. *Journal of Bacteriology* 178:4367-4374
- Baumann B, vanderMee JR, Snozzi M, Zehnder AJB (1997) Inhibition of denitrification activity but not of mRNA induction in *Paracoccus denitrificans* by nitrite at a suboptimal pH. *Antonie Van Leeuwenhoek International Journal of General and Molecular Microbiology* 72:183-189
- Beaulieu JJ, Tank JL, Hamilton SK, Wollheim WM, Hall RO, Mulholland PJ, Peterson BJ, Ashkenas LR, Cooper LW, Dahm CN, Dodds WK, Grimm NB, Johnson SL, McDowell WH, Poole GC, Valett HM, Arango CP, Bernot MJ, Burgin AJ, Crenshaw CL, Helton AM, Johnson LT, O'Brien JM, Potter JD, Sheibley RW, Sobota DJ, Thomas SM (2010) Nitrous oxide emission from denitrification in stream and river networks. *Proceedings of the National Academy of Sciences of the United States of America* 108:214-219
- Bergaust L, Mao YJ, Bakken LR, Frostegard A (2010) Denitrification Response Patterns during the Transition to Anoxic Respiration and Posttranscriptional Effects of Suboptimal pH on Nitrous Oxide Reductase in *Paracoccus denitrificans* (vol 76, pg 6387, 2010). *Applied and Environmental Microbiology* 76:8285-8285
- Bergaust L, Shapleigh J, Frostegard A, Bakken L (2008) Transcription and activities of NO_x reductases in *Agrobacterium tumefaciens*: the influence of nitrate, nitrite and oxygen availability. *Environmental Microbiology* 10:3070-3081
- Beseres JJ, Lawrence AL, Feller RJ (2005) Variation in fiber, protein, and lipid content of shrimp feed - Effects on gut passage times measured in the field. *Journal of Shellfish Research* 24:301-308
- Blackmer AM, Bremner JM (1978) Inhibitory effect of nitrate on reduction of N₂O to N₂ by soil microorganisms *Soil Biology & Biochemistry* 10:187-191
- Bonin P, Raymond N (1990) Effects of Oxygen on Denitrification in Marine-Sediments. *Hydrobiologia* 207:115-122
- Browdy, CL, Jory DE (2009) The Rising Tide, Proceedings of the Special Session on Sustainable Shrimp Farming, Aquaculture 2009. The World Aquaculture Society, Baton Rouge Louisiana, USA.
- Burford MA, Thompson PJ, McIntosh RP, Bauman RH, Pearson DC (2003) Nutrient and microbial dynamics in high-intensity, zero-exchange shrimp ponds in Belize. *Aquaculture* 219:393-411
- Chen JC, Cheng SY (1995) Hemolymph oxygen content, oxyhemocyanin, protein levels and ammonia excretion in the shrimp *Penaeus monodon* exposed to ambient nitrite *Journal of Comparative Physiology B-Biochemical Systemic and Environmental Physiology* 164:530-535
- Crab R, Avnimelech Y, Defoirdt T, Bossier P, Verstraete W (2007) Nitrogen removal techniques in aquaculture for a sustainable production. *Aquaculture* 270:1-14

- Cuzon G, Lawrence A, Gaxiola G, Rosas C, Guillaume J (2004) Nutrition of *Litopenaeus vannamei* reared in tanks or in ponds. *Aquaculture* 235:513-551
- Dall W, Smith DM (1977) Measurement of water drinking rates in marine Crustacea. *Journal of Experimental Marine Biology and Ecology* 30:199-208
- Denman, KL, Brasseur G, Chidthaisong A, Ciais P, Cox PM, Dickinson RE, Hauglustaine D, Heinze C, Holland E, Jacob D, Lohmann U, Ramachandran S, da Silva Dias PL, Wofsy SC, and Zhang X (2007): Couplings Between Changes in the Climate System and Biogeochemistry. In: *Climate Change 2007: The Physical Science Basis. Contribution of Working Group I to the Fourth Assessment Report of the Intergovernmental Panel on Climate Change* [Solomon S, Qin D, Manning M, Chen Z, Marquis M, Averyt KB, Tignor M, and Miller HL (eds.)]. Cambridge University Press, Cambridge, United Kingdom and New York, NY, USA.
- De Schryver P, Crab R, Defoirdt T, Boon N, Verstraete W (2008) The basics of bio-flocs technology: The added value for aquaculture. *Aquaculture* 277:125-137
- Drake HL, Horn MA (2007) As the worm turns: The earthworm gut as a transient habitat for soil microbial biomes. *Annual Review of Microbiology* 61:169-189
- Drake HL, Schramm A, Horn MA (2006) Earthworm gut microbial biomes: their importance to soil microorganisms, denitrification, and the terrestrial production of the greenhouse gas N₂O. In: König H, Varma A (eds) *Soil biology, Vol 6. Intestinal microorganisms of soil invertebrates*. Springer-Verlag, Heidelberg, pp 65-87
- Forster P, Ramaswamy V, Artaxo P, Berntsen T, Betts T, Fahey DW, Haywood J, Lean J, Lowe DC, Myhre G, Nganga J, Prinn R, Raga G, Schulz M, and Van Dorland R, (2007): Changes in Atmospheric Constituents and in Radiative Forcing. In: *Climate Change 2007: The Physical Science Basis. Contribution of Working Group I to the Fourth Assessment Report of the Intergovernmental Panel on Climate Change* [Solomon S, Qin D, Manning M, Chen Z, Marquis M, Averyt KB, Tignor M, and Miller HL (eds.)]. Cambridge University Press, Cambridge, United Kingdom and New York, NY, USA.
- FAO. The State of World Fisheries and Aquaculture, 2010; Food and Agricultural Organization of the United Nations: Rome, Italy, 2010.
- Goreau TJ, Kaplan WA, Wofsy SC, McElroy MB, Valois FW, Watson SW (1980) Production of NO₂- and N₂O by Nitrifying Bacteria at Reduced Concentrations of Oxygen. *Applied and Environmental Microbiology* 40:526-532
- Gregory LG, Bond PL, Richardson DJ, Spiro S (2003) Characterization of a nitrate-respiring bacterial community using the nitrate reductase gene (*narG*) as a functional marker. *Microbiology-Sgm* 149:229-237
- Heisterkamp IM, Schramm A, de Beer D, Stief P (2010) Nitrous oxide production associated with coastal marine invertebrates. *Marine Ecology-Progress Series* 415:1-9
- Holl CM, Glazer CT, Moss SM (2010) Nitrogen stable isotopes in recirculating aquaculture for super-intensive shrimp production: Tracing the effects of water filtration on microbial nitrogen cycling. *Aquaculture* 311:146-154
- Horn MA, Drake HL, Schramm A (2006) Nitrous oxide reductase genes (*nosZ*) of denitrifying microbial populations in soil and the earthworm gut are phylogenetically similar. *Applied and Environmental Microbiology* 72:1019-1026

- Horn MA, Schramm A, Drake HL (2003) The earthworm gut: An ideal habitat for ingested N₂O-producing microorganisms. *Applied and Environmental Microbiology* 69:1662-1669
- Hu Z, Lee JW, Chandran K, Kim S, Khnal SK (2012) Nitrous oxide (N₂O) emission from aquaculture: a review. *Environmental Science & Technology*, published online ahead of print
- Ihssen J, Horn MA, Matthies C, Gossner A, Schramm A, Drake HL (2003) N₂O - producing microorganisms in the gut of the earthworm *Aporrectodea caliginosa* are indicative of ingested soil bacteria. *Applied and Environmental Microbiology* 69:1655-1661
- Karsten GR, Drake HL (1997) Denitrifying bacteria in the earthworm gastrointestinal tract and in vivo emission of nitrous oxide (N₂O) by earthworms. *Applied and Environmental Microbiology* 63:1878-1882
- Kester RA, deBoer W, Laanbroek HJ (1997) Production of NO and N₂O by pure cultures of nitrifying and denitrifying bacteria during changes in aeration. *Applied and Environmental Microbiology* 63:3872-3877
- Klotz, MG Research on nitrification and related processes, Part 1. In *Methods Enzymology*; Klotz, MG, Eds.; Academic Press: San Diego, 2011; pp 349.
- Krummenauer D, Peixoto S, Cavalli RO, Poersch LH, Wasielesky W (2011) Superintensive Culture of White Shrimp, *Litopenaeus vannamei*, in a Biofloc Technology System in Southern Brazil at Different Stocking Densities. *Journal of the World Aquaculture Society* 42:726-733
- Lin CH, Chen JC (2001) Hemolymph oxyhemocyanin and protein levels and acid-base balance in the tiger shrimp *Penaeus monodon* exposed to copper sulfate. *Journal of the World Aquaculture Society* 32:335-341
- Matthies C, Griesshammer A, Schmittroth M, Drake HL (1999) Evidence for involvement of gut-associated denitrifying bacteria in emission of nitrous oxide (N₂O) by earthworms obtained from garden and forest soils. *Applied and Environmental Microbiology* 65:3599-3604
- Otte S, Grobden NG, Robertson LA, Jetten MSM, Kuenen JG (1996) Nitrous oxide production by *Alcaligenes faecalis* under transient and dynamic aerobic and anaerobic conditions. *Applied and Environmental Microbiology* 62:2421-2426
- Ponce-Palafox J, Martinez-Palacios CA, Ross LG (1997) The effects of salinity and temperature on the growth and survival rates of juvenile white shrimp, *Penaeus vannamei*, Boone, 1931. *Aquaculture* 157:107-115
- Ravishankara AR, Daniel JS, Portmann RW (2009) Nitrous Oxide (N₂O): The Dominant Ozone-Depleting Substance Emitted in the 21st Century. *Science* 326:123-125
- Revsbech NP (1989) An Oxygen Microsensor with a Guard Cathode. *Limnology and Oceanography* 34:474-478
- Richardson D, Felgate H, Watmough N, Thomson A, Baggs E (2009) Mitigating release of the potent greenhouse gas N(2)O from the nitrogen cycle - could enzymic regulation hold the key? *Trends in Biotechnology* 27:388-397
- Schulthess P, Shijo Y, Pham HV, Pretsch E, Ammann D, Simon W (1981) A hydrogen ion-selective liquid membrane electrode based on tri-n-dodecylamine as neutral carrier. *Analytica Chimica Acta* 131:111-116
- Seitzinger SP (1988) Denitrification in Fresh-Water and Coastal Marine Ecosystems - Ecological and Geochemical Significance. *Limnology and Oceanography* 33:702-724

- Sørensen J (1978) Denitrification Rates in a Marine Sediment as Measured by Acetylene Inhibition Technique. *Applied and Environmental Microbiology* 36:139-143
- Stief P, Eller G (2006) The gut microenvironment of sediment-dwelling *Chironomus plumosus* larvae as characterised with O₂, pH, and redox microsensors. *Journal of Comparative Physiology B-Biochemical Systemic and Environmental Physiology* 176:673-683
- Stief P, Polerecky L, Poulsen M, Schramm A (2010) Control of nitrous oxide emission from *Chironomus plumosus* larvae by nitrate and temperature. *Limnology and Oceanography* 55:872-884
- Stief P, Poulsen M, Nielsen LP, Brix H, Schramm A (2009) Nitrous oxide emission by aquatic macrofauna. *Proceedings of the National Academy of Sciences of the United States of America* 106:4296-4300
- Stief P, Schramm A (2010) Regulation of nitrous oxide emission associated with benthic invertebrates. *Freshwater Biology* 55:1647-1657
- Tallec G, Garnier J, Gousailles M (2006) Nitrogen removal in a wastewater treatment plant through biofilters: nitrous oxide emissions during nitrification and denitrification. *Bioprocess and Biosystems Engineering* 29:323-333
- vanRijn J (1996) The potential for integrated biological treatment systems in recirculating fish culture - A review. *Aquaculture* 139:181-201
- Weiss RF, Price BA (1980) Nitrous-oxide solubility in water and seawater. *Marine Chemistry* 8:347-359
- Williams J, Crutzen PJ (2010) Nitrous oxide from aquaculture. *Nature Geoscience* 3:143-143
- Wyban J, Walsh WA, Godin DM (1995) Temperature effects on growth, feeding rate and feed conversion of the Pacific white shrimp (*Penaeus vannamei*). *Aquaculture* 138:267-279
- Zumft WG (1997) Cell biology and molecular basis of denitrification. *Microbiology and Molecular Biology Reviews* 61:533-616
- Zumft WG, Kroneck PMH (2007) Respiratory transformation of nitrous oxide (N₂O) to dinitrogen by Bacteria and Archaea. In: *Advances in Microbial Physiology*, Vol 52, Vol 52, p 107-227

Chapter 6



The polychaete *Hediste diversicolor* is one of the most important bioturbating species in temperate coastal marine sediments that influences nitrogen cycling by changing physico-chemical conditions in its surrounding.

**Indirect control of the intracellular nitrate pool
of intertidal sediment by the
polychaete *Hediste diversicolor***

Ines M. Heisterkamp, Anja Kamp, Angela T. Schramm,
Dirk de Beer, and Peter Stief

Max Planck Institute for Marine Microbiology, Microsensor Group,
Celsiusstraße 1, 28359 Bremen, Germany

***Marine Ecology Progress Series* 445:181-192, 2012**

Abstract

In an intertidal flat of the German Wadden Sea, a large sedimentary pool of intracellular nitrate was discovered that by far exceeded the pool of nitrate that was freely dissolved in the porewater. Intracellular nitrate was even present deep in anoxic sediment layers where it might be used for anaerobic respiration processes. The origin and some of the ecological controls of this intracellular nitrate pool were investigated in a laboratory experiment. Sediment microcosms were set up with and without the abundant polychaete *Hediste diversicolor* that is known to stimulate nitrate production by microbial nitrification in the sediment. Additional treatments were amended with ammonium to mimic ammonium excretion by the worms or with allylthiourea (ATU) to inhibit nitrification by sediment bacteria. *H. diversicolor* and ammonium increased, while ATU decreased the intracellular nitrate pool in the sediment. Microsensor profiles of porewater nitrate showed that bacterial nitrification was enhanced by worms and ammonium addition. Thus, nitrification formed an important nitrate supply for the intracellular nitrate pool in the sediment. The vertical distribution of intracellular nitrate matched that of the photopigments chlorophyll *a* and fucoxanthin, strongly suggesting that diatoms were the main nitrate-storing organisms. Intracellular nitrate formation is thus stimulated by the interaction of phylogenetically distant groups of organisms: Worms enhance nitrification by feeding on particulate organic matter, excreting ammonium, and oxygenating the sediment. Bacteria oxidise ammonium to nitrate in oxic sediment layers, and diatoms store nitrate intracellularly.

Introduction

Several phylogenetically distant groups of sediment microorganisms are able to store nitrate in their cells. Large sulphur bacteria (Schulz & Jørgensen 2001), foraminifera (Risgaard-Petersen et al. 2006, Pina-Ochoa et al. 2010), and microalgae (Garcia-Robledo et al. 2010, Kamp et al. 2011) store nitrate at millimolar concentrations, while in their direct environment porewater nitrate is available only at micromolar concentrations. Thus, the uptake of nitrate into the cell occurs against a steep concentration gradient and costs metabolic energy (Høgslund et al. 2008). Storage of nitrate is of obvious advantage in environments with fluctuating nutrient concentrations. Also, intracellular nitrate is known to be used for respiration in anoxic sediment layers. The high nitrate storage capacity of large sulphur bacteria enables them to survive long periods of anoxia when intracellular nitrate is respired to ammonium (Preisler et al. 2007, Høgslund et al. 2009). Respiratory use of intracellular nitrate has recently also been shown for microeukaryotes such as foraminifera (Risgaard-Petersen et al. 2006) and diatoms (Kamp et al. 2011). At the oxic sediment surface, however, diatoms and other microalgae use dissolved inorganic nitrogen (DIN) and probably also intracellular nitrate for nitrogen assimilation (Lomas & Glibert 2000, Sundbäck & Miles 2000).

The ability to store nitrate intracellularly may be particularly advantageous in intertidal flats which are very dynamic ecosystems. Benthic organisms have to cope with frequent changes in the availability of, e.g., light, oxygen, and nutrients due to tidal and diurnal rhythms. Another source of perturbation in intertidal flats is the presence of macrofauna that reworks large amounts of sediment and the microorganisms therein (e.g., Bouchet et al. 2009). Some polychaetes construct deep-reaching burrows and enhance solute exchange between sediment and the water column due to their ventilation activity (Kristensen 2001). Many species of intertidal macrofauna feed on sediment microorganisms and thereby decrease microbial populations or keep them in the exponential growth phase (Herman et al. 2000, Blanchard et al. 2001). Under such transient conditions, the nitrate storage capacity awards sediment microorganisms with the steady availability of a key nutrient and an energetically favourable electron acceptor. Nitrate-storing microorganisms may thereby gain a competitive advantage over sediment bacteria that lack the ability to store nitrate intracellularly.

Nitrate is supplied to intertidal sediments via the water column or is produced by microbial nitrification at the oxic sediment surface. Nitrate from nitrification diffuses both into the water column and towards anoxic layers in the sediment where it can be anaerobically respired to dinitrogen gas by microbial denitrification. In intertidal sediments, the coupling of nitrification and denitrification can be relatively loose (Jensen et al. 1996). This implies that either denitrification has a substantial nitrate source other than nitrification (e.g., the water column) or that much of the nitrate produced by nitrification does not end up as dinitrogen produced by denitrification. Nitrate-storing microorganisms take up nitrate from the water column or from the nitrification layer of the sediment surface (Sayama 2001). The sedimentary intracellular nitrate pool might be controlled by the rates of nitrogen mineralisation and nitrification in the sediment. Both processes are stimulated by the oxygenation of the sediment by tidal currents and by ventilation of macrofaunal burrows (Kristensen 2001, Nielsen et al. 2004, de Beer et al. 2005). Additionally, some macrofauna species enrich the sediment with organic matter due to their feeding activities (Christensen et al. 2000), but also digest organic matter in their gut, which further enhances mineralisation and ammonium regeneration (Gardner et al. 1993).

In an intertidal flat of the German Wadden Sea, a snapshot measurement revealed a large pool of intracellular nitrate that reached deep into the sediment, well below the very thin photosynthetic layer (de Beer et al. 2005). The sediment was densely populated by diatoms, but also by the burrowing polychaete *Hediste diversicolor*. Hence, in a laboratory microcosm experiment, the hypothesis was tested that the presence of *H. diversicolor* in intertidal sediment increases the nitrate supply and thereby the size of the sedimentary intracellular nitrate pool via stimulation of nitrification. As experimental treatments served (1) sediment without worms, (2) sediment with worms, (3) sediment without worms, but amended with ammonium to mimic the worms' ammonium excretion, and (4) sediment with worms, but amended with the nitrification inhibitor allylthiourea.

Materials and Methods

Origin of sediment and animals

Sediment was collected in the intertidal flat near Dorum-Neufeld in the German Wadden Sea (53°45'N, 8°21'E). This site is characterised by mixed sediment (sand/mud) with low porewater sulphide concentrations (Jahn & Theede 1997) and high densities of epifauna (e.g., the snails *Hydrobia ulvae* and *Littorina littorea*) and infauna (e.g., the polychaetes *Arenicola marina* and *Hediste diversicolor*). Sediment from the top 25 cm was sieved through a 0.5 mm screen to remove macrofauna and shell debris. It was then frozen at -20°C for 30 h to kill macrofauna juveniles that had passed through the sieve. The defaunated and homogenised sediment was added to 4 recirculating flow-through microcosms (30 cm long \times 20 cm wide \times 10 cm high). A thin layer of unfrozen and 180 μm sieved sediment was evenly distributed on the sediment surface to inoculate the sediments with living microalgae. After the sediment had settled, aerated seawater from the North Sea diluted to the *in situ* salinity of 22 was continuously directed over the sediment surface. Each microcosm was continuously supplied from its own 50 L seawater reservoir at a flow rate of 3 L min^{-1} throughout the experiment. To allow the growth of microalgae on the sediment surface and the formation of the typical redox stratification in the sediment, the flow-through microcosms were illuminated from above by a neon daylight lamp ($50 \mu\text{mol photons m}^{-2} \text{ s}^{-1}$ light intensity at the sediment surface) at a 16 h light to 8 h dark cycle and left untouched for 10 days. The incubation temperature was 22°C , which was at the upper end of temperatures reached at the collection site during summer when large infauna is abundant and exhibits high foraging, burrowing, and ventilation activities. The polychaete *Hediste diversicolor* (O.F. Müller) was freshly collected in the intertidal flat near Dorum-Neufeld by digging up the sediment with a spade to a depth of approximately 25 cm and searching it through by hand. On the day of collection, 30 individuals of 250 to 300 mg wet weight were added to 2 of the 4 microcosms, which corresponded to a density of 420 ind. m^{-2} .

Experimental design

The experiment comprised four treatments (one in each microcosm): A) Sediment without *H. diversicolor* (Control), B) Sediment colonised by *H. diversicolor* (*Hediste*), C) Sediment not colonised by *H. diversicolor*, and overlain with ammonium-enriched water (Ammonium), and D) Sediment colonised by *H. diversicolor*, and overlain by allylthiourea-treated water (*Hediste* + ATU). Allylthiourea, an inhibitor of microbial ammonia oxidation (Hall 1984), was added to the seawater at a final concentration of $100 \mu\text{mol L}^{-1}$ on the day the animals were added. Three days later, NH_4Cl was added to the seawater of treatment C) to a final concentration of $50 \mu\text{mol L}^{-1} \text{NH}_4^+$; 16 days later it was replenished because the concentration had dropped to less than $2 \mu\text{mol L}^{-1} \text{NH}_4^+$. Water samples from the four microcosms were taken every two days during the course of the experiment and stored at -20°C until ammonium was analysed by flow-injection (Hall & Aller 1992) and nitrate was analysed using the VCl_3 reduction method (Braman & Hendrix 1989) with a chemiluminescence detector (CLD 86 S NO/NO_x -Analyser, Eco Physics, Switzerland). Microsensor measurements were started 10 days after the animals were added and were completed within 11 days. Afterwards, sediment cores were taken for the analysis of intracellular nitrate and photopigments.

Intracellular nitrate

In the intertidal flat near Dorum-Neufeld ($53^\circ45'\text{N}$, $8^\circ21'\text{E}$) that was densely colonised by *H. diversicolor*, four randomly selected sediment cores with an inner diameter of 3.6 cm were taken at low tide. One sediment core was used for measuring porewater nitrate concentration by microsensor measurements (see 'Microsensor measurements' below). The other three sediment cores were sliced at 0.2-cm intervals for the upper 1 cm and at 1-cm intervals to a total depth of 15 cm. Care was taken to remove macrofauna from each slice with forceps. The sediment slices were frozen at -20°C until used for nitrate extraction with the freeze-and-thaw technique (Lomstein et al. 1990). For the extraction, 1 mL Milli Q water was added to the 0.2-cm sediment slices (upper 10 mm) and 3 mL Milli Q water to the 1-cm sediment slices (1-15 cm). Samples were vigorously shaken, frozen in liquid nitrogen, and heated in the water bath (90°C) three times for 10 min each to physically break up large microbial cells and thereby release intracellular nitrate. The concentration of total nitrate (porewater nitrate plus extracted

nitrate) in the supernatant of the sediment slurries was measured using the VCl_3 reduction method (Braman & Hendrix 1989). The intracellular nitrate concentration (expressed in $nmol\ cm^{-3}$ sediment) was calculated by subtracting the porewater nitrate concentration from the total nitrate concentration.

In the microcosm experiment, four randomly selected sediment cores with an inner diameter of 2.5 cm were taken from each microcosm and sliced at 0.2-cm intervals for the upper 1 cm and at 1-cm intervals to a total depth of 5 cm. One half of each sediment slice was used for intracellular nitrate analysis and was frozen at $-20^{\circ}C$, the other half was used for pigment analysis and was frozen at $-80^{\circ}C$. Extraction and analysis of intracellular nitrate were made as described above.

Photopigments

Sliced sediment from the laboratory microcosms was defrosted and each slice was incubated with 10 mL 90% acetone (Sigma-Aldrich, Switzerland) on a rotary shaker at $4^{\circ}C$ over night. After centrifugation for 10 min at 3700 g at $0^{\circ}C$, the supernatants were filtered (Acrodisc[®] CR 4 mm Syringe Filter with 0.45 μm Versapor[®] Membrane, Gelman Laboratory) and filled into HPLC-vials. Samples were always kept in the dark. Extracted pigments were separated by means of HPLC (Waters 2695, U.S.A.) and analysed by a photodiode array detector (Waters 996, U.S.A.). The HPLC column (Reprosil, 350×4.6 mm, Dr. Maisch, Germany) was heated to $25^{\circ}C$, while the samples were kept at $4^{\circ}C$ during measurements. Pigments of each sample were separated by three different eluents (methanol:ammonium acetate (80:20), acetonitrile 90% and ethyl acetate (100%), flow rate $1\ mL\ min^{-1}$) the mixing ratio of which changed gradually during each 24 min run. Peaks were integrated with the software Millenium³² and chlorophyll *a* and fucoxanthin peaks were identified according to their specific retention time and absorption spectrum. Calibrations were performed by using 1:5, 1:10, 1:20 and 1:40 dilutions of a chlorophyll *a* stock solution ($1.963\ mg\ L^{-1}$, DHI, Denmark) and a fucoxanthin stock solution ($1.075\ mg\ L^{-1}$, DHI, Denmark).

Microsensor measurements

Oxygen and NO_x microsensors were constructed as described by Revsbech (1989) and Larsen et al. (1997), respectively. The sensors were calibrated before and after each series of 4-6 profiles in sterile seawater equilibrated to 22°C. Oxygen microsensors were calibrated at 0 and 100% air saturation by flushing the seawater with either dinitrogen gas or synthetic air. NO_x microsensors were calibrated by adding aliquots of a 10 mmol L⁻¹ stock solution of NaNO_3 to a known volume of seawater to arrive at nominal nitrate concentrations of 0, 20, 40, 60, 80, and 100 $\mu\text{mol L}^{-1}$. The calibration curve was corrected for the natural concentration of nitrate in the seawater that was determined with the VCl_3 reduction method. The oxygen and NO_x microsensors were simultaneously used in a measuring set-up as described by Stief & de Beer (2002). At least 4 and up to 14 vertical steady-state concentration profiles were recorded in each flow-through microcosm from 0.3 cm above to 0.6 cm below the sediment surface in increments of 0.025 cm. Positions of the profiles were randomly selected, but a minimum distance of 2 cm to burrow openings at the sediment surface was held in the two *Hediste* treatments. In the natural sediment core from the intertidal flat, profiling with the NO_x microsensor was done down to a depth of 2 cm in the laboratory within 2 h of collection. Profiles were recorded at three randomly selected spots of the sediment surface.

The NO_x profiles were interpreted as porewater nitrate profiles, assuming that nitrite and nitrous oxide (N_2O) concentrations in the sediments were negligible. For calculating the depth-integrated nitrate content (see ‘Depth integration of data and statistical analysis’), the concentration values in $\mu\text{mol L}^{-1}$ porewater were converted to concentration values in nmol cm^{-3} sediment by multiplication with the average sediment porosity of 0.41. Local volumetric net nitrate production rates were calculated from the curvature of the steady state NO_x concentration profiles by diffusion-reaction modeling (Bungay et al. 1969, Berner 1980). The effective diffusion coefficient of nitrate at depth x in the sediment was calculated as $D_{s(x)} = D_0 \times \varphi / (1 - \ln(\varphi^2))$ (Boudreau 1996) with D_0 as the diffusion coefficient of nitrate in seawater and φ as the sediment porosity. D_0 of nitrate in seawater was taken as $1.75 \times 10^{-5} \text{ cm}^2 \text{ s}^{-1}$ at 22°C (Li & Gregory 1974). φ was determined as the volumetric water content of the

sediment, which corresponded to the weight loss of sediment slices of known wet volume after drying at 60°C for 3 days.

Depth-integration of data and statistical analysis

Depth-integrated values of photopigments, intracellular nitrate (expressed per μg chlorophyll *a*), porewater nitrate, and local nitrate production rates were calculated from the respective vertical profiles. Depth-integrated contents of chlorophyll *a*, intracellular nitrate, and porewater nitrate were calculated by adding up the average concentration values of every depth interval of the vertical profile multiplied by the individual thickness of each depth interval. Depth-integrated net nitrate production rates were calculated by adding up the local production rates multiplied by the thickness of each depth interval of the production-consumption profiles.

The depth-integrated contents of chlorophyll *a*, intracellular nitrate (expressed per μg chlorophyll *a*), porewater nitrate as well as the depth-integrated net nitrate production rates were compared between the four treatments. One-way ANOVAs were run for each variable after confirming normality and homogeneity of variance of the data. If the null hypothesis was rejected, the Waller-Duncan Post-hoc test was used for pairwise comparisons. This test is based on Bayesian principles and uses the harmonic mean of different samples sizes. For the depth-integrated contents of intracellular nitrate, an additional T-test was run for the pairwise comparison between the treatments Control and *Hediste*. All statistical analyses were carried out with the program SPSS Version 11.

Results

Sedimentary pool of intracellular nitrate

Under *in situ* conditions, the sedimentary pool of intracellular nitrate showed a peak reaching from 0 to 5 cm depth with a maximum concentration of $11.7 \text{ nmol cm}^{-3}$ sediment (Fig. 1). Below 5 cm, the intracellular nitrate concentration was relatively

constant around 2.5 nmol cm^{-3} sediment to the depth of 15 cm (Fig. 1). In contrast, the porewater nitrate concentration was highest at the sediment-water interface (up to 4.1 nmol cm^{-3} sediment) and decreased rapidly to 0 within the upper 1.5 cm of the sediment (Fig. 1).

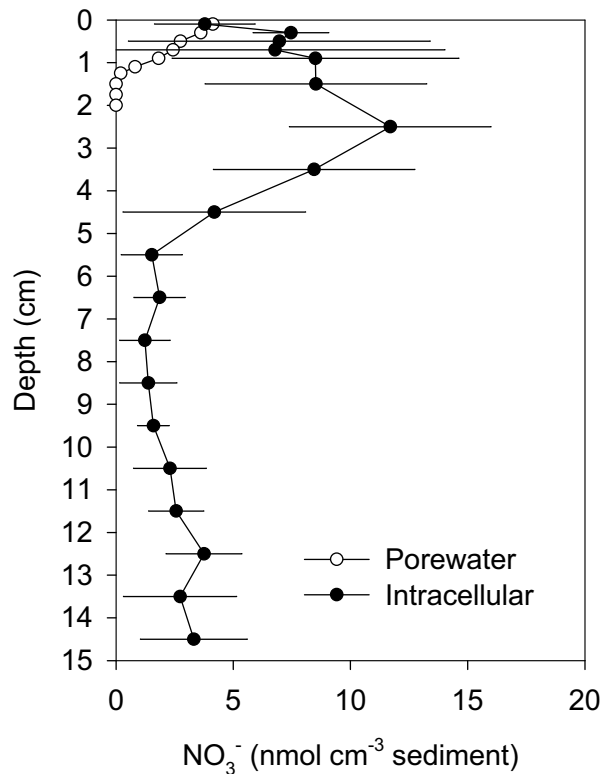

Figure 1: *In situ* distribution of intracellular and porewater nitrate in intertidal sediment densely colonised by diatoms and burrowing macro-fauna. Both intracellular nitrate and porewater nitrate concentrations are given in nmol cm^{-3} sediment. Means \pm SD of $n = 3$ replicate profiles are shown.

In the microcosms, the sedimentary pools of intracellular nitrate showed the highest concentrations at the surface and then decreased gradually with depth in all treatments (Fig. 2A-D). Intracellular nitrate concentrations were generally higher and also extended to greater depth in the *Hediste* and Ammonium treatments than in the Control and *Hediste* + ATU treatments. The highest concentration of 71 nmol cm^{-3} sediment was observed in the Ammonium treatment (Fig. 2C).

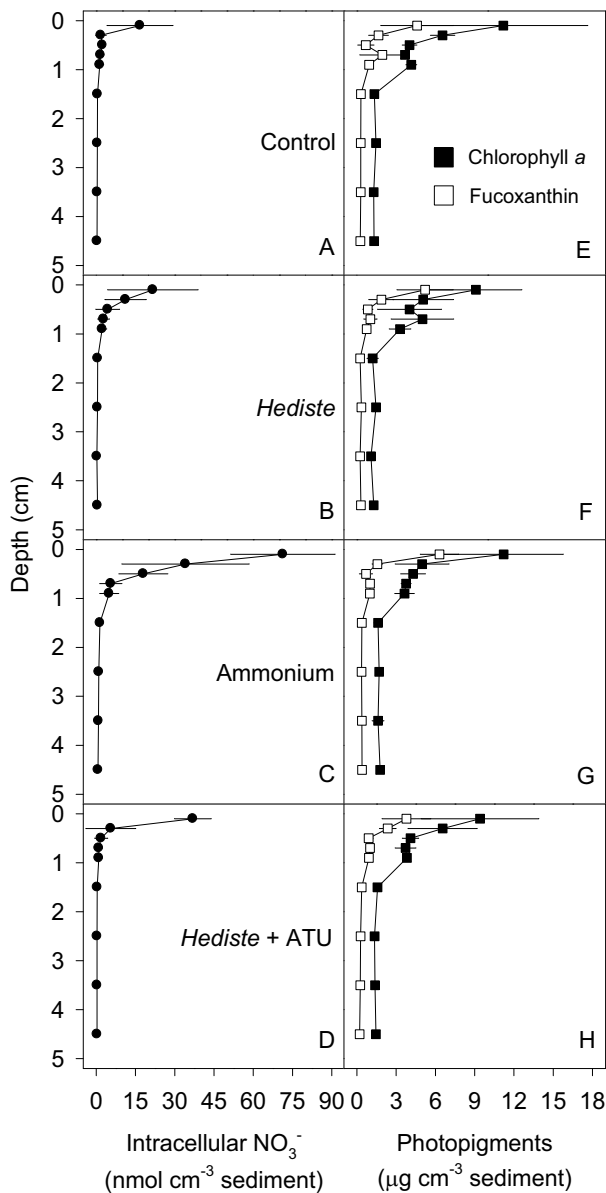

Figure 2: Vertical distribution of (A-D) intracellular nitrate and (E-H) photopigments in coastal marine sediment incubated in laboratory flow-through microcosms for 3 weeks. (A, E) Control sediment without *H. diversicolor*, (B, F) Sediment colonised by *H. diversicolor*, (C, G) sediment without *H. diversicolor*, overlain with ammonium-enriched water, (D, H) sediment colonised by *H. diversicolor*, overlain by allylthiourea (ATU)-treated water. Means \pm SD of $n = 4$ replicate cores.

While in many of the sediment layers intracellular nitrate was detected, it was totally absent from other layers. In contrast, organic matter was homogeneously distributed in all sediment layers because the sediment was thoroughly homogenised before it was filled into the microcosms. From this we concluded that organic nitrogen compounds that were potentially extracted and degraded by the extreme temperature changes were not converted to nitrate, which would have produced false-positive results.

Photopigment distribution in the sediment

The vertical distributions of marker pigments of diatoms, chlorophyll *a* and fucoxanthin, were similar in all treatments with the highest pigment concentrations at the sediment surface and a gradual decrease down to 5 cm depth (Fig. 2E-H). Fucoxanthin was present in all sediment slices, indicating the presence of viable diatoms even in relatively deep sediment layers. In the upper 2 mm of the sediment, the fucoxanthin-to-chlorophyll *a* ratio was particularly high (i.e., 0.4-0.6) and suggested that the photosynthetically active community was dominated by diatoms (Lucas & Holligan 1999), which was also confirmed by qualitative microscopic examination. Average concentrations of the two photopigments within each of the 9 sediment layers were linearly correlated with average concentrations of intracellular nitrate (Fig. 3).

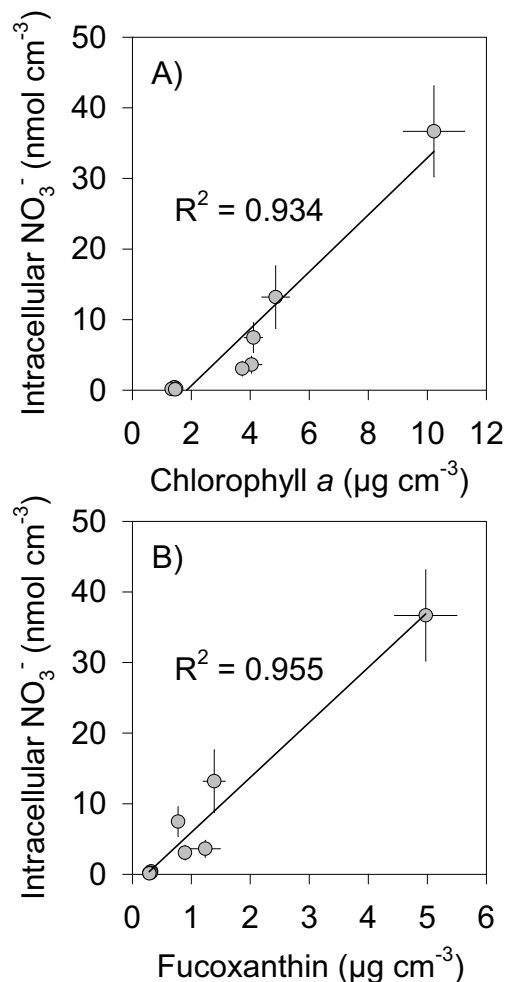

Figure 3: Correlation of intracellular nitrate with A) chlorophyll *a* and B) fucoxanthin in sediment cores taken from the 4 laboratory microcosms. Nitrate and pigment contents were averaged for each of the 9 sediment layers analysed (compare Fig. 2). Error bars give SE for each sediment layer. R^2 is Pearson's coefficient for linear correlations.

Porewater concentrations of oxygen and nitrate

The oxygen profiles were identical in all treatments, except in the sediment of the *Hediste* + ATU treatment, where oxygen penetrated deeper. Diffusion-reaction modeling revealed no significant net oxygen production due to microalgal photosynthesis at the sediment surface at which the light intensity was $50 \mu\text{mol photons m}^{-2} \text{ s}^{-1}$ (data not shown). The nitrate concentration profiles showed surface peaks indicative of nitrate production by nitrification in all treatments, except the *Hediste* + ATU treatment (Fig. 4A-D). Diffusion-reaction modeling revealed net production of nitrate in the oxic sediment layer of the Control, *Hediste*, and Ammonium treatments (Fig. 4E-G), but not in the *Hediste* + ATU treatment (Fig. 4H). Below the oxic surface layer, net nitrate consumption by bacteria and/or microalgae occurred, which did not show any significant differences between all non-inhibited treatments, but which was very low in the *Hediste* + ATU treatment (Fig. 4E-H). It should be noted that net nitrate production and consumption might also have occurred inside the *Hediste* burrows, but this microbial activity was not measured with the microsensor approach. The nitrate concentration in the water column of the *Hediste* + ATU treatment was lower than in the natural North Sea water due to the inhibition of nitrification by ATU (Fig. 4A-D, Tab. 1). The ammonium concentration in the water column was highest in the ATU-inhibited treatment, intermediate in the Ammonium treatment and lowest in the Control and *Hediste* treatments (Tab. 1).

Table 1: Mean ammonium and nitrate concentrations in the water column of the four sediment microcosms over the incubation period of three weeks. Treatments are described in the legend of Fig. 2. ATU: allylthiourea

Treatment	NH_4^+ [$\mu\text{mol L}^{-1}$] (\pm SD)	NO_3^- [$\mu\text{mol L}^{-1}$] (\pm SD)
Control	1.2 (0.7)	34.1 (9.8)
<i>Hediste</i>	2.7 (2.2)	44.8 (7.9)
Ammonium	11.2 (8.9)	46.2 (17.6)
<i>Hediste</i> + ATU	33.5 (6.1)	14.0 (5.4)

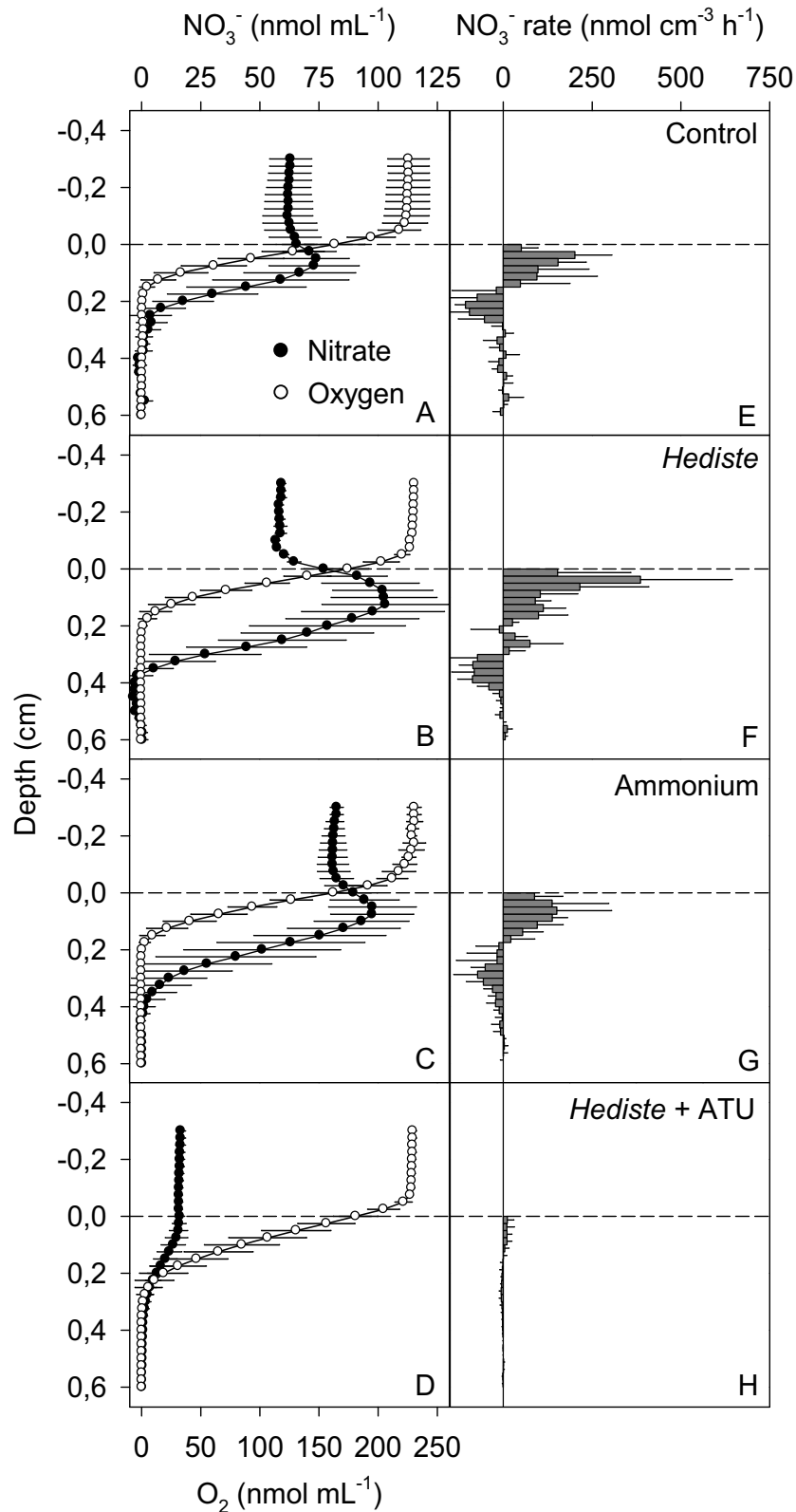
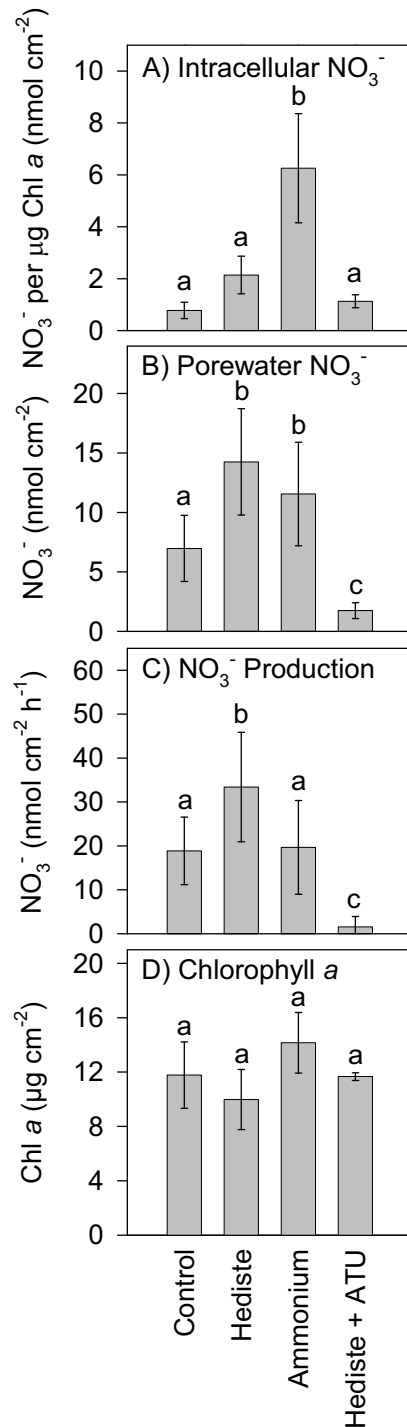

Figure 4: (A-D) Vertical microprofiles of porewater oxygen and nitrate in laboratory sediment microcosms and (E-H) nitrate conversion rates derived from the microprofiles. Treatments as described for Fig. 2. Dashed line indicates the sediment-water interface. Positive and negative rates correspond to net production and consumption of nitrate, respectively. Means \pm SD of $n = 4$ to 14 replicate profiles are shown.

Depth-integrated contents of nitrate and photopigments

Significant differences between the four treatments were found with respect to the depth-integrated contents of intracellular nitrate (expressed per μg chlorophyll *a*), porewater nitrate, and net nitrate production rates (ANOVA: $F_{3,12} = 19.7$, $p < 0.001$, $F_{3,25} = 12.8$, $p < 0.001$, and $F_{3,25} = 12.1$, $p < 0.001$, respectively) (Fig. 5A-C). In



contrast, no significant differences between the four treatments were found with respect to the depth-integrated contents of chlorophyll *a* (ANOVA: $F_{3,12} = 0.8$, $p = 0.512$, Fig. 5D) and fucoxanthin (ANOVA: $F_{3,12} = 2.6$, $p = 0.097$, data not shown). The porewater nitrate contents and the net nitrate production rate were significantly higher in the *Hediste* than in the Control treatment (Waller-Duncan Post-hoc test, Fig. 5B+C). Also the intracellular nitrate content (expressed per μg chlorophyll *a*) was significantly higher in the *Hediste* than in the Control treatment, but only in a pairwise comparison that excluded the Ammonium treatment with its extraordinarily high average intracellular nitrate content (Student's T-test: $T_6 = -2.8$, $p < 0.05$, Fig. 5A).

Figure 5: Depth-integrated A) intracellular nitrate (expressed per μg chlorophyll *a*), B) porewater nitrate, C) net nitrate production, and D) chlorophyll *a*. Treatments are described in Fig.2. Means + SD of $n = 3$ -14 replicate measurements are shown. Treatments with different lower case letters have significantly different means (ANOVA, Waller-Duncan Post-hoc test).

In the Ammonium treatment mimicking ammonium excretion by *H. diversicolor*, the intracellular and porewater nitrate contents (but not nitrate production and chlorophyll *a*) were significantly higher than in the Control treatment (Waller-Duncan Post-hoc test, Fig. 5A-D). In the *Hediste* + ATU treatment, the intracellular and porewater nitrate contents as well as the net nitrate production rate (but not chlorophyll *a*) were significantly lower than in the *Hediste* and Ammonium treatments in which ammonium was abundant and could be nitrified (Waller-Duncan Post-hoc test, Fig. 5A-D).

The variability of depth-integrated profiles within each treatment was high for the punctual oxygen and nitrate microsensors profiles (i.e., coefficients of variation (CV) = 29-39 and 31-40%, respectively) and low for chlorophyll *a* and fucoxanthin profiles that were analysed in sediment cores that integrated over ca. 5 cm² of sediment surface (i.e., CV = 2-22 and 7-15%, respectively). Intracellular nitrate that was also analysed in sediment cores took an intermediate position with CVs of 24-33% for cores collected in the microcosms. Only for the cores collected *in situ*, the CV was relatively high with 42%.

Discussion

Intracellular nitrate in intertidal sediment

A large pool of intracellular nitrate was discovered in the sediment of an intertidal flat in the German Wadden Sea. Intracellular nitrate exceeded porewater nitrate levels and was also present at depths where porewater nitrate was depleted. The high abundance of diatoms in this and other intertidal flats (MacIntyre et al. 1996) suggests that nitrate is stored in benthic phototrophic microorganisms. Correlative evidence for nitrate storage in diatoms was obtained by photopigment analysis in the intertidal sediment incubated in laboratory microcosms. Sedimentary pools of intracellular nitrate due to nitrate storage by diatoms may be a wide-spread phenomenon in coastal marine sediments, since diatoms dominate microphytobenthic communities in intertidal flats (MacIntyre et al. 1996) and are able to store nitrate intracellularly (Garcia-Robledo et al. 2010, Kamp et al. 2011). Nevertheless, the presence of intracellular nitrate might also be linked to large sulphur bacteria (Sayama 2001), but in the sulphide-poor intertidal sediment near

Dorum-Neufeld (Jahn & Theede 1997), these microorganisms were not present, as confirmed by microscopy. Also many benthic foraminifera are able to store nitrate, but obviously not the species occurring in German Wadden Sea sediments (Risgaard-Petersen et al. 2006, Pina-Ochoa et al. 2010).

The maximum concentration of intracellular nitrate was found in the upper 5 cm of the intertidal sediment, which contrasts with the thin layer of intracellular nitrate at the surface of other coastal marine sediments (Lomstein et al. 1990, Garcia-Robledo et al. 2010). Interestingly, the layer of high intracellular nitrate concentrations is often much thicker than the photosynthetically active layer (Fenchel & Straarup 1971). This broad distribution of intracellular nitrate must be caused by the presence of diatoms in deep, aphotic sediment layers. The gliding motility of diatoms allows them to migrate vertically in the sediment, but only down to depths of a few millimetres. In contrast, passive burial of diatoms may relocate them several centimetres or decimetres into the sediment. Known burial mechanisms of small microalgal cells are advective porewater flow in permeable sandy sediments (Huettel & Rusch 2000, Ehrenhauss et al. 2004) and bioturbation by animals such as the polychaetes *H. diversicolor* and *A. marina* that were abundant at the time of sampling the intertidal flat.

Effect of *H. diversicolor* on intracellular nitrate

In the laboratory microcosms, benthic diatoms were most probably the main nitrate-storing organisms because intracellular nitrate concentrations correlated well with distributions of chlorophyll *a* and fucoxanthin. Large sulphur bacteria and foraminifera did probably not contribute substantially to the sedimentary pool of intracellular nitrate for the reasons given above. The intracellular nitrate pool was larger in the *Hediste* than in the Control microcosm, even though diatom density and distribution were the same in the two treatments. This means that *H. diversicolor* increased the average concentration of intracellular nitrate in the diatom cells rather than changing the cell density of nitrate-storing diatoms. The presence of *H. diversicolor* also enhanced the sedimentary nitrification rate and enlarged the zone in which nitrification took place. Nitrification might be stimulated by the increased oxygen availability due to searching and foraging activities of the polychaete. In deeper sediment layers, burrow ventilation and ammonium excretion may increase both oxygen and ammonium availability and

consequently nitrification in the thin oxic layer of the worm burrows (Mayer et al. 1995, Nielsen et al. 2004). However, the excretion activity of the polychaete may also affect nitrification at the sediment surface, if a substantial fraction of the ammonium excreted is expelled into the water column due to the worm's ventilation activity. This effect might be quantitatively important in shallow coastal ecosystems and reinforced in a recirculating system as used here. In line with this reasoning, the Ammonium treatment, meant to mimic the ammonium excretion by *H. diversicolor* (Christensen et al. 2000), increased the porewater and intracellular nitrate concentrations close to the sediment surface. The increased availability of ammonium alone was sufficient to enlarge the nitrate pools, while the increased availability of oxygen seemed to be less important for the stimulation of nitrification.

The microcosm experiment revealed that diatoms take up and store more nitrate intracellularly when nitrifying bacteria produce nitrate in the immediate environment of the algae, maybe because of the efficient transport of nitrate within the oxic sediment layer. The tight relationship between sedimentary nitrification and the storage of intracellular nitrate by diatoms was demonstrated by the addition of the nitrification inhibitor ATU to the second *Hediste* treatment. No stimulatory effect of *H. diversicolor* on the intracellular and porewater nitrate pools occurred in the presence of ATU, despite the worms' ammonium excretion and sediment oxygenation.

Also the flux of dissolved inorganic nitrogen (DIN) between the water column and the sediment has probably affected the nitrate pools in the sediment. The DIN concentrations in the water column that drove these fluxes differed between the four treatments in an expected way. The North Sea water supplied to the microcosms contained ca. $40 \mu\text{mol L}^{-1}$ nitrate and the average nitrate concentration remained close to this concentration, except for the *Hediste* + ATU treatment where it decreased in the water column. This observation was in line with nitrification being inhibited and nitrate consumption going on in the sediment. Together, the missing nitrate production in the sediment and the lower nitrate flux from the water column explain the small sedimentary pool of intracellular nitrate observed in the ATU-treated sediment. The North Sea water supplied to the microcosms contained ca. $1\text{-}2 \mu\text{mol L}^{-1}$ ammonium and this concentration remained unchanged, except for the Ammonium treatment where it was deliberately adjusted to a concentration higher than in natural North Sea water and

also in the *Hediste* + ATU treatment where it increased due to the worms' ammonium excretions and nitrification being inhibited in the sediment. The possible ammonium flux from the water column into the sediment increased the intracellular nitrate pool only in the Ammonium treatment, but not in the *Hediste* + ATU treatment, which underlines that ammonium must be nitrified to nitrate in the sediment to exert a measurable effect on the intracellular nitrate pool.

Extrapolation to natural conditions

After the equilibration time of 10 days, worm distribution in the sediment microcosms was relatively homogenous, while the diatoms that were visible on the sediment surface occurred in patches. The very thin tip of microsensors measures chemical gradients in a very small spot and these gradients may differ considerably even between neighbouring spots. To arrive at representative oxygen and nitrate gradients, microprofiles were repeated at as many randomly chosen spots as possible in each microcosm (i.e., up to 14). In contrast, sediment cores with a diameter of 2.5 cm integrate the measured parameter over an area of ca. 5 cm². Replicate sediment cores were thus expected to be more similar than replicate microprofiles and therefore coring was repeated only 4 times in each microcosm. In fact, the observed within-treatment variability of depth-integrated profiles was high for microsensor data, intermediate for intracellular nitrate data, and low for pigment data. In all cases, the within-treatment variability was low enough to allow for comparisons between the treatments, and also lower than the one observed under *in situ* conditions.

The intracellular nitrate concentrations in the sediment microcosms were in the range of naturally occurring concentrations in coastal marine sediments (Garcia-Robledo et al. 2010, Høgslund et al. 2010). The difference in the vertical distribution of intracellular nitrate concentrations between the sediment microcosms and the field site are probably due to differences in the flow regime (i.e., tidal currents vs. continuous flow) and the community of burrowing macrofauna (i.e., single-species vs. multi-species community). In the sediment microcosms, the bioturbation and bioirrigation activities of *H. diversicolor* did not lead to substantial burial of diatoms. The density of *H. diversicolor* in the sediment microcosms was in the lower range of densities reported for marine sediments (Scaps 2002). The effect of *H. diversicolor* on intracellular nitrate

pools might thus be even stronger at higher worm densities. The nutrient concentrations were in the range of naturally occurring concentrations in the Wadden Sea (Kieskamp et al. 1991, van Beusekom et al. 2008). Chlorophyll *a* concentrations in the sediment microcosms were in the normal range (MacIntyre et al. 1996). The observed effects of *H. diversicolor* on the sedimentary pool of intracellular nitrate might thus be representative for intertidal flats of similar sediment composition. It is noteworthy that the quantitative importance of intracellular nitrate will be particularly high in low-porosity sediments as studied here, whereas porewater nitrate is likely more important in high-porosity sediments such as mud.

Possible fate of intracellular nitrate

When integrating the vertical profiles over depth, the intertidal sediment contained $619 \mu\text{mol m}^{-2}$ intracellular nitrate and $87 \mu\text{mol m}^{-2}$ porewater nitrate. Intracellular nitrate may thus sustain nitrate-consuming processes in the sediment longer or at a higher rate than porewater nitrate. The diatoms themselves use intracellular nitrate for assimilation (Lomas & Glibert 2000), but have also been shown to reduce it to ammonium in a dissimilatory process that is induced by dark, anoxic conditions (Kamp et al. 2011). Both diatoms and intracellular nitrate have been detected in anoxic sediment layers of the sediment microcosms and thus diatoms do not entirely consume their intracellular nitrate content under dark, anoxic conditions. It may be speculated that some nitrate leaks out of the diatom cells (e.g., upon lysis following the freezing of sediment at low tide during winter) and fuel anaerobic nitrate respiration by other microorganisms in the sediment. Denitrification rates reported for intertidal sediments in the Wadden Sea range from 0.2 to $190 \mu\text{mol N m}^{-2} \text{h}^{-1}$ (Kieskamp et al. 1991, Jensen et al. 1996, Gao et al. 2010). Hence, intracellular nitrate from diatoms might sustain denitrification in intertidal sediments for 3-129 days. Both anaerobic and aerobic denitrification occur in Wadden Sea sediments (Gao et al. 2010) and could be fuelled by intracellular nitrate from diatoms that are present in both oxic and anoxic sediment layers.

Conceptual model of macrofauna effect on intracellular nitrate

We propose a mechanism of nitrogen cycling in coastal marine sediments in which organisms from different trophic levels interact in converting particulate organic nitrogen (PON) to nitrate that is stored in sedimentary microorganisms (Fig. 6).

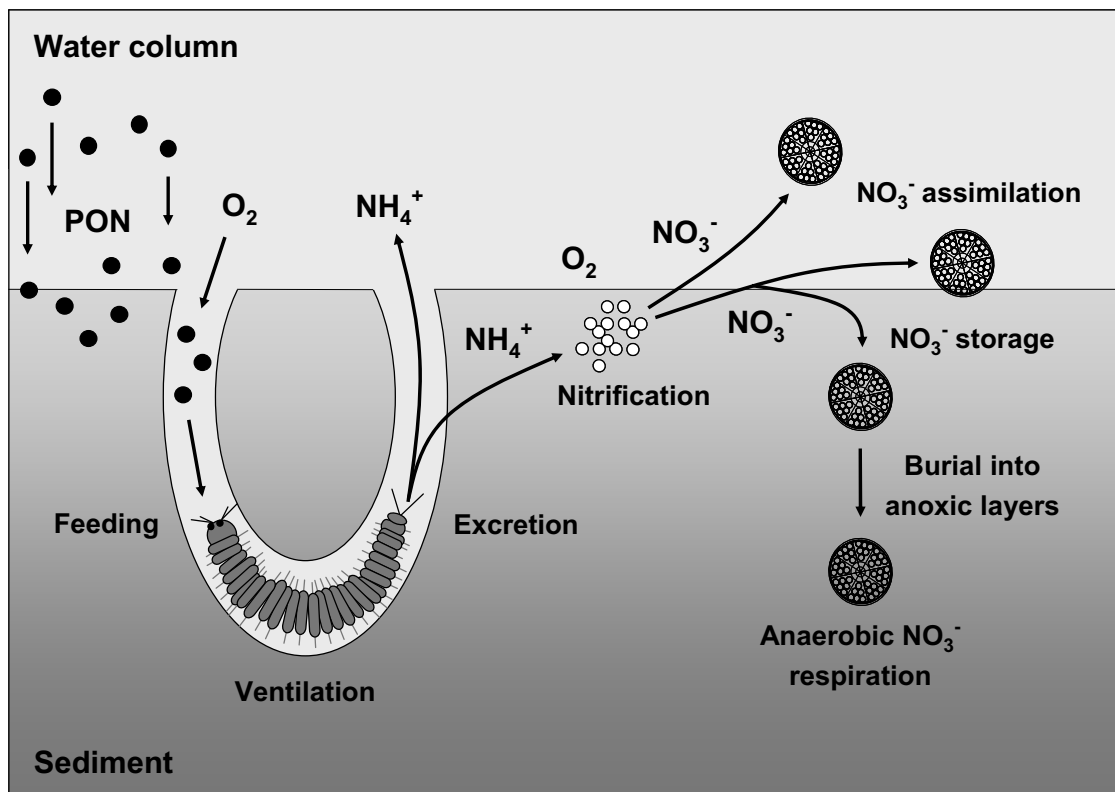

Figure 6: Conceptual model of nitrogen cycling in intertidal sediments as affected by nitrate-storing diatoms and burrowing polychaetes. Worms feed on organic matter (black circles) from the water column or the sediment surface, excrete ammonium and oxygenate the sediment by their foraging, burrowing, and ventilation activities. Thereby, worms enhance the activity of nitrifying bacteria (white circles) that oxidise ammonium to nitrate in oxic sediment layers. Nitrate is taken up and stored intracellularly by diatoms (perforated discs). The sedimentary pool of intracellular nitrate can be used for nitrogen assimilation or for anaerobic nitrate respiration in anoxic sediment layers.

Burrowing macrofauna feeds on organic matter and excretes ammonium or nitrogen-rich organic compounds like mucus or silk. Additionally, they oxygenate the sediment by their foraging, burrowing, and ventilation activities, which results in additional interface area and enhanced solute fluxes. Macrofauna thereby stimulates the activity of nitrifying bacteria that oxidise ammonium to nitrate in the oxic sediment layers. Nitrate is then taken up by microalgae (e.g., diatoms) and stored intracellularly. This

mechanism leads to a change in the forms of nitrogen (nitrate vs. ammonium and PON) and in the compartmentalisation of nitrogen (intracellular vs. extracellular). The conversion of PON into reactive oxidised nitrogen may fuel benthic primary production or serve as an electron acceptor in anoxic sediment layers.

It remains to be investigated whether macrofauna also influences the fate of intracellular nitrate in coastal marine sediments. It may be speculated that macrofaunal activities will determine whether nitrate-storing microorganisms use their intracellular nitrate themselves or whether it is made available to other sediment microorganisms. Sediment reworking and burrow construction by macrofauna may relocate microphytobenthos within the sediment and expose it to different microenvironmental conditions (e.g., from light to dark, or from oxic to anoxic conditions). In the light, the microalgae probably use intracellular nitrate for nitrogen assimilation (Lomas & Glibert 2000). If buried by macrofauna to dark and anoxic conditions, the microalgae may use their intracellular nitrate for dissimilatory nitrate reduction to ammonium (DNRA) to meet the energy demand for entering a resting stage for long-term survival (Kamp et al. 2011). Conversely, macrofauna that feeds on microphytobenthos may cause the lysis of nitrate-storing cells in the gut (Smith et al. 1996). Denitrifying bacteria in the gut can use nitrate leaking out of the lysing microalgal cells and produce nitrous oxide and dinitrogen gas which are emitted from the animal (Stief et al. 2009, Heisterkamp et al. 2010). Nitrate that is not used in the gut will be excreted and can be used by sediment bacteria in the immediate surrounding of macrofauna burrows as possible hotspots of nitrate respiration.

Acknowledgements

We are grateful to the technicians of the Max-Planck-Institute for Marine Microbiology for the construction of microsensors. Markus Huettel is acknowledged for inspiring discussions. This study was financially supported by a grant from the German Science Foundation awarded to P.S. (STI 202/6) and by the Max-Planck-Society, Germany.

References

- Berner RA (1980) Early diagenesis: A theoretical approach. Princeton University Press, Princeton, NJ. 237pp.
- Blanchard GF, Guarini JM, Orvain F, Sauriau PG (2001) Dynamic behaviour of benthic microalgal biomass in intertidal mudflats. *J Exp Mar Biol Ecol* 264:85-100
- Bouchet VM, Sauriau P, Debenay J, Mermillod-Blondin F, Schmidt S, Amiard J, Dupas B (2009) Influence of the mode of macrofauna-mediated bioturbation on the vertical distribution of living benthic foraminifera: first insight from axial tomodensitometry. *J Exp Mar Biol Ecol* 371:20-33
- Boudreau BP (1996) The diffusive tortuosity of fine-grained unlithified sediments. *Geochim Cosmochim Acta* 60:3139-3142
- Braman RS, Hendrix SA (1989) Nanogram nitrite and nitrate determination in environmental and biological materials by Vanadium(III) reduction with chemiluminescence detection. *Anal Chem* 61:2715-2718
- Bungay HR, Whalen WJ, Sanders WM (1969) Microprobe techniques for determining diffusivities and respiration rates in microbial slime systems. *Biotechnol Bioeng* 11:765-772
- Christensen B, Vedel A, Kristensen E (2000) Carbon and nitrogen fluxes in sediment inhabited by suspension-feeding (*Nereis diversicolor*) and non-suspension feeding (*N. virens*) polychaetes. *Mar Ecol Prog Ser* 192:203-217
- de Beer D, Wenzhofer F, Ferdelman TG, Boehme SE, Huettel M, van Beusekom JEE et al. (2005) Transport and mineralization rates in North Sea sandy intertidal sediments, Sylt-Rømø Basin, Wadden Sea. *Limnol Oceanogr* 50:113-127
- Ehrenhauss S, Witte U, Buhning SL, Huettel M (2004) Effect of advective pore water transport on distribution and degradation of diatoms in permeable North Sea sediments. *Mar Ecol Prog Ser* 271:99-111
- Fenchel T, Straarup BJ (1971) Vertical distribution of photosynthetic pigments and the penetration of light in marine sediments. *Oikos* 22:172-182
- Gao H, Schreiber F, Collins G, Jensen MM, Kostka JE, Lavik G, de Beer D, Zhou HY, Kuypers MMM (2010) Aerobic denitrification in permeable Wadden Sea sediments. *ISME J* 4:417-426.
- Garcia-Robledo E, Corzo A, Papaspyrou S, Jimenez-Arias JL, Villahermosa D (2010) Freeze-lysable inorganic nutrients in intertidal sediments: dependence on microphytobenthos abundance. *Mar Ecol Prog Ser* 403:155-163
- Gardner WS, Briones EE, Kaegi EC, Rowe GT (1993) Ammonium excretion by benthic invertebrates and sediment-water nitrogen flux in the Gulf of Mexico near the Mississippi River outflow. *Estuaries* 16:799-808
- Hall GH (1984) Measurement of nitrification rates in lake sediments: Comparison of the nitrification inhibitors nitrapyrin and allylthiourea. *Microb Ecol* 10:25-36
- Hall PJ, Aller RC (1992) Rapid, small-volume, flow injection analysis for CO₂, and NH₄⁺ in marine and freshwaters. *Limnol Oceanogr* 37:1113-1119
- Heisterkamp IM, Schramm A, de Beer D, Stief P (2010) Nitrous oxide production associated with coastal marine invertebrates. *Mar Ecol Prog Ser* 415:1-9
- Herman PMJ, Middelburg JJ, Widdows J, Lucas CH, Heip CHR (2000) Stable isotopes as trophic tracers: combining field sampling and manipulative labelling of food resources for macrobenthos. *Mar Ecol Prog Ser* 204:79-92

- Høgslund S, Nielsen JL, Nielsen LP (2010) Distribution, ecology and molecular identification of *Thioploca* from Danish brackish water sediments. *FEMS Microbiol Ecol* 73:110-120
- Høgslund S, Revsbech NP, Cedhagen T, Nielsen LP, Gallardo VA (2008) Denitrification, nitrate turnover, and aerobic respiration by benthic foraminiferans in the oxygen minimum zone off Chile. *J Exp Mar Biol Ecol* 359:85-91
- Høgslund S, Revsbech NP, Kuenen JG, Jørgensen BB, Gallardo VA, van de Vossenberg J, Nielsen JL, Holmkvist L, Arning E, Nielsen LP (2009) Physiology and behaviour of marine *Thioploca*. *ISME J* 3:647-657
- Huettel M, Rusch A (2000) Transport and degradation of phytoplankton in permeable sediment. *Limnol Oceanogr* 45:534-549
- Jahn A, Theede H (1997) Different degrees of tolerance to hydrogen sulphide in populations of *Macoma balthica* (Bivalvia, Tellinidae). *Mar Ecol Prog Ser* 154:185-196
- Jensen KM, Jensen MH, Kristensen E (1996) Nitrification and denitrification in Wadden Sea sediments (Königshafen, Island of Sylt, Germany) as measured by nitrogen isotope pairing and isotope dilution. *Aquat Microb Ecol* 11:181-191
- Kamp A, de Beer D, Nitsch JL, Lavik G, Stief P (2011) Diatoms respire nitrate to survive dark and anoxic conditions. *Proc Natl Acad Sci USA* 108:5649-5654
- Kieskamp WM, Lohse L, Epping E, Helder W (1991) Seasonal variation in denitrification rates and nitrous oxide fluxes in intertidal sediments of the western Wadden Sea. *Mar Ecol Prog Ser* 72:145-151
- Kristensen E (2001) Impact of polychaetes (*Nereis* spp. and *Arenicola marina*) on carbon biogeochemistry in coastal marine sediments. *Geochem Trans* 2:92-103
- Kristensen E, Mikkelsen OL (2003) Impact of the burrow-dwelling polychaete *Nereis diversicolor* on the degradation of fresh and aged macroalgal detritus in a coastal marine sediment. *Mar Ecol Prog Ser* 259:237-251
- Larsen LH, Kjær T, Revsbech NP (1997) A microscale NO_3^- biosensor for environmental applications. *Anal Chem* 69:3527-3531
- Li Y-H, Gregory S (1974) Diffusion of ions in sea water and deep-sea sediments. *Geochim Cosmochim Acta* 38:703-714.
- Lomas MW, Glibert PM (2000) Comparisons of nitrate uptake, storage, and reduction in marine diatoms and flagellates. *J Phycol* 36:903-913
- Lomstein E, Jensen MH, Sørensen J (1990) Intracellular NH_4^+ and NO_3^- pools associated with deposited phytoplankton in a marine sediment (Aarhus Bight, Denmark). *Mar Ecol Prog Ser* 61:97-105
- Lucas CH, Holligan PM (1999) Nature and ecological implications of algal pigment diversity on the Molenplaat tidal flat (Westerschelde estuary, SW Netherlands). *Mar Ecol Prog Ser* 180:51-64
- MacIntyre HL, Geider RJ, Miller DC (1996) Microphytobenthos: the ecological role of the 'secret garden' of unvegetated, shallow-water marine habitats. I. Distribution, abundance, and primary production. *Estuaries* 19:186-201
- Mayer MS, Schaffner L, Kemp WM (1995) Nitrification potentials of benthic macrofaunal tubes and burrow walls: effects of sediment NH_4^+ and animal irrigation behaviour. *Mar Ecol Prog Ser* 121:157-169
- Nielsen OI, Gribsholt B, Kristensen E, Revsbech NP (2004) Microscale distribution of oxygen and nitrate in sediment inhabited by *Nereis diversicolor*: spatial patterns and estimated reaction rates. *Aquat Microb Ecol* 34:23-32

- Pina-Ochoa E, Høgslund S, Geslin E, Cedhagen T, Revsbech NP, Nielsen LP, Schweizer M, Jorissen F, Rysgaard S, Risgaard-Petersen N (2010) Widespread occurrence of nitrate storage and denitrification among Foraminifera and Gromiida. *Proc Natl Acad Sci* 107:1148-1153
- Preisler A, de Beer D, Lichtschlag A, Lavik G, Boetius A, Jørgensen BB. (2007) Biological and chemical sulphide oxidation in a *Beggiatoa* inhabited marine sediment. *ISME J* 1:341-353
- Revsbech NP (1989) An oxygen microsensor with a guard cathode. *Limnol Oceanogr* 34:474-478
- Risgaard-Petersen N, Langezaal AM, Ingvarsdén S, Schmid MC, Jetten MSM, Op den Camp HJM, Derksen JWM, Pina-Ochoa E, Eriksson SP, Nielsen LP, Revsbech NP, Cedhagen T, van der Zwaan GJ (2006) Evidence for complete denitrification in a benthic foraminifer. *Nature* 443:93-96
- Sayama M (2001) Presence of nitrate-accumulating sulphur bacteria and their influence on nitrogen cycling in a shallow coastal marine sediment. *Appl Environ Microbiol* 67:3481-3487
- Scaps P (2002) A review of the biology, ecology and potential use of the common ragworm *Hediste diversicolor* (O.F. Müller) (Annelida: Polychaeta). *Hydrobiologia* 470:203-218
- Schulz HN, Jørgensen BB (2001) Big bacteria. *Annu Rev Microbiol* 55:105-137
- Smith D, Hughes RG, Cox EJ (1996) Predation of epipelagic diatoms by the amphipod *Corophium volutator* and the polychaete *Nereis diversicolor*. *Mar Ecol Prog Ser* 145:53-61
- Stief P, de Beer D (2002) Bioturbation effects of *Chironomus riparius* on the benthic N-cycle as measured using microsensors and microbiological assays. *Aquat Microb Ecol* 27:175-185
- Stief P, Poulsen M, Nielsen LP, Brix H, Schramm A (2009) Nitrous oxide emission by aquatic macrofauna. *Proc Natl Acad Sci USA* 106:4296-4300
- Sundbäck K, Miles A (2000) Balance between denitrification and microalgal incorporation of nitrogen in microtidal sediments, NE Kattegat. *Aquat Microb Ecol* 22:291-300
- van Beusekom JEE, Weigelt-Krenz S, Martens P (2008) Longterm variability of winter nitrate concentrations in the northern Wadden Sea driven by freshwater discharge, decreasing riverine loads and denitrification. *Helgol Mar Res* 62:49-57

Chapter 7

Conclusion and perspectives

This thesis focuses on interactions between benthic aquatic invertebrates and microbes and their role in biogeochemical nitrogen cycling with particular emphasis on the production of the gas N_2O . Although N_2O is a very important greenhouse gas and ozone-depleting substance, the global N_2O budget remains poorly quantified, in particular with respect to biogenic N_2O sources (Forster et al. 2007). This thesis presents the first results on N_2O emission from marine macrofauna that has so far been overlooked as a biogenic source of N_2O . The dataset compiled here contributes to the currently small record on N_2O emission by invertebrate species and extends our knowledge on animal-associated N_2O production from terrestrial and freshwater habitats to the marine realm. Furthermore, it complements earlier studies on N_2O emission from terrestrial and freshwater invertebrates by identifying microbial biofilms on the external surface of invertebrates as site of intense N_2O production and nitrification as important pathway involved in animal-associated N_2O production. In conclusion, benthic invertebrates can stimulate microbial N_2O production by providing three distinct habitats with specific microenvironments:

- a) the gut, a transient microbial habitat characterized by low O_2 , high C_{org} and NO_3^- concentrations, which is thus favourable for denitrification (Drake et al. 2006, Stief et al. 2009 Chapters 2, 4, 5),
- b) the exoskeleton or shell surface, a relatively persistent habitat exposed to fluctuating O_2 concentrations and high inorganic N input that provides suitable conditions for the formation of microbial biofilms, in which nitrification and denitrification can (co-) occur (Chapters 2-4),
- c) the burrow, a microbial habitat with fluctuating environmental conditions and steep concentration gradients, in which nitrification and denitrification can prevail in close proximity (Svensson 1998, Stief & Schramm 2010).

By creating these microsites, invertebrates influence microbial metabolism and alter rates of nitrification and denitrification and their N_2O yields and thus net production rates of N_2O . In the invertebrate-provided microsites, the net N_2O production rates can be far higher than in the surrounding environment, which can lead to high N_2O emission rates from soils, sediments and water bodies that are densely colonized by invertebrates

(Drake & Horn 2007, Stief et al. 2009, Chapter 5). Benthic invertebrates thus represent abundant hotspots of N₂O production that need to be integrated conceptually and quantitatively into the global N cycle.

Conceptual integration of N₂O emission from aquatic invertebrates

N₂O-emitting benthic coastal invertebrates were found among the taxonomic groups of Crustacea, Mollusca, Polychaeta and Echinodermata that comprise most of the soft-bottom macrofauna species in coastal marine habitats (Chapter 2). The ability to emit N₂O is thus widespread among benthic coastal invertebrates and appears to be the rule rather than the exception. However, the potential N₂O emission rate varies considerably with species, depending on the body size, habitat, presence of microbial biofilms on external surfaces, and conditions in the gut of the respective species (Chapters 2, 3, 5).

Microbial N₂O production in the invertebrate gut

In the gut, N₂O is only produced in significant amounts if high numbers of active denitrifiers are present that produce more N₂O than they consume. Consequently, factors that influence N₂O production in the gut are:

- a) the feeding type and the feeding rate of the animal that determine the amount of ingested bacteria,
 - b) the physico-chemical conditions (e.g., O₂, C_{org}, NO₃⁻, pH) in the gut that determine the activity of denitrifiers and the balance of denitrification enzymes, hence the rate and N₂O yield of gut denitrification,
 - c) the gut residence time that determines how long ingested denitrifiers are exposed to the specific conditions in the gut and thus how much time they have for expression of the denitrification genes,
 - d) the lysozyme activity that determines the number of viable denitrifiers in the gut
- (Horn et al. 2003, Stief et al. 2009, Stief & Schramm 2010, Chapters 2-5).

For freshwater invertebrates, the amount of ingested bacteria is an important factor, since N₂O emission rates depend strongly on the feeding type of the animal (Stief et al. 2009). This does not hold true for marine invertebrates, which indicates that the

physico-chemical conditions, the gut residence time and/or the lysozyme activity are more important in determining the net rate of N_2O production in the gut.

In respect to O_2 , the gut microenvironment of most aquatic macrofauna can be assumed to be conducive for denitrification. Dissected guts of the shrimp *Litopenaeus vannamei* were hypoxic to anoxic depending on their filling state even when being exposed to fully oxygenated medium and no oxygen gradients were observed along the gut axis (Chapter 5). Diffusion of oxygen into the gut might only play a role in smaller species that have smaller volume to surface ratios of the guts (Tang et al. 2011). Here, oxygen gradients may prevail along the gut axis and/or radius due to diffusion of oxygen through the gut wall or openings and anoxic conditions may only occur in some sections or the core of the gut (Schmitt-Wagner & Brune 1999, Tang et al. 2011). However, even in very small animals such as the insect larvae *Chironomus plumosus* the gut can be completely anoxic if diffusion of oxygen from the haemolymph and uptake of oxic water by feeding is not sufficient to oxygenate the gut contents (Stief & Eller 2006). Moreover, it was shown for the freshwater mussel *Dreissena polymorpha* that both nitrifiers and denitrifiers are present in the gut, but only the denitrifying bacteria are metabolically active (Chapter 4). Overall, this indicates that the gut of aquatic invertebrates constitutes a microenvironment of low oxygen concentration that supports denitrification activity. However, so far only a limited number of studies characterized the gut microenvironment of a few invertebrate species in respect to oxygen, nitrate, organic carbon, pH, and other physico-chemical parameters, and further investigations are needed to improve our knowledge about environmental conditions and associated microbial metabolism in the guts of invertebrates.

Based on the few studies on the invertebrates' gut microenvironments, it can be expected that the physico-chemical conditions in respect to nitrate and organic carbon are especially favourable for denitrification in the gut of aquatic detritivores such as deposit- and filter-feeding invertebrates. These animals take up large amounts of organic carbon and NO_3^- by ingesting water-soaked food particles (Stief et al. 2010). Moreover, they might ingest large numbers of nitrate-accumulating diatoms that, after being lysed, could supply additional nitrate for gut denitrification. Benthic diatoms from an intertidal flat can store more NO_3^- intracellularly than is available in the porewater of

the sediment (Chapter 6). Invertebrate species, like *Hediste diversicolor*, that enhance the sedimentary pool of intracellular nitrate, might thus indirectly stimulate N₂O production by increasing the NO₃⁻ supply for gut denitrification in diatom-feeding invertebrates.

However, even though physico-chemical conditions in the invertebrate gut are favourable for denitrification, this does not necessarily lead to high net N₂O production rates. A high lysozyme activity, which is common among marine deposit- and filter-feeding invertebrates, can lead to the digestion of a great fraction of the ingested bacteria (McHenery et al. 1986, Plante & Shriver 1998), thereby reducing the amount of actively denitrifying bacteria in the gut. Additionally, if invertebrate species have long gut residence times and rather stable anoxic conditions in their guts, ingested denitrifiers will have enough time to express the full set of denitrification genes and perform complete denitrification. In the latter case, denitrification in the gut might prevail at high rates, but produce only trace amounts of N₂O.

In contrast, high N₂O yields from gut denitrification can be expected for species with short gut residence times because the induction of the N₂O reductase lags behind that of the other denitrifying enzymes and ingested denitrifiers are probably not long enough in the anoxic gut to establish the complete denitrification pathway (Philippot et al. 2001, Zumft & Körner 2007, Stief et al. 2009). Additionally, high N₂O yields may arise from oxygen and pH gradients along the alimentary tract because the N₂O reductase is efficiently inhibited by elevated oxygen concentration or low pH (Bonin & Raymond 1990, Drake & Horn 2007, Richardson et al. 2009). For the shrimp *L. vannamei*, for instance, the very short gut residence time of maximal 1 h (Beseres et al. 2005) and the constantly low oxygen and high pH conditions throughout the filled gut suggest that the high N₂O/N₂ ratio from gut denitrification was due to delayed expression of the N₂O reductase (Chapter 5). In other species, however, oxygen and pH conditions might be more important than gut residence time for high N₂O yields from gut denitrification. Notably, the gut of soil-feeding termites is highly structured and characterized by changing pH and steep oxygen gradients across the gut radius and length (Brune & Kuhl 1996, Schmitt-Wagner & Brune 1999). Furthermore, the nitrate and/or nitrite concentrations in the invertebrate gut can exceed the concentrations in the ambient

surrounding and might be high enough to inhibit the reduction of N_2O (Blackmer & Bremner 1978, Firestone et al. 1979, Drake & Horn 2007, Stief et al. 2009). The reduction of N_2O to N_2 makes up only about 20% of the energy yield of denitrification (Richardson et al. 2009) and reduction of NO_3^- and NO_2^- might be preferred over reduction of N_2O when NO_x^- is in ample supply.

In conclusion, several environmental, autecological, and physiological factors may lead to an imbalance in the activity of the different denitrification enzymes in the gut of invertebrates and thereby to increased N_2O yields from gut denitrification. Depending on the invertebrate species and environmental conditions, the importance of each factor may vary, which makes it difficult to predict N_2O production by invertebrates. The combination of environmental, autecological, and physiological controlling factors makes denitrification in the gut of invertebrates different from denitrification in sediments, soils, and water bodies, and a site of intense microbial N_2O production.

Microbial N_2O production in exoskeletal biofilms

Besides N_2O production in the gut of invertebrates, microbial biofilms on hard external surfaces of aquatic invertebrates were found to be sites of high N_2O production. Studies on three marine mollusc species from different habitats and feeding guilds and one freshwater species revealed that shell biofilms contribute 18-96% to the total N_2O emission of the animals (Chapters 3 + 4). The widespread distribution and importance of such biofilms are further supported by the significant positive correlation of the N_2O emission rates of 19 marine invertebrate species with the presence of microbial biofilms on exoskeleton and shell surfaces (Chapter 2). These results challenge earlier studies on N_2O emission from freshwater invertebrates that ascribed N_2O production exclusively to microbial denitrification activity in the anoxic gut (Stief et al. 2009, Stief & Schramm 2010). Since these studies did not specifically test for N_2O production in exoskeletal biofilms, it can be speculated that also for biofilm-bearing freshwater invertebrates, N_2O production in exoskeletal biofilms is a common trait that significantly contributes to the total N_2O emission of the animal.

While N_2O production in the invertebrate gut is only linked to denitrification, N_2O production in shell biofilms can derive from both denitrification and nitrification (Chapter 3). Accordingly, N_2O is produced by two functional groups of microorganisms, nitrifiers and denitrifiers, whose activity is regulated by different environmental factors (Devol 2008, Ward 2008). Importantly, the involvement of nitrifying bacteria in the production of N_2O means that not only NO_3^- and NO_2^- are precursors and drivers for animal-associated N_2O emission, but also NH_4^+ . This is of particular importance in the light of the high NH_4^+ excretion rates of many invertebrate species, as well as their feeding and bioturbation activities that stimulate remineralisation and release of NH_4^+ from the sediment (Blackburn & Henriksen 1983, Aller et al. 2001, Chapters 3, 4, 6). Benthic invertebrates thereby significantly increase the availability of NH_4^+ , which is often limiting in oxygenated sediments and water bodies (Canfield et al. 2005). By enriching dissolved inorganic nitrogen (DIN) in their immediate surroundings, invertebrates stimulate the growth of microbial biofilms on the external surfaces of their body and consequently also N_2O production (Chapter 3).

Furthermore, the investigated mollusc species were found to excrete more than enough NH_4^+ to sustain the nitrification-derived N_2O production in their shell biofilms. Moreover, the NO_3^- produced by biofilm nitrification might support N_2O production by denitrification if nitrification and denitrification are tightly coupled in shell biofilms, and may also supply NO_3^- for denitrification in the animal's gut. A substantial part of the animal's N_2O emission may therefore be fuelled by the animal's excretion and is independent from environmental DIN supply. In conclusion, high N_2O emission rates may not only occur in nutrient-rich ecosystems, but also in the nutrient-enriched micro-environment of invertebrates living in otherwise nutrient-poor macro-environments.

The animal's self-sustained N_2O emission might also overcome the sometimes counteracting effects of DIN availability and temperature that control the rates of N conversions and N_2O production throughout the seasonal cycle in temperate regions. In summer, when temperatures are high, the water column concentrations of DIN are typically low, limiting the rates of nitrification and denitrification and concomitant N_2O production in the sediment and water column (Jorgensen & Sorensen 1985, Jorgensen & Sorensen 1988, Rysgaard et al. 1995). In winter, the opposite is the case, and

temperature is the limiting factor. High rates of denitrification and N₂O emission from sediments therefore occur during spring and autumn when moderate nitrate concentrations coincide with moderate temperatures (Jorgensen & Sorensen 1985). A very similar seasonal pattern was observed for N₂O emission from insect larvae whose N₂O emission derived solely from denitrification in the gut (Stief et al. 2010, Stief & Schramm 2010). For invertebrate species with a significant fraction of the emitted N₂O being produced in shell biofilms, the seasonal variability of N₂O emission rates might be different. The density of invertebrates is generally higher in summer than in winter and consequently high NH₄⁺ excretion rates and high temperatures are likely to coincide in the animals' microenvironment in summer (Gardner et al. 1993, Rysgaard et al. 1995). This may lead to high invertebrate-associated N₂O emission rates in summer. It would therefore be essential to monitor the seasonal *in situ* N₂O emission rates of invertebrate species whose N₂O emission derives mainly from the shell biofilm and whose NH₄⁺ excretion rates are high.

Apart from the DIN availability, oxygen is a key factor controlling the process rates of nitrification and denitrification and their N₂O yields (Goreau et al. 1980, Betlach & Tiedje 1981). The oxygen distribution in shell biofilms is very heterogeneous and the vertical concentration gradients vary with biofilm thickness and light conditions (Chapter 3). Anoxic bottom layers only establish in thick shell biofilms under dark conditions when oxygen is not produced by photosynthesis and respiration by the biofilm community consumes all oxygen that diffuses into the biofilm from the oxygenated environment. The community composition of the biofilm (heterotrophs versus oxygenic phototrophs) and the light regime to which the microbial biofilm is exposed in the environment are therefore important for determining the prevailing oxygen concentrations in shell biofilms. Under low-light conditions, denitrification and nitrification were equally important for N₂O production (Chapter 3). It can be speculated that the N₂O emission rates from shell biofilms are generally highest under low-light conditions because (i) denitrification can prevail in hypoxic to anoxic microsites and (ii) nitrification will not be light-inhibited. Furthermore, N₂O yields of nitrification and denitrification are highest under hypoxic conditions (Goreau et al. 1980, Bonin & Raymond 1990), which preferentially establish in shell biofilms under low-light conditions.

Relative N₂O yields of nitrification and denitrification in shell biofilms measured under oxic and anoxic conditions, respectively, were 3.7-13.4% and thus higher than N₂O yields normally observed in aquatic sediments and water columns (Seitzinger 1988, Bange 2008). Under *in situ* conditions, frequent changes in oxygen concentration are likely to occur in the shell biofilm due to the animal's respiration, feeding and migration behaviour and these fluctuations in oxygen concentration might further increase the N₂O yield. In an artificially grown biofilm, changes in O₂ concentration caused high transient accumulation of N₂O (Schreiber et al. 2009). It can also be speculated that the N₂O yield from denitrification in shell biofilms is increased because of higher numbers of aerobic denitrifiers. It has been suggested that aerobic denitrification especially takes place in environments with frequently changing oxygen conditions and that aerobic denitrifiers preferentially produce N₂O (Frette et al. 1997, Patureau et al. 2000, Gao et al. 2010). Moreover, imbalanced enzyme activity of nitrifiers and denitrifiers due to frequently changing conditions can result in the accumulation of the intermediate nitrite (Stein 2011), which was shown to strongly increase the N₂O production in shell biofilms (Chapter 3).

In conclusion, aquatic invertebrates provide distinct microenvironments in their guts and on their external surfaces that stimulate microbial N₂O production. These microenvironments complement the known sites of N₂O production in aquatic habitats, such as sediments and biofilms. Conceptually, invertebrate-associated N₂O production stands out due to its complex control by environmental, autecological, and physiological factors. In respect to the global N cycle, N₂O production associated with aquatic invertebrates constitutes a link between reactive nitrogen (i.e. nitrate, nitrite, and ammonium) in aquatic ecosystems and the potent greenhouse gas N₂O in the atmosphere. Due to heterogeneous distribution, abundance and composition of the invertebrate communities, and seasonal changes in environmental drivers, it can be expected that the invertebrate-derived N₂O emission from benthic aquatic systems is spatially and temporally very variable. The ecological concept of "hotspots" and "hot moments" may thus be most appropriate to describe the N₂O emission from invertebrate-colonized benthic habitats.

Quantitative integration of N₂O emission from aquatic invertebrates

The high abundance and potential N₂O emission rates of many aquatic invertebrates, especially marine species, suggest that aquatic invertebrates significantly contribute to the overall N₂O emission from aquatic environments. However, estimations on *in situ* rates of N₂O emission from aquatic invertebrates are difficult due to high variability between species and the multiple temporally changing factors that control invertebrate-associated N₂O production. Furthermore, interactions between the invertebrates and the environment might reduce or further stimulate N₂O emission depending on the exact site at which the invertebrates emit N₂O and the ambient N₂O production and consumption rates (Stief & Schramm 2010). At the current state of research, only a very rough quantitative integration of invertebrate-associated N₂O production can be made based on potential N₂O emission rates because *in situ* measurements throughout the year are missing.

Generally, it can be expected that N₂O emission from aquatic invertebrates is highest in nutrient-rich environments like coastal areas, lakes and streams, since these environments sustain high numbers of invertebrates due to high primary production and supply plenty of inorganic and organic substrates (Beukema et al. 2002). The Wadden Sea is a very productive system with usually dense populations of diverse epi- and infaunal invertebrates (Beukema et al. 2002). A typical average density of macrobenthic fauna in tidal flats of the Wadden Sea is around 2000 individuals m⁻² (Beukema 2002). Assuming that the intertidal macrobenthic fauna emit N₂O at the average potential emission rate of 0.32 nmol N₂O individual⁻¹ h⁻¹ determined for 19 benthic coastal invertebrate species, a population of 2000 individuals m⁻² results in an areal N₂O emission rate of about 1.28 μmol N m⁻² h⁻¹ or about 11 mmol N m⁻² per year. This is within the range of -2.9 to 8.6 μmol N m⁻² h⁻¹ reported for N₂O fluxes from intertidal and estuarine sediments (Seitzinger 1988, Kieskamp et al. 1991, Middelburg 1995, Usui et al. 2001), which probably already include the effect of the benthic invertebrate community on N₂O emission rates if measurements were done in macrofaunal-colonized sediments. According to these calculations, N₂O production associated with invertebrates accounts for a significant fraction of N₂O fluxes from coastal marine sediments. Whether the average potential N₂O emission rate of 0.32 nmol ind.⁻¹ h⁻¹

reflects the average annual *in situ* N₂O emission rate of the benthic invertebrate community is, however, highly uncertain. It can be speculated that the average annual *in situ* N₂O emission rate of macrofauna from temperate coastal areas is lower than 0.32 nmol ind.⁻¹ h⁻¹, since throughout much of the year the *in situ* temperatures are lower than the temperature at which the potential emission rates were measured. On the other hand, invertebrate densities in shallow coastal habitats can be much higher than 2000 individuals m⁻² from spring to autumn due to extremely high abundances of N₂O-emitting mollusc species like *Hydrobia ulva* and *Macoma balthica* (Beukema et al. 1996, Barnes 1999, Ysebaert et al. 2005).

Extrapolation of the estimated annual N₂O emission from benthic invertebrates of 11 mmol N m⁻² to the complete area of the Wadden Sea of 13 000 km² (van Beusekom & de Jonge 2002) results in the emission of about 0.002 Tg N yr⁻¹ (Table 1). This is ca. 1% of the estimated global N₂O emission rate of earthworms (Drake et al. 2006). Considering that benthic invertebrates colonize a great proportion of the world's continental shelf areas at relative high abundance (Bolam et al. 2010, Laverock et al. 2011), the global N₂O emission rates of marine invertebrates and terrestrial earthworms may be in the same order of magnitude. Assuming that the continental shelf area of approximately 29 × 10⁶ km² (Inman & Scott 2005) is colonized with a mean macrofaunal density of 500 individuals m⁻² that emit N₂O at a mean rate of 0.1 nmol individual⁻¹ h⁻¹, marine invertebrates from continental shelf sediments would cause N₂O emissions of 0.35 Tg N yr⁻¹. This is about 6% of the global N₂O emission of 5.5 Tg N yr⁻¹ from aquatic ecosystems (Denman et al 2007).

Table 1: Estimates of annual global N₂O emissions from various sources

Source of N ₂ O emission	Tg N yr ⁻¹	Reference
Benthic macrofauna Wadden Sea	0.002	This thesis
Benthic macrofauna continental shelves	0.35	This thesis
Earthworms	0.19	Drake et al. 2006
Aquacultured shrimp <i>Litopenaeus vannamei</i>	0.0001	This thesis
Aquatic ecosystems	5.5	Denman et al. 2007
Total global N ₂ O emission	17.7	Denman et al. 2007

How much of the N₂O produced by benthic marine invertebrates in continental shelf sediments will actually reach the atmosphere depends on the hydrodynamics, the distance of the N₂O production site to the atmosphere and microbial N₂O consumption in the sediment and water column (Meyer et al. 2008, Bange 2008). The contribution of N₂O emission from marine invertebrates to the atmospheric N₂O flux most likely decreases with increasing water depth because more N₂O can be consumed on the way from the sediment to the atmosphere and the abundance of benthic macrofauna decreases typically with increasing water depth (Wei et al. 2010). The impact of epifaunal invertebrate species on N₂O fluxes to the atmosphere might be greater than that of infaunal species, since they emit N₂O directly into the water column or in case of intertidal species directly to the atmosphere, whereas N₂O emitted by infaunal species might be partly consumed in the surrounding sediment.

Conditions that favour N₂O emission from aquatic invertebrates to the atmosphere (i.e. high animal density, high nutrient concentrations, short distance between the N₂O production site and the atmosphere) are typically found in aquaculture facilities. The shrimp *L. vannamei* is one of the most important aquaculture species that is reared at high animal densities, temperatures, and nutrient concentrations. The high N₂O production in the gut of *L. vannamei* most likely contributed to the several-fold supersaturation of N₂O in the rearing water (Chapter 5), which probably caused high N₂O flux from the aquaculture to the atmosphere. With a global aquaculture production of 2.72×10^6 tonnes in 2010 (FAO 2012), this species could have caused N₂O emissions from aquacultures of $0.13 \text{ Gg N yr}^{-1}$, assuming that it emits N₂O with an average rate of $0.2 \text{ nmol g}^{-1} \text{ h}^{-1}$ (Chapter 5). Since this N₂O emission rate was measured under conditions that were very similar to those normally found in aquacultures of *L. vannamei* and conditions in the aquaculture farms are rather constant throughout the year, this rate reflects reasonably well the annual *in situ* rate of N₂O emission from *L. vannamei*. The estimated global N₂O emission from *L. vannamei* is rather insignificant compared to the estimated total global N₂O emission of $17.7 \text{ Tg N yr}^{-1}$ (Denman et al. 2007). However, it is likely that also other aquacultured species (e.g., other shrimp and prawn species, molluscs, and maybe also fish) emit N₂O. Furthermore, it can be expected that the contribution of aquacultured species to the global N₂O emission will

increase in the future due to the extremely fast-growing aquaculture industry (Williams & Crutzen 2010).

N₂O emissions from aquatic invertebrates in natural environments are also likely to increase in the future due to the prospected increase in global warming and anthropogenic N inputs to aquatic systems. The combination of higher temperatures and increased availability of DIN will probably stimulate N₂O emission from invertebrates to the atmosphere, as these factors were shown to limit animal-associated N₂O production (Stief et al. 2010, Stief & Schramm 2010). Furthermore, moderate eutrophication of aquatic systems leads to increased macrofaunal biomass and to community shifts towards higher abundance of deposit- and filter-feeding species (Grall & Chauvaud 2002, Nixon & Buckley 2002), which both are likely to enhance invertebrate-associated N₂O production.

Overall, the current dataset on N₂O emission from aquatic invertebrates results in more complete inventories of biogenic N₂O sources, but does not reduce the uncertainties in the global N₂O budget. The first rough estimate on invertebrate-associated N₂O production suggests that aquatic invertebrates will only significantly contribute to N₂O emission from aquatic ecosystems if many abundant species emit N₂O at high rates throughout the year.

Future research

To arrive at more reliable estimates of the contribution of macrofauna to N₂O emission from aquatic environments, it is essential to measure *in situ* emission rates at high resolution throughout the year to account for the expected spatial and temporal variability in invertebrate-associated N₂O production. Field measurements of N₂O emission rates and correlation with abundance and community composition of invertebrates in different aquatic ecosystems and during all seasons are thus required. Simultaneous monitoring of environmental drivers (ammonium, nitrite, nitrate, temperature, oxygen, organic carbon, pH) is needed to improve our knowledge on controlling factors of invertebrate-associated N₂O production and their interaction with each other.

Since temperature and nitrate concentration have already been shown to be key factors in regulating the N₂O emission rate of aquatic invertebrates in temperate regions (Stief et al. 2010, Stief & Schramm 2010), future studies should address for the first time aquatic invertebrates in tropical regions. It can be assumed that the year-round high temperatures and increasing eutrophication in tropical areas due to intensified agriculture and aquaculture (Galloway et al. 2008) leads to exceptionally high invertebrate-associated N₂O emission rates in these regions. In the same context, it is important to investigate the N₂O emission potential of aquaculture key species that are grown in very high numbers under extremely nutrient-rich conditions and at high temperatures (FAO 2010). Both the *per capita* rates and the global rates of N₂O emission by aquacultured species may thus be far higher than from invertebrates in natural environments.

Furthermore, it is essential to investigate the N₂O emission potential of pelagic invertebrate species. If also marine pelagic species emit N₂O at significant rates, this would increase the importance of invertebrate-associated N₂O emission tremendously. This is on the one hand due to the vast numbers of pelagic invertebrates in the world's oceans (e.g., krill, salps, copepods) and on the other hand due to direct emission of N₂O into the water column. Even if N₂O emission rates from pelagic species are lower than from benthic invertebrates, a higher fraction of the N₂O emitted by pelagic invertebrates may end up in the atmosphere due to lower N₂O consumption rates in the water column than in the sediment.

Special attention should be given to highly abundant aquatic invertebrate species. The Antarctic krill *Euphausia superba* is estimated to be the species with the highest biomass on Earth (379 million tonnes, Atkinson et al. 2009). The gut of Antarctic krill is most likely a nitrate-rich microsite because this species inhabits the nitrate-rich Southern Ocean (Kamykowski & Zentara 2005) and feeds primarily on diatoms that have been found to accumulate nitrate intracellularly (Lomas & Glibert 2000, Kamp et al. 2011). If this species emits N₂O at a significant rate, krill alone could account for a substantial fraction of oceanic N₂O emission. Therefore, the next step will be to investigate the rate and mechanisms of microbial N₂O production associated with this

pelagic key species and examine whether the intracellular nitrate from the ingested diatom cells can fuel denitrification in the krill's gut.

Many open questions remain concerning the interaction between the host and the associated microbes. I propose to specifically follow the fate of ammonium excreted by the animals and quantify the amount that is metabolized to N_2O in shell biofilms. Furthermore, the animal may not only supply ammonium to the shell biofilm, but also labile organic carbon compounds. Filter-feeding invertebrates generate a flow of organic solutes and particles and motile invertebrates can actively search for food sources, which as a side effect probably supply plenty of organic carbon to the shell biofilm. The role of electron donors for invertebrate-associated N_2O production has so far not been studied and awaits further investigations. It is also not clear whether the host is directly affected by the presence and activity of N_2O -producing bacteria. Since N_2O is not toxic, the production in its body or on its external surface probably does not harm the animal. In contrast, the animal may benefit from the presence of microbial biofilms due to camouflage that reduces the predation pressure (Wahl 1989). Ingested heterotrophic microbes, including denitrifiers, may support degradation of organic matter in the animal gut and supply nutrients to the host or may compete with the host for limited nutrients.

A combination of field measurements, controlled laboratory experiments, and molecular analysis of the microbial communities is needed to investigate the complexity and heterogeneity of processes and factors involved in N_2O emission from aquatic invertebrates. This is required to resolve the mechanisms, importance of regulating factors, and eventually the contribution of invertebrate-associated N_2O production to the overall N_2O emissions from aquatic environments.

References

- Aller RC, Aller JY, Kemp PF (2001) Effects of particle and solute transport on rates and extent of remineralization in bioturbated sediments. In: *Organism-Sediment Interactions*, p 315-333
- Atkinson A, Siegel V, Pakhomov EA, Jessopp MJ, Loeb V (2009) A re-appraisal of the total biomass and annual production of Antarctic krill. *Deep-Sea Research Part I-Oceanographic Research Papers* 56:727-740
- Bange HW (2008) Gaseous nitrogen compounds (NO, N₂, NH₃) in the ocean. In: Douglas G Capone, Deborah A Bronk, Margaret R Mulholland and Edward J Carpenter (eds) *Nitrogen in the marine environment*. Elsevier Inc., pp 51-94
- Barnes RSK (1999) What determines the distribution of coastal hydrobiid mudsnails within north-western Europe? *Marine Ecology-Pubblicazioni Della Stazione Zoologica Di Napoli I* 20:97-110
- Beseres JJ, Lawrence AL, Feller RJ (2005) Variation in fiber, protein, and lipid content of shrimp feed - Effects on gut passage times measured in the field. *Journal of Shellfish Research* 24:301-308
- Betlach MR, Tiedje JM (1981) Kinetic explanation for accumulation of nitrite, nitric oxide, and nitrous oxide during bacterial denitrification. *Applied and Environmental Microbiology* 42:1074-1084
- Beukema JJ (2002) Expected changes in the benthic fauna of Wadden Sea tidal flats as a result of sea-level rise or bottom subsidence. *Journal of Sea Research* 47:25-39
- Beukema JJ, Cadee GC, Dekker R (2002) Zoobenthic biomass limited by phytoplankton abundance: evidence from parallel changes in two long-term data series in the Wadden Sea. *Journal of Sea Research* 48:111-125
- Beukema JJ, Essink K, Michaelis H (1996) The geographic scale of synchronized fluctuation patterns in zoobenthos populations as a key to underlying factors: Climatic or man-induced. *Ices Journal of Marine Science* 53:964-971
- Blackburn TH, Henriksen K (1983) Nitrogen cycling in different types of sediments from danish waters. *Limnology and Oceanography* 28:477-493
- Blackmer AM, Bremner JM (1978) Inhibitory effect of nitrate on reduction of N₂O to N₂ by soil microorganisms *Soil Biology & Biochemistry* 10:187-191
- Bolam SG, Barrio-Frojan CRS, Eggleton JD (2010) Macrofaunal production along the UK continental shelf. *Journal of Sea Research* 64:166-179
- Bonin P, Raymond N (1990) Effects of Oxygen on Denitrification in Marine-Sediments. *Hydrobiologia* 207:115-122
- Brune A, Kuhl M (1996) pH profiles of the extremely alkaline hindguts of soil-feeding termites (Isoptera: Termitidae) determined with microelectrodes. *Journal of Insect Physiology* 42:1121-1127
- Canfield DE, Kristensen E, Thamdrup B (2005) *Aquatic Geomicrobiology*, Elsevier Academic Press
- Denman, KL, Brasseur G, Chidthaisong A, Ciais P, Cox PM, Dickinson RE, Hauglustaine D, Heinze C, Holland E, Jacob D, Lohmann U, Ramachandran S, da Silva Dias PL, Wofsy SC, and Zhang X (2007): Couplings Between Changes in the Climate System and Biogeochemistry. In: *Climate Change 2007: The Physical Science Basis. Contribution of Working Group I to the Fourth Assessment Report of the Intergovernmental Panel on Climate Change* [Solomon S, Qin D, Manning M, Chen Z, Marquis M, Averyt KB, Tignor M,

- and Miller HL (eds.)]. Cambridge University Press, Cambridge, United Kingdom and New York, NY, USA.
- Devol AH (2008) Denitrification including anammox. In: Douglas G Capone, Deborah A Bronk, Margaret R Mulholland and Edward J Carpenter (eds) *Nitrogen in the marine environment*. Elsevier Academic Press, pp 263-301
- Drake HL, Schramm A, Horn MA (2006) Earthworm gut microbial biomes: their importance to soil microorganisms, denitrification, and the terrestrial production of the greenhouse gas N₂O. In: König H, Varma A (eds) *Soil biology, Vol 6. Intestinal microorganisms of soil invertebrates*. Springer-Verlag, Heidelberg, p 65–87
- Drake HL, Horn MA (2007) As the worm turns: The earthworm gut as a transient habitat for soil microbial biomes. *Annual Review of Microbiology* 61:169-189
- FAO. The State of World Fisheries and Aquaculture, 2010; Food and Agricultural Organization of the United Nations: Rome, Italy, 2010.
- FAO (Food and Agriculture Organization of the United Nations): Fisheries and Aquaculture Information and Statistics Service - June 2012, http://www.fao.org/fishery/culturedspecies/Litopenaeus_vannamei/en
- Firestone MK, Smith MS, Firestone RB, Tiedje JM (1979) Influence of nitrate, nitrite, and oxygen on the composition of the gaseous products of denitrification in soil *Soil Science Society of America Journal* 43:1140-1144
- Forster P, Ramaswamy V, Artaxo P, Berntsen T, Betts T, Fahey DW, Haywood J, Lean J, Lowe DC, Myhre G, Nganga J, Prinn R, Raga G, Schulz M, and Van Dorland R, (2007): Changes in Atmospheric Constituents and in Radiative Forcing. In: *Climate Change 2007: The Physical Science Basis. Contribution of Working Group I to the Fourth Assessment Report of the Intergovernmental Panel on Climate Change* [Solomon S, Qin D, Manning M, Chen Z, Marquis M, Averyt KB, Tignor M, and Miller HL (eds.)]. Cambridge University Press, Cambridge, United Kingdom and New York, NY, USA.
- Frette L, Gejlsbjerg B, Westermann P (1997) Aerobic denitrifiers isolated from an alternating activated sludge system. *Fems Microbiology Ecology* 24:363-370
- Galloway JN, Townsend AR, Erisman JW, Bekunda M, Cai ZC, Freney JR, Martinelli LA, Seitzinger SP, Sutton MA (2008) Transformation of the nitrogen cycle: Recent trends, questions, and potential solutions. *Science* 320:889-892
- Gao H, Schreiber F, Collins G, Jensen MM, Kostka JE, Lavik G, de Beer D, Zhou HY, Kuypers MMM (2010) Aerobic denitrification in permeable Wadden Sea sediments. *Isme Journal* 4:417-426
- Gardner WS, Briones EE, Kaegi EC, Rowe GT (1993) Ammonium excretion by benthic invertebrates and sediment-water flux in the Gulf of Mexico near the Mississippi river outflow. *Estuaries* 16:799-808
- Goreau TJ, Kaplan WA, Wofsy SC, McElroy MB, Valois FW, Watson SW (1980) Production of NO₂⁻ and N₂O by Nitrifying Bacteria at Reduced Concentrations of Oxygen. *Applied and Environmental Microbiology* 40:526-532
- Grall J, Chauvaud L (2002) Marine eutrophication and benthos: the need for new approaches and concepts. *Global Change Biology* 8:813-830
- Horn MA, Schramm A, Drake HL (2003) The earthworm gut: An ideal habitat for ingested N₂O-producing microorganisms. *Applied and Environmental Microbiology* 69:1662-1669
- Inman DL, Jenkins SA (2005) Energy and sediment budgets of the global coastal zone. In: Schwartz M (ed) *Encyclopedia of Coastal Science*, Encyclopedia of Earth Sciences Series, Springer, Dordrecht, Netherlands, pp 408-415

- Jorgensen BB, Sorensen J (1985) Seasonal cycles of O₂, NO₃⁻ and SO₄²⁻ reduction in estuarine sediments - the significance of an NO₃⁻ reduction maximum in spring. *Marine Ecology-Progress Series* 24:65-74
- Jorgensen KS, Sorensen J (1988) 2 annual maxima of nitrate reduction and denitrification in estuarine sediment (Norsminde Fjord, Denmark). *Marine Ecology-Progress Series* 48:147-154
- Kamp A, de Beer D, Nitsch JL, Lavik G, Stief P (2011) Diatoms respire nitrate to survive dark and anoxic conditions. *Proceedings of the National Academy of Sciences of the United States of America* 108:5649-5654
- Kamykowski D, Zentara SJ (2005) Changes in world ocean nitrate availability through the 20th century. *Deep-Sea Research Part I-Oceanographic Research Papers* 52:1719-1744
- Kieskamp WM, Lohse L, Epping E, Helder W (1991) Seasonal-Variation in Denitrification Rates and Nitrous-Oxide Fluxes in Intertidal Sediments of the Western Wadden Sea. *Marine Ecology-Progress Series* 72:145-151
- Laverock B, Gilbert JA, Tait K, Osborn AM, Widdicombe S (2011) Bioturbation: impact on the marine nitrogen cycle. *Biochemical Society Transactions* 39:315-320
- Lomas MW, Glibert PM (2000) Comparisons of nitrate uptake, storage, and reduction in marine diatoms and flagellates. *Journal of Phycology* 36:903-913
- McHenry JG, Allen JA, Birkbeck TH (1986) Distribution of lysozyme-like activity in 30 bivalve species. *Comparative Biochemistry and Physiology B-Biochemistry & Molecular Biology* 85:581-584
- Meyer RL, Allen DE, Schmidt S (2008) Nitrification and denitrification as sources of sediment nitrous oxide production: A microsensor approach. *Marine Chemistry* 110:68-76
- Middelburg JJ (1995) Nitrous-Oxide Emissions from Estuarine Intertidal Sediments. *Hydrobiologia* 311:43-55
- Nixon SW, Buckley BA (2002) "A strikingly rich zone" - Nutrient enrichment and secondary production in coastal marine ecosystems. *Estuaries* 25:782-796
- Patureau D, Zumstein E, Delgenes JP, Moletta R (2000) Aerobic denitrifiers isolated from diverse natural and managed ecosystems. *Microbial Ecology* 39:145-152
- Philippot L, Mirleau P, Mazurier S, Siblot S, Hartmann A, Lemanceau P, Germon JC (2001) Characterization and transcriptional analysis of *Pseudomonas fluorescens* denitrifying clusters containing the nar, nir, nor and nos genes. *Biochimica Et Biophysica Acta-Genes Structure and Expression* 1517:436-440
- Plante CJ, Shriver AG (1998) Patterns of differential digestion of bacteria in deposit feeders: a test of resource partitioning. *Marine Ecology-Progress Series* 163:253-258
- Richardson D, Felgate H, Watmough N, Thomson A, Baggs E (2009) Mitigating release of the potent greenhouse gas N₂O from the nitrogen cycle - could enzymic regulation hold the key? *Trends in Biotechnology* 27:388-397
- Rysgaard S, Christensen PB, Nielsen LP (1995) Seasonal-Variation in Nitrification and Denitrification in Estuarine Sediment Colonized by Benthic Microalgae and Bioturbating Infauna. *Marine Ecology-Progress Series* 126:111-121
- Schmitt-Wagner D, Brune A (1999) Hydrogen profiles and localization of methanogenic activities in the highly compartmentalized hindgut of soil-feeding higher termites (*Cubitermes* spp.). *Applied and Environmental Microbiology* 65:4490-4496

- Schreiber F, Loeffler B, Polerecky L, Kuypers MMM, de Beer D (2009) Mechanisms of transient nitric oxide and nitrous oxide production in a complex biofilm. *Isme Journal* 3:1301-1313
- Seitzinger SP (1988) Denitrification in Fresh-Water and Coastal Marine Ecosystems - Ecological and Geochemical Significance. *Limnology and Oceanography* 33:702-724
- Stein LY (2011) Surveying N₂O-producing pathways in bacteria. In: Klotz MG (ed) *Methods in Enzymology*, Elsevier Academic Press; pp 131-152
- Stief P, Eller G (2006) The gut microenvironment of sediment-dwelling *Chironomus plumosus* larvae as characterised with O₂, pH, and redox microsensors. *Journal of Comparative Physiology B-Biochemical Systemic and Environmental Physiology* 176:673-683
- Stief P, Polerecky L, Poulsen M, Schramm A (2010) Control of nitrous oxide emission from *Chironomus plumosus* larvae by nitrate and temperature. *Limnology and Oceanography* 55:872-884
- Stief P, Poulsen M, Nielsen LP, Brix H, Schramm A (2009) Nitrous oxide emission by aquatic macrofauna. *Proceedings of the National Academy of Sciences of the United States of America* 106:4296-4300
- Stief P, Schramm A (2010) Regulation of nitrous oxide emission associated with benthic invertebrates. *Freshwater Biology* 55:1647-1657
- Svensson JM (1998) Emission of N₂O, nitrification and denitrification in a eutrophic lake sediment bioturbated by *Chironomus plumosus*. *Aquatic Microbial Ecology* 14:289-299
- Tang KW, Glud RN, Glud A, Rysgaard S, Nielsen TG (2011) Copepod guts as biogeochemical hotspots in the sea: Evidence from microelectrode profiling of *Calanus* spp. *Limnology and Oceanography* 56:666-672
- Usui T, Koike I, Ogura N (2001) N₂O production, nitrification and denitrification in an estuarine sediment. *Estuarine Coastal and Shelf Science* 52:769-781
- van Beusekom JEE, de Jonge VN (2002) Long-term changes in Wadden Sea nutrient cycles: importance of organic matter import from the North Sea. *Hydrobiologia* 475:185-194
- Wahl M (1989) Marine epibiosis. 1. Fouling and antifouling - some basic aspects *Marine Ecology-Progress Series* 58:175-189
- Ward BB (2008) Nitrification in marine systems In: Douglas G Capone, Deborah A Bronk, Margaret R Mulholland and Edward J Carpenter (eds) *Nitrogen in the marine environment*. Elsevier Inc., pp 199-261
- Wei CL, Rowe GT, Escobar-Briones E, Boetius A, Soltwedel T, Caley MJ, Soliman Y, Huettmann F, Qu FY, Yu ZS, Pitcher CR, Haedrich RL, Wicksten MK, Rex MA, Baguley JG, Sharma J, Danovaro R, MacDonald IR, Nunnally CC, Deming JW, Montagna P, Levesque M, Weslawski JM, Wlodarska-Kowalczyk M, Ingole BS, Bett BJ, Billett DSM, Yool A, Bluhm BA, Iken K, Narayanaswamy BE (2010) Global Patterns and Predictions of Seafloor Biomass Using Random Forests. *Plos One* 5
- Williams J, Crutzen PJ (2010) Nitrous oxide from aquaculture. *Nature Geoscience* 3:143-143
- Ysebaert T, Fettweis M, Meire P, Sas M (2005) Benthic variability in intertidal soft-sediments in the mesohaline part of the Schelde estuary. *Hydrobiologia* 540:197-216

Zumft WG, Körner H. (2007) Nitrous oxide reductases. In: Bothe H, Ferguson SJ, Newton WE (eds.). *Biology of the Nitrogen Cycle*. Amsterdam Elsevier, pp. 67–81

Contributed works

Denitrification in human dental plaque

Microscopic oxygen imaging based on
fluorescein bleaching efficiency measurements

Denitrification in human dental plaque

Frank Schreiber¹, Peter Stief¹, Armin Gieseke¹, Ines M Heisterkamp¹, Willy Verstraete², Dirk de Beer¹, Paul Stoodley^{3,4}

¹Microsensor Research Group, Max Planck Institute for Marine Microbiology,
Celsiusstraße 1, 28359 Bremen, Germany.

²Laboratory of Microbial Ecology and Technology (LabMET), Ghent University,
Coupure Links 653, B-9000 Ghent, Belgium.

³Center for Genomic Sciences, Allegheny General Hospital/Allegheny-Singer Research
Institute, 320 East North Avenue, Pittsburgh 15212-4772,
Pennsylvania, USA.

⁴National Centre for Advanced Tribology at Southampton (nCATS), School of
Engineering Sciences, University of Southampton,
Highfield, Southampton SO17 1BJ, UK.

Published in *BMC Biology* 8:24, 2010

I.M. Heisterkamp performed the molecular analysis of dental plaque with help of A. Gieseke and P. Stief and contributed to measurements of oral N₂O emissions.

Abstract

Background: Microbial denitrification is not considered important in human-associated microbial communities. Accordingly, metabolic investigations of the microbial biofilm communities of human dental plaque have focused on aerobic respiration and acid fermentation of carbohydrates, even though it is known that the oral habitat is constantly exposed to nitrate (NO_3^-) concentrations in the millimolar range and that dental plaque houses bacteria that can reduce this NO_3^- to nitrite (NO_2^-).

Results: We show that dental plaque mediates denitrification of NO_3^- to nitric oxide (NO), nitrous oxide (N_2O), and dinitrogen (N_2) using microsensor measurements, ^{15}N isotopic labelling and molecular detection of denitrification genes. *In vivo* N_2O accumulation rates in the mouth depended on the presence of dental plaque and on salivary NO_3^- concentrations. NO and N_2O production by denitrification occurred under aerobic conditions and was regulated by plaque pH.

Conclusions: Increases of NO concentrations were in the range of effective concentrations for NO signalling to human host cells and, thus, may locally affect blood flow, signalling between nerves and inflammatory processes in the gum. This is specifically significant for the understanding of periodontal diseases, where NO has been shown to play a key role, but where gingival cells are believed to be the only source of NO. More generally, this study establishes denitrification by human-associated microbial communities as a significant metabolic pathway which, due to concurrent NO formation, provides a basis for symbiotic interactions.

Table 1: Denitrification genes in dental biofilms of five volunteers

Volunteer	NO_3^- reductase	NO_2^- reductase		NO reductase		N_2O reductase
	<i>narG</i>	<i>nirS</i>	<i>nirK</i>	<i>cnorB</i>	<i>qnorB</i>	<i>nosZ</i>
A	+	+	+	-	+	+
B	+	+	+	-	+	+
C	+	+	+	-	+	+
D	+	-	+	-	+	+
E	+	NA	NA	-	+	NA

Results are based on detection of PCR product with the expected size or on additional analysis of the sequence of the PCR product.

NA = not analysed.

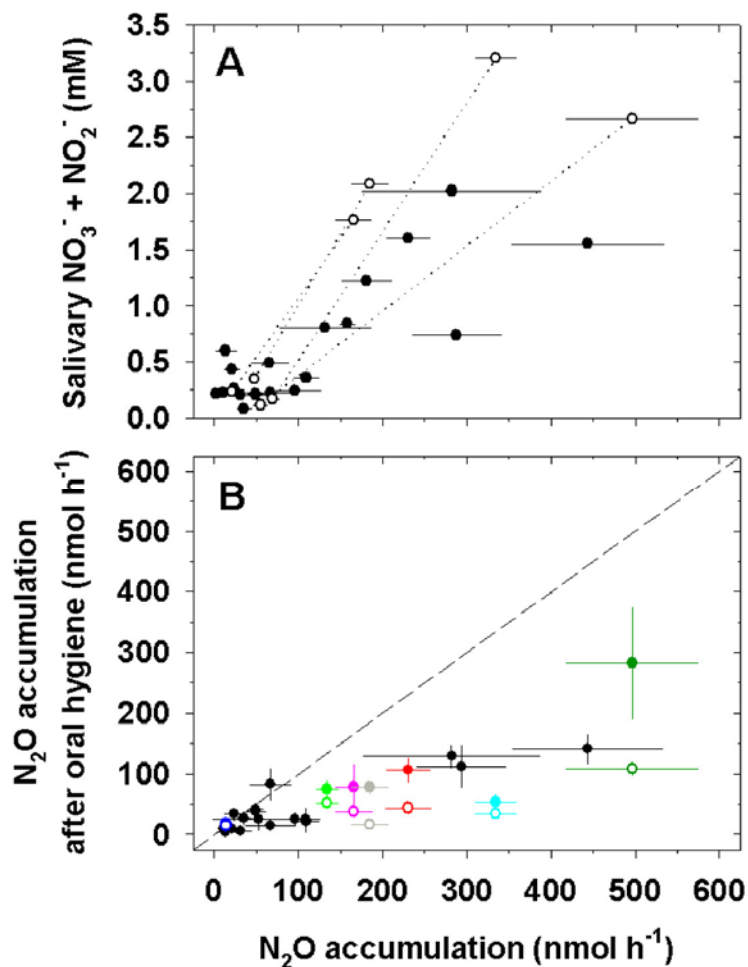

Figure 4: N_2O formation in the human mouth is dependent on salivary $\text{NO}_2^-/\text{NO}_3^-$ concentrations and the presence of dental plaque. **(a)** Correlation of oral N_2O production and salivary $\text{NO}_2^-/\text{NO}_3^-$ concentration in 15 volunteers with unbrushed teeth. Each data point represents the rate of oral N_2O accumulation of one individual on a certain day (black circles). Some volunteers were sampled on more than 1 day resulting in 19 data points in total. Four volunteers were additionally sampled before and after drinking NO_3^- -rich beetroot juice to increase salivary $\text{NO}_2^-/\text{NO}_3^-$ concentration and oral N_2O accumulation (white circles connected by dotted line). **(b)** Effect of oral hygiene on N_2O accumulation rate in the mouth. Oral N_2O accumulation rate of individuals before tooth brushing plotted against the N_2O accumulation rate after tooth brushing (closed circles). In six individuals an antiseptic mouth rinse that affects bacteria in the entire oral cavity was applied after tooth brushing (open circles, each of the six individuals is represented by a unique colour). For example, an individual (dark green) with an oral N_2O accumulation rate of 500 nmol/h reduced the rate to 290 nmol/h by tooth brushing. Subsequent application of a mouth rinse resulted in a rate of 110 nmol/h . The dashed line corresponds to the absence of an effect of oral hygiene on the oral N_2O accumulation. The error bars indicate the standard error of five replicate measurements of the oral N_2O accumulation rate.

Microscopic oxygen imaging based on fluorescein bleaching efficiency measurements

Martin Beutler^{1,2}, Ines M. Heisterkamp¹, Peter Stief¹, Dirk de Beer¹

¹Microsensor Research Group, Max Planck Institute for Marine Microbiology,
Celsiusstraße 1, 28359 Bremen, Germany

²bionsys GmbH, Fahrenheitstr. 1, 28359 Bremen, Germany

Manuscript in preparation

I.M. Heisterkamp contributed to microsensor measurements and performed oxygen measurements in shell biofilms of different marine mollusc species.

Abstract

Photobleaching of the fluorophore fluorescein in an aqueous solution is dependent of the apparent oxygen concentration. Therefore, the analysis of the time-dependent bleaching behaviour is a useful measure of dissolved oxygen concentrations that can be combined with epi-fluorescence microscopy. The molecular states of the fluorophore can be expressed by a three-state energy model. This leads to a set of differential equations which describe the photobleaching behaviour of fluorescein. The numerical solution of these equations shows that in a conventional wide-field fluorescence microscope, the fluorescence of fluorescein will fade out faster at low than at high oxygen concentration. Further simulation showed that a simple ratio function of different time-points during a fluorescence decay recorded during photobleaching could be used to describe oxygen concentrations in an aqueous solution. Additional findings were that a careful choice of dye concentration or excitation light intensity could help to increase sensitivity in the oxygen concentration range of interest. In the simulations, the estimation of oxygen concentration by the ratio function was very little affected by the pH value in the range of pH 6.5 to 8.5. Filming the fluorescence decay by a charge-coupled-device (ccd) camera mounted on a fluorescence microscope allowed a pixelwise estimation of the ratio function in a microscopic image. Use of a microsensor and oxygen-consuming bacteria in a sample chamber enabled the calibration of the system for quantification of absolute oxygen concentrations. Finally, the method was employed to nitrifying biofilms growing on snail and mussel shells to estimate apparent oxygen concentrations.

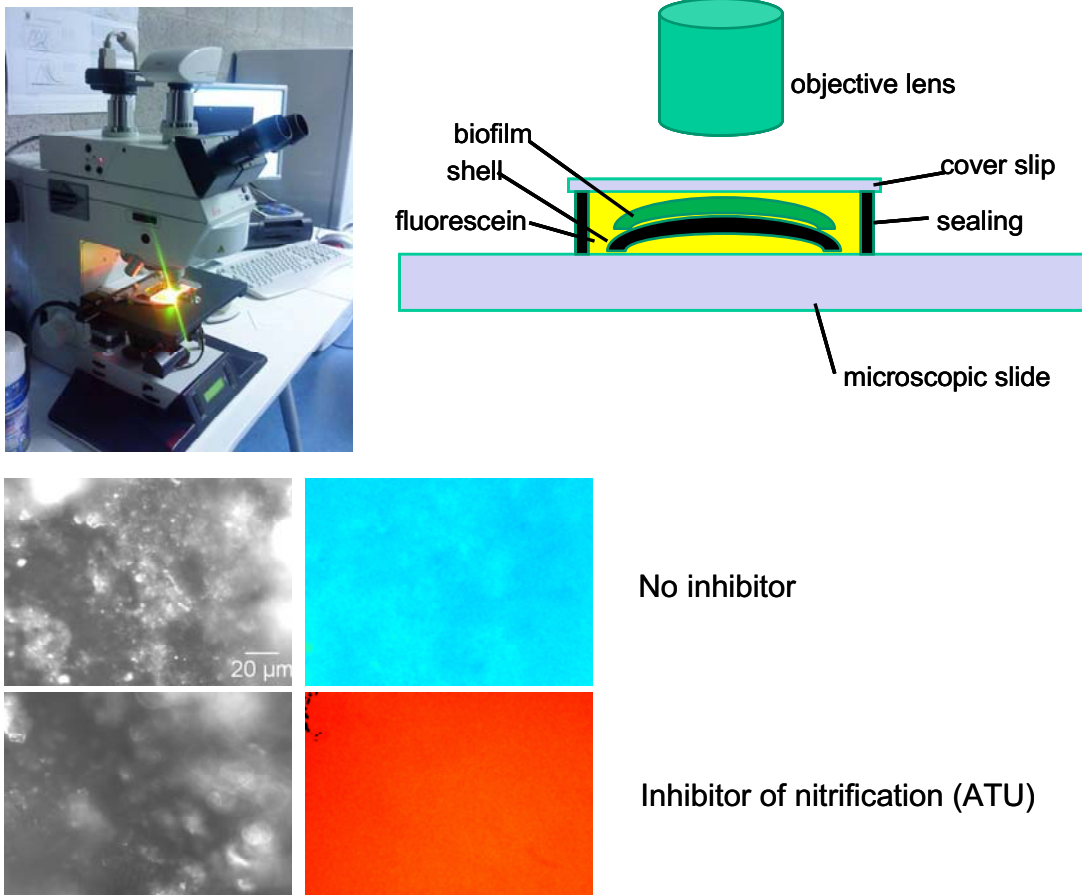

Figure 8: Oxygen measurements in microbial biofilms on the shell surfaces of marine invertebrates based on fluorescein bleaching measurements. Top left: fluorescence microscope with camera by which time series of fluorescein bleaching were measured. Top right: drawing of measuring chamber with incubated biofilm-covered shell. Bottom left: reflectance images of the biofilms on the shell of the mussel *Mytilus edulis*. Bottom right: oxygen images after biofilm-covered shells of *M. edulis* were incubated in artificial seawater without inhibitor and with the nitrification inhibitor allylthiourea (ATU) for 5 minutes. Blue means oxygen-depleted, red oxygen-saturated.

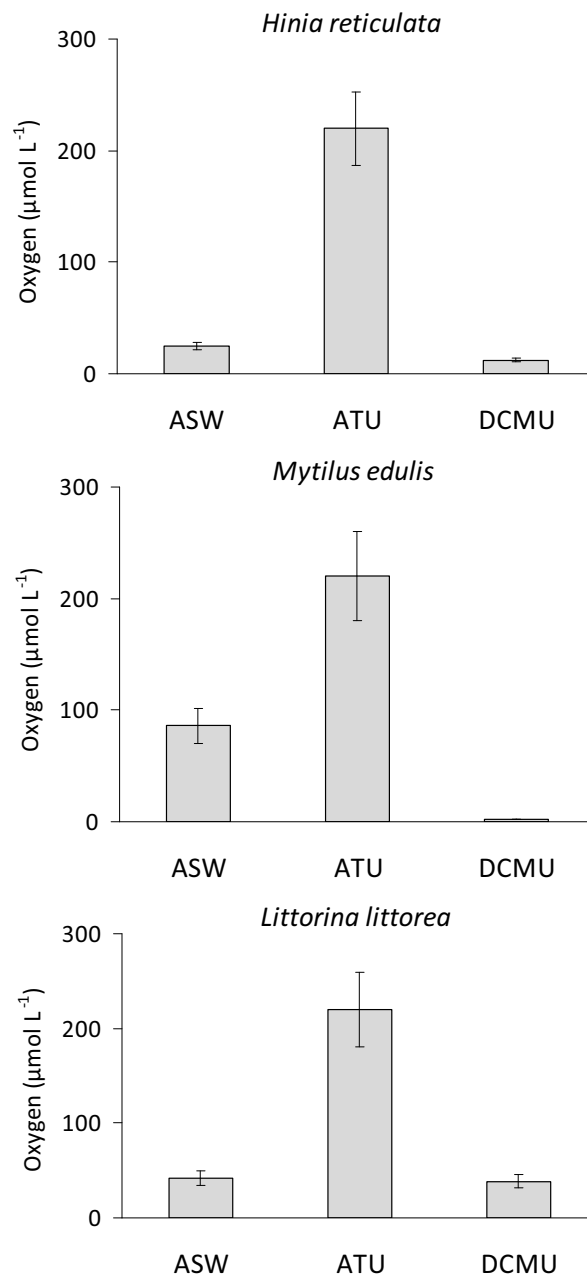

Figure 9: Oxygen concentrations in biofilms on the shells of the three mollusc species *Hinia reticulata*, *Mytilus edulis*, and *Littorina littorea*. Intact shell biofilms were incubated in artificial seawater without inhibitor (ASW), with the nitrification inhibitor allylthiourea (ATU), and with the photosynthesis inhibitor 3-(3,4-dichlorophenyl)-1,1-dimethylurea (DCMU). After 5 minutes of incubation, oxygen concentration was measured by photobleaching.

Danksagung

Zuerst möchte ich mich herzlichst bei Prof. Dr. Bo Barker Jørgensen bedanken, dass er mich als seine letzte Doktorandin am Max-Planck-Institut angenommen hat und für das Verfassen des Erstgutachtens. Vielen Dank geht auch an Herrn Prof. Dr. Ulrich Fischer, der so freundlich war das Zweitgutachten zu übernehmen. Herzlich bedanken möchte ich mich ebenfalls bei den anderen Mitglieder des Prüfungskomitees Herrn Prof. Dr. Victor Smetacek, Dr. Peter Stief, Kristina Stemmer und Johanna Wiedling.

Mein größter Dank gilt Peter Stief, meinem Betreuer und Mentor während meiner Doktorarbeitszeit. Peter, ich habe dir so vieles zu verdanken und möchte mich von ganzem Herzen für deine großartige Unterstützung in den letzten Jahren bedanken. Ich habe deine humorvolle Art, dein stets offenes Ohr, deine Ideen und Ratschläge für die Laborarbeit als auch beim Verfassen der Manuskript sehr geschätzt.

Großer Dank gilt natürlich auch Dirk de Beer, der meine Arbeit in der Mikrosensorgruppe immer unterstützt hat und mir mit seinen Kommentaren und Ideen weitergeholfen hat.

Einen ganz besonderen Dank möchte ich den lieben „Dänen“ aussprechen, Andreas Schramm, Nanna Svenningsen, Lone Heimann, Maria Sigby-Clausen und Lars Peter Nielsen für die sehr gute langjährige Zusammenarbeit, die ich sehr genossen habe. Ich möchte mich an dieser Stelle auch bei der gesamten Mikrobiologiegruppe der Universität Aarhus bedanken, die mich immer herzlich aufgenommen hat bei meinen zahlreichen Besuchen und mir eine tolle Zeit im schönen Aarhus bereitet hat.

Vielen herzlichen Dank für die gute Zusammenarbeit gilt auch Anja Kamp, für die vielen guten Gespräche und schönen gemeinsamen Stunden im Labor und in der Teeküche, Gaute Lavik dafür, dass er mir die Geheimnisse der Massenspektrometrie näher gebracht hat und für anregende Diskussionen, Frank Schreiber für seine interessanten Anregungen und einer spannenden Arbeit, bei der wir selbst Probanden waren und Martin Beutler, für die zahlreichen Stunden mit ihm vor dem Mikroskop und guten Diskussionen.

Vielen Dank gilt natürlich auch der Mikrosensorgruppe, in der ich mich all die Jahre so wohl gefühlt habe. Vielen Dank an die TA's für ihre Hilfe, wann immer ich sie gebraucht habe. Und an euch, liebe anderen Doktoranden der Mikrosensorgruppe, für die motivierenden Gespräche, Diskussion über die Wissenschaft und das Leben. Haltet durch, ihr habt es auch bald geschafft.

Ganz lieben Dank auch an meine „Mädels“ (Anna, Anne, Frauke, Julia, Kirsten, Sandra, Ulli und Verena) für die vielen amüsanten Mittagspausen und Mädelsabende. Mein besonderer Dank geht dabei an Anna und Anne, die immer für mich da waren und mich aufgemuntert haben, wenn es mal nicht so gut lief.

Natürlich möchte ich auch meine Bürokollegen danken, Mohammad Al-Najjar, Kristina Stemmer und Stefan Häusler, sowie allen vorherigen Bürokollegen. Vielen Dank für die tolle Zeit und super Atmosphäre.

Ganz herzlich möchte ich meinen Mitbewohnern Ela, Jutta, Sebastian und Mika danken. Ich habe die gemeinsame Zeit mit euch unglaublich genossen und danke euch sehr, für die gemütlichen Abende in der Küche und dafür, dass ihr mir ein so schönes Zuhause bereitet habt. Ela, dir möchte ich besonders danken für deine Hilfe und dein Verständnis vor allem in der Endphase der Arbeit.

Danke auch an alle meine Freunde, die in den letzten Jahren oft von mir hören mussten, dass ich keine Zeit habe, aber immer verständnisvoll waren und mir viel Mut zu gesprochen haben.

Zum Schluss möchte ich von ganzem Herzen meiner Familie danken; für ihre Liebe, Vertrauen und Glauben an mich, der mir geholfen hat, die manchmal doch sehr schwierige Zeit gut zu überstehen. Ohne euch hätte ich das nie geschafft. Ganz besonders möchte ich dir danken, Matthias, für dein immerwährendes Verständnis, deine Unterstützung und dass du immer für mich da bist.