

**Regulation of anaerobic catabolism of aromatic compounds  
and sulfate reduction in *Desulfobacula toluolica* Tol2**

Dissertation  
zur Erlangung des Grades eines  
Doktors der Naturwissenschaften  
- Dr. rer. nat. -

dem Fachbereich Biologie/Chemie  
der Universität Bremen  
vorgelegt von

**Jacob H. Jacob**

Bremen  
2007

**Die Untersuchungen zur vorliegenden Doktorarbeit wurden am Max-Planck-Institut für Marine Mikrobiologie in Bremen durchgeführt.**

**1. Gutachter: Prof. Dr. Friedrich Widdel**

**2. Gutachter: Prof. Dr. Ralf Rabus**

Tag des Promotionskolloquiums: 20, September 2007

To my family

## Contents

Summary	
Abbreviations	
	Page
Title	
<b>A Introduction</b>	
1. Aromatic compounds	
1.1. Definition, chemical properties and classification	1
1.2. Sources	2
1.3. Toxicity	2
2. Aerobic catabolism of aromatic compounds	3
3. Anaerobic catabolism of aromatic compounds	
3.1. Microorganisms	4
3.2. Degradation pathways	6
4. Dissimilatory sulfate reduction	8
5. <i>Desulfobacula toluolica</i> Tol2	10
6. Aims of study	11
<b>B Materials and methods</b>	
1. Chemicals, gases and source of bacterium	12
2. Cultivation techniques	
2.1. Medium composition and preparation	
2.1.1. Preparation of stock solutions	12
2.1.2. Preparation of mineral medium	15
2.1.3. Organic substrates and electron acceptors	16
2.2. Cultivation	
2.2.1. Physiological adaptations	18
2.2.2. Monitoring growth	18
2.2.3. Mass cultivation and cell harvesting	19
3. Analytical methods	
3.1. Quantification of sulfide	19
3.2. Quantification of sulfate, sulfite and thiosulfate	21

4. Proteomic methods	
4.1. Cell breakage and protein extraction	
4.1.1. Protein extraction for SDS-PAGE	22
4.1.2. Protein extraction for two-dimensional gel electrophoresis	23
4.2. Protein quantification	23
4.3. Fluorescence protein labeling	
4.3.1. One-dimensional difference gel electrophoresis	24
4.3.2. Two-dimensional difference gel electrophoresis	26
4.4. Gel electrophoresis	
4.4.1. SDS-PAGE	27
4.4.2. Two-dimensional gel electrophoresis	31
4.5. Gel visualization and documentation	
4.5.1. Staining methods	35
4.5.2. Scanning of DIGE gels	38
4.6. 2D DIGE image analysis	38
4.7. Protein identification	38

## C Results

Part I – Anaerobic catabolism of aromatic compounds	
1. Growth behavior	40
2. Proteomic analysis	
2.1. Detection of BssA-like proteins by SDS-PAGE	42
2.2. Optimization of 2DE-based protein separation	
2.2.1. Immobilized pH-gradient ranges	47
2.2.2. Immobilized pH gradient versus non-equilibrium pH gradient	51
2.2.3. Sample rehydration	
2.3. Aromatic-compound specific differential protein profiles	53
2.4. Mass spectrometric analysis of regulated and non-regulated proteins	54
Part II – Regulation of sulfate reduction pathway by different electron acceptors	
1. Growth behavior	58
2. Proteomic analysis	
2.1. Regulation of sulfate reduction enzymes	60
2.2. Electron-acceptor specific regulation	62

Part III – Dissemination of BssA-like proteins among alkylbenzene- , 2-methylnaphthalene- and naphthalene-degrading sulfate-reducing bacteria	65
--	----

## **D Discussion**

1. Anaerobic activation of toluene and <i>p</i> -cresol	71
2. Regulation of anaerobic catabolism of aromatic compounds coupled to sulfate reduction	73
3. Regulation of dissimilatory sulfate reduction pathway by different electron acceptors	79
4. Anaerobic activation of alkylbenzenes, 2-methylnaphthalene and naphthalene in sulfate-reducing bacteria	82

## **E Literature** 84

## **F Appendices**

1. Equations for quantification of sulfide determined by titration	96
2. Calibration curve for quantification of sulfide	97
3. Calibration curves for quantification of proteins	98
4. Anaerobic growth of <i>D. toluolica</i> Tol2 with <i>p</i> -cresol	99
5. Protein profiles of <i>D. toluolica</i> Tol2 grown anaerobically with different aromatic compounds	100

## Summary

The metabolic regulation of the sulfate-reducing bacteria in response to the availability and adaptation to aromatic growth substrates was studied by a combined physiological/proteomic approach. The study organism is the marine aromatic compound-degrading sulfate-reducing *Desulfobacula toluolica* Tol2.

### **a) Anaerobic catabolism of aromatic compounds in *D. toluolica* Tol2**

*D. toluolica* Tol2 can grow anaerobically with various aromatic compounds including toluene, phenylacetate, *p*-cresol, *p*-hydroxybenzaldehyde, *p*-hydroxybenzoate and benzoate under sulfate-reducing conditions. In denitrifiers, catabolism of these aromatic compounds proceeds via specific peripheral reaction sequences to the central intermediate benzoyl-CoA. The latter is reductively dearomatized by an ATP-consuming reaction. Hydrolytic ring cleavage is followed by  $\beta$ -oxidation yielding acetyl-CoA, which is completely oxidized to CO<sub>2</sub> via the TCA cycle. Even though similar routes can be assumed for sulfate-reducing bacteria, their low energy yield argues against an ATP-dependent dearomatization of benzoyl-CoA. Also, *D. toluolica* Tol2 employs the C<sub>1</sub>/CO dehydrogenase pathway for complete oxidation of acetyl-CoA to CO<sub>2</sub>. Here, substrate-dependent regulation of the respective aromatic compound degradation pathways in *D. toluolica* Tol2 was studied by SDS-PAGE and two-dimensional gel electrophoresis (2 DE). Differences in protein abundances were quantified by differential fluorescence labeling (SDS-PAGE and two-dimensional difference gel electrophoresis [2D DIGE]). Fumarate-grown cells served as reference state. BssA (catalytic subunit of toluene-activating benzylsuccinate synthase) was resolved by SDS-PAGE in cells grown with toluene and *p*-cresol. However, the changes in BssA abundance varied by one order of magnitude: 40-fold in toluene- versus 4.5-fold in *p*-cresol-grown cells. Thus, the initial reaction of anaerobic *p*-cresol degradation could, in analogy to toluene, involve addition to fumarate yielding 4-hydroxybenzylsuccinate, but *p*-cresol may also just act as gratuitous inducer of toluene catabolic genes. A wide array of protein spots was detected by 2D DIGE, the abundance of which was specifically regulated by the aromatic compound used for growth adaptation. Remarkably, only a minor fraction of them could be identified by scanning PMFs/PFFs against the public data base. Due to the low number of identified proteins, one may speculate that novel reactions/enzymes may be involved in the respective anaerobic catabolic pathways. Subunits of the key enzymes of the sulfate reduction

pathway were identified: adenosine-5'-phosphosulfate reductase subunit A (AprA), dissimilatory sulfite reductase subunit A (DsrA) and dissimilatory sulfite reductase subunit B (DsrB). However, 2D DIGE analysis revealed mostly unchanged abundances of these three proteins irrespective of the aromatic compounds used for growth/adaptation of the cells.

**b) Are terminal electron-accepting pathways constitutive or electron-acceptor inducible?**

Regulation of AprA, DsrA and DsrB was also studied under different electron-acceptor conditions (growth with sulfate, sulfite, thiosulfate or a mixture of sulfate, sulfite and thiosulfate). 2D DIGE analysis revealed mostly unchanged abundances of the three subunits of enzymes indicating their constitutive formation under all studied conditions. However, a number of specifically regulated protein spots could be detected under each electron-acceptor condition.

**c) Dissemination of BssA-like proteins in alkylbenzene-, methylnaphthalene- and naphthalene-degrading sulfate-reducing bacteria**

Anaerobic toluene degradation in *D. toluolica* Tol2 was previously demonstrated to be initiated by fumarate-dependent formation of benzylsuccinate. The dissemination of this reaction principle was studied in other hydrocarbon-degrading (alkylbenzenes, methylnaphthalene and naphthalene) sulfate-reducing bacteria. BssA-like protein bands could be resolved by SDS-PAGE and identified from all cells grown with alkylbenzenes and methylnaphthalene but not with naphthalene.



## Abbreviations

BSA	bovine serum albumin
CHAPS	3-[(3-cholamidopropyl)dimethylammonio]-1-propane-sulfonate
Cy2	3-(4-carboxymethyl)phenylmethyl)-3'-ethyloxycarbocyanine halide <i>N</i> -hydroxysuccinimidylester
Cy3	1-(5-carboxypentyl)-1'-propylindocarbocyanine halide <i>N</i> -hydroxysuccinimidylester
Cy5	1-(5-carboxypentyl)-1'-methylindodicarbocyanine halide <i>N</i> -hydroxysuccinimidylester
1 DE	one-dimensional gel electrophoresis
2 DE	two-dimensional gel electrophoresis
DIGE	difference gel electrophoresis
DTT	dithiothreitol
EDTA	ethylenediaminetetraacetic acid
IPG	immobilized pH gradient
kD	kilo Dalton
N	normality
NEPHGE	non equilibrium pH gel electrophoresis
OD <sub>660</sub>	optical density at 660 nm
P <sub>i</sub>	inorganic phosphate
PMF	peptide mass fingerprint
PFF	peptide fragment fingerprint
rpm	rotation per minute
RT	room temperature
SDS	sodiumdodecyl sulfate
PAGE	polyacrylamide gel electrophoresis
TCA	tricarboxylic acid
Tris	trihydroxymethylaminomethane
VIS	visible light
vol:vol	volume to volume ratio

## A Introduction

### A. 1. Aromatic compounds

#### A. 1. 1. Definition, chemical properties and classification

Aromatic compounds contain at least one cyclic, unsaturated, planar ring system consisting primarily of C and H (e.g. benzene) and may contain other atoms like oxygen (e.g. furan), nitrogen (e.g. pyridine) or sulfur (e.g. thiophene). They exhibit low chemical reactivity at moderate temperature range due to the delocalized  $\pi$  electron system and the resonance energy ( $>100 \text{ kJ mol}^{-1}$ ; Boll, 2005) of the aromatic ring. Different classes of aromatic compounds can be distinguished in nature based on their atomic structure and relative chemical reactivity. For instance, aromatic compounds can be classified into monocyclic or polycyclic compounds. Within the class of monocyclic compounds, one may distinguish between hydrocarbon compounds and polar compounds. Hydrocarbon compounds (e.g. toluene, ethylbenzene and xylenes; Fig. 1, a) lack functional groups and polarized bonds. On the other hand, polar aromatic compounds possess functional group(s) of activating effect that render them more reactive than their hydrocarbon counterparts.

Polycyclic aromatic compounds are defined by containing more than one ring system fused together by sharing two neighbouring carbon atoms. As with monocyclic compounds, polycyclic aromatic compounds may include heteroatom(s) like oxygen, nitrogen or sulfur. They may also carry substituents. Naphthalene, with two benzene-like rings fused together, represents a typical example in this class (Fig. 1, b). More complex polycyclic compounds such as anthracene, benzo[a]pyrene and coronene (Fig. 1, b) are also well known.

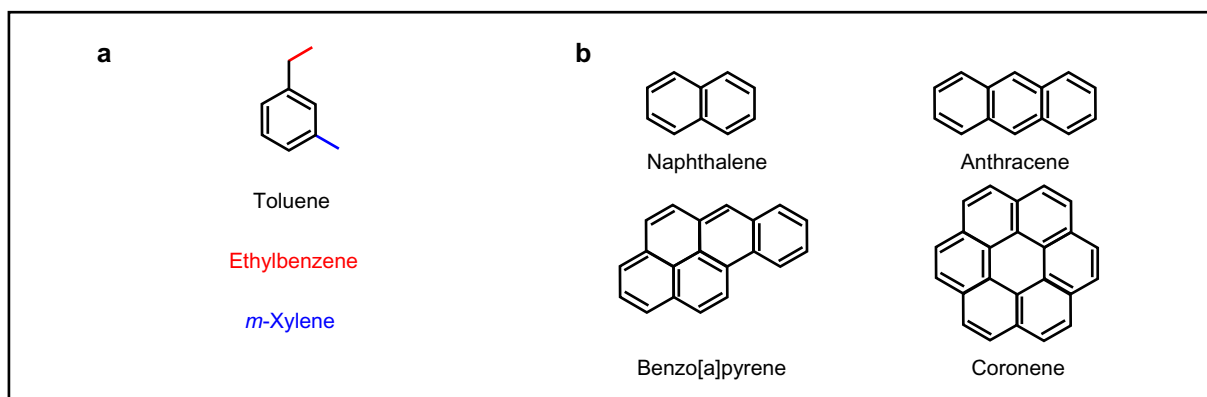

Fig. 1: Chemical structures of (a) monocyclic and (b) polycyclic aromatic hydrocarbons.

## A. 1. 2. Sources

Sources of aromatic compounds can be biological, geologic or anthropogenic. Aromatic compounds of biological origin are mostly derived from plant metabolism (e.g. lignin and tannins) (Boll, 2005; Young, 1985) and the three aromatic amino acids (phenylalanine, tyrosine, or tryptophane). Aromatic compounds can be also formed by prokaryotes, for instance, formation of toluene during fermentation of phenylalanine by *Tolumonas auensis* in anoxic fresh water systems (Jüttner and Henatsch, 1986; Fischer-Romero et al., 1996) or formation of *p*-cymene (*p*-isopropyltoluene) from monoterpenes under methanogenic conditions (Harder and Foss, 1999). In contrast, aromatic compounds of geologic origin are mostly hydrocarbons because they are the thermodynamically most stable structures. The major geologic source of aromatic hydrocarbons is crude oil, where they amount up to 30% (Tissot and Welte, 1984). Aromatic hydrocarbons can also be chemically produced from coal and during oil refining. Coal contains large variety of unsaturated benzene-like compounds. When heated to 1000°C in the absence of air, thermal breakdown of coal constituents occurs and a mixture of volatile products (coal tar) distills off. Further fractional distillation of coal tar yields benzene, toluene, ethylbenzene, xylenes and a host of other aromatic compounds. During refining, aromatic hydrocarbons are also formed when alkanes are passed over a catalyst at about 500°C under high pressure. Heptane (C<sub>7</sub>H<sub>16</sub>), for example, is converted into toluene (C<sub>7</sub>H<sub>8</sub>) by dehydrogenation and cyclization (McMurry, 1992).

Wide variety of aromatic compounds is extensively used and produced in industry for the production of, e.g. solvents, pesticides and polymers (Maier et al., 1999; Young, 1985). They are also released as waste products of incomplete combustion for heat and power generation purposes (Samanta et al., 2002).

## A. 1. 3. Toxicity

Many aromatic compounds can pose toxic cellular effects on prokaryotes as well as eukaryotes (Maier et al., 1999; Young, 1985). Membrane toxicity (Sikkema, 1995) and genotoxicity (Dean, 1978) are the most pronounced cellular effects. Membrane-directed toxicity is evident for lipophilic aromatic compounds which have *n*-octanol:water partition coefficient ( $K_{ow}$ ) of more than 1.5 (Kühner, unpublished; Jackson and de Moss, 1965). These compounds tend to accumulate into the lipophilic layer of the cell membrane disturbing its integrity (Sikkema, 1995). Such disturbed membrane integrity has been assayed by the loss of <sup>14</sup>C-labeled photosynthates

from algal cells (Maier et al., 1999) or by the leakage of ions, ATP and even nucleic acids and proteins from bacteria (Jackson and de Moss, 1965). Examples of lipophilic aromatic hydrocarbons and some of their chemical/physical properties are listed in Table 1. Several aromatic compounds can also pose mutagenic effects due to covalent binding to nucleic acids, mainly DNA (Allen and Coombs, 1980). Additionally, irritation, redness and a burning sensation results from contact with skin and eye are also well recognized health effects in humans (U.S. Public Health Service, 1989).

Tab. 1: Partition coefficients and other chemical/physical properties of potentially membrane-toxic aromatic compounds.

Aromatic compound	Formula	Molecular weight (g/mol)	Water solubility (g/l) <sup>a</sup>	Octanol-water partition coefficient (K <sub>ow</sub> ) <sup>b</sup>
Benzene	C <sub>6</sub> H <sub>6</sub>	78.11	1.78	2.13
Toluene	C <sub>6</sub> H <sub>5</sub> CH <sub>3</sub>	92.13	0.52	2.69
<i>p</i> -Cresol	C <sub>6</sub> H <sub>4</sub> CH <sub>3</sub> OH	108.14	20.0	1.94

<sup>a</sup>(Mackay and Shiu, 1981)

<sup>b</sup>(Yaffe et al., 2002)

## A. 2. Aerobic catabolism of aromatic compounds

Even though animals and plants are able to modify aromatic ring structures and to degrade a limited number of aromatic compounds, they do not contribute to a large extent to the mineralization of aromatic compounds (Heider and Fuchs, 1997). Microorganisms, particularly fungi (Hammel, 1995) and bacteria (Rosenberg, 2004; Wackett and Hershberger, 2001) can completely degrade aromatic structures to gain energy and carbon. The challenge to aromatic catabolism, however, is the stable aromatic ring structure which must be activated and subsequently dearomatized. The open ring can then be further degraded to compounds that can enter the TCA cycle. In presence of air, cells can use the highly reactive oxygen species (derived from O<sub>2</sub>) via mono- or di-oxygenase-catalyzed reactions to overcome the resonance stability of the ring structure (Hedegaard and Gunsalus, 1965; Gibson et al., 1970; Wackett and Hershberger, 2001). Aerobic catabolism of toluene via a toluene-*cis*-1,2-dihydrodiol intermediate to the level

of acetyl-CoA in *Pseudomonas putida* F1 is shown in Figure 2 as an example for aerobic aromatic compound degradation. Although two reduced pyridine nucleotides (NADH+H<sup>+</sup>) are invested for activation of the aromatic ring to methylcatechol, a substantial energy is still available in oxidizing the compound to 7 mol of CO<sub>2</sub>.

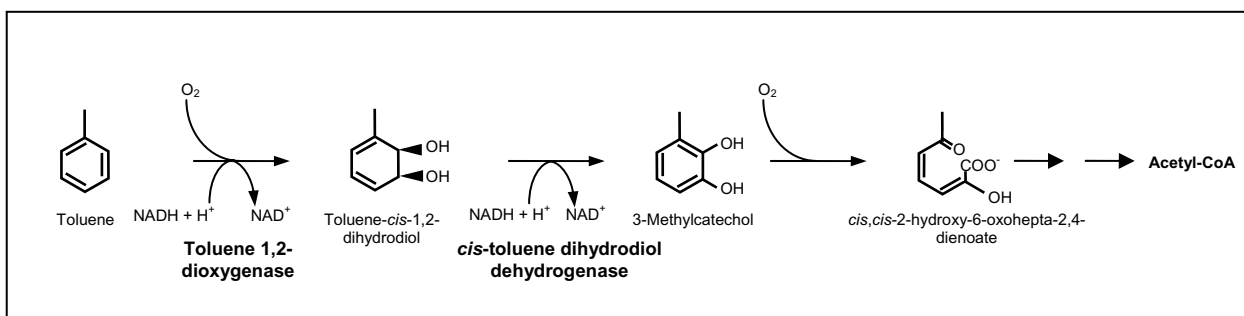

Fig. 2: Aerobic toluene catabolism to the level of methylcatechol via toluene-*cis*-1,2-dihydrodiol (Lau et al., 1994)

### A. 3. Anaerobic catabolism of aromatic compounds

#### A. 3. 1. Microorganisms

It is now well established that aromatic compounds are also readily metabolized aerobically. More importantly, various microorganisms with the ability to anaerobically degrade aromatic compounds were isolated enabling more detailed physiological, biochemical and molecular studies. The majority of isolated microorganisms are bacterial strains that can utilize monocyclic aromatic compounds. They belong to groups of denitrifying bacteria (e.g. Dolfing et al., 1990; Evans et al., 1991; Anders et al., 1995; Rabus and Widdel, 1995; Song et al., 1999), sulfate-reducing bacteria (Widdel et al., 1983; Imhoff-Stuckle and Pfennig, 1983; Bak and Widdel, 1986a; Bak and Widdel, 1986b; Szewzyk and Pfennig, 1987; Schnell et al., 1989; Drzyzga et al., 1993; Kuever et al., 1993; Rabus et al., 1993; Beller et al., 1996; Reichenbecher and Schink B, 1997; Harms et al., 1999; Kniemeyer et al., 2003), iron(III)-reducing bacteria (Lovley et al., 1989), phototrophic bacteria (Zengler et al., 1999) and syntrophic bacteria (Meckenstock, 1999). Few strains with the capacity to degrade polycyclic aromatic hydrocarbon compounds such as naphthalene have also been isolated (Galushko et al., 1999; Rockne et al., 2000). Examples of isolates from the group of sulfate-reducing bacteria are presented in Table 2.

Tab. 2: Pure cultures of sulfate-reducing bacteria capable of anaerobic degradation of aromatic compounds.

Microorganism	Aromatic growth substrate	Reference
Aromatic hydrocarbons		
<i>Desulfobacula toluolica</i> strain Tol2	Toluene, benzoate, phenylacetate, <i>p</i> -cresol, <i>p</i> -hydroxybenzoate, <i>p</i> -hydroxybenzaldehyde	Rabus et al., 1993
PROTL1	Toluene	Beller et al., 1996
oXyS1	<i>o</i> -Xylene, toluene, <i>o</i> -ethyltoluene, <i>o</i> -methylbenzyl alcohol, benzoate, <i>o</i> -methylbenzoate, benzylsuccinate	Harms et al., 1999
mXyS1	<i>m</i> -Xylene, toluene, <i>m</i> -ethyltoluene, <i>m</i> -Isopropyltoluene, benzoate, <i>m</i> -methylbenzoate	Harms et al., 1999
NaphS2	Naphthalene, 2-naphthoate, benzoate	Galushko et al., 1999
EbS7	Ethylbenzene, phenylacetate	Kniemeyer et al., 2003
Non-hydrocarbon aromatic compounds		
<i>Desulfonema magnum</i>	Benzoate, <i>p</i> -hydroxybenzoate, phenylacetate, <i>m</i> -phenylpropionate, hippurate,	Widdel et al., 1983
<i>Desulfococcus niacini</i>	Nicotinic acid, <i>o</i> -phenylpropionate	Imhoff-Stuckle and Pfennig, 1983
<i>Desulfobacterium indolicum</i>	Indole, 2-aminobenzoate	Bak and Widdel, 1986a
<i>Desulfobacterium phenolicum</i>	Phenol, <i>p</i> -cresol, benzoate, phenylacetate, indole, <i>p</i> -hydroxyphenylacetate, 2-aminobenzoate, protocatechuate, phloroglucinol, pyrogallol	Bak and Widdel, 1986b
<i>Desulfobacterium catecholicum</i>	Catechol, resorcinol, <i>p</i> -hydroxybenzoate, hydroquinone, benzoate, 2-aminobenzoate, protocatechuate, phloroglucinol, pyrogallol	Szewzyk and Pfennig, 1987
<i>Desulfobacterium anilini</i>	Aniline, 2-aminobenzoate, 4-aminobenzoate, indolylacetate, quinoline	Schnell et al., 1989
strain Cat2	Phenol, catechol, <i>m</i> -cresol, <i>p</i> -cresol, benzoate, phenylacetate, phenylpropionate, <i>p</i> -hydroxybenzoate, 3,4- dihydroxybenzoate, phenylalanine	Schnell et al., 1989
strain SAX	Benzoate, <i>p</i> -hydroxybenzoate, phenol, phenylacetate, phenylalanine	Drzyzga et al., 1993
<i>Desulfotomaculum</i> strain Groll	Catechol, phenol, <i>m</i> -cresol, <i>p</i> -cresol, benzoate, <i>m</i> -hydroxybenzoate, benzaldehyde, benzyl alcohol, phenylacetate, phenylpropionate	Kuever et al., 1993
<i>Desulfovibrio inopinatus</i>	Hydroxyhydroquinone (1,2,4-trihydroxybenzene)	Reichenbecher and Schink, 1997

### A. 3. 2. Degradation pathways

Under anoxic conditions, molecular oxygen is not available, necessitating novel reactions for catabolism of aromatic compounds. Enzymes and pathways for anaerobic aromatic compound catabolism have been most intensively studied in members from a distinct group of denitrifying betaproteobacteria, including *Thauera aromatica* (e.g. Leuthner et al., 1998) and *Azoarcus*-related species (e.g. Rabus and Heider, 1998). In denitrifiers, the huge variety of aromatic compounds is usually first transformed via peripheral reactions to the common intermediate benzoyl-CoA (Rabus et al., 2004, Boll et al., 2002). Benzoyl-CoA, in turn, is reductively dearomatized to a cyclic diene derivative by ATP-consuming benzoyl-CoA reductase (Boll and Fuchs, 1995). After subsequent hydrolytic cleavage of the ring structure, a  $\beta$ -oxidation-like reaction sequence yields acetyl-CoA units, which are completely oxidized to CO<sub>2</sub> via TCA-cycle. As example, the catabolic pathways of toluene to the level of benzoyl-CoA and of the latter to the level of acetyl-CoA are shown in Figures 3 and 4, respectively.

Whether the low energy yield of sulfate reducing bacteria could support the same enzymology for abolishment of the aromaticity of benzoyl-CoA has been questioned. In studies with *Desulfococcus multivorans*, initial evidence was obtained that key reactions of aromatic metabolism differ in sulfate reducers and denitrifiers (Peters et al., 2004; Wischgoll et al., 2005). The reactions have yet to be demonstrated.

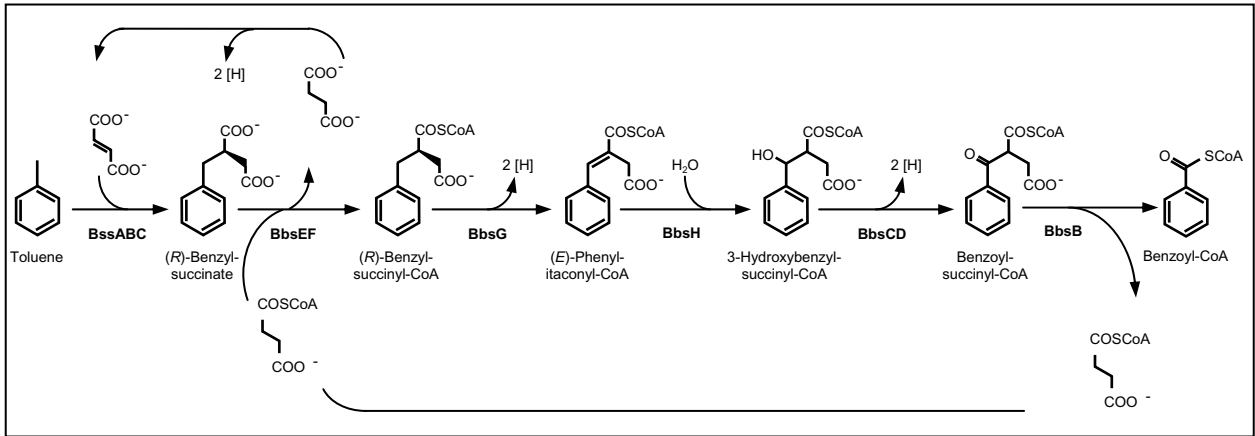

Fig. 3: Anaerobic degradation of toluene to the level of benzoyl-CoA in denitrifying strains K172 and EbN1. Enzyme abbreviations: BssABC, benzylsuccinate synthase; BbsEF, succinyl-CoA:benzylsuccinate CoA-transferase; BbsG, benzylsuccinyl-CoA dehydrogenase; BbsH, phenylitaconyl-CoA hydratase; BbsCD, 3-hydroxyacyl-CoA dehydrogenase; and BbsB, benzylsuccinyl-CoA thiolase (Kube et al., 2004).

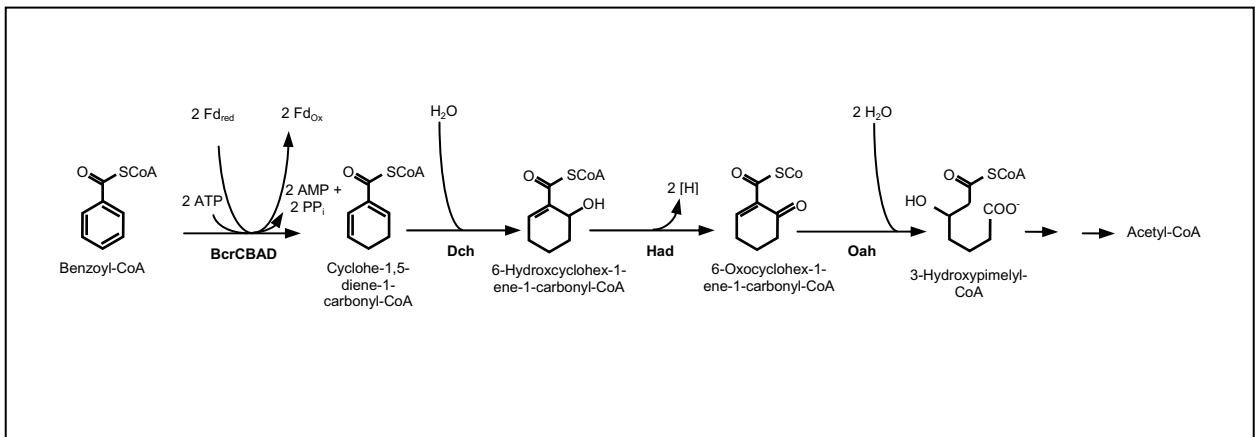

Fig. 4: Anaerobic degradation of benzoyl-CoA to the level of acetyl-CoA in denitrifying strain EbN1 and *A.evansii*. Enzyme abbreviations: BclA, benzoate CoA-ligase; BcrCBAD, benzoyl-CoA reductase; Dch, cyclohexa-1,5-diene-1-carbonyl-CoA hydratase; Had, 6-hydroxycyclohex-1-ene-1-carbonyl-CoA dehydrogenase; and Oah, 6-oxocyclohex-1-ene-1-carbonyl-CoA hydrolase (Rabus et al., 2005).



#### A. 4. Dissimilatory sulfate reduction

The ability to use sulfate ( $\text{SO}_4^{2-}$ , oxidation state + VI) as an electron acceptor for energy conserving processes is restricted to which are termed sulfate-reducing bacteria and sulfate-reducing archaea. Several other inorganic sulfur compounds may also serve as electron acceptors for sulfate reducers, for instance, sulfite ( $\text{SO}_3^{2-}$ , oxidation state + IV) and thiosulfate ( $\text{S}_2\text{O}_3^{2-}$ , oxidation state +II [average per sulfur atom]). The reduction of sulfate to sulfide ( $\text{H}_2\text{S}$ , oxidation states -II), an eight-electron reduction, proceeds through a number of intermediates. The sulfate ion with its oxygen tetrahedral arrangement is stable and cannot be reduced without first being activated. Sulfate is activated by ATP and the enzyme ATP sulfurylase catalyzes the attachment of the sulfate ion to a phosphate of ATP leading to the formation of adenosine-5'-phosphosulfate (APS) (Rabus et al., 2004). The sulfate moiety in APS is reduced to sulfite ( $\text{SO}_3^{2-}$ ) by the enzyme APS reductase with the release of AMP (Fig. 5). APS reductases are non-heme iron sulfur flavoproteins (Rabus et al., 2004). The purified enzymes from *Desulfovibrio desulfuricans* and *Desulfovibrio vulgaris* have heterodimeric structure ( $\alpha\beta$ ) and a total molecular mass being 95 kDa. The  $\alpha$ -subunit is proposed to carry one flavin adenine dinucleotide (FAD) molecule and the  $\beta$ -subunit to contain two [4Fe-4S] centers (Fritz, 1999).

Sulfite or its protonated form bisulfite ( $\text{HSO}_3^{2-}$ ), which are approximately equally abundant at pH 7,0 are much more reactive than sulfate (Rabus et al., 2004). The reduction of sulfite to sulfide by sulfite reductase involves the transfer of six electrons. Dissimilatory sulfite reductases generally have tetrameric composition ( $\alpha_2\beta_2$ ). However, a third type of subunit  $\gamma$  has been observed in *Desulfovibrio vulgaris* suggesting a hexameric structure ( $\alpha_2\beta_2\gamma_2$ ). The molecular mass of dissimilatory sulfite reductases ranges between 145 and 225 kDa (Rabus et al., 2004). Two different pathways for the reduction of sulfite to sulfide were discussed in literature: (i) direct reduction with six electrons without the formation of intermediates, (ii) trithionate pathway; the reduction via three consecutive two-electron steps with the formation of trithionate and thiosulfate as intermediates (Fig. 6). In the latter scenario, three reductases are involved: (bi)sulfite reductase, trithionate reductase and thiosulfate reductase (Thauer et al., 1977).

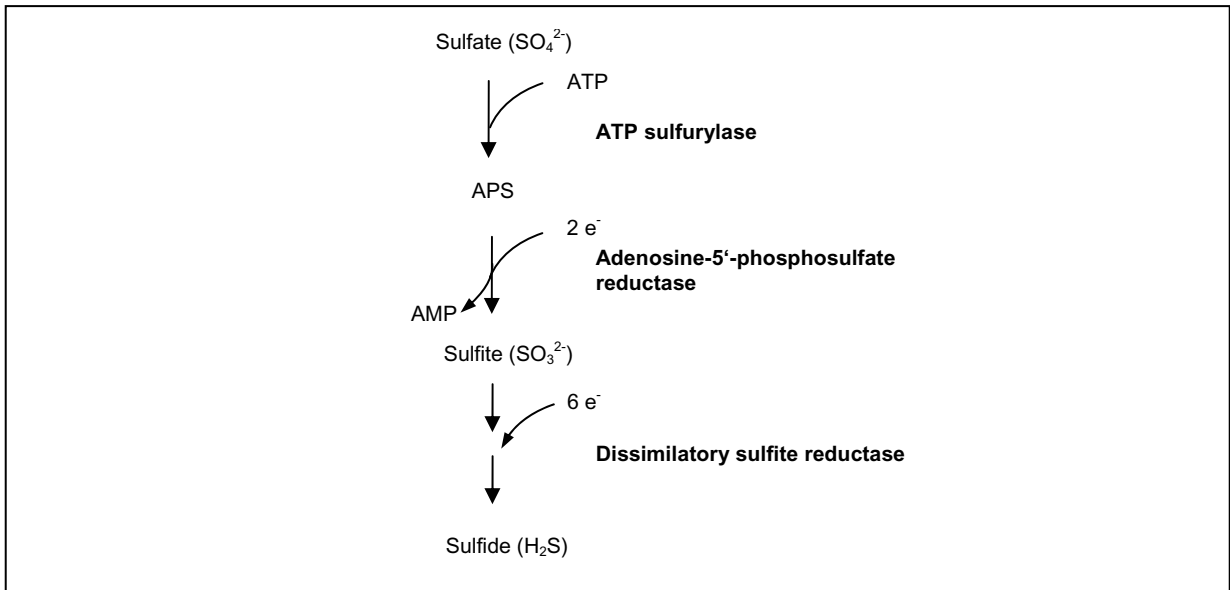

Fig. 5: Dissimilatory sulfate reduction pathway (Rabus et al., 2004).

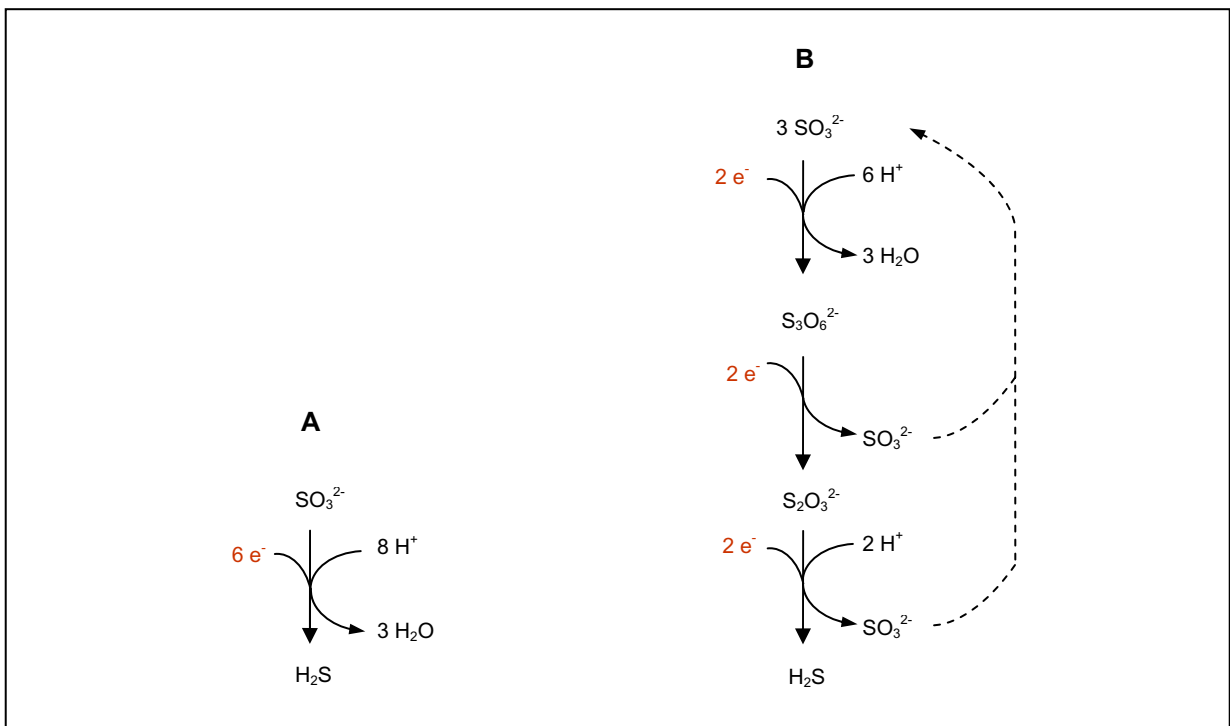

Fig. 6: Possible pathways of sulfite reduction to sulfide: (A) Direct reduction with six electrons without the formation of intermediates, (B) trithionate pathway where the reduction occurs via three consecutive two-electron steps with the formation of tetrathionate and trithionate as intermediates (Rabus et al., 2004).

## A. 5. *Desulfobacula toluolica* Tol2

*Desulfobacula toluolica* Tol2 (Rabus et al., 1993) was isolated from marine sediment and represented the first pure culture of a toluene-degrading sulfate-reducing bacterium. *D. toluolica* Tol2 belongs to *Deltaproteobacteria*. Based on 16S rRNA analysis, the strain is related to the metabolically dissimilar genera *Desulfobacter* and *Desulfobacterium* (Fig. 7). The strain grows optimally at pH 7,0 – 7,1 and 25°C. Organic aromatic substrates supporting anaerobic growth include toluene, benzoate, phenylacetate, *p*-cresol, *p*-hydroxybenzaldehyde and *p*-hydroxybenzoate. Organic non-aromatic growth substrates include glutarate, pyruvate, succinate, fumarate, malate, butyrate, ethanol, 1-propanol and 1-butanol. The strain completely oxidizes toluene to CO<sub>2</sub> via C<sub>1</sub>/CO dehydrogenase pathway, as indicated by the activity of carbon monoxide dehydrogenase and formate dehydrogenase (Rabus et al., 1993).

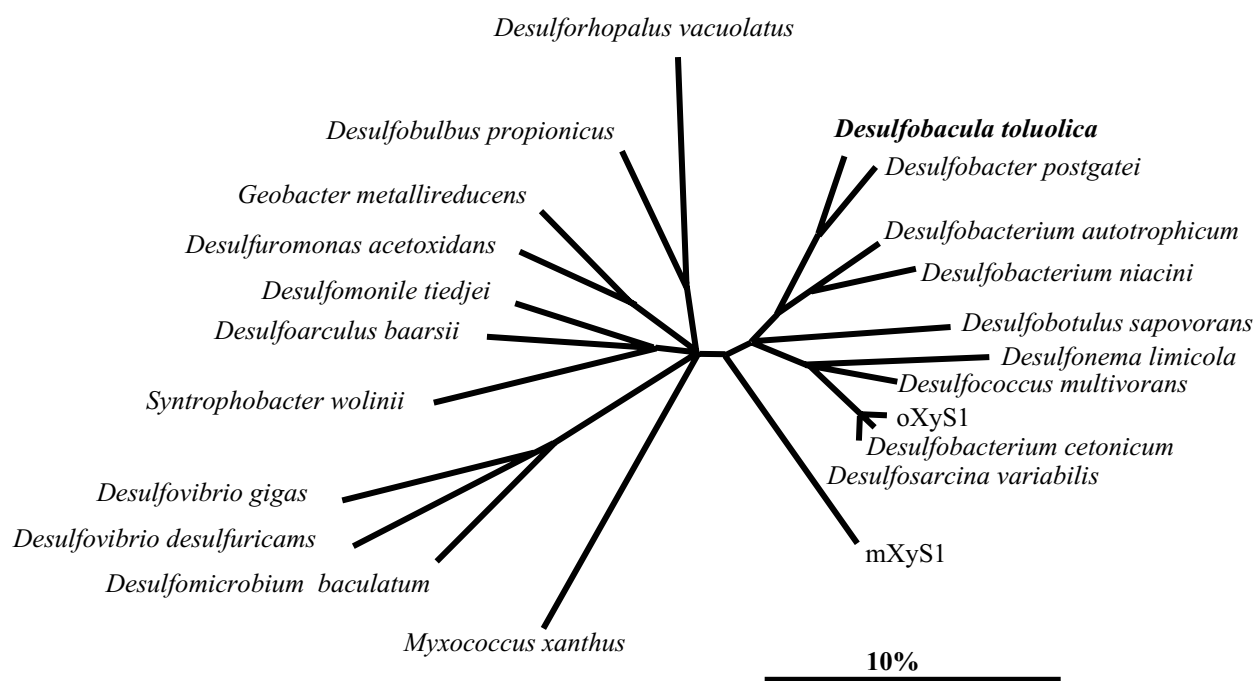

Fig. 7: 16S rRNA-based phylogenetic tree reflecting the relationships of some members of *Deltaproteobacteria* based on maximum-parsimony analysis. The tree also reflects the relationships of *Desulfobacula toluolica* Tol2 to other aromatic hydrocarbon degraders (*D. cetonicum*, strains oXyS1 and mXyS1). The bar indicates estimated 10% sequence divergence (tree source: Harms et al., 1999).

## A. 6. Aims of the study

We focus in this study on the metabolic regulation of sulfate-reducing bacteria in response to the availability of and adaptation to aromatic growth substrate. For this purpose, a combined physiological/proteomic approach was applied to the study organism *Desulfobacula toluolica* Tol2. The study pursued the following lines of research:

- a) Catabolism of aromatic compounds in *D. toluolica* Tol2:
  - i) Substrate-specificity of regulation.
  - ii) Proteomic insights into the presence of degradation pathways known from denitrifiers or hints for alternative routes.
- b) Are terminal electron-accepting pathways constitutive or electron-acceptor inducible?
- c) Toluene-degradation in *D. toluolica* Tol2 was previously demonstrated to be initiated by fumarate-dependent formation of benzylsuccinate. The dissemination of this reaction principle was studied in other hydrocarbon-degrading (alkylbenzenes, 2-methylnaphthalene and naphthalene) sulfate-reducing bacteria.

## B Materials and methods

### B. 1. Chemicals, gases and source of bacterium

All chemicals used in this study were of analytical grade and obtained from GE Healthcare (Munich), AppliChem (Darmstadt), Fluka (Buchs, Switzerland), Merck (Darmstadt), Roth (Karlsruhe), Serva (Heidelberg) and Sigma-Aldrich (Steinheim).

Gases including N<sub>2</sub> (99.999%), CO<sub>2</sub> (99.995%), N<sub>2</sub>/CO<sub>2</sub> (90:10 [vol:vol]) were supplied by Messer-Griesheim (Osterholz-Scharmbeck).

*Desulfobacula toluolica*, strain Tol2 (Rabus et al., 1993) was originally enriched and isolated from anoxic, sulfide-rich marine sediment from Eel Pond, a seawater pond in Woods Hole, Mass. The strain is deposited in the Deutsche Sammlung von Mikroorganismen und Zellkulturen (DSMZ) under number DSM 7467, and has been subcultured in the laboratory since its isolation.

### B. 2. Cultivation techniques

Medium preparation and cultivation of *D. toluolica* Tol2 were carried out as described before by (Widdel and Bak, 1992; Rabus et al., 1993).

#### B. 2. 1. Medium composition and preparation

##### B. 2. 1. 1. Preparation of stock solutions

###### a) Trace element solution

Na <sub>2</sub> -EDTA	5200 mg
FeSO <sub>4</sub> .7H <sub>2</sub> O	2100 mg
H <sub>3</sub> BO <sub>3</sub>	30 mg
MnCl <sub>2</sub> .4H <sub>2</sub> O	100 mg
CoCl <sub>2</sub> .6H <sub>2</sub> O	190 mg
NiCl <sub>2</sub> .6H <sub>2</sub> O	24 mg
CuCl <sub>2</sub> .2H <sub>2</sub> O	2 mg
ZnSO <sub>4</sub> .7H <sub>2</sub> O	44 mg
Na <sub>2</sub> MoO <sub>4</sub> .2H <sub>2</sub> O	36 mg

H <sub>2</sub> O <sub>mp</sub>	1000 ml
--------------------------------	---------

Salts were dissolved in H<sub>2</sub>O<sub>mp</sub> (ca. 800 ml; H<sub>2</sub>O<sub>mp</sub>: deionized water). The pH was adjusted with NaOH to 6,5. The final volume of 1000 ml was adjusted by addition of H<sub>2</sub>O<sub>mp</sub>. The solution was filter-sterilized through nitrocellulose membrane (pore size, 0,2 µm) in sterile 50 ml bottles and stored at RT.

#### b) Selenite-Tungstate solution

NaOH	100.0 mg
Na <sub>2</sub> SeO <sub>3</sub> .5H <sub>2</sub> O	6.0 mg
Na <sub>2</sub> WO <sub>4</sub> .2H <sub>2</sub> O	8.0 mg
H <sub>2</sub> O <sub>mp</sub>	1000.0 ml

The solution was dispensed in portions in 50 ml bottles, autoclaved, and stored at RT.

#### c) Vitamin mixture

4-Aminobenzoic acid	4.0 mg
D(+)-Biotin	2.0 mg
Nicotinic acid	10.0 mg
Calcium-D(+)-pantothenate	5.0 mg
Pyridoxine dihydrochloride	15.0 mg
Folic acid	4.0 mg
Lipoic acid	1.5 mg
2-Mercaptoethanesulfonic acid, Sodium salt	25.0 mg
Na <sub>2</sub> HPO <sub>4</sub> /NaH <sub>2</sub> PO <sub>4</sub> , 25 mM, pH 7.1	100.0 ml

The mixture was filter-sterilized through nitrocellulose membrane (pore size, 0,2 µm) in sterile 50 ml bottles and stored at 4°C in dark.

#### d) Thiamine solution

Thiamine dihydrochloride	10.0 mg
Na <sub>2</sub> HPO <sub>4</sub> /H <sub>3</sub> PO <sub>4</sub> , 50 mM, pH 3,7	100.0 ml

The solution was filter-sterilized through nitrocellulose membrane (pore size, 0,2 µm) in sterile 50 ml bottles and stored at 4°C in dark.

#### e) Riboflavin solution

Acetic acid	0.1 ml
Riboflavin	2.5 mg
H <sub>2</sub> O <sub>mp</sub>	100.0 ml

The solution was filter-sterilized through nitrocellulose membrane (pore size, 0,2 µm) in sterile 50 ml bottles and stored at 4°C in dark.

#### f) Vitamin – B<sub>12</sub> – solution

Cyanocobalamine	5.0 mg
H <sub>2</sub> O <sub>mp</sub>	100.0 ml

The solution was filter-sterilized through nitrocellulose membrane (pore size, 0,2 µm) in sterile 50 ml bottles and stored at 4°C in dark.

#### g) Sodium bicarbonate solution

NaHCO <sub>3</sub>	84.0 g
H <sub>2</sub> O <sub>mp</sub>	1000.0 ml

The solution was dispensed in portions (30 and 60 ml in serum bottles) leaving approximately  $\frac{1}{3}$  of the bottle volume as gas head space. The head space was exchanged with CO<sub>2</sub> and the solution was saturated with CO<sub>2</sub> by repeated flushing and vigorous shaking. The solution portions were autoclaved and stored at room temperature.

#### h) Sodium sulfide solution

Na <sub>2</sub> S·9H <sub>2</sub> O	240.12 g
H <sub>2</sub> O <sub>mp</sub>	1000.00 ml

Crystals of Na<sub>2</sub>S·9H<sub>2</sub>O were washed on a plastic sieve by brief rinsing with H<sub>2</sub>O<sub>mp</sub>. The required weight of clean, colorless crystals was added to H<sub>2</sub>O<sub>mp</sub> under N<sub>2</sub> atmosphere. 30 ml of the solution were prepared and filled into 50 ml serum bottle. The head space was gassed with N<sub>2</sub>, and the bottles were stoppered under N<sub>2</sub>-atmosphere. The solution was autoclaved and stored at 4°C.

#### i) Resazurine solution

Resazurine	100.0 mg
H <sub>2</sub> O <sub>mp</sub>	100.0 ml

The solution was dispensed in 50 ml bottles, autoclaved and stored at RT.

### 2. 1. 2. Preparation of mineral medium

#### Salt solution

KH <sub>2</sub> PO <sub>4</sub>	0.20 g
NH <sub>4</sub> Cl	0.30 g
NaCl	20.00 g
MgCl <sub>2</sub> ·6H <sub>2</sub> O	3.00 g
KCl	0.50 g
CaCl <sub>2</sub> ·2H <sub>2</sub> O	0.15 g
H <sub>2</sub> O <sub>mp</sub>	1000.00 ml

Na<sub>2</sub>SO<sub>4</sub> (4,0 g) was added to salt solution when the medium was prepared for cultivation with different organic substrates, otherwise the electron acceptor was added separately before inoculation. Salts were then dissolved and filled into a Widdel flask (1 l- or 2 l-size) or 5 l-volume bottles. After autoclaving with the medium still at 85°C, the head space was exchanged with N<sub>2</sub>.



After cooling down to RT, 1 ml of each of the following solutions was added to 1 l of medium under a constant stream of N<sub>2</sub>:

Trace element solution  
Selenite-Tungstate solution  
Vitamin mixture  
Thiamine solution  
Riboflavin solution  
Vitamin – B<sub>12</sub> – Solution

In addition, 1 ml of resazurine was added as redox indicator. The head space was then changed to N<sub>2</sub>/CO<sub>2</sub> (90:10 [vol:vol]) and 30 ml of sodium bicarbonate were added. Traces of dithionite were added until the medium turned colorless. When the medium was prepared for cultivation with different electron acceptors, resazurine and dithionite were not included. The pH of the medium was adjusted to pH 7,0 with 2 M HCL. Finally, 1 ml of sodium sulfide solution was added by means of N<sub>2</sub>-flushed sterile syringe. The medium was dispensed, via glass dispenser into 50 ml bottles. Completely filled bottles were stored at 4°C until use for cultivation. Other batches of medium were dispensed in either 100 ml flat bottles (containing 80 ml medium) or 500 ml flat bottles (containing 400 ml medium). In each case, the head space was gassed with N<sub>2</sub>/CO<sub>2</sub> (90:10 [vol:vol]) and the bottles were tightly sealed with rubber stoppers.

### B. 2. 1. 3. Organic substrates and electron acceptors

Organic substrates and electron acceptors used for cultivation are listed in Table 3. Toluene was filter-sterilized through solvent-resistant cellulose membrane (pore size, 0,2 µm) and added as dilute solution (2%, vol:vol) in an inert sterile anoxic carrier phase (2,2,4,4,6,8,8-heptamethylnonane). This procedure allowed supplying sufficient amounts of toluene of non-toxic concentration in the medium. Stocks of toluene-containing heptamethylnonane were stored aseptically under a N<sub>2</sub>-atmosphere. Poorly soluble *p*-hydroxybenzaldehyde was added from filter-sterilized solution in 2-propanol. The solution was filter-sterilized through nitrocellulose membrane (pore size, 0,2 µm) and added as pure solution. 2-propanol does not serve as growth substrate for *D. toluolica* Tol2. Benzoate, phenylacetate, *p*-cresol, *p*-hydroxybenzoate, fumarate, sulfate, sulfite and thiosulfate were added from filter-sterilized aqueous solutions. The final concentrations of used organic substrates and electron acceptors are listed in Table 3.

Tab. 3: Organic growth substrates, electron-acceptors and their concentrations used for cultivation of *D. toluolica* Tol2. Numbers in brackets represents the number of addition increments.

	Concentration of stock solution	Final concentration in the medium
<b>Organic substrates</b>		
<b>Aromatic hydrocarbon</b>		
Toluene	2% (vol:vol) in carrier phase	0.6 mM
<b>Non-hydrocarbon aromatic compounds</b>		
Benzoate	1 M	mM
Phenylacetate	0.5 M	(4) x 0.20 mM <sup>a</sup>
<i>p</i> -Hydroxybenzoate	1 M	(4) x 0.25 mM <sup>a</sup>
<i>p</i> -Hydroxybenzaldehyde	0.1 M	(6) x 0.10 mM <sup>a</sup>
<i>p</i> -Cresol	0.1 M	(6) x 0.15 mM <sup>b</sup>
<b>Aliphatic carboxylic acid</b>		
Fumarate	1 M	10 mM
<b>Electron acceptors</b>		
Sulfate	1mM	5 mM
Sulfite	1mM	5 mM <sup>c</sup>
Thiosulfate	1mM	15 mM [5 mM of each of
Electron acceptor mixture		sulfate, sulfite and thiosulfate] <sup>d</sup>

<sup>a</sup> Increments were added every ~24 h.

<sup>b</sup> Increments were added every ~12 h.

<sup>c</sup> 10, 7 and 5 mM sulfite were tested for growth, only 5 mM allowed growth.

<sup>d</sup> Electron acceptors were added from separate stock solutions directly to the medium.

## B. 2. 2. Cultivation

### B. 2. 2. 1. Physiological adaptations

*D. toluolica* Tol2 was adapted to different organic substrates utilizing sulfate as electron acceptor or different electron-acceptor states utilizing benzoate as organic substrate. In both cases, cells were transferred for at least 5 passages to allow adaptation to the respective adaptation conditions. In case of adaptation to different organic-substrates, cultivation was carried out in 20 ml glass tubes (toluene, benzoate and fumarate) or 100 ml flasks (phenylacetate, *p*-cresol, *p*-hydroxybenzaldehyde and *p*-hydroxybenzoate). In case of adaptation to different electron acceptors, cultivation was carried out in 20 ml glass tubes. Glass tubes were filled with 15 ml medium according to Hungate-technique (Bryant, 1972) leaving approximately  $\frac{1}{3}$  of the tube volume as gas head space. After addition of substrates and electron acceptors, the head space was changed to a N<sub>2</sub>/CO<sub>2</sub> (90:10 [vol:vol])-atmosphere. Tubes were sealed with butyl stoppers, and fixed with plastic screw caps. The media were inoculated with 5% (vol:vol) pre-culture by means of N<sub>2</sub>/CO<sub>2</sub> (90:10 [vol:vol]) gassed sterile syringes. Culture tubes and flasks were incubated vertically and shaken every day briefly. Toluene-amended culture tubes and flasks were incubated at an angle slightly inclined from the horizontal on a rotary shaker at low speed of 55 rpm to guarantee the optimal supply with toluene; contact of the carrier phase with the stoppers was avoided. Incubation occurred at 28°C in dark. Cultures were routinely controlled by optical density measurements and microscopic examination (Axioscope; Zeiss). Optical densities of cultures in tubes were measured directly at 660 nm using (Schimadzu TUBE UV) spectrophotometer, whereas optical densities of culture flasks were measured after retrieving 1 ml by a N<sub>2</sub>-flushed syringe in plastic cuvettes (Brand, Wertheim) using UV- VIS spectrophotometer (UV-1240; Shimadzu, Sehnle). The same volume had to be replaced by N<sub>2</sub>/CO<sub>2</sub> (90:10 [vol:vol]).

### B. 2. 2. 2. Monitoring growth

Growth was monitored primarily to determine corresponding time points for harvesting the mass cultures. Growth was monitored in 80 ml cultures (in 100 ml flat bottles) by measuring optical density changes and sulfide formation. Incubation and measurements of optical density were carried out as described above, whereas sulfide was quantified as described in section (B.3.1.). In

experiments of different electron-acceptor conditions, 1 ml culture medium (cells removed by filtration) was additionally retrieved and directly stored at -20°C until quantification of sulfate, sulfite and thiosulfate (section B.3.2).

### B. 2. 2. 3. Mass cultivation and cell harvesting

#### Washing buffer

Tris Base	12.1 g
MgCl <sub>2</sub>	14.7 g
H <sub>2</sub> O <sub>mp</sub>	1000.0 ml

The pH was adjusted by 2 M HCl to 7,5. The solution was stored at RT.

Mass cultivation was carried out in 5 l bottles containing 4 l medium. In case of toluene in the carrier phase, flat bottles (500 ml) containing 400 ml media were used.  $\frac{1}{5}$  of the volume was left as gas phase of N<sub>2</sub>/CO<sub>2</sub> (90:10 [vol:vol]). Addition of organic substrates, electron acceptors, and incubation were accomplished as described before. Mass cultures were harvested at half-maximum optical density. For harvesting, cultures were centrifuged (9000 rpm, 20 min, 4°C). Cultures containing carrier phase were separated using separation funnel and centrifuged as before. The resulting cell pellets were washed in 5 ml washing buffer and pooled. Additional 20 ml washing buffer were added and the cells were centrifuged (9000 rpm, 20 min, 4°C). The pellet was resuspended in 4 ml of washing buffer and aliquoted in 800 µl portions in 1.5 ml reaction cups. The cells were then centrifuged (1400 rpm, 15 min, 4°C), and the resulted pellets were weighed, directly frozen in liquid nitrogen, and stored at -80°C until cell breakage.

### B. 3. Analytical methods

#### B. 3. 1. Quantification of sulfide

Sulfide quantification was carried out as described before by others (Cline, 1969; Aeckersberg et al., 1991).

## Reagents

### Solution A: Zink acetate solution

$(\text{CH}_3\text{COO})_2\text{Zn}\cdot 2\text{H}_2\text{O}$	20.0 g
Acetic acid (100%)	1.0 ml
$\text{H}_2\text{O}_{\text{mp}}$	1000.0 ml

### Solution B: 0,2% dimethyl-*p*-phenylenediamine

$\text{H}_2\text{O}_{\text{mp}}$  (500 ml) was cooled in ice bath and 200 ml  $\text{H}_2\text{SO}_4$  were added under constant stirring. Then 2 g of dimethyl-*p*-phenylenediammonium chloride were added to the cold solution. The final volume was adjusted to 1000 ml and stored at 4°C in dark. Prior to use, this solution was diluted 1: 2.5 [stock solution :  $\text{H}_2\text{O}_{\text{mp}}$ ] generating the working solution. Contact with naked skin and eyes had to be avoided because of the acidity and potential carcinogenicity of the solution.

### Solution C:

$\text{Fe}_2(\text{SO}_4)_3\cdot 12\text{H}_2\text{O}$	10.0 g
$\text{H}_2\text{SO}_4$	2.0 ml
$\text{H}_2\text{O}_{\text{mp}}$	1000.0 ml

The solution was stored at RT. Prior to use, the solution was diluted 1: 50 (stock solution :  $\text{H}_2\text{O}_{\text{mp}}$ ) as working solution.

## Method

The assay was carried out in small glass test tubes, with the following components successively added:

Solution A	1.0 ml
Sample	10.0-20.0 $\mu\text{l}$
$\text{H}_2\text{O}_{\text{mp}}$	1.0 ml
Working Solution B	1.0 ml
Working Solution C	1.0 ml

Samples (1 ml) were retrieved from the growth cultures with N<sub>2</sub>-flushed, sterile plastic syringes. During sampling, 1 ml sterile N<sub>2</sub>/CO<sub>2</sub> (90:10 [vol:vol]) were added to cultures for each 1 ml sample retrieved, to maintain overpressure during incubation time. The small sample volumes (10-20 µl) applied in the assay were retrieved from the plastic syringes by deeply inserting N<sub>2</sub>-flushed Hamilton syringes. These samples were then added to solution A by placing the tip of the Hamilton syringe at the bottom of the test tube. This procedure allowed avoiding loss of sulfide due to evaporation. After addition of H<sub>2</sub>O<sub>mp</sub>, the reaction mixture was vigorously mixed twice. The other components were successively added and mixed as mentioned above. The reaction mixture was incubated at RT in the dark for 20 min. The absorbance was measured in plastic cuvettes at 670 nm using a UV- VIS spectrophotometer. A reaction mixture lacking sulfide served as reference blank. For each individual culture, sulfide was determined in triplicates.

A calibration curve was established for sulfide quantification. A diluted sulfide solution (about 10 mM) was generated by dilution of the 1 M stock solution in anoxic H<sub>2</sub>O<sub>mp</sub>. The exact concentration of the diluted sodium sulfide solution was determined titrimetrically as follows: under constant stirring, 7.5 ml of 0,1 N HCl and 2.5 ml of 0,1 N potassium iodate solution were mixed in a small-orifice bottle. Ten ml of the diluted sodium sulfide solution (about 10 mM) were immediately added to the mixture. The excess of iodine was titrated with sodium thiosulfate solution. A few drops of starch solution were added to indicate the presence of free iodine. Titration with sodium thiosulfate was then continued carefully until the blue color disappeared. The amount of iodine titrated with sodium thiosulfate was calculated (App. 1, equation 2). The amount of iodine that had reacted with sulfide was subsequently calculated (App. 1, equation 1). Ultimately, the amount of added sulfide and hence the exact concentration of sulfide solution was calculated. A concentration series (1, 2, 4, 6, 8, 12, 15 and 20 µmol/ml) of sulfide from the solution were prepared and the corresponding absorbance of each concentration was determined to establish the equilibration curve (App. 2).

### B. 3. 2. Quantification of sulfate, sulfite and thiosulfate

Measurements of sulfate, sulfite and thiosulfate were carried out by Volker Brüchert (Department of Biogeochemistry-MPI, Bremen). Sulfate concentration was determined by nonsuppressed anion chromatography and conductivity detection (Brüchert et al., 2001). Detection limit for the method is 10 µM with an analytical precision better than 5 µM.

Concentrations of sulfite and thiosulfate were determined by high-performance liquid chromatography and UV detection after derivatization with 2,2'-dithiobis (5-nitropyridine) (Valravamurthy and Mopper, 1990). Detection limits for thiosulfate and sulfite are about 0.06 and 0.08  $\mu\text{M}$ , respectively. The analytical precision is  $\pm 5\%$  in the 0.2 - 5  $\mu\text{M}$  range.

## B. 4. Proteomic methods

SDS-PAGE and 1D DIGE analyses were initially carried out to study anaerobic activation of toluene and *p*-cresol in *D. toluolica* Tol2. Other sulfate-reducing bacteria capable of degrading alkylbenzenes, 2-methylnaphthalene and naphthalene were included in the 1DE-based analyses to study the initial steps for degradation of these compounds. The strains were: oXyS1 and mXyS1, described originally by Harms et al. (1999) and subcultured in the lab since their isolation. Growth monitoring, mass cultures and cell harvesting of both strains was carried out by Mohammad Al-najjar during his laboratory training in our lab. *Desulfosarcina cetonica* strain 480 (Galushko and Rozanova, 1991), NaphS2 (Galushko et al., 1999) and the enrichment culture RS2MN (Galushko et al., 2003) were obtained as cell pellets from Alexander Galushko (MPI-Bremen). NaphS3 and NaphS6 were obtained as cell pellets from Florine Musat (MPI-Bremen).

### B. 4. 1. Cell breakage and protein extraction

#### B. 4. 1. 1. Protein extraction for SDS-PAGE

##### SDS-PAGE cell lysis buffer

1 M Tris/HCl (pH 7,5)	10.0 ml
10 mM MgCl <sub>2</sub>	20.0 ml
Glycerin	12.8 g
DTT	7.5 g

The solution was aliquoted (1 ml) in 1.5 ml reaction cups and stored at  $-80^{\circ}$ .

Cell pellets were resuspended in 1ml SDS-PAGE cell lysis buffer. Cells in a pellet were broken using the PlusOne sample grinding kit (GE Healthcare, Munich) following the instructions of the

manufacturer. Cell debris, DNA and membranes were removed by ultracentrifugation (75000 rpm, 1 h, 17°C; MAX-E Ultracentrifuge, Beckman Coulter; Krefeld). The resulting supernatant was homogenized by gentle pipetting and 30 µl were transferred to a 1.5 ml reaction cup for estimation of protein concentration (see B 4. 2). The protein solution was then aliquoted into half portions (approximately 500 µl) in 1.5 ml reaction cups and rapidly frozen in liquid nitrogen and stored at -80°C until protein estimation and SDS-PAGE.

#### B. 4. 1. 2. Protein extraction for two-dimensional gel electrophoresis

##### 2DE cell lysis buffer

Tris/HCl (1 mM)	3.00 ml
Thiourea	15.22 g
Urea	42.00 g
CHAPS	4.00 g

The pH was adjusted to 8,5 with 2 M HCl. Aliquotes were stored in 1.5 ml reaction cups at -80°.

Cell pellets were resuspended in 1ml of 2DE cell lysis buffer. Cells were broken and protein was extracted as described above (B 4.1.1).

#### B. 4. 2. Protein quantification

Protein content of the extracts was estimated photometrically as described by Bradford (1976). Protein extracts were diluted 1:100, 1:200, 1:5000, 1:10000 (vol:vol, protein extract:H<sub>2</sub>O<sub>mp</sub>) with a final volume of 800 µl. Bradford reagent (200 µl) was added to diluted extracts and the mixture was briefly but vigorously mixed. The mixture was then incubated in the dark at RT for 30 min. Contact with Bradford-containing solutions and mixtures had to be avoided because of its suspected carcinogenicity. The absorbance was measured at 595 nm using plastic cuvettes. A reaction mixture lacking proteins served as a reference. For each tested sample, protein quantification was based on triplicates. A calibration curve was determined with a dilution series (0, 1, 2, 4, 6, 8 and 10 µg) of bovine serum albumin (BSA). The calibration curve and its linear equation were determined for each extraction (App. 3).



### B. 4. 3. Fluorescence protein labeling

#### B. 4. 3. 1. One-dimensional difference gel electrophoresis

The pH of protein extracts was adjusted to 8.5. 50  $\mu\text{g}$  protein extract were labeled with 200 pmol fluorescence dye. Samples were vortexed and incubated on ice for 30 min in the dark. The reaction was stopped by adding 10 mM lysine. The samples were then vortexed and incubated for additional 10 min in the dark. Differential labeling of protein was carried out with extracts from *D. toluolica* Tol2 and other alkylbenzene-, methylnaphthalene- and naphthalene-degrading sulfate-reducing bacteria. The specified labeling under each substrate condition is listed in Table 4.

Tab. 4: Differential fluorescence labeling of proteins from alkylbenzene-, methyl-naphthalene- and naphthalene-degrading sulfate-reducing bacteria used for one-dimensional gel electrophoresis (1D DIGE). Three different states were included and differentially labelled in each experimental condition; test state, reference state and internal standard.

<b>Strain</b>	<b>Test state (Cy3-labeled)</b>	<b>Reference state (Cy5-labeled)</b>	<b>Internal standard (Cy2-labeled) Mixture of:</b>
<b><i>D. toluolica Tol2</i></b>	Toluene	Benzoate	Toluene + Benzoate
	<i>p</i> -Cresol	Benzoate	<i>p</i> -Cresol + Benzoate
<b>oXyS1</b>	<i>o</i> -Xylene	Benzoate	<i>o</i> -Xylene + Benzoate
	Toluene	Benzoate	Toluene + Benzoate
<b>mXyS1</b>	<i>m</i> -Xylene	Benzoate	<i>m</i> -Xylene + Benzoate
<b><i>Desulfosarcina cetonica 480</i></b>	Toluene	Benzoate	Toluene + Benzoate
<b>NaphS2</b>	2-Methylnaphthalene	Naphthalene	2-methylnaphthalene + Naphthalene
<b>NaphS3</b>	2-Methylnaphthalene	Naphthalene	2-methylnaphthalene + Naphthalene
<b>NaphS6</b>	2-Methylnaphthalene	Naphthalene	2-methylnaphthalene + Naphthalene

### B. 4. 3. 2. Two-dimensional difference gel electrophoresis

Differential labeling of protein extracts was carried out as mentioned in section 4.3.1. Two-dimensional difference gel electrophoresis (2D DIGE) was carried out only with extracts of *D. toluolica* Tol2. The differential labeling under various organic-substrate or electron-acceptor conditions is specified as follows:

#### 2D DIGE

##### a) Different organic-substrate conditions using sulfate as electron acceptor

<b>Test states (Cy3-labeled)</b>	<b>Reference state (Cy5-labeled)</b>	<b>Internal standard (Cy2-labeled) Mixture of:</b>
Benzoate Toluene Phenylacetate <i>p</i> -Cresol <i>p</i> -Hydroxybenzaldehyde <i>p</i> -Hydroxybenzoate	Fumarate	Benzoate Toluene Phenylacetate <i>p</i> -Cresol <i>p</i> -Hydroxybenzaldehyde <i>p</i> -Hydroxybenzoate

##### b) Different electron-acceptor conditions using benzoate as organic substrate

<b>Test states (Cy3-labeled)</b>	<b>Reference state (Cy5-labeled)</b>	<b>Internal standard (Cy2-labeled) Mixture of:</b>
Sulfite Thiosulfate Sulfate + Sulfite + Thiosulfate	Sulfate	Sulfite Thiosulfate Mixture Sulfate

## B. 4. 4. Gel electrophoresis

### B. 4. 4. 1. SDS-PAGE

#### a) Stock Solutions

##### i) Tris HCl/SDS, pH 6.8

Tris Base	6.05 g
SDS	0.40 g
H <sub>2</sub> O <sub>mp</sub>	100.00 ml

Tris Base (6,05 g) was dissolved in 40 ml H<sub>2</sub>O<sub>mp</sub>. The pH was adjusted to 6.8 using 1 and 10 N HCl. The volume was then adjusted to 100 ml and the solution was filter-sterilized through nitrocellulose membrane (pore size, 0,2 µm). SDS was added under stirring and the solution was stored at 4°C. Inhalation of SDS had to be prevented. The solution has a shelf life of one month.

##### ii) Slab gel buffer

Tris Base	130.8 g
Tris HCl	66.3 g
H <sub>2</sub> O <sub>mp</sub>	1000.0 ml

The solution was stored at 4°C.

##### iii) SDS solution

SDS	10.0 g
H <sub>2</sub> O <sub>mp</sub>	1000.0 ml

SDS was dissolved in heated water. The solution was filter-sterilized through nitrocellulose membrane (pore size, 0,2 µm) and stored at RT.

iv) APS solution

APS	0.5 g
H <sub>2</sub> O <sub>mp</sub>	5.0 ml

The solution had to be freshly prepared prior to use.

v) Stacking gel buffer

Tris Base	15.13 g
SDS	1.00 g
H <sub>2</sub> O <sub>mp</sub>	250.00 ml

The pH was adjusted to 6,8 using 1N HCl and the solution was stored at 4°C.

vi) SDS-PAGE sample loading buffer

Stacking gel buffer	7.00 ml
SDS	1.00 g
Glycerol	3.00 ml
DTT	0.60 ml
Bromophenol blue	0.93 mg
H <sub>2</sub> O <sub>mp</sub>	10.00 ml

The buffer was aliquoted in 1ml portions and stored at -80 until sample loading.

vii) Running buffer

Tris Base	30.28 g
Glycine	144.13 ml
SDS	10.00 g
H <sub>2</sub> O <sub>mp</sub>	1000.00 ml

The buffer was stored at RT.

viii) SDS-PAGE fixative

Ethanol (99%)	400.0 ml
H <sub>2</sub> SO <sub>4</sub> (85%)	16.0 ml
H <sub>2</sub> O <sub>mp</sub>	up to 800.0 ml

The fixative had to be freshly prepared for each new experiment.

ix) Coomassie (G250) stain

Methanol	340.00 ml
H <sub>3</sub> PO <sub>4</sub>	23.50 ml
(NH <sub>3</sub> ) <sub>2</sub> SO <sub>4</sub>	170.00 g
Coomassie (G250)	0.66 g
H <sub>2</sub> O <sub>mp</sub>	1000.00 ml

x) Destaining solution

Ethanol	400.0 ml
H <sub>2</sub> O <sub>mp</sub>	up to 2000.0 ml

xi) Gel-packing solution

Glycerol	10.0 ml
Ethanol	30.0 ml
H <sub>2</sub> O <sub>mp</sub>	up to 1000.0 ml

The solution had to be freshly prepared before use.

b) Stacking Gel

30% Acrylamide	10.40 ml
Tris HCl/SDS, pH 6,8	1.25 ml
H <sub>2</sub> O <sub>mp</sub>	3.08 ml
TEMED	3.00 µl
APS	30.00 µl

The components were successively added in a 50 ml plastic tube and gently mixed by inverting 3-5 times avoiding formation of bubbles.

### c) Resolving gel

30% Acrylamide	41.5 ml
Slab gel buffer	25.0 ml
H <sub>2</sub> O <sub>mp</sub>	32.5 ml
SDS	1.0 ml
TEMED	50.0 µl
APS	522.0 µl

The components were successively added in a 50 ml plastic tube and gently mixed by inverting 3-5 times avoiding formation of bubbles.

After the assembly of vertical gel electrophoresis chamber (Biorad, München), following the instructions of the manufacturer, the resolving gel was gently filled by means of a 5 ml-tipped pipette leaving enough space for the stacking gel. The resolving gel was covered with 5 ml H<sub>2</sub>O<sub>mp</sub>. After polymerization, H<sub>2</sub>O<sub>mp</sub> was replaced by the stacking gel and the combs were then inserted avoiding formation of bubbles. Protein extracts were diluted in SDS-PAGE sample loading buffer to final protein concentrations of 30 and 50 µg per 20 µl final volumes. Proteins were then denatured by heating at 100°C for 10 min. The samples were loaded onto the stacking gel. The electrophoresis was conducted using 1:10 diluted (in H<sub>2</sub>O<sub>mp</sub>) running buffer at 80 volts for about 16 hrs. Continuous cooling was achieved with a water circulation system (Haake-Omnilab, Mettmenstetter). After electrophoresis, the stacking gel was removed and the separating gel was incubated with 400 ml fixation buffer in a staining tray for 30 min under continuous shaking (20 rpm). The fixed gel was stained with 200 ml Coomassie (G250) stain for 1 h with shaking (20 rpm). Destaining with 400 ml destaining solution was conducted until the optimal visibility of bands with minimal background was achieved (approximately 4 h). The gels were then digitalized by scanning (Image scanner, GE Healthcare). The gels were stored at 4°C until manual band excision and then packed in cellophane sheets (GE Healthcare). For gel packing, the gel and the cellophane sheets were soaked in the gel-packing solution for 5 min, and wrapped between the cellophane sheets after the exclusion of air bubbles and air dried.

In case of 1D DIGE, gel polymer was prepared as mentioned before and filled between low fluorescent glass plates (GE Healthcare). Fluorescently labeled proteins were diluted in SDS-PAGE sample loading buffer to a final protein amount of 50 µg. Electrophoresis was conducted using 1:10 diluted (in H<sub>2</sub>O<sub>mp</sub>) running buffer at 30 W volts for about 16 hrs using Ettan-Dalt electrophoresis chamber (GE Healthcare) in the dark.

#### B. 4. 4. 2. Two-dimensional gel electrophoresis

##### a) Rehydration buffer

Urea	3.60 g
Thiourea	1.52 g
CHAPS	0.20 g
DTT	40.00 mg
H <sub>2</sub> O <sub>mp</sub>	10.00 ml
IPG buffer (correspondent to the pH gradient used)	50.00 µl

H<sub>2</sub>O<sub>mp</sub> (4.5 ml) was heated at 33°C in a small water bath. The components were then dissolved and the volume was adjusted to 10 ml H<sub>2</sub>O<sub>mp</sub> using a graduated cylinder. The buffer was filter-sterilized through nitrocellulose membrane (pore size, 0,2 µm). The buffer had to be freshly prepared and stored at RT.

##### b) DeStreak™ rehydration solution

DeStreak™ rehydration solution	3.0 ml
IPG buffer (correspondent to the pH gradient used)	15.0 µl

##### c) Resolving gel buffer

Tris Base	18.2 g
SDS	0.4 g
H <sub>2</sub> O <sub>mp</sub>	100.0 ml



Na-Azide	10.0 mg (if the buffer was used to prepare bromophenol blue solution)
----------	---

The salts were dissolved in 8 ml of H<sub>2</sub>O<sub>mp</sub> and the pH was adjusted to 8,8 using 4 N HCl. The volume was adjusted to 100 ml and filter-sterilized through nitrocellulose membrane (pore size, 0,2 µm) and stored at 4°C. The shelf life of the solution is two weeks.

#### d) Basal equilibration buffer

Urea	180.0 g
Glycerol	150.0 ml
SDS	10.0 g
Resolving gel buffer	16.7 ml
H <sub>2</sub> O <sub>mp</sub>	up to 500.0 ml

Glycerol was added to 150 ml heated H<sub>2</sub>O<sub>mp</sub> (33°C) and urea was then added in portions. The buffer was stored at RT. The shelf life of the solution is two weeks.

#### e) Agarose sealing solution

Agarose	0.5 g
Bromophenol blue	Few crystals
Gel running buffer	100.0 ml

The solution was heated in a microwave oven until dissolution of the components and aliquoted in 1.5 ml reaction tubes and stored at RT.

#### f) Bromophenol blue solution

Bromophenol blue	125.0 mg
Resolving gel buffer	50.0 ml

The solution was stored at 4°C.

### g) Equilibration buffer

#### (i) Equilibration buffer I

DTT	2.0 g
Bromophenol blue solution	1.0 ml
Basal equilibration buffer	200.0 ml

#### (ii) Equilibration Buffer II

Iodoacetamide	8.0 g
Bromophenol blue solution	1.0 ml
Basal equilibration buffer	200.0 ml

The equilibration buffers had to be freshly prepared.

### h) Gel polymer

30% Acrylamide	415.00 ml
Rhinohide™	83.00 ml (only with gels to be stained with silver nitrate or Coomassie, otherwise the volume was replaced by H <sub>2</sub> O <sub>mp</sub> )
Slab gel buffer	247.00 ml
H <sub>2</sub> O <sub>mp</sub>	242.00 ml
SDS	10.30 ml
TEMED	0.51 ml
APS	2.49 ml

The components were added successively under vacuum and with stirring.

## First dimension: Isoelectric focussing

Protein extracts were diluted in rehydration buffer (450  $\mu$ l total volume containing 50  $\mu$ g protein if the gels were stained with silver nitrate and 300  $\mu$ g if the gels were stained with Coomassie stain) or in DeStreak<sup>TM</sup> rehydration solution and then evenly loaded in the IPG-strip holder (GE Healthcare) avoiding bubble formation. A commercial 24-cm-long IPG-strip (pH gradients 4-7, 6-9, 7-11, 3-10, and non-linear pH gradient 3-10; GE Healthcare) was laid gel side facing down onto the sample and covered with 1.5 ml of mineral oil (GE Healthcare) and a plastic lid. Gel rehydration and entry of the protein sample into the gel were conducted simultaneously at 30 volts for 7 h, followed by 60 volts for 6 h. Then H<sub>2</sub>O<sub>mp</sub>-moistuarized filter papers (GE Healthcare) were placed between the strip gel and the electrodes to avoid a delayed diffusion of proteins from outside of the electrodes into the electrophoretic field. Electrophoresis was then continued across the following gradient: 200 volts for 1 h, 100 volts for 1h, 1000-8000 volts for 0.5 h and 8000 volts for 9 h. Isoelectric focusing was carried out in the dark in case of 2D DIGE.

## Second dimension: SDS-PAGE

Prior to SDS-PAGE, strips were briefly washed with H<sub>2</sub>O<sub>mp</sub> and equilibrated using the equilibration buffer I and II for 15 min each, in long test tubes with shaking (20 rpm), and washed again with H<sub>2</sub>O<sub>mp</sub>. Equilibration was required to change from the non-ionic first dimension to the SDS-conditions of the second dimension. Casting of the gels was performed as follows. Gel polymer was filled between parallel glass plates (GE Healthcare) and covered by 2 ml isobutanol. Low fluorescent glass plates (GE Healthcare) were used in case of 2D DIGE. After initial polymerization (2-3 h), the gels were covered with 0.1% SDS and polymerization was continued over night. Gels (12) were mounted in Ettan-Dalt electrophoresis chamber (GE Healthcare) containing 1:10 diluted (in H<sub>2</sub>O<sub>mp</sub>) running buffer. IPG strips were placed on the top of gels and fixed by overlaying with approximately 1ml of agarose sealing solution. Electrophoresis was conducted in two phases: 30 watt for 30 min (sample entry) and 180 watt for ca. 6 h (until bromophenol front reached the bottom of the gel). Electrophoresis was carried out in the dark for 2D DIGE gels.

## B. 4. 5. Gel visualization and documentation

### B. 4. 5. 1. Staining methods

#### a) Silver nitrate

##### (i) Fixation solution

Ethanol	500.0 ml
Acetic acid	100.0 ml
H <sub>2</sub> O <sub>mp</sub>	up to 1000.0 ml

The buffer had to be freshly prepared.

##### (ii) Incubation solution

Na-acetate	41.0 g
Na-thiosulfate	0.2 g
Ethanol	300.0 ml
H <sub>2</sub> O <sub>mp</sub>	up to 1000.0 ml

##### (iii) Silver nitrate staining solution

Silver nitrate	1.0 g
H <sub>2</sub> O <sub>mp</sub>	1000.0 ml

Contact with naked hands had to be avoided.

##### (iv) Flushing solution

Na <sub>2</sub> CO <sub>3</sub>	25.0 g
H <sub>2</sub> O <sub>mp</sub>	up to 1000.0 ml

(v) Developing solution

Na <sub>2</sub> CO <sub>3</sub>	25.00 g
Formalin	0.27 ml
NaHCO <sub>3</sub>	0.50 g
Thimerosal	0.20 g
H <sub>2</sub> O <sub>mp</sub>	up to 1000.00 ml

The solution had to be freshly prepared in a protective hood and contact with naked hands had to be avoided.

(vi) Stop solution

Na-EDTA	18.5 g
H <sub>2</sub> O <sub>mp</sub>	up to 1000.0 ml

After electrophoresis, the gels were fixed overnight with 400 ml fixation buffer in white plastic trays with shaking (20 rpm) and then incubated for 1 h in 400 ml incubation solution with shaking. The gels were washed twice in 400 ml H<sub>2</sub>O<sub>mp</sub> for 2 min each and then silver-stained by silver nitrate staining solution for 1h with shaking. The stained gels were briefly washed with H<sub>2</sub>O<sub>mp</sub> and flushed for 1 min by flushing solution. The protein spots were visualized by immersion in developing solution with shaking until the spots were clear and the background was minimal. At this point, the staining was stopped by addition of stop solution and washed in H<sub>2</sub>O<sub>mp</sub>, and gels were scanned and packed.

b) Coomassie G250

(i) Fixation solution

Methanol	500.0 ml
H <sub>3</sub> PO <sub>4</sub> (85%)	23.0 ml
H <sub>2</sub> O <sub>mp</sub>	up to 1000.0 ml

(ii) Incubation solution

(NH <sub>4</sub> ) <sub>2</sub> SO <sub>4</sub>	170.0 g
H <sub>3</sub> PO <sub>4</sub> (85%)	23.0 ml
Methanol	340.0 ml
H <sub>2</sub> O <sub>mp</sub>	up to 1000.0 ml

(iii) Coomassie G250 staining solution

Coomassie G250	264.0 mg
Incubation buffer	400.0 ml

The amount is added directly to the incubation solution after the incubation step. Contact with naked hands had to be avoided

(iv) Destaining solution

Methanol	250.0 ml
H <sub>2</sub> O <sub>mp</sub>	up to 1000.0 ml

Contact with naked hands and eyes had to be avoided

Coomassie staining was carried out by fixing the gels overnight with 400 ml fixation buffer in white plastic trays with shaking (20 rpm) and washed three times in 400 ml H<sub>2</sub>O<sub>mp</sub> for 30 min each. The gels were then incubated for 1 h in 400 ml incubation solution with shaking. Coomassie G250 (0,264 g) was added directly to the incubation solution and the gels were stained for at least five days with shaking. The gels were then destained by destaining solution for a few minutes. The gels were then scanned and stored at 4°C for manual spot excision and packed as mentioned before.

#### B. 4. 5. 2. Scanning of DIGE gels

After electrophoresis, 2D DIGE gels were scanned directly between the low fluorescent glass plates using the Typhoon 9400 scanner (GE Healthcare). All gels were scanned with a resolution of 100 microns and the photomultiplier tube set at 500 V. Emission filters and laser combinations are listed in Table 5.

Tab. 5: Excitation wavelengths and emission filters used for scanning of 2D DIGE gels with the Typhoon 9400 scanner.

Fluorescence dye	Emission Filter (nm)	Laser (nm)
Cy2	520 BP <sup>a</sup> 40	Blue2 (488)
Cy3	580 BP 30	Green (532)
Cy5	670 BP 30	Red (633)

<sup>a</sup>BP, bandpass

#### B. 4. 6. 2D DIGE image analysis

Determination of protein abundances and statistics were carried out with the DeCyder<sup>TM</sup> software package (version 5.0; GE Healthcare). Three images (corresponding to Cy2-, Cy3- and Cy5-labeled protein extracts) were generated from a single gel during repeated scanning. Identical spot maps were created for each merged image. For intra-gel analysis, normalized ratios of volumes (Cy3: Cy2 and Cy5: Cy2) were calculated. For inter-gel comparison, corresponding spots from all Cy-2 images were matched. Protein spots were regarded as regulated if fold-change was  $>|2.5|$ . The regulated protein spots were manually confirmed if ANOVA P-value  $< 0.05$  and t-test value  $< 10^{-4}$ . Abundant non-regulated protein spots (representative of housekeeping enzymes) were also matched and confirmed manually if they meet the statistical threshold.

#### B. 4.7. Protein identification

Regulated as well as abundant non-regulated protein spots were manually excised from 2 DE-separated Coomassie-stained gels and transferred to 96-well microtiter plates. Bands of proteins tentatively assigned as BssA from *D. toluolica* Tol2 and other alkylbenzene- or methyl-naphthalene-degrading sulfate-reducing bacteria were also manually excised from 1DE-

separated Coomassie-stained gels and transferred to 1.5 ml reaction cups. Tryptic digest and MALDI-TOF-MS and MS/MS analysis were carried out by Toplab GmbH (Martinsried, Germany). Fingerprinting based on MS or MS/MS data was done on a Mascot server (Matrix Science) against the public database. The database includes the genome sequence of anaerobically aromatic-compound degrading strain EbN1 (Rabus et al., 2005). Fingerprinting was based on the theoretical peptide masses generated by *in silico* digestion of predicted gene products. The threshold for correct matches was set to a Mascot score >50. This corresponds to a probability of  $< 10^{-5}$  that the match of experimental and theoretical peptide mass spectra is the result of a random event. Ambiguous identification results, e.g. more than two or three identifications per spot were excluded.



## C Results

### Part I: Anaerobic catabolism of aromatic compounds

#### C-I. 1. Growth behavior

*D. toluolica* Tol2 can grow with various aromatic compounds including toluene, benzoate, phenylacetate, *p*-cresol, *p*-hydroxybenzaldehyde and *p*-hydroxybenzoate. However, most of these compounds were toxic when applied at high concentrations except benzoate (6 mM). Therefore, toluene (2% in carrier phase) was supplied in a hydrophobic carrier phase to allow continuous supply with low concentrations, since direct addition to the culture was found to be inhibitory for growth (Rabus et al., 1993). Good growth with other aromatic substrates was possible when portions of low concentrations (phenyl acetate [4 portions of 0.2 mM]; *p*-cresol [6 portions of 0.15 mM]; *p*-hydroxybenzaldehyde [6 portions of 0.1 mM] and *p*-hydroxybenzoate [4 portions of 0.25 mM]) were added. Portions of aromatic substrates were added approximately every 24 h, except for *p*-cresol which were added approximately every 12 h (for comparison, App. 4). *D. toluolica* Tol2 was also able to grow with the aliphatic carboxylic acid fumarate which allowed rapid and robust growth. Fumarate-grown cells are used as reference state for 2DE-based proteomic analysis of the anaerobic degradation pathways of aromatic compounds.

After establishing the growth conditions, *D. toluolica* Tol2 was first adapted to the respective aromatic substrates by subsequent transfer for at least five passages. Detailed growth behavior of the adapted cultures was then monitored by measuring increases in optical density and sulfide formation (Fig. 8). The purpose of these growth curves was to determine time points for harvesting subsequent mass cultures at half-maximal OD. Thereby, misleading changes in the protein profiles originating from growth phase effects should be avoided. Except for cultures grown with phenylacetate and *p*-hydroxybenzaldehyde, cells were harvested at an optical density of approximately 0,2 (Tab. 6).

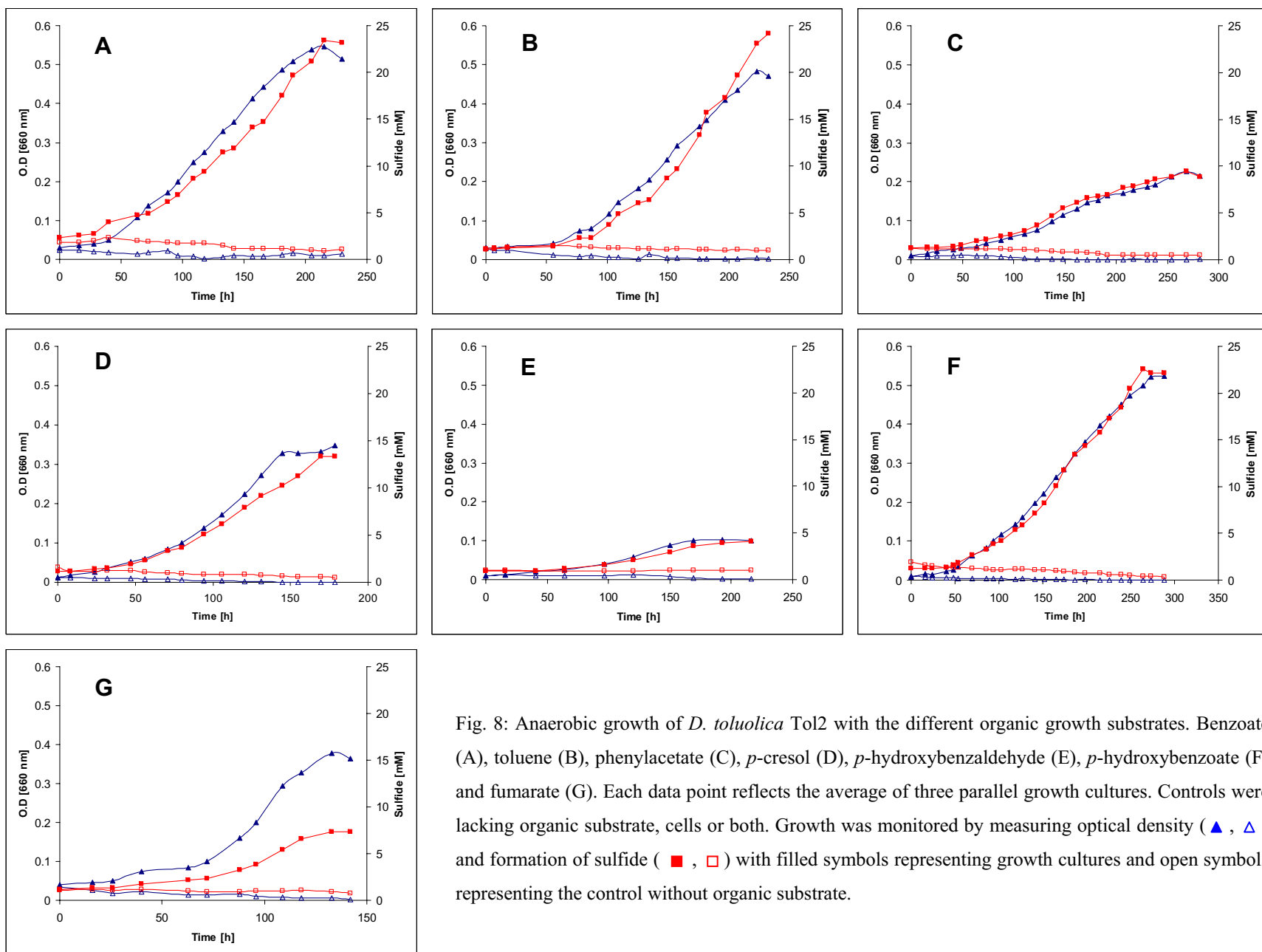

Fig. 8: Anaerobic growth of *D. toluolica* Tol2 with the different organic growth substrates. Benzoate (A), toluene (B), phenylacetate (C), *p*-cresol (D), *p*-hydroxybenzaldehyde (E), *p*-hydroxybenzoate (F) and fumarate (G). Each data point reflects the average of three parallel growth cultures. Controls were lacking organic substrate, cells or both. Growth was monitored by measuring optical density ( $\blacktriangle$ ,  $\triangle$ ) and formation of sulfide ( $\blacksquare$ ,  $\square$ ) with filled symbols representing growth cultures and open symbols representing the control without organic substrate.

Tab. 6: Half-maximal OD<sub>660</sub> values at which mass cultures were harvested. Values are based on growth curves shown in Fig. 8

<b>Growth substrate</b>	<b>O.D for harvesting (Half-maximal)</b>
Benzoate	0.2
Toluene	0.2
Phenylacetate	0.1
<i>p</i> -Cresol	0.2
<i>p</i> -Hydroxybenzaldehyde	0.08
<i>p</i> -Hydroxybenzoate	0.2
Fumarate	0.2

## C-I. 2. Proteomic analysis

### C-I. 2.1. Detection of BssA-like proteins by SDS-PAGE

Protein extracts from cells of *D. toluolica* Tol2 adapted to toluene and *p*-cresol were analyzed by IDE-based methods to test for the presence of a protein band possibly representing the  $\alpha$ -subunit of benzylsuccinate synthase (BssA). Such a band should subsequently be subjected to identification by MS/MS analysis and to quantification of fold-changes in abundance (fumarate- and benzoate-grown cells are used for comparison). Analysis of protein extracts from toluene-adapted cells by SDS-PAGE revealed the formation of two specific bands migrating along with the 100 kDa band of the molecular mass marker (Fig. 9). These proteins were absent in cells adapted to fumarate or benzoate. The two bands could be assigned as candidates for BssA and its oxygenolytic truncated product based on literature data (Leuthner et al., 1998; Rabus and Heider, 1998). Extracts from *p*-cresol-adapted cells showed also one band migrating at 100 kDa along with the tentative oxygenolytic truncated product of BssA from toluene-adapted cells (Fig. 9). The three protein bands representing candidates of BssA were excised and analyzed by a combined MS/MS analysis. Peptide fragment fingerprinting of tentative BssA from toluene-adapted cells against known BssA of the denitrifying strains *Thauera aromatica* K172 and strain EbN1 yielded matching of several peptide fragments (Tab. 7, Fig 10). On the other hand, only three peptide fragments from the tentative BssA of *p*-cresol-adapted cells of *D. toluolica* Tol2

could be matched with BssA of *Thauera aromatica* K172 (Tab. 8) and no matching was observed with BssA of strain EbN1.

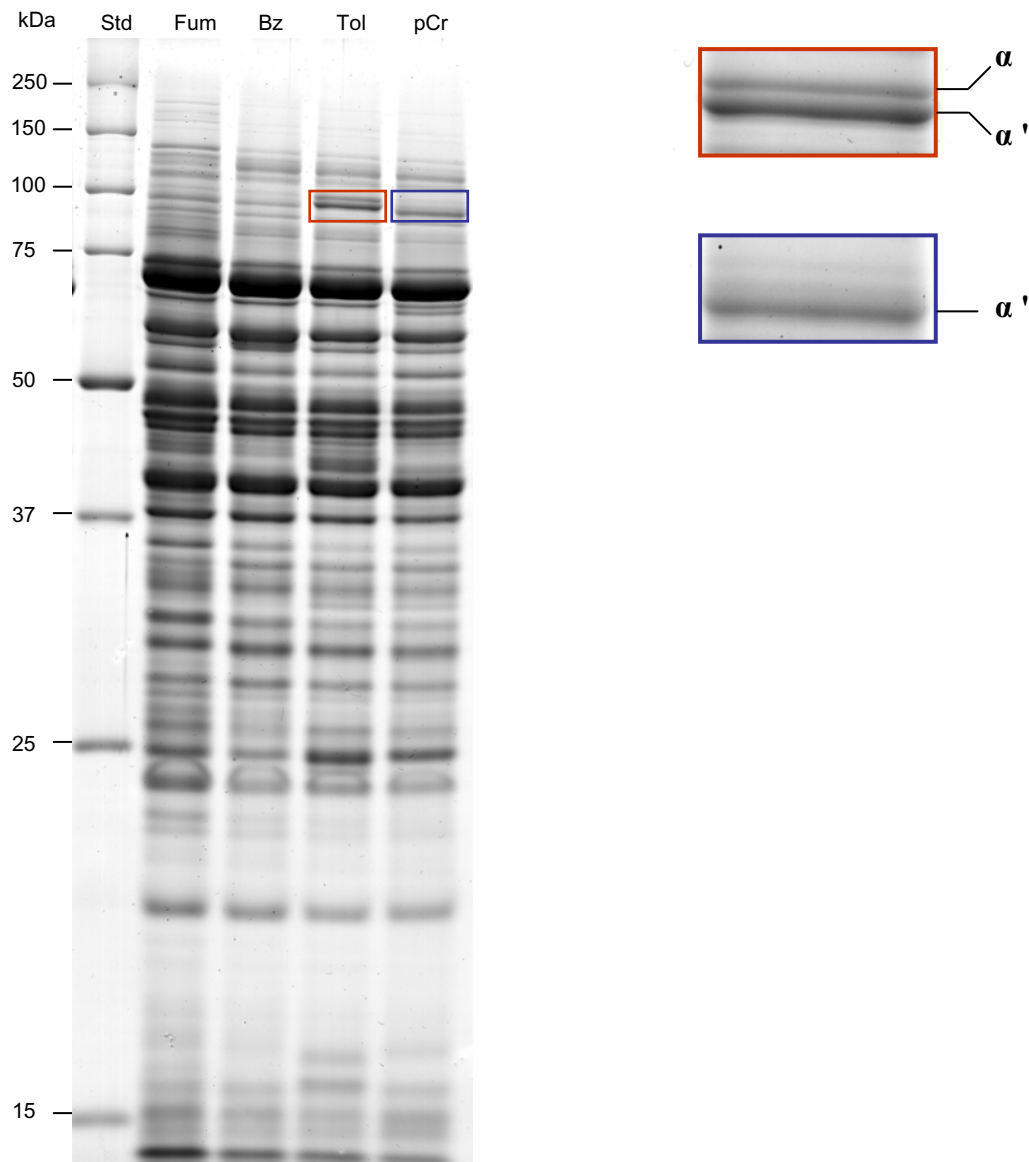

Fig. 9: SDS-PAGE of protein extracts of *D. toluolica* Tol2 grown with toluene (Tol) and *p*-cresol (pCr). The tentative  $\alpha$ -subunit of benzylsuccinate synthase (assigned as  $\alpha$ ) and its oxygenolytic truncation product (assigned as  $\alpha'$ ) in toluene-grown cells are indicated by the red box, whereas the tentative BssA from *p*-cresol-grown cells is indicated by the blue box. Extracts from cells grown with fumarate (Fum) or benzoate (Bz) are used for comparison. Lane Std represents the molecular mass marker. Protein load was 30  $\mu$ g and the gel was stained with Coomassie G250.

Tab. 7: Sequences and molecular data of the identified peptide fragments of the tentative BssA of toluene-adapted cells of *D. toluolica* Tol2 (A) and its truncated product (B) against the BssA of the aromatic-compound degrading denitrifiers *Thauera aromatica* K172 and strain EbN1.

**(A)**

Sequence	Start	End	$\pm$ da	$\pm$ ppm
LLTESHWATRGEPEPIR	74	90	- 0.1364	- 68
CEPYFDPVDLHR	166	177	- 0.1386	- 90
AVIAWAR	255	261	- 0.0694	- 88
TTEPSIVFR	419	427	- 0.0682	- 65
YTMAQLMDALQANWEGYEEMR	635	655	- 0.0732	- 28
NINYSGGPVKPTGQAVGLYMEVGSR	690	714	- 0.1074	- 41
TGPTPDGR	715	722	- 0.0100	- 12
ANLLNQR	760	766	- 0.0191	- 23
LSVPIMR	767	773	- 0.0182	- 22
FVDIPTYGQNTIAR	830	844	- 0.1051	- 62

*Thauera aromatica* K172

Sequence	Start	End	$\pm$ da	$\pm$ ppm
AVIAWAR	255	261	- 0.0694	- 88
TTEPSIVFR	419	427	- 0.0682	- 65
TGPTPDGR	715	722	- 0.0100	- 12
ANLLNQR	760	766	- 0.0191	- 23
LSVPIMR	767	773	- 0.0182	- 22
FVDIPTYGQNTIAR	830	844	- 0.1051	- 62

EbN1

**(B)**

Sequence	Start	End	$\pm$ da	$\pm$ ppm
CEPYFDPVDLHR	166	177	- 0.1531	- 99
TTEPSIVFR	419	427	- 0.0853	- 81
NINYSGGPVKPTGQAVGLYMEVGSR	690	714	- 0.2490	- 96
TGPTPDGR	715	722	- 0.0214	- 27
ANLLNQR	760	766	- 0.0461	- 56

*Thauera aromatica* K172

Sequence	Start	End	$\pm$ da	$\pm$ ppm
TTEPSIVFR	419	427	- 0.0853	- 81
NGNGVTPEEAHYWVNVLCMAPGVAGRR	472	498	- 0.0191	- 6
WGNDDDAADTLISR	664	677	- 0.1184	- 76
TGPTPDGR	715	722	- 0.0214	- 27
ANLLNQR	760	766	- 0.0461	56

EbN1

Tab. 8: Sequences and molecular data of the identified peptide fragments of the tentative BssA of *D. toluolica* Tol2 adapted to *p*-cresol against the BssA of the aromatic-compound degrading denitrifying *Thauera aromatica* K172.

Sequence	Start	End	± da	± ppm
EAQEIVDYWKPFSLQAR	149	165	- 0.1152	- 55
WFTFLICHAIER	310	321	- 0.1257	- 79
HNELGVQQMLEMAKYSR	455	471	- 0.0788	- 38

<i>Thauera aromatica</i> K172						
1	msdvqtleyk	gkvvqfapen	preaeipade	lhehlqnpst	ertrrlkarc	rwkhaaagef
61	cekgvtagie	rmrllteshw	atrgepepir	rahglknild	kstlvtlqtde	fivgyhaedp
121	nmfplypels	ymavqdylks	kysppakea	qeivdywkp	slqarcepyf	dpvdlhrgyq
181	vstiegpvfa	tgynsvippy	etvledglqa	rialaekie	haraemekfp	whapsglewi
241	dkidnwkamv	iackaviawa	rrharlckiv	aehfetdpkr	kaelleiadi	cqrmpaepar
301	glkdamqskw	ftflichaie	ryasgfaqe	dsllwpyyka	svidktfqpm	ehkdavelie
361	merlkvseh	agksrayrei	fpgsndlfil	tlggtngdgs	dacndmt dai	leatkri rtt
421	epsivfrysk	knraktlrwv	fecirdglgy	psikhnelgv	qqmlemakys	rngngatpee
481	ahywvnlcm	apglagrrka	qktrseggsa	ifpaklleit	lnngydwsya	dmqmgpetgy
541	akdfatfdql	weafrkqyqy	aialairckd	vsrtmecrfl	qmpfv saldd	gcmelgmdan
601	alseqpngwh	npitsivagn	slvaikkliy	dekkytmaql	mdalqanweg	yeemrrdfkn
661	apkwgndddd	advlisrfye	eilggemmn	inysggpvkp	tgqavglyme	vgsrtgptpd
721	grfggeaadd	ggispysgtd	kkqptavlrs	vskvqknqka	nllnqrslsvp	imrskhgfdi
781	whaymdtwhd	lnidhvqfnv	vsteemkaa	repekhqdli	vrvsgfsarf	vdiptygqnt
841	iiarneqfn	aqdleflnve	l			
Strain EbN1						
1	mtgaqtmeik	gkvlqftpen	paeadipade	lhehlqnpst	ertrrlkarc	rwkhasagef
61	cekgvtagie	rmrllteshw	dtrgkpepir	ralglknild	kctlvtlqpe	fivgyhaedp
121	nmfplypels	ymavqdylks	kysppakea	qeivdywkp	slqarcepyf	dpvdlrrgyq
181	vstiegpvfa	sgynsvippy	etiledglla	rialaeknie	haraemekfp	wnaptglewi
241	dkidnwamv	iackaviawa	rrharlckiv	aerfetdpkr	kaelleiadi	cqrmpaepar
301	glkdamqakw	ftflichaie	ryasgyaqe	dsllwpyyka	svidktfqpm	ehkdavelie
361	merlkvseh	agksrayrei	fpgsndlfil	tlggtngdgs	dacndmt dai	leakri rtt
421	epsivfrysk	knraktlrwv	fecirdglgy	psiknddli	qqllemakys	rngngvtpee
481	ahywvnlcm	apgvagrka	qktrseggsa	ifpaklleit	lsngydwsya	dmqmgpetgh
541	akdfatfdql	weafrkqyqy	aialairckd	vsrtmecrfl	qmpfv saldd	gcmelgmdan
601	alseqpngwh	npittivagn	slvaikkliy	dekkytmeql	mdalkanweg	yeemrrdfkn
661	apkwgnddda	adtlisrfye	eilggemmn	inysggpvkp	vgqavglyme	vgsrtgptpd
721	grfggeaadd	ggispysgtd	kkqptavlrs	vskvqknqka	nllnqrslsvp	imrskhgfdi
781	whaymdtwe	lnidhvqfnv	vsteemkaa	repekhqdli	vrvsgfsarf	vdiptygqnt
841	iiarneqdfn	aqdleflnae	l			

Fig. 10: Amino acid sequence of BssA from *Thauera aromatica* (Leuthner et al., 1998) and strain EbN1 (Rabus et al., 2005). Gray-shaded sequences indicate similar fragments generated from the tentative BssA proteins of *D. toluolica* Tol2 grown with toluene and *p*-cresol listed in Tables 7 and 8.

One-dimensional difference gel electrophoresis (1D DIGE) was used to quantify the relative abundance of tentative BssA protein in cells of *D. toluolica* Tol2 adapted to toluene and *p*-cresol. Protein extracts from benzoate adapted cells served as reference state. Figure 11 shows the overlay image of Cy3-labeled proteins from toluene-adapted cells and Cy5-labeled proteins from benzoate-adapted cells, where the band representing the tentative BssA can be detected as highly induced protein. The detected double pattern on Coomassie-stained SDS-polyacrylamide gels was not retained. Tentative BssA from *p*-cresol-adapted cells was also detectable as highly induced protein as compared to benzoate-adapted cells. However, analysis of fold-changes in abundance revealed that the toluene-adapted cells upregulated the tentative BssA by one order of magnitude higher than *p*-cresol-adapted cells: 40-fold versus 4.5-fold.

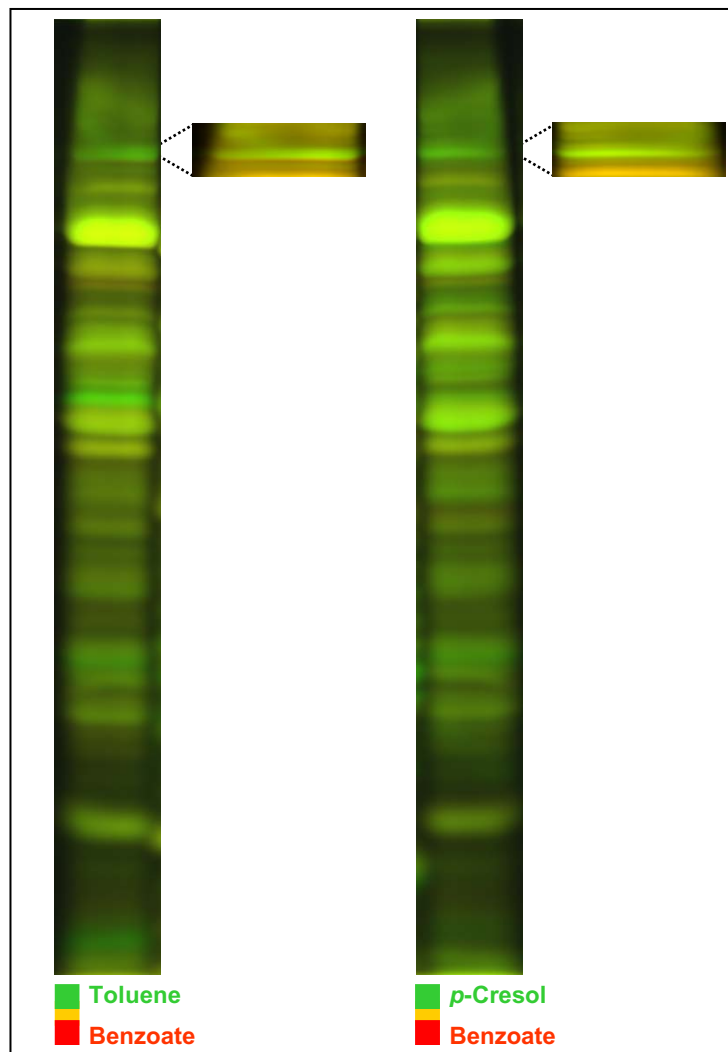

Fig. 11: 1D DIGE of protein extracts from *D. toluolica* Tol2 adapted to toluene and *p*-cresol (test states). Extracts from cells adapted to benzoate served as reference state. Test state is labeled with Cy3, whereas reference state is labeled with Cy5. Bands representing the tentative BssAs are enlarged. Green colour indicates up-regulation in test state.

## C-I. 2. 2. Optimization of 2 DE-based protein separation

### C-I. 2. 2. 1. Immobilized pH-gradient ranges

Two-dimensional gel electrophoresis (2 DE) was used as key proteomic tool for studying the (i) anaerobic degradation pathways of aromatic compounds and (ii) the terminal electron-accepting pathways in *D. toluolica* Tol2. 2 DE separates proteins according to their isoelectric points (pI) in the first dimension and according to their molecular weight by SDS-PAGE in the second dimension. There are presently two different experimental strategies for separating proteins in the first dimension: carrier ampholites versus immobilines. Isoelectric focusing using immobilized pH gradient is advantageous in terms of reproducibility of protein patterns. This allows reliable comparison of proteins from a test-state to their counterparts from a reference-state and detection of any newly synthesized proteins.

To select an immobilized pH range suitable for protein separation, 3 narrow ranges (4-7, 6-9 and 7-11) as well as 2 broad ranges (linear 3-10 and non-linear 3-10; the neutral pH range is more extended) were tested and compared (Figs. 12 - 14). The comparison is based on determining the number of specifically formed protein spots in four parallels gels of toluene- and benzoate-adapted cells (protein extracts from fumarate-grown cells were used as reference). As summarized in Table 9, the detected numbers of newly synthesized protein were almost higher in the broader linear range 3-10.

Tab. 9: Numbers of specifically formed proteins in silver stained-2DE gels of protein extracts from *D. toluolica* Tol2 adapted to toluene and benzoate as compared to fumarate adapted cells.

Substrate	Number of specifically formed proteins				
	pH 4-7	pH 6-9	pH 7-11	Non-linear pH 3-10	Linear pH 3-10
Benzoate	3	-	-	6	8
Toluene	19	4	1	22	28



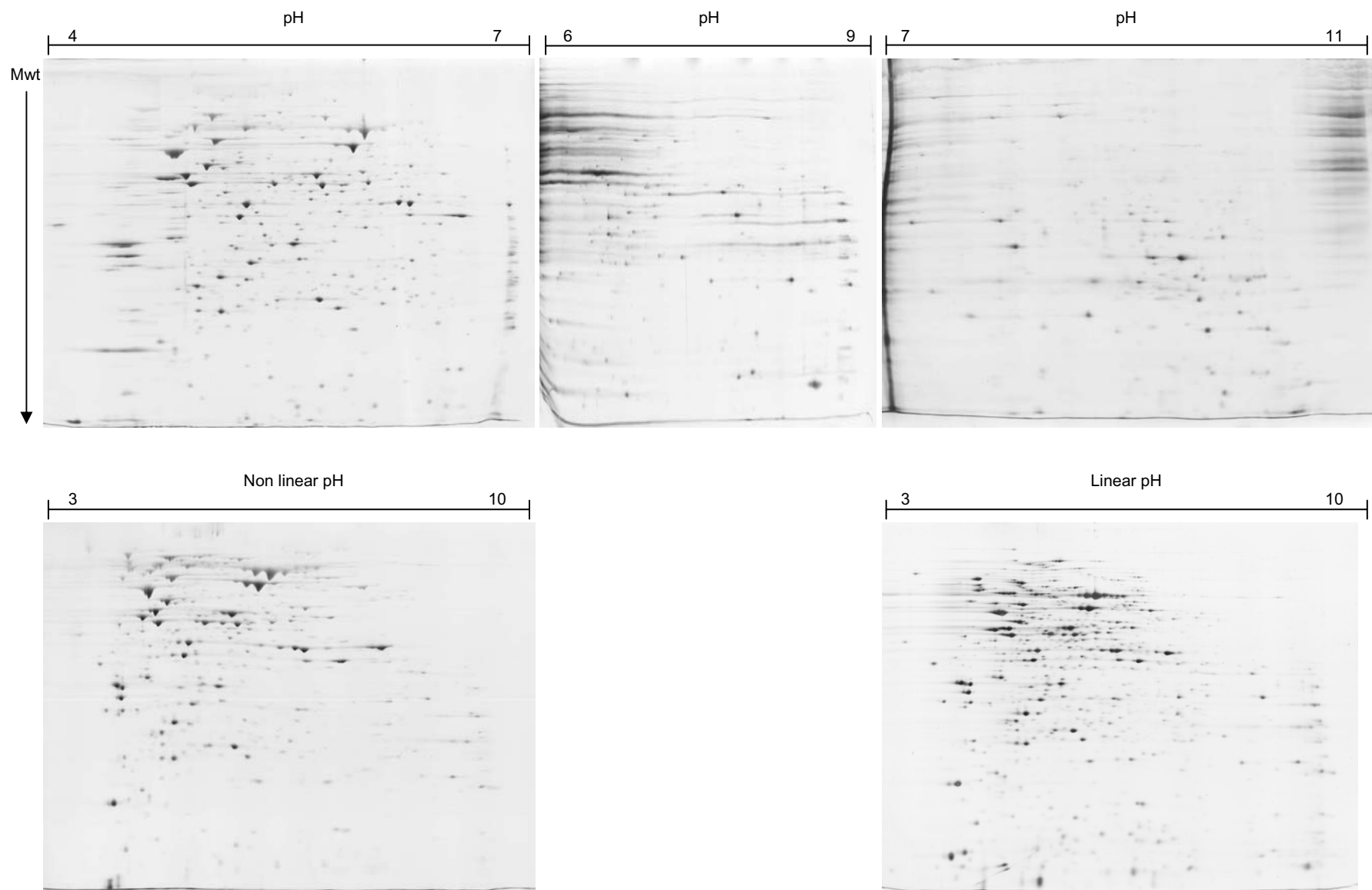

Fig. 12: Protein profiles of *D. toluolica* Tol2 grown with fumarate as resolved by 2DE. IEF was carried out with the following immobilized pH ranges: 4-7, 6-9, 9-11, 3-10 NL and 3-10. These protein profiles were used as reference state for benzoate- and toluene-specific protein spots in Figures 13 and 14. Gels are silver stained.

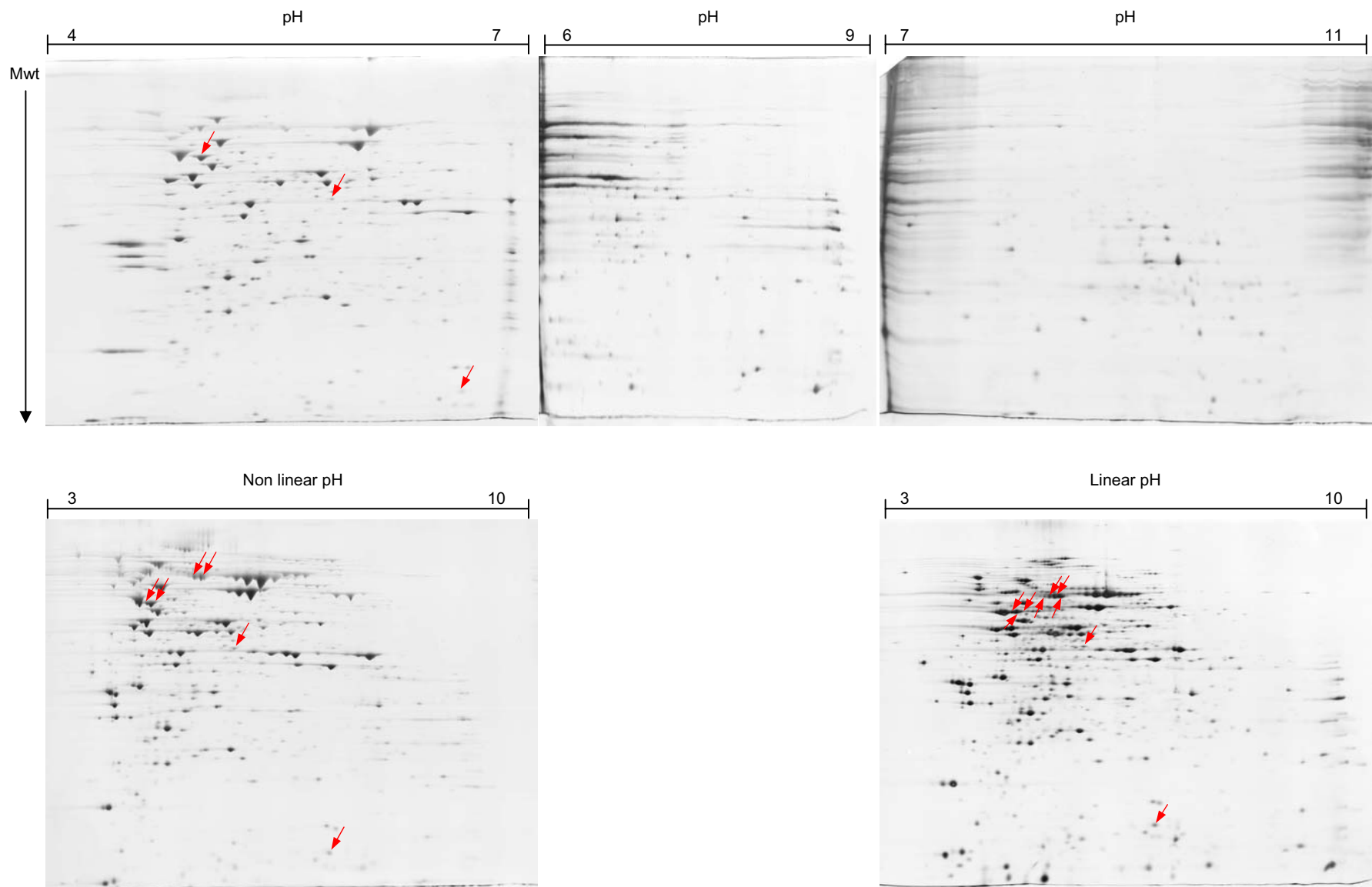

Fig. 13: Protein profiles of *D. toluolica* Tol2 grown with benzoate as resolved by 2DE. IEF was carried out with the following immobilized pH ranges: 4-7, 6-9, 9-11, 3-10 NL and 3-10. Arrows indicate benzoate-specific proteins as compared to fumarate-adapted cells. Gels are silver stained.

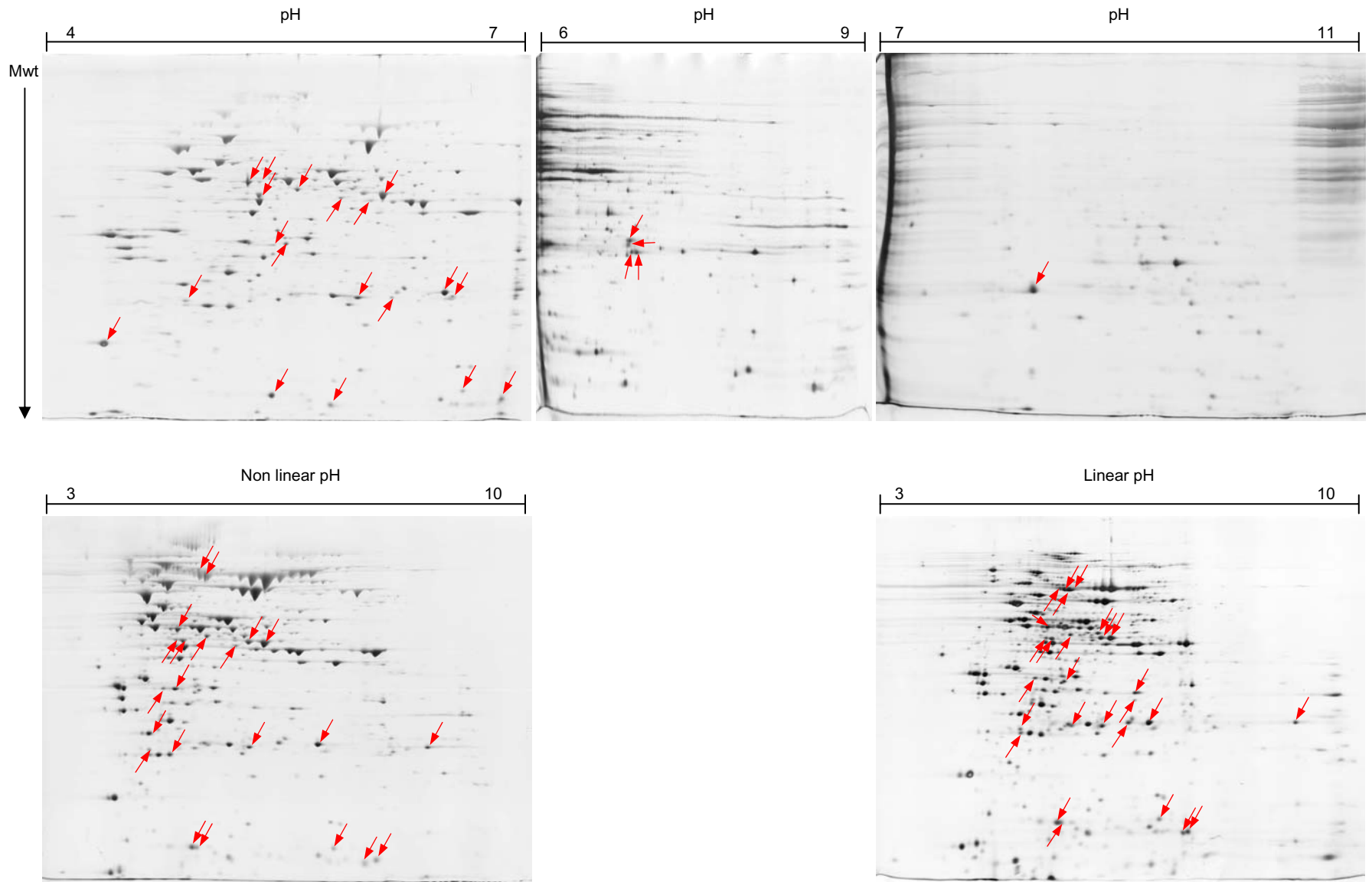

Fig. 14: Protein profiles of *D. toluolica* Tol2 grown with toluene as resolved by 2DE. IEF was carried out with the following immobilized pH ranges: 4-7, 6-9, 9-11, 3-10 NL and 3-10. Arrows indicate toluene-specific proteins as compared to fumarate-grown cells. Linear pH 3-10 gradient displayed the highest resolution. Gels are silver-stained.

### C-I. 2. 2. 2. Immobilized pH gradient versus non-equilibrium pH gradient

The number of newly synthesized protein spots resolved from cells adapted to benzoate using immobilized pH gradient was relatively low in all tested pH ranges. Therefore, non equilibrium pH gel electrophoresis (NEPHGE) using carrier ampholites was carried out and compared to immobilized pH gradient system. NEPHGE is generally believed to be more suitable for resolving hydrophobic proteins or proteins carrying metal-cofactors. Only two newly synthesized protein spots could be detected (as compared to extracts from fumarate-adapted cells, Fig. 15). This indicates that detection of substrate-specific formation of proteins is not limited by application of the immobilized pH gradient system.

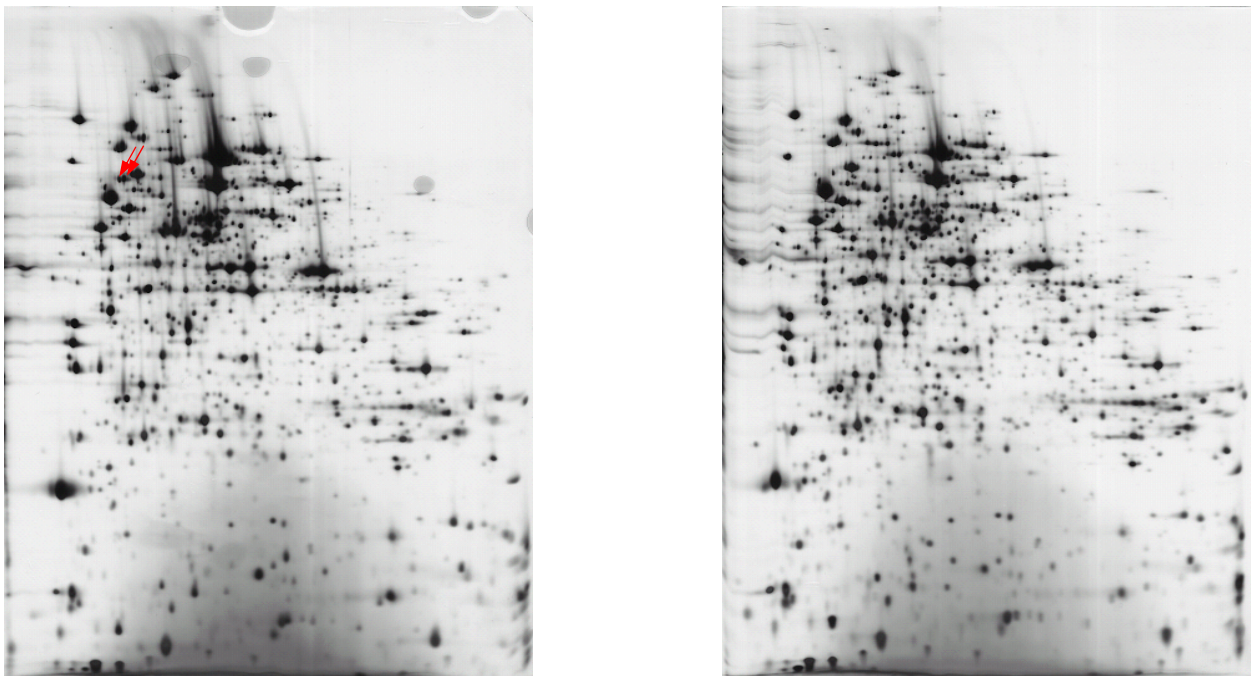

Fig. 15: Non equilibrium pH gel electrophoresis of proteins extracted from cells of *D. toluolica* Tol2 adapted to benzoate (left) and fumarate (right). Arrows indicate the benzoate-specific protein spots as compared to fumarate-adapted cells. The marked protein spots were also detected when immobilized pH gradient was used.

### C-I. 2. 2. 3. Sample rehydration

Protein spots of apparent same molecular mass and different isoelectric points were frequently detected on our 2 DE gels forming strings or horizontal smears. This may result from carbamylation of proteins at temperatures higher than room temperature (RT) during the rehydration of the immobilized pH gradient strips. The rehydration buffer was replaced by the commercially available DeStreak™ rehydration solution which can be dissolved at RT without heating. The patterns of spot strings were retained even when applying DeStreak™ rehydration solution. However, horizontal streaking of the spots was minimized (Fig. 16).

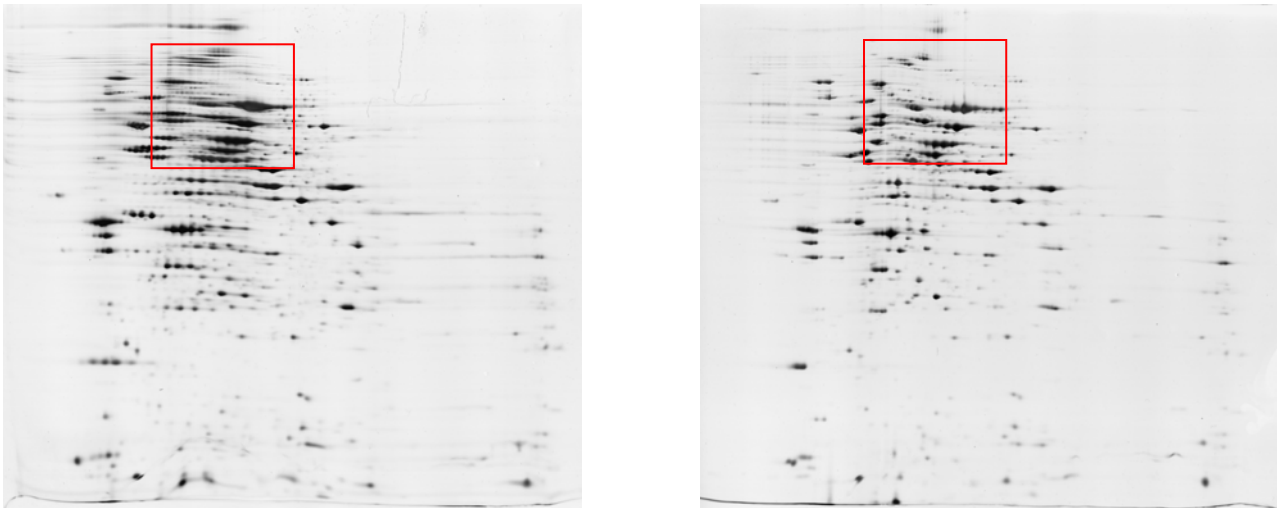

Fig. 16: 2DE protein profiles of *D. toluolica* Tol2 grown with phenylacetate. Immobilized pH gradient strips were rehydrated by rehydration buffer (left) and Destreak™ rehydration solution (right). Spot strings (examples indicated by red box) appear in both case. However, streaking effect was minimized when Destreak was used.

### C-I. 2. 3. Aromatic-compound specific differential protein profiles

Proteins involved in the anaerobic catabolism of the aromatic compounds (benzoate, toluene, phenylacetate, *p*-cresol, *p*-hydroxybenzaldehyde and *p*-hydroxybenzoate) in *D. toluolica* Tol2 were separated by 2 DE applying an immobilized pH gradient 3-10 and initially detected by silver staining (detection limit 0.05-2 ng; Gade et al., 2003). Comparison of silver-stained 2 DE gels revealed protein spots that were specific for each aromatic compound as well as protein spots that were common for all tested aromatic compounds when fumarate-adapted cells were used as reference state (Fig. 12 - 14; App. 5). Even though these experiments confirmed at the proteomic level that the aromatic catabolic pathways are inducible by the correspondent substrates, they did not answer the question about their regulation in a quantifiable manner. Therefore, 2D DIGE was used to determine the regulation of the respective pathways by quantifying the changes in abundance between the proteins extracted from cells adapted to each aromatic compound and proteins extracted from cells adapted to the non-aromatic compound fumarate.

2D DIGE analysis of protein profiles in *D. toluolica* Tol2 grown with aromatic compounds revealed three categories of regulated protein spots; i) specifically up-regulated, ii) commonly up-regulated, and iii) commonly down-regulated protein spots. The first group represents candidates for enzymes that are only involved in the catabolism of the respective aromatic compound to the level of benzoyl-CoA. The second group represents candidates for enzymes probably co-occurring in several compound-specific pathways or involved in the central degradation pathway of benzoyl-CoA to acetyl-CoA. A total number of 69 compound-specific up-regulated protein spots could be detected; with benzoate-specific proteins constituting the smallest (4 spots) and phenylacetate the largest subgroup (35 spots). Eleven, 10 and 9 specifically up-regulated protein spots were detected in cells adapted to toluene, *p*-cresol and *p*-hydroxybenzaldehyde, respectively. No specifically up-regulated protein spots could be detected for *p*-hydroxybenzoate. Instead, 10 commonly up-regulated protein spots were detected.

A total number of 38 commonly up-regulated protein spots could be resolved (Tab. 10). The number of down-regulated was almost the same with every aromatic compound used, indicating that these protein spots are not induced in aromatic catabolism. The detailed regulation of up-regulated protein spots is illustrated in Figure 17.

Tab. 10: Numbers of regulated protein spots among the aromatic catabolic pathways.

Aromatic compound	Specifically up-regulated <sup>a</sup>	Commonly up-regulated <sup>b</sup>	Commonly down-regulated <sup>c</sup>
Benzoate	4	15	11
Toluene	11	29	11
Phenylacetate	35	22	12
<i>p</i> -Cresol	10	31	12
<i>p</i> -Hydroxybenzaldehyde	9	6	12
<i>p</i> -Hydroxybenzoate	-	10	12

<sup>a</sup> Highly induced under the respective growth substrate condition

<sup>b</sup> Highly induced under two or more growth substrate conditions

<sup>c</sup> Down-regulated under two or more growth substrate conditions

#### C-1. 2. 4. Mass spectrometric analysis of regulated and non-regulated proteins

Regulated protein spots were excised from Coomassie-stained gels for subsequent MS(/MS) analysis. Also, a number of commonly non-regulated protein spots was excised for MS(/MS) analysis to gain further insights into the metabolism of *D. toluolica* Tol2. The total number of protein spots submitted for MS(/MS) analysis was 192; 119 regulated and 73 non-regulated protein spots. Since the genome sequence of *D. toluolica* Tol2 is currently unknown, peptide mass fingerprints (PMFs) and peptide fragment fingerprints (PFFs) were compared to the public database which also includes the complete genome sequence of the aromatic-compound degrading denitrifying strain EbN1 (Rabus et al., 2005). Remarkably, only a minor fraction of regulated proteins could be identified (6 out of 119 analyzed protein). The identified proteins are among the specifically up-regulated protein spots; 1 thiolase for toluene, 2 thiolases for *p*-cresol, 2 hypothetical proteins for phenylacetate, 1 related NADH oxidase for *p*-hydroxybenzaldehyde (Tab. 11). None of the proteins specific for *p*-hydroxybenzoate, benzoate, or commonly up-regulated protein spots could be identified.

Regarding the non-regulated protein spots, 11 out of 73 protein spots could be identified. Among them were subunits of the key enzymes in the sulfate reduction pathway; adenosine-5'-phosphosulfate reductase alpha subunit (AprA), dissimilatory sulfite reductase subunit A (DsrA) and dissimilatory sulfite reductase subunit B (DsrB) [Tab. 12, Fig 18]. Formate-tetrahydrofolate ligase was also identified. Other identified, non-regulated protein spots include chaperonin GroEL, heat shock protein and elongation factor EF-Tu (Tab. 12, Fig. 18).

Fig. 17: Differential protein profiles of *D. toluolica* Tol2 adapted to anaerobic growth with different aromatic compounds. Benzoate (6 mM) [A], toluene (0,66 mM) [B], phenylacetate (0,8 mM) [C], *p*-cresol (0,9 mM) [D] and *p*-hydroxybenzaldehyde (0,6 mM) [E]. Cells grown with fumarate (10 mM) served as reference state. Test states (extracts from cells grown with aromatic compounds) were labeled with Cy3, whereas extract from the reference state was labeled with Cy5. A mixture of equal amounts of all test states and reference state was labeled with Cy2 and used as internal standard. An overlay image of test states and reference state is shown. Each bar represents one regulated protein spot annotated on the gels. Protein spots were regarded as regulated when fold-changes in abundance were  $>|2.5|$ . *p*-Hydroxybenzoate did not show a specific regulatory pattern, however, commonly regulated protein spots were detected. Only specifically up-regulated protein spots are annotated on gels.



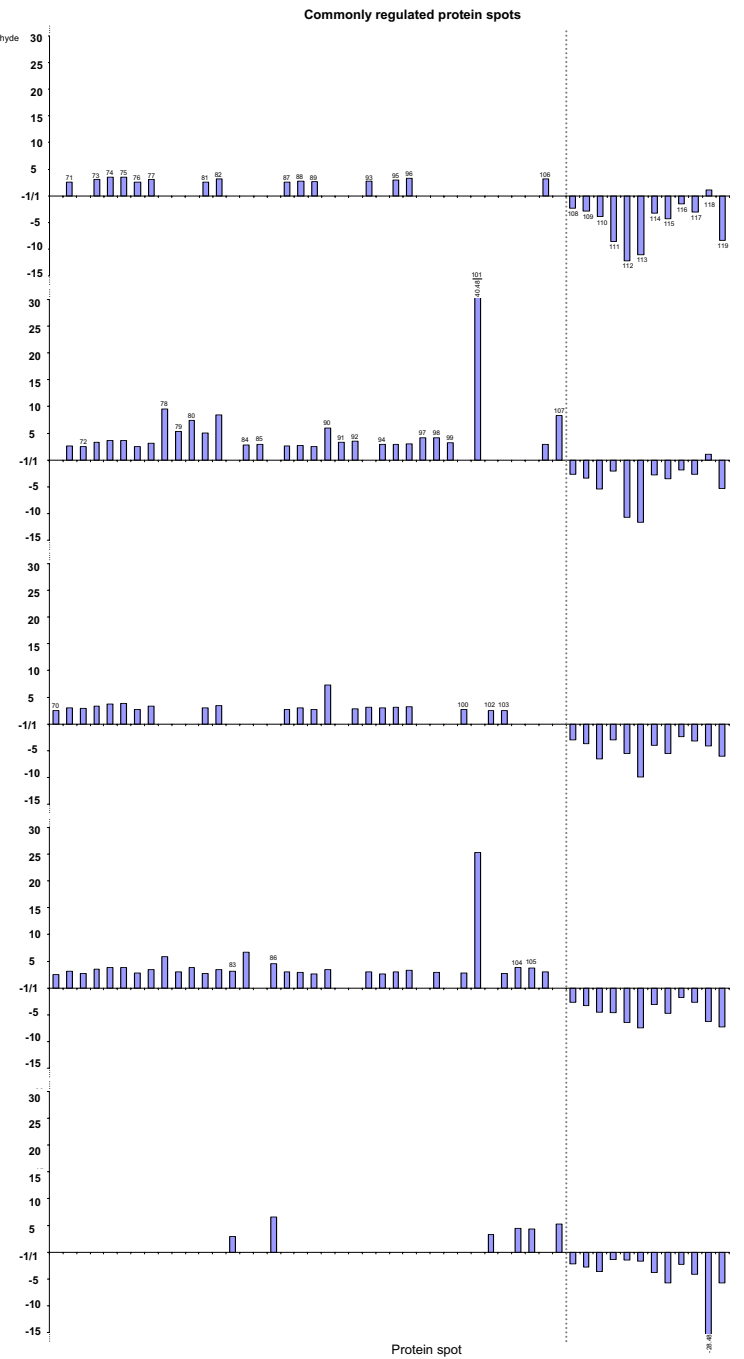
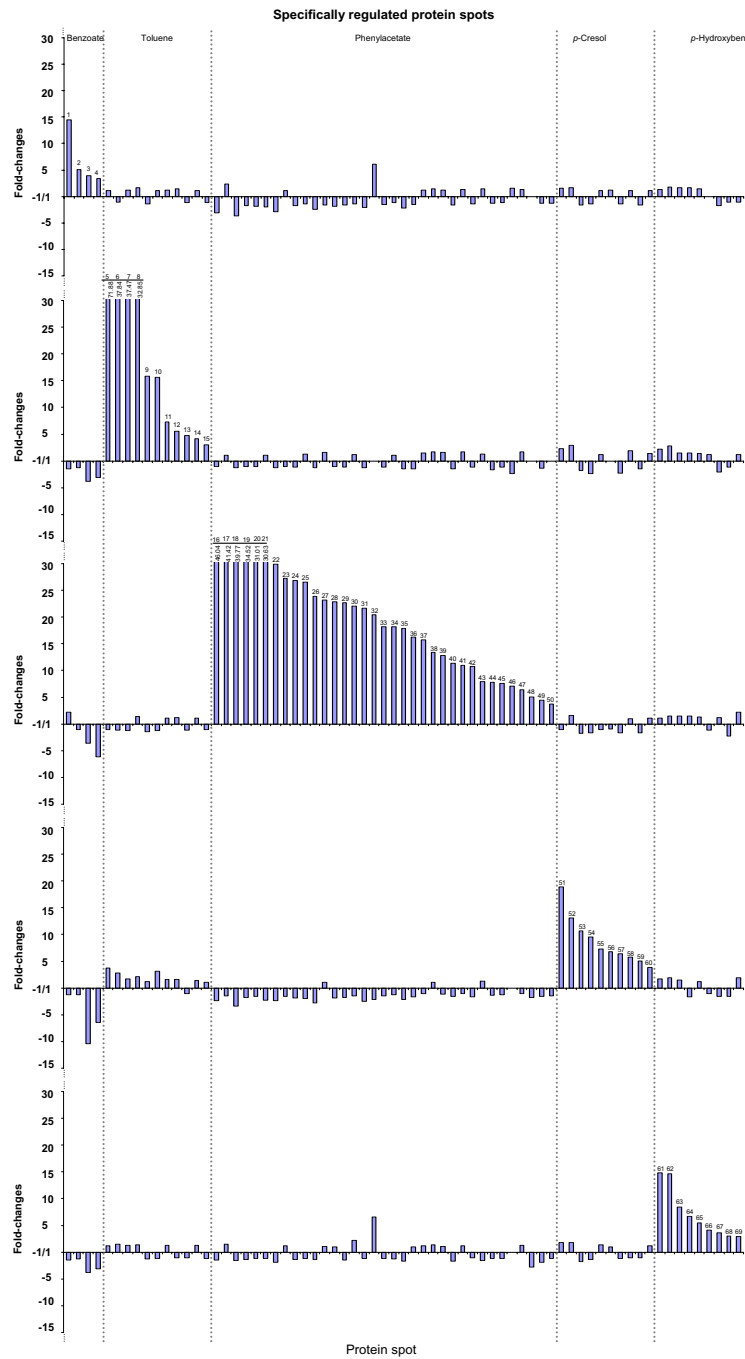
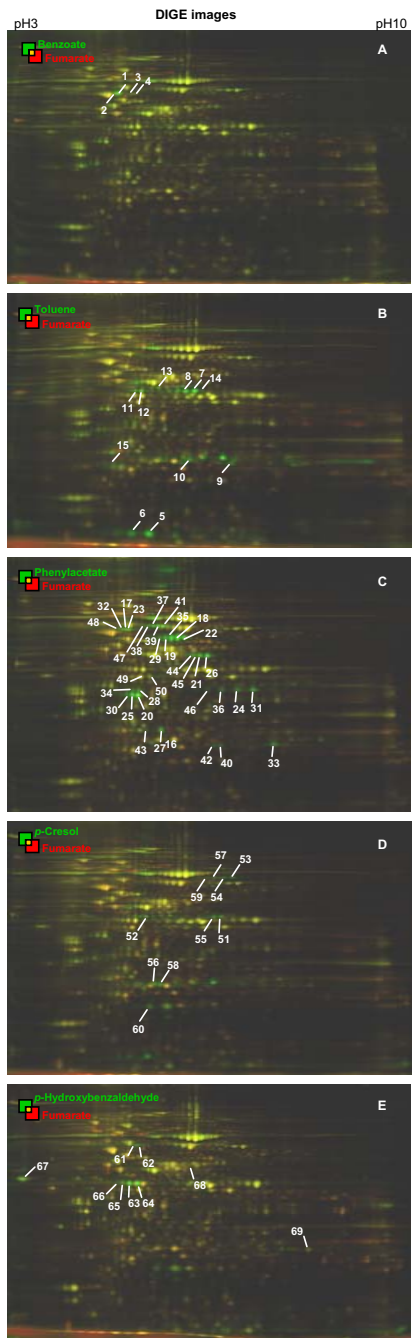

Tab. 11: Identification details for specifically up-regulated proteins from *D. toluolica* Tol2.

<b>Protein</b>	<b>Substrate</b>	<b>Coverage (%)</b>	<b>Mascot score</b>	<b>Fold-changes in abundance</b>
Thiolase	<i>p</i> -Cresol	4,6	107,9	18,87
Thiolase	<i>p</i> -Cresol	3,8	89,9	7,30
Hypothetical protein	Phenylacetate	44,1	99,2	13,44
Hypothetical protein	Phenylacetate	42,7	119,0	10,80
Thiolase	Toluene	3,8	92,3	37,47
Related to NADH oxidase	<i>p</i> -Hydroxybenzaldehyde	3,4	89,7	3,06

Tab. 12: Identification details for commonly non-regulated proteins (<|2.5| fold change in abundance) from *D. toluolica* Tol2.

<b>Protein</b>	<b>Coverage (%)</b>	<b>Mascot score</b>
Adenosine-5'-phosphosulfate reductase alpha subunit	44,9	103,3
Dissimilatory sulfite reductase subunit A	51,5	216,0
Dissimilatory sulfite reductase subunit B	60,5	216,0
Formate-tetrahydrofolate ligase	3,2	123,9
Chaperonin GroEL	5,5	123,9
Heat shock protein	3,1	79,9
Elongation factor EF-Tu	4,3	133,6

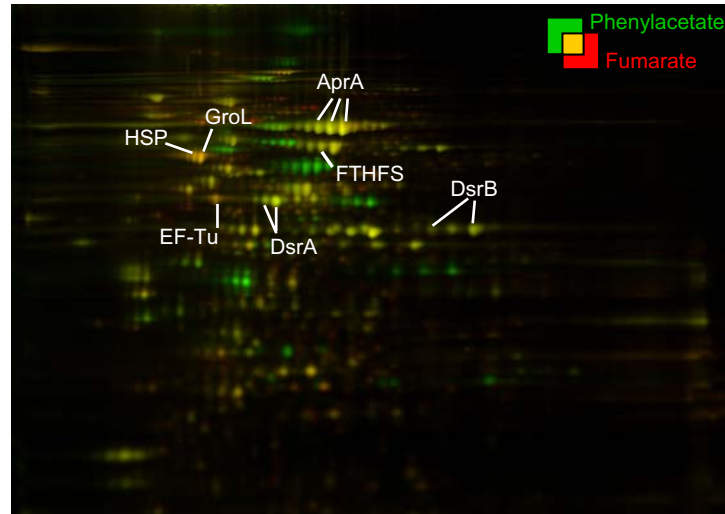

Fig. 18: 2D DIGE image of protein extracts from *D. toluolica* Tol2 grown with phenylacetate (fumarate-grown cells served as reference). The identified non-regulated protein spots are annotated; AprA, adenosine-5'-phosphosulfate reductase alpha subunit; DsrA, dissimilatory sulfite reductase subunit A; DsrB, dissimilatory sulfite reductase subunit B, FTHFS, formate-tetrahydrofolate synthase; GroL, chaperonin GroEL; HSP, heat shock protein; EF-Tu, elongation factor EF-Tu.

## Part II: Regulation of sulfate reduction pathway by different electron acceptors

### C-II. 1. Growth behavior

In the before described experiments with *D. toluolica* Tol2 adapted to different aromatic substrates, sulfate was always supplied as terminal electron acceptor. *D. toluolica* Tol2 was also able to use sulfite (5 mM) and thiosulfate (5 mM) as alternative electron acceptors with benzoate (2 mM) as sole source of carbon and energy. To study regulation of the sulfate reduction pathway by different electron acceptors, 4 growth conditions were designed: sulfate (5 mM), sulfite (5 mM), thiosulfate (5 mM) or a mixture of sulfate, sulfite and thiosulfate (5 mM each). The growth behavior under these conditions was studied by measuring the increase in O.D, sulfide formation and changes in electron acceptor concentrations. During growth with sulfate (5 mM), most of it was consumed within 114 h, at this time the sulfate concentration was 0,81 mM. No significant accumulation of sulfite or thiosulfate could be detected (Fig. 19). In cultures grown with sulfite (5 mM), most sulfite was utilized within 71 h with 0,67 mM sulfite remaining. Significant amounts of sulfate (2,9 mM) and thiosulfate (3,4 mM) could be detected during growth with sulfite (Fig. 19). When cells were grown with thiosulfate, only 0,02 mM could be detected after 160 h. Sulfate (1,2 mM) could be detected after 114 h (Fig. 19).

In culture amended with a mixture of electron acceptors, the latter were sequentially depleted. Sulfite was the first to be utilized, followed by thiosulfate. No clear depletion of sulfate could be detected indicating the following order of electron acceptor depletion: sulfite, thiosulfate and sulfate (Fig. 19).

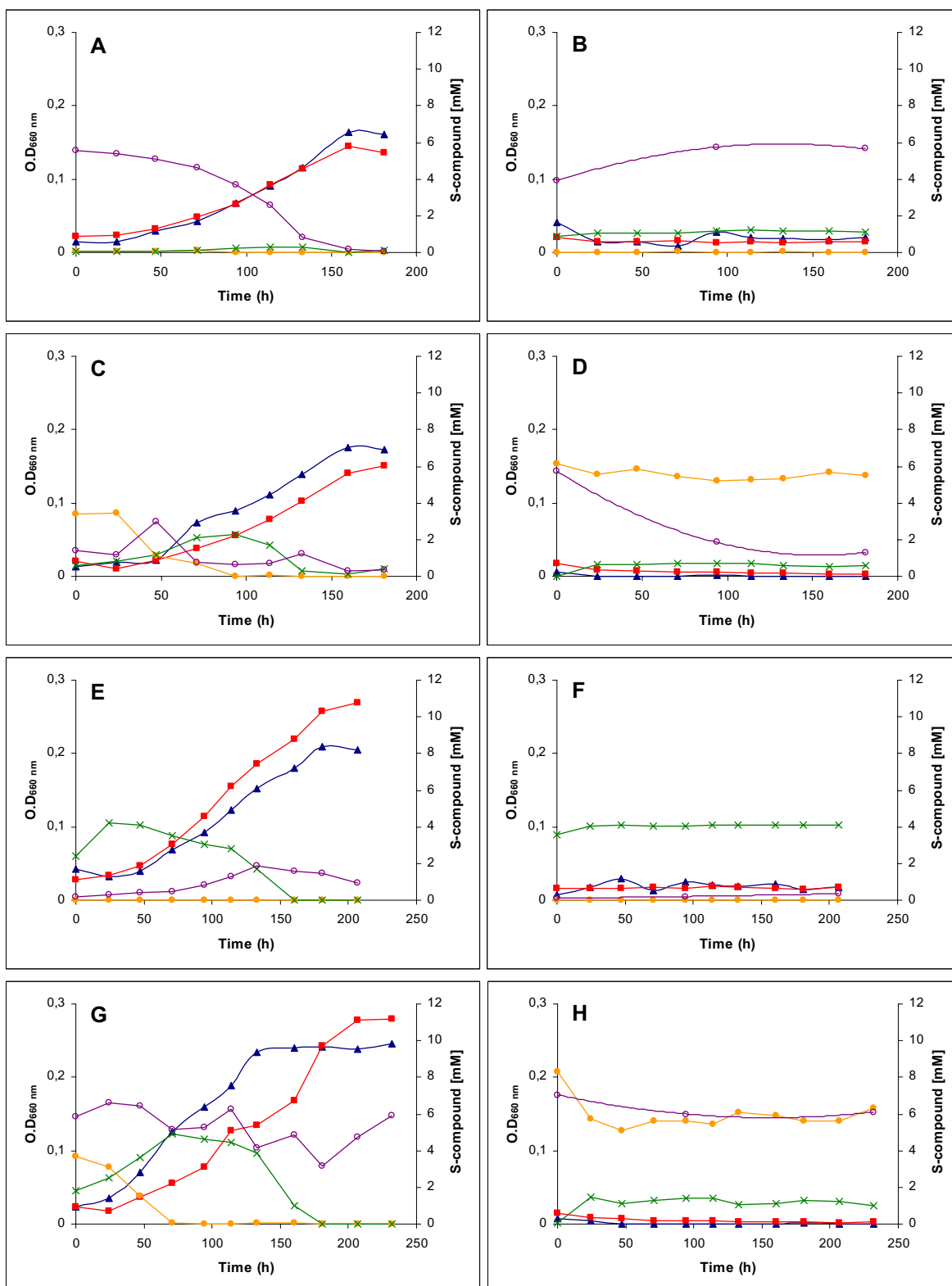

Fig. 19: Anaerobic growth of *D. toluolica* Tol2 with benzoate (2 mM) coupled to different electron acceptors: Sulfate (5 mM) [A], sulfite (5 mM) [C], thiosulfate (5 mM) [E], or mixture of sulfate, sulfite and thiosulfate (5 mM each) [G]. Growth behaviour was studied by measuring optical density (  $\blacktriangle$  ) and concentrations of sulfide (  $\blacksquare$  ), sulfite (  $\bullet$  ), thiosulfate (  $\times$  ) and sulfate (  $\circ$  ). Plots B, D, F and H represent cell-free controls corresponding to the plots A, C, E and G, respectively.

## C-II. 2. Proteomic analysis

### C-II. 2. 1. Regulation of sulfate reduction enzymes

Cultures of *D. toluolica* Tol2 were adapted to growth with benzoate (2 mM) and different electron-acceptor conditions: sulfate (5 mM), sulfite (5 mM), thiosulfate (5 mM) and a mixture of electron acceptors (5 mM each). The differential protein profiles of these cultures were analyzed by 2D DIGE. These experiments aimed at determining the electron-acceptor dependent regulation of adenosine-5'-phosphosulfate reductase alpha subunit (AprA), dissimilatory sulfite reductase subunit A (DsrA) and dissimilatory sulfite reductase subunit B (DsrB), when benzoate was used as organic growth substrate. The test states in these experiments are cells grown with sulfite, thiosulfate, or a mixture of sulfate, sulfite and thiosulfate, while cells grown with sulfate served as reference state. No significant changes in abundance of the three proteins could be detected under the three tested electron acceptor conditions (Fig. 20, 21).

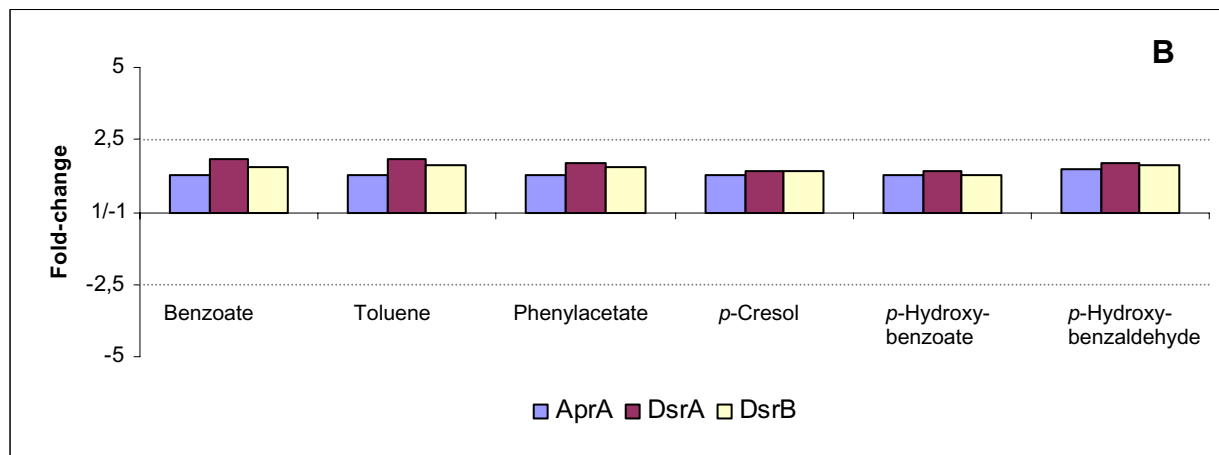
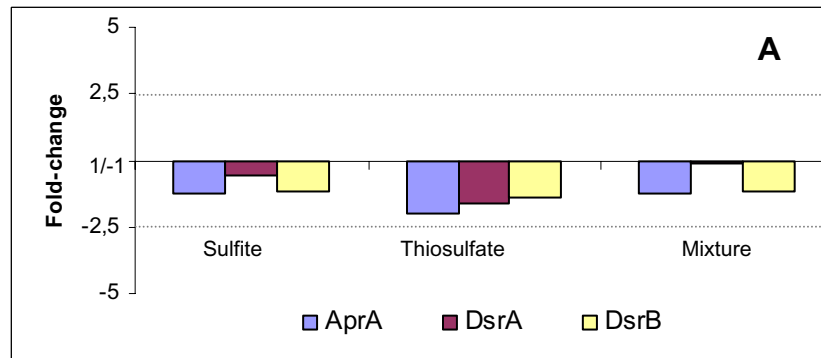

Fig. 20: (A) Average fold-changes in abundance of sulfate reduction enzymes in *D. toluolica* Tol2. Protein abbreviations: adenosine-5'-phosphosulfate reductase alpha subunit, AprA; dissimilatory sulfite reductase subunit A, DsrA and dissimilatory sulfite reductase subunit B, DsrB. Cells of *D. toluolica* Tol2 were grown under two different conditions. (A) With benzoate and different electron acceptor conditions; sulfite, thiosulfate or mixture of sulfate, sulfite and thiosulfate. (B) With sulfate as electron acceptor and different aromatic substrates. The grey dashed lines indicate fold-change range regarded as not-regulated ( $\pm 2.5$  fold changes).

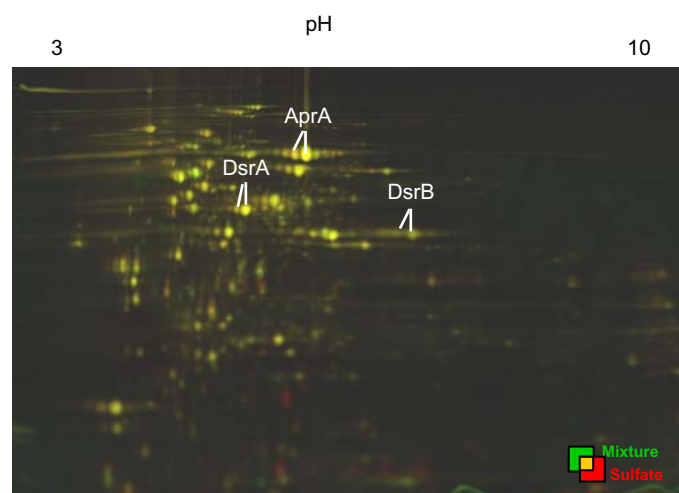

Fig. 21: 2D DIGE gel image of proteins extracted from cells of *D. toluolica* Tol2. Growth with benzoate (2 mM) and a mixture of electron acceptors (sulfate [5 mM], sulfite [5 mM] and thiosulfate [5 mM]) represented the test state, while growth with benzoate (2 mM) and sulfate (5 mM) represented the reference state.

## C-II. 2. 2. Electron-acceptor specific regulation

Even though 2D DIGE analysis revealed unchanged abundances of AprA, DsrA and DsrB during growth with different electron-acceptor conditions, up- and down-regulated protein spots could be detected (cells grown with sulfate as electron acceptor served as reference). The detected up-regulated protein spots were electron-acceptor specific. 7 sulfite-specific protein spots could be detected. MS-based analysis of the protein spots revealed the tentative identification of one protein spot as 50S ribosomal protein L5. Also 9 thiosulfate-specific protein spots could be detected. Among them 3 protein spots could be tentatively identified: signal transduction histidine kinase, chaperonin and hypothetical protein. In addition, specifically and commonly down-regulated protein spots could be also detected. 5 protein spots were down-regulated when sulfite was used as terminal electron acceptor. Among them a ferredoxin-like protein could be tentatively identified. One protein spot was specifically down-regulated when cells were grown with thiosulfate and two when cells were grown with a mixture of electron acceptors. None of the three spots could be identified by MS analysis. Three protein spots were commonly down-regulated. Two of them could be tentatively identified as aspartyl-tRNA synthetase and thioredoxin-disulfide reductase. The differential protein profiles of *D. toluolica* Tol2 adapted to the different electron acceptor conditions are detailed in Figure 22. The molecular data of the tentatively identified proteins is summarized in Table 13.



Tab. 13: Identified, regulated proteins of *D. toluolica* Tol2 grown under different electron-acceptor conditions.

<b>Protein</b>	<b>Electron-acceptor condition</b>	<b>Size (kDa)</b>	<b>pI</b>	<b>Mascot score</b>	<b>Fold-changes in abundance</b>
50S ribosomal protein L5	Sulfite	20,2	8,7	97,1	13,07
Signal transduction histidine kinase	Thiosulfate	89,0	5,5	94,5	4,13
Chaperonin	Thiosulfate	57,7	5,0	95,8	3,67
Hypothetical protein	Thiosulfate	36,1	7,7	98,2	3,58
Ferredoxin-like protein	Sulfite	10,1	7,6	95,2	- 2,38
Aspartyl-tRNA synthetase	Sulfite	66,1	5,2	99,2	- 3,05
	Thiosulfate				- 6,66
	Mixture				- 7,47
Thioredoxin-disulfide reductase	Sulfite	34,6	5,0	94,3	- 3,33
	Mixture				- 2,52

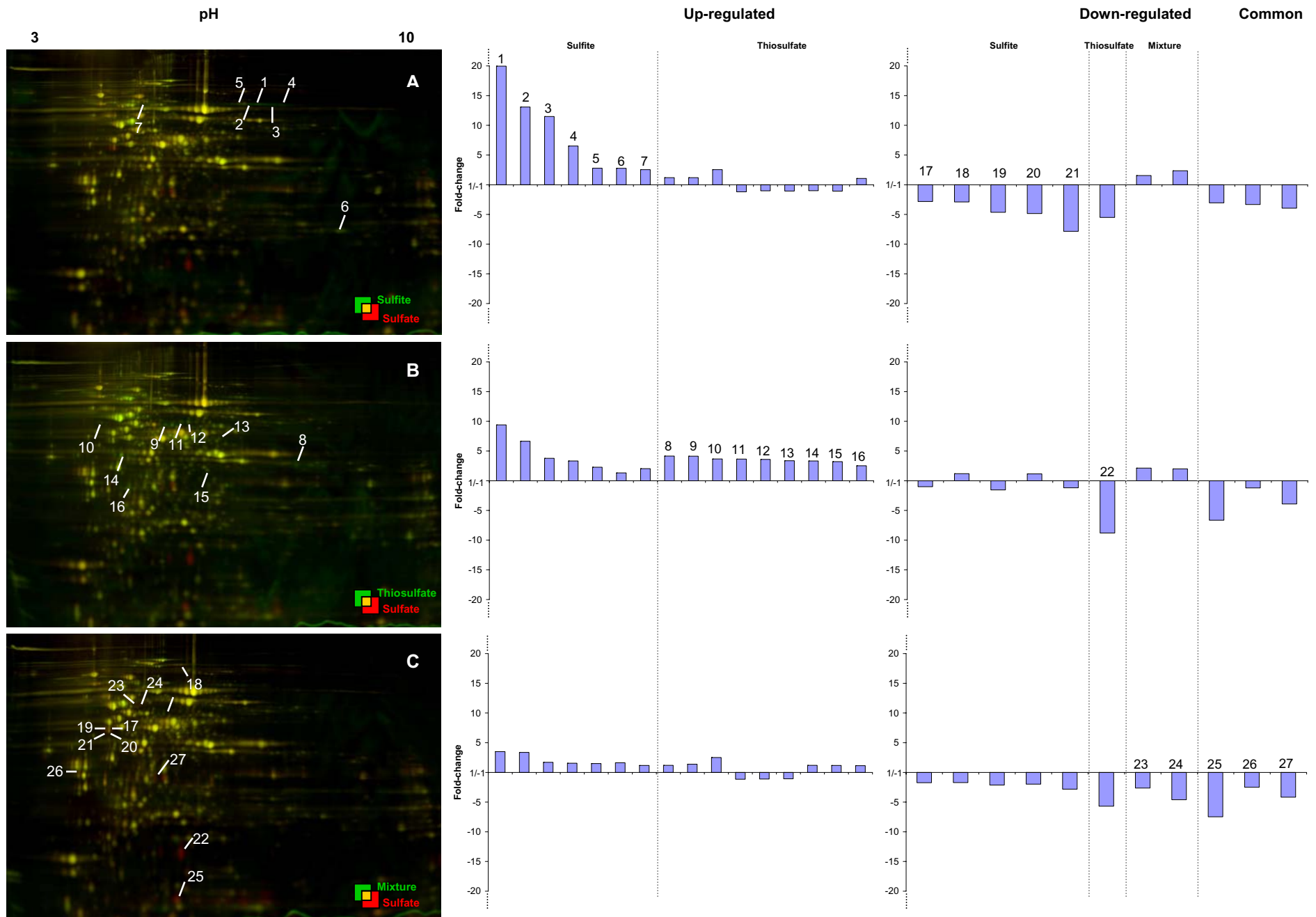

Fig. 22: Differential protein profiles of *D. toluolica* Tol2 grown with sulfite (A), thiosulfate (B) and a mixture of sulfate, sulfite and thiosulfate (C). Cells grown with sulfate serve as reference state. Benzoate was used as organic substrate for growth.

### Part III: Dissemination of BssA-like proteins among alkylbenzene-, 2-methylnaphthalene- and naphthalene-degrading sulfate-reducing bacteria

The catalytic subunit of benzylsuccinate synthase (BssA) was tentatively assigned in protein extract of *D. toluolica* Tol2 as major toluene-induced protein on SDS-polyacrylamide gels. Protein extracts from several other sulfate-reducing bacteria capable of anaerobically degrading toluene, *m*-xylene, *o*-xylene, 2-methylnaphthalene and naphthalene were analyzed by SDS-PAGE, MS/MS analysis, and 1D DIGE to detect differential formation of BssA-like proteins. Bands representing candidates for BssA-like proteins were detected in cells of sulfate-reducing bacteria grown with toluene, *m*-xylene, *o*-xylene and 2-methylnaphthalene with approximate molecular size of 100 kDa. These bands were absent in cells grown with benzoate or naphthalene (Fig. 23). MS/MS analysis of the excised bands allowed matching of peptide fragments to *in silico* predicted ones from BssA of *Thauera aromatica* K172 and strain EbN1 (Tab. 14). However, matching of peptides from NaphS2, NaphS3 and NaphS6 were not conclusive. Very recent availability of complete *bssA* gene sequences from all three strains (R. Reinhardt, MPI-Berlin) allowed unambiguous identification of the BssA-like protein bands with sequence coverage for matched peptides of about 50% (Fig. 24). The phylogenetic distinctiveness of the three new BssA proteins from all other known BssA proteins explains the inclusive earlier identification results. Analysis of fold-changes in abundance by 1D DIGE revealed that BssA-like proteins were significantly up-regulated (Fig. 25; Tab. 15).

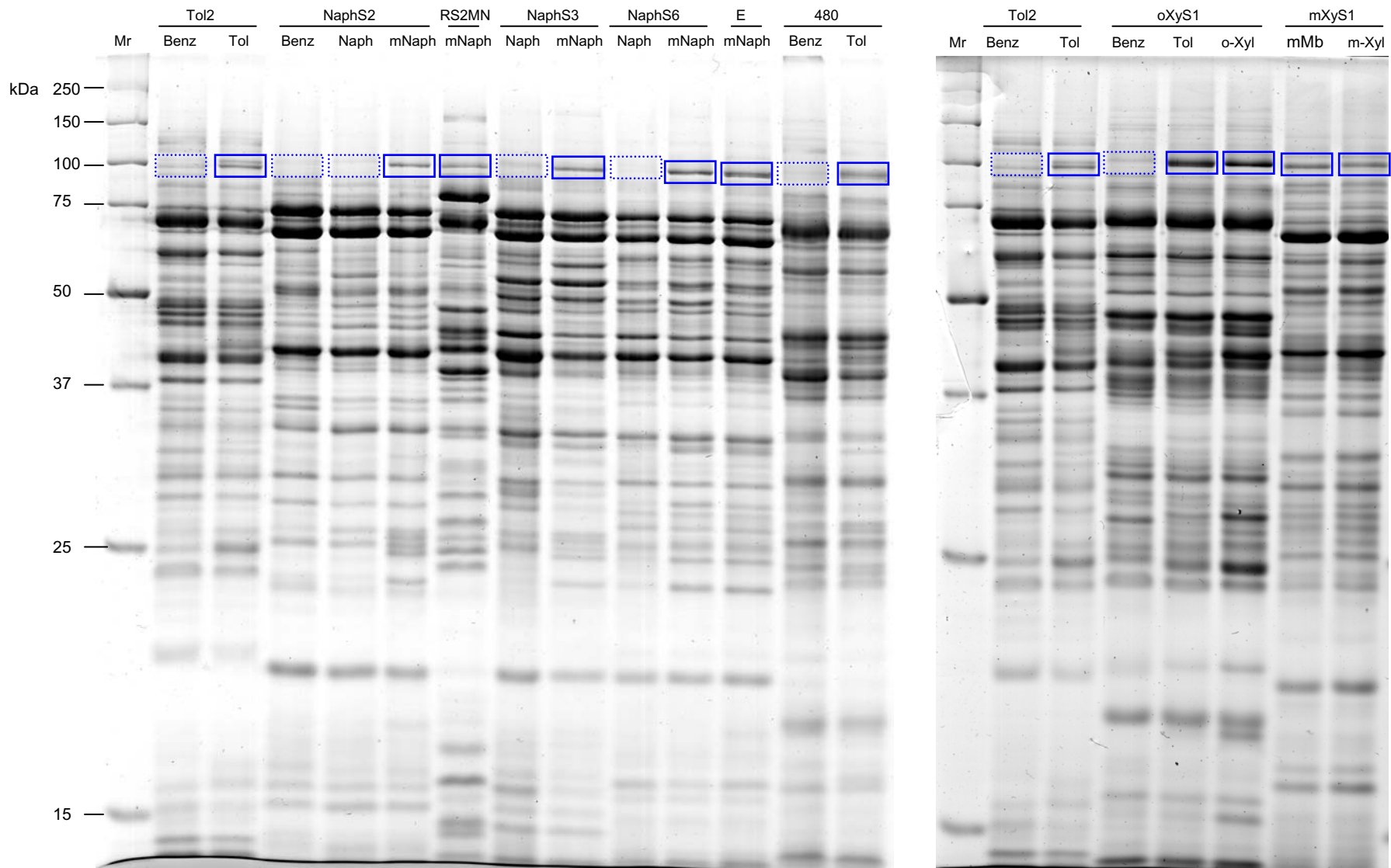

Fig. 23: SDS-PAGE of protein extracts from sulfate-reducing bacteria grown with alkylbenzenes, naphthalene, and methylnaphthalene. Strains: *D. toluolica* Tol2; NaphS2; RS2MN; NaphS3; NaphS6; *Desulfosarcina cetonica* strain 480; oXyS1; mXyS1; and enrichment culture (E). Growth substrates: Benz, benzoate; Tol, toluene, Naph, naphthalene; mNaph, 2-methylnaphthalene; o-Xyl, *o*-xylene; m-Xyl, *m*-xylene; mMb, *m*-methylbenzoate. BssA-like proteins are indicated by blue boxes, with dashed boxes indicate their absence. Mr, molecular mass marker. Protein load was 30  $\mu$ g per lane and the gels were stained with Coomassie G250.

Tab. 14: Numbers of MS-generated peptide fragments of the tentative BssA-like proteins tentatively matching to BssA from *Thauera aromatica* strain K172 and strain EbN1.

Organism	Substrate	No. of detected peptides [K172] <sup>a</sup>	± Da <sup>b</sup>	No. of detected peptides [EbN1] <sup>c</sup>	± Da
Alkybenzene-degraders					
<i>D. toluolica</i> Tol2	Toluene	10	0,7456	6	0,2900
	Toluene	5	0,6311	5	0,2903
<i>Desulfoarcina cetonica</i> 480	Toluene	9	0,4089	7	0,2792
Strain oXyS1	Toluene	10	0,6132	5	0,2349
	<i>o</i> -Xylene	7	0,3881	6	0,3319
Strain mXyS1	<i>m</i> -Xylene	5	0.3155	-	-
	<i>m</i> -Methylbenzoate	7	0.2825	5	0,2351
Methylnaphthalene-degraders					
Strain NaphS2	2-Methylnaphthalene	5	0,2032	6	0,2888
RS2MN enrichment	2-Methylnaphthalene	6	0,3521	-	-
Strain NaphS3	2-Methylnaphthalene	-	-	4	0,2288
Strain NaphS6	2-Methylnaphthalene	5	0,1866	5	0,3202
Enrichment culture	2-Methylnaphthalene	-	-	5	0,2084

<sup>a</sup>Number of peptides similar to those from BssA of *Thauera aromatic* strain K172

<sup>b</sup>Average difference between the calculated masses and the observed masses of the matched peptides

<sup>c</sup>Number of detected peptides similar those from BssA of strain EbN1

	10	20	30	40	50	60	70	80
NaphS2	MQENVALKIS	EETPGSTERI	QFLYDCRQWK	<u>HVAGGMYMRP</u>	<u>EVKVGVIARAR</u>	<u>LLTESYKETR</u>	GESEMIRRAK	GLDHVLENYP
NaphS3	MQENVALKIS	EETPGSTERI	QFLYDCRQWK	<u>HVAGGMYMRP</u>	<u>EVKVGVIARAR</u>	<u>LLTESYKETR</u>	GESEMIRRAK	GLDHVLENYP
NaphS6	MQENVALK <b>I</b> A	EETPGSTERI	QFLYDCRQWK	<u>HVAGGMYMRP</u>	<u>EVKVGVIARAR</u>	<u>LLTESYKETR</u>	GESEMIRRAK	GLDH <b>I</b> LENYP
	90	100	110	120	130	140	150	160
NaphS2	IFINDEEFIV	GDAENPDTL	AIFPEMGFFP	TIDIVEDPEL	MDDDIRDEAR	<u>EIAMFWKPLG</u>	<u>LQDKCMPYYD</u>	QHEIDIATPW
NaphS3	IFINDEEFIV	GDAENPDTL	AIFPEMGFFP	TIDIVEDPEL	MDDDIRDEAR	<u>EIAMFWKPLG</u>	<u>LQDKCMPYYD</u>	QHEIDIATPW
NaphS6	IFINDEEF <b>V</b> V	GDAENPDTL	AIFPEMGFFP	TIDIVEDPEL	MDDDIRDEAR	<u>EIAMFWKPLG</u>	<u>LQDKCMPYYD</u>	QHEIDIATPW
	170	180	190	200	210	220	230	240
NaphS2	TIVDVPPFIA	NYMSVCPAYM	SVLEDGLLGR	IKSAEENIEK	<u>AFVKLRAYPW</u>	NGPENMPLMD	<u>QIDVWRAMII</u>	ADKAVIKWAR
NaphS3	TIVDVPPFIA	NYMSVCPAYM	SVLEDGLLGR	IKSAEENIEK	<u>AFVKLRAYPW</u>	NGPENMPLMD	<u>QIDVWRAMII</u>	ADKAVIKWAR
NaphS6	TIVDVPPFIA	NYMSVCPAYM	SVLEDGLLGR	IK <b>S</b> SEENIA <b>K</b>	<u>AFVKLRAYPW</u>	NGPENMPLMD	<u>QIDVWR</u> <b>S</b> MI <b>I</b>	ADKAVIKWAR
	250	260	270	280	290	300	310	320
NaphS2	<u>RYSRLAKIVA</u>	<u>ENFDLSDSVQ</u>	<u>GAEERKNELL</u>	<u>EISDICYRMP</u>	<u>AEPKAGFKDA</u>	<u>MQSKWVYLV</u>	<u>CHSLERYSSG</u>	<u>YAHLEDRLMW</u>
NaphS3	<u>RYSRLAKIVA</u>	<u>ENFDLSDSVQ</u>	<u>GAEERKNELL</u>	<u>EISDICYRMP</u>	<u>AEPKAGFKDA</u>	<u>MQSKWVYLV</u>	<u>CHSLERYSSG</u>	<u>YAHLEDRLMW</u>
NaphS6	<u>RY<b>G</b>RLAKI<b>I</b>A</u>	<u>ENFDLSDSV<b>L</b></u>	<u>GA<b>E</b>GRKNELL</u>	<u>EISDICYRMP</u>	<u>AEPKAGFKDA</u>	<u>MQSKWVYLV</u>	<u>CHSLERYSSG</u>	<u>YAHLEDRLMW</u>
	330	340	350	360	370	380	390	400
NaphS2	<u>PYYKASVIDK</u>	<u>TAQPMTRDEA</u>	<u>IQLVELERLK</u>	<u>VCERGVAKGR</u>	<u>AHREGQPGAN</u>	<u>DLHIITIGGL</u>	<u>DENGNDATND</u>	<u>LTNVILEASL</u>
NaphS3	<u>PYYKASVIDK</u>	<u>TAQPMTRDEA</u>	<u>IQLVELERLK</u>	<u>VCERGVAKGR</u>	<u>AHREGQPGAN</u>	<u>DLHIITIGGL</u>	<u>DENGNDATND</u>	<u>LTNVILEASL</u>
NaphS6	<u>PYYKASVIDK</u>	<u>TAQPMTRDEA</u>	<u>I<b>E</b>L<b>I</b>ECERLK</u>	<u>VCERGVAKGR</u>	<u>AHREGQPGAN</u>	<u>DLHIITIGGL</u>	<u>DENGNDATND</u>	<u>LTNA<b>I</b>LEASL</u>
	410	420	430	440	450	460	470	480
NaphS2	<u>NIRTPPEPSLG</u>	<u>FRYSPKINAK</u>	<u>TRRLVFENIA</u>	<u>AGFGFPSIKH</u>	<u>EEKNTRQMLE</u>	<u>HYKVPPDEAA</u>	<u>HWALVLCMAP</u>	<u>GVSKRRGLQK</u>
NaphS3	<u>NIRTPPEPSLG</u>	<u>FRYSPKINAK</u>	<u>TRRLVFENIA</u>	<u>AGFGFPSIKH</u>	<u>EEKNTRQMLE</u>	<u>HYKVPPDEAA</u>	<u>HWALVLCMAP</u>	<u>GVSKRRGLQK</u>
NaphS6	<b>S</b> <u>VRTPEPSLG</u>	<u>FRYSPKINAK</u>	<u>TRRLVFENIA</u>	<u>AGFGFPSIKH</u>	<u>EEKNTRQMLE</u>	<u>HYKVPPDEAA</u>	<u>HWALVLCMAP</u>	<u>GV<b>G</b>KRRGLQK</u>
	490	500	510	520	530	540	550	560
NaphS2	<u>TRTEGGGLIW</u>	<u>IDKCCEIAFY</u>	<u>DGFDHSFANI</u>	<u>QTGPKTGDAT</u>	<u>KFKTFEELFE</u>	<u>AFEKQVEFAT</u>	<u>ALHYRNKDVT</u>	<u>RRAEIKFIES</u>
NaphS3	<u>TRTEGGGLIW</u>	<u>IDKCCEIAFY</u>	<u>DGFDHSFANI</u>	<u>QTGPKTGDAT</u>	<u>KFKTFEELFE</u>	<u>AFEKQVEFAT</u>	<u>ALHYRNKDVT</u>	<u>RRAEIKFIES</u>
NaphS6	<u>TRTEGGGLIW</u>	<u>IDKCCEIAFY</u>	<u>DGFDHSFANI</u>	<u>QTGPKTGDAT</u>	<u>KFKTFEELFE</u>	<u>AFEKQVEFAT</u>	<u>ALHYRNKDVT</u>	<u>RRAEIKFIES</u>
	570	580	590	600	610	620	630	640
NaphS2	<u>PFVASLDDAC</u>	<u>MDDGVGAFVD</u>	<u>KTYPNPWNNT</u>	<u>PGEQTAADSL</u>	<u>AAVKKLVFDD</u>	<u>KKYTMEEVNV</u>	<u>AMKANFDGYE</u>	<u>EMRKDMLAAP</u>
NaphS3	<u>PFVASLDDAC</u>	<u>MDDGVGAFVD</u>	<u>KTYPNPWNNT</u>	<u>PGEQTAADSL</u>	<u>AAVKKLVFDD</u>	<u>KKYTMEEVNV</u>	<u>AMKANFDGYE</u>	<u>EMRKDMLAAP</u>
NaphS6	<u>PFVASLDDAC</u>	<u>MDDGVGAFVD</u>	<u>KTYPNPWNNT</u>	<u>PGEQTAADSL</u>	<u>AAVKKLVFDD</u>	<u>KKYTMEEVNV</u>	<u>AMKAN<b>F</b>EG<b>H</b>E</u>	<u>EMRKDMLAAP</u>
	650	660	670	680	690	700	710	720
NaphS2	<u>KWGNDDPYVD</u>	<u>EIGERVFKMV</u>	<u>ADKLMQTTY</u>	<u>SGMHPGNGP</u>	<u>TVSTFATRAP</u>	<u>RIGALPFGKL</u>	<u>HGEVLHDGGS</u>	<u>SPYVGLDKKG</u>
NaphS3	<u>KWGNDDPYVD</u>	<u>EIGERVFKMV</u>	<u>ADKLMQTTY</u>	<u>SGMHPGNGP</u>	<u>TVSTFATRAP</u>	<u>RIGALPFGKL</u>	<u>HGEVLHDGGS</u>	<u>SPYVGLDKKG</u>
NaphS6	<u>KWGNDDPYVD</u>	<u>EIGER<b>I</b>F<b>T</b>MV</u>	<u>ADKLMQTTY</u>	<u>SGMHPGNGP</u>	<u>TVSTFATRAP</u>	<u>RIGALPFGKL</u>	<u>HGEVLHDGGS</u>	<u>SPYVGLDKKG</u>
	730	740	750	760	770	780	790	800
NaphS2	<u>PTAVLKSAVAH</u>	<u>IPYDRYKGVQ</u>	<u>FNQRLPVSIM</u>	<u>RGDKGFQVWS</u>	<u>AYMKAWHDLN</u>	<u>IDHVQFNVVE</u>	<u>TKDMLEAQKE</u>	<u>PEKWESLIVR</u>
NaphS3	<u>PTAVLKSAVAH</u>	<u>IPYDRYKGVQ</u>	<u>FNQRLPVSIM</u>	<u>RGDKGFQVWS</u>	<u>AYMKAWHDLN</u>	<u>IDHVQFNVVE</u>	<u>TKDMLEAQKE</u>	<u>PEKWESLIVR</u>
NaphS6	<u>PTAVLKSAVAH</u>	<u>IPYDRYKGVQ</u>	<u>FNQRLPVS<b>V</b>M</u>	<u>RGDKGFQV<b>V</b>T</u>	<u>AYM<b>F</b>W<b>H</b>DLN<b>n</b></u>	<u>IDHVQ<b>F</b>N<b>V</b>VD</u>	<u>TKDMLEAQKE</u>	<u>PEKW<b>Q</b>S<b>M</b>IVR</u>
	810	820						
NaphS2	<u>IAGYSARFVS</u>	<u>LPKNAQDAII</u>	<u>ARNEQQIG</u>					
NaphS3	<u>IAGYSARFVS</u>	<u>LPKNAQDAII</u>	<u>ARNEQQIG</u>					
NaphS6	<u>IAGYSARFVS</u>	<u>LP<b>R</b>NAQ<b>D</b>S<b>I</b>I</u>	<u>ARTEQ<b>P</b>V<b>G</b></u>					

Fig. 24: Mapping of peptides analyzed by mass spectrometry (MS) from corresponding protein bands specific for anaerobic growth of the sulfate-reducing strains NaphS2, NaphS3 and NaphS6 with 2-methylnaphthalene against the protein sequences deduced from *bssA* homologous genes identified in the same three strains. Matched peptide masses (MS-generated) are underlined and matched peptide sequences (MS/MS-generated) are indicated by grey background. Non-identical amino acid residues are marked in bold. The conserved glycine residue assumed to be involved in catalysis is boxed.

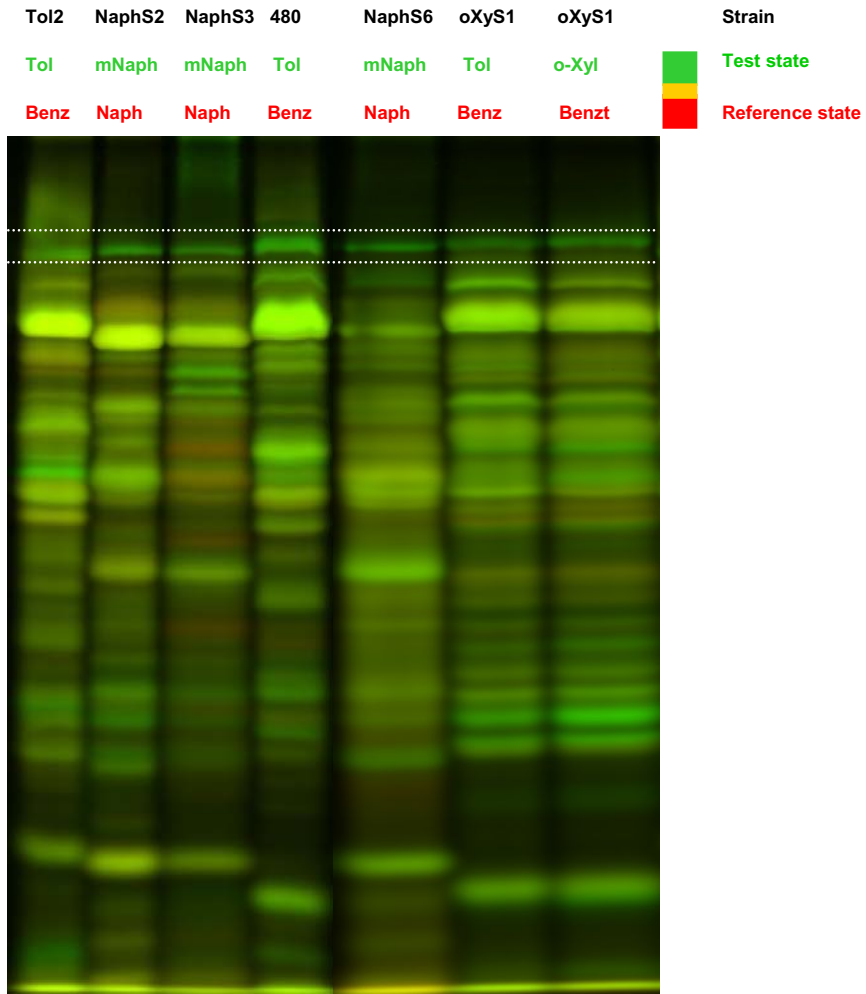

Fig. 25: 1D DIGE of protein extracts from alkylbenzene- and naphthalene-degrading sulfate-reducing bacteria. Overlay image represents the Cy3-labeled test states and Cy5-labeled reference states. Dashed line indicates bands of putative BssA-like proteins.

Tab. 15: Fold-changes in abundance of putative BssA-like proteins in the tested aromatic-hydrocarbon degrading sulfate-reducing bacteria. Only strains that have reference-state compounds were analyzed.

<b>Organism</b>	<b>Test-state substrate</b>	<b>Reference-state substrate</b>	<b>Fold-change in protein abundance</b>
<i>D. toluolica</i> Tol2	Toluene	Benzoate	40,1
<i>Desulfoarcina cetonica</i> 480	Toluene	Benzoate	10,0
Strain oXyS1	Toluene	Benzoate	5,6
	<i>o</i> -Xylene	Benzoate	17,8
Strain NaphS2	2-Methylnaphthalene	Naphthalene	17,4
Strain NaphS3	2-Methylnaphthalene	Naphthalene	7,1
Strain NaphS6	2-Methylnaphthalene	Naphthalene	6,8



## D Discussion

### D. 1. Anaerobic activation of toluene and *p*-cresol

Anaerobic activation of toluene was first described for denitrifying bacteria (Biegert et al., 1996). The reaction proceeds via addition of fumarate to the methyl group of toluene yielding benzylsuccinate (Biegert et al., 1996; Beller and Spormann, 1997a, 1997b). Benzylsuccinate formation appears to be an ideal initial reaction for anaerobic toluene metabolism under energy-limited conditions since the reaction is exergonic ( $\Delta G^{0'} = -40 \text{ KJ mol}^{-1}$ ; Rabus and Heider, 1998). Thus, the same activation principle of toluene is shared by denitrifiers and sulfate-reducing bacteria despite the large difference in energy yield from toluene oxidation coupled to denitrification ( $\Delta G^{0'} = -3554 \text{ kJ per mole toluene}$ ) and sulfate reduction ( $\Delta G^{0'} = -205.2 \text{ kJ/mol toluene}$ ). The formation of benzylsuccinate is catalyzed by the glycyl radical enzyme benzylsuccinate synthase. Earlier experiments with the denitrifying *Thauera aromatica* K172 showed that BssA (catalytic subunit of benzylsuccinate synthase) can be resolved on SDS-polyacrylamide gels with a molecular size of 94 kDa (Leuthner et al., 1998; Rabus and Heider, 1998). Moreover, the presence of oxygen leads to a breakage of the peptide bond at the glycine residue involved in catalysis, whereby the oxygenolytic truncated product (90 kDa) is formed (Leuthner et al., 1998). This oxygenolytic cleavage results in the presence of a characteristic double band on SDS-PAGE. Based on these literature data, the tentative BssA and its oxygenolytic truncated product could be detected on our SDS-polyacrylamide gels. The peptide fragment fingerprinting of both bands by MS/MS analysis confirmed their similarity to the BssAs of both denitrifying strains; *Thauera aromatica* K172 and strain EbN1. Furthermore, specific up-regulation of BssA up to 40-fold reflects the physiological significance of BssA formation in *D. toluolica* Tol2.

A BssA-like protein could also be detected in *p*-cresol-grown cells of *D. toluolica* Tol2. Peptide fragment fingerprinting allowed assigning of three sequences to BssA of *Thauera aromatica* K172. This may indicate that the initial reaction of anaerobic *p*-cresol catabolism in *D. toluolica* Tol2 could, in analogy to toluene, involve the addition to fumarate yielding 4-hydroxybenzylsuccinate. If a common reaction principle is shared for activating toluene and *p*-cresol, both steps may require different isoenzymes for their conversion to the respective arylsuccinates due to structural differences of the aromatic substrates (Fig. 26). This may explain the low number of peptide fragments of BssA-like protein from *p*-cresol-adapted

cells similar to peptide fragments available in the public database. The BssA-like proteins in toluene- and *p*-cresol-adapted cells displayed markedly differing fold-changes in abundance (4.5-fold in *p*-cresol- versus 40.1-fold in toluene-grown cells), indicating that *p*-cresol may just act as gratuitous inducer of the toluene catabolic genes in *D. toluolica* Tol2.

Anaerobic *p*-cresol degradation was first elucidated in *Pseudomonas putida* (Hopper and Taylor, 1977) and has also been described in several *Thauera* and *Azoarcus*-like species (Rudolphi et al., 1991) suggesting hydroxylation reactions for activation. The enzyme *p*-cresol methylhydroxylase performs two sequential oxidation reactions at the methyl group of *p*-cresol, yielding *p*-hydroxybenzaldehyde as reaction product (Hopper and Taylor, 1977; Cunane et al., 2000). Anaerobic activation of *p*-cresol by sulfate-reducing bacteria was studied in *Desulfotomaculum* strain Groll (Londry et al., 1999) suggesting that these bacteria also hydroxylate the methyl group of *p*-cresol as the initial reaction step. However, *in vitro* and physiological studies with *Desulfobacterium cetonicum* (Müller et al., 2001) demonstrated the formation of 4-hydroxybenzylsuccinate during growth with *p*-cresol (Müller et al., 2001) indicating activation of *p*-cresol of via addition to fumarate. More importantly, no evidence of *p*-cresol methylhydroxylase was detected.

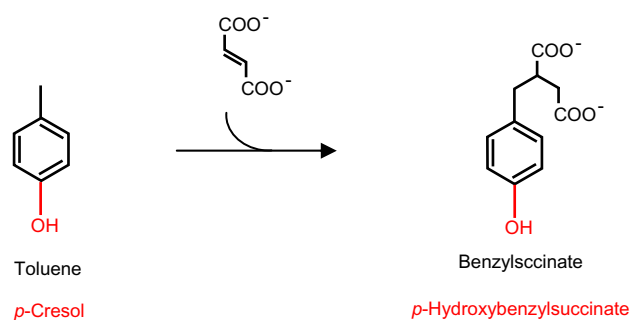

Fig. 26: The fumarate-dependent reaction for activation of toluene and possibly of *p*-cresol in *D. toluolica* Tol2.

## D. 2. Regulation of anaerobic catabolism of aromatic compounds coupled to sulfate reduction

*D. toluolica* Tol2 can grow anaerobically with the aromatic compounds toluene, benzoate, phenylacetate, *p*-cresol, *p*-hydroxybenzaldehyde and *p*-hydroxybenzoate as sole electron donor and carbon source. In denitrifiers, anaerobic catabolism of these aromatic compounds involves the following main principles (Boll et al., 2002; Rabus et al., 2004; Widdel et al., 2004). Firstly, they are converted to the central intermediate benzoyl-CoA via so-called peripheral pathways. Secondly, benzoyl-CoA is reductively dearomatized by an ATP-dependent reductase, hydrolytically cleaved and then degraded to the level of acetyl-CoA. Thirdly, the latter is completely oxidized to CO<sub>2</sub> via the TCA cycle. Due to their low energy yield, sulfate-reducing bacteria are expected to employ a less ATP-consuming reaction for dearomatization of benzoyl-CoA. The complete degradation of acetyl-CoA to CO<sub>2</sub> is also different in sulfate-reducing bacteria since C<sub>1</sub>/CO dehydrogenase pathway is usually employed for complete oxidation (Fig. 27). In the present study, regulation of the respective aromatic catabolic pathways in substrate-adapted cells of *D. toluolica* Tol2 was analyzed by 2D DIGE. The regulated proteins were identified by MS(/MS) analysis. The regulation of the individual catabolic pathways to the level of benzoyl-CoA is first discussed:

### a) Toluene

Activation of toluene in strain *D. toluolica* Tol2 proceeds via the radical addition to fumarate (Rabus and Heider, 1998; section D.1). This reaction is evident from the BssA-like protein specifically detected in toluene-adapted cells by SDS-PAGE. A BssA-like protein could not be detected on 2DE gels, probably due to precipitation of the protein during 1<sup>st</sup> dimension separation. Further degradation of benzylsuccinate proceeds via  $\beta$ -oxidation to benzoyl-CoA and succinyl-CoA (Heider, 2007). A number of toluene-specific proteins could be resolved by 2D DIGE. These proteins represent candidates for enzymes of the  $\beta$ -oxidation pathway of benzylsuccinate. However, only one protein (thiolase) could be identified. It could be involved in the last step of the  $\beta$ -oxidation of benzylsuccinate, i.e. thiolytic cleavage of benzylsuccinyl-CoA to benzoyl-CoA and succinyl-CoA. However, low similarity between the analyzed proteins involved in toluene degradation in *D. toluolica* Tol2 with the enzyme sequences available in the public databases is probably hindering protein identification at present.

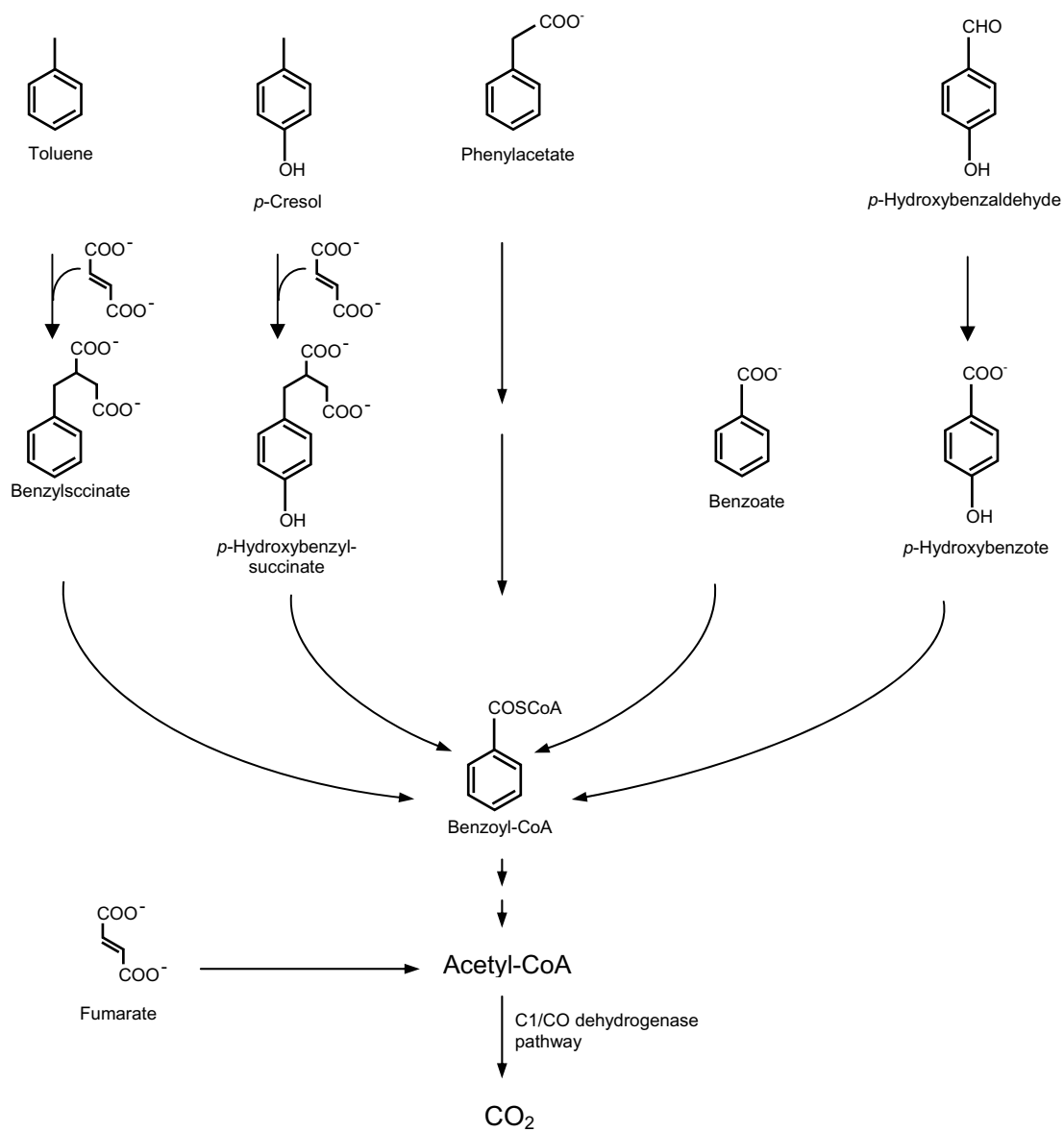

Fig. 27: General routes of complete anaerobic oxidation (to CO<sub>2</sub>) of aromatic compounds in sulfate-reducing *D. toluolica* Tol2. The upper pathways to the level of benzoyl-CoA are shared between sulfate reducers and denitrifiers. However, different mechanisms for benzoyl-CoA degradation to the level of acetyl-CoA are suggested for sulfate reducers. Terminal degradation to CO<sub>2</sub> proceeds via C1/CO dehydrogenase pathway.

## b) Benzoate

2D DIGE analysis revealed 4 benzoate-specific protein spots. This number is the lowest among the detected specifically up-regulated protein spots. This is plausible since only a single benzoyl-CoA ligase catalyzed reaction is needed to activate benzoate to benzoyl-CoA. Isoenzymes of benzoyl-CoA ligase are known from different denitrifiers (e.g. Schühle et al., 2003) as well as sulfate-reducing bacteria (Peters et al., 2004). In the latter case, the enzyme was separated as a single 59 KD-subunit from the sulfate-reducing *Desulfococcus multivorans* (Peters et al., 2004). Similarity in molecular weight and exclusive formation in the presence of benzoate suggests the detected protein(s) to be related to benzoyl-CoA ligase. Nevertheless, MS(/MS) analysis could not confirm any similarity of the tentative benzoyl-CoA ligase from *D. toluolica* Tol2 with a respective enzyme of any other bacterium, suggesting an early phylogenetic separation.

## c) Phenylacetate

In denitrifiers, phenylacetate is suggested to be activated to phenylacetyl-CoA by phenylacetate-CoA ligase (Mohammed and Fuchs, 1993). The methylene carbon of phenylacetyl-CoA is oxidized by phenylacetyl-CoA:acceptor oxidoreductase to keto group of phenylglyoxylate. The latter is decarboxylated to benzoyl-CoA (Schneider and Fuchs, 1998). Even though a number of phenylacetate specific protein spots could be detected by 2D DIGE, MS-based analysis of these proteins could not confirm homology to any of the above mentioned enzymes. This may indicate low significance similarity or novelty of the enzymes involved.

## d) *p*-Cresol

Based on the activation reaction of *p*-cresol (discussed earlier in section D.1), two possible catabolic pathways to the level of benzoyl-CoA are suggested:

(i) Hydroxylation of the methyl-group to *p*-hydroxybenzaldehyde via hydroxylation by *p*-cresol methylhydroxylase and further to *p*-hydroxybenzoate by hydroxybenzaldehyde dehydrogenase (Hopper and Taylor, 1977; Cunane et al., 2000). Interestingly, methylhydroxylation was recently demonstrated to also occur in the strictly anaerobe *Geobacter metallireducens* (Peters et al., 2007)

(ii) Radical addition to fumarate yielding 4-hydroxybenzylsuccinate in a reaction analogous to toluene activation. 4-Hydroxybenzylsuccinate is further degraded via  $\beta$ -oxidation to 4-hydroxybenzoyl-CoA and the latter is reductively dehydroxylated to benzoyl-CoA (Müller et al., 2002).

Detection of a possible thiolase in our 2D DIGE gels as a highly up-regulated *p*-cresol-specific protein could argue in favor of the second possible pathway, i.e., degradation of toluene via benzylsuccinate. The suggested thiolytic cleavage of 4-hydroxybenzylsuccinyl-CoA to 4-hydroxybenzoyl-CoA and succinyl-CoA requires 4-hydroxybenzylsuccinyl-CoA thiolase. The possible *p*-cresol-specific thiolase was detected in two isoforms with molecular weight of (41,4 kDa) and isoelectric point (7,1). Strongest evidence for the benzylsuccinate-involving pathway comes from specific formation of a BssA-like protein (see Fig. 9) and *in vitro* activity (Rabus and Heider, 1998).

#### e) *p*-Hydroxybenzaldehyde

Transformation of *p*-hydroxybenzaldehyde to *p*-hydroxybenzoate requires dehydrogenation by *p*-hydroxybenzaldehyde dehydrogenase as suggested for denitrifiers (Bossert et al., 1989). Further transformation of *p*-hydroxybenzoate is discussed below. One protein related to NADH oxidase could be identified among the *p*-hydroxybenzaldehyde-specific proteins in *D. toluolica* Tol2. The enzyme could be involved in dehydrogenation of *p*-hydroxybenzaldehyde.

#### f) *p*-Hydroxybenzoate

Anaerobic degradation of *p*-hydroxybenzoate is initiated by activation to 4-hydroxybenzoyl-CoA catalyzed by a specific CoA ligase (Gibson et al., 1994). 4-Hydroxybenzoyl-CoA is then reductively dehydroxylated to benzoyl-CoA by a *p*-hydroxybenzoyl-CoA reductase (Heider et al., 1998). According to this pathway in denitrifiers, *p*-hydroxybenzoate represents a common intermediate shared with the degradation pathway for *p*-hydroxybenzaldehyde. This may explain the absence of specifically up-regulated proteins in case of *p*-hydroxybenzoate, and detection of only commonly up-regulated protein spots since proteins from the *p*-hydroxybenzaldehyde were included in our analysis. However, it should also be considered that *p*-hydroxybenzoate-CoA ligase and *p*-hydroxybenzoate-CoA reductase may simply not be detectable under the applied

electrophoretic conditions. Such a scenario was very recently reported for aromatic-compound degrading, denitrifying strain EbN1 (Wöhlbrand et al, 2007).

Even though *D. toluolica* Tol2 is expected to share most peripheral degradation pathways with denitrifiers, further degradation of benzoyl-CoA to the level of acetyl-CoA should be fundamentally different. In denitrifying *T. aromatica* K172, the initial reaction of anaerobic benzoyl-CoA degradation is an ATP-consuming reductive dearomatization. The involved enzyme, benzoyl-CoA reductase couples a two-electron reduction of benzoyl-CoA with ferredoxin as electron donor to a stoichiometric hydrolysis of two ATP, yielding cyclohexa-1,5-diene-1-carbonyl-CoA (Boll et al., 1997). Energy-limited bacteria such as sulfate-reducing bacteria probably cannot afford the required ATP investment, necessitating alternative reaction principles for dearomatization of benzoyl-CoA.

Proteins of *D. toluolica* Tol2 which are up-regulated during growth with any of the tested aromatic compounds represent candidates of enzymes involved in the degradation pathway of benzoyl-CoA to the level of acetyl-CoA. Proteins were analyzed and the PMFs/PFFs were searched against the public database. Remarkably, none of the commonly up-regulated protein spots could be identified. This could be indicative of (i) low sequence similarity despite of similar enzymatic function or (ii) the novelty of the enzymes involved in the central aromatic catabolic pathways in *D. toluolica* Tol2.

The sulfate-reducing *Desulfococcus multivorans* strictly requires the trace elements molybdenum and selenium during anaerobic growth with benzoate but not with aliphatic carboxylic acids (Peters et al., 2004). Accordingly, <sup>75</sup>Se-labeled benzoate-induced proteins were detected including an unknown 30 kDa selenocysteine-containing protein. Notably, no molybdenum- and/or selenocysteine-containing enzyme is involved in anaerobic benzoate metabolism in denitrifiers. Analysis of gene clusters involved in anaerobic benzoate catabolism of *Geobacter metallireducens* (Wischgoll et al., 2005), demonstrated the absence of genes for an ATP-dependent benzoyl-CoA reductase as known from denitrifiers. These findings suggest that key processes in benzoyl-CoA reduction in sulfate-reducing bacteria appears to be catalyzed by a set of completely different protein compounds comprising putative molybdenum and selenocysteine containing enzymes. Following different dearomatization reactions, facultative and strictly anaerobic bacteria probably used a common further degradation pathway, as indicated by *in vitro* demonstration of cyclohexa-1,5-diene-1-carbonyl-CoA hydratase activities in extracts of benzoate-grown cells of *Geobacter metallireducens* (iron reducing), *Syntrophus aciditrophicus* (fermenting) and *Desulfococcus multivorans* (sulfate-reducing) (Peters et al., 2007).

The complete oxidation of acetyl-CoA to CO<sub>2</sub> in *D. toluolica* Tol2 proceeds via the C<sub>1</sub>/CO dehydrogenase pathway (Fig. 28). Previous activity measurements of carbon monoxide dehydrogenase and formate dehydrogenase suggested that the C<sub>1</sub>/CO dehydrogenase pathway is responsible for complete oxidation in *D. toluolica* Tol2 (Rabus et al., 1993). The pathway involves cleavage of acetyl-CoA into a bound CO and a bound methyl group. Both C1-units are then oxidized to CO<sub>2</sub> (Schauder et al., 1986; Spormann and Thauer, 1988). The carrier of the methyl group in *Desulfotomaculum acetoxidans* is tetrahydrofolate (Spormann and Thauer, 1988). The conversion of formyl-tetrahydrofolate to free formate is associated with ATP synthesis.

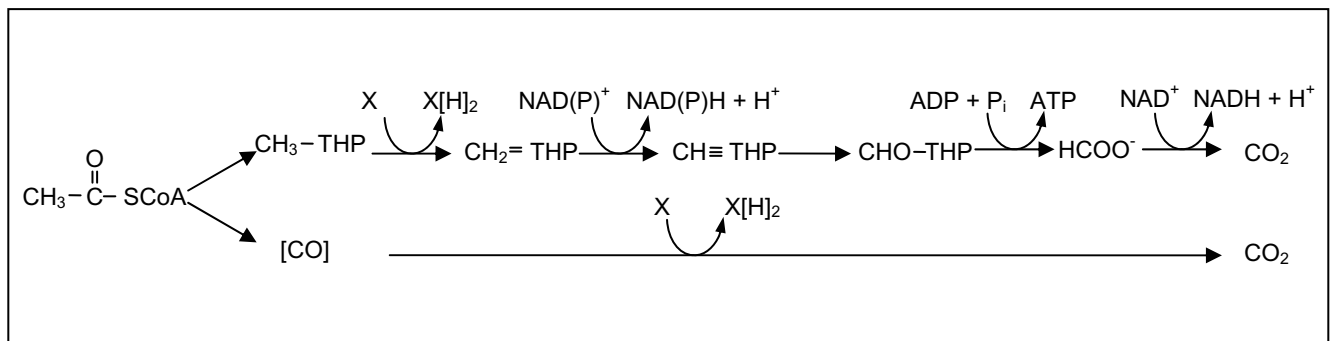

Fig. 28: Complete oxidation of acetyl-CoA to CO<sub>2</sub> via the C<sub>1</sub>/CO dehydrogenase pathway in sulfate-reducing bacteria. THP is tetrahydrofolate in *Desulfotomaculum acetoxidans*, and tetrahydropteroyltetraglutamate in *Desulfobacterium autotrophicum* (Rabus et al., 2004).

Analysis of the proteome of *D. toluolica* Tol2 allowed detection of non-regulated enzyme subunits indicating their role as ‘housekeeping’ enzymes. These include subunits of key enzymes in the pathway for dissimilatory sulfate reduction: AprA, DsrA and DsrB. The substrate-dependent regulation will be discussed in the following section. Formate-tetrahydrofolate ligase was also detected.



### D. 3. Regulation of dissimilatory sulfate reduction pathway by different electron acceptors

*D. toluolica* Tol2 couples oxidation of various aromatic compounds to dissimilatory reduction of sulfate. In the present proteomic analysis, subunits of key enzymes of sulfate reduction pathway were identified (AprA, DsrA and DsrB). Interestingly, quantitative 2D DIGE analysis revealed unchanged abundances of these proteins irrespective of which aromatic-compound degradation pathway was operative. The question whether the dissimilatory sulfate reduction pathway is regulated by the type of electron acceptor applied was then investigated. Notably, AprA, DsrA and DsrB also did not display changes in protein abundances in response to different types of electron acceptors (i.e. sulfate, sulfite and thiosulfate). Thus the targeted enzymes of the dissimilatory sulfate reduction pathway are apparently constitutively formed by *D. toluolica* Tol2 under all tested conditions. Thus far, most regulatory studies were concerned with the assimilatory sulfate reduction in plants (e.g. Farago and Brunold, 1990; Takahashi et al., 1997) rather than with the dissimilatory sulfate reduction in bacteria (e.g. Neretin et al., 2003). In the latter study, expression of dissimilatory (bi)sulfite reductase (DSR) was quantified in *Desulfobacterium autotrophicum* in response to different growth conditions (lactate and sulfate/or thiosulfate, H<sub>2</sub>/CO<sub>2</sub> and sulfate and fermentation). DSR mRNA was present under all studied conditions indicating its constitutive expression (Neretin et al., 2003). An adaptive strategy of *D. autotrophicum* based on constitutive *dsr* expression may lead to overproduction of the enzyme, in order to efficiently respond to changes in environmental conditions.

The physiological aspects of growth of *D. toluolica* Tol2 with different electron acceptors (sulfate, sulfite, thiosulfate and a mixture of the three) are discussed in the following.

#### a) Sulfate

Sulfate reduction to sulfide requires eight electrons, preceded by ATP-dependent activation of sulfate to APS. The reduction pathway involves a number of intermediates. Sulfate-reducing bacteria usually do not excrete the intermediate oxidation states, but only the final product sulfide. In case of *Desulfovibrio desulfuricans*, excretion of minor concentrations of sulfite and thiosulfate has been reported (Vainshtein et al., 1980; Fitz and Cypionka, 1990). The present study revealed that cultures of *D. toluolica* Tol2 did not excrete sulfite or thiosulfate during

anaerobic growth with benzoate and sulfate. Rather *D. toluolica* Tol2 produced stoichiometric amounts of sulfide during the course of incubation.

#### b) Sulfite

In addition to sulfate, *D. toluolica* Tol2 can utilize sulfite as terminal electron acceptor. Even though this trait is widespread among sulfate-reducing bacteria, few exceptions were reported. For instance, *Desulfotomaculum acetoxidans* (Widdel and Pfennig, 1981), *Desulfonema magnum* (Widdel et al., 1983) and *Desulfocella halophila* (Brandt et al., 1999) did not utilize sulfite in growth tests. Sulfite reduction is six electron step process, with no activation by ATP being required. The process may proceed by (i) direct reduction with six electrons by sulfite (or bisulfite) reductase without the formation of intermediates or (ii) sequential reduction via the trithionate pathway involving three consecutive two-electron steps and intermediate formation of trithionate and thiosulfate (Rabus, 2004). Thiosulfate was indeed detected during growth of *D. toluolica* Tol2 with sulfite. The observed thiosulfate formation could be of biological (assuming the trithionate pathway) or abiotic origin since sulfite may react with sulfide to form thiosulfate. Thiosulfate was detected during later growth stages. It has also to be considered, that benzoate or benzoic acid (pKa 4.19) has an *n*-octanol:water partition coefficient of 1.9 (EPA, 1996), characterizing it as membrane active compound. Thus, under the used conditions, thiosulfate may leak out of the cell.

Detection of sulfate (2,9 mM) during early growth is probably due to chemical rather than enzymatic transformation of sulfite. Sulfite, being a low stable compound, could be oxidized to sulfate by oxygen introduced during sample handling. Even though controls showed stable sulfite concentration over time, parallel detection of high sulfite and sulfate concentrations at the first time point raise the possibility of an analytical error.

#### c) Thiosulfate

Thiosulfate can also serve as terminal electron acceptor for *D. toluolica* Tol2. Higher sulfide was observed during growth of *D. toluolica* Tol2 with thiosulfate (5 mM) than with either sulfate or sulfite (both 5 mM). This results from the different stoichiometries of the involved reactions: sulfide:thiosulfate = 2:1 in contrast to sulfide:sulfate or sulfite = 1:1.

Thiosulfate reduction to sulfide does not require ATP activation and proceeds by two major steps: disproportionation of thiosulfate to sulfite and sulfide, followed by the reduction of sulfite to sulfide (Chambers and Trundiger, 1975). So far, disproportionation of thiosulfate has been demonstrated in *Desulfovibrio desulfuricans* (Ishimoto and Koyama, 1957), *Desulfotomaculum nigrificans* (Nakatsukasa and Akagi, 1969) and *Desulfovibrio vulgaris* (Haschke and Campbell, 1971). Detection of sulfate at the later growth phase may result from disproportionation of thiosulfate to sulfate and sulfide (eq. 1) assuming complete consumption of benzoate.



#### d) Mixture of electron acceptors

During anaerobic growth of *D. toluolica* Tol2 with benzoate and a mixture of the three different electron acceptors, a sequential consumption of electron acceptors could be observed in the following order: sulfite, thiosulfate and sulfate. Preferential consumption of sulfite and thiosulfate is expected since their reduction does not require an ATP-consuming activation step. However, sulfite is more reactive than thiosulfate and represents a direct intermediate in the sulfate reduction pathway.

The detected concentrations of sulfite (1.8 mM) and thiosulfate (3.9 mM) during early growth were lower than expected (5 mM). This discrepancy was not paralleled by an increase in another sulfur compound. Also the control experiment showed stable but low thiosulfate concentration. The reason for such discrepancies is still unclear. Analysis of sulfur compound mixtures is known to be associated with difficulties due to low stability of some sulfur compounds as well as complex equilibria formed by their auto-redox reactions (Koh and Okabe, 1994).

#### D. 4. Anaerobic activation of alkylbenzenes, 2-methylnaphthalene and naphthalene in sulfate-reducing bacteria

During the recent years evidence accumulated that radical addition of fumarate represents a widespread reaction principle for initial activation of toluene and other alkyl-substituted aromatic hydrocarbons under anoxic conditions (e.g. Widdel and Rabus, 2001; Winderl et al., 2007; Heider, 2007). E.g. formation of the respective arylsuccinates was also demonstrated for anaerobic degradation of *m*-xylene (e.g. Krieger et al., 1999), *o*-xylene (e.g. Beller and Spormann, 1997a) and 2-methylnaphthalene (Annweiler et al., 2000).

We used a 1DE-based approach to detect and identify proteins specifically formed during anaerobic growth of diverse sulfate-reducing bacteria with toluene, *m*-xylene and *o*-xylene. The catalytic subunit of benzylsuccinate synthase (BssA) could be detected as major induced protein in extracts of *D. toluolica* Tol2, *Desulfosarcina cetonica* 480 and oXyS1 cells anaerobically grown with alkylbenzenes. Specific and strong formation of a putative BssA-like protein was detected in *D. toluolica* Tol2 and *D. cetonica* 480 indicating their physiological significance during anaerobic degradation of toluene. Substrate-dependent regulation of a putative BssA-like protein was less pronounced, while still significant in strains oXyS1 and mXyS1 grown with *o*-xylene/toluene and *m*-xylene, respectively. Initial activation of *m*-xylene to 3-methylbenzylsuccinate was recently demonstrated for denitrifying *Azoarcus* sp. starin T (Krieger et al., 1999) and sulfate-reducing strain OX39 (Morasch et al., 2004). Surprisingly, a tentative 3-methylbenzylsuccinate synthase-like protein could be also detected when cells of mXyS1 were grown with *m*-methylbenzoate. One may speculate that *m*-methylbenzoate acts as gratuitous inducer for the catabolic genes of methylbenzylsuccinate synthase.

A tentative 2-methylbenzylsuccinate synthase protein could be resolved in cells of oXyS1 grown with *o*-xylene. The protein was up-regulated by more than 17-folds (cells grown with benzoate serve as reference). Activation reactions by addition of *o*-xylene to fumarate yielding 2-methylbenzylsuccinate were demonstrated in the denitrifying strain T (Beller and Spormann, 1997a) and sulfate-reducing strain OX39 (Morasch et al., 2004).

Candidates for BssA-like proteins were also detected in 2-methylnaphthalene-degrading bacterial isolates (NaphS2, NaphS3 and NaphS6) and two enrichment cultures. This suggests degradation of 2-methylnaphthalene by the tentative naphthyl-2-methylsuccinate synthase to naphthyl-2-methylsuccinate. The latter intermediate was already demonstrated in enrichment culture under sulfate-reducing conditions (Annweiler et al., 2000).

Importantly, the present study revealed the absence of BssA-like proteins during anaerobic growth of NaphS2, NaphS3 and NaphS6 with naphthalene. The latter substrate lacks the alkyl-side chains susceptible for radical attack at the aliphatic carbon atom adjacent to the aromatic ring (Widdel et al., 2004). Thus, the recently proposed methylation of naphthalene to 2-methylnaphthalene (Safinowski and Meckenstock, 2006) is unlikely in the tested marine sulfate reducers NaphS2, NaphS3 and NaphS6. Rather a different mechanism has to be expected, such as carboxylation of naphthalene to 2-naphthoate (Zhang and Young, 1997).

## D Literature

- Aeckersberg F, Bak F, Widdel F** (1991) Anaerobic oxidation of saturated hydrocarbons to carbon dioxide by a new type of sulfate-reducing bacterium. *Archives of Microbiology* 156: 5-14
- Allen J, Coombs M** (1980) Covalent binding of polycyclic aromatic compounds to mitochondrial and nuclear DNA. *Nature* 287: 244-245
- Anders HJ, Kaetzke A, Kämpfer P, Ludwig W, Fuchs G** (1995) Taxonomic position of aromatic-degrading denitrifying *Pseudomonad* strains K 172 and KB 740 and their description as new members of the genera *Thauera*, as *Thauera aromatica* sp. nov, and *Azoarcus*, as *Azoarcus evansii* sp. nov, respectively, members of the beta subclass of the Proteobacteria. *International Journal of Systematic Bacteriology* 45: 327-333
- Annweiler E, Materna A, Safinowski M, Kappler A, Richnow H, Michaelis W, Meckenstock R** (2000) Anaerobic degradation of 2-methylnaphthalene by a sulfate-reducing enrichment culture. *Applied Environmental Microbiology* 66: 5329–5333.
- Bak F, Widdel F** (1986a) Anaerobic degradation of indolic compounds by sulfate-reducing enrichment cultures, and description of *Desulfobacterium indolicum* gen. nov, sp. nov. *Archives of Microbiology* 146: 170–176
- Bak F, Widdel F** (1986b) Anaerobic degradation of phenol and phenol derivatives by *Desulfobacterium phenolicum* sp. nov. *Archives of Microbiology* 146: 177–180
- Beller H, Spormann A** (1997a) Anaerobic activation of toluene and o-xylene by addition to fumarate in denitrifying strain T. *Journal of Bacteriology* 179: 670–676
- Beller H, Spormann A** (1997b) Benzylsuccinate formation as a means of anaerobic toluene activation by sulfate-reducing strain PRTOL1. *Applied Environmental Microbiology* 63: 3729–3731

- Beller H, Spormann A, Sharma P, Cole J, Reinhard M** (1996) Isolation and characterization of a novel toluene-degrading, sulfate-reducing bacterium. *Applied and Environmental Microbiology* 62: 1188-1196
- Biegert T, Fuchs G, Heider F** (1996) Evidence that anaerobic oxidation of toluene in the denitrifying bacterium *Thauera aromatica* is initiated by formation of benzylsuccinate from toluene and fumarate. *European Journal of Biochemistry* 238: 661-668
- Boll M** (2005) Key enzymes in the anaerobic aromatic metabolism catalysing Birch-like reductions. *Biochemica et Biophysica Acta* 1707: 34-50
- Boll M, Albracht S, Fuchs G** (1997) Benzoyl-CoA reductase (dearomatizing), a key enzyme of anaerobic aromatic metabolism - a study of adenosinetriphosphatase activity, ATP stoichiometry of the reaction and EPR properties of the enzyme. *European Journal of Biochemistry* 244: 840-851
- Boll M, Fuchs G** (1995) Benzoyl-coenzyme A reductase (dearomatising), a key enzyme of anaerobic aromatic metabolism: ATP-dependence of the reaction, purification and some properties of the enzyme from *Thauera aromatica* strain K172. *European Journal of Biochemistry* 234: 921-933
- Boll M, Fuchs G, Heider J** (2002) Anaerobic oxidation of aromatic compounds and hydrocarbons. *Current Opinion in Chemical Biology* 6: 604-611
- Bossert I, Whited G, Gibson D, Young L** (1989) Anaerobic oxidation of *p*-cresol mediated by a partially purified methylhydroxylase from a denitrifying bacterium. *Journal of Bacteriology* 171: 2956-2962
- Bradford M** (1976) A rapid and sensitive method for the quantification of microgram quantities of protein utilizing the principle of protein-dye binding. *Analytical Biochemistry* 72: 248-254

- Brüchert V, Knoblauch C, Jørgensen B.B** (2001) Controls on stable sulfur isotope fractionation during bacterial sulfate reduction in Arctic sediments. *Geochim. Cosmochim. Acta* 65: 763-776.
- Bryant MP** (1972) Commentary on the Hungate technique for culture of anaerobic bacteria. *American Journal of Clinical Nutrition* 25: 1324-1328
- Chambers L, Trudinger P** (1975) Are thiosulfate and trithionate intermediates in dissimilatory sulfate reduction. *Journal of Bacteriology* 123: 36-40
- Cline JD** (1969) Spectrophotometric determination of hydrogen sulfide in natural waters. *Limnology and Oceanography* 14: 454-458
- Cunane L, Chen Z-W, Shamala N, Mathews F, Cronin C, McIntire W** (2000) structure of the flavocytochrome *p*-cresol methylhydroxylase and its enzyme-substrate complex: gated substrate entry and proton relays support the proposed catalytic mechanism. *Journal of Molecular Biology* 295: 357-374
- Dean BJ** (1978) Genetic toxicology of benzene, toluene, xylenes, and phenols. *Mutation Research* 74: 75-97
- Dolfing J, Zeyer J, Binder-Eicher P, Schwarzenbach RP** (1990) Isolation and characterization of a bacterium that mineralizes toluene in the absence of molecular oxygen. *Archives of Microbiology* 154: 336-341
- Drzyzga O, Küver J, Blotevogel K-H** (1993) Complete oxidation of benzoate and 4-hydroxybenzoate by a new sulfate-reducing bacterium resembling *Desulfoarculus*. *Archives of Microbiology* 159: 109-113
- EPA-Environmental Protection Agency** (1996) Product properties test guidelines: partition coefficient (*n*-octanol/water), estimation by liquid chromatography. EPA 712-C-96-040



- Evans PJ, Mang DT, Kim KS, Young LY** (1991) Anaerobic degradation of toluene by a denitrifying bacterium. *Applied and Environmental Microbiology* 57: 1139-1145
- Farago S, Brunold** (1990) Regulation of assimilatory sulfate reduction by Herbicide safeners in *Zea mays* L. *Plant Physiology* 94: 1808-1812
- Fischer-Romero C, Tindall BJ, Jüttner F** (1996) *Toluomonas auensis* gen. nov., sp. nov., a toluene-producing bacterium from anoxic sediments of a freshwater lake. *International Journal of Systematic Bacteriology* 46: 183-188
- Fritz G** (1999) Structure and function of redox proteins involved in dissimilatory sulfate reduction: adenosine 5'-phosphosulfate reductase and multiheme cytochromes. Universität Konstanz: Konstanz
- Galushko A, Kiesele-Lang U, Kappler A** (2003) Degradation of 2-methylnaphthalene by a sulfate-reducing enrichment culture of mesophilic freshwater bacteria. *Polycyclic Aromatic Compounds* 23: 207-218
- Galushko A, Minz D, Schink B, Widdel F** (1999) Anaerobic degradation of naphthalene by a pure culture of a novel type of marine sulphate-reducing bacterium. *Environmental Microbiology* 1: 415–420
- Galushko A, Rozanova E** (1991) *Desulfobacterium cetonicum* sp. nov. – a sulfate-reducing bacterium which oxidizes fatty acids and ketones. *Microbiology (Engl. Transl. Microbiologiya (USSR))* 60: 742-746
- Gibson D, Hensley M, Yoshioka H, Mabry T** (1970) Formation of (+)-*cis*-2,3-dihydroxy-1-methylcyclohexa-4,6-diene from toluene by *Pseudomonas putida*. *Biochemistry* 9: 1626-1630
- Gibson J, Dispensa M, Fogg G, Evans D, Harwood C** (1994) 4-Hydroxybenzoate-coenzyme A ligase from *Rhodopseudomonas palustris*: purification, gene sequence, and role in anaerobic degradation. *Journal of Bacteriology* 176: 634-641

- Harder J and Foss S** (1999) Anaerobic formation of the aromatic hydrocarbon *p*-cymene from monoterpenes by methanogenic enrichment cultures. *Geomicrobiology Journal* 16: 295-305
- Hammel KE** (1995) Organopollutant degradation by ligninolytic fungi. In: Young LY, Cerniglia CE (Ed.). *Microbial transformation and degradation of toxic organic chemicals*, Wiley and Sons. New York. pp 331-346
- Harms G, Zengler K, Rabus R, Aeckersberg F, Minz D, Rossello-Mora R, Widdel F** (1999) Anaerobic oxidation of *o*-xylene, *m*-xylene, and homologous alkylbenzenes by new types of sulfate-reducing bacteria. *Applied and Environmental Microbiology* 65: 999-1004
- Haschke R, Campbell L** (1971) Thiosulfate reductase of *Desulfovibrio vulgaris*. *Journal of Bacteriology* 106: 603-607
- Hedegaard J, Gunsalus I** (1965) Mixed function oxidation. IV. An induced methylene hydroxylase in camphor oxidation. *Journal of Biological Chemistry* 240: 4038-4043
- Heider J** (2007) Adding handles to unhandy substrates: anaerobic hydrocarbon activation mechanisms. *Current Opinion in Chemical Biology* 11: 188-194
- Heider J, Boll M, Breese K, Breinig S, Ebenau-Jehle C, Fell U, Gad'on N, Laempe D, Leuthner B, Mohamed M, Schneider S, Burchhardt G, Fuchs G** (1998) Differential induction of enzymes involved in anaerobic metabolism of aromatic compounds in the denitrifying bacterium *Thauera aromatica*. *Archives of Microbiology* 170: 120-131
- Heider J, Fuchs G** (1997) Anaerobic metabolism of aromatic compounds. *European Journal of Biochemistry* 243: 577-596
- Hopper D, Taylor D** (1977) The purification and properties of *p*-cresl-(accepting) oxidoreductases (hydroxylating), a flavocytochrome from *Pseudomonas putida*. *Biochemical Journal* 167: 155-162

- Imhoff-Stuckle D, Pfennig N** (1983) Isolation and characterization of a nicotinic acid-degrading sulfate-reducing bacterium *Desulfococcus niacini* sp. nov. Archives of Microbiology 136, pp. 194–198
- Ishimoto M, Koyama J** (1957) Biochemical studies on sulfate-reducing bacteria. VI. Separation of hydrogenase and thiosulfate reductase and partial purification of cytochrome and green pigment. Journal of Biochemistry 44: 233-242
- Jackson RW, de Moss JA** (1965) Effects of toluene on *Escherichia coli*. Journal of Bacteriology 90: 1420-1425
- Jüttner F, Henatsch J** (1986) Anoxic hypolimnion is a significant source of biogenic toluene. Nature 323: 797-798
- Kniemeyer O, Fischer T, Wilkes H, Glöckner FO, Widdel F** (2003) Anaerobic degradation of ethylbenzene by a new type of marine sulfate-reducing bacterium. Applied and Environmental Microbiology 69: 760-768
- Koh T, Okabe K** (1994) Spectrophotometric determination of sulfide, sulfite, thiosulfate, trithionate and tetrathionate in mixtures. Analyst 119: 2457-2461
- Krieger C, Beller H, Reinhard M, Spormann A** (1999) Initial reactions in anaerobic oxidation of *m*-xylene by the denitrifying bacterium *Azoarcus* sp. Strain T. Journal of Bacteriology 181: 6403-6410
- Kube M, Heider J, Amann J, Hufnagel P, Kühner S, Beck A, Reinhardt R, Rabus R** (2004) Genes involved in the anaerobic degradation of toluene in a denitrifying bacterium, strain EbN1. Archives of Microbiology 181: 182-194
- Kuever J, Kulmer J, Jannsen S, Fischer U, Blotevogel K-H** (1993) Isolation and characterization of a new spore-forming sulfate-reducing bacterium growing by complete oxidation of catechol. Archives of Microbiology 159: 282–288

- Lau P, Bergeron H, Labbe D, Wang Y, Brousseau R, Gibson D** (1994) Sequence and expression of *todGIH* genes involved in the last three steps of toluene degradation by *Pseudomonas putida* F1. *Gene* 146: 7-13
- Leuthner B, Leutwein C, Schulz H, Hoerth P, Haehnel W, Schiltz E, Shaegger H, Heider J** (1998) Biochemical and genetic characterization of benzylsuccinate synthase from *Thauera aromatica*: A new glyceryl radical enzyme catalysing the first step in anaerobic toluene metabolism. *Molecular Microbiology* 28: 615-628
- Londry K, Suflita L, Tanner R** (1999) Cresol metabolism by the sulfate-reducing bacterium *Desulfotomaculum* sp. strain Groll. *Canadian Journal of Microbiology* 45:458-463
- Lovley DR , Baedeker MJ, Lonergan DJ, Cozzarelli IM, Phillips EJP, Siegel OI** (1989) Oxidation of aromatic contaminants coupled to microbial iron reduction. *Nature* 339: 297-300
- Mackay D, Shiu W** (1981) A critical review of Henry's law constants for chemicals of environmental interest. *Journal of Physical and Chemical Reference Data* 10: 1175-1199
- Maier RM** (1999) Microorganisms and organic pollutants. In: Maier RM, Pepper IL, Cerba CP *Environmental Microbiology* (Ed.). Academic press, New York. pp 336-400
- McMurry J** (1992) *Organic chemistry*. Brooks/Cole Publishing Company, California. pp 525-623
- Meckenstock RU** (1999) Fermentative toluene degradation in anaerobic defined syntrophic co-cultures. *FEMS Microbiology Letters* 177: 67-73
- Mohamed M, Fuchs G** (1993) Purification and characterization of phenylacetate-coenzyme A ligase from a denitrifying *Pseudomonas* sp., an enzyme involved in anaerobic degradation of phenylacetate. *Archives of Microbiology* 159: 554-562

- Morasch B, Schink B, Tebbe C, Meckenstock R** (2004) Degradation of *o*-xylene and *m*-xylene by a novel sulfate-reducer belonging to the genus *Desulfotomaculum*. Archives of Microbiology 181: 407–417.
- Müller J, Galushko A, Kappler A, Schink B** (2001) Initiation of anaerobic degradation of *p*-cresol by formation of 4-Hydroxybenzylsuccinate in *Desulfobacterium cetonicum*. Journal of Bacteriology 183: 752-757
- Nakatsukasa W, Akagi M** (1969) Thiosulfate reductase isolated from *Desulfotomaculum nigrificans*. Journal of Bacteriology 98: 429-433
- Neretin L, Schippers A, Pernthaler A, Hamann K, Amann R, Jørgensen B** (2003) Quantification of dissimilatory (bi)sulfite reductase gene expression in *Desulfobacterium autotrophicum* using real-time RT-PCR. Environmental Microbiology 5: 660-671
- Peters F, Heintz D, Johannes J, van Dorselaer A, Boll M** (2007) Genes, enzymes, and regulation of *p*-cresol metabolism in *Geobacter metallireducens*. Journal of Bacteriology 189: 4729-4738
- Peters F, Rother M, Boll M** (2004) Selenocysteine-containing proteins in anaerobic benzoate metabolism of *Desulfococcus multivorans*. Journal of Bacteriology 186: 2156-2163
- Peters F, Schinoda Y, McInerney M, Boll M** (2007) Cyclohexa-1,5-diene-1-carbonyl-coenzyme A hydratase of *Geobacter metallireducens* and *Syntrophus aciditrophicus*: evidence for a common benzoyl-CoA degradation pathway in facultative and strictly anaerobes. Journal of Bacteriology 189: 1055-1060
- Rabus R, Hansen T, Widdel F** (2004) Dissimilatory sulfate- and sulfur- reducing prokaryotes. In: The prokaryotes, Springer-Verlag: release 3.3
- Rabus R, Heider J** (1998) Initial reactions of anaerobic metabolism of alkylbenzenes in denitrifying and sulfate reducing bacteria. Archives of Microbiology 170: 377-384

- Rabus R, Kube M, Heider J, Beck A, Heitmann K, Widdel F, Reinhardt R** (2005) The genome sequence of anaerobic aromatic-degrading denitrifying bacterium, strain EbN1. *Archives of Microbiology* 183: 27-36. Electronic supplementary material (5) at [www.micro-genomes.mpg.de/ebn1](http://www.micro-genomes.mpg.de/ebn1)
- Rabus R, Nordhaus R, Ludwig W, Widdel F** (1993) Complete oxidation of toluene under strictly anoxic conditions by a new sulfate-reducing bacterium. *Applied and Environmental Microbiology* 59: 1444-1451
- Rabus R, Widdel F** (1995) Anaerobic degradation of ethylbenzene and other aromatic hydrocarbons by new denitrifying bacteria. *Archives of Microbiology* 163: 96-103
- Reichenbecher W, Schink B** (1997) *Desulfovibrio inopinatus*, sp. nov., a new sulfate-reducing bacterium that degrades hydroxyhydroquinone (1,2,4-trihydroxybenzene). *Archives of Microbiology* 168: 338–344
- Rockne K, Chee-Sanford J, Sanford R, Hedlund B, Staley J, Strand S** (2000) Anaerobic naphthalene degradation by microbial pure cultures under nitrate-reducing conditions. *Applied Environmental Microbiology* 66: 1595-1601
- Rosenberg E** (2004) Hydrocarbon-oxidizing bacteria. In: *The prokaryotes*, Springer-Verlag: release 3.1
- Rudolphi A, Tschech A, Fuchs G** (1991) Anaerobic degradation of cresols by denitrifying bacteria. *Archives of Microbiology* 155: 238-248
- Safinowski M, Meckenstock R** (2006) Methylation is the initial reaction in anaerobic naphthalene degradation by a sulfate-reducing enrichment culture. *Environmental Microbiology* 8: 347-352
- Schneider S, Fuchs G** (1998) Phenylacetyl-CoA:acceptor oxidoreductase, a new  $\alpha$ -oxidizing enzyme that produces phenylglyoxylate. Assay, membrane localization, and differential production in *Thauera aromatica*. *Archives of Microbiology* 169: 509-516

- Schnell S, Bak F, Pfennig N** (1989) Anaerobic degradation of aniline and dihydroxybenzenes by newly isolated sulfate-reducing bacteria and description of *Desulfobacterium anilini*. Archives of Microbiology 152: 556–563
- Schühle K, Gescher J, Feil U, Paul M, Jahn M, Schägger H, Fuchs G** (2003) Benzoate-coenzyme A ligase from *Thauera aromatica*. Journal of Bacteriology 185: 4920-2929
- Semanta S, Singh O, Jain R** (2002) Polycyclic aromatic hydrocarbon: environmental pollution and bioremediation. TRENDS in Biotechnology 20: 243-248
- Sikkema J, de Bont JA, Poolman B** (1995) Mechanisms of membrane toxicity of hydrocarbons. Microbiological Reviews 59: 201-222
- Song B, Häggblom M, Zhou J, Tiedje J, Palleroni N** (1999) Taxonomic characterization of denitrifying bacteria that degrade aromatic compounds and description of *Azoarcus toluvorans* sp. nov. and *Azoarcus toluclasticus* sp. nov. International Journal of Systematic Bacteriology 49: 1129-1140
- Szewzyk R, Pfennig N** (1987) Complete oxidation of catechol by the strictly anaerobic sulfate-reducing *Desulfobacterium catecholicum* sp. nov. Archives of Microbiology 147: 163–168
- Takahashi H, Yamazaki M, Sasakura N, Watanabe A, Leustek T, Engler J, Engler G, Van Montagu M, Saito K** (1997) Regulation of sulfur assimilation in higher plants: a sulfate transporter induced in sulfate-starved roots plays a central role in *Arabidopsis thaliana*. Proceedings of the National Academy of Sciences 94: 11102-11107
- Thauer R, Jungermann K, Decker K** (1977) Energy conservation in chemotrophic anaerobic bacteria. Bacteriological Reviews 41: 100-180
- Tissot B, Welte D** (1984) Petroleum formation and occurrence. Berlin, Springer-Verlag

- U.S. Public Health Service** (1989) Toxicological profile for toluene. Publication ATSDR/TP-89/23. Agency for Toxic Substrates and Disease Registry, U.S. Public Health Service, Atlanta, Ga.
- Valravamurthy A, Mopper K** (1990) Determination of Sulfite and Thiosulfate in Aqueous Samples Including Anoxic Seawater by Liquid Chromatography after Derivatization with 2,2'-Dithiobis( 5-nitropyridine). *Environmental Science and Technology* 24: 333-337
- Wackett L, Hershberger C** (2001) Biocatalysis and Biodegradation microbial transformation of organic compounds. ASM press: Washington.
- Widdel F, Bak F** (1992) Gram-negative mesophilic sulfate-reducing bacteria. In: Balows A, Trüper HG, Dworkin M, Harder W Schleifer KH (Ed.). *The prokaryotes*, Springer-Verlag. Berlin. pp 2278-3352
- Widdel F, Boetius A, Rabus R** (2004) Anaerobic degradation of hydrocarbons including methane. In: *The prokaryotes*, Springer-Verlag: release 3.16
- Widdel F, Kohring G-W, Mayer F** (1983) Studies on dissimilatory sulfate-reducing bacteria that decompose fatty acids. III. Characterization of the filamentous gliding *Desulfonema limicola* gen. nov., sp. nov., and *Desulfonema magnum* sp. nov. *Archives of Microbiology* 134: 286–294
- Widdel F, Rabus R** (2001) Anaerobic biodegradation of saturated aromatic hydrocarbons. *Current Opinion in Biotechnology* 12: 259-276
- Winderl C, Schaefer S, Lueders T** (2007) Detection of anaerobic toluene and hydrocarbon degraders in contaminated aquifers using benzylsuccinate synthase (bssA) genes as a functional marker. *Environmental Microbiology* 9: 1035-1046
- Wischgoll S, Heintz D, Peters F, Erxleben A, Samighausen E, Reski R, Van Dorselaer A, Boll M** (2005) Gene clusters involved in anaerobic benzoate degradation of *Geobacter metallireducens*. *Molecular Microbiology* 58: 1238-1252



- Wöhlbrand L, Kallerhoff B, Lange D, Hufnagel P, Thiermann J, Reinhardt R, Rabus R** (2007) Functional proteomic view of metabolic regulation in "Aromatoleum aromaticum" strain EbN1. *Proteomics* DOI: 10.1002/pmic.200600987
- Yaffe D, Cohen Y, Epinosa G, Arenas A, Giralt F** (2002) Fuzzy ARTMAP and back-propagation neural networks based quantitative structure-property relationships (QSPRs) for octanol-water partition coefficient of organic compounds. *Journal of Chemical Information and Computer Sciences* 42: 162-183
- Young L** (1985) Anaerobic degradation of aromatic compounds. In: Gibson D (Ed.) *Microbial degradation of aromatic compounds*, Marcel Dekker Inc, New York. pp487-523
- Zhang X, Young L** (1997) Carboxylation as an initial reaction in the anaerobic metabolism of naphthalene and phenanthrene by sulfidogenic consortia. *Applied Environmental Microbiology* 63: 4759–4764
- Zengler K, Heider J, Rossello-Mora R, Widdel F** (1999) Phototrophic utilization of toluene under anoxic conditions by a new strain of *Blastochloris sulfoviridis*. *Archives of Microbiology* 172: 204-212

## F Appendices

### Appendix I: Equations for quantification of sulfide determined by titration

The sulfide-containing solution was added to an excess of acidified iodine solution.  $\text{H}_2\text{S}$  reacts under these conditions with iodine according to:

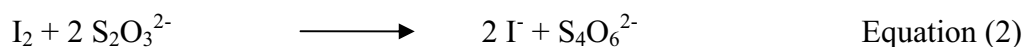
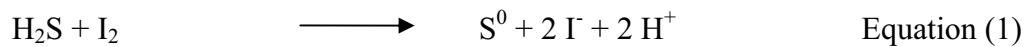

The amount of iodine titrated with thiosulfate was calculated from equation 1 and from this amount, the amount of iodine that had reacted before with sulfide was also calculated. From the latter, the amount of added sulfide and hence the exact concentration of the prepared sulfide solution was calculated.

## Appendix 2: Calibration curve for quantification of sulfide

The calibration curve was established by relating known concentrations of sulfide with the corresponding absorption at 670 nm. The linear equation was used in calculating the sulfide concentration in small sample volumes.

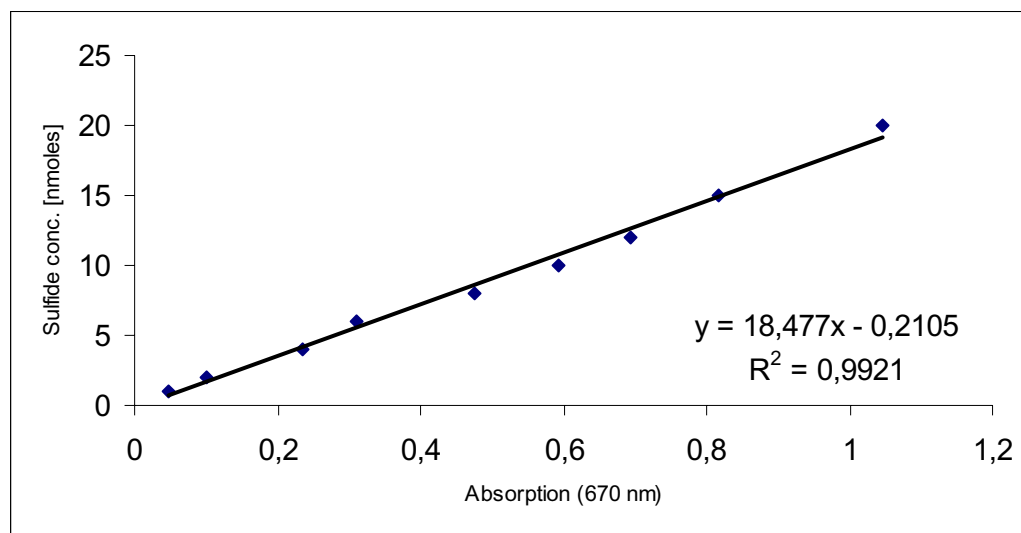

### Appendix 3: Calibration curves for quantification of proteins

Calibration curves for the determination of protein content in cell-free extracts used for SDS-PAGE (A) and 2 DE (B). Two different calibration curves were determined due to the different protein extraction procedures.

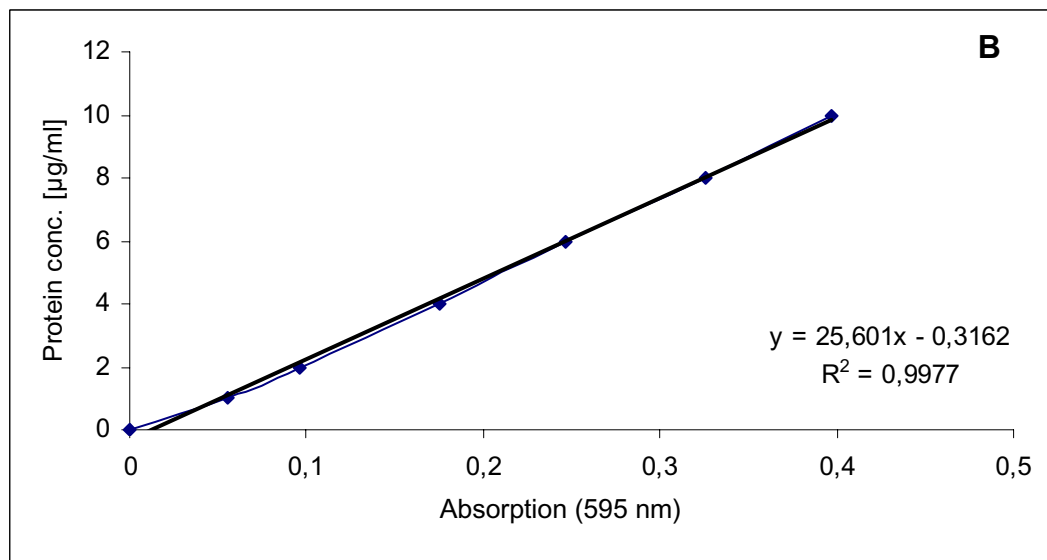
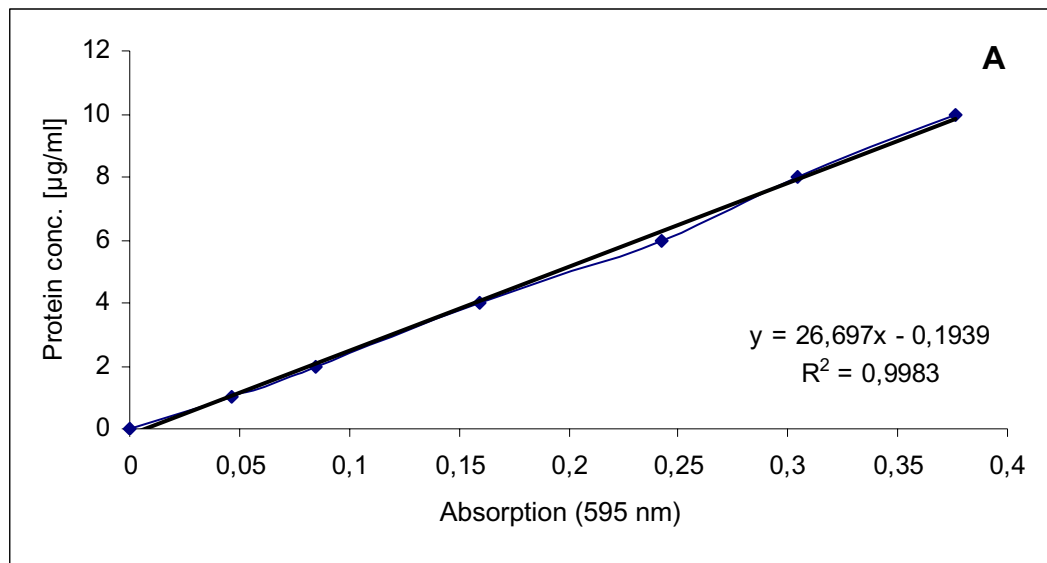

#### Appendix 4: Anaerobic growth of *D. toluolica* Tol2 with *p*-cresol

Anaerobic growth of *D. toluolica* Tol2 with *p*-cresol was optimal when increments of 0.15 mM *p*-cresol were added every ~ 24 hours (5 times in total) (A). The growth behavior was improved when the time intervals between increments were decreased to ~ 10 and ~ 14 hours (B). Each data point reflects the average of three parallels. Controls were lacking organic substrate, cells or both. Growth was monitored by measuring optical density (▲, △) and formation of sulfide (■, □) with filled symbols representing growth cultures and open symbols representing the control without organic substrate.

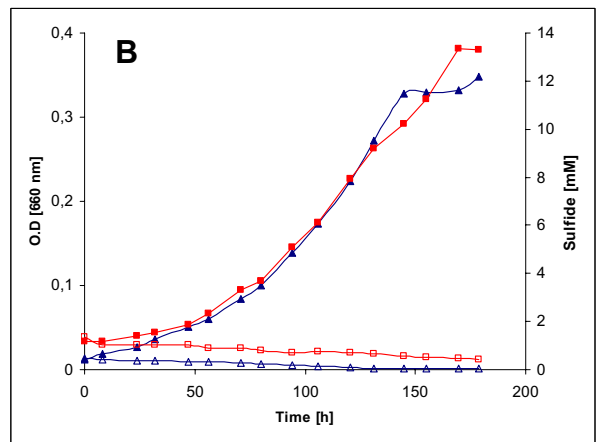
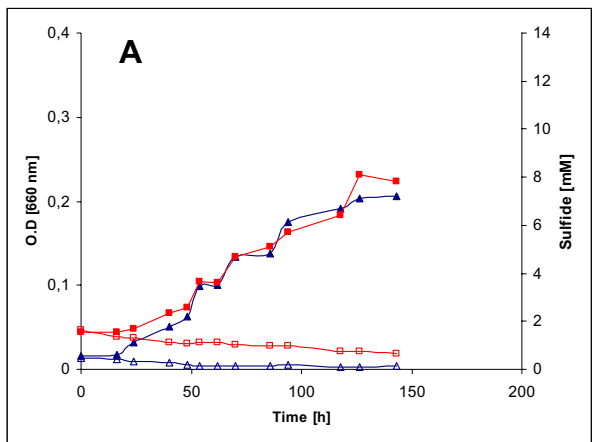

Appendix 5: Protein profiles of *D. toluolica* Tol2 grown anaerobically with different aromatic compounds.

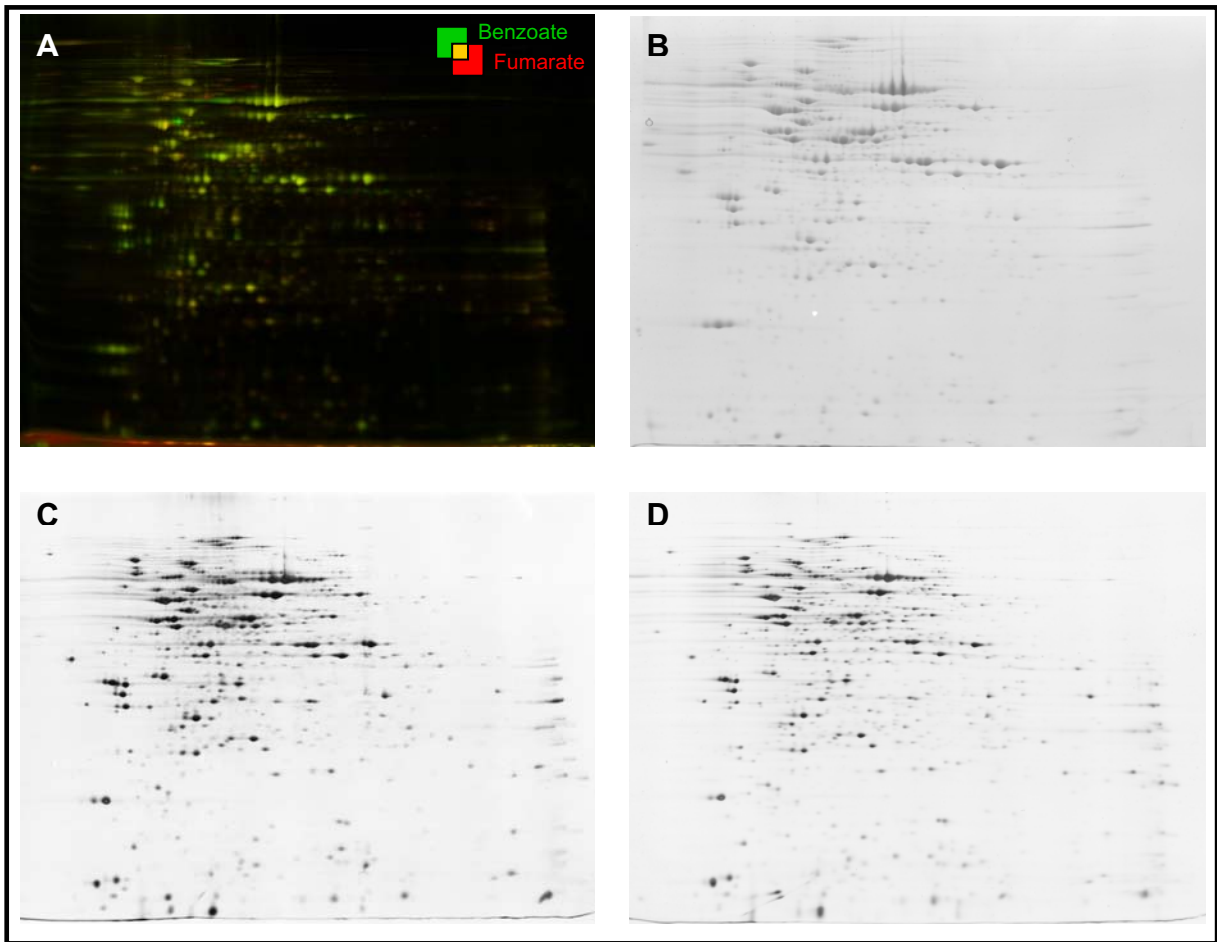

2DE-resolved protein profiles of *D. toluolica* Tol2 grown anaerobically with benzoate. Proteins were labelled with CyDyes [A] or stained with Coomassie [B] or silver nitrate [C]. Protein extracts from fumarate-adapted cells served as reference state (Cy5-labeling in image A) or silver-stained [D].

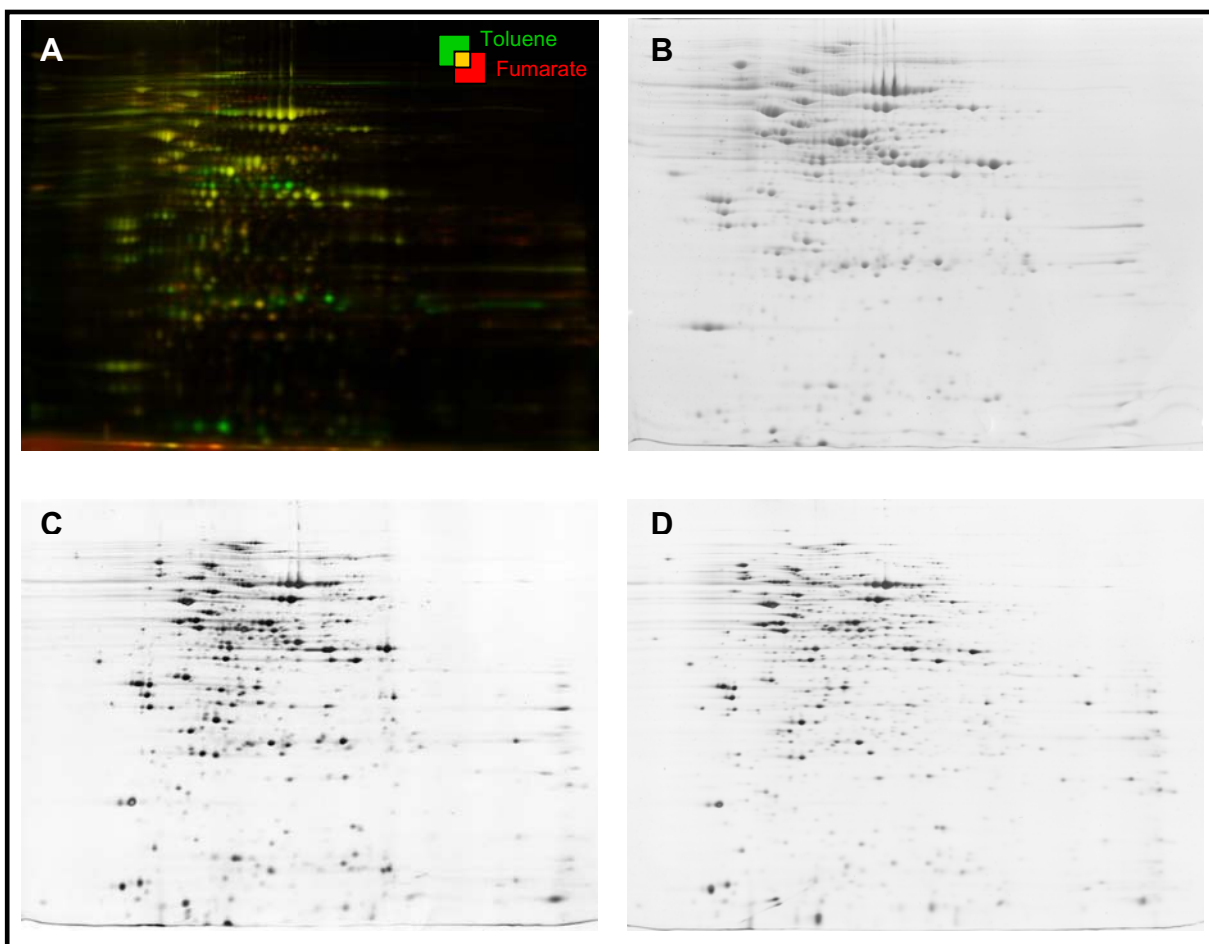

2DE-resolved protein profiles of *D. toluolica* Tol2 grown anaerobically with toluene. Proteins were labelled with CyDyes [A] or stained with Coomassie [B] or silver nitrate [C]. Protein extracts from fumarate-adapted cells served as reference state (Cy5-labeling in image A) or silver-stained [D].

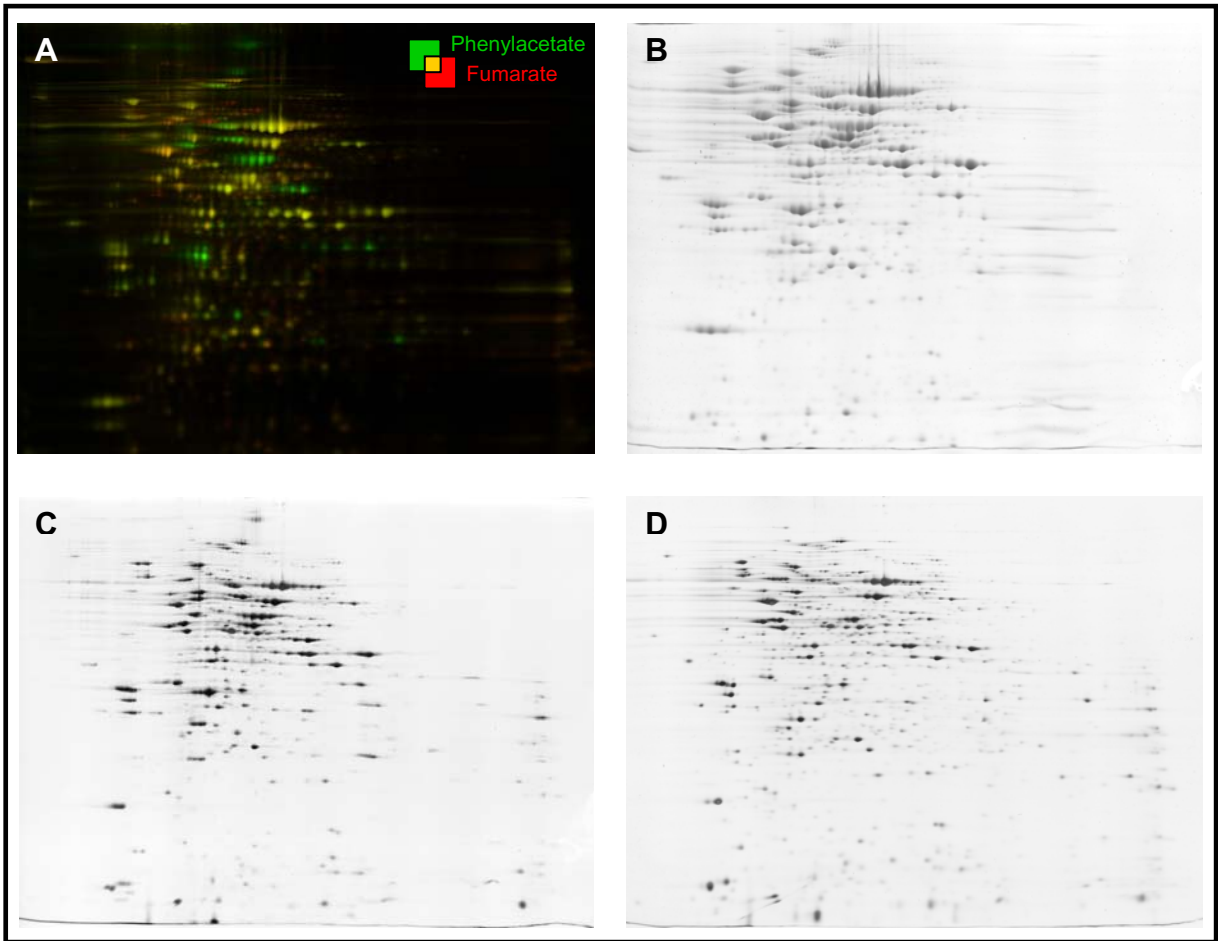

2DE-resolved protein profiles of *D. toluolica* Tol2 grown anaerobically with phenylacetate. Proteins were labelled with CyDyes [A] or stained with Coomassie [B] or silver nitrate [C]. Protein extracts from fumarate-adapted cells served as reference state (Cy5-labeling in image A) or silver-stained [D].



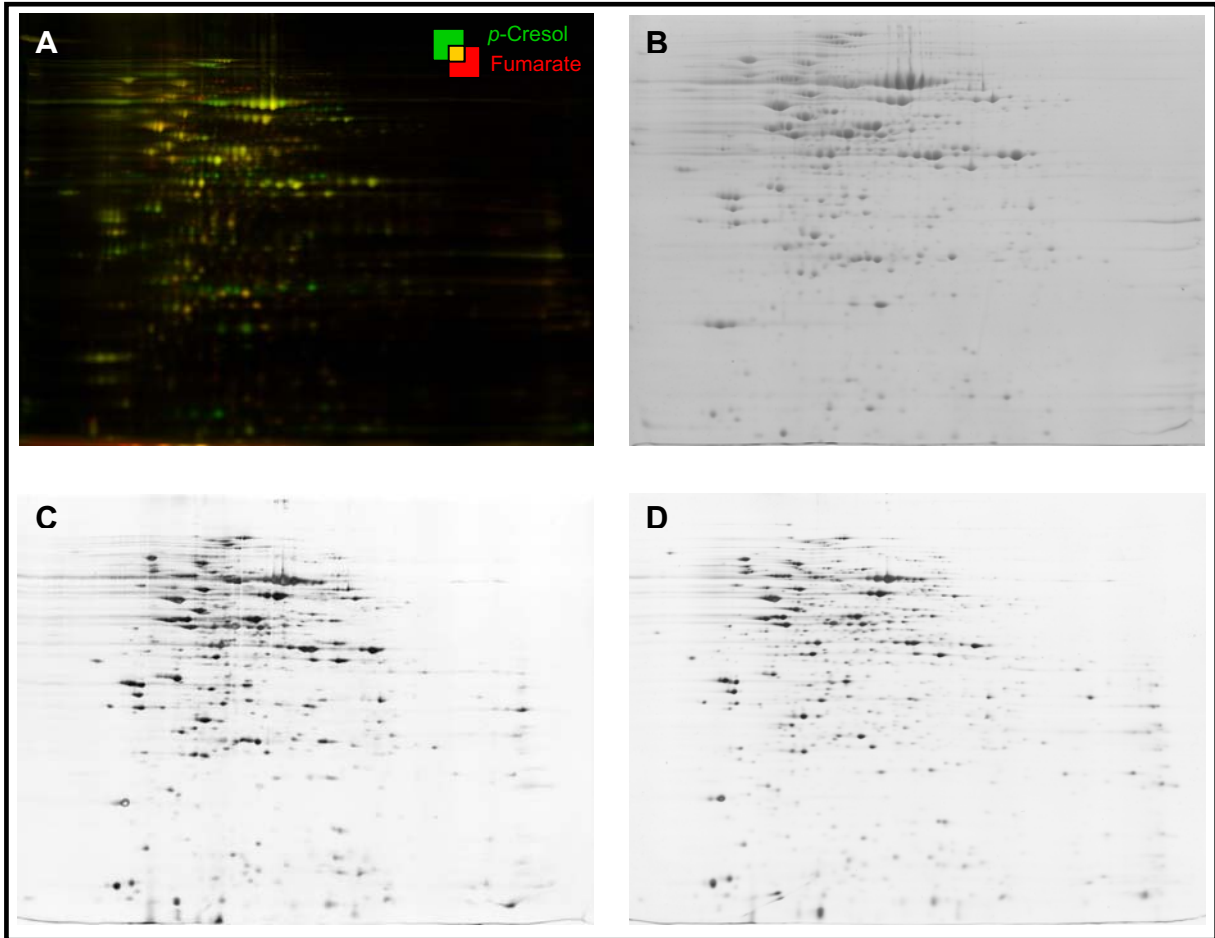

2DE-resolved proteins of *D. toluolica* Tol2 grown anaerobically with *p*-cresol. Proteins were labelled with Cydyes [A] or stained with Coomassie [B] or silver nitrate [C]. Protein extracts from fumarate-adapted cells served as reference state (Cy5-labeling in image A) or silver-stained [D].

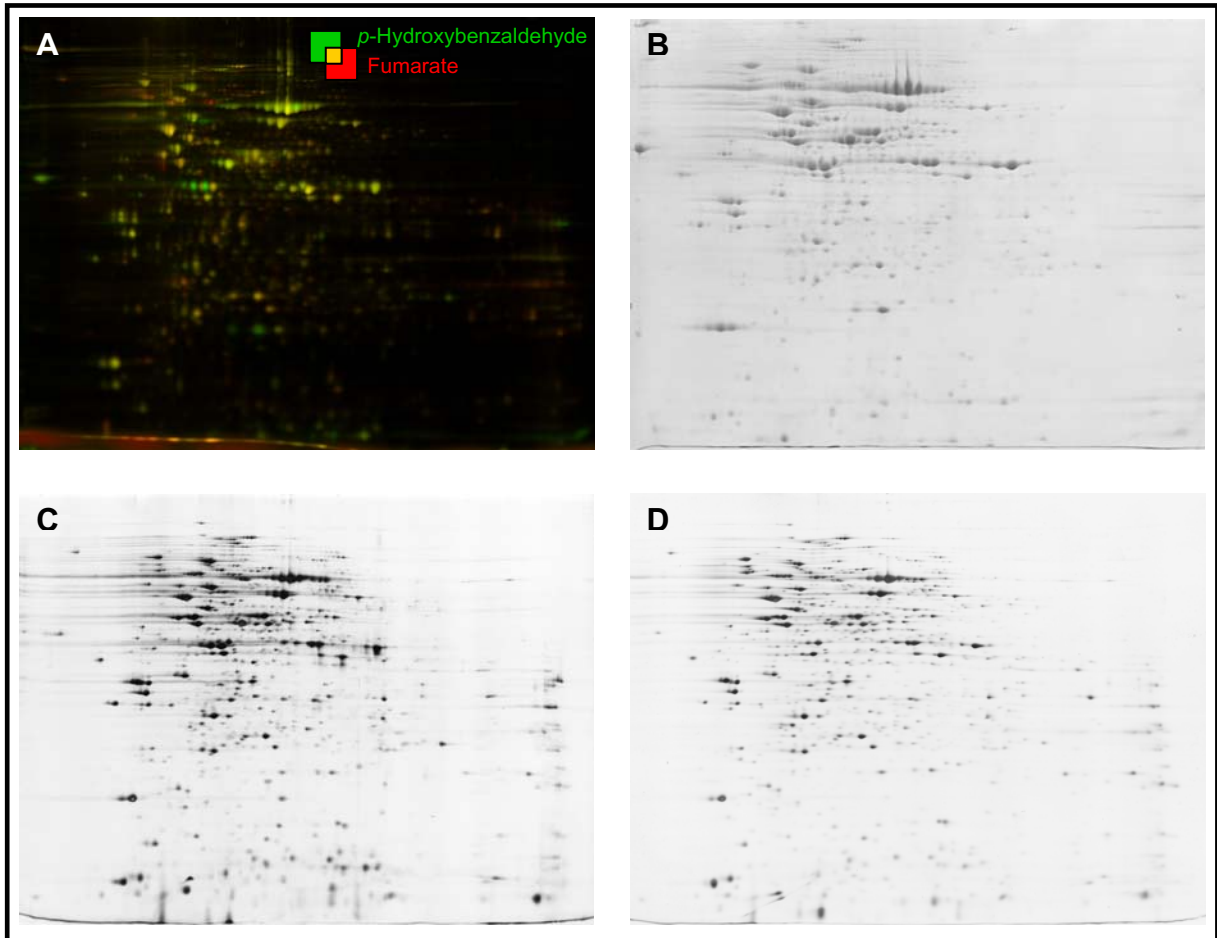

2DE-resolved protein profiles of *D. toluolica* Tol2 grown anaerobically with *p*-hydroxybenzaldehyde. Proteins were labelled with CyDyes [A] or stained with Coomassie [B] or silver nitrate [C]. Protein extracts from fumarate-adapted cells served as reference state (Cy5-labeling in image A) or silver-stained [D].

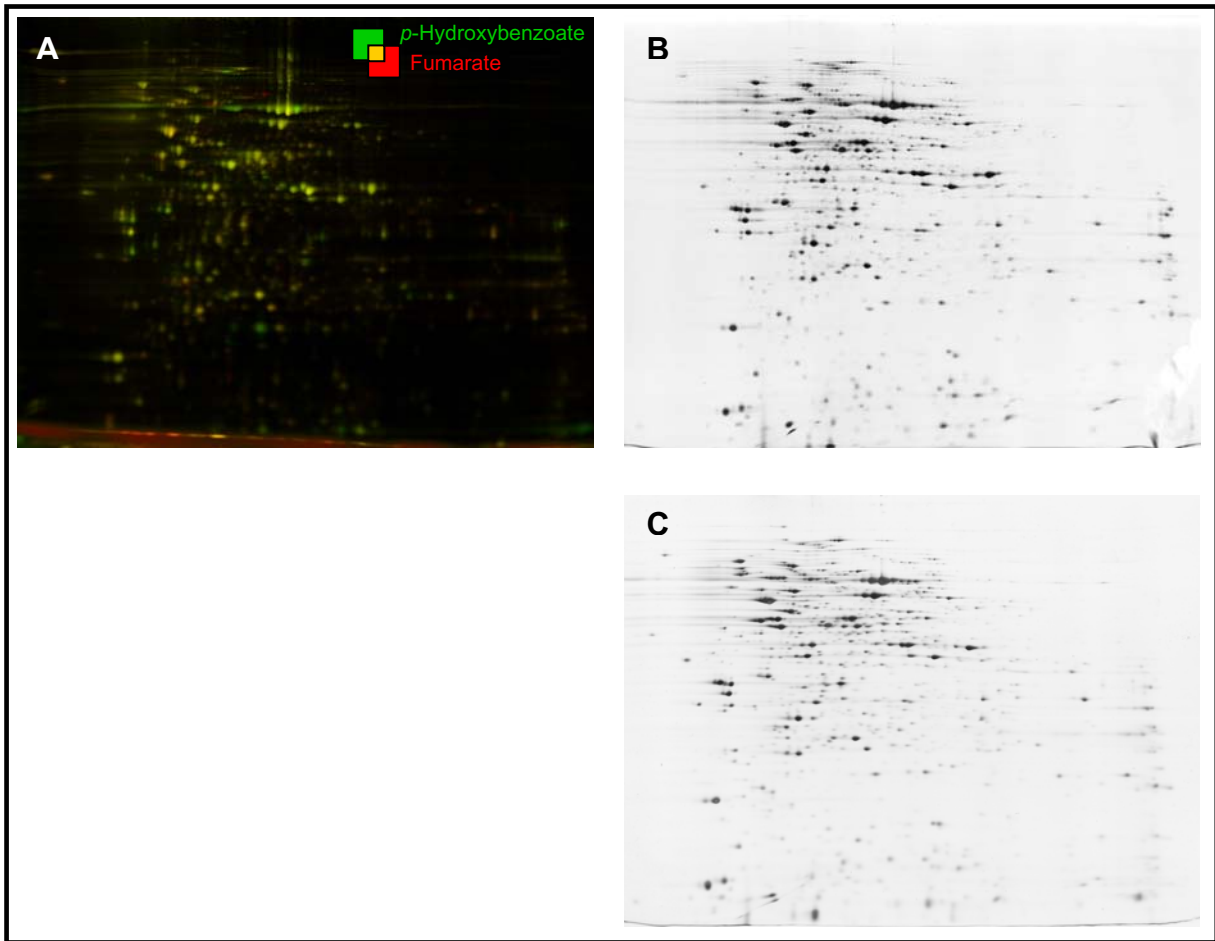

2DE-resolved protein profiles of *D. toluolica* Tol2 grown anaerobically with *p*-hydroxybenzoate. Proteins were labelled with CyDyes [A] or stained with silver nitrate [B]. Protein extracts from fumarate-adapted cells served as reference state (Cy5-labeling in image A) or silver-stained [C].

## Acknowledgment

I would like to express my deep thanks to my advisor Prof. Dr. Ralf Rabus for his guidance, motivation and stimulating discussions throughout all phases of my PhD work. I would like to thank Prof. Dr. Friedrich Widdel for giving me the valuable opportunity to work at the institute and for his scientific remarks.

This work was done within the international *marmic* program at Max Planck Institute for Marine Microbiology-Bremen. Thanks for the *marmic* faculty members, especially Prof. Dr. Rudolf Amann for the opportunity to join the program and for his participation as thesis committee member. Thanks for Prof. Dr. Karl-Heinz Blotevogel for his support and participation as thesis committee member. I would like to thank Prof. Dr. Mathias Ullrich for his participation in my thesis committee meetings. Many thanks to Dr. Christiane Glöckner who offered all kinds of support during my study.

Thanks to Dr. Volker Brüchert from the Department of Biogeochemistry-MPI for carrying out measurement of sulfur compounds in his lab.

Special thanks to Daniela Lange for her assistance in cultivation, cell harvesting, and SDS-PAGE, Birte Kallerhof for her help in 2DE, and Lars Wöhlbrand for his help in protein extraction and 2D DIGE. Thanks for my officemates, Maya, Amelia, and Alex and all colleagues in the Department of Microbiology for the pleasant and productive working environment.