

## EDGE CONTRACTION ON DUAL RIBBON GRAPHS AND 2D TQFT

OLIVIA DUMITRESCU AND MOTOHICO MULASE

ABSTRACT. We present a new set of axioms for 2D TQFT formulated on the category of cell graphs with edge-contraction operations as morphisms. We construct a functor from this category to the endofunctor category consisting of Frobenius algebras. Edge-contraction operations correspond to natural transformations of endofunctors, which are compatible with the Frobenius algebra structure. Given a Frobenius algebra  $A$ , every cell graph determines an element of the symmetric tensor algebra defined over the dual space  $A^*$ . We show that the edge-contraction axioms make this assignment depending only on the topological type of the cell graph, but not on the graph itself. Thus the functor generates the TQFT corresponding to  $A$ .

## CONTENTS

1. Introduction	1
2. Frobenius algebras	5
3. 2D TQFT	7
4. The edge-contraction axioms	11
5. Category of cell graphs and Frobenius ECO functors	17
References	21

## 1. INTRODUCTION

The purpose of the present paper is to give a new set of axioms for two-dimensional topological quantum field theory (2D TQFT) formulated in terms of dual ribbon graphs. The key relations between ribbon graphs are **edge-contraction operations**, which correspond to the degenerations in the moduli space  $\overline{\mathcal{M}}_{g,n}$  of stable curves of genus  $g$  with  $n$  labeled points that create a rational component with 3 special points. The structure of Frobenius algebra is naturally encoded in the category of dual ribbon graphs, where edge-contraction operations form morphisms and represent multiplication and comultiplication operations.

As Grothendieck impressively presents in [14], it is a beautiful and simple yet very surprising idea that a graph drawn on a compact topological surface gives an algebraic structure to the surface. When a positive real number is assigned to each edge as its length, a unique complex structure of the surface is determined. This association leads to a combinatorial model for the moduli space  $\mathcal{M}_{g,n}$  of smooth algebraic curves of genus  $g$  with  $n$  marked points [15, 21, 24, 26, 27]. By identifying these graphs as Feynman diagrams of [29] appearing in the asymptotic expansion of a particular matrix integral, and by giving a graph description of tautological cotangent classes on  $\overline{\mathcal{M}}_{g,n}$ , Kontsevich [17] shows that Witten's generating function [30] of intersection numbers of these classes satisfies the KdV equations. Kontsevich's argument is based on his discovery that an weighted sum of these intersection numbers is proportional to the Euclidean volume of the combinatorial model of  $\mathcal{M}_{g,n}$ .

---

2010 *Mathematics Subject Classification*. Primary: 14N35, 81T45, 14N10; Secondary: 53D37, 05A15.

*Key words and phrases*. Topological quantum field theory; Frobenius algebras; ribbon graphs; cell graphs.

The Euclidean volume of  $\mathcal{M}_{g,n}$  depends on the choice of the perimeter length of each face of the graph drawn on a surface. Kontsevich used the *Laplace transform* of the volume as a function of the perimeter length to obtain a set of relations among intersection numbers of different values of  $(g, n)$ . These relations are equivalent to the conjectured KdV equations.

Recall that if each edge has an integer length, then the resulting Riemann surface by the Strebel correspondence [27] is an algebraic curve defined over  $\overline{\mathbb{Q}}$  [3, 21]. Thus a systematic counting of curves defined over  $\overline{\mathbb{Q}}$  gives an approximation of the Euclidean volume of Kontsevich by lattice point counting. Since these lattice points naturally correspond to the graphs themselves, the intersection numbers in question can be obtained by graph enumeration, after taking the limit as the mesh length approaches to 0. Now we note that edge-contraction operations give an effective tool for graph enumeration problems. Then one can ask: *what information do the edge-contraction operations tell us about the intersection numbers?*

We found in [9, 12, 22] that the Laplace transform of the counting formula obtained by the edge-contraction operations on graphs is exactly the Virasoro constraint conditions of [6] for the intersection numbers. Indeed it gives the most fundamental example of *topological recursion* of [13].

Euclidean volume is naturally approximated by lattice point counting. It can be also approximated as a limit of hyperbolic volume. The latter idea applied to moduli spaces of hyperbolic surfaces gives the same Virasoro constraint conditions, as beautifully described in the work of Mirzakhani [19, 20]. Mirzakhani's technique of symplectic and hyperbolic geometry can be naturally extended to *character varieties* of surface groups. Yet there are no Virasoro constraints for this type of moduli spaces. We ask: *what do edge-contraction operations give us for the character varieties?*

This is our motivation of the current paper. Instead of discussing the application of our result to character varieties, which will be carried out elsewhere, we focus in this paper our discovery of the relation between edge-contraction operations and 2D TQFT.

A TQFT of dimension  $d$  is a symmetric monoidal functor  $Z$  from the monoidal category of  $(d - 1)$ -dimensional compact oriented topological manifolds, with  $d$ -dimensional oriented cobordism forming morphisms among  $(d - 1)$ -dimensional boundary manifolds, to the monoidal category of finite-dimensional vector spaces defined over a fixed field  $K$  [2, 25]. Since there is only one compact manifold in dimension 1, a 2D TQFT is associated with a unique vector space  $A = Z(S^1)$ , and the Atiyah-Segal axioms of TQFT makes  $A$  a commutative Frobenius algebra. It has been established that 2D TQFTs are classified by finite-dimensional Frobenius algebras [1, 5]. We ask the following question, in the reverse direction:

**Question 1.1.** *Suppose we are given a finite-dimensional commutative Frobenius algebra. What is the combinatorial realization of the algebra structure that leads to the corresponding 2D TQFT?*

The answer we propose in this paper is the *category of dual ribbon graphs*, with edge-contraction operations as morphisms. This category does not carry the information of a specific Frobenius algebra. In our forthcoming paper, we will show that our category generates all Frobenius objects among any given monoidal category.

For a given Frobenius algebra  $A$  and a ribbon graph  $\gamma_{g,n}$  with  $n$  vertices drawn on a topological surface of genus  $g$ , we assign a multilinear map

$$\gamma_{g,n} : A^{\otimes n} \longrightarrow K.$$

The *edge-contraction axioms* of Section 4 determine the behavior of this map under the change of ribbon graphs via edge contractions. Theorem 4.7, our main result of this paper,

exhibits a surprising statement that the map  $\gamma_{g,n}$  depends only on  $g$  and  $n$ , and is independent of the choice of the graph  $\gamma_{g,n}$ . We then evaluate  $\gamma_{g,n}$  for each  $v_1 \otimes \cdots \otimes v_n \in A^{\otimes n}$  and prove that this map indeed defines the TQFT corresponding to  $A$ .

A *ribbon graph* (also called as a dessin d'enfant, fatgraph, embedded graph, or a map) is a graph with an assignment of a cyclic order of half-edges incident at each vertex. The cyclic order induces the ribbon structure to the graph, and it becomes the 1-skeleton of the cell-decomposition of a compact oriented topological surface of genus, say  $g$ , by attaching oriented open discs to the graph. Let  $n$  be the number of the discs attached. We call this ribbon graph of *type*  $(g, n)$ .

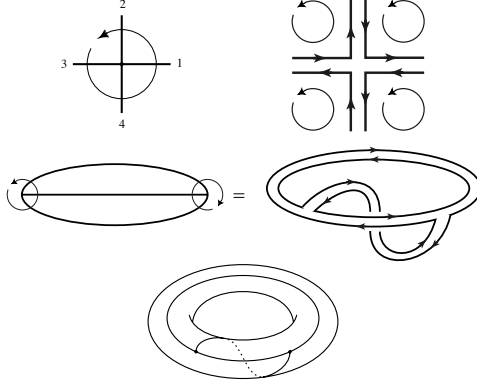

FIGURE 1.1. Top Row: A cyclic order of half-edges at a vertex induces a local ribbon structure to a graph. Second Row: Globally, a ribbon graph is the 1-skeleton of a cell-decomposition of a compact oriented surface. Third Row: A ribbon graph is thus a graph drawn on a compact oriented surface.

An assignment of a positive real number to each edge of a ribbon graph determines a concrete holomorphic coordinate system of the topological surface of genus  $g$  with  $n$  labeled marked points [21], thus making it a Riemann surface. This construction gives the identification of the space of ribbon graphs of type  $(g, n)$  with positive edge lengths assigned, and the space  $\mathcal{M}_{g,n} \times \mathbb{R}_+^n$ , as an orbifold. The operation of edge-contraction of an edge connecting two distinct vertices then defines the boundary operator, which introduces the structure of orbi-cell complex on  $\mathcal{M}_{g,n} \times \mathbb{R}_+^n$ . Each ribbon graph determines the stratum of this cell complex, whose dimension is the number of edges of the graph.

Since the ribbon graphs we need for the consideration of TQFT have *labeled vertices* but no labels for faces, we use the terminology **cell graph of type**  $(g, n)$  for a ribbon graph of genus  $g$  with  $n$  labeled vertices. A cell graph of type  $(g, n)$  is the dual of a ribbon graph of the same type  $(g, n)$ . The set of all cell graphs of type  $(g, n)$  is denoted by  $\Gamma_{g,n}$ .

Ribbon graphs naturally form orbi-cell complex. Their dual cell graphs naturally form a category  $\mathcal{CG}$ , as we shall define in Section 5. We then consider functors

$$\omega : \mathcal{CG} \longrightarrow \mathcal{Fun}(\mathcal{C}/K, \mathcal{C}/K),$$

where  $(\mathcal{C}, \otimes, K)$  is a monoidal category with the unit object  $K$ , and  $\mathcal{Fun}(\mathcal{C}/K, \mathcal{C}/K)$  is the endofunctor category over the category of  $K$ -objects of  $\mathcal{C}$ . Each cell graph corresponds to an endofunctor, and edge-contraction operations among them correspond to natural transformations. Our consideration can be generalized to the cohomological field theory of Kontsevich-Manin [18]. After this generalization, we can construct a functor that gives a classification of 2D TQFT. Since we need more preparation, these topics will be discussed in our forthcoming paper.

Edge-contraction operations also provide an effective method for graph enumeration problems. It has been noted in [12] that the Laplace transform of edge-contraction operations on many counting problems corresponds to the topological recursion of [13]. In a separate paper [11], we give the construction of the mirror B-models corresponding to the simple and orbifold Hurwitz numbers, by using only the edge-contraction operations. In general, enumerative geometry problems, such as computation of Gromov-Witten type invariants, are solved by studying a corresponding problem on the *mirror dual* side. The effectiveness of the mirror problem relies on the technique of complex analysis. The question is: How do we find the mirror of a given enumerative problem? In [11], we give an answer to this question for a class of graph enumeration problems that are equivalent to counting of orbifold Hurwitz numbers. The key is again the same edge-contraction operations. The base case, or the case for the “moduli space”  $\overline{\mathcal{M}}_{0,1}$ , of the edge contraction in the counting problem identifies the mirror dual object, and a universal mechanism of complex analysis, known as the **topological recursion** of [13], solves the B-model side of the counting problem. The solution is a collection of generating functions of the original problem for all genera.

The edge-contraction operation causes the degeneration of  $\mathbb{P}^1$  with one marked point  $p$  into two  $\mathbb{P}^1$ 's with one marked point on each, connected by a  $\mathbb{P}^1$  with 3 special points, two of which are nodal points and the third one representing the original marked point  $p$ . In terms of graph enumeration, the  $\mathbb{P}^1$  with 3 special points does not play any role. So we break the original vertex into two vertices, and separate the graph into two disjoint pieces (Figure 1.2).

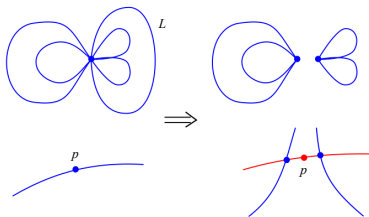

FIGURE 1.2. The edge-contraction operation on a loop is a degeneration process. The graph on the left is a connected cell graph of type  $(0, 1)$ . The edge-contraction on the loop  $L$  changes it to the one on the right. Here, a  $\mathbb{P}^1$  with one marked point  $p$  degenerates into two  $\mathbb{P}^1$ 's with one marked point on each, connected by a  $\mathbb{P}^1$  with 3 special points.

Once we have our formulation of 2D TQFT and topological recursion in terms of edge-contraction operations, we can consider a TQFT-valued topological recursion. An immediate example is the Gromov-Witten theory of the classifying space  $BG$  of a finite group  $G$ . In our forthcoming paper, we will show that a straightforward generalization of the topological recursion for differential forms with values in tensor products of a Frobenius algebra automatically splits into the product of the usual scalar-valued solution to the topological recursion and a 2D TQFT. Therefore, topological recursion implies TQFT. Here, we remark the similarity between the topological recursion and the comultiplication operation in a Frobenius algebra. Indeed, the topological recursion itself can be regarded as a comultiplication formula for an infinite-dimensional analogue of the Frobenius algebra (Vertex algebras, or conformal field theory).

The authors have noticed that the topological recursion appears as the Laplace transform of edge-contraction operations in [12]. The geometric nature of the topological recursion was further investigated in [7, 8, 10], where it was placed in the context of Hitchin spectral

curves for the first time, and the relation to quantum curves was discovered. The present paper is the authors' first step toward identifying the topological recursion in an algebraic and categorical setting. We note that Hitchin moduli spaces are diffeomorphic to character varieties of a surface group. The TQFT point of view of our current paper in the context of these character varieties, in particular, their Hodge structures, will be discussed elsewhere.

The paper is organized as follows. We start with a quick review of Frobenius algebras, for the purpose of setting notations, in Section 2. We then recall two-dimensional TQFT in Section 3. In Sections 4, we give our formulation of 2D TQFT in terms of the edge-contraction axioms of cell graphs. A categorical formulation of our axioms is given in Section 5.

## 2. FROBENIUS ALGEBRAS

In this paper, we are concerned with finite-dimensional, unital, commutative Frobenius algebras defined over a field  $K$ . In this section we review the necessary account of Frobenius algebra and set notations.

Let  $A$  be a finite-dimensional, unital, associative, and commutative algebra over a field  $K$ . A non-degenerate bilinear form  $\eta : A \otimes A \rightarrow K$  is a *Frobenius form* if

$$(2.1) \quad \eta(v_1, m(v_2, v_3)) = \eta(m(v_1, v_2), v_3), \quad v_1, v_2, v_3 \in A,$$

where  $m : A \otimes A \rightarrow A$  is the multiplication. We denote by

$$(2.2) \quad \lambda : A \xrightarrow{\sim} A^*, \quad \langle \lambda(u), v \rangle = \eta(u, v),$$

the canonical isomorphism of the algebra  $A$  and its dual. We assume that  $\eta$  is a symmetric bilinear form. Let  $\mathbf{1} \in A$  denote the multiplicative identity. Then it defines a *counit*, or a *trace*, by

$$(2.3) \quad \epsilon : A \rightarrow K, \quad \epsilon(v) = \eta(\mathbf{1}, v).$$

The canonical isomorphism  $\lambda$  introduces a unique cocommutative and coassociative coalgebra structure in  $A$  by the following commutative diagram.

$$(2.4) \quad \begin{array}{ccc} A & \xrightarrow{\delta} & A \otimes A \\ \lambda \downarrow & & \downarrow \lambda \otimes \lambda \\ A^* & \xrightarrow{m^*} & A^* \otimes A^* \end{array}$$

It is often convenient to use a basis for calculations. Let  $\langle e_1, e_2, \dots, e_r \rangle$  be a  $K$ -basis for  $A$ . In terms of this basis, the bilinear form  $\eta$  is identified with a symmetric matrix, and its inverse is written as follows:

$$(2.5) \quad \eta = [\eta_{ij}], \quad \eta_{ij} := \eta(e_i, e_j), \quad \eta^{-1} = [\eta^{ij}].$$

The comultiplication is then written as

$$\delta(v) = \sum_{i,j,a,b} \eta(v, m(e_i, e_j)) \eta^{ia} \eta^{jb} e_a \otimes e_b.$$

From now on, if there is no confusion, we denote simply by  $m(u, v) = uv$ . The symmetric Frobenius form and the commutativity of the multiplication makes

$$(2.6) \quad \eta(e_{i_1} \cdots e_{i_j}, e_{i_{j+1}} \cdots e_n) = \epsilon(e_{i_1} \cdots e_{i_n}), \quad 1 \leq j < n,$$

completely symmetric with respect to permutations of the indices.

The following is a standard formula for a non-degenerate bilinear form:

$$(2.7) \quad v = \sum_{a,b} \eta(v, e_a) \eta^{ab} e_b.$$

It immediately follows that

**Lemma 2.1.** *The following diagram commutes:*

$$(2.8) \quad \begin{array}{ccccc} & & A \otimes A \otimes A & & \\ & \nearrow^{id \otimes \delta} & & \searrow^{m \otimes id} & \\ A \otimes A & \xrightarrow{m} & A & \xrightarrow{\delta} & A \otimes A. \\ & \searrow^{\delta \otimes id} & & \nearrow^{id \otimes m} & \\ & & A \otimes A \otimes A & & \end{array}$$

Or equivalently, for every  $v_1, v_2$  in  $A$ , we have

$$\delta(v_1 v_2) = (id \otimes m)(\delta(v_1), v_2) = (m \otimes id)(v_2, \delta(v_1)).$$

*Proof.* Noticing the commutativity and cocommutativity of  $A$ , we have

$$\begin{aligned} \delta(v_1 v_2) &= \sum_{i,j,a,b} \eta(v_1 v_2, e_i e_j) \eta^{ia} \eta^{jb} e_a \otimes e_b \\ &= \sum_{i,j,a,b} \eta(v_1 e_i, v_2 e_j) \eta^{ia} \eta^{jb} e_a \otimes e_b \\ &= \sum_{i,j,a,b,c,d} \eta(v_1 e_i, e_c) \eta^{cd} \eta(e_d, v_2 e_j) \eta^{ia} \eta^{jb} e_a \otimes e_b \\ &= \sum_{i,j,a,b,c,d} \eta(v_1, e_i e_c) \eta^{cd} \eta^{ia} \eta(e_d v_2, e_j) \eta^{jb} e_a \otimes e_b \\ &= \sum_{i,a,c,d} \eta(v_1, e_i e_c) \eta^{cd} \eta^{ia} e_a \otimes (e_d v_2) \\ &= (id \otimes m)(\delta(v_1), v_2). \end{aligned}$$

□

In the lemma above we consider the composition  $\delta \circ m$ . The other order of operations plays an essential role in 2D TQFT.

**Definition 2.2** (Euler element). The **Euler element** of a Frobenius algebra  $A$  is defined by

$$(2.9) \quad \mathbf{e} := m \circ \delta(\mathbf{1}).$$

In terms of basis, the Euler element is given by

$$(2.10) \quad \mathbf{e} = \sum_{a,b} \eta^{ab} e_a e_b.$$

Another application of (2.7) is the following formula that relates the multiplication and comultiplication.

$$(2.11) \quad (\lambda(v_1) \otimes id) \delta(v_2) = v_1 v_2.$$

This is because

$$\begin{aligned}
(\lambda(v_1) \otimes id) \delta(v_2) &= \sum_{a,b,k,\ell} (\lambda(v_1) \otimes id) \eta(v_2, e_k e_\ell) \eta^{ka} \eta^{\ell b} e_a \otimes e_b \\
&= \sum_{a,b,k,\ell} \eta(v_2 e_\ell, e_k) \eta^{ka} \eta(v_1, e_a) \eta^{\ell b} e_b \\
&= \sum_{b,\ell} \eta(v_1, v_2 e_\ell) \eta^{\ell b} e_b = v_1 v_2.
\end{aligned}$$

### 3. 2D TQFT

The axiomatic formulation of conformal and topological quantum field theories was established in 1980s. We refer to Atiyah [2] and Segal [25]. We consider only two-dimensional topological quantum field theories in this paper. Again for the purpose of setting notations, we provide a brief review of the subject in this section. We refer to fundamental literature, such as [16, 28], for more detail of 2D TQFT.

A 2D TQFT is a symmetric monoidal functor  $Z$  from the cobordism category of oriented surfaces (a surface being a cobordism of its boundary circles) to the monoidal category of finite-dimensional vector spaces over a fixed field  $K$  with the operation of tensor products. The Atiyah-Segal TQFT axioms automatically make the vector space

$$(3.1) \quad Z(S^1) = A$$

a unital commutative Frobenius algebra over  $K$ .

Let  $\Sigma_{g,n}$  be an oriented surface of finite topological type  $(g, n)$ , i.e., a surface obtained by removing  $n$  disjoint open discs from a compact oriented two-dimensional topological manifold of genus  $g$ . The boundary components are labeled by indices  $1, \dots, n$ . We always give the induced orientation at each boundary circle. The TQFT then assigns to such a surface a multilinear map

$$(3.2) \quad \Omega_{g,n} \stackrel{\text{def}}{=} Z(\Sigma_{g,n}) : A^{\otimes n} \longrightarrow K.$$

If we change the orientation at the  $i$ -th boundary, then the  $i$ -th factor of the tensor product is changed to the dual space  $A^*$ . Therefore, if we have  $k$  boundary circles with induced orientation and  $\ell$  circles with opposite orientation, then we have a multi-linear map

$$\Omega_{g,k,\bar{\ell}} : A^{\otimes k} \longrightarrow A^{\otimes \ell}.$$

The sewing axiom of Atiyah [2] requires that

$$\Omega_{g_2,\ell,\bar{n}} \circ \Omega_{g_1,k,\bar{\ell}} = \Omega_{g_1+g_2+\ell-1,k,\bar{n}} : A^{\otimes k} \longrightarrow A^{\otimes n}.$$

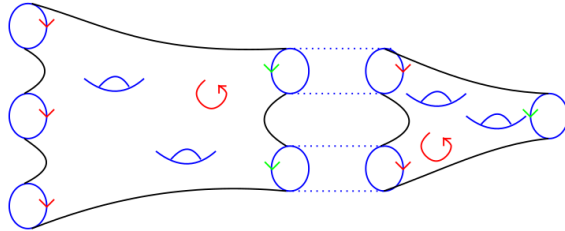

FIGURE 3.1.

A 2D TQFT can be also obtained as a special case of a CohFT of [18].

**Definition 3.1** (Cohomological Field Theory). We denote by  $\overline{\mathcal{M}}_{g,n}$  the moduli space of stable curves of genus  $g \geq 0$  and  $n \geq 1$  smooth marked points subject to the stability condition  $2g - 2 + n > 0$ . Let

$$(3.3) \quad \pi : \overline{\mathcal{M}}_{g,n+1} \longrightarrow \overline{\mathcal{M}}_{g,n}$$

be the forgetful morphism of the last marked point, and

$$(3.4) \quad gl_1 : \overline{\mathcal{M}}_{g-1,n+2} \longrightarrow \overline{\mathcal{M}}_{g,n}$$

$$(3.5) \quad gl_2 : \overline{\mathcal{M}}_{g_1,n_1+1} \times \overline{\mathcal{M}}_{g_2,n_2+1} \longrightarrow \overline{\mathcal{M}}_{g_1+g_2,n_1+n_2}$$

the gluing morphisms that give boundary strata of the moduli space. An assignment

$$(3.6) \quad \Omega_{g,n} : A^{\otimes n} \longrightarrow H^*(\overline{\mathcal{M}}_{g,n}, K)$$

is a CohFT if the following axioms hold:

**CohFT 0:**  $\Omega_{g,n}$  is  $S_n$ -invariant, i.e., symmetric, and  $\Omega_{0,3}(\mathbf{1}, v_1, v_2) = \eta(v_1, v_2)$ .

**CohFT 1:**  $\Omega_{g,n+1}(v_1, \dots, v_n, \mathbf{1}) = \pi^* \Omega_{g,n}(v_1, \dots, v_n)$ .

**CohFT 2:**  $gl_1^* \Omega_{g,n}(v_1, \dots, v_n) = \sum_{a,b} \Omega_{g-1,n+2}(v_1, \dots, v_n, e_a, e_b) \eta^{ab}$ .

**CohFT 3:**  $gl_2^* \Omega_{g_1+g_2, |I|+|J|}(v_I, v_J) = \sum_{a,b} \Omega_{g_1, |I|+1}(v_I, e_a) \Omega_{g_2, |J|+1}(v_J, e_b) \eta^{ab}$ ,

where  $I \sqcup J = \{1, \dots, n\}$ .

If a CohFT takes values in  $H^0(\overline{\mathcal{M}}_{g,n}, K) = K$ , then it is a 2D TQFT. In what follows, we only consider CohFT with values in  $H^0(\overline{\mathcal{M}}_{g,n}, K)$ .

**Remark 3.2.** The forgetful morphism makes sense for a stable pointed curve, but it does not exist for a topological surface with boundary in the same way. Certainly we cannot just *forget* a boundary. For a TQFT, eliminating a boundary corresponds to capping a disc. In algebraic geometry language, it is the same as gluing a component of  $g = 0$  and  $n = 1$ . Since  $H^0(\overline{\mathcal{M}}_{g,n}, K) = K$  is not affected by the morphism (3.3)-(3.5), the equation

$$\Omega_{g,n}(\mathbf{1}, v_2, \dots, v_n) = \Omega_{g,n-1}(v_2, \dots, v_n)$$

is identified with CohFT 3 for  $g_2 = 0$  and  $J = \emptyset$ , if we define

$$(3.7) \quad \Omega_{0,1}(v) := \epsilon(v) = \eta(\mathbf{1}, v),$$

even though  $\overline{\mathcal{M}}_{0,1}$  does not exist. We then have

$$\begin{aligned} \Omega_{g,n}(v_1, \dots, v_n) &= \sum_{a,b} \Omega_{g,n+1}(v_1, \dots, v_n, e_a) \eta(\mathbf{1}, e_b) \eta^{ab} \\ &= \Omega_{g,n+1}(v_1, \dots, v_n, \mathbf{1}) \end{aligned}$$

by (2.7). In other words, the isomorphism of the degree 0 cohomologies

$$(3.8) \quad \pi^* : H^0(\overline{\mathcal{M}}_{g,n}, K) \longrightarrow H^0(\overline{\mathcal{M}}_{g,n+1}, K)$$

is replaced by its left inverse

$$(3.9) \quad \sigma_i^* : H^0(\overline{\mathcal{M}}_{g,n+1}, K) \longrightarrow H^0(\overline{\mathcal{M}}_{g,n}, K),$$

where

$$(3.10) \quad \sigma_i : \overline{\mathcal{M}}_{g,n} \longrightarrow \overline{\mathcal{M}}_{g,n+1}$$

is one of the  $n$  tautological sections. Of course this consideration does not apply for CohFT.



**Remark 3.3.** In the same spirit, although  $\overline{\mathcal{M}}_{0,2}$  does not exist either, we can *define*

$$(3.11) \quad \Omega_{0,2}(v_1, v_2) := \eta(v_1, v_2)$$

so that we exhaust all cases appearing in the Atiyah-Segal axioms for 2D TQFT. In particular, for  $g_2 = 0$  and  $J = \{n\}$ , we have

$$\begin{aligned} \Omega_{g,n}(v_1, \dots, v_n) &= \Omega_{g,n} \left( v_1, \dots, v_{n-1}, \sum_{a,b} \eta(v_n, e_b) \eta^{ab} e_a \right) \\ &= \sum_{a,b} \Omega_{g,n}(v_1, \dots, v_{n-1}, e_a) \Omega_{0,2}(v_n, e_b) \eta^{ab}. \end{aligned}$$

Thus  $\Omega_{0,2}(v_1, v_2)$  functions as the identity operator of the Atiyah-Segal axiom [2].

**Remark 3.4.** A marked point  $p_i$  of a stable curve  $\Sigma \in \overline{\mathcal{M}}_{g,n}$  is an insertion point for the cotangent class  $\psi_i = c_1(\mathbb{L}_i)$ , where  $\mathbb{L}_i$  is the pull-back of the relative canonical sheaf on the universal curve  $\pi : \overline{\mathcal{M}}_{g,n+1} \rightarrow \overline{\mathcal{M}}_{g,n}$  by the  $i$ -th tautological section  $\sigma_i : \overline{\mathcal{M}}_{g,n} \rightarrow \overline{\mathcal{M}}_{g,n+1}$ . If we cut a small disc around  $p_i \in \Sigma$ , then the orientation induced on the boundary circle is consistent with the orientation of the unit circle in  $T_{p_i}^* \Sigma$ . This orientation is opposite to the orientation that is naturally induced on  $T_{p_i} \Sigma$ . In general, if  $V$  is an oriented real vector space of dimension  $n$ , then  $V^*$  naturally acquires the opposite orientation with respect to the dual basis if  $n \equiv 2, 3 \pmod{4}$ .

As we have noted, in terms of sewing axioms, if a boundary circle on a topological surface  $\Sigma$  of type  $(g, n)$  is oriented according to the induced orientation, then this is an *input* circle to which we assign an element of  $A$ . If a boundary circle is oppositely oriented, then it is an *output* circle and  $\Sigma$  produces an output element at this boundary. Thus if  $\Sigma_1$  has an input circle and  $\Sigma_2$  an output circle, then we can sew the two surfaces together along the circle to form a connected sum  $\Sigma_1 \# \Sigma_2$ , where the output from  $\Sigma_2$  is placed as input for  $\Sigma_1$ .

**Proposition 3.5.** *The genus 0 values of a 2D TQFT is given by*

$$(3.12) \quad \Omega_{0,n}(v_1, \dots, v_n) = \epsilon(v_1 \cdots v_n),$$

*provided that we define*

$$(3.13) \quad \Omega_{0,3}(v_1, v_2, v_3) := \epsilon(v_1 v_2 v_3).$$

*Proof.* This is a direct consequence of CohFT 3 and (2.7).  $\square$

One of the original motivations of TQFT [2, 25] is to identify the *topological invariant*  $Z(\Sigma)$  of a closed manifold  $\Sigma$ . In our current setting, it is defined as

$$(3.14) \quad Z(\Sigma_g) := \epsilon(\lambda^{-1}(\Omega_{g,1}))$$

for a closed oriented surface  $\Sigma_g$  of genus  $g$ . Here,  $\Omega_{g,1} : A \rightarrow K$  is an element of  $A^*$ , and  $\lambda : A \xrightarrow{\sim} A^*$  is the canonical isomorphism.

**Proposition 3.6.** *The topological invariant  $Z(\Sigma_g)$  of (3.14) is given by*

$$(3.15) \quad Z(\Sigma_g) = \epsilon(\mathbf{e}^g),$$

*where  $\mathbf{e}^g \in A$  represents the  $g$ -th power of the Euler element of (2.9).*

**Lemma 3.7.** *We have*

$$(3.16) \quad \mathbf{e} := m \circ \delta(1) = \lambda^{-1}(\Omega_{1,1}).$$

*Proof.* This follows from

$$\Omega_{1,1}(v) = \sum_{a,b} \Omega_{0,3}(v, e_a, e_b) \eta^{ab} = \sum_{a,b} \eta(v, e_a e_b) \eta^{ab} = \eta(v, \mathbf{e})$$

for every  $v \in A$ . □

*Proof of Proposition 3.6.* Since the starting case  $g = 1$  follows from the above Lemma, we prove the formula by induction, which goes as follows:

$$\begin{aligned} \Omega_{g,1}(v) &= \sum_{a,b} \Omega_{g-1,3}(v, e_a, e_b) \eta^{ab} \\ &= \sum_{i,j,a,b} \Omega_{0,4}(v, e_a, e_b, e_i) \Omega_{g-1,1}(e_j) \eta^{ab} \eta^{ij} \\ &= \sum_{i,j,a,b} \eta(v e_a e_b, e_i) \Omega_{g-1,1}(e_j) \eta^{ab} \eta^{ij} \\ &= \sum_{i,j} \eta(v \mathbf{e}, e_i) \Omega_{g-1,1}(e_j) \eta^{ij} \\ &= \Omega_{g-1,1}(v \mathbf{e}) \\ &= \Omega_{1,1}(v \mathbf{e}^{g-1}) \\ &= \eta(v \mathbf{e}^{g-1}, \mathbf{e}) = \eta(v, \mathbf{e}^g). \end{aligned}$$

□

A closed genus  $g$  surface is obtained by sewing  $g$  genus 1 pieces with one output boundaries to a genus 0 surface with  $g$  input boundaries. Since the Euler element is the output of the genus 1 surface with one boundary, we obtain the same result

$$Z(\Sigma_g) = \Omega_{0,g}(\overbrace{\mathbf{e}, \dots, \mathbf{e}}^g).$$

Finally we have the following:

**Theorem 3.8.** *The value of the 2D TQFT is given by*

$$(3.17) \quad \Omega_{g,n}(v_1, \dots, v_n) = \epsilon(v_1 \cdots v_n \mathbf{e}^g).$$

*Proof.* The argument is the same as the proof of Proposition 3.6:

$$\begin{aligned} \Omega_{g,n}(v_1, \dots, v_n) &= \Omega_{1,n}(v_1 \mathbf{e}^{g-1}, v_2, \dots, v_n) \\ &= \sum_{a,b} \Omega_{0,n+2}(v_1 \mathbf{e}^{g-1}, v_2, \dots, v_n, e_a, e_b) \eta^{ab} \\ &= \epsilon(v_1 \cdots v_n \mathbf{e}^g). \end{aligned}$$

□

**Example 3.9.** Let  $G$  be a finite group. The center of the complex group algebra  $Z\mathbb{C}[G]$  is a semi-simple Frobenius algebra over  $\mathbb{C}$ . For every conjugacy class  $c$  of  $G$ , the sum of group elements in  $c$ ,

$$v(C) := \sum_{u \in C} u \in \mathbb{C}[G],$$

is central and defines an element of  $Z\mathbb{C}[G]$ . Although we do not discuss it any further here, the corresponding TQFT is equivalent to counting problems of character varieties of the fundamental group of  $n$ -punctured topological surface of genus  $g$  into  $G$ .

## 4. THE EDGE-CONTRACTION AXIOMS

In this section we give a formulation of 2D TQFTs based on the edge-contraction operations on cell graphs and a new set of axioms. The main theorem of this section, Theorem 4.7, motivates our construction of the category of cell graphs and the Frobenius ECO functor in Section 5.

**Definition 4.1** (Cell graphs). A connected **cell graph** of topological type  $(g, n)$  is the 1-skeleton (the union of 0-cells and 1-cells) of a cell-decomposition of a connected compact oriented topological surface of genus  $g$  with  $n$  labeled 0-cells. We call a 0-cell a *vertex*, a 1-cell an *edge*, and a 2-cell a *face*, of a cell graph.

**Remark 4.2.** The *dual* of a cell graph is usually referred to as a *ribbon graph*, or a *dessin d'enfant* of Grothendieck. A ribbon graph is a graph with cyclic order assigned to incident half-edges at each vertex. Such assignments induce a cyclic order of half-edges at each vertex of the dual graph. Thus a cell graph itself is a ribbon graph. We note that vertices of a cell graph are labeled, which corresponds to the usual face labeling of a ribbon graph.

**Remark 4.3.** We identify two cell graphs if there is a homeomorphism of the surfaces that brings one cell-decomposition to the other, keeping the labeling of 0-cells. The only possible automorphisms of a cell graph come from cyclic rotations of half-edges at each vertex.

We denote by  $\Gamma_{g,n}$  the set of connected cell graphs of type  $(g, n)$  with labeled vertices.

**Definition 4.4** (Edge-contraction axioms). The **edge-contraction axioms** are the following set of rules for the assignment

$$(4.1) \quad \Omega : \Gamma_{g,n} \longrightarrow (A^*)^{\otimes n}$$

of a multilinear map

$$\Omega(\gamma) : A^{\otimes n} \longrightarrow K$$

to each cell graph  $\gamma \in \Gamma_{g,n}$ . We consider  $\Omega(\gamma)$  an  $n$ -variable function  $\Omega(\gamma)(v_1, \dots, v_n)$ , where we assign  $v_i \in A$  to the  $i$ -th vertex of  $\gamma$ .

- **ECA 0:** For the simplest cell graph  $\gamma_0 = \bullet \in \Gamma_{0,1}$  that consists of only one vertex without any edges, we define

$$(4.2) \quad \Omega(\bullet)(v) = \epsilon(v), \quad v \in A.$$

- **ECA 1:** Suppose there is an edge  $E$  connecting the  $i$ -th vertex and the  $j$ -th vertex for  $i < j$  in  $\gamma \in \Gamma_{g,n}$ . Let  $\gamma' \in \Gamma_{g,n-1}$  denote the cell graph obtained by contracting  $E$ . Then

$$(4.3) \quad \Omega(\gamma)(v_1, \dots, v_n) = \Omega(\gamma')(v_1, \dots, v_{i-1}, v_i v_j, v_{i+1}, \dots, \widehat{v}_j, \dots, v_n),$$

where  $\widehat{v}_j$  means we omit the  $j$ -th variable  $v_j$  at the  $j$ -th vertex, which no longer exists in  $\gamma'$ .

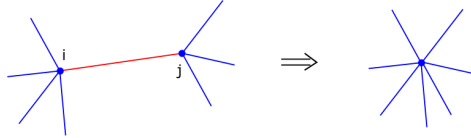

FIGURE 4.1. The edge-contraction operation that shrinks a straight edge connecting Vertex  $i$  and Vertex  $j$ .

- **ECA 2:** Suppose there is a loop  $L$  in  $\gamma \in \Gamma_{g,n}$  at the  $i$ -th vertex. Let  $\gamma'$  denote the possibly disconnected graph obtained by contracting  $L$  and separating the vertex to two distinct vertices labeled by  $i$  and  $i'$ . For the purpose of labeling all vertices, we assign an ordering  $i - 1 < i < i' < i + 1$ .

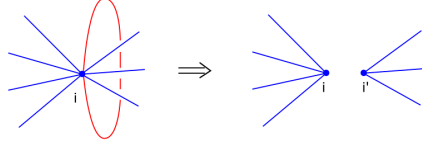

FIGURE 4.2. The edge-contraction operation that shrinks a loop attached Vertex  $i$ .

If  $\gamma'$  is connected, then it is in  $\Gamma_{g-1,n+1}$ . We call  $L$  a *loop of a handle*. We then impose

$$(4.4) \quad \Omega(\gamma)(v_1, \dots, v_n) = \Omega(\gamma')(v_1, \dots, v_{i-1}, \delta(v_i), v_{i+1}, \dots, v_n),$$

where the outcome of the comultiplication  $\delta(v_i)$  is placed in the  $i$ -th and  $i'$ -th slots.

If  $\gamma'$  is disconnected, then write  $\gamma' = (\gamma_1, \gamma_2) \in \Gamma_{g_1, |I|+1} \times \Gamma_{g_2, |J|+1}$ , where

$$(4.5) \quad \begin{cases} g = g_1 + g_2 \\ I \sqcup J = \{1, \dots, \hat{i}, \dots, n\} \end{cases} .$$

In this case  $L$  is a *separating loop*. Here, vertices labeled by  $I$  belong to the connected component of genus  $g_1$ , and those labeled by  $J$  on the other component. Let  $(I_-, i, I_+)$  (reps.  $(J_-, i, J_+)$ ) be reordering of  $I \sqcup \{i\}$  (resp.  $J \sqcup \{i\}$ ) in the increasing order. We impose

$$(4.6) \quad \Omega(\gamma)(v_1, \dots, v_n) = \sum_{a,b,k,\ell} \eta(v_i, e_k e_\ell) \eta^{ka} \eta^{\ell b} \Omega(\gamma_1)(v_{I_-}, e_a, v_{I_+}) \Omega(\gamma_2)(v_{J_-}, e_b, v_{J_+}),$$

which is similar to (4.4), just the comultiplication  $\delta(v_i)$  is written in terms of the basis. Here, cocommutativity of  $A$  is assumed in this formula.

**Remark 4.5.** We do not assume the permutation symmetry of  $\Omega(\gamma)(v_1, \dots, v_n)$ . The cumbersome notation of the axioms is due to keeping track of the ordering of indices.

**Remark 4.6.** Let us define  $m(\gamma) = 2g - 2 + n$  for  $\gamma \in \Gamma_{g,n}$ . The edge-contraction operations are reduction of  $m(\gamma)$  exactly by 1. Indeed, for ECA 1, we have

$$m(\gamma') = 2g - 2 + (n - 1) = m(\gamma) - 1.$$

ECA 2 applied to a loop of a handle produces

$$m(\gamma') = 2(g - 1) - 2 + (n + 1) = m(\gamma) - 1.$$

For a separating loop, we have

$$+) \quad \frac{2g_1 - 2 + |I| + 1}{2g_1 + 2g_2 - 4 + |I| + |J| + 2} = 2g - 2 + n - 1.$$

This reduction is used in the proof of the following theorem.

**Theorem 4.7** (Graph independence). *As the consequence of the edge-contraction axioms, every connected cell graph  $\gamma \in \Gamma_{g,n}$  gives rise to the same map*

$$(4.7) \quad \Omega(\gamma) : A^{\otimes n} \ni v_1 \otimes \cdots \otimes v_n \longmapsto \epsilon(v_1 \cdots v_n \mathbf{e}^g) \in K,$$

where  $\mathbf{e}$  is the Euler element of (2.9). In particular,  $\Omega(\gamma)(v_1, \dots, v_n)$  is symmetric with respect to permutations of indices.

**Corollary 4.8** (ECA implies TQFT). *Define  $\Omega_{g,n}(v_1, \dots, v_n) = \Omega(\gamma)(v_1, \dots, v_n)$  for any  $\gamma \in \Gamma_{g,n}$ . Then  $\{\Omega_{g,n}\}$  is the 2D TQFT associated with the Frobenius algebra  $A$ . Every 2D TQFT is obtained in this way, hence the two descriptions of 2D TQFT are equivalent.*

*Proof of Corollary 4.8 assuming Theorem 4.7.* Since both ECAs and 2D TQFT give the unique value

$$\Omega(\gamma)(v_1, \dots, v_n) = \epsilon(v_1 \cdots v_n \mathbf{e}^g) = \Omega_{g,n}(v_1, \dots, v_n)$$

for all  $(g, n)$  from (3.17), we see that the two sets of axioms are equivalent, and also that the edge-contraction axioms produce every 2D TQFT.  $\square$

To illustrate the graph independence, let us first examine three simple cases.

**Lemma 4.9** (Edge-removal lemma). *Let  $\gamma \in \Gamma_{g,n}$ .*

- (1) *Suppose there is a disc-bounding loop  $L$  in  $\gamma$  (the graph on the left of Figure 4.3). Let  $\gamma' \in \Gamma_{g,n}$  be the graph obtained by removing  $L$  from  $\gamma$ .*
- (2) *Suppose there are two edges  $E_1$  and  $E_2$  between two distinct vertices Vertex  $i$  and Vertex  $j$ ,  $i < j$ , that bound a disc (the middle graph of Figure 4.3). Let  $\gamma' \in \Gamma_{g,n}$  be the graph obtained by removing  $E_2$ .*
- (3) *Suppose two loops,  $L_1$  and  $L_2$ , are attached to the  $i$ -th vertex (the graph on the right of Figure 4.3). If they are homotopic, then let  $\gamma' \in \Gamma_{g,n}$  be the graph obtained by removing  $L_2$  from  $\gamma$ .*

In each of the above cases, we have

$$(4.8) \quad \Omega(\gamma)(v_1, \dots, v_n) = \Omega(\gamma')(v_1, \dots, v_n).$$

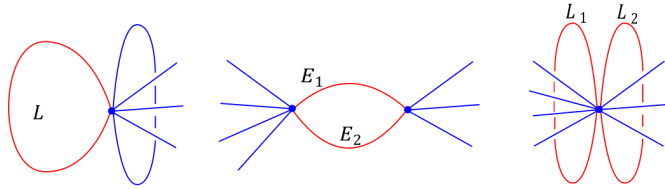

FIGURE 4.3.

*Proof.* (1) Contracting a disc-bounding loop attached to the  $i$ -th vertex creates  $(\gamma_0, \gamma') \in \Gamma_{0,1} \times \Gamma_{g,n}$ , where  $\gamma_0$  consists of only one vertex and no edges. Then ECA 2 reads

$$\begin{aligned} \Omega(\gamma)(v_1, \dots, v_n) &= \sum_{a,b,k,\ell} \eta(v_i, e_k e_\ell) \eta^{ka} \eta^{\ell b} \gamma_0(e_a) \Omega(\gamma')(v_1, \dots, v_{i-1}, e_b, v_{i+1}, \dots, v_n) \\ &= \sum_{a,b,k,\ell} \eta(v_i, e_k e_\ell) \eta^{ka} \eta^{\ell b} \eta(1, e_a) \Omega(\gamma')(v_1, \dots, v_{i-1}, e_b, v_{i+1}, \dots, v_n) \\ &= \sum_{b,k,\ell} \eta(v_i, e_k e_\ell) \delta_1^k \eta^{\ell b} \Omega(\gamma')(v_1, \dots, v_{i-1}, e_b, v_{i+1}, \dots, v_n) \end{aligned}$$

$$\begin{aligned}
&= \sum_{b,\ell} \eta(v_i, e_\ell) \eta^{lb} \Omega(\gamma')(v_1, \dots, v_{i-1}, e_b, v_{i+1}, \dots, v_n) \\
&= \Omega(\gamma')(v_1, \dots, v_{i-1}, v_i, v_{i+1}, \dots, v_n).
\end{aligned}$$

(2) Contracting Edge  $E_1$  makes  $E_2$  a disc-bounding loop at Vertex  $i$ . We can remove it by (1). Note that the new Vertex  $i$  is assigned with  $v_i v_j$ . Restoring  $E_1$  makes the graph exactly the one obtained by removing  $E_2$  from  $\gamma$ . Thus (4.8) holds.

(3) Contracting Loop  $L_1$  makes  $L_2$  a disc-bounding loop. Hence we can remove it by (1). Then restoring  $L_1$  creates a graph obtained from  $\gamma$  by removing  $L_2$ . Thus (4.8) holds.  $\square$

**Remark 4.10.** The three cases treated above correspond to eliminating degree 1 and 2 vertices from the ribbon graph dual to the cell graph. In combinatorial moduli theory, we normally consider ribbon graphs that have no vertices of degree less than 3 [21].

**Definition 4.11** (Reduced graph). We call a cell graph **reduced** if it does not have any disc-bounding loops or disc-bounding bigons. In other words, the dual ribbon graph of a reduced cell graph has no vertices of degree 1 or 2.

We can see from Lemma 4.9 (1) that every  $\gamma_{0,1} \in \Gamma_{0,1}$  gives rise to the same map

$$(4.9) \quad \Omega(\gamma_{0,1})(v) = \epsilon(v).$$

Likewise, Lemma 4.9 (1) and (2) show that every  $\gamma_{0,2} \in \Gamma_{0,2}$  gives the same map

$$\Omega(\gamma_{0,2})(v_1, v_2) = \eta(v_1, v_2).$$

This is because we can remove all edges and loops but one that connects the two vertices, and from ECA 1, the value of the assignment is  $\epsilon(v_1 v_2)$ .

*Proof of Theorem 4.7.* We use the induction on  $m = 2g - 2 + n$ . The base case is  $m = -1$ , or  $(g, n) = (0, 1)$ , for which the theorem holds by (4.9). Assume that (4.7) holds for all  $(g, n)$  with  $2g - 2 + n < m$ . Now let  $\gamma \in \Gamma_{g,n}$  be a cell graph of type  $(g, n)$  such that  $2n - 2 + n = m$ .

Choose an arbitrary straight edge of  $\gamma$  that connects two distinct vertices, say Vertex  $i$  and Vertex  $j$ ,  $i < j$ . By contracting this edge, we obtain by ECA 1,

$$\Omega(\gamma)(v_1, \dots, v_n) = \Omega(\gamma_{g,n-1})(v_1, \dots, v_{i-1}, v_i v_j, v_{i+1}, \dots, \widehat{v}_j, \dots, v_n) = \epsilon(v_1 \dots v_n \mathbf{e}^g).$$

If we have chosen an arbitrary loop attached to Vertex  $i$ , then its contraction by ECA 2 gives two cases, depending on whether the loop is a loop of a handle, or a separating loop. For the first case, by appealing to (2.7) and (2.10), we obtain

$$\begin{aligned}
\Omega(\gamma)(v_1, \dots, v_n) &= \sum_{a,b,k,\ell} \eta(v_i, e_k e_\ell) \eta^{ka} \eta^{lb} \Omega(\gamma_{g-1,n+1})(v_1, \dots, v_{i-1}, e_a, e_b, v_{i+1}, \dots, v_n) \\
&= \sum_{a,b,k,\ell} \eta(v_i e_k, e_\ell) \eta^{ka} \eta^{lb} \Omega(\gamma_{g-1,n+1})(v_1, \dots, v_{i-1}, e_a, e_b, v_{i+1}, \dots, v_n) \\
&= \sum_{a,k} \eta^{ka} \Omega(\gamma_{g-1,n+1})(v_1, \dots, v_{i-1}, e_a, v_i e_k, v_{i+1}, \dots, v_n) \\
&= \sum_{a,k} \eta^{ka} \epsilon(v_1 \dots v_n \mathbf{e}^{g-1} e_a e_b) \\
&= \epsilon(v_1 \dots v_n \mathbf{e}^g).
\end{aligned}$$

For the case of a separating loop, again by appealing to (2.7), we have

$$\begin{aligned}
\Omega(\gamma)(v_1, \dots, v_n) &= \sum_{a,b,k,\ell} \eta(v_i, e_k e_\ell) \eta^{ka} \eta^{\ell b} \Omega(\gamma_{g_1, |I|+1})(v_{I-}, e_a, v_{I+}) \Omega(\gamma_{g_2, |J|+1})(v_{J-}, e_b, v_{J+}) \\
&= \sum_{a,b,k,\ell} \eta(v_i, e_k e_\ell) \eta^{ka} \eta^{\ell b} \epsilon \left( e_a \prod_{c \in I} v_c \mathbf{e}^{g_1} \right) \epsilon \left( e_b \prod_{d \in J} v_d \mathbf{e}^{g_2} \right) \\
&= \sum_{a,b,k,\ell} \eta(v_i e_k, e_\ell) \eta^{ka} \eta^{\ell b} \eta \left( \prod_{c \in I} v_c, e_a \mathbf{e}^{g_1} \right) \epsilon \left( e_b \prod_{d \in J} v_d \mathbf{e}^{g_2} \right) \\
&= \sum_{a,k} \eta^{ka} \eta \left( \prod_{c \in I} v_c \mathbf{e}^{g_1}, e_a \right) \epsilon \left( v_i e_k \prod_{d \in J} v_d \mathbf{e}^{g_2} \right) \\
&= \epsilon \left( v_i \prod_{c \in I} v_c \mathbf{e}^{g_1} \prod_{d \in J} v_d \mathbf{e}^{g_2} \right) \\
&= \epsilon(v_1 \cdots v_n \mathbf{e}^{g_1+g_2}).
\end{aligned}$$

Therefore, no matter how we apply ECA 1 or ECA 2, we always obtain the same result. This completes the proof.  $\square$

**Remark 4.12.** There is a different proof of the graph independence theorem, using a topological idea of deforming graphs similar to the one used in [23].

As we see, the key reason for the graph independence of Theorem 4.7 is the property of the Frobenius algebra  $A$  that we have, namely, commutativity, cocommutativity, associativity, coassociativity, and the Frobenius relation (2.1). These properties are manifest in the following graph operations. Although the next proposition is an easy consequence of Theorem 4.7, we derive it directly from the ECAs so that we can see how the algebraic structure of the Frobenius algebra is encoded into the TQFT. Indeed, the graph-independence theorem also follows from Proposition 4.13. This fact motivates us to introduce the category of cell graphs and the Frobenius ECO functor in the next section.

**Proposition 4.13** (Commutativity of Edge Contractions). *Let  $\gamma \in \Gamma_{g,n}$ .*

- (1) *Suppose Vertex  $i$  is connected to two distinct vertices Vertex  $j$  and Vertex  $k$  by two edges,  $E_j$  and  $E_k$ . The graph we obtain, denoted as  $\gamma' \in \Gamma_{g,n-2}$ , by first contracting  $E_j$  and then contracting  $E_k$ , is the same as contracting the edges in the opposite order. The two different orders of the application of ECA 1 then gives the same answer. For example, if  $i < j < k$ , then we have*

$$(4.10) \quad \Omega(\gamma)(v_1, \dots, v_n) = \Omega(\gamma')(v_1, \dots, v_{i-1}, v_i v_j v_k, v_{i+1}, \dots, \widehat{v}_j, \dots, \widehat{v}_k, \dots, v_n).$$

- (2) *Suppose two loops  $L_1$  and  $L_2$  are connected to Vertex  $i$ . Then the contraction of the two loops in different orders gives the same result.*
- (3) *Suppose a loop  $L$  and a straight edge  $E$  are attached to Vertex  $i$ , where  $E$  connects to Vertex  $j$ ,  $i \neq j$ . Then contracting  $L$  first and followed by contracting  $E$ , gives the same result as we contract  $L$  and  $E$  in the other way around.*

*Proof.* (1) There are three possible cases:  $i < j < k$ ,  $j < i < k$ , and  $j < k < i$ . In each case, the result is replacing  $v_i$  by  $v_i v_j v_k$ , and removing two vertices. The associativity and commutativity of the multiplication of  $A$  make the result of different contractions the same.

(2) There are two cases here: After the contraction of one of the loops, (a) the other loop remains to be a loop, or (b) becomes an edge connecting the two vertices created by the contraction of the first loop.

In the first case (a), the contraction of the two loops makes Vertex  $i$  in  $\gamma$  into three different vertices  $i_1, i_2, i_3$  of the resulting graph  $\gamma'$ , which may be disconnected. The loop contractions in the two different orders produce triple tensor products

$$(1 \otimes \delta)\delta(v_i) = (\delta \otimes 1)\delta(v_i),$$

which are equal by the coassociativity

$$\begin{array}{ccc}
 & A \otimes A & \\
 \delta \nearrow & & \searrow 1 \otimes \delta \\
 A & & A \otimes A \otimes A \\
 \delta \searrow & & \nearrow \delta \otimes 1 \\
 & A \otimes A &
 \end{array}$$

For (b), the contraction of the loops in either order will produce  $m \circ \delta(v_i)$  on the same  $i$ -th slot of the same graph  $\gamma' \in \Gamma_{g-1, n}$ .

(3) This amounts to proving the equation

$$\delta(v_i v_j) = (1 \otimes m)(\delta(v_i), v_j) = (m \otimes 1)(v_j, \delta(v_i)),$$

which is Lemma 2.1. □

**Remark 4.14.** If we have a system of subsets  $\Gamma'_{g,n} \subset \Gamma_{g,n}$  for all  $(g, n)$  that is closed under the edge-contraction operations, then all statements of this section still hold by replacing  $\Gamma_{g,n}$  by  $\Gamma'_{g,n}$ .

**Remark 4.15.** Chen [4] proved the graph independence for a special case of  $A = Z\mathbb{C}[S_3]$ , the center of the group algebra for symmetric group  $S_3$ , by direct computation. This result led the authors to find a general proof of Theorem 4.7.

The edge-contraction operations are associated with gluing morphisms of  $\overline{\mathcal{M}}_{g,n}$  that are different from those in (3.4) and (3.5). ECA 1 of (4.3) is associated with

$$(4.11) \quad \alpha : \overline{\mathcal{M}}_{0,3} \times \overline{\mathcal{M}}_{g,n-1} \longrightarrow \overline{\mathcal{M}}_{g,n}.$$

The handle cutting case of ECA 2 of (4.4) is associated with

$$(4.12) \quad \beta_1 : \overline{\mathcal{M}}_{0,3} \times \overline{\mathcal{M}}_{g-1, n+1} \longrightarrow \overline{\mathcal{M}}_{g,n},$$

and the separating loop contraction with

$$(4.13) \quad \beta_2 : \overline{\mathcal{M}}_{0,3} \times \overline{\mathcal{M}}_{g_1, |I|+1} \times \overline{\mathcal{M}}_{g_2, |J|+1} \longrightarrow \overline{\mathcal{M}}_{g_1+g_2, |I|+|J|+1}.$$

Although there are no cell graph operations that are directly associated with the forgetful morphism  $\pi$  and the gluing maps  $gl_1$  and  $gl_2$ , there is an operation on cell graphs similar to the *connected sum* of topological surfaces.

**Definition 4.16** (Connected sum of cell graphs). Let  $\gamma'$  be a cell graph with the following conditions.

- (1) There is a vertex  $q$  in  $\gamma'$  of degree  $d$ .
- (2) There are  $d$  distinct edges incident to  $q$ . In particular, none of them is a loop.
- (3) There are exactly  $d$  faces in  $\gamma'$  incident to  $q$ .



Given an arbitrary cell graph  $\gamma$  with a degree  $d$  vertex  $p$ , we can create a new cell graph  $\gamma \#_{(p,q)} \gamma'$ , which we call the *connected sum* of  $\gamma$  and  $\gamma'$ . The procedure is the following. We label all half-edges incident to  $p$  with  $\{1, 2, \dots, d\}$  according to the cyclic order of the cell graph  $\gamma$  at  $p$ . We also label all edges incident to  $q$  in  $\gamma'$  with  $\{1, 2, \dots, d\}$ , but this time opposite to the cyclic order given to  $\gamma'$  at  $q$ . Cut a small disc around  $p$  and  $q$ , and connect all half-edges according to the labeling. The result is a cell graph  $\gamma \#_{(p,q)} \gamma'$ .

**Remark 4.17.** The connected sum construction can be applied to two distinct vertices  $p$  and  $q$  of the same graph, provided that these vertices satisfy the required conditions.

**Remark 4.18.** The total number of vertices decreases by 2 in the connected sum. Therefore, two 1-vertex graphs cannot be connected by this construction.

The connected sum construction provides the inverse of the edge-contraction operations as the following diagrams show. It is also clear from these figures that the edge-contraction operations are degeneration of curves producing a rational curve with three special points, as indicated in Introduction.

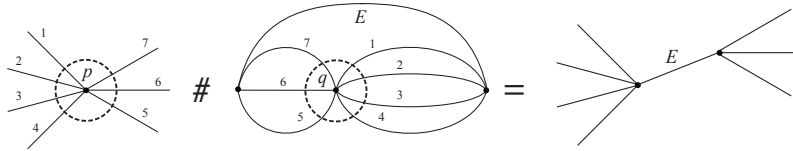

FIGURE 4.4. The connected sum of a cell graph with a particular type  $(0, 3)$  cell graph gives the inverse of the edge-contraction operation on  $E$  that connects two distinct vertices. The connected sum with the  $(0, 3)$  piece has to be done so that the edges incidents on each side of  $E$  match the original graph.

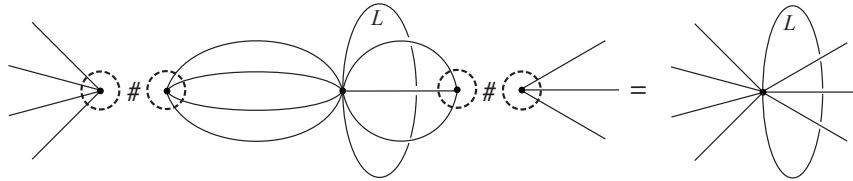

FIGURE 4.5. The edge-contraction operation on a loop  $L$  is the inverse of two connected sum operations, with a type  $(0, 3)$  piece in the middle.

## 5. CATEGORY OF CELL GRAPHS AND FROBENIUS ECO FUNCTORS

In the previous section, we started from a Frobenius algebra  $A$  and constructed the corresponding TQFT through edge-contraction axioms. The key step is the assignment of the linear map  $\Omega(\gamma) : A^{\otimes n} \rightarrow K$  to each cell graph  $\gamma \in \Gamma_{g,n}$ . As we have noticed, edge-contraction operations encode the structure of a Frobenius algebra. These considerations suggest that cell graphs are functors, and edge-contraction operations are natural transformations. In this section, we define the category of cell graphs, and define Frobenius ECO functors, which make edge-contraction operations correspond to natural transformations.

Let  $(\mathcal{C}, \otimes, K)$  be a monoidal category with a bifunctor  $\otimes : \mathcal{C} \times \mathcal{C} \rightarrow \mathcal{C}$  and its left and right identity object  $K \in \text{Ob}(\mathcal{C})$ . The example we keep in mind is the monoidal category  $(\mathbf{Vect}, \otimes, K)$  of vector spaces defined over a field  $K$  with the vector space tensor product

operation. For brevity, we call the bifunctor  $\otimes$  just as a tensor product. A  $K$ -object in  $\mathcal{C}$  is a pair  $(V, f : V \rightarrow K)$  consisting of an object  $V$  and a morphism  $f : V \rightarrow K$ . We denote by  $\mathcal{C}/K$  the category of  $K$ -objects in  $\mathcal{C}$ . A  $K$ -morphism  $h : (V_1, f_1) \rightarrow (V_2, f_2)$  is a morphism  $h : V_1 \rightarrow V_2$  in  $\mathcal{C}$  that satisfies the commutativity

$$(5.1) \quad \begin{array}{ccc} V_1 & \xrightarrow{f_1} & K \\ h \downarrow & & \parallel \\ V_2 & \xrightarrow{f_2} & K \end{array}$$

We note that every morphism  $h : V_1 \rightarrow V_2$  in  $\mathcal{C}$  yields a new object  $(V_1, f_1)$  from a given  $(V_2, f_2)$  as in (5.1). This is the *pull-back* object. The category  $\mathcal{C}/K$  itself is a monoidal category with respect to the tensor product, and the final object  $(K, id_K : K \rightarrow K)$  of  $\mathcal{C}/K$  as its identity object.

We denote by  $\mathcal{F}un(\mathcal{C}/K, \mathcal{C}/K)$  the **endofunctor category**, consisting of monoidal functors

$$\alpha : \mathcal{C}/K \rightarrow \mathcal{C}/K$$

as its objects. Let  $\alpha$  and  $\beta$  be two endofunctors, and  $\tau$  a natural transformation between them. Natural transformations form morphisms in the endofunctor category.

$$\begin{array}{ccc} \begin{array}{ccc} V & & \\ \downarrow h & \searrow f & \\ & & K \\ & \nearrow g & \\ W & & \end{array} & \begin{array}{ccccc} \alpha(V) & \xrightarrow{\tau} & \beta(V) & & \\ \downarrow \alpha(h) & \searrow \alpha(f) & \downarrow \beta(f) & & \\ & & K & \xrightarrow{\tau} & K \\ & \nearrow \alpha(g) & \downarrow \beta(g) & & \\ \alpha(W) & \xrightarrow{\tau} & \beta(W) & & \end{array} \end{array}$$

The final object of  $\mathcal{F}un(\mathcal{C}/K, \mathcal{C}/K)$  is the functor

$$(5.2) \quad \phi : (V, f : V \rightarrow K) \rightarrow (K, id_K : K \rightarrow K)$$

which assigns the final object of the codomain  $\mathcal{C}/K$  to everything in the domain  $\mathcal{C}/K$ . With respect to the tensor product and the above functor  $\phi$  as its identity object, the endofunctor category  $\mathcal{F}un(\mathcal{C}/K, \mathcal{C}/K)$  is again a monoidal category.

**Definition 5.1** (Subcategory generated by  $V$ ). For every choice of an object  $V$  of  $\mathcal{C}$ , we define a category of  $K$ -objects  $\mathcal{T}(V^\bullet)/K$  as the full subcategory of  $\mathcal{C}/K$  whose objects are  $(V^{\otimes n}, f : V^{\otimes n} \rightarrow K)$ ,  $n = 0, 1, 2, \dots$ . We call  $\mathcal{T}(V^\bullet)/K$  the **subcategory generated by  $V$**  in  $\mathcal{C}/K$ .

**Definition 5.2** (Monoidal category of cell graphs). The finite coproduct (or cocartesian) **monoidal category of cell graphs**  $\mathcal{CG}$  is defined as follows.

- The set of objects  $Ob(\mathcal{CG})$  consists of a finite disjoint union of cell graphs.
- The coproduct in  $\mathcal{CG}$  is the disjoint union, and the coidentity object is the empty graph.

The set of morphism  $\text{Hom}(\gamma_1, \gamma_2)$  from a cell graph  $\gamma_1$  to  $\gamma_2$  consists of equivalence classes of sequences of edge-contraction operations and graph automorphisms. For brevity of notation, if  $E$  is an edge connecting two distinct vertices of  $\gamma_1$ , then we simply denote by  $E$  itself as

the edge-contraction operation shrinking  $E$ , as in Figure 4.1. If  $L$  is a loop in  $\gamma_1$ , then we denote by  $L$  the edge-contraction operation of Figure 4.2. Let

$$\widetilde{\text{Hom}}(\gamma_1, \gamma_2) = \left\{ \begin{array}{l} \text{composition of a sequence of edge-contractions} \\ \text{and graph automorphisms that changes } \gamma_1 \text{ to } \gamma_2 \end{array} \right\}.$$

This is the set of words consisting of edge-contraction operations and graph automorphisms that change  $\gamma_1$  to  $\gamma_2$  when operated consecutively. If there is no such operations, then we define  $\widetilde{\text{Hom}}(\gamma_1, \gamma_2)$  to be the empty set. The morphism set  $\text{Hom}(\gamma_1, \gamma_2)$  is the set of equivalence classes of  $\widetilde{\text{Hom}}(\gamma_1, \gamma_2)$ . The equivalence relation in the extended morphism set is generated by the following cases of equivalences.

- (1) Suppose  $\gamma_1$  has a non-trivial automorphism  $\sigma$ . Then for every edge  $E$  of  $\gamma_1$ ,  $E$  and  $\sigma(E)$  are equivalent.
- (2) Suppose Vertex  $i$  of  $\gamma_1 \in \Gamma_{g,n}$  is connected to two distinct vertices Vertex  $j$  and Vertex  $k$  by two edges,  $E_j$  and  $E_k$ . The graph we obtain, denoted as  $\gamma_2 \in \Gamma_{g,n-2}$ , by first contracting  $E_j$  and then contracting  $E_k$ , is the same as contracting the edges in the opposite order. The two words  $E_1E_2$  and  $E_2E_1$  are equivalent.
- (3) Suppose two loops  $L_1$  and  $L_2$  of  $\gamma_1$  are connected to Vertex  $i$ . Then the contraction operations of the two loops in different orders give the same result. The two words  $L_1L_2$  and  $L_2L_1$  are equivalent.
- (4) Suppose a loop  $L$  and a straight edge  $E$  in  $\gamma_1$  are attached to Vertex  $i$ , where  $E$  connects to Vertex  $j$ ,  $i \neq j$ . Then contracting  $L$  first and followed by contracting  $E$ , gives the same result as we contract  $L$  and  $E$  in the other way around. The two words  $EL$  and  $LE$  are equivalent.
- (5) Suppose  $\gamma_1$  has two edges (including loops)  $E_1$  and  $E_2$  that have no common vertices, and  $\gamma_2$  is obtained by contracting them. Then  $E_1E_2$  is equivalent to  $E_2E_1$ .
- (6) Suppose two edges  $E_1$  and  $E_2$  are both incident to two distinct vertices. Then  $E_1E_2$  is equivalent to  $E_2E_1$ .

**Example 5.3.** A few simple examples of morphisms are given below.

$$\begin{aligned} \text{Hom}(\bullet \xrightarrow{E_1} \bullet \xrightarrow{E_2} \bullet, \bullet \text{---} \bullet) &= \{E_1, E_2\}, \\ \text{Hom}(\bullet \xrightarrow{E_1} \bullet \xrightarrow{E_2} \bullet, \bullet) &= \{E_1E_2\}, \\ \text{Hom}\left(\begin{array}{c} E_1 \\ \bullet \text{---} \bullet \\ E_2 \end{array}, \bullet \text{---} \bullet\right) &= \{E_1\} = \{\sigma(E_1)\} = \{E_2\}, \\ \text{Hom}\left(\begin{array}{c} E_1 \\ \bullet \text{---} \bullet \\ E_2 \end{array}, \bullet \bullet\right) &= \{E_1E_2\}. \end{aligned}$$

The cell graph on the left of the third and fourth lines has an automorphism  $\sigma$  that interchanges  $E_1$  and  $E_2$ . Thus as the edge-contraction operation,  $E_2 = E_1 \circ \sigma = \sigma(E_1)$ .

**Remark 5.4.** If  $\gamma \in \Gamma_{g,n}$ , then  $\text{Hom}(\gamma, \gamma) = \{id_\gamma\}$ .

We have seen in the last section that when we have made a choice of a unital commutative Frobenius algebra  $A$ , a cell graph  $\gamma \in \Gamma_{g,n}$  defines a multilinear map  $\Omega_A(\gamma) : A^{\otimes n} \rightarrow K$  subject to edge-contraction axioms. For a different Frobenius algebra  $B$ , we have a different multilinear map  $\Omega_B(\gamma) : B^{\otimes n} \rightarrow K$ , subject to the same axioms. These two maps are unrelated, unless we have a Frobenius algebra homomorphism  $h : A \rightarrow B$ . Theorem 4.7

tells us that we have a  $K$ -morphism of (5.1) which induces  $\Omega_A(\gamma)$  as the pull-back of  $\Omega_B(\gamma)$ .

$$\begin{array}{ccc} A & A^{\otimes n} & \xrightarrow{\Omega_A(\gamma)} & K \\ h \downarrow & \downarrow & & \downarrow \\ B & B^{\otimes n} & \xrightarrow{\Omega_B(\gamma)} & K \end{array}$$

This consideration suggests that  $\Omega(\gamma)$  is a functor defined on the category of Frobenius algebras. But since we are encoding the Frobenius algebra structure into the category of cell graphs, the extra choice of Frobenius algebras is redundant.

We are thus led to the following definition.

**Definition 5.5** (Frobenius ECO functor). An **Frobenius ECO functor** is a monoidal functor

$$(5.3) \quad \omega : \mathcal{CG} \longrightarrow \mathcal{Fun}(\mathcal{C}/K, \mathcal{C}/K)$$

satisfying the following conditions.

- The graph  $\gamma_0 = \bullet$  of (4.2) of type  $(0, 1)$  consisting of only one vertex and no edges corresponds to the identity endofunctor:

$$(5.4) \quad \bullet \longrightarrow (id : \mathcal{C}/K \longrightarrow \mathcal{C}/K).$$

- A graph  $\gamma \in \Gamma_{g,n}$  of type  $(g, n)$  corresponds to a functor

$$(5.5) \quad \gamma \longmapsto [(V, f : V \longrightarrow K) \longrightarrow (V^{\otimes n}, \omega_V(\gamma) : V^{\otimes n} \longrightarrow K)].$$

The Frobenius ECO functor assigns to each edge-contraction operation a natural transformation of endofunctors  $\mathcal{C}/K \longrightarrow \mathcal{C}/K$ .

**Remark 5.6.** The unique construction of the Frobenius ECO functor for  $(\mathbf{Vect}, \otimes, K)$  requires us to generalize our categorical setting to include CohFT of Kontsevich-Manin [18]. Then we will be able to show that this unique functor actually generates all *Frobenius objects* of  $(\mathbf{Vect}, \otimes, K)$ . This topic will be treated in our forthcoming paper.

Let us consider the monoidal (not full) subcategory  $\mathcal{A} \subset (\mathbf{Vect}, \otimes, K)$  consisting of commutative Frobenius algebras.

**Theorem 5.7** (Construction of 2D TQFTs). *There is a canonical Frobenius ECO functor*

$$(5.6) \quad \Omega : \mathcal{CG} \longrightarrow \mathcal{Fun}(\mathcal{A}/K, \mathcal{A}/K).$$

*When we start with a Frobenius algebra  $A$ , this functor generates a network of multilinear maps*

$$\Omega_A(\gamma) : A^{\otimes n} \longrightarrow K$$

*for all cell graphs  $\gamma \in \Gamma_{g,n}$  for all values of  $(g, n)$ . This is the 2D TQFT corresponding to the Frobenius algebra  $A$ .*

*Proof.* This follows from the graph independence of Theorem 4.7.  $\square$

**Acknowledgement.** The authors are grateful to the American Institute of Mathematics in California, the Banff International Research Station, the Institute for Mathematical Sciences at the National University of Singapore, Kobe University, Leibniz Universität Hannover, the Lorentz Center for Mathematical Sciences, Leiden, Max-Planck-Institut für Mathematik in Bonn, Mathematisches Forschungsinstitut Oberwolfach, and Institut Henri Poincaré, for their hospitality and financial support during the authors' stay for collaboration related

to the subjects of this paper. They thank Ruian Chen, Maxim Kontsevich and Shintaro Yanagida for valuable discussions. They also thank the referee for useful comments in improving the manuscript. O.D. thanks the Perimeter Institute for Theoretical Physics, and M.M. thanks the Hong Kong University of Science and Technology and the Simons Center for Geometry and Physics, for financial support and hospitality. During the preparation of this work, the research of O.D. has been supported by GRK 1463 *Analysis, Geometry, and String Theory* at Leibniz Universität Hannover, and Max-Planck-Institut für Mathematik, Bonn. The research of M.M. has been supported by NSF grants DMS-1104734, DMS-1309298, DMS-1619760, DMS-1642515, and NSF-RNMS: Geometric Structures And Representation Varieties (GEAR Network, DMS-1107452, 1107263, 1107367).

## REFERENCES

- [1] L. Abrams, *Two-dimensional topological quantum field theories and Frobenius algebras*, Journal of Knot Theory and Ramifications **5**, 335–352 (2000).
- [2] M.F. Atiyah, *Topological quantum field theory*, [arXiv:hep-th/0312085], Publications Mathématiques de l’I.H.É.S., **68**, 175–186 (1988).
- [3] G. V. Belyi, *On galois extensions of a maximal cyclotomic fields*, Math. U.S.S.R. Izvestija **14**, 247–256 (1980).
- [4] R. Chen, *Topological quantum field theory from the viewpoint of cellular graphs*, Senior Thesis, University of California, Davis (2015).
- [5] R. Dijkgraaf, *A geometric approach to two-dimensional conformal field theory*, Ph.D. Thesis, University of Utrecht (1989).
- [6] R. Dijkgraaf, E. Verlinde, and H. Verlinde, *Loop equations and Virasoro constraints in non-perturbative two-dimensional quantum gravity*, Nucl. Phys. **B348**, 435–456 (1991).
- [7] O. Dumitrescu and M. Mulase, *Quantum curves for Hitchin fibrations and the Eynard-Orantin theory*, Lett. Math. Phys. **104**, 635–671 (2014).
- [8] O. Dumitrescu and M. Mulase, *Quantization of spectral curves for meromorphic Higgs bundles through topological recursion*, arXiv:1411.1023 (2014).
- [9] O. Dumitrescu and M. Mulase, *Lectures on the topological recursion for Higgs bundles and quantum curves*, to appear in the lecture notes series of the National University of Singapore.
- [10] O. Dumitrescu and M. Mulase, *Interplay between opers, quantum curves, WKB analysis, and Higgs bundles*, arXiv:1702.00511 (2017).
- [11] O. Dumitrescu and M. Mulase, *Mirror curve of orbifold Hurwitz numbers*, preprint.
- [12] O. Dumitrescu, M. Mulase, A. Sorokin and B. Safnuk, *The spectral curve of the Eynard-Orantin recursion via the Laplace transform*, in “Algebraic and Geometric Aspects of Integrable Systems and Random Matrices,” Dzhamay, Maruno and Pierce, Eds. Contemporary Mathematics **593**, 263–315 (2013).
- [13] B. Eynard and N. Orantin, *Invariants of algebraic curves and topological expansion*, Communications in Number Theory and Physics **1**, 347–452 (2007).
- [14] A. Grothendieck, *Esquisse d’un programme*, (1984).
- [15] J. L. Harer, *The cohomology of the moduli space of curves*, in Theory of Moduli, Montecatini Terme, 1985 (Edoardo Sernesi, ed.), Springer-Verlag, 1988, pp. 138–221.
- [16] J. Kock, *Frobenius algebras and 2D topological quantum field theories*, Cambridge University Press (2003).
- [17] M. Kontsevich, *Intersection theory on the moduli space of curves and the matrix Airy function*, Communications in Mathematical Physics **147**, 1–23 (1992).
- [18] M. Kontsevich and Y.I. Manin, *Gromov-Witten classes, quantum cohomology, and enumerative geometry*, Communications in Mathematical Physics **164**, 525–562 (1994),
- [19] M. Mirzakhani, *Simple geodesics and Weil-Petersson volumes of moduli spaces of bordered Riemann surfaces*, Invent. Math. **167**, 179–222 (2007).
- [20] M. Mirzakhani, *Weil-Petersson volumes and intersection theory on the moduli space of curves*, J. Amer. Math. Soc. **20**, 1–23 (2007).
- [21] M. Mulase and M. Penkava, *Ribbon graphs, quadratic differentials on Riemann surfaces, and algebraic curves defined over  $\mathbb{Q}$* , The Asian Journal of Mathematics **2** (4), 875–920 (1998).
- [22] M. Mulase and M. Penkava, *Topological recursion for the Poincaré polynomial of the combinatorial moduli space of curves*, Advances in Mathematics **230**, 1322–1339 (2012).
- [23] M. Mulase and J. Yu, *Non-commutative matrix integrals and representation varieties of surface groups in a finite group*, Annales de l’Institut Fourier **55**, 1001–1036 (2005).
- [24] D. Mumford, *Towards an enumerative geometry of the moduli space of curves* (1983), in “Selected Papers of David Mumford,” 235–292 (2004).
- [25] G. Segal, *Geometric aspect of quantum field theory*, Proceedings of the International Congress of Mathematicians, Kyoto, Japan 1990, 1387–1396 (1991).

- [26] D. D. Sleator, R. E. Tarjan, and W. P. Thurston, *Rotation distance, triangulations, and hyperbolic geometry*, Journal of the American Mathematical Society **1**, 647–681 (1988).
- [27] K. Strebel, *Quadratic differentials*, Springer-Verlag, 1984.
- [28] C. Teleman, *The structure of 2D semi-simple field theories*, Inventiones Mathematicae **188**, 525–588 (2012).
- [29] G. 't Hooft, *A planer diagram theory for strong interactions*, Nuclear Physics **B 72**, 461–473 (1974).
- [30] E. Witten, *Two dimensional gravity and intersection theory on moduli space*, Surveys in Differential Geometry **1**, 243–310 (1991).

O. DUMITRESCU: MAX-PLANCK-INSTITUT FÜR MATHEMATIK, BONN, GERMANY

CURRENT ADDRESS: DEPARTMENT OF MATHEMATICS, CENTRAL MICHIGAN UNIVERSITY, MOUNT PLEASANT, MI 48859

*E-mail address:* `dumit1om@cmich.edu`

SIMION STOILOW INSTITUTE OF MATHEMATICS, ROMANIAN ACADEMY, 21 CALEA GRIVITEI STREET, 010702 BUCHAREST, ROMANIA

M. MULASE: DEPARTMENT OF MATHEMATICS, UNIVERSITY OF CALIFORNIA, DAVIS, CA 95616–8633

*E-mail address:* `mulase@math.ucdavis.edu`

KAVLI INSTITUTE FOR PHYSICS AND MATHEMATICS OF THE UNIVERSE, THE UNIVERSITY OF TOKYO, KASHIWA, JAPAN