

# **Report No. 2**

## **The Hamburg Large Scale Geostrophic Ocean General Circulation Model Cycle 1**

Ernst Maier-Reimer and Uwe Mikolajewicz  
Max-Planck-Institut für Meteorologie,  
Bundesstraße 55, D-2000 Hamburg 13

Edited by: Modellberatungsgruppe  
Hamburg, February 1992  
**Revision 1**



## Table of Contents

<b>1</b>	<b>Summary page</b>	<b>1</b>
<b>2</b>	<b>Model description</b>	<b>2</b>
2.1	Model physics and dynamics	2
2.2	Finite difference form	5
<b>3</b>	<b>System description</b>	<b>13</b>
3.1	Flow diagram	13
3.2	Subroutines	16
3.3	List of model variables	20
<b>4</b>	<b>User's manual</b>	<b>21</b>
4.1	Running the model	21
4.2	Postprocessing	23
4.3	Structure of datasets	26
4.3.1	Format for restart and output files	26
4.4	Format for Input Files	29
4.4.1	Input Format for File with Topographic Data	30
<b>5</b>	<b>References</b>	<b>31</b>
	<b>Appendix A List of symbols used in section 2</b>	<b>32</b>
	<b>Appendix B Field code numbers of the ocean model</b>	<b>34</b>

# DKRZ LSG Model Documentation

## **1. Summary page**

### **Short description of the model**

The rationale for the Large Scale Geostrophic ocean circulation model (LSG-OGCM) is based on the observations that for a large scale ocean circulation model designed for climate studies, the relevant characteristic spatial scales are large compared with the internal Rossby radius throughout most of the ocean, while the characteristic time scales are large compared with the periods of gravity modes and barotropic Rossby wave modes. In the present version of the model, the fast modes have been filtered out by a conventional technique of integrating the full primitive equations, including all terms except the nonlinear advection of momentum, by an implicit time integration method. The free surface is also treated prognostically, without invoking a rigid lid approximation. The numerical scheme is unconditionally stable and has the additional advantage that it can be applied uniformly to the entire globe, including the equatorial and coastal current regions.

### **Main authors of the model**

Ernst Maier-Reimer and Uwe Mikolajewicz, MPI , Hamburg, Germany

### **Person(s) responsible for model support at the DKRZ**

Michael Lautenschlager, DKRZ Model User Support Group, Hamburg, Germany

## 2. Model description

### 2.1 Model physics and dynamics

In this section, a short derivation of the filtered model equations is presented (for a more detailed discussion, see Hasselmann 1982, Maier-Reimer and Hasselmann 1987 and Maier-Reimer et al. 1991 ). A list of symbols used in this section can be found in Appendix A.

It is assumed that the spatial resolution of the model is large compared to the internal Rossby radius of deformation ( $\approx 50$  km ), so the nonlinear terms in the Navier-Stokes-equations can be neglected. By further neglecting the vertical friction and applying the hydrostatic and the Boussinesq approximations the equations reduce to:

$$\begin{aligned} u_t - fv + \frac{1}{R \sin \varphi} \frac{p_\lambda}{\rho_0} &= \frac{\tau^\lambda}{\rho_0} + A_h \Delta_h u \\ v_t + fu + \frac{1}{R} \frac{p_\varphi}{\rho_0} &= \frac{\tau^\varphi}{\rho_0} + A_h \Delta_h v \end{aligned} \quad (\text{EQ 1})$$

$$p = g\rho_0 \left( \zeta + \frac{1}{\rho_0} \int_0^z \rho(z') dz' \right)$$

where

$$f = 2\Omega \sin \varphi ,$$

with

$$\frac{\partial u}{\partial z} = \frac{\tau^\lambda}{A_v}, \quad \frac{\partial v}{\partial z} = \frac{\tau^\varphi}{A_v} ,$$

The equation of continuity yields

$$w_z + \frac{1}{R \cos \varphi} \left( (v \cdot \cos \varphi)_\varphi + u_\lambda \right) = 0 \quad (\text{EQ 2})$$

The equation of state is given by the UNESCO-formula (UNESCO, 1981):

$$\rho = \rho(S, T, p) \quad (\text{EQ 3})$$

with the in-situ temperature T given as

$$T = T(\vartheta, p) \quad (\text{EQ 4})$$

On the upper boundary  $\zeta_t = w$  at  $z=0$  is assumed. After neglection of the diffusive terms the principle

of conservation of heat and salt results in

$$\begin{aligned}\vartheta_t + \frac{v}{R}\vartheta_\varphi + \frac{u}{R\cos\varphi}\vartheta_\lambda &= q_\vartheta \\ S_t + \frac{v}{R}S_\varphi + \frac{u}{R\cos\varphi}S_\lambda &= q_S\end{aligned}\tag{EQ 5}$$

The only sources  $q_\vartheta$  and  $q_S$  are located in the surface layer.

The equations are divided into a barotropic and a baroclinic part by vertical averaging.

$$\begin{aligned}\bar{\Upsilon} &= \frac{1}{H} \int_{-H}^0 \Upsilon dz \\ \Upsilon' &= \Upsilon - \bar{\Upsilon}\end{aligned}\tag{EQ 6}$$

Consequently the equation set can be divided into two coupled subsystems, the barotropic and the baroclinic.

### The Barotropic Subsystem

The barotropic subsystem consists of the following equations:

$$\begin{aligned}
 \bar{u}'_t - f\bar{v}' + \frac{g}{R\rho_0 \cos\phi} \zeta_\lambda + \frac{1}{HR \cos\phi} \int_{-H}^0 p'_\lambda dz' &= \frac{\tau^\lambda}{H\rho_0} + A_h \Delta_h \bar{u} \\
 \bar{v}'_t + f\bar{u}' + \frac{g}{R\rho_0} \zeta_\phi + \frac{1}{HR} \int_{-H}^0 p'_\phi dz' &= \frac{\tau^\phi}{H\rho_0} + A_h \Delta_h \bar{v} \\
 \zeta_t - w_o &= 0
 \end{aligned}
 \tag{EQ 7}$$

### The Baroclinic Subsystem

Let  $k$  be the number of the layer ( $k=1$  at the surface), then the baroclinic subsystem consists of the following equations:

$$\begin{aligned}
 u'_t - fv' + \frac{1}{R\rho_0 \sin\phi} p'_\lambda - \frac{1}{HR\rho_0 \sin\phi} \int_{-H}^0 p_\lambda dz' &= \delta_k^1 \frac{\tau^\lambda}{D_1 \rho_0} + A_h \Delta_h u' - \frac{\tau^\lambda}{H\rho_0} \\
 v'_t + fu' + \frac{1}{R\rho_0} p'_\phi - \frac{1}{HR\rho_0} \int_{-H}^0 p_\phi dz' &= \delta_k^1 \frac{\tau^\phi}{D_1 \rho_0} + A_h \Delta_h v' - \frac{\tau^\phi}{H\rho_0}
 \end{aligned}
 \tag{EQ 8}$$

$$\begin{aligned}
 \vartheta_t + \frac{(u' + \bar{u})}{R \cos\phi} \vartheta_\lambda + \frac{(v' + \bar{v})}{R} \vartheta_\phi &= q_\vartheta \\
 S_t + \frac{(u' + \bar{u})}{R \cos\phi} S_\lambda + \frac{(v' + \bar{v})}{R} S_\phi &= q_S
 \end{aligned}
 \tag{EQ 9}$$

$$\int_Z^0 (\rho(S, \vartheta, \bar{p}) - \rho_0) dz' = \frac{p'(z)}{g}
 \tag{EQ 10}$$

where  $D_1$  is the thickness of the uppermost layer.



## 2.2 Finite difference form

### The Grid

The variables of the model are defined on an E-type grid (Arakawa and Lamb 1977). The horizontal grid is staggered (indices given in brackets):

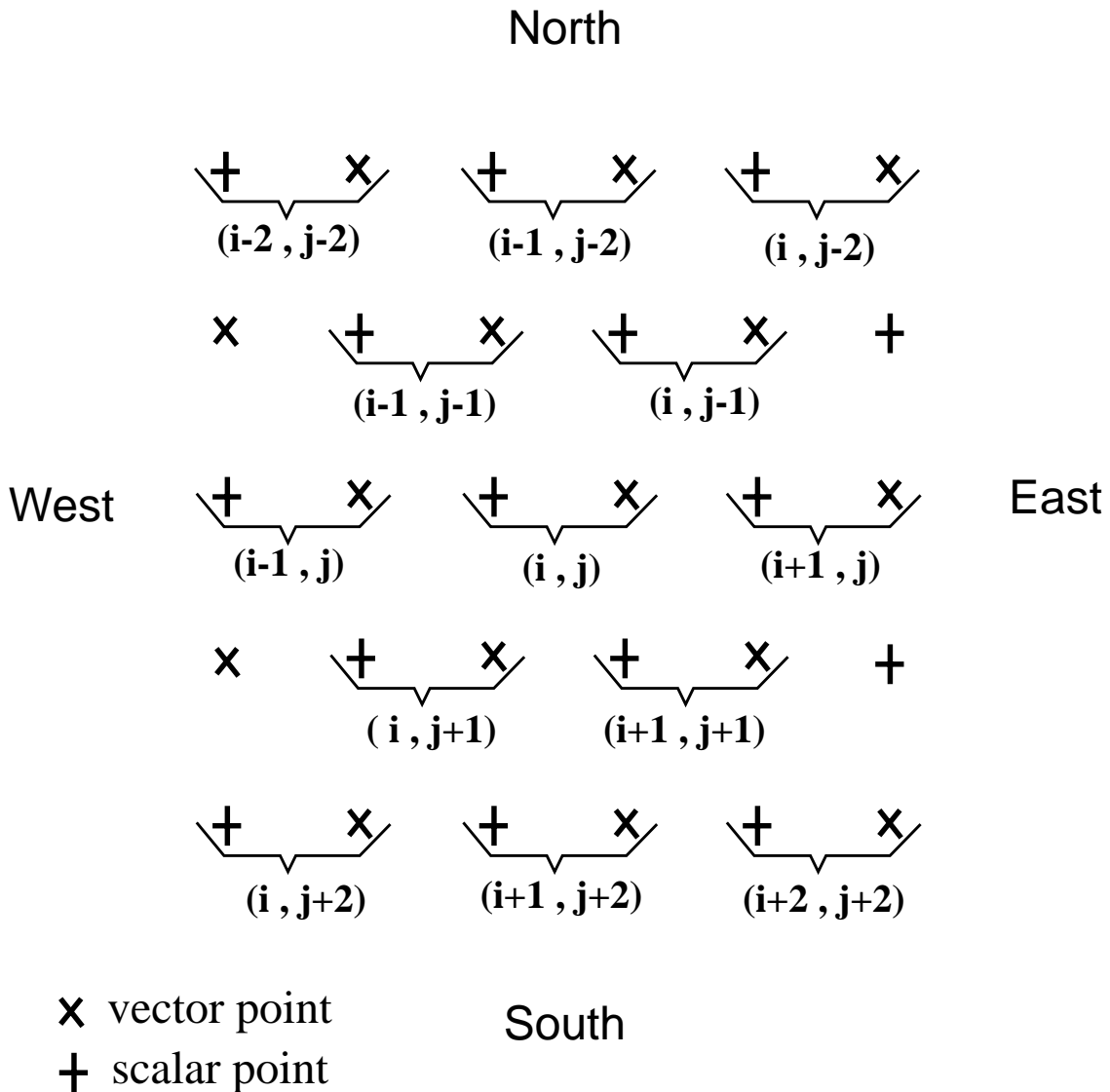

Figure 1 : Horizontal grid used for scalar and vector properties

Variables defined on vector-points are: the components of horizontal velocity and the wind stress. Variables on scalar-points are: potential temperature, salinity, heat and fresh water fluxes, sea surface elevation, pressure and vertical velocity. In order to avoid a potential singularity of the equations near the equator caused by the vanishing Coriolis term, the grid is located in such a way, that the equator is halfway between the two nearest latitude lines.

The depth at the scalar-points is usually defined as the maximum depth of the four surrounding vector-points. This ensures that each wet (ocean) vector-point is surrounded by four wet (ocean) scalar-points. It is possible to assign manually greater depths to single scalar-points, but never a smaller depth!

The w-points (for the vertical component of the velocity) are located between scalar-points. The location of the points on a zonal-vertical section is shown below.

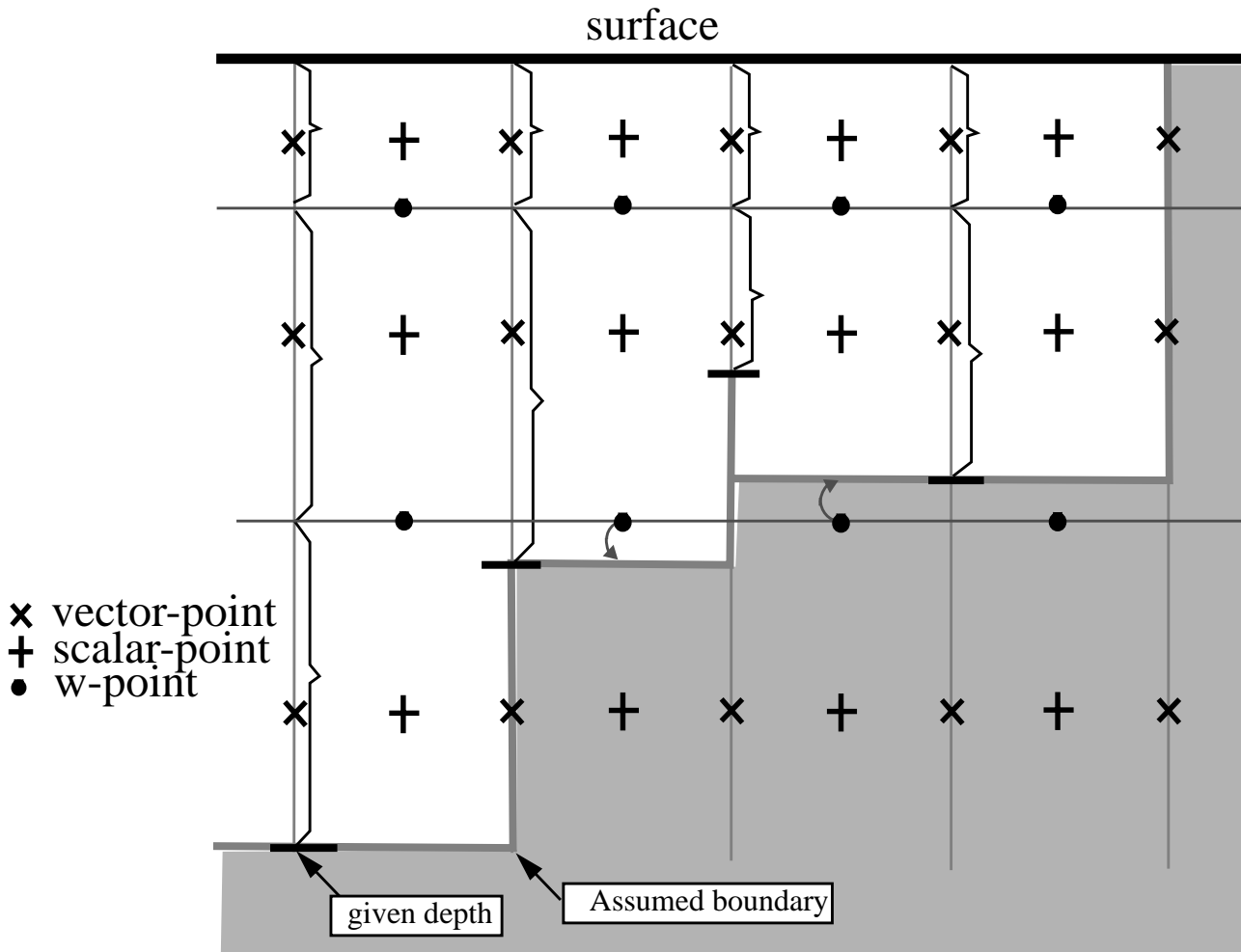

Figure 2 : Distribution of scalar-, vector- and w-points shown in a east-west-vertical cross-section.

Separating the velocity into one barotropic and several baroclinic contributions yields

$$\bar{u} = \frac{1}{H} \sum_{k=1}^{KEN} \Delta z^k u^k$$

$$\bar{v} = \frac{1}{H} \sum_{k=1}^{KEN} \Delta z^k v^k$$
(EQ 11)

(EQ 12)

$$\tilde{u}^k = u^k - u^{k-1}$$

$$\tilde{v}^k = v^k - v^{k-1}$$

$\tilde{u}^k$  and  $\tilde{v}^k$  can be characterized as the k-th baroclinic contribution of the grid.

### The Barotropic Subsystem

For the computation of the barotropic velocities a backward implicit (in time) integration scheme is used. With central differences for spatial derivatives the arrangement of grid points influencing the horizontal velocities is

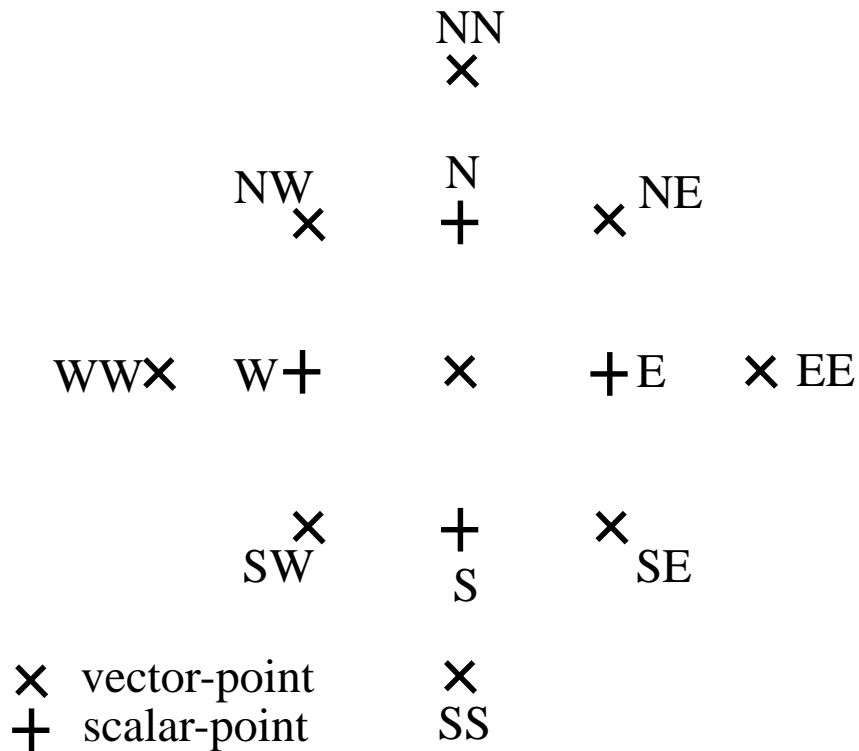

Figure 3 : Arrangement of grid points influencing the horizontal velocities

The position of neighbouring grid points is denoted by the shift in the geographical directions by half grid spaces. EW and NS cancel each other. With  $\Delta\rho$  defined as the difference of the potential density related to the intermediate w-points, the equations reads :

$$\begin{aligned}
& g \frac{\Delta t^2}{\Delta x^2} (2H\bar{u} - H\bar{u}^{EE} - H\bar{u}^{WW}) - f\Delta t\bar{v} \\
& + A_h \frac{\Delta t}{\Delta x \Delta y} (4\bar{u} - \bar{u}^{NW} - \bar{u}^{NE} - \bar{u}^{SW} - \bar{u}^{SE}) \\
& - g \frac{\Delta t^2}{\Delta x^2 \Delta y} (H\bar{v}^{NE} \Delta x^N - H\bar{v}^{NW} \Delta x^N + H\bar{v}^{SW} \Delta x^S - H\bar{v}^{SE} \Delta x^S) \\
& + gH \frac{\Delta t^2}{\Delta x \rho_0} \sum_{k=2}^{KEN} \sum_1^k \left( \frac{\bar{u} \Delta z^k}{\Delta x} \Delta z^1 (\Delta \rho^{E,1-1} + \Delta \rho^{W,1-1}) \right. \\
& \quad - \frac{\bar{u}^{EE} \Delta z^k}{\Delta x} \Delta z^{E,1} \Delta \rho^{E,1-1} - \frac{\bar{u}^{WW} \Delta z^k}{\Delta x} \Delta z^{W,1} \Delta \rho^{W,1-1} \\
& \quad - \frac{\bar{v}^{NE} \Delta z^k}{\Delta x \Delta y} \Delta z^{NE,1} \Delta \rho^{E,1-1} \Delta x^N - \frac{\bar{v}^{SE} \Delta z^k}{\Delta x \Delta y} \Delta z^{SE,1} \Delta \rho^{E,1-1} \Delta x^S \\
& \quad \left. + \frac{\bar{v}^{NW} \Delta z^k}{\Delta x \Delta y} \Delta z^{NW,1} \Delta \rho^{W,1-1} \Delta x^N - \frac{\bar{v}^{SW} \Delta z^k}{\Delta x \Delta y} \Delta z^{SW,1} \Delta \rho^{W,1-1} \Delta x^S \right) \\
& = \frac{\tau^\lambda \Delta t}{\rho_0} + \frac{gH\Delta t}{\Delta x} (\zeta^W - \zeta^E) - \sum_{k=1}^{KEN} \frac{\Delta z^k \Delta t}{\Delta x} (p^E - p^W)
\end{aligned} \tag{EQ 13}$$

$$\begin{aligned}
& g \frac{\Delta t^2}{\Delta y^2} \left( \left( \frac{\Delta x}{\Delta x^N} + \frac{1}{\Delta x^S} \right) H\bar{v} - \frac{\Delta x^{NN}}{\Delta x^N} H\bar{v}^{NN} - \frac{\Delta x^{SS}}{\Delta x^S} H\bar{v}^{SS} \right) + f\Delta t\bar{u} \\
& + A_h \frac{\Delta t}{\Delta x \Delta y} (4\bar{v} - \bar{v}^{NW} - \bar{v}^{NE} - \bar{v}^{SW} - \bar{v}^{SE}) \\
& - g \frac{\Delta t^2}{\Delta y^2} \left( \frac{H\bar{u}^{NE} - H\bar{u}^{NW}}{\Delta x^N} + \frac{H\bar{u}^{SW} - H\bar{u}^{SE}}{\Delta x^S} \right) \\
& + gH \frac{\Delta t^2}{\rho_0} \sum_{k=2}^{KEN} \sum_1^k \left( \frac{\bar{v} \Delta z^k}{\Delta y^2 \Delta x} \Delta z^1 (\Delta x^N \Delta \rho^{N,1-1} + \Delta x^S \Delta \rho^{S,1-1}) \right. \\
& \quad - \frac{\bar{v}^{NN} \Delta z^k \Delta x^{NN}}{\Delta y^2 \Delta x^N} \Delta z^{N,1} \Delta z^{N,1} \Delta \rho^{N,1-1} - \frac{\bar{v}^{SS} \Delta z^k \Delta x^{SS}}{\Delta y^2 \Delta x^S} \Delta z^{S,1} \Delta z^{S,1} \Delta \rho^{S,1-1} \\
& \quad - \frac{\bar{u}^{NE} \Delta z^k}{\Delta x^N \Delta y} \Delta z^{NE,1} \Delta \rho^{N,1-1} - \frac{\bar{u}^{SE} \Delta z^k}{\Delta x^S \Delta y} \Delta z^{SE,1} \Delta \rho^{S,1-1} \\
& \quad \left. + \frac{\bar{u}^{NW} \Delta z^k}{\Delta x^N \Delta y} \Delta z^{NW,1} \Delta \rho^{N,1-1} - \frac{\bar{u}^{SW} \Delta z^k}{\Delta x^S \Delta y} \Delta z^{SW,1} \Delta \rho^{S,1-1} \right) \\
& = \frac{\tau^\theta \Delta t}{\rho_0} + \frac{gH\Delta t}{\Delta y} (\zeta^S - \zeta^N) - \sum_{k=1}^{KEN} \frac{\Delta z^k \Delta t}{\Delta y} (p^N - p^S)
\end{aligned} \tag{EQ 14}$$

The equations are solved directly by Gaussian elimination without pivoting. In order to save computer time the triangularisation of the band matrix is done only once in the beginning of a run ( SUBROUTINE MATRIT ) and the elimination factors are kept in memory. During the run the right hand side of the equation system is computed in SUBROUTINE PREFOR1 and the resulting triangularised equation matrix is solved in SUBROUTINE UVTROP (for details see Maier-Reimer et al., 1991).

### Computation of the Baroclinic Velocities

The hydrostatic approximation yields

$$p(z) = g\rho_0\zeta + \int_z^0 g\rho(s) ds \quad (\text{EQ 15})$$

A density anomaly  $\delta\rho$  at depth  $D$  contributes  $g\delta\rho((B-D)/B)$  to the forcing of the barotropic motion,  $+g\delta\rho(D/B)$  to all baroclinic motion below  $D$  and  $-g\delta\rho((B-D)/B)$  to the baroclinic motion above  $D$ .

For the formulation of the implicit time discretization we perform the transformation:

$$V_1 = \sum_{k=1}^N \Delta z_k u_k, \quad (\text{EQ 16})$$

and

$$V_k = H_k (u_k - u_{k-1}), k = 2, \dots, N \quad (\text{EQ 17})$$

where  $H_k = D_k((B-D_k)/B)$ , and  $D_k = \sum_{n=1}^{k-1} \Delta z_n (D_1 = 0)$  corresponds to the reduced depth of a two layer mode defined at the depth  $D_k$

The inverse transformation is given by

$$u = \sum_{n=k}^N V_k / (B - D_k) - \sum_{n=1}^{k-1} V_k / D_k + \hat{u}$$

The layer thickness  $\Delta z_k$  is normally defined by the computation levels. However, at locations where the assumed topography intersects the levels of computation, a modified layer thickness is introduced in order to obtain smoother variations of depth than could otherwise be achieved for the low number of levels of our model.

$V_1$  is the barotropic mode, while for  $k > 1$   $V_k$  represents the  $N-1$  computational baroclinic modes of the model grid. They are driven by the vertical shear of the horizontal pressure gradients, i.e. the local density gradients. Each baroclinic mode represents a flow field with vanishing  $\int u \, dz$ .

For the time discretization, the modes are treated separately. For each mode  $k \geq 2$  the convergence  $W_k = \partial_i V_{ik}$  creates a profile of vertical velocity at levels  $m$ :

$$\begin{aligned} w &= 0 && \text{at the bottom} && \text{(EQ 18)} \\ w_{km} &= W_k \left( \frac{D - D_m}{D - D_{k-1}} \right) && \text{for } D_m > D_{k-1} \\ w_{km} &= W_k \frac{D_m}{D_{k-1}} && \text{for } D_m < D_{k-1} \end{aligned}$$

(For  $k=1$ ,  $w$  at the surface is the rate of change of sea level). The vertical velocity profiles  $w_{k1}$  with  $k \neq 1$  provide the coupling between the different modes with a one time step delay.

The decoupled mode equations can be written:

$$\partial_t V_i + f \varepsilon_{ij} V_j + \partial_i p = F \quad \text{(EQ 19)}$$

$$\partial_t p + c^2 \partial_i V_i = 0 \quad \text{(EQ 20)}$$

where the phase velocity  $c$  is determined by the overall stratification, but with the strongest contribution coming from the level associated with the mode under consideration (including air-sea difference for the barotropic mode).

The arrangement of grid-points relevant for the computation of the baroclinic modes is the same as for the barotropic velocities (see previous subsection). In the model, the resulting system of equations for the different modes is then given by:

$$\begin{aligned}
 & -f\tilde{v}^k - \frac{\Delta x^2}{\Delta y^2 \Delta t} \tilde{u}^{\text{old}} + \frac{A_h}{\Delta x \Delta y} (4\tilde{u}^k - \tilde{u}^{\text{NW},k} - \tilde{u}^{\text{NE},k} - \tilde{u}^{\text{SE},k} - \tilde{u}^{\text{SW},k}) \\
 & + \frac{H^U H^L \Delta t}{H \Delta x \rho_0} \left( \frac{(M^{\text{E},k} + M^{\text{W},k}) \tilde{u}^k - M^{\text{E},k} \tilde{u}^{\text{EE},k} - M^{\text{W},k} \tilde{u}^{\text{WW},k}}{\Delta x} \right. \\
 & \quad + \frac{M^{\text{W},k} \Delta x^{\text{N}} \tilde{v}^{\text{NW},k} - M^{\text{E},k} \Delta x^{\text{N}} \tilde{v}^{\text{NE},k}}{\Delta x \Delta y} \\
 & \quad \left. + \frac{M^{\text{E},k} \Delta x^{\text{S}} \tilde{v}^{\text{SE},k} - M^{\text{W},k} \Delta x^{\text{S}} \tilde{v}^{\text{SW},k}}{\Delta x \Delta y} \right) \\
 & = \delta_k^2 \cdot \frac{\tau^\lambda}{\rho_0} + \left( \frac{H^U H^L}{H} \cdot \frac{\tilde{p}^{\text{W},k, \text{old}} - \tilde{p}^{\text{E},k, \text{old}}}{\Delta x \rho_0} \right)
 \end{aligned} \tag{EQ 21}$$

$$\begin{aligned}
 & f\tilde{u}^k - \frac{\Delta x^2}{\Delta y^2 \Delta t} \tilde{v}^{\text{old}} + \frac{A_h}{\Delta x \Delta y} (4\tilde{v}^k - \tilde{v}^{\text{NW},k} - \tilde{v}^{\text{NE},k} - \tilde{v}^{\text{SE},k} - \tilde{v}^{\text{SW},k}) \\
 & + \frac{H^U H^L \Delta t}{H \Delta x \rho_0} \left( \frac{M^{\text{N},k-1} \Delta x^{\text{N}} \tilde{v}^k + M^{\text{S},k-1} \Delta x^{\text{S}} \tilde{v}^k}{\Delta x \Delta y} \right. \\
 & \quad - \frac{M^{\text{N},k-1} \Delta x^{\text{NN}} \tilde{v}^{\text{NN},k}}{\Delta x^{\text{N}} \Delta y} - \frac{M^{\text{S},k-1} \Delta x^{\text{SS}} \tilde{v}^{\text{SS},k}}{\Delta x^{\text{S}} \Delta y} \\
 & \quad \left. - \frac{M^{\text{N},k-1} \Delta x (\tilde{v}^{\text{NE},k} - \tilde{v}^{\text{NW},k})}{\Delta x^{\text{N}}} + \frac{M^{\text{S},k-1} \Delta x (\tilde{v}^{\text{SE},k} - \tilde{v}^{\text{SW},k})}{\Delta x^{\text{S}}} \right) \\
 & = \delta_k^2 \cdot \frac{\tau^\phi}{\rho_0} + \left( \frac{H^U H^L}{H} \cdot \frac{\tilde{p}^{\text{S},k, \text{old}} - \tilde{p}^{\text{N},k, \text{old}}}{\Delta y \rho_0} \right)
 \end{aligned} \tag{EQ 22}$$

where  $M$  is given by the relation:

$$M = \sum_{k=1}^{\text{KEN}-1} \left( \sum_{l=1}^k g \Delta \rho^l \frac{H^{\text{U},l}}{H^{\text{U},k}} + \sum_{l=k+1}^{\text{KEN}-1} g \Delta \rho^l \frac{H^{\text{L},l}}{H^{\text{L},k}} \right) \tag{EQ 23}$$

In this system the SUBROUTINE GEOSTR is solved by iteration. The baroclinic velocities are obtained by the composition:

$$u^{,k} = \sum_{l=2}^k \frac{\tilde{u}^k}{H^L} - \sum_{l=k+1}^{KEN} \frac{\tilde{u}^k}{H^U} \quad (\text{EQ 24})$$

$$v^{,k} = \sum_{l=2}^k \frac{\tilde{v}^k}{H^L} - \sum_{l=k+1}^{KEN} \frac{\tilde{v}^k}{H^U}$$

The vertical velocities are computed in SUBROUTINE CONT1 from the equation of continuity.

### The advection scheme

For the advection of heat and salt, an implicit component upwind advection scheme is used together with horizontal diffusion. This scheme has a rather high numerical diffusion, but it can be shown that

- total heat and salt content are strictly conserved (Bacastow and Maier-Reimer, 1990)
- for practical applications the diffusion is tolerable (Maier-Reimer et al., 1991)

For reduction of grid separations, an explicit diffusion of 200 m<sup>2</sup>/s is introduced between points with even and odd j-indices.



### 3. System description

#### 3.1 Flow diagram

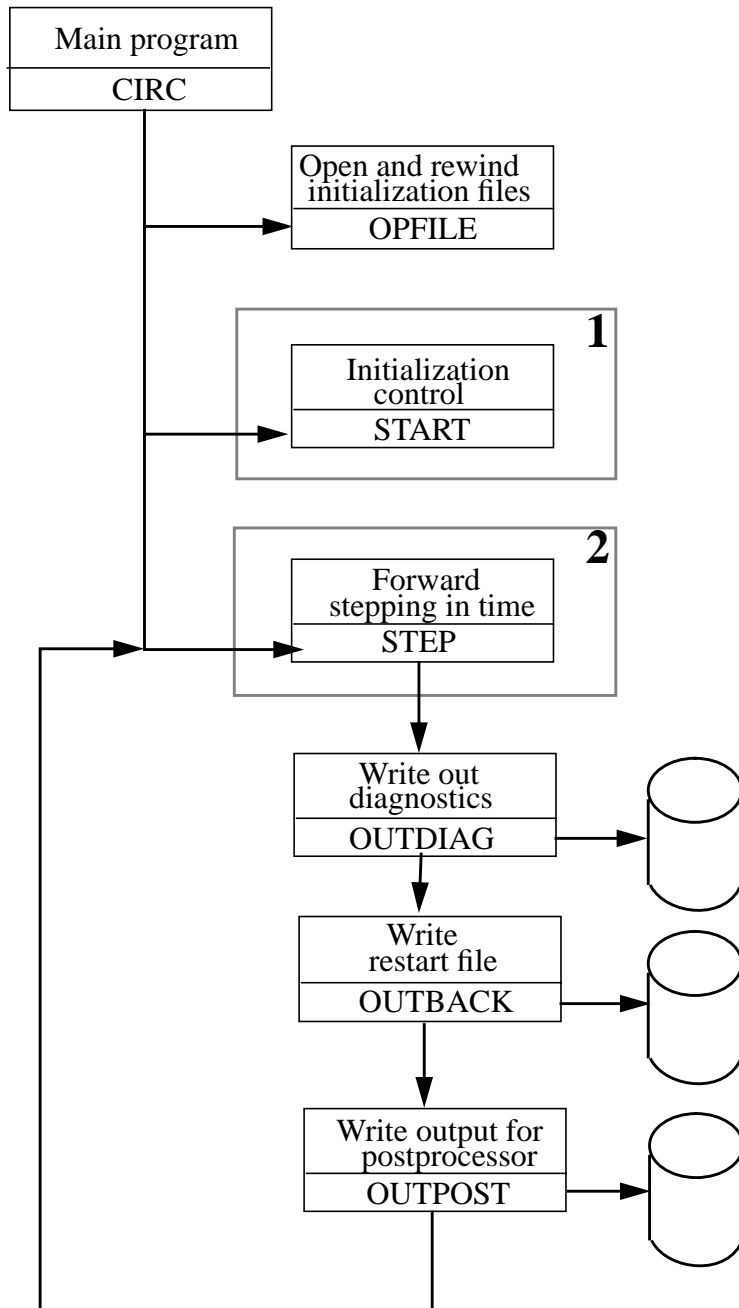

1:

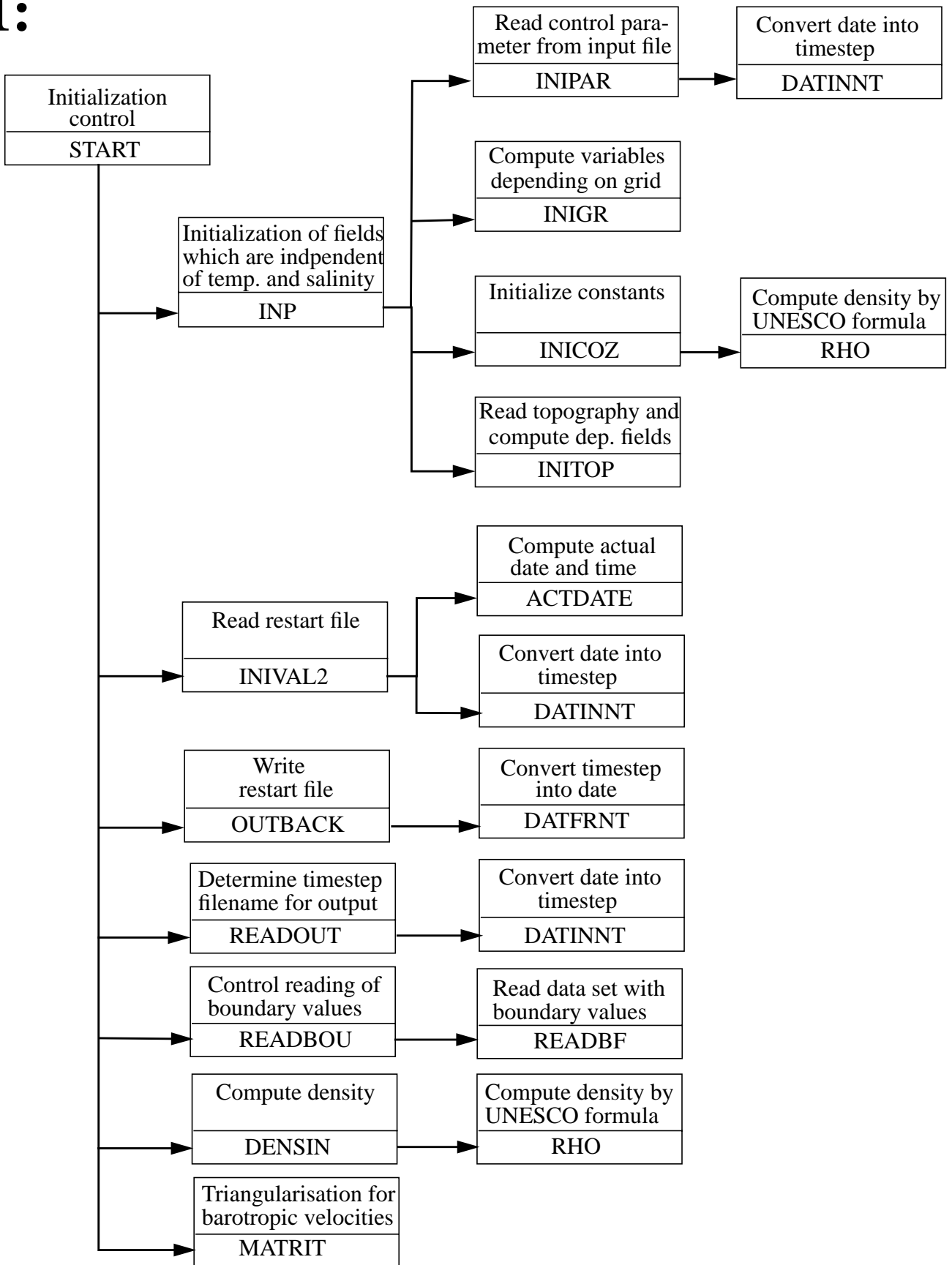

# 2:

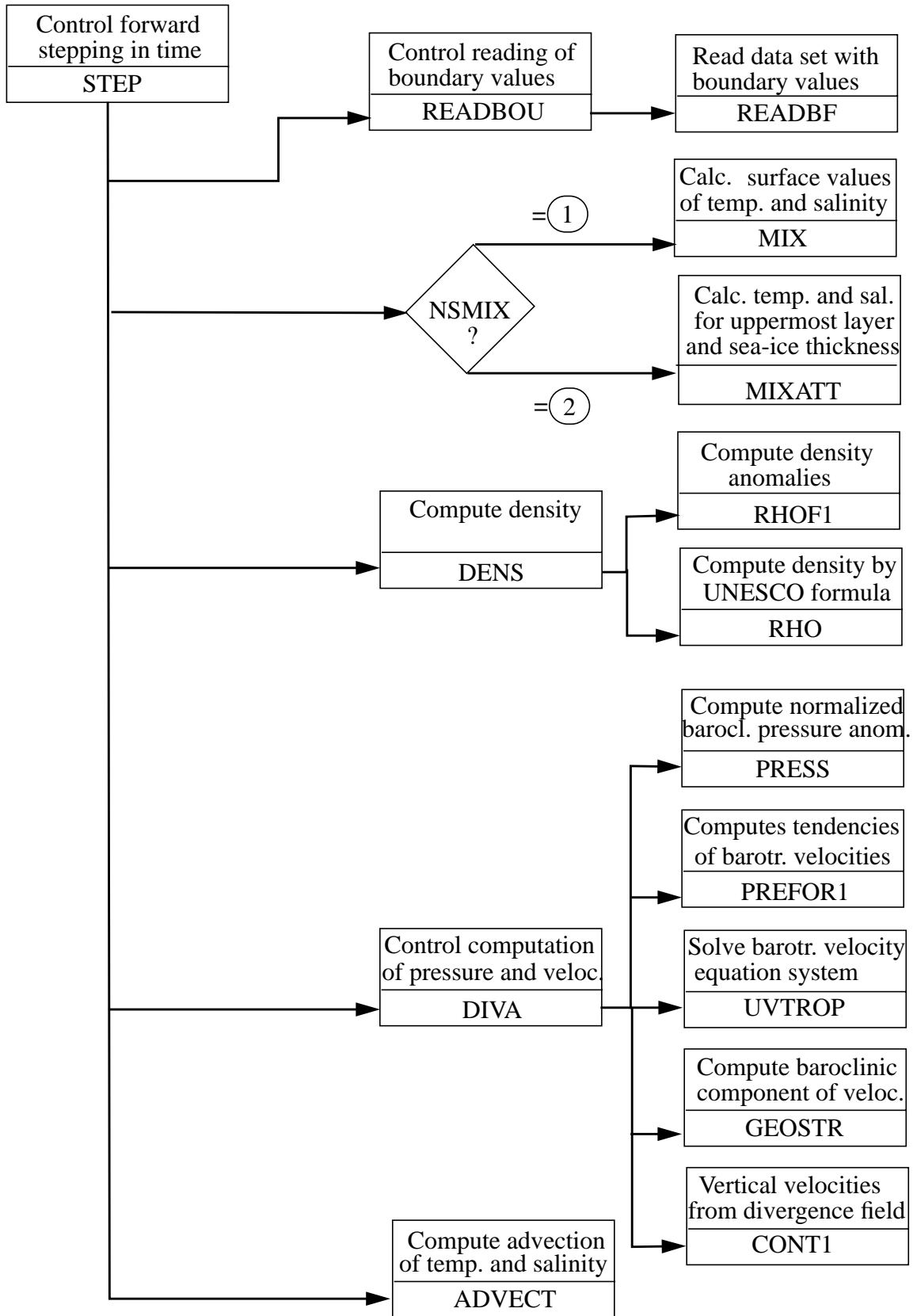

## 3.2 Subroutines

The individual components of the program are listed below in alphabetical order. The name of the main program is CIRC.

### SUBROUTINE ACTDATE(KDATE,KTIME)

The SUBROUTINE ACTDATE gives back the actual date KDATE (format YYMMDD) and time KTIME (format HHMMSS).

### SUBROUTINE ADVECT

This subroutine computes advection for potential temperature and salinity.

A forward implicit (in time) component upwind scheme is used together with horizontal diffusion.

The resulting equations are solved by iteration. For a more detailed description of the method used see section 2.2 .

### PROGRAM CIRC

This is the main program. It controls the run.

### SUBROUTINE CONT1

This subroutine computes the vertical velocities from the divergence of the horizontal velocities.

### SUBROUTINE DATFRNT(NTT,IYEAR,IDATE)

This subroutine converts the number of time steps NTT to a date IDATE (format MMDD) and a year IYEAR (format YYYYYY).

### SUBROUTINE DATINNT(NTT,IYEAR,IDATE)

This subroutine converts a date IDATE (format MMDD) and a year IYEAR (format YYYYYY) to a number of time steps NTT.

### SUBROUTINE DENS

This subroutine computes the density from potential temperature and salinity (UNESCO, 1981).

If the resulting density distribution is unstable, convective adjustment is applied and new potential temperatures and salinities are computed. This process is done only once at each time step.

### SUBROUTINE DENSIN

DENSIN fulfills the same purpose as DENS, but does not apply convective adjustment. DENSIN is only used in the initialisation phase.

### SUBROUTINE DIVA

DIVA controls the computation of pressure and velocities and computes the total velocities from barotropic and baroclinic components.

**SUBROUTINE GEOSTR**

This subroutine computes the baroclinic component of the velocities by decomposition into baroclinic modes. The resulting equation system, resulting from the forward (in time ) implicit formulation is solved by iteration.

**SUBROUTINE INICOZ**

INICOZ initializes thermodynamic constants of the ocean.

**SUBROUTINE INIGR**

INIGR computes several variables depending on the grid spacing, e.g. the adaption coefficients for temperature (ADAPT) and salinity (ADAPS) used by the Newtonian relaxation algorithm.

**SUBROUTINE INIPAR**

This subroutine reads the control parameters from an input file (e.g. time step, names of files, layer depths etc.).

**SUBROUTINE INITOP**

INITOP reads the topography and computes several topography-dependent variables.

**SUBROUTINE INIVAL2(NOREAD,YFILE)**

This subroutine reads a restart file produced by SUBROUTINE OUTBACK (filename YFILE, logical unit number NOREAD) containing variables such as potential temperature, salinity, barotropic velocities, baroclinic modes, ice distribution and surface elevation. It checks whether the chosen parameters match the input file.

**SUBROUTINE INP**

INP controls the initialisation of variables which are not dependent on the distribution of potential temperature and salinity.

**SUBROUTINE MATRIT**

The subroutine MATRIT performs the triangularisation of the system of equations for the barotropic velocities. It is called only once at the beginning of the program run and is a relatively time consuming part of the initialisation of the program. The matrix has a band structure and only a relatively small section is simultaneously kept in memory. After elimination of the first column, the result is stored and the section moves down by one. This process is repeated until total triangularisation is performed. The triangularised matrix (in band form), the elimination factors and scaling factors computed during triangularisation are later used in the subroutines PREFOR1 and UVTROP to compute the barotropic velocities. **IMPORTANT:** To avoid numerical instabilities, the calculations should be carried out with an accuracy not less than 64 bit.

**SUBROUTINE MIX**

MIX calculates the surface values of temperature and salinity from the prescribed boundary fields to the model. MIX is called when NSMIX=1. MIX is driven by sea surface temperature and surface salinity and - if NSFLU is chosen to be 1 - by heat and net fresh water fluxes. In this case the surface elevation ZETA is altered according to fresh water flux. The coupling to SST and SSS is done via a Newtonian relaxation (formulated implicitly) with the coupling coefficients ADAPT [ $\text{W/m}^2/\text{K}$ ] for temperature and ADAPS [ $\text{m/s}$ ] for salinity. MIX does not contain any ice model, so the ice thickness SICE is equal to 0 after leaving this subroutine.

**SUBROUTINE MIXATT**

This subroutine is called when NSMIX=2. MIXATT computes the temperature and salinity values of the uppermost layer for the model. The expected input values are the air temperature (2m) and salinity in the uppermost layer. In an implicit formulation, the input of heat and salt is performed via Newtonian coupling with the coefficients ADAPT for temperature [ $\text{W/m}^2/\text{K}$ ] and ADAPS for salinity [ $\text{m/s}$ ]. MIXATT contains a simple thermodynamic ice model, in which the ice thickness SICE is computed. The basic assumption is that the heat flux is inversely proportional to the ice thickness. If the ice grows, brine is released that sinks down to the second layer.

**SUBROUTINE OPFILE**

OPFILE opens and rewinds files during the initialisation phase.

**SUBROUTINE OUTBACK(KTAPE,KTSWIT,KSWIT,YFILE)**

This subroutine writes a restart file (unit KTAPE, file YFILE) in the format described in section 4.3.1. A code for the name of the restart file with the last successful backup and information whether this run has terminated normally (KSWIT) is stored on unit KTSWIT. The frequency for backups is chosen in PROGRAM CIRC with the variable NTBACK.

**SUBROUTINE OUTDIAG**

This subroutine writes some diagnostic parameters for a quick look on file OUTPUT. This enables the user to have a first check whether the job has run properly. Some of the output parameters are:

- the maximum of the barotropic stream function.
- the average potential temperature in certain layers.
- the average salinity in certain layers.
- the average kinetic energy in certain layers.
- the sum of the upward and downward transports through certain layers.
- the maxima and minima of temperature, salinity and ice thickness  
in the surface layer.

How often OUTDIAG is called depends on the choice of NTCONT. If  $\text{MOD}(\text{NTCONT}, \text{NT})$  is 0 (with NT the actual time step), then OUTDIAG is called.

**SUBROUTINE OUTPOST**

This subroutine writes history output files for the postprocessing. During the run of the program, each write-up produces a file with a characteristic and unique filename, which has been generated by subroutine READOUT. The output format is described in section 4.3.1 . The standard output contains:

- potential temperature (in Kelvin).
- salinity
- velocity components
- barotropic velocities
- surface elevation
- ice thickness
- number of convective adjustment events
- depth in vector-points
- depth in scalar-points

**SUBROUTINE PREFOR1(B)**

PREFOR1 computes the array B containing the right hand side of the equation system for the barotropic velocities. The barotropic velocities are computed in UVTROP.

**SUBROUTINE PRESS**

This subroutine computes the normalized baroclinic pressure anomaly defined as

$$p' = \sum g \frac{(\rho - \rho_{\text{ref}})}{\rho_0}$$

**SUBROUTINE READBF(KPAR, KTAPE, KNT, PFIELD)**

This subroutine reads one array PFIELD with boundary values (e.g. wind stress, surface temperature, surface salinity, heat and fresh water fluxes) identified by the field code KPAR and the timestep KNT from unit KTAPE. It controls whether the file contains the correct parameter. READBF determines the positioning of the tape according to the requested date itself. For information about the data format, see section 4.4 .

**SUBROUTINE READBOU(KNT)**

This subroutine controls the reading of boundary values ( wind stress, surface temperature, surface salinity, heat and fresh water fluxes) at timestep KNT from the different tape units.

**SUBROUTINE READOUT(YTEXT)**

READOUT gives the number of the time step to produce the next output and constructs the name of the output file (YTEXT). The dates for the output are read from the local file CONTOUT.

**FUNCTION RHO(S,T,P)**

This function computes the density as a function of potential temperature T, salinity S and pressure P according to UNESCO (1981).

**SUBROUTINE RHOF1(S,T,P,RH)**

This subroutine computes the density anomaly RH (defined as actual in-situ density - reference density from 2 deg. Celsius and 35 ‰) for an array as a function of potential temperature T, salinity S and pressure P according to UNESCO (1981).

**SUBROUTINE START**

START controls the initialisation of the program.

**SUBROUTINE STEP**

STEP controls the execution of one time step.

**SUBROUTINE UVTROP(B1)**

This subroutine solves the system of equations for the barotropic velocities directly by elimination. The input array B1 contains the right hand side of the equation system for the barotropic velocities computed in SUBROUTINE PREFOR1. The necessary elimination factors and the values of the triangularised band matrix are computed once in the beginning of the run by the subroutine MATRIT. In addition the new surface elevation and the barotropic stream function plus its maximum are computed.

**3.3 List of model variables**

A complete list of model variables used can be obtained from the documented source code.



## 4. User's manual

### 4.1 Running the model

The LSG-OGCM and a set of standard forcing fields are available on the Cray-2S computer. UNIX-scripts (including comments) to create an executable model version and to run the model are available additionally on following locations:

/pool/POST/ocean	model and forcing
/pool/POST/ocean/mkmodel	to create an executable model version
/pool/POST/ocrun.job	to run the model

Several parameters must be specified via namelist in the script running the model, namely:

#### NSMIX

NSMIX selects the SUBROUTINE chosen for computation of potential temperature and salinity in the surface layer.

If NSMIX=1, the SUBROUTINE MIX is called. MIX does not include any ice model. If a temperature is chosen as input data (see NSFLU), the model expects to find a sea surface temperature on the boundary file for temperature.

If NSMIX=2, the SUBROUTINE MIXATT is called. MIXATT includes a thermodynamic ice model and expects to find air temperatures as input on the boundary file.

#### NSFLU

This parameter decides, whether the model is driven by Newtonian coupling to a prescribed temperature and salinity in the surface layer or by prescribed heat and fresh water fluxes.

If NSFLU=0, only prescribed temperature and salinity are used for Newtonian coupling. The model will not read the files containing fluxes.

The choice of NSFLU=1 is only allowed when NSMIX=1. Sea surface temperature, surface salinity and prescribed net heat and fresh water fluxes are read from the boundary files. Default is, that pot. temperature and salinity of the first layer are determined by the fluxes alone. By giving the adaptation coefficients for temperature (ADAPT) and salinity (ADAPS) in the SUBROUTINE MIX a value greater than zero, it is possible to use additional Newtonian coupling to sea surface temperature and surface salinity.

NSFLU=2 represents mixed boundary conditions. The temperature is determined by Newtonian coupling alone, the salinity is computed from net fresh water fluxes. It is possible to include Newtonian coupling for salinity too by giving the adaptation coefficient ADAPS a value greater than 0.

NEWST, IYEAR and IDATE

These parameters determine the number of time steps to be executed in this run. NEWST gives the maximum number of time steps to be executed in this run. IYEAR and IDATE give the year and the date (format -MMDD) when to stop. If either the maximum number of allowed timesteps or the final date is reached, the model will stop.

NTCONT

If the condition  $\text{MOD}(\text{NT}, \text{NTCONT})=0$  is fulfilled, with NT as the number of the actual time step, diagnostic output is produced.

An example for a diagnostic output is given below:

```

TIMESTEP NUMBER      48120   YEAR:   4009 DATE (MMDD):  1230
MAXIMUM OF BAROTROPIC STREAMFUNCTION IN M**3/S 0.174938E+09 AT LON= 164. LAT= -26.
LAYER DEPTH IN M          75.00      250.00      700.00      2000.00      4000.00
AV.POT.TEMP.(C)          14.4732995  10.3859115  5.8452258  3.1404344  2.2354247
AV.SALINITY IN 0/00      34.8533459  34.9209054  34.8369522  34.8143193  34.7714983
AV.KINETIC ENERGY J/M**3 0.9212109  0.3934392  0.0992338  0.0378997  0.0232330
DEPTH IN M                50.00      200.00      575.00      1500.00      3500.00      6000.00
SUM OF UPW. TRANSPORTS M**3/S 0.35984E+09 0.30183E+09 0.35663E+09 0.46801E+09 0.36264E+09 0.00000E+00
SUM OF DOWNW.TRANSPORTS M**3/S -0.35984E+09 -0.30183E+09 -0.35663E+09 -0.46801E+09 -0.36264E+09 0.00000E+00
CONVECTIVE ADJUSTMENT EVENTS:      142      85      43      24      38      0
ICEVOLUME M**3 0.1095804E+15 ICECOVERED AREA M**2 0.4719828E+14 AV. THICKNESS IN M 2.3217033
RANGE ICETHICKNESS FROM 0.0000000 TO 24.9999969 AVERAGE 2.3217033 M
RANGE TEMPERATURE AT SURFACE FROM -1.9000000 TO 27.8023396 AVERAGE 16.3350134 CELSIUS
RANGE SALINITY AT SURFACE FROM 16.2208695 TO 38.0837457 AVERAGE 34.5422065 0/00
GLOBAL AV.DIAGN.HEATFLUX -1.436E+00W/M**2, GLOBAL AV.DIAGN.NET FRESHWATERFLUX -8.212E-01MM/MONTH
+ 4009 YEARS: BACKUP WRITTEN ON FILE KLEIIN2 +
*****
TIMESTEP NUMBER      48240   YEAR:   4019 DATE (MMDD):  1230
MAXIMUM OF BAROTROPIC STREAMFUNCTION IN M**3/S 0.175000E+09 AT LON= 164. LAT= -26.
LAYER DEPTH IN M          75.00      250.00      700.00      2000.00      4000.00
AV.POT.TEMP.(C)          14.4711668  10.3798234  5.8429712  3.1406586  2.2359195
AV.SALINITY IN 0/00      34.8542987  34.9204797  34.8367827  34.8142989  34.7715216
AV.KINETIC ENERGY J/M**3 0.9218001  0.3931978  0.0991707  0.0379220  0.0232559
DEPTH IN M                50.00      200.00      575.00      1500.00      3500.00      6000.00
SUM OF UPW. TRANSPORTS M**3/S 0.35980E+09 0.30185E+09 0.35672E+09 0.46855E+09 0.36309E+09 0.00000E+00
SUM OF DOWNW.TRANSPORTS M**3/S -0.35980E+09 -0.30185E+09 -0.35672E+09 -0.46855E+09 -0.36309E+09 0.00000E+00
CONVECTIVE ADJUSTMENT EVENTS:      141      85      45      22      36      0
ICEVOLUME M**3 0.1095258E+15 ICECOVERED AREA M**2 0.4719828E+14 AV. THICKNESS IN M 2.3205467
RANGE ICETHICKNESS FROM 0.0000000 TO 24.9999976 AVERAGE 2.3205467 M
RANGE TEMPERATURE AT SURFACE FROM -1.9000000 TO 27.8025224 AVERAGE 16.3344710 CELSIUS
RANGE SALINITY AT SURFACE FROM 16.2262564 TO 38.0701571 AVERAGE 34.5430084 0/00
GLOBAL AV.DIAGN.HEATFLUX -1.428E+00W/M**2, GLOBAL AV.DIAGN.NET FRESHWATERFLUX -8.212E-01MM/MONTH
+ 4019 YEARS: BACKUP WRITTEN ON FILE KLEIIN1 +
*****

```

## 4.2 Postprocessing

The subroutine OUTPOST (see section 3.2 ) writes datafiles onto disk at specified times during the model run, which are readable by the postprocessing package. An example script to run the postprocessor is available on the Cray-2S:

```
/pool/POST/ocpost.job
```

The following types of plots can be chosen via namelist:

LMAP(i,j) horizontal plot of code i at level j  
 LSEC(i,j) vertical cross section of code i at section j  
           j=1          GEOSECS Atlantic  
           j=2          GEOSECS Pacific  
           j=3          (east) Atlantic  
 LMERCI(i) meridional circulation of  
           i=0          global mean  
           i=1          atlantic mean  
           i=2          pacific mean  
           i=3          indic mean  
           i=4          fresh water flux  
           i=5          heat flux

Code numbers have been introduced to easily identify ocean variables. They can be seen in the following table.

<i>Code no.</i>	<i>Variable</i>	<i>Unit</i>
2	<i>potential temperature</i>	<i>Celsius</i>
3	<i>zonal velocity component</i>	<i>m/s</i>
4	<i>meridional velocity component</i>	<i>m/s</i>
5	<i>salinity</i>	<i>%</i>
6	<i>pressure</i>	<i>Pa</i>
7	<i>vertical velocity component</i>	<i>m/s</i>
8	<i>in-situ density - 1000</i>	<i>kg/m<sup>3</sup></i>
9	<i>potential density - 1000</i>	<i>kg/m<sup>3</sup></i>
13	<i>ice thickness</i>	<i>m</i>
18	<i>heat flux (prescribed)</i>	<i>W/m<sup>2</sup></i>
27	<i>horizontal barotropic stream function</i>	<i>m<sup>3</sup>/s</i>
37	<i>zonal component of barotropic velocity</i>	<i>m/s</i>
38	<i>meridional component of barotropic velocity</i>	<i>m/s</i>
63	<i>zonal component of baroclinic velocity contribution</i>	<i>m<sup>2</sup>/s</i>
64	<i>meridional component of baroclinic velocity contribution</i>	<i>m<sup>2</sup>/s</i>
67	<i>fresh water flux due to Newtonian coupling (diagnostic)</i>	<i>m/s</i>
68	<i>heat flux due to Newtonian coupling (diagnostic)</i>	<i>W/m<sup>2</sup></i>
69	<i>convective adjustment events</i>	
98	<i>depth in scalar-points</i>	<i>m</i>
99	<i>depth in vector-points</i>	<i>m</i>

Examples for typical plot output

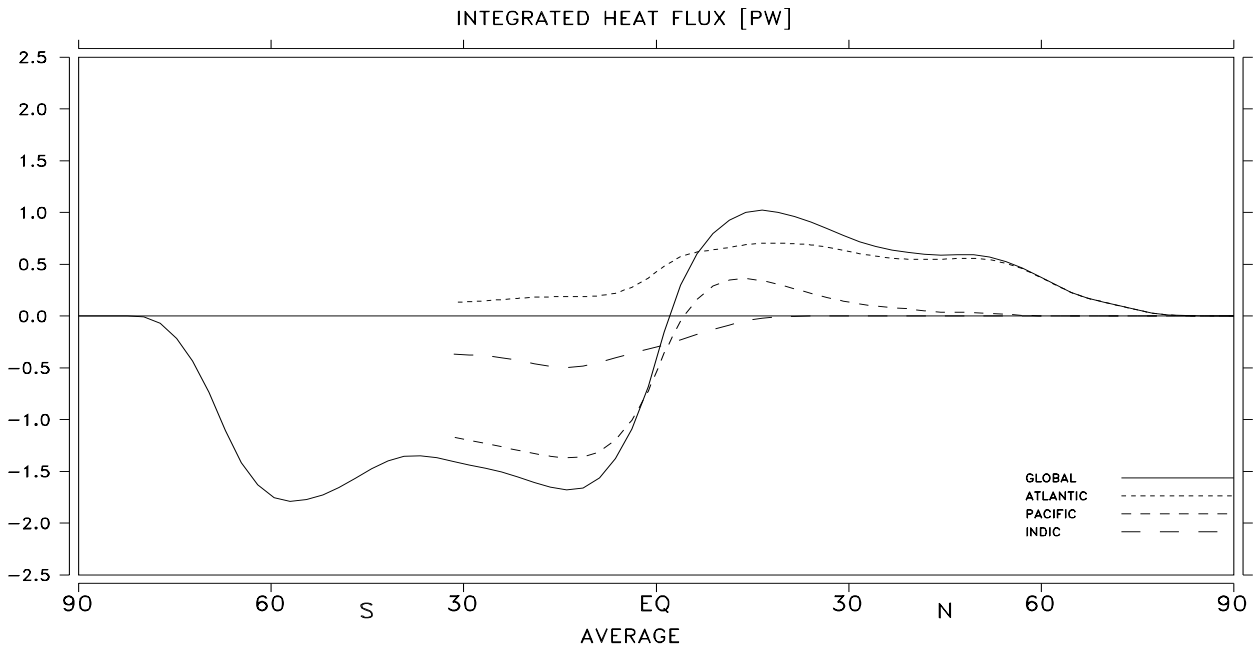

Figure 4 : Example plot showing the integrated heat flux for Atlantic, Pacific and Indic as well as global integrated heat flux.  
(created by using plot parameter LMERC(5)=.TRUE.)

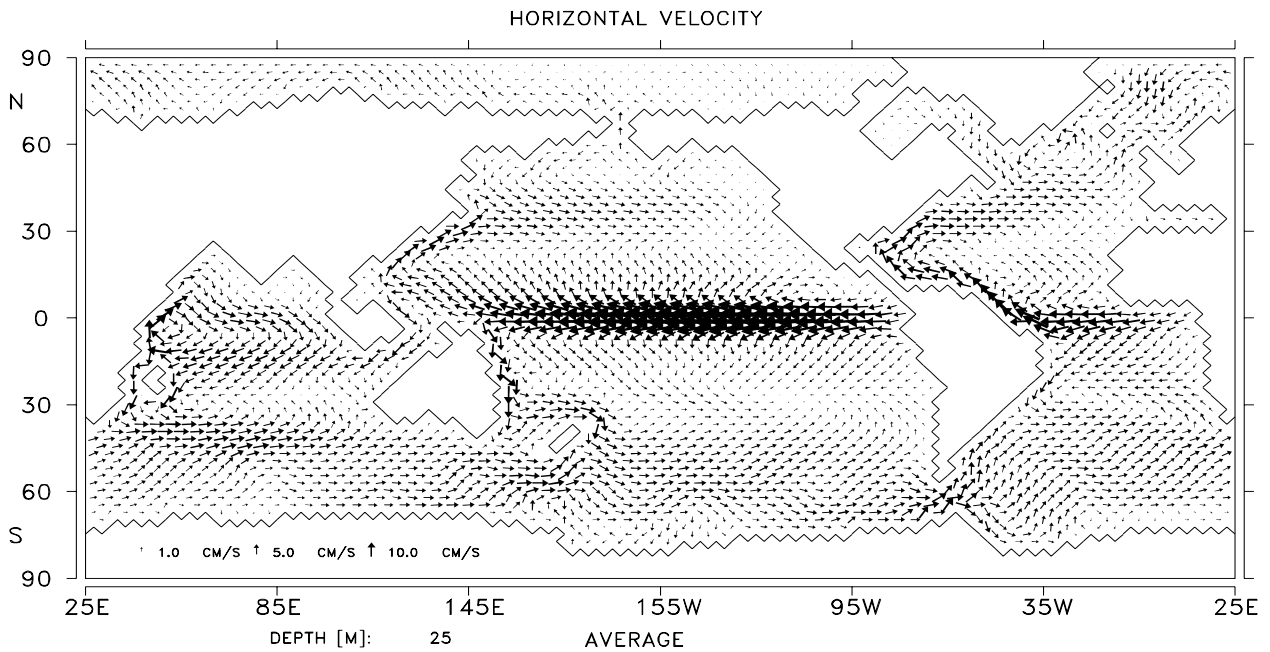

Figure 5 : Example plot showing the horizontal velocity vector for a depth of 25 m.  
(created by using plot parameter LMAP(3,1)=.TRUE.)

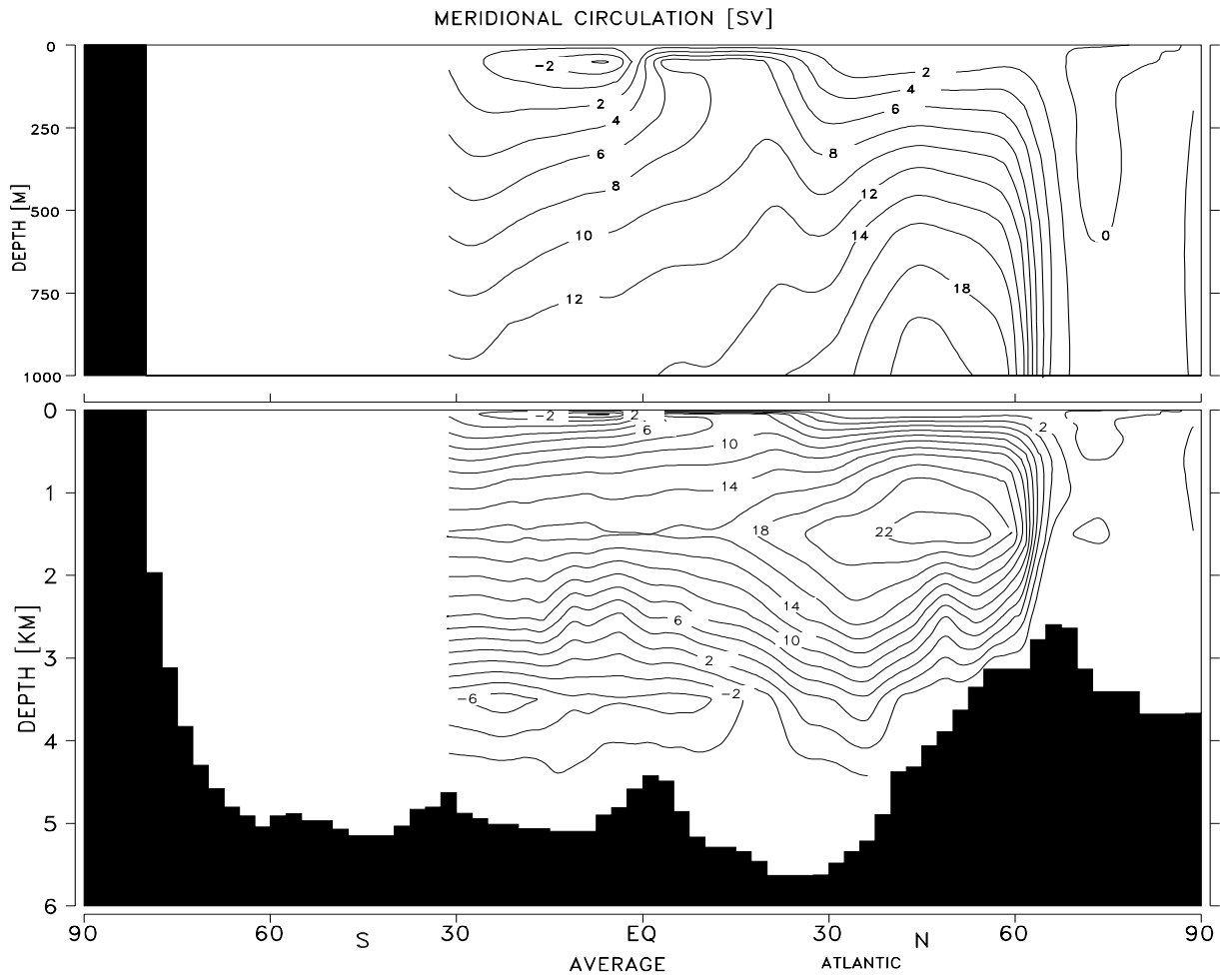

Figure 6 : Example plot showing a meridional-vertical cross section of meridional circulation in the Atlantic.

(created by using plot parameter LMERC(1)=.TRUE.)

REMARK: The default value for the plot parameters LMAP(i,j), LSEC(i,j) and LMERC(i) mentioned above is .FALSE. (representation type LOGICAL).

### 4.3 Structure of datasets

#### 4.3.1 Format for restart and output files

Backup files are written every 10 model years alternatively to KLEIIN1 and KLEIIN2. The output files for the postprocessor are specified in the script running the model. The files have the following structure:

```

IDDR(512)
ODDR(512)
ZPREL(6)
data field
ZPREL(6)
data field
...

```

#### Header Field IDDR

IDDR is a field of type INTEGER of length 512. The content of this array is described below.

<i>Element</i>	<i>Content</i>	
1	<i>length of IDDR</i>	(=512)
2	<i>length of integer section</i>	(=512)
3	<i>length of next DDR</i>	(=512)
:	:	(=0)
7	<i>creation time</i>	(hhmmss)
8	<i>creation date</i>	(yymmdd)
9	<i>initial data date</i>	(-mmdd)
10	<i>initial data year</i>	(yyyyyy)
11	<i>data date</i>	(-mmdd)
12	<i>data year</i>	(yyyyyy)
13	...	(=0)
14	<i>data type</i>	(=15)
15	<i>number of DDR's</i>	(=2)
16	<i>number of data records</i>	
17	<i>maximum DDR length</i>	(=512)
18	<i>maximum data record length</i>	(IEN*JEN)
19	<i>number of points on latitude line</i>	(IEN)
20	<i>number of latitude lines</i>	(JEN)
21	<i>number of vertical levels</i>	(KEN)
22	<i>number of fields</i>	(maximal 200)
23	<i>field code of field 1</i>	
24	<i>level code of field 1</i>	
25	<i>field code of field 2</i>	
:	:	
23+2*(n-1)	<i>field code of field n</i>	
23+2*n-1	<i>level code of field n</i>	
:	:	
300 to 399	<i>description of the experiment in HOLLERITH</i>	
400	<i>value of the switch NSVE</i>	(NSVE)
401	<i>value of the switch NSMIX</i>	(NSMIX)
402	<i>value of the switch NSFLU</i>	(NSFLU)
403	<i>number of time steps per year</i>	
:	:	
512		

Unused elements of IDDR should have the value zero to avoid difficulties.

### Header Field ODDR

ODDR is a floating point field of length 512.

<i>Element</i>	<i>Content</i>	
1	length of ODDR	(=512.)
:		
10	depth of level 1 in m	
11	depth of level 2 in m	
:		
10+n-1	depth of level n in m ( $n \leq 39$ )	
50	zonal grid step	(degrees)
51	meridional grid step	(degrees)
52	latitude of first latitude line	(degrees)
:		
52+JEN-1	latitude of last latitude line	(degrees)
52+JEN	longitude of first point on first latitude line	(degrees)
:		
52+2*JEN-1	longitude of first scalar point on last latitude line	(degrees)
:		
512		

### Data Record Header Field ZPREL

ZPREL is a floating point header array of length 6. Each data record must be preceded by a header record.

<i>Element</i>	<i>Content</i>	
1	length of preliminary array	(=6.)
2	length of data record	(IEN * JEN)
3	code number of data	
4	level number of data	
5	not in use	
6	not in use	

## Data Record

The data record must be written unformatted with one WRITE statement. The length of the record must be given by ZPREL(2). Each data record must consist of a 2-dimensional field(e.g., pot. temperature in the first layer or salinity in third layer) .

The program ( SUBROUTINE INIVAL2) expects to find the variables in this order:

<i>No. of data record</i>	<i>Variable</i>
1	<i>pot. temperature in the first layer</i>
2	<i>pot. temperature in the second layer</i>
:	
<i>KEN</i>	<i>pot. temperature in the lowest layer</i>
<i>KEN + 1</i>	<i>salinity in the first layer</i>
<i>KEN + 2</i>	<i>salinity in the second layer</i>
:	
<i>2*KEN</i>	<i>salinity in the lowest layer</i>
<i>2*KEN+1</i>	<i>zonal component of baroclinic modes in the first layer</i>
:	
<i>3*KEN</i>	<i>zonal component of baroclinic modes in the lowest layer</i>
<i>3*KEN+1</i>	<i>merid. component of baroclinic mode in the first layer</i>
:	
<i>4*KEN</i>	<i>merid. component of baroclinic mode in the lowest layer</i>
<i>4*KEN+1</i>	<i>zonal component of barotropic velocity</i>
<i>4*KEN+2</i>	<i>meridional component of barotropic velocity</i>
<i>4*KEN+3</i>	<i>surface elevation</i>
<i>4*KEN+4</i>	<i>ice thickness</i>

The SUBROUTINE OUTBACK writes a restart file in the correct form. The output files are written by the SUBROUTINE OUTPOST.



#### 4.4 Format for Input Files

##### Boundary fields are:

surface temperature	(file MONTEM)
surface salinity	(file MONSAL)
wind stress components	(files WISTRX, WISTRY)
net fresh water flux	(file SALFLU)
heat flux	(file HEAFLU)

These boundary fields must be specified as monthly means in the complete annual cycle. The fields are read in the subroutine READBF. One file is required for each parameter. All variables are written unformatted. The files must have the following structure:

```
ZNUM
ZHEAD
ZHPRE
data field
ZHPRE
data field
. .
```

The meaning of the elements in detail:

ZNUM describes the length of the header array ZHEAD ( $8 \leq \text{NINT}(\text{ZNUM}) \leq 20$ ).  
ZHEAD is a header array of length  $\text{NINT}(\text{ZNUM})$ .

The elements of ZHEAD have this meaning:

1. Field code of the variable.
2. Depth level of the variable (for surface -100.)
3. Number of data sets on this file. This number must be equal to NTYEAR, the number of time steps per year. NTYEAR is given by  $\text{NTYEAR} = \text{NINT}(3600. * 86400. / \text{DT} + .2)$ , where DT is the time step in seconds.
4. Zonal dimension of the data field, must match the parameter IEN in the model.
5. Meridional dimension of the data field, must match the parameter JEN in the model.
6. The data grid. The Arakawa E-grid which the model expects to find has the code number 1.
7. Longitude of the point(1,1).
8. Latitude of the point(1,1).
9. USER-ID of the file's producer.
10. Date of production (yymmdd).
11. This and subsequent elements are not yet in use.

The first 8 elements of ZHEAD must correspond to the expected values, otherwise the model will stop at the first nonmatching element. There must be ZHEAD(3) datasets with dimensions ZHEAD(4)\*ZHEAD(5), otherwise the model will stop with an error message. The data record header field ZHPRE is of length 6. The first element contains the field code of the variable (see section 4.2 ), the second must be the number of the data record following, the others are not yet in use and should have the value 0.

Each dataset must be written with one WRITE statement.

#### 4.4.1 Input Format for File with Topographic Data

This file must be formatted in the following way:

- Format of the length of the header field ZHEADT (max. A40)
- length LEN of the header field ZHEADT (  $8 \leq \text{LEN} \leq 20$  ).
- Format of the header field ZHEADT (max. A40).
- Header field ZHEADT.
- Format of the data (max. A40).
- Data set containing the depths in vector-points in m.

The single elements of the header field ZHEADT do have the meaning:

<i>No.</i>	<i>Content</i>	
1	<i>field code of data</i>	<i>-99.</i>
2	<i>number of points on latitude line</i>	<i>IEN</i>
3	<i>number of latitude lines</i>	<i>JEN</i>
4	<i>zonal grid step in degree</i>	
5	<i>meridional grid step in degree</i>	
6	<i>longitude of point (1,1)</i>	
7	<i>latitude of point (1,1)</i>	
8	<i>code for grid type (Arakawa E type =1.)</i>	<i>1.</i>
9	<i>date of construction yymmdd</i>	
10	<i>USER-ID of constructor</i>	

## 5. References

Arakawa, A., and V. R. Lamb, 1977:

Computational design of the basic dynamical process of the UCLA general circulation model. Meth. Comp. Phys., 16, 173 - 263.

Bacastow, R. and E. Maier-Reimer, 1990:

Ocean-Circulation Model of the Carbon Cycle. Climate Dynamics, 4, 95-126.

Hasselmann, K., 1982:

An ocean model for climate variability studies. Prog. Oceanog., 11, 69 - 92.

Maier-Reimer, E., and K. Hasselmann, 1987:

Transport and storage of CO<sub>2</sub> in the ocean - an inorganic ocean-circulation carbon cycle model. Climate Dynamics, 2, 63 -90.

Maier-Reimer, E., U. Mikolajewicz and K. Hasselmann, 1991:

On the sensitivity of the global ocean circulation to changes in the surface heat flux forcing. MPI-Report No. 68 (submitted to JPO).

UNESCO, 1981:

10th report of the joint panel on oceanographic tables and standards.  
UNESCO technical papers in marine sci., 36, UNESCO, Paris.

## Appendix A List of symbols used in section 2

Symbol	model notation	meaning
$A_h$	<i>FRIH</i>	<i>coefficient of horizontal friction</i>
$A_h$	<i>FRIV</i>	<i>coefficient of vertical friction</i>
$A_\vartheta$	<i>DIFHDR</i>	<i>coefficient of horizontal diffusion for pot. temperature</i>
$D_1$		<i>thickness of the uppermost layer</i>
$f$	<i>FF</i>	<i>Coriolis parameter</i>
$g$	<i>G</i>	<i>acceleration due to gravity.</i>
$H$	<i>DEPP</i>	<i>depth</i>
$i$	<i>I</i>	<i>zonal index</i>
$IEN$	<i>IEN</i>	<i>number of points on latitude line</i>
$j$	<i>J</i>	<i>meridional index</i>
$JEN$	<i>JEN</i>	<i>number of latitude lines</i>
$k$	<i>K</i>	<i>vertical index</i>
$KEN$	<i>KEN</i>	<i>number of vertical layers</i>
$p$	<i>P</i>	<i>pressure</i>
$q$		<i>source term</i>
$R$	<i>ERDRAD</i>	<i>radius of the earth</i>
$S$	<i>S</i>	<i>salinity</i>
$t$	<i>NT</i>	<i>time</i>
$\Delta t$	<i>DT</i>	<i>time step</i>
$T$		<i>temperature</i>
$u$	<i>UTOT</i>	<i>zonal velocity component</i>
$v$	<i>VTOT</i>	<i>meridional velocity component</i>
$w$	<i>W</i>	<i>vertical velocity component</i>
$\Delta x$		<i>distance between zonal grid points</i>
$\Delta y$		<i>distance between meridional grid points</i>
$z$		<i>vertical coordinate</i>
$\Delta z^k$	<i>DDZ(k)</i>	<i>thickness of the k-th layer</i>
$\Delta$		<i>Laplace operator, difference oper. in discrete equations</i>
$\Delta_h$		<i>horizontal Laplace operator</i>
$\rho$	<i>RH</i>	<i>density</i>
$\rho_0$	<i>RHOREF</i>	<i>reference density</i>
$\Delta \rho$	<i>RHDIF</i>	<i>difference of the potential density related to the intermediate w-points</i>
$\lambda$		<i>zonal coordinate, longitude</i>
$\varphi$		<i>meridional coordinate, latitude</i>
$\vartheta$	<i>T</i>	<i>potential temperature</i>
$\delta_i^k$		<i>=1 if <math>i=k</math>, else =0</i>
$\tau$	<i>TAUX,TAUY</i>	<i>wind stress</i>
$\zeta$	<i>ZETA</i>	<i>sea surface elevation</i>
$\Omega$	<i>ERDROT</i>	<i>angular frequency of earth rotation.</i>
$Y$	<i>DUM1</i>	<i>dummy variable</i>

$Y^\lambda$	<i>zonal component of variable</i>
$Y^\phi$	<i>meridional component of variable</i>
$\bar{Y}$	<i>vertical average</i>
$Y_\lambda$	<i>derivation with respect to <math>\lambda</math></i>
$Y_\phi$	<i>derivation with respect to <math>\phi</math></i>
$Y_t$	<i>derivation with respect to time <math>t</math></i>
$Y_z$	<i>derivation with respect to <math>z</math></i>
$Y^k$	<i>variable in the <math>k</math>-th layer</i>
$Y^N$	<i>variable from the north</i>
$Y^S$	<i>variable from the south</i>
$Y^E$	<i>variable from the east</i>
$Y^W$	<i>variable from the west</i>
$Y^U$	<i>variable from the layer above</i>
$Y^L$	<i>variable from the layer below</i>
$Y'$	<i>deviation of variable from vertical average, baroclinic component</i>
$\tilde{Y}$	<i>baroclinic mode</i>

## Appendix B Field code numbers of the ocean model

For easier identification of variables there have been introduced certain code numbers which usually have been chosen to be negative in order to avoid conflicts with the atmosphere model.

Code no.	Content	Unit
-1	<i>surface elevation</i>	<i>m</i>
-2	<i>potential temperature</i>	<i>Kelvin</i>
-3	<i>zonal velocity component</i>	<i>m/s</i>
-4	<i>meridional velocity component</i>	<i>m/s</i>
-5	<i>salinity</i>	<i>0/00</i>
-6	<i>pressure</i>	<i>Pa</i>
-7	<i>vertical velocity component</i>	<i>m/s</i>
-8	<i>in-situ-density - 1000</i>	<i>kg/m<sup>3</sup></i>
-9	<i>potential density - 1000</i>	<i>kg/m<sup>3</sup></i>
-10	<i>C-14 distribution</i>	<i>0/00</i>
-12	<i>C-12 distribution</i>	<i>0/00</i>
-13	<i>ice thickness</i>	<i>m</i>
-14	<i>sea surface temperature over ice</i>	<i>Celsius</i>
-15	<i>ice compactness</i>	<i>0/0</i>
-18	<i>heat flux</i>	<i>W/m<sup>2</sup></i>
-19	<i>meridional heat transport</i>	<i>PW</i>
-20	<i>meridional salt transport</i>	<i>Kt/s</i>
-21	<i>zonally integrated fresh water flux</i>	<i>Sv</i>
-22	<i>zonally integrated heat flux</i>	<i>PW</i>
-24	<i>meridional circulation</i>	<i>Sv</i>
-27	<i>horizontal barotropic stream function</i>	<i>m<sup>3</sup>/s</i>
-37	<i>zonal component of barotropic velocity</i>	<i>m/s</i>
-38	<i>meridional component of barotropic velocity</i>	<i>m/s</i>
52	<i>zonal component of wind stress</i>	<i>Pa</i>
53	<i>meridional component of wind stress</i>	<i>Pa</i>
-60	<i>density difference</i>	<i>kg/m<sup>3</sup></i>
-61	<i>geopotential thickness</i>	<i>m<sup>2</sup>/s<sup>2</sup></i>
-62	<i>potential temperature</i>	<i>Celsius</i>
-63	<i>zonal component of baroclinic mode</i>	<i>m<sup>2</sup>/s</i>
-64	<i>meridional component of baroclinic mode</i>	<i>m<sup>2</sup>/s</i>
-65	<i>net fresh water flux (P-E)</i>	<i>m/s</i>
-66	<i>potential energy dissipation due to convection</i>	<i>mW/m<sup>2</sup></i>
-67	<i>fresh water flux due to Newtonian coupling</i>	<i>m/s</i>
-68	<i>heat flux due to Newtonian coupling</i>	<i>W/m<sup>2</sup></i>
-69	<i>convective adjustment events</i>	
-72	<i>temperature correction</i>	<i>Celsius</i>
-73	<i>zonal component of wind stress correction</i>	<i>Pa</i>
-74	<i>meridional component of wind stress correction</i>	<i>Pa</i>
-75	<i>P-E correction</i>	<i>m/s</i>
-78	<i>heat flux correction</i>	<i>W/m<sup>2</sup></i>
-97	<i>dQ/dt coupling coefficient</i>	<i>W/m<sup>2</sup>K</i>
-98	<i>depth in scalar-points</i>	<i>m</i>
-99	<i>depth in vector-points</i>	<i>m</i>