

THE SLOPE CONJECTURE FOR MONTESINOS KNOTS

STAVROS GAROUFALIDIS, CHRISTINE RUEY SHAN LEE, AND ROLAND VAN DER VEEN

ABSTRACT. The slope conjecture relates the degree of the colored Jones polynomial of a knot to boundary slopes of essential surfaces. We develop a general approach that matches a state-sum formula for the colored Jones polynomial with the parameters that describe surfaces in the complement. We apply this to Montesinos knots proving the slope conjecture for Montesinos knots, with some restrictions.

CONTENTS

1. Introduction	2
1.1. The slope conjecture and the case of Montesinos knots	2
1.2. Our results	3
1.3. Plan of the proof	7
2. Preliminaries	7
2.1. Rational tangles	7
2.2. Classification of Montesinos links	10
2.3. Skein theory and the colored Jones polynomial	10
3. The colored Jones polynomial of pretzel knots	15
3.1. Outline of the proof of Theorem 3.2	17
Conventions for representing a Kauffman state	19
3.2. Simplifying the state sum and pyramidal position for crossings	19
3.3. Minimal states are taut and their degrees are $\delta(n, k)$	22
3.4. Enumerating all taut states	25
3.5. Adding up all taut states in $st(c, k)$	28
3.6. Proof of Theorem 3.2	29
4. Quadratic integer programming	29
4.1. Quadratic real optimization	30
4.2. Quadratic lattice optimization	31
4.3. Application: the degree of the colored Jones polynomial	32
5. The colored Jones polynomial of Montesinos knots	34
5.1. The TR-move	34
5.2. Special Montesinos knot case	35
5.3. The general case	37
6. Essential surfaces of Montesinos knots	44
6.1. Incompressible and ∂ -incompressible surfaces for a rational knot	45
6.2. Edge-paths and candidate surfaces for Montesinos knots	47
6.3. The boundary slope of a candidate surface	49
6.4. The Euler characteristic of a candidate surface	50

Date: May 12, 2020.

1991 *Mathematics Classification*. Primary 57N10. Secondary 57M25.

Keywords and phrases: knot, Jones polynomial, Jones slope, quasi-polynomial, pretzel knots, essential surfaces, incompressible surfaces.

6.5. Matching the growth rate to topology for pretzel knots	50
6.6. Proof of Theorem 1.2	56
6.7. Matching the growth rate to topology for Montesinos knots	56
6.8. Proof of Theorem 1.3	58
Acknowledgments	60
References	60

1. INTRODUCTION

1.1. The slope conjecture and the case of Montesinos knots. The slope conjecture relates one of the most important knot invariants, the colored Jones polynomial, to essential surfaces in the knot complement [Gar11b]. More precisely, the growth of the degree as a function of the color determines boundary slopes. Understanding the topological information that the polynomial detects in the knot is a central problem in quantum topology. The conjecture suggests the polynomial can be studied through surfaces, which are fundamental objects in 3-dimensional topology.

Our philosophy is that the connection follows from a deeper correspondence between terms in an expansion of the polynomial and surfaces. This would potentially lead to a purely topological definition of quantum invariants. The coefficients of the polynomial should count isotopy classes of surfaces, much like in the case of the 3D-index [GHHR16]. As a first test of this principle, we focus on the slope conjecture for Montesinos knots. In this case Hatcher-Oertel [HO89] provides a description of the set of essential surfaces of those knots. In particular they give an effective algorithm to compute the set of boundary slopes of incompressible and ∂ -incompressible surfaces in the complement of such knots.

We provide a state-sum formula for the colored Jones polynomial that allows us to match the parameters of the terms of the sum that contribute to the degree of the polynomial with the parameters that describe the locally essential surfaces. The key innovation of our state sum is that we are able to identify those terms that actually contribute to the degree. The resulting degree function is piecewise-quadratic, allowing application of quadratic integer programming methods.

We interpret the curve systems formed by intersections with essential surfaces on a Conway sphere enclosing a rational tangle in terms of these degree-maximizing skein elements in the state sum. In this paper we carry out the matching for Montesinos knots but the state-sum (11) is valid in general. In fact using this framework, one could determine the degree of the colored Jones polynomial and find candidates for corresponding essential surfaces in many new cases beyond Montesinos knots.

While the local theory works in general, fitting together the surfaces in each tangle to obtain a (globally) essential surface has yet to be done. The behavior of the colored Jones polynomial under gluing of tangles has similar patterns, which may be explored in future work.

The Montesinos knots, together with some well-understood algebraic knots, are knots that have small Seifert fibered 2-fold branched covers [Mon73, Zie84]. For our purposes, we will not use this abstract definition, and instead construct Montesinos links by inserting rational

tangles into pretzel knots. More precisely, a Montesinos link is the closure of a list of rational tangles arranged as in Figure 1 and concretely as in Figure 2. See Definition 2.4.

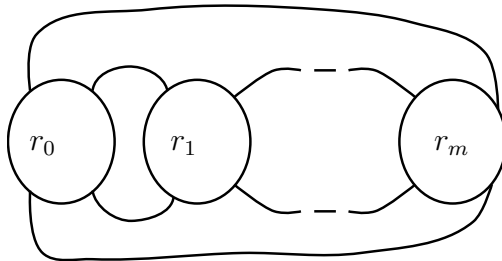

FIGURE 1. A Montesinos link.

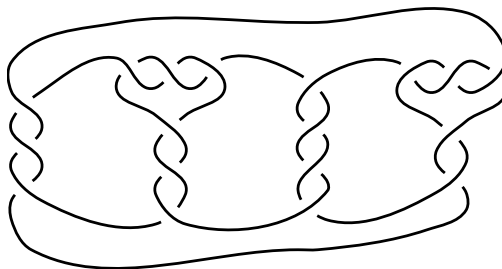

FIGURE 2. The Montesinos link $K(-\frac{1}{3}, -\frac{3}{10}, \frac{1}{4}, \frac{3}{7})$.

Rational tangles are determined by rational numbers, see Section 2.1, thus a Montesinos link $K(r_0, r_1, \dots, r_m)$ is encoded by a list of rational numbers $r_i \in \mathbb{Q}$. Note that $K(r_0, r_1, \dots, r_m)$ is a knot if and only if either there is only one even denominator, or, there is no even denominator and the number of odd numerators is odd. When $r_i = 1/q_i$ is the inverse of an integer, the Montesinos link $K(1/q_0, \dots, 1/q_m)$ is also known as the pretzel link $P(q_0, \dots, q_m)$.

1.2. Our results. Recall the colored Jones polynomial $J_{K,n}(v) \in \mathbb{Z}[v^{\pm 2}]$ of a knot K colored by the n -dimensional irreducible representation of \mathfrak{sl}_2 [Tur88]. See Definition 2.8. Our variable v for the colored Jones polynomial is related to the skein theory variable A [Prz91] and to the Jones variable q [Jon87] by $v = A^{-1} = q^{-\frac{1}{4}}$. With our conventions, if $3_1 = P(1, 1, 1)$ denotes the left-hand trefoil, then $J_{3_1,2}(v) = v^{18} - v^{10} - v^6 - v^2$. For the n -colored unknot we get $J_{O,n} = \frac{v^{2n} - v^{-2n}}{v^2 - v^{-2}}$.

Let $\delta_K(n)$ denote the maximum v -degree of the colored Jones polynomial $J_{K,n}(v)$. It follows that $\delta_K(n)$ is a quadratic quasi-polynomial [Gar11a]. In other words, for every knot K there exists an $N_K \in \mathbb{N}$ such that for $n > N_K$:

$$\delta_K(n) = \text{js}_K(n)n^2 + \text{jx}_K(n)n + c_K(n) \quad (1)$$

where js_K , jx_K , and c_K are periodic functions.

Conjecture 1.1. (The strong slope conjecture)

For any knot K and any $n > N_K$, there is an n' and an essential surface $S \subset S^3 \setminus K$ with

$|\partial S|$ boundary components, such that the boundary slope of S equals $\text{js}_K(n) = p/q$ (reduced to lowest terms and with the assumption $q > 0$), and $\frac{2\chi(S)}{q|\partial S|} = \text{jx}_K(n')$.

The number $q|\partial S|$ is called the *number of sheets* of S , denoted by $\#S$, and $\chi(S)$ is the Euler characteristic of S . See the discussion at the beginning of Section 6 for the definition of an essential surface and boundary slope. We call a value of the function js_K a *Jones slope* and a value of the function jx_K a *normalized Euler characteristic*. The original slope conjecture is the part of Conjecture 1.1 that concerns the interpretation of js_K as boundary slopes [Gar11b], while the rest of the statement is a refinement by [KT15]. The reader may consult these two sources [Gar11b], [KT15] for additional background. By considering the mirror image \overline{K} of K and the formula $J_{K,n}(v^{-1}) = J_{\overline{K},n}(v)$, the strong slope conjecture is equivalent to the statement in [KT15] that includes the behavior of the minimal degree.

The slope conjecture and the strong slope conjecture were established for many knots including alternating knots, adequate knots, torus knots, knots with at most 9 crossings, 2-fusion knots (in this case only the slope conjecture is proven), graph knots, near-alternating knots, and most 3-tangle pretzel knots and 3-tangle Montesinos knots [Gar11b, FKP11, GvdV16, LvdV16, MT17, BMT18, Lee, LYL19, How]. However the general case remains intractable and most proofs simply compute the quantum side and the topology side separately, comparing only the end results.

Since the strong slope conjecture is known for adequate knots [Gar11b, FKP11, FKP13], we will ignore the Montesinos knots which are adequate. When $m \geq 2$, a non-adequate Montesinos knot $K(r_0, r_1, \dots, r_m)$ has precisely one negative or positive tangle [LT88, p.529]. Without loss of generality we need only to consider $\text{js}_K(n)$ and $\text{jx}_K(n)$ for a Montesinos knot with precisely one negative tangle. The positive tangle case follows from taking mirror image.

Before stating our main result on Montesinos knots we start with the case of pretzel knots as they are the basis for our argument. In fact Theorem 1.2 is the bulk of our work. For $P(q_0, \dots, q_m)$ to be a knot, at most one tangle has an even number of crossings, and if each tangle has an odd number of crossings, then the number of tangles has to be odd. In the theorem below, the condition on the parities of the q_i 's and the number of tangles may be dropped if one is willing to exclude an arithmetic sub-sequence of colors n .

Theorem 1.2. *Fix an $(m+1)$ -vector q of odd integers $q = (q_0, \dots, q_m)$ with $m \geq 2$ even and $q_0 < -1 < 1 < q_1, \dots, q_m$. Let $P = P(q_0, \dots, q_m)$ denote the corresponding pretzel knot. Define rational functions $s(q), s_1(q) \in \mathbb{Q}(q)$:*

$$s(q) = 1 + q_0 + \frac{1}{\sum_{i=1}^m (q_i - 1)^{-1}}, \quad s_1(q) = \frac{\sum_{i=1}^m (q_i + q_0 - 2)(q_i - 1)^{-1}}{\sum_{i=1}^m (q_i - 1)^{-1}}. \quad (2)$$

For all $n > N_K$ we have:

(a) If $s(q) < 0$, then the strong slope conjecture holds with

$$\text{js}_P(n) = -2s(q), \quad \text{jx}_P(n) = -2s_1(q) + 4s(q) - 2(m-1). \quad (3)$$

In particular, $\text{js}_P(n)$ and $\text{jx}_P(n)$ are constant functions.

(b) If $s(q) = 0$, then the strong slope conjecture holds with

$$\text{js}_P(n) = 0, \quad \text{jx}_P(n) = \begin{cases} -2(m-1) & \text{if } s_1(q) \geq 0 \\ -2s_1(q) - 2(m-1) & \text{if } s_1(q) < 0 \end{cases}. \quad (4)$$

In particular, $\text{js}_P(n)$ and $\text{jx}_P(n)$ are constant functions.

(c) If $s(q) > 0$, then the strong slope conjecture holds with

$$\text{js}_P(n) = 0, \quad \text{jx}_P(n) = -2(m-1). \quad (5)$$

In particular, $\text{js}_P(n)$ and $\text{jx}_P(n)$ are constant functions.

Next, we consider the case of Montesinos knots. Recall that by applying Euclid's algorithm, every rational number r has a unique positive continued fraction expansion $r = [b_0, \dots, b_{\ell'}]$, see (8), with $\ell' < \infty$, $b_0 \in \mathbb{Z}$, $|b_j| \geq 1$ for $1 \leq j \leq \ell' - 1$, $|b_{\ell'}| \geq 2$, and b_j 's all of the same sign as r . From this we define an even length continued fraction expansion $[a_0, \dots, a_{\ell_r}]$ of r to be equal to $[b_0, \dots, b_{\ell'}]$ if ℓ' is even, and we define it to be equal to $[b_0, \dots, b_{\ell'} - 1, 1]$ (resp. $[b_0, \dots, b_{\ell'} + 1, -1]$) if ℓ' is odd and $r > 0$ (resp. $r < 0$). Note $[a_0, \dots, a_{\ell_r}]$ is well-defined. We will call $[a_0, \dots, a_{\ell_r}]$ the unique even length positive continued fraction expansion for r . Define $r[j] = a_j$ for $j = 0, \dots, \ell_r$, and define

$$[r]_e = \sum_{3 \leq j \leq \ell_r, j=\text{even}} r[j], \quad [r]_o = \sum_{3 \leq j \leq \ell_r, j=\text{odd}} r[j], \quad [r] = [r]_e + [r]_o.$$

For example, the fraction $63/202 = [0, 3, 4, 1, 5, 2]$ has the unique even length positive continued fraction expansion $[0, 3, 4, 1, 5, 1, 1]$. Adding up all the partial quotients of the continued fraction expansion with even indices ≥ 3 , we get $[63/202]_e = 5 + 1 = 6$. Similarly, adding up all the partial quotients with odd indices ≥ 3 , we get $[63/202]_o = 1 + 1 = 2$.

Given a Montesinos knot $K(r_0, \dots, r_m)$, define D_K to be the diagram obtained by summing rational tangle diagrams corresponding to the unique even length positive continued fraction expansion for each r_i , and then taking the numerator closure. See Section 2.1 for how a rational tangle diagram is assigned to a continued fraction expansion of a rational number and definitions for the tangle sum and numerator closure.

By the classification of Montesinos knots by [Bon79], and the existence and use of reduced diagrams of Montesinos links [LT88] based on the classification, we will further restrict to Montesinos knots $K(r_0, \dots, r_m)$ where $|r_i| < 1$ for all $0 \leq i \leq m$. See Section 2.2 for the discussion of why we may do so without loss of generality.

Let $(r_0, \dots, r_m) \in \mathbb{Q}^{m+1}$ denote a tuple of rational numbers, and let $(q_0, \dots, q_m) \in \mathbb{Z}^{m+1}$ denote the associated tuple of integers where $q_i = r_i[1] + 1$ for $1 \leq i \leq m$ and

$$q_0 = \begin{cases} r_0[1] - 1 & \text{if } \ell_{r_0} = 2 \text{ and } r_0[2] = -1, \text{ and} \\ r_0[1] & \text{otherwise} \end{cases}$$

from the unique even length positive continued fraction expansion of r_i 's. Again, for the following theorem the condition on the parities of the q_i 's and the number of tangles ($m \geq 2$ even) may be dropped if one is willing to exclude an arithmetic sub-sequence of colors n , thus proving a weaker version of the conjecture for all Montesinos knots.

Theorem 1.3. *Let $K = K(r_0, r_1, \dots, r_m)$ be a Montesinos knot such that $r_0 < 0$, $r_i > 0$ for all $1 \leq i \leq m$, and $|r_i| < 1$ for all $0 \leq i \leq m$ with $m \geq 2$ even. Suppose $q_0 < -1 < 1 < q_1, \dots, q_m$ are all odd, and q'_0 is an integer that is defined to be 0 if $r_0 = 1/q_0$, and defined to be $r_0[2]$ otherwise. Let $P = P(q_0, \dots, q_m)$ be the associated pretzel knot, and let $\omega(D_K)$, $\omega(D_P)$ denote the writhe of D_K , D_P with orientations. Then the strong slope conjecture holds. For all $n > N_K$ we have:*

$$\begin{aligned} \text{js}_K(n) &= \text{js}_P(n) - q'_0 - [r_0] - \omega(D_P) + \omega(D_K) + \sum_{i=1}^m (r_i[2] - 1) + \sum_{i=1}^m [r_i], \\ \text{jx}_K(n) &= \text{jx}_P(n) - 2\frac{q'_0}{r_0[2]} + 2[r_0]_o - 2\sum_{i=1}^m (r_i[2] - 1) - 2\sum_{i=1}^m [r_i]_e. \end{aligned}$$

In particular, $\text{js}_P(n)$ and $\text{jx}_P(n)$ are constant functions.

Example 1.4. Consider the Montesinos knot $K = K(-\frac{46}{327}, \frac{35}{151}, \frac{5}{31}, \frac{16}{35}, \frac{1}{5})$. Applying Theorem 1.2 and 1.3, we compute the Jones slope js_K by using Euclid's algorithm to obtain the unique even length continued fraction expansion for each rational number in the definition of K . We have for the first rational number $-46/327$,

$$-\frac{46}{327} = 0 + \frac{1}{-\frac{327}{46}} = 0 + \frac{1}{-7 + (-\frac{5}{46})} = 0 + \frac{1}{-7 + \frac{1}{-\frac{46}{5}}} = 0 + \frac{1}{-7 + \frac{1}{-9 + (-\frac{1}{5})}} = [0, -7, -9, -5].$$

This is of odd length, so the unique even length continued fraction expansion for $-\frac{46}{327}$ is

$$-\frac{46}{327} = [0, -7, -9, -4, -1].$$

The rational numbers together with their unique even length continued fractions expansions are

$$-\frac{46}{327} = [0, -7, -9, -4, -1], \quad \frac{35}{151} = [0, 4, 3, 5, 2], \quad \frac{5}{31} = [0, 6, 5], \quad \frac{16}{35} = [0, 2, 5, 2, 1], \quad \frac{1}{5} = [0, 4, 1].$$

The associated pretzel knot is $P(-7, 5, 7, 3, 5)$. Theorem 1.2 applied to the pretzel knot gives that

$$s(q) = -\frac{36}{7} < 0 \text{ and } s_1(q) = -\frac{32}{7}.$$

So

$$\text{js}_P(n) = (-2)(-\frac{36}{7}) = \frac{72}{7} \text{ and } \text{jx}_P(n) = -2(-\frac{32}{7}) + 4(-\frac{36}{7}) - 2(4 - 1) = -\frac{122}{7}.$$

Dunfield's program [Dun01], which computes boundary slopes and other topological properties of essential surfaces for a Montesinos knot based on Hatcher and Oertel's algorithm, produces an essential surface S whose boundary slope equals $\text{js}_P(n) = -2s(q) = 72/7$, and such that $2\chi(S)/(7|\partial S|) = \text{jx}_P = -122/7$. Now we compute $\text{js}_K(n)$ and $\text{jx}_K(n)$ using Theorem 1.3. To aid in presentation, we replace each symbol in the equations in the theorem by

the number computed from the example. We have

$$\begin{aligned}
 \text{js}_K(n) &= \underbrace{\text{js}_P(n)}_{72/7} - \underbrace{r_0[2]}_{-9} - \underbrace{[r_0]}_{-4+-1} - \underbrace{\omega(D_P)}_{-13} + \underbrace{\omega(D_K)}_{-43} + \underbrace{\sum_{i=1}^m (r_i[2] - 1)}_{(2)+(4)+(4)} + \underbrace{\sum_{i=1}^m [r_i]}_{(5+2)+(2+1)} = \frac{100}{7}. \\
 \text{jx}_K(n) &= \underbrace{\text{jx}_P(n)}_{-122/7} - 2 + 2 \underbrace{[r_0]_o}_{-4} - 2 \underbrace{\sum_{i=1}^m (r_i[2] - 1)}_{(2)+(4)+(4)} - 2 \underbrace{\sum_{i=1}^m [r_i]_e}_{(2)+(1)} = -\frac{374}{7}.
 \end{aligned}$$

For the Montesinos knot, Dunfield’s program also produces an essential surface S which realizes the strong slope conjecture, with boundary slope $100/7$ and $2\chi(S)/7|\partial S| = -374/7$.

1.3. Plan of the proof. We divide the proof of Theorem 1.2 and Theorem 1.3 into two parts, first concerning the claims regarding the degree of the colored Jones polynomial, and the second concerning the existence of essential surfaces realizing the strong slope conjecture.

First we use a mix of skein theory and fusion, reviewed in Section 2.3, to find a formula for the degree of the dominant terms in the resulting state sum for the colored Jones polynomial in Section 3. Using quadratic integer programming techniques we determine the maximal degree of these dominant terms in Section 4, and this is applied to find the degree of the colored Jones polynomial for the pretzel knots we consider in Section 4.3. In Section 5 we determine the degree of the colored Jones polynomial for the Montesinos knots we consider in Theorem 1.3 by reducing to the pretzel case. Finally, we work out the relevant surfaces using the Hatcher-Oertel algorithm in Section 6, and we match the growth rate of the degree of the quantum invariant with the topology, using the analogy drawn between the parameters of the state sum and the parameters for the Hatcher-Oertel algorithm by Lemma 6.3. We explicitly describe the essential surfaces realizing the strong slope conjecture in Sections 6.5 and 6.7, and the proofs of Theorem 1.2 and Theorem 1.3 are completed in Section 6.6 and Section 6.8, respectively.

2. PRELIMINARIES

2.1. Rational tangles. Let us recall how to describe rational tangles by rational numbers and their continued fraction expansions. Originally studied by Conway [Con70], this material is well-known and may be found for instance in [KL04, BS]. An (m, n) -tangle is an embedding of a finite collection of arcs and circles into B^3 , such that the endpoints of the arcs lie in the set of $m + n$ points on $\partial B^3 = S^2$. We consider tangles up to isotopy of the ball B^3 fixing the boundary 2-sphere. The integer m indicates the number of points on the upper hemisphere of S^2 , and the integer n indicates the number of points on the lower hemisphere. We may isotope a tangle so that its endpoints are arranged on a great circle of the boundary 2-sphere S^2 , preserving the upper/lower information of endpoints from the upper/lower hemisphere. A tangle diagram is then a regular projection of the tangle onto the plane of this great circle. We represent tangles by tangle diagrams, and we will refer to an (m, m) -tangle as an m -tangle. Our building blocks of rational tangles are the horizontal and the vertical 2-tangles shown below, called elementary tangles in [KL04].

- A *horizontal tangle* has n horizontal half-twists (i.e., crossings) for $n \in \mathbb{Z}$.

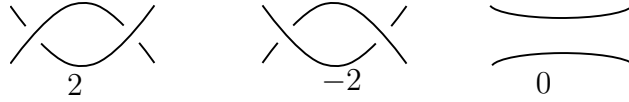

- A *vertical tangle* has n vertical half-twists (i.e., crossings) for $n \in \mathbb{Z}$.

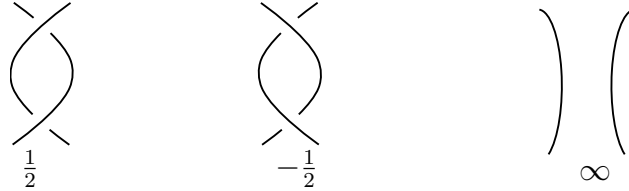

The horizontal tangle with 0 half-twists will be called the 0 tangle, and the vertical tangle with 0 half-twists will be called the ∞ tangle.

Definition 2.1. A rational tangle is a $2m$ -tangle that can be obtained by applying a finite number of consecutive twists of neighboring endpoints to the 0 tangle and the ∞ tangle.

For $2m$ -tangles we define tangle addition, denoted by \oplus , and tangle multiplication, denoted by $*$, as follows in Figure 3. We also define the numerator closure of a $2m$ -tangle as a knot or link obtained by joining the two sets of m endpoints in the upper hemisphere, and by joining the two sets of m endpoints in the lower hemisphere.

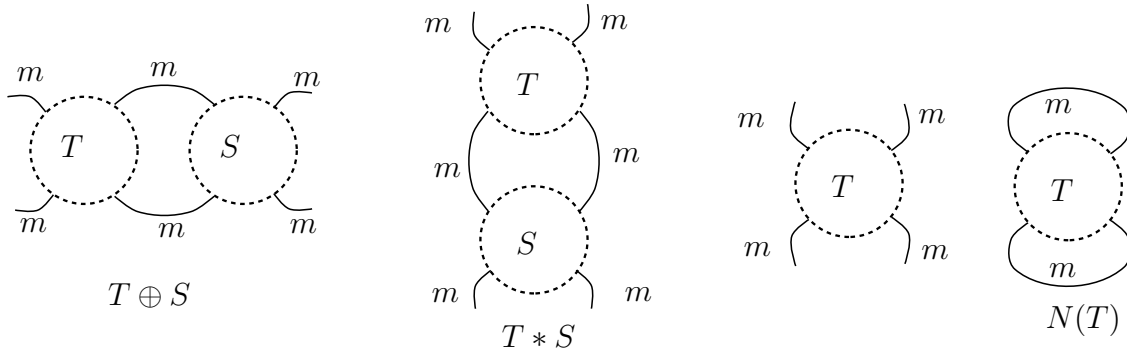

FIGURE 3. $2m$ -tangle addition, multiplication, and numerator closure.

The following theorem is paraphrased from [KL04] with changes in notations for the elementary rational tangles.

Theorem 2.2. [KL04, Lemma 3] *Every rational tangle can be isotoped to have a diagram in standard form, obtained by consecutive additions of horizontal tangles only on the right (or only on the left) and consecutive multiplications by vertical tangles only at the bottom (or only at the top), starting from the 0 tangle or the ∞ tangle.*

More precisely, every rational tangle diagram may be isotoped to have the algebraic presentation

$$\left(\left(\left(a_\ell * \frac{1}{a_{\ell-1}} \right) \oplus a_{\ell-2} \right) * \cdots * \frac{1}{a_1} \right) \oplus a_0, \quad (6)$$

if ℓ is even, or

$$\left(\left(\left(\frac{1}{a_\ell} \oplus a_{\ell-1}\right) * a_{\ell-2}\right) \oplus \cdots * \frac{1}{a_1}\right) \oplus a_0, \quad (7)$$

if ℓ is odd, where $a_j \in \mathbb{Z}$ for $0 \leq j \leq \ell$, and $a_j \neq 0$ for $1 \leq j \leq \ell$.

Recall the notation of the positive continued fraction expansion [KL04, BS]:

$$[a_0, \dots, a_\ell] = a_0 + \frac{1}{a_1 + \frac{1}{a_2 + \frac{1}{a_3 + \cdots + \frac{1}{a_\ell}}}} \quad (8)$$

for integers $a_j \neq 0$ of the same sign for $1 \leq j \leq \ell$ and $a_0 \in \mathbb{Z}$. We define the rational number r associated to a rational tangle in standard form with algebraic expression (6) or (7) to be

$$r = [a_0, \dots, a_\ell].$$

Conversely, given a positive continued fraction expansion of a rational number $r = [a_0, \dots, a_\ell]$ we may obtain a diagram of a rational tangle given by the corresponding algebraic expression (6) or (7). See Figure 4 for an example.

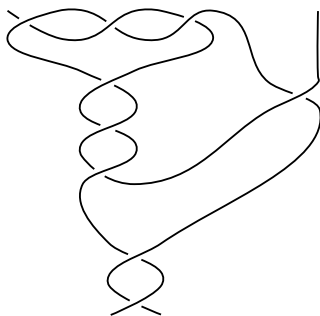

FIGURE 4. A rational tangle diagram T associated to the continued fraction expansion $[0, 2, 1, 3, 3] = 13/36$.

A rational tangle is determined by their associated rational number to a standard diagram by the following theorem.

Theorem 2.3. [Con70] *Two rational tangles are isotopic if and only if they have the same associated rational number.*

See [KL04, Theorem 3] for a proof of this statement.

Definition 2.4. A *Montesinos link* $K(r_0, r_1, \dots, r_m)$ is a link that admits a diagram D obtained by summing rational tangle diagrams $T_{c_0}, T_{c_1}, \dots, T_{c_m}$ then taking the numerator closure:

$$D = N((T_{c_0} \oplus T_{c_1}) \oplus T_{c_2} \oplus \cdots \oplus T_{c_m}).$$

Here c_i for each $0 \leq i \leq m$ is a choice of a positive continued fraction expansion of r_i , and T_{c_i} is the rational tangle diagram constructed based on c_i via (6) or (7), depending on whether the length of c_i is even or odd, respectively.

Note that a different choice of positive continued fraction expansion for each r_i in the sum of Definition 2.4 produces a different diagram of the same knot by Theorem 2.3. To simplify our arguments, we will fix a diagram for the Montesinos knot $K(r_0, r_1, \dots, r_m)$ by specifying the choice of a positive continued fraction expansion for each rational number r_i .

2.2. Classification of Montesinos links. The book [BZ03] has a complete account of the classification of Montesinos links, originally due to Bonahon [Bon79]. The following version of the classification theorem comes from [FKP13].

Theorem 2.5. [BZ03, Theorem 12.29] *Let $K(r_0, \dots, r_m)$ be a Montesinos link such that $m \geq 3$ and $r_0, \dots, r_m \in \mathbb{Q} \setminus \mathbb{Z}$. Then K is determined up to isomorphism by the rational number $\sum_{i=0}^m r_m$ and the vector $((r_0 \bmod 1), (r_1 \bmod 1), \dots, (r_m \bmod 1))$, up to cyclic permutation and reversal of order.*

We will work with *reduced* diagrams for Montesinos knots as studied by Lickorish and Thistlethwaite [LT88]. Here we follow the exposition of [FKP13, Chapter 8].

Definition 2.6. Let K be a Montesinos link. A diagram is called a *reduced Montesinos diagram* of K if it is the numerator closure of the sum of rational angles T_0, \dots, T_m corresponding to rational numbers r_0, \dots, r_m with $m \geq 2$, and both of the following hold:

- (1) Either all of the r_i 's have the same sign, or $0 < |r_i| < 1$ for all i .
- (2) For each i , the diagram of T_i comes from a positive continued fraction expansion $[a_0, a_1, \dots, a_{\ell_i}]$ of r_i with the nonzero a_j 's all of the same sign as r_i .

It follows as a consequence of the classification theorem that every Montesinos link $K(r_0, \dots, r_m)$ with $m \geq 2$ has a reduced diagram. For example, if $r_i < 0$ while $r_{i'} \geq 1$, we can subtract 1 from $r_{i'}$ and add 1 to r_i until condition (1) is satisfied. This does not change the link type of the Montesinos link by Theorem 2.5. Since we are focused on Montesinos links with precisely one negative tangle we may assume that $0 < |r_i| < 1$. Thus $r_i[0] = 0$ for all $0 \leq i \leq m$.

2.3. Skein theory and the colored Jones polynomial. We consider the skein module of properly embedded tangle diagrams on an oriented surface F with a finite (possibly empty) collection of points specified on the boundary ∂F . This will be used to give a definition of the colored Jones polynomial from a diagram of a link. For the original reference for skein modules see [Prz91]. We will follow Lickorish's approach [Lic97, Section 13] except for the variable substitution (our v is his A^{-1} to avoid confusion with the A for a Kauffman state). See [Oht01] for how the skein theory gives the colored Jones polynomial, also known as the quantum \mathfrak{sl}_2 invariant. The word "color" refers to the weight of the irreducible representation where one evaluates the invariant.

Definition 2.7. Let v be a fixed complex number. The linear skein module $\mathcal{S}(F)$ of F is a vector space of formal linear sums over \mathbb{C} , of unoriented and properly-embedded tangle diagrams in F , considered up to isotopy of F fixing ∂F , and quotiented by the *skein relations*

- (i) $D \sqcup \bigcirc = (-v^{-2} - v^2)D$, and
- (ii) $\begin{array}{c} \diagup \\ \diagdown \end{array} = v^{-1} \left(+v \begin{array}{c} \frown \\ \smile \end{array} \right)$.

Here \bigcirc denotes the unknot and $D \sqcup \bigcirc$ is the disjoint union of the diagram D with an unknot. Relation (ii) indicates how we can write a diagram with a crossing as a sum of two

diagrams with coefficients in rational functions of v by locally replacing the crossing by the two splittings on the right.

We consider the linear skein module $\mathcal{S}(D^2, n, n')$ of the disk D^2 with $n + n'$ -points specified on its boundary, where the boundary is viewed as a rectangle with n marked points above and n' marked points below. We will use this to decompose link diagrams into tangles. By the skein relations in Definition 2.7, every element in $\mathcal{S}(D^2, n, n')$ is generated by crossingless matchings between the n points on top and n' points below. For crossingless matchings $D_1 \in \mathcal{S}(D^2, n, n')$ and $D_2 \in \mathcal{S}(D^2, n', n'')$, there is a natural multiplication operation $D_1 \times D_2 \in \mathcal{S}(D^2, n, n'')$ defined by identifying the bottom boundary of D_1 with the top boundary of D_2 and matching the n' common boundary points. Extending this by linearity to all elements in $\mathcal{S}(D^2, n, n)$ makes it into an algebra TL_n^n , called *Temperley-Lieb algebra*. For the original references see [TL71, KL94]. We will simply write TL_n for TL_n^n . There is a natural identification of $2n$ -tangles with diagrams in TL_{2n} . Pictorially, a non-negative integer such as n next to a strand represents n parallel strands.

As an algebra, TL_n is generated by a basis $\{|_n, e_n^1, \dots, e_n^{n-1}\}$, where $|_n$ is the identity with respect to the multiplication, and e_n^i is a crossingless tangle diagram as specified below in Figure 5.

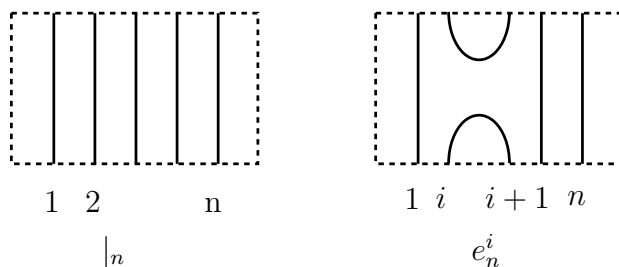

FIGURE 5. An example of the identity element $|_n$ (left) and a generator e_n^i (right) of TL_n for $n = 5$ and $i = 2$.

Suppose that v^{-4} is not a k th root of unity for $k \leq n$. There is an element, which we will denote by \boxplus_n , in TL_n called the n th *Jones-Wenzl idempotent*. For the original reference where the idempotent was defined and studied, see [Wen87]. Whenever n is specified we will simply refer to this element as the Jones-Wenzl idempotent.

The element \boxplus_n is uniquely defined by the following properties. (Note $\boxplus_1 = |_1$.)

- (i) $\boxplus_n \times e_n^i = e_n^i \times \boxplus_n = 0$ for $1 \leq i \leq n - 1$.
- (ii) $\boxplus_n - |_n$ belongs to the algebra generated by $\{e_n^1, e_n^2, \dots, e_n^{n-1}\}$.
- (iii) $\boxplus_n \times \boxplus_n = \boxplus_n$.
- (iv) The image of \boxplus_n in $\mathcal{S}(\mathbb{R}^2)$, obtained by embedding the disk D^2 in the plane and then joining the n boundary points on the top with those on the bottom with n disjoint planar parallel arcs outside of D^2 , is equal to

$$\frac{(-1)^n (v^{-2(n+1)} - v^{2(n+1)})}{v^{-2} - v^2} \cdot \text{the empty diagram in } \mathbb{R}^2.$$

We will denote the rational function multiplying the empty diagram by Δ_n .

Definition 2.8. Let D be a diagram of a link $K \subset S^3$ with k components. For each component D_i for $i \in \{1, \dots, k\}$ take an annulus $A_i = S^1 \times I$ containing D via the blackboard framing. Let $\mathcal{S}(S^1 \times I)$ be the linear skein module of the annulus with no points marked on its boundary, and let

$$f_D : \underbrace{\mathcal{S}(A_1) \times \dots \times \mathcal{S}(A_k)}_{\text{Cartesian product}} \rightarrow \mathcal{S}(\mathbb{R}^2)$$

be the map which sends a k -tuple of elements $(s_1 \in \mathcal{S}(A_1), \dots, s_k \in \mathcal{S}(A_k))$ to $\mathcal{S}(\mathbb{R}^2)$ by immersing in the plane the collection of skein elements in $\mathcal{S}(A_i)$ such that the over- and under-crossings of components of D are the over- and under-crossings of the annuli. For $n \geq 1$, the $n + 1$ th unreduced colored Jones polynomial $J_{K,n+1}(v)$ may be defined as

$$J_{K,n+1}(v) := ((-1)^n v)^{\omega(D)(n^2+2n)} (-1)^n \left\langle f_D \left(\underbrace{\left(\begin{array}{c} \text{Diagram 1} \\ \text{Diagram 2} \\ \dots \\ \text{Diagram } k \end{array} \right)}_{k \text{ times}} \right) \right\rangle,$$

where $\langle \mathcal{S} \rangle$ for a linear skein element in $\mathcal{S}(\mathbb{R}^2)$ is the polynomial in v multiplying the empty diagram after resolving crossings and removing disjoint circles of \mathcal{S} using the skein relations. This is called the *Kauffman bracket* of \mathcal{S} . To simplify notation, we will write

$$D^n = f_D \left(\begin{array}{c} \text{Diagram 1} \\ \text{Diagram 2} \\ \dots \\ \text{Diagram } k \end{array} \right).$$

A Kauffman state [Kau87], which we will denote by σ , is a choice of the A - or B -resolution at a crossing of a link diagram.

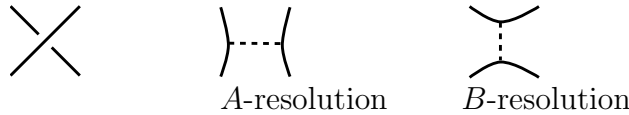

FIGURE 6. A - and B -resolutions of a crossing. The dashed segment records the location where the crossing was.

Definition 2.9. Let σ be a Kauffman state on a skein element with crossings, define

$$\text{sgn}(\sigma) = (\# \text{ of } B\text{-resolutions of } \sigma) - (\# \text{ of } A\text{-resolutions of } \sigma).$$

This quantity keeps track of the number of A - and B -resolutions chosen by σ .

Definition 2.10. Given a skein element \mathcal{S} with crossings in $\mathcal{S}(\mathbb{R}^2)$, the σ -state denoted by \mathcal{S}_σ is the set of disjoint arcs and circles, possibly connecting Jones-Wenzl idempotents, resulting from applying a Kauffman state σ to \mathcal{S} . The σ -state graph \mathcal{S}_σ^G is the set of disjoint arcs and circles, possibly connecting Jones-Wenzl idempotents, resulting from applying a

Kauffman state σ to \mathcal{S} along with (dashed) segments recording the original locations of the crossings as shown in Figure 6.

We summarize standard techniques and formulas for computing the colored Jones polynomial using Definition 2.8 that are used in this paper. Given a diagram D^n decorated with a single Jones-Wenzl idempotent from a link, a *state sum* for the Kauffman bracket $\langle D^n \rangle$ of D^n is an expansion of $\langle D^n \rangle$ into a sum over skein elements $(D^n)_\sigma$ resulting from applying a Kauffman state σ on a subset of crossings in D^n . As an example, one can compute the second colored Jones polynomial of the trefoil knot 3_1 by writing down the following state sum in Figure 7.

$$\begin{aligned}
 \langle \text{trefoil} \rangle &= v^{-3} \langle \text{state 1} \rangle + v^{-1} \langle \text{state 2} \rangle + v \langle \text{state 3} \rangle \\
 &+ v \langle \text{state 4} \rangle + v \langle \text{state 5} \rangle + v^{-1} \langle \text{state 6} \rangle \\
 &+ v^{-1} \langle \text{state 7} \rangle + v^3 \langle \text{state 8} \rangle \\
 &= \sum_{\sigma \text{ a Kauffman state}} v^{\text{sgn}(\sigma)} \langle (D^1)_\sigma \rangle.
 \end{aligned}$$

FIGURE 7. A state sum for the 2nd colored Jones polynomial of the left-hand trefoil 3_1 . In this example, Kauffman states are taken over the set of all crossings of the diagram.

We are left with disjoint arcs and circles connecting the Jones-Wenzl idempotent. These may be removed by applying skein relations and by applying properties of the idempotent to obtain the polynomial. Note that we can also write down a state sum for a skein element with crossings which may be decorated by Jones-Wenzl idempotents.

Since we are interested in bounding degrees of the Kauffman brackets of skein elements in the state sum, we will define a few more relevant combinatorial quantities and gather some useful results.

The *degree* of a rational function $L(v)$, denoted by $\deg_v(L(v))$, is the maximum power of v in the formal Laurent series expansion of $L(v)$ with finitely many positive degree terms.

Let \mathcal{S}_σ be a skein element coming from applying a Kauffman state σ to a skein element \mathcal{S} with crossings and decorated by Jones-Wenzl idempotents in $\mathcal{S}(\mathbb{R}^2)$. Then $\overline{\mathcal{S}_\sigma}$ is the set of disjoint circles obtained from \mathcal{S}_σ by replacing all idempotents with the identity.

Definition 2.11. A *sequence* s of states starting at σ_1 and ending at σ_f on a set of crossings in a skein element \mathcal{S} is a finite sequence of Kauffman states $\sigma_1, \dots, \sigma_f$, where σ_i and σ_{i+1} differ on the choice of the A - or B -resolution at only one crossing x , so that σ_{i+1} chooses the A -resolution at x and σ_i chooses the B -resolution.

Let $s = \{\sigma_1, \dots, \sigma_f\}$ be a sequence of states starting at σ_1 and ending at σ_f . In each step from σ_i to σ_{i+1} either two circles of $\overline{\mathcal{S}_{\sigma_i}}$ merge into one or a circle of $\overline{\mathcal{S}_{\sigma_i}}$ splits into two. When two circles merge into one as the result of changing the B -resolution to the A -resolution, the number of circles of the skein element decreases by 1 while the sign of the state decreases by 2. More precisely, let \mathcal{S}_σ be the skein element resulting from applying the Kauffman state σ , we have

$$\operatorname{sgn}(\sigma_{i+1}) + \deg_v \langle \overline{\mathcal{S}_{\sigma_{i+1}}} \rangle = \operatorname{sgn}(\sigma_i) + \deg_v \langle \overline{\mathcal{S}_{\sigma_i}} \rangle - 4,$$

when a pair of circles merges from $\overline{\mathcal{S}_{\sigma_i}}$ to $\overline{\mathcal{S}_{\sigma_{i+1}}}$. This immediately gives the following corollary.

Lemma 2.12. Let $s = \{\sigma_1, \dots, \sigma_f\}$ be a sequence of states on a skein element \mathcal{S} with crossings, then

$$\operatorname{sgn}(\sigma_1) + \deg_v \langle \overline{\mathcal{S}_{\sigma_1}} \rangle = \operatorname{sgn}(\sigma_f) + \deg_v \langle \overline{\mathcal{S}_{\sigma_f}} \rangle$$

if and only if a circle is split from $\overline{\mathcal{S}_{\sigma_i}}$ to $\overline{\mathcal{S}_{\sigma_{i+1}}}$ for every $1 \leq i \leq f - 1$. Otherwise

$$\operatorname{sgn}(\sigma_1) + \deg_v \langle \overline{\mathcal{S}_{\sigma_1}} \rangle > \operatorname{sgn}(\sigma_f) + \deg_v \langle \overline{\mathcal{S}_{\sigma_f}} \rangle.$$

We will also use standard fusion and untwisting formulas involving skein elements decorated by Jones-Wenzl idempotents for which one can consult [Lic97] and the original reference [MV94].

$$\begin{array}{c} \text{Diagram 1: Two crossings with strands } b \text{ and } a. \end{array} = \sum_{\substack{c:(a,b,c) \\ \text{admissible}}} \frac{\Delta_c}{\theta(a,b,c)} \begin{array}{c} \text{Diagram 2: Two crossings with strands } b, a, \text{ and } c/2. \end{array} \quad (9)$$

FIGURE 8. Fusion formula: the skein element which locally looks like the left-hand side is equal to the sum of skein elements on the right-hand side with corresponding local replacements.

$$\begin{aligned}
 & \text{Left Diagram} = (-1)^{\frac{a+b-c}{2}} v^{a+b-c + \frac{a^2+b^2-c^2}{2}} \text{Right Diagram} \\
 & \hspace{15em} (10)
 \end{aligned}$$

FIGURE 9. Untwisting formula: the skein element which locally looks like the left-hand side is equal to the skein element on the right-hand side with the local replacement.

We say that a triple (a, b, c) of non-negative integers is admissible if $a + b + c$ is even and $a \leq b + c$, $b \leq c + a$, and $c \leq a + b$. For k a non-negative integer, let $\Delta_k! := \Delta_k \Delta_{k-1} \cdots \Delta_1$, with the convention that $\Delta_0 = \Delta_{-1} = 1$. In Figure 8 above, the function $\theta(a, b, c)$ is defined by

$$\theta(a, b, c) = \frac{\Delta_{x+y+z}! \Delta_{x-1}! \Delta_{y-1}! \Delta_{z-1}!}{\Delta_{y+z-1}! \Delta_{z+x-1}! \Delta_{x+y-1}!},$$

where x, y , and z are determined by $a = y + z$, $b = z + x$, and $c = x + y$.

3. THE COLORED JONES POLYNOMIAL OF PRETZEL KNOTS

From this point on we will always consider the *standard diagram* K when referring to the pretzel knot $K = P(q_0, \dots, q_m)$, with $|q_i| > 1$. Throughout the section the integer $n \geq 2$ is fixed, and we will illustrate graphically using the example $P(-5, 3, 3, 3, 5)$.

The colored Jones polynomial for a fixed n of a knot is by Definition 2.8 the Kauffman bracket of the n -blackboard cable (n -cable for short) of a diagram of K decorated by a Jones-Wenzl idempotent, multiplied by a monomial in v raised to the power of the writhe of the diagram with orientation. We write the colored Jones polynomial as

$$J_{K,n+1}(v) = ((-1)^n v)^{\omega(K)n(n+2)} (-1)^n \langle K^n \rangle.$$

The Jones-Wenzl idempotent is a sum of tangle diagrams with coefficients rational functions of v in the algebra TL_n . A skein element in TL_n^n decorated by Jones-Wenzl idempotents is thus also a sum of tangle diagrams with coefficients rational functions of v by locally replacing idempotent with its sum. We extend the tangle sum operation \oplus to skein elements \mathcal{S} in TL_{2n} decorated by Jones-Wenzl idempotents, written

$$\mathcal{S} = \sum_{T \in \text{TL}_{2n}} s(v)T,$$

as

$$\mathcal{S} \oplus \mathcal{S}' = \sum_{T, T' \in \text{TL}_{2n}} s(v)s'(v)T \oplus T'.$$

Graphically, this will be the same as joining the top right and bottom right $2n$ -strands of \mathcal{S} to the top left and bottom left $2n$ -strands to \mathcal{S}' as in Figure 3, except with the presence of

the idempotent and possibly crossings indicating that this is actually a sum of such diagrams in TL_{2n} . Similarly, we extend the numerator closure to skein elements in TL_{2n} .

We will represent the diagram $K^n = N(K_-^n \oplus K_+^n)$ as the numerator closure of the sum of two $2n$ -tangles decorated by Jones-Wenzl idempotents, with the label n indicating the number of parallel strands. This decomposition of K^n reflects the original splitting of $K = N(K_- \oplus K_+)$ into two 2-tangles K_- and K_+ . A twist region is a vertical 2-tangle with a nonzero number of crossings all of the same sign. Let K_- be the negative twist region consisting of $-q_0$ crossings, and K_+ the rest of the diagram K . For a fixed n double the idempotents in K^n so that four are framing the n -cable of the negative twist region consisting of $-q_0$ crossings, and four are framing the n -cable of the rest of the knot diagram. The $2n$ -tangle K_-^n is the n -cable of K_- along with the four idempotents, and K_+^n is the rest of K^n , which is the n -cable of K_+ , also decorated with four idempotents. See the middle figure in Figure 10.

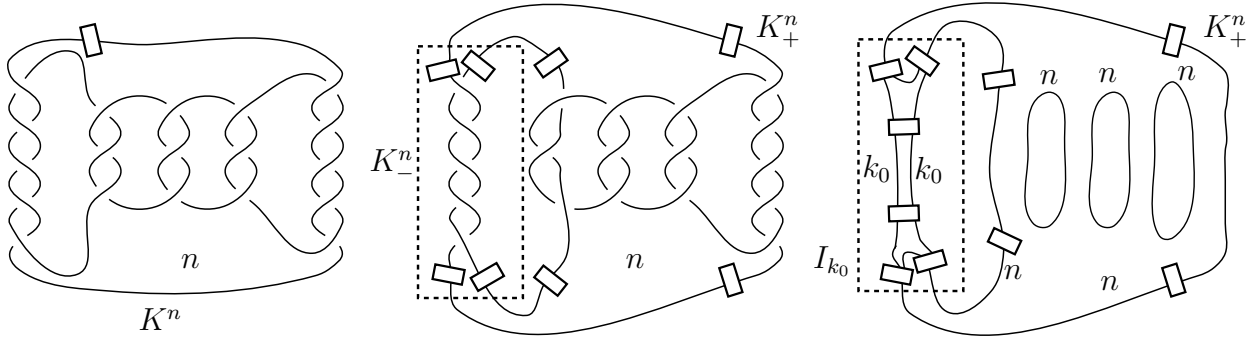

FIGURE 10. From left to right: K^n , doubling the idempotents and the splitting $K^n = N(K_-^n \oplus K_+^n)$, and $N(I_{k_0} \oplus (K_+^n)_{\sigma_A})$, where σ_A is the Kauffman state that chooses the A -resolution on all the crossings in K_+^n . The dotted boxes enclose the skein elements in $\mathcal{S}(D^2, 2n, 2n)$, which are sums of $2n$ -tangles.

It is convenient to compute the bracket of these $2n$ -tangles first. For any tangle T write $\langle T^n \rangle$ to mean cabling each component by a Jones-Wenzl idempotent of order n and evaluating in the Temperley-Lieb algebra TL_{2n} using the Kauffman bracket.

We write $\langle K_-^n \rangle = \sum_{k_0} G_{k_0}(v) I_{k_0}$ for $2n$ -tangles I_{k_0} with four Jones-Wenzl idempotents of size n connected in the middle by two Jones-Wenzl idempotents of size $2k_0$ arranged in an I -shape using the fusion and untwisting formulas. Apply the fusion formula (9) to two strands of K_-^n going into (or coming out of) the n -cabled negative twist region. Then, apply the untwisting formula (10) to get rid of all the negative crossings. The function $G_{k_0}(v) = \frac{\Delta_{2k_0}}{\theta(n, n, 2k_0)} ((-1)^{n-k_0} v^{2n-2k_0+n^2-2k_0^2})^{q_0}$ is a rational function that is the product of two coefficient functions in v multiplying the replacement skein elements. The other tangle K_+^n is expanded into a state sum by taking Kauffman states over all the crossings in K_+^n , leaving the four Jones-Wenzl idempotents of size n . Let $(K_+^n)_\sigma$ denote the skein element resulting from applying a Kauffman state σ to all the crossings of K_+^n . Then, $\langle K^n \rangle = \sum_\sigma v^{\text{sgn}(\sigma)} \langle (K_+^n)_\sigma \rangle$ as

discussed in Section 2.3. The state sum we consider is indexed by pairs (k_0, σ) and we write

$$\langle K^n \rangle = \sum_{(k_0, \sigma)} G_{k_0}(v) v^{\text{sgn}(\sigma)} \langle N(I_{k_0} \oplus (K_+^n)_\sigma) \rangle. \quad (11)$$

See the rightmost figure of Figure 10 for an example of $N(I_{k_0} \oplus (K_+^n)_\sigma)$. Using the notion of through strands, we collect like terms together in our state sum.

Definition 3.1. Consider the Temperley-Lieb algebra TL_n^n with n inputs and n' outputs. Let T be an element of TL_n^n with no crossings. Viewing ∂D^2 as a square, an arc in T with one endpoint on the top boundary of the disk D^2 defining TL_n^n and another endpoint on the bottom boundary is called a *through strand* of T .

We can organize states (k_0, σ) according to the number of through strands at various levels. The *global* number of through strands of σ , denoted by $c = c(\sigma)$, is the number of through strands of $(K_+^n)_\sigma$ in TL_{2n} inside the box framed by four idempotents in K_+^n , see Figure 11 for examples of Kauffman states $(K_+^n)_\sigma$ and their through strands.

For $1 \leq i \leq m$, we will also define $c_i(\sigma)$ to be the number of i th *local* through strands when restricting σ to the i th twist region, that are also global through strands. The parameter k_i corresponding to a Kauffman state σ for each twist region q_i will be defined as $k_i(\sigma) = \lceil \frac{c_i(\sigma)}{2} \rceil$. The intuition for these parameters is that they will be used to bound the degree of each term in the state sum relative to each other, which is crucial to determining the degree of the n th colored Jones polynomial $J_{K, n+1}$.

With the notation $k = (k_0, \dots, k_m)$ we set

$$\mathcal{G}_{c,k} = \sum_{k_0} \sum_{\sigma: k_i(\sigma)=k_i, c(\sigma)=c} G_{k_0}(v) v^{\text{sgn}(\sigma)} \langle N(I_{k_0} \oplus (K_+^n)_\sigma) \rangle. \quad (12)$$

Note $0 \leq k_i \leq n$ and define the parameters c, k to be *tight* if $k_0 = k_1 + \dots + k_m = \frac{c}{2}$. We prove the following theorem.

Theorem 3.2. Assume $|q_i| > 1$ and write $\langle K^n \rangle = \sum_{c,k} \mathcal{G}_{c,k}$ using (11) and (12). For tight c, k we have $\mathcal{G}_{c,k} = (-1)^{q_0(n-k_0)+n+k_0+\sum_{i=1}^m(n-k_i)(q_i-1)} v^{\delta(n,k)} + l.o.t.$ ¹ and $\delta(n, k) =$

$$-2 \left((q_0 + 1)k_0^2 + \sum_{i=1}^m (q_i - 1)k_i^2 + \sum_{i=1}^m (-2 + q_0 + q_i)k_i - \frac{n(n+2)}{2} \sum_{i=0}^m q_i + (m-1)n \right). \quad (13)$$

If c, k are not tight then there exists a tight pair c', k' (coming from some Kauffman state) such that $\deg_v \mathcal{G}_{c,k} < \deg_v \mathcal{G}_{c',k'}$.

This theorem will be used in the next section to find the actual degree of $J_{K, n+1}$ using quadratic integer programming.

3.1. Outline of the proof of Theorem 3.2. Let c, k be tight and let $st(c, k)$ be the set of states (k_0, σ) with $c(\sigma) = c$ and $k_i(\sigma) = k_i$ for all $1 \leq i \leq m$. A state in $st(c, k)$ is said to be *taut* if its term $G_{k_0}(v) v^{\text{sgn}(\sigma)} \langle N(I_{k_0} \oplus (K_+^n)_\sigma) \rangle$ in (12) maximizes the v -degree within $st(c, k)$. For any fixed tight c, k we plan to construct all taut states. The first examples we

¹The abbreviation *l.o.t.* means lower order terms in v .

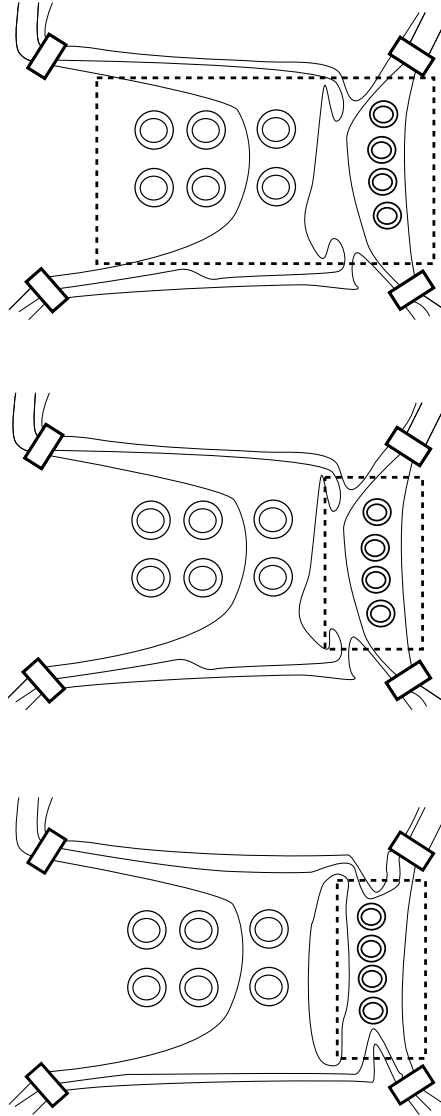

FIGURE 11. Top: an example of $(K_+^n)_\sigma$ with $n = 3$ and $c(\sigma) = 4$. Middle: when restricting σ to $i = 4$ th twist region, we have $c_4(\sigma) = k_4(\sigma) = 2$. Bottom: we show an example of a state σ where $c_4(\sigma) = 1$ and therefore $k_4(\sigma) = \lceil \frac{1}{2} \rceil = 1$.

construct will be *minimal states*, from which we will derive all taut states. A state in $st(c, k)$ is minimal if it chooses the least number of A -resolutions.

We will first show that minimal states are characterized by having a certain configuration, or position, on the set of crossings where they choose the A -resolution, called *pyramidal*. This will also be used to show that c, k not tight implies $\deg_v \mathcal{G}_{c, k} < \deg_v \mathcal{G}_{c', k'}$ for some tight pair c', k' .

Then, with the construction of all taut states from minimal states, we show that $\delta(n, k)$ is the degree of a taut state with parameters k , and

$$\mathcal{G}_{c,k}^{\text{taut}} = (-1)^{q_0(n-k_0)+n+k_0+\sum_{i=1}^m(n-k_i)(q_i-1)} \nu^{\delta(n,k)} + l.o.t.,$$

where $\mathcal{G}_{c,k}^{\text{taut}}$ is the double sum of $\mathcal{G}_{c,k}$ only over taut states with tight c, k . This will lead to

$$\mathcal{G}_{c,k}^{\text{taut}} = (-1)^{q_0(n-k_0)+n+k_0+\sum_{i=1}^m(n-k_i)(q_i-1)} \nu^{\delta(n,k)} + l.o.t.$$

and conclude Theorem 3.2.

Conventions for representing a Kauffman state. Throughout the rest of Section 3, we will indicate schematically a crossingless skein element \mathcal{S}_σ , resulting from applying a Kauffman state to a skein element \mathcal{S} with crossings, by the following convention. Let \mathcal{S}_B^G be the all- B state graph of \mathcal{S} . For a Kauffman state σ let A_σ be the set of crossings of \mathcal{S} on which σ chooses the A -resolution, and define $|A_\sigma|$ to be the number of crossings in A_σ . The skein element \mathcal{S}_σ is represented by \mathcal{S}_B^G with colored edges, such that the edge in \mathcal{S}_B^G corresponding to a crossing in A_σ is colored red, and all other edges remain black. The skein element \mathcal{S}_σ may then be recovered from \mathcal{S}_B^G by a local replacement of two arcs with a dashed segment. See Figure 12 below.

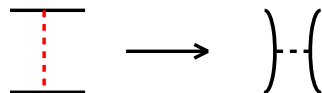

FIGURE 12. A red edge in \mathcal{S}_B^G indicates the choice of the A -resolution for a Kauffman state σ on \mathcal{S} .

3.2. Simplifying the state sum and pyramidal position for crossings. We will denote by $\mathcal{S}(k_0, \sigma)$ the skein element $N(I_{k_0} \oplus (K_+^n)_\sigma)$ as in (12).

Lemma 3.3. Fix (k_0, σ) determining a skein element $\mathcal{S}(k_0, \sigma)$ with $k_i = k_i(\sigma)$ and $c = c(\sigma)$. If $k_0 > \sum_{i=1}^m k_i$, then $\mathcal{S}(k_0, \sigma) = 0$.

Proof. Note that $\sum_{i=1}^m k_i \geq \frac{c}{2}$. Thus if $k_0 > \sum_{i=1}^m k_i$, then $k_0 > \frac{c}{2}$, and the lemma follows from [Lee, Lemma 3.2]. \square

With the information of through strands $c(\sigma)$ and $\{k_i(\sigma)\}$, we describe the structure of A_σ for a Kauffman state σ . It is necessary to introduce a labeling of the crossings with respect to their positions in the all- B Kauffman state graph $\mathcal{S}^G(k_0, B) = N(I_{k_0} \oplus (K_+^n)_B^G)$.

We first further decompose $K_+^n = \mathcal{S}^t \times \mathcal{S}^w \times \mathcal{S}^b$ where \times is the multiplication by stacking in TL, and let the crossings contained in those skein elements be denoted by C^t , C^w , and C^b , respectively. See Figure 13 for an example.

See Figure 14 for a guide to the labeling. The skein element $(K_+^n)_B$ consists of n arcs on top in the region defining \mathcal{S}^t , n arcs on the bottom in the region defining \mathcal{S}^b , and $q_i - 1$ sets of n circles for the i th twist region in the region defining \mathcal{S}^w . The n upper arcs are labeled by S_1^u, \dots, S_n^u , and the n lower arcs are labeled by $S_1^\ell, \dots, S_n^\ell$, respectively. C_j^u is the set of crossings whose corresponding segments in $(K_+^n)_B^G$ lie between the arcs S_j^u and S_{j+1}^u . Similarly we define C_j^ℓ by reflection.

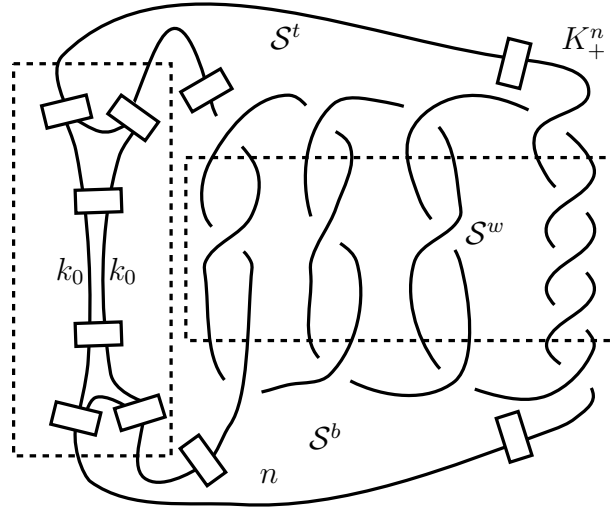

FIGURE 13. Skein element $\mathcal{S} = N(I_{k_0} \oplus (\mathcal{S}^t \times \mathcal{S}^w \times \mathcal{S}^b))$ of the pretzel knot $P(-5, 3, 3, 3, 5)$. We have $\mathcal{S}^t \in \text{TL}_{2mn}^{2n}$, $\mathcal{S}^w \in \text{TL}_{2mn}$, and $\mathcal{S}^b \in \text{TL}_{2n}^{2mn}$ where $m = 4$.

For the crossings in the region defining \mathcal{S}^w , we divide each set of n state circles into upper and lower half arcs as also shown in Figure 14, and use an additional label s for $1 \leq s \leq q_i$. Thus the notation $C_{i,j}^{\ell,s}$, where $1 \leq s \leq q_i$ for each twist region with q_i crossings and $1 \leq j \leq n$ indicating a circle in the n -cable, means the crossings between the state circles $S_{i,j}^{\ell,s}$ and $S_{i,j+1}^{\ell,s}$, see Figure 14.

It is helpful to see a local picture at each n -cabled crossing in K_+^n .

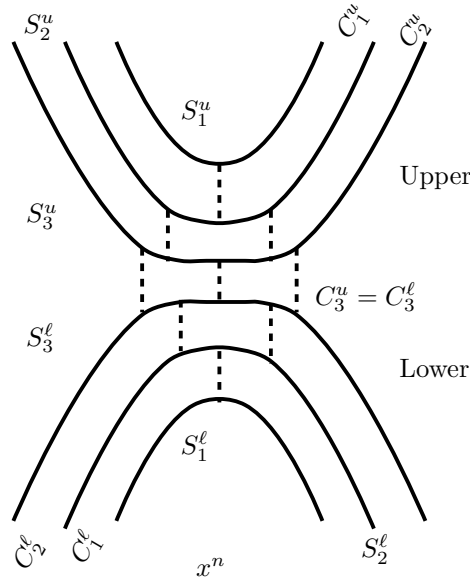

FIGURE 15. Local labeling of n^2 crossings on the all- B state of an n -cabled crossing. In this example $n = 3$.

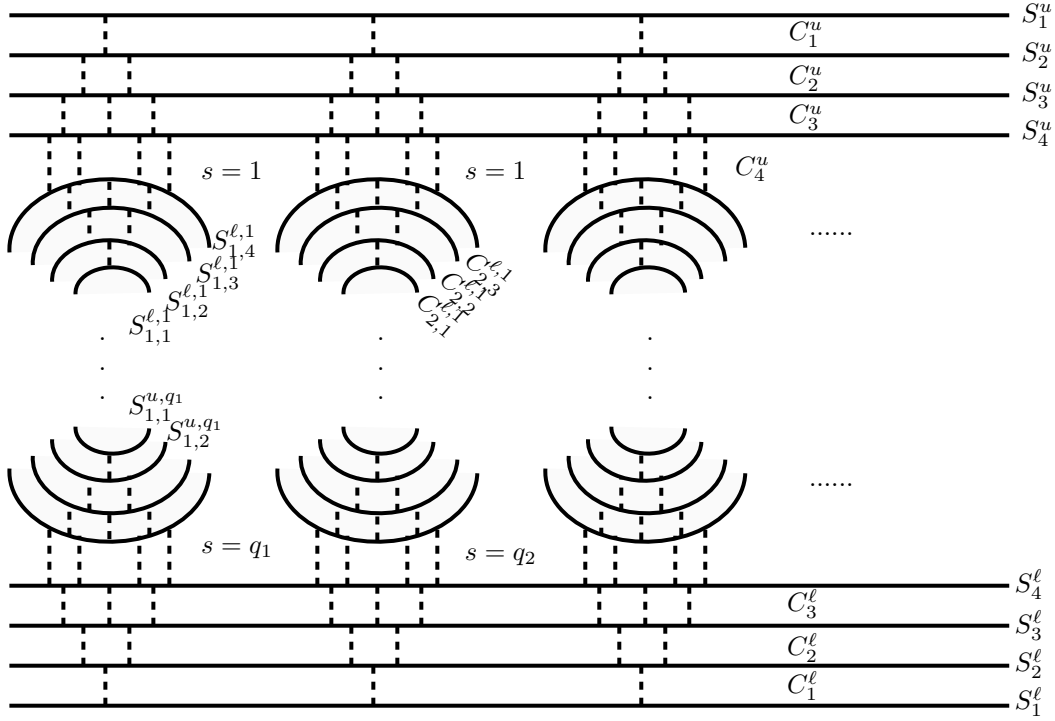

FIGURE 14. Labeling of crossings, arcs, and circles from applying the all- B state to K_+^n . In this example $n = 4$.

The goal of this subsection is to prove the following theorem.

Theorem 3.4. *Suppose a skein element $\mathcal{S}(k_0, \sigma)$ has parameters $k_i = k_i(\sigma)$ and $c = c(\sigma)$. Then there is a subset $A_\sigma \subseteq A_\sigma$ of crossings on which the Kauffman state σ chooses the A -resolution, such that we have $A_\sigma = A_\sigma^t \cup A_\sigma^w \cup A_\sigma^b$ denoting the crossings in the regions determining \mathcal{S}^t , \mathcal{S}^w , and \mathcal{S}^b , respectively, and the following conditions are satisfied.*

- (i) $|A_\sigma^w| = \sum_{i=1}^m (q_i - 2)k_i^2$. The set $A_\sigma^w = \cup_{i=1}^m \cup_{s=1}^{q_i} \cup_{j=n-k_i+1}^n (u_{i,j}^s \cup \ell_{i,j}^s)$ is a union of crossings with $u_{i,j}^s \subset C_{i,j}^{u,s}$ and $\ell_{i,j}^s \subset C_{i,j}^{\ell,s}$, such that
 - For each $n - k_i + 1 \leq j \leq n$, $u_{i,j}^s, \ell_{i,j}^s$ each has $j - n + k_i$ crossings.
 - For each $n - k_i + 2 \leq j \leq n$ and a pair of crossings x, x' in $u_{i,j}^s$ (resp. $\ell_{i,j}^s$) whose corresponding segments e, e' in $(K_+^n)_B^G$ are adjacent (i.e., there is no other edge in $u_{i,j}^s$ between e and e'), there is a crossing x'' in $u_{i,j-1}^s$ (resp. $\ell_{i,j-1}^s$), where the end of the corresponding segment e'' on $S_{i,j}^{u,s}$ (resp. $S_{i,j}^{\ell,s}$) lies between the ends of e and e' .
- (ii) $|A_\sigma^t| = |A_\sigma^b| = \frac{c^2/4 - c/2 + \sum_{i=1}^m (k_i^2 + k_i)}{2}$. The set $A_\sigma^t = \cup_{j=n-c/2+1}^n u_j$ is a union of crossings $u_j \subset C_j^u$, and the set $A_\sigma^b = \cup_{j=n-c/2+1}^n \ell_j$ is a union of crossings $\ell_j \subset C_j^\ell$ satisfying:
 - For $n - \frac{c}{2} + 1 \leq j \leq n$, u_j (resp. ℓ_j) has $j - n + \frac{c}{2}$ crossings.
 - For each $n - \frac{c}{2} + 2 \leq j \leq n$ and a pair of crossings x, x' in u_j (resp. ℓ_j) whose corresponding segments e, e' in $(K_+^n)_B^G$ are adjacent (i.e., there is no other crossing in u_j whose corresponding segment is between e and e'), there is a

crossing x'' in u_{j-1} (resp. ℓ_{j-1}), where the end of the corresponding segment e'' on S_j^u (resp. S_j^ℓ) lies between the ends of e and e' .

It follows that $|A'_\sigma| = |A_\sigma^t| + |A_\sigma^w| + |A_\sigma^b| = \frac{c^2}{4} - \frac{c}{2} + \sum_{i=1}^m (k_i^2 + k_i) + \sum_{i=1}^m (q_i - 2)k_i^2$. The set of crossings A'_σ is said to be in *pyramidal position*.

Proof. Statement (i) is a direct application to every set of n -cabled crossings in each twist region of \mathcal{S}^w of the following result from [Lee].

Lemma 3.5. [Lee, Lem. 3.7] Let \mathcal{S} be a skein element in TL_{2n} consisting of a single n -cabled positive crossing x^n with labels as shown in Figure 15.

If $(x^n)_\sigma$ for a Kauffman state σ on x^n has $2k$ through strands, then σ chooses the A -resolution on a set of k^2 crossings C_σ of x^n , where $C_\sigma = \cup_{j=n-k+1}^n (u_j \cup \ell_j)$ is a union of crossings $u_j \subseteq C_j^u$ and $\ell_j \subseteq C_j^\ell$, such that

- For each $n - k + 1 \leq j \leq n$, u_j, ℓ_j each has $j - n + k$ crossings.
- For each $n - k + 2 \leq j \leq n$, and a pair of crossings x, x' in u_j (resp. ℓ_j) whose corresponding segments c, c' in the all- B state of x^n are adjacent (i.e., there is no other edge in C_σ between c and c'), there is a crossing x'' in u_{j-1} (resp. ℓ_{j-1}), where the end of the corresponding segment c'' on S_j^u (resp. S_j^ℓ) lies between the ends of c and c' .

The same proof applies to the crossings in the strip \mathcal{S}^t to show the existence of a set of crossings A_σ^t satisfying (ii), see Figure 16. Reflection with respect to the horizontal axis will show (ii) for \mathcal{S}^b .

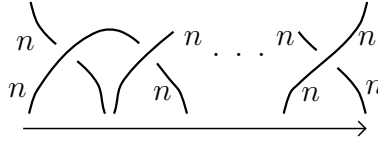

FIGURE 16. The arrow indicates the direction from left to right of the crossings in \mathcal{S}^t .

□

We will now apply what we know about the crossings on which a state σ chooses the A -resolution from Theorem 3.4 to construct degree-maximizing states for given global through strands $c(\sigma)$ and parameters $\{k_i(\sigma)\}$. See Figure 17 for an example of a pyramidal position of crossings.

3.3. Minimal states are taut and their degrees are $\delta(n, k)$. The contribution of the state (k_0, σ) to the state sum is $G_{k_0}(v)v^{\text{sgn}(\sigma)} \langle N(I_{k_0} \oplus (K_+^n)_\sigma) \rangle$ as in (12). We denote its v -degree by $d(k_0, \sigma)$.

Recall the skein element $\mathcal{S}(k_0, \sigma) = N(I_{k_0} \oplus (K_+^n)_\sigma)$. Also recall A_σ denotes the set of crossings on which σ chooses the A -resolution, and $|A_\sigma|$ is the number of crossings in A_σ . A *minimal state* with tight parameters c, k (i.e., $k_0 = k_1 + \cdots + k_m = \frac{c}{2}$) has the least $|A_\sigma|$ in $st(c, k)$. Let $\text{o}(A_\sigma)$ denote the number of circles of $\overline{\mathcal{S}(k_0, \sigma)}$, which is the skein

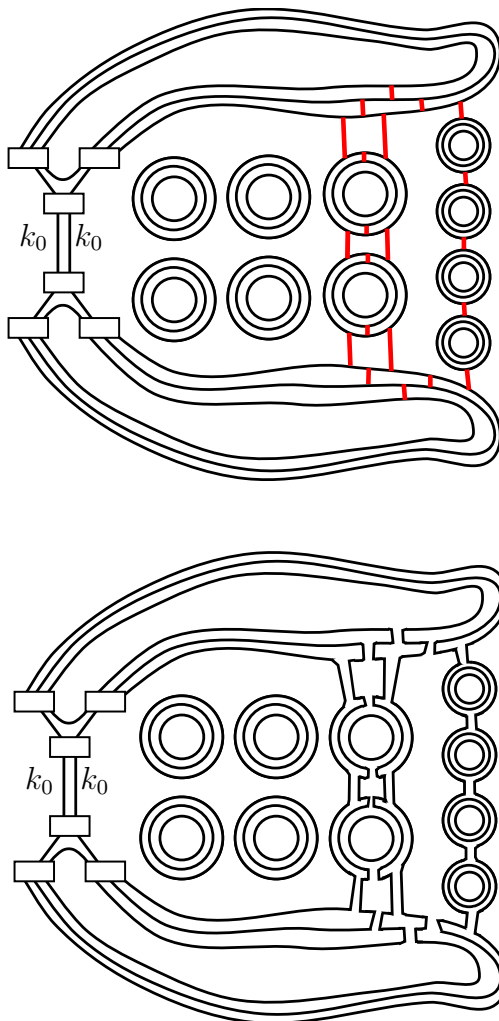

FIGURE 17. A minimal state τ is shown with $n = 3$ and $c(\tau) = 6$ global through strands. In the top picture one can see the pyramidal position of the crossings A_τ as described by Theorem 3.4. The skein element $\mathcal{S}(k_0, \tau)$ with $k = (k_0, 0, 0, 2, 1)$ resulting from applying τ is shown below.

element obtained by replacing all the Jones-Wenzl idempotents in $\mathcal{S}(k_0, \sigma)$ by the identity, respectively.

Lemma 3.6. A minimal state (k_0, τ) with $c(\tau)$ through strands and tight c, k has A_τ in pyramidal position as specified in Theorem 3.4 and distance $|A_\tau|$ from the all- B state given by

$$|A_\tau| = 2 \left(\left(\sum_{i=1}^m k_i \right) \frac{(\sum_{i=1}^m k_i - 1)}{2} + \sum_{i=1}^m \frac{k_i(k_i + 1)}{2} \right) + \sum_{i=1}^m (q_i - 2)k_i^2.$$

Moreover,

$$G_{k_0}(v) v^{\text{sgn}(\sigma)} \langle N(I_{k_0} \oplus (K_+^n)_\sigma) \rangle = (-1)^{q_0(n-k_0)+n+k_0+\sum_{i=1}^m (n-k_i)(q_i-1)} v^{\delta(n,k)} + l.o.t. \quad (14)$$

Proof. Observe that minimal states τ have corresponding crossings A_τ in pyramidal position. Moreover, if A_τ is pyramidal, then $|A_\tau|$ determines the number of circles $o(A_\tau)$. The skein element $\mathcal{S}(k_0, \tau)$ is adequate as long as $k_0 \leq \sum_{i=1}^m k_i$. This means that no circles of $\overline{\mathcal{S}(k_0, \tau)}$ goes through a location where there was an idempotent twice. Thus by [Arm13, Lem. 4], we have

$$\deg_v v^{\text{sgn}(\tau)} \langle \mathcal{S}(k_0, \tau) \rangle = \deg_v v^{\text{sgn}(\tau)} \langle \overline{\mathcal{S}(k_0, \tau)} \rangle,$$

and we simply need to determine the number of circles in $\overline{\mathcal{S}(k_0, \tau)}$ and $\text{sgn}(\tau)$ in order to compute the degree of the Kauffman bracket. This is completely specified by the pyramidal position of A_τ by just applying the Kauffman state. With the assumption that $k_0 = \sum_{i=1}^m k_i = \frac{c}{2}$ since c, k is tight, the degree is then

$$\begin{aligned} d(k_0, \tau) &= \underbrace{\sum_{i=1}^m q_i n^2 - 2 \left(\frac{(\sum_{i=1}^m k_i)((\sum_{i=1}^m k_i) - 1)}{2} + \sum_{i=1}^m \frac{k_i(k_i + 1)}{2} \right) + \sum_{i=1}^m (q_i - 2)k_i^2}_{\text{sgn}(\tau)} \\ &\quad + 2 \underbrace{\left(2n - \left(\sum_{i=1}^m k_i \right) - k_0 + \sum_{i=1}^m (n - k_i)(q_i - 1) \right)}_{2o(A_\tau)} \\ &\quad + \underbrace{q_0 \left(2n - 2k_0 + \frac{2n^2 - 4k_0^2}{2} \right) + 2k_0 - 2n}_{\text{fusion and untwisting}}. \end{aligned}$$

The sign of the leading term is given by

$$(-1)^{\underbrace{q_0(n - k_0) + n + k_0}_{\text{fusion and untwisting}} + \underbrace{o(A_\tau)}_{\text{number of circles}}} = (-1)^{q_0(n - k_0) + n + k_0 + \sum_{i=1}^m (n - k_i)(q_i - 1)}.$$

□

Lemma 3.7. Minimal states are taut. In other words, given c, k tight, we have

$$\max_{\sigma: c(\sigma)=c, k_i(\sigma)=k_i} d(k_0, \sigma) = d(k_0, \tau),$$

where τ is a minimal state with $c(\tau) = c$ and $k_i(\tau) = k_i$.

Proof. Note that for *any* state σ with corresponding skein element $\mathcal{S}(k_0, \sigma)$, we have

$$A_\tau \subseteq A_\sigma$$

for a minimal state τ with the same parameter set (c, k) by Theorem 3.4, and $d(k_0, \tau) = d(k_0, \tau')$ for two minimal states τ, τ' with the same parameters $c(\tau) = c(\tau')$ and $k_i(\tau) = k_i(\tau')$ by Lemma 3.6. This implies $d(k_0, \sigma) \leq d(k_0, \tau)$ by Lemma 2.12. □

3.3.1. Constructing minimal states.

Lemma 3.8. A minimal state exists for any tight c, k , where c is an even integer between 0 and $2n$ and $k_0 = \sum_{i=1}^m k_i = \frac{c}{2}$.

Proof. It is not hard to see that at an n -cabled crossing x^n in a twist region with q_i crossings in \mathcal{S}^w , for any $0 \leq k_i \leq n$ there is always a minimal state giving $2k_i$ through strands. For an n -cabled crossing x^n in \mathcal{S}^t or \mathcal{S}^b , it is also not hard to see that we may take the pyramidal position for the minimal state for the upper half (or bottom half, for \mathcal{S}^b) of each crossing in x^n in C_n^u (or C_n^ℓ) and in $C_{i,j}^{\ell,s}$ (or $C_{i,j}^{u,s}$) for each twist region.

What remains to be shown is that a minimal state *overall* always exists, given the set of parameters $\{k_i\}$ and c total through strands for crossings in the top and bottom strips delimited by $\{S_j^u\}_{j=1}^n$ and $\{S_j^\ell\}_{j=1}^n$. To see this, we take the leftmost position for the crossings x^n in $(\cup_{i=1}^m \cup_{j=1}^n C_{i,j}^{\ell,1}) \cup C_n^u$ with $\{2k_i\}$ through strands, which we already know to exist. Given two crossings x and x' in C_n^u whose corresponding segments in $\mathcal{S}(k_0, B)$ have ends on S_n^u we can always find another crossing x'' in C_{n-1}^u , the end of whose corresponding segment on S_n^u lies between those of x and x' , because the previously chosen crossings in C_n^u are leftmost. Pick the leftmost possible and repeat to choose crossings in C_j^u for $n-k+1 \leq j \leq n-2$. We pick crossings in the bottom strip by reflection. For the remaining n -cabled crossings x^n in \mathcal{S}^w in a twist region corresponding to q_i , any subset of crossings in pyramidal position with $2k_i$ through strands will complete the description of a minimal state satisfying the conditions in the lemma. \square

Lemma 3.9. Let σ be a state with $c = c(\sigma)$ and $k_i = k_i(\sigma)$ which is not tight, that is, $\sum_{i=1}^m k_i > \frac{c}{2}$ or $k_0 < \frac{c}{2}$, then $d(k_0, \sigma) < d(k_0, \tau)$, where τ is a minimal state with $c(\tau) = c$ through strands.

Proof. For the case $\sum_{i=1}^m k_i > \frac{c}{2}$, we can apply Theorem 3.4 to conclude that there is a minimal state τ (there may be multiple such states) such that

$$A_\tau \subset A_\sigma,$$

with $k_i(\tau) \leq k_i(\sigma)$ for each i . There must be some i for which $k_i(\tau) < k_i(\sigma)$. Applying the B -resolution to the additional crossings to obtain a sequence of states from τ to σ , we see that it must contain two consecutive terms that merge a pair of circles.

If $k_0 < \frac{c}{2}$, since $d(k_0, \sigma)$ increases monotonically in k_0 in $G_{k_0}(v)$ from the fusion and untwisting formulas, we can see that $d(k_0, \sigma) < d(c/2, \tau)$. \square

3.4. Enumerating all taut states. By Lemma 3.7, we have shown that every taut state contains a minimal state. Next we show that every taut state is obtained from a unique such minimal state τ by changing the resolution from B -to A -on a set of crossings F_τ . We show that any taut state σ with $c(\sigma) = c(\tau)$ and $k_i(\sigma) = k_i(\tau)$ containing τ as the *leftmost* minimal state, to be defined below, satisfies $A_\sigma = A_\tau \cup p$, where p is any subset of F_τ .

All the circles here in the definitions and theorems are understood with possible extra labels u, ℓ, s, i, j indicating where they are in the regions defining $\mathcal{S}^t, \mathcal{S}^w$, and \mathcal{S}^b . To simplify notation we do not show these extra labels.

Definition 3.10. For each $x \in A_\tau$ between S_{j-1} and S_j , let R_x be the set of crossings to the right of x between S_{j-1} and S_j , but to the left of any $x' \in A_\tau$ between S_{j-2} and S_{j-1} , and any $x'' \in A_\tau$ between S_j and S_{j+1} . We define the following (possibly empty) subset F_τ of crossings of K^n .

$$F_\tau := \cup_{x \in A_\tau} R_x.$$

See Figure 18 and 19 for examples.

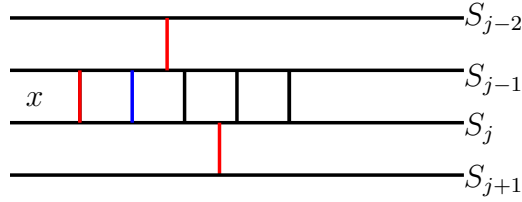

FIGURE 18. Only the blue edge is in R_x because of the presence of the top and bottom red edges.

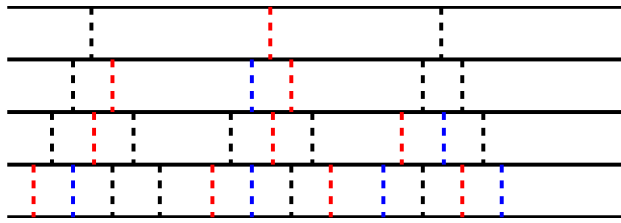

FIGURE 19. An example of F_τ with edges shown in blue with the minimal state τ shown as red edges.

Definition 3.11. Given a set of crossings C of K^n , a crossing $x \in C$, and $1 \leq j \leq n$, define the *distance* $|x|_C$ of a crossing $x \in C$ from the left to be

$$|x|_C := \text{For } x \in C_j, \text{ the } \# \text{ of edges in } \mathcal{S}^G(k_0, B) \text{ to the left of } x \text{ between } S_j \text{ and } S_{j+1}.$$

The *distance* of the set C from the left is defined as

$$\sum_{x \in C} |x|_C.$$

Given any state σ with tight parameters c, k , we extract the *leftmost* minimal state τ_σ where $A_{\tau_\sigma} \subseteq A_\sigma$, i.e., there is no other minimal state τ' such that $A_{\tau'} \subset A_\sigma$, and the distance of $A_{\tau'}$ from the left is less than the distance of A_{τ_σ} from the left.

Lemma 3.12. A Kauffman state σ with tight parameters $c(\sigma), \{k_i(\sigma)\}$ is taut if and only if A_σ may be written as

$$A_\sigma = A_{\tau_\sigma} \cup p$$

where τ_σ is the leftmost minimal state from σ such that $A_{\tau_\sigma} \subseteq A_\sigma$, and p is a subset of F_{τ_σ} . See Figure 20 for an example of a taut state that is not a minimal state, and how it is obtained from the leftmost minimal state that it contains.

Proof. By construction, if a state σ is such that

$$A_\sigma = A_{\tau_\sigma} \cup p$$

where p is a subset of F_{τ_σ} , then σ is a taut state.

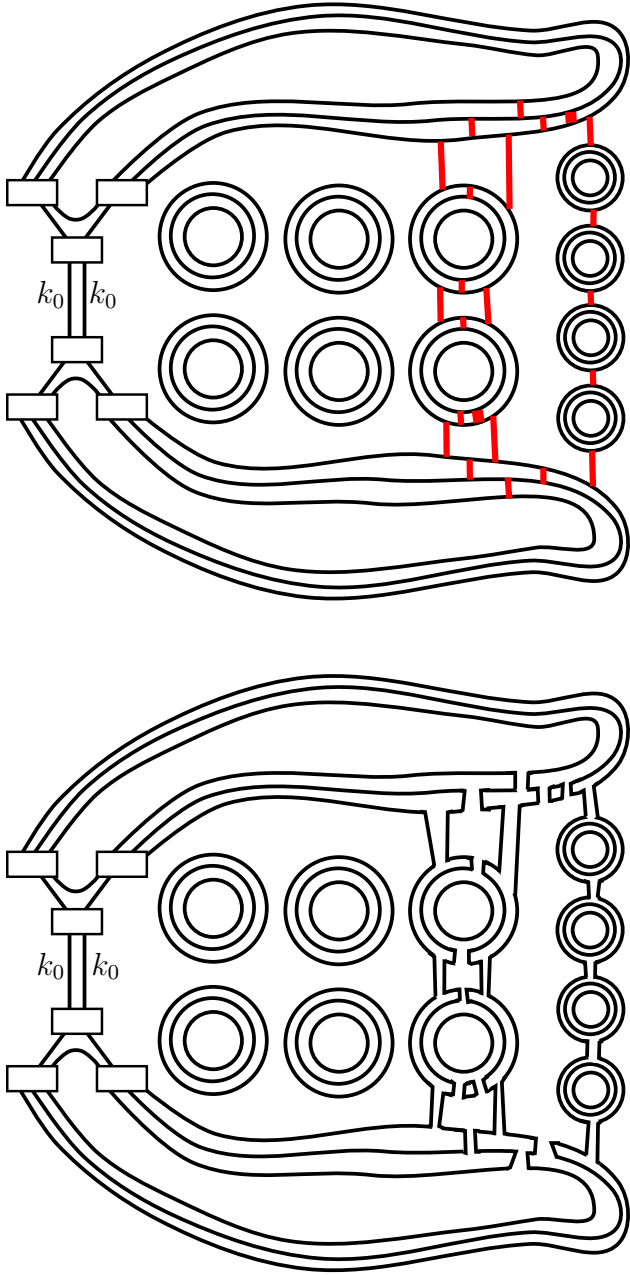

FIGURE 20. On top, a taut state having the same degree as a minimal state but is not equal to it. The bottom picture shows the resulting skein element from applying the state. We have $c = 6$, $k_1 = 0$, $k_2 = 0$, $k_3 = 2$, and $k_4 = 1$ as the minimal state in Figure 17, and the thickened red edges indicate the difference from a minimal state with the same parameters. Choosing the A -resolution at each of the thickened red edges splits off a circle.

Conversely, suppose by way of contradiction that σ is taut, which means that it has the same parameters (c, k) as its leftmost minimal state τ_σ with the same degree, but that there is a crossing $x \in A_\sigma$ and $x \notin F_{\tau_\sigma}$. Then there are two cases:

- (1) x is to the left or to the right of all the edges in A_{τ_σ} .
- (2) $x \in C_j$ is between $x', x'' \in C_j$ in A_{τ_σ} for some j .

In both cases we consider the state σ' where

$$A_{\sigma'} = A_{\tau_\sigma} \cup \{x\},$$

and we assume that taking the A -resolution on x splits off a circle from the skein element $\overline{\mathcal{S}(k_0, \sigma)}$. Otherwise, by Lemma 2.12 applied to a sequence from τ_σ to σ starting with changing the resolution from B to A on x ,

$$\deg_v v^{\text{sgn}(\sigma)} \langle \overline{\mathcal{S}(k_0, \sigma)} \rangle < \deg_v v^{\text{sgn}(\tau_\sigma)} \langle \overline{\mathcal{S}(k_0, \tau_\sigma)} \rangle,$$

a contradiction to σ being taut.

In case (1), the state σ' has parameters (c, k') such that $\sum_{i=1}^m k'_i < \sum_i^m k_i$. If each step of a sequence from σ' to σ splits a circle in order to maintain the degree, then the parameters for σ , and hence the number of global through strands of $\mathcal{S}(k_0, \sigma)$ will differ from $\mathcal{S}(k_0, \tau_\sigma)$, a contradiction.

In case (2), we have that $x \notin F_{\tau_\sigma}$ must be an edge of the following form between a pair of edges x', x'' as indicated in the generic local picture shown in Figure 21, since τ_σ is assumed to be leftmost.

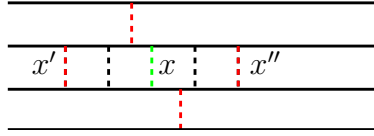

FIGURE 21. The crossing x corresponds to the green edge.

Choosing the A -resolution at x merges a pair of circles in $\overline{\mathcal{S}(k_0, \tau_\sigma)}$ which means that $d(k_0, \sigma) < d(k_0, \tau_\sigma)$, a contradiction. \square

3.5. Adding up all taut states in $st(c, k)$. Note that in general there may be many taut states σ with fixed parameters $(c = c(\sigma), k = k(\sigma))$.

Theorem 3.13. *Let $c, k = \{k_i\}_{i=1}^m$ be tight. The sum*

$$\sum_{\sigma \text{ taut}: c(\sigma)=c, k_i(\sigma)=k_i} v^{\text{sgn}(\sigma)} \langle \mathcal{S}(k_0, \sigma) \rangle = (-1)^{q_0(n-k_0)+n+k_0+\sum_{i=1}^m (n-k_i)(q_i-1)} v^{d(k_0, \tau)} + l.o.t., \quad (15)$$

where τ is a minimal state in the sum.

We are finally ready to prove Theorem 3.13.

Proof. Every minimal state with parameters c, k may be obtained from the leftmost minimal state of the entire set of minimal states \mathcal{M} by transposing to the right. Now we organize the sum (15) by putting it into equivalence classes of states indexed by the leftmost minimal state τ_σ . We may write

$$\sum_{\sigma \text{ taut}: c(\sigma)=c, k_i(\sigma)=k_i} v^{\text{sgn}(\sigma)} \langle \mathcal{S}(k_0, \sigma) \rangle = \sum_{\tau \text{ minimal}} \sum_{\sigma: \tau_\sigma=\tau} v^{\text{sgn}(\sigma)} \langle \mathcal{S}(k_0, \sigma) \rangle.$$

By Lemma 3.12, this implies

$$\sum_{\sigma \text{ taut}: c(\sigma)=c, k_i(\sigma)=k_i} v^{\text{sgn}(\sigma)} \langle \mathcal{S}(k_0, \sigma) \rangle = \sum_{\tau \text{ minimal}} \sum_{j=0}^{|F_\tau|} \binom{|F_\tau|}{j} v^{\text{sgn}(\tau)-2j} (-v^2 - v^{-2})^{o(A_\tau)+j}.$$

If $F_\tau \neq \emptyset$, then by a direct computation,

$$\begin{aligned} \deg_v \left(\sum_{j=0}^{|F_\tau|} \binom{|F_\tau|}{j} v^{\text{sgn}(\tau)-2j} (-v^2 - v^{-2})^{o(A_\tau)+j} \right) &= \text{sgn}(\tau) + 2o(A_\tau) - 4|F_\tau| \\ &< \deg_v (v^{\text{sgn}(\tau)} \langle \mathcal{S}(k, \tau) \rangle) = \delta(n, k) \end{aligned}$$

by Lemma 3.6.

Every taut state can be grouped into a nontrivial canceling sum except for the rightmost minimal state. Thus it remains and determines the degree of the sum. \square

3.6. Proof of Theorem 3.2. Recall that $J_{K,n+1} = \sum_{c,k} \mathcal{G}_{c,k}$ and

$$\mathcal{G}_{c,k} = \sum_{k_0} G_{k_0}(v) \sum_{\sigma: k_i(\sigma)=k_i, c(\sigma)=c} v^{\text{sgn}(\sigma)} \langle N(I_{k_0} \oplus (K_+^n)_\sigma) \rangle$$

By the fusion and untwisting formulas we have

$$G_{k_0}(v) = (-1)^{q_0(n-k_0)} \frac{\Delta_{2k_0}}{\theta(n, n, 2k_0)} v^{q_0(2n-2k_0+n^2-k_0^2)}.$$

We apply the previous lemmas to compute for each c, k the v -degree of the sum

$$\sum_{\sigma: k_i(\sigma)=k_i, c(\sigma)=c} v^{\text{sgn}(\sigma)} \langle N(I_{k_0} \oplus (K_+^n)_\sigma) \rangle.$$

When c, k is tight the top degree part of the sum is $\mathcal{G}_{c,k}^{\text{taut}}$. By Theorem 3.13, we have that the coefficient and the degree of the leading term are given by a minimal state τ with parameters c, k . The degree is computed to be $\delta(n, k)$ in Lemma 3.6, which also determines the leading coefficient.

When σ is a state such that c, k is not tight, and $k_0 \geq c(\sigma)/2$ or $k_0 \geq \sum_{i=1}^m k_i(\sigma)$, Lemma 3.3 says that $\mathcal{S}(k_0, \sigma)$ is zero. Otherwise, Lemma 3.9 says that there exists a taut state corresponding to a tight c', k' that has strictly higher degree. \square

4. QUADRATIC INTEGER PROGRAMMING

In this section we collect some facts regarding real and lattice optimization of quadratic functions.

4.1. Quadratic real optimization. We begin with considering the well-known case of real optimization.

Lemma 4.1. Suppose that A is a positive definite $m \times m$ matrix and $b \in \mathbb{R}^m$. Then, the minimum

$$\min_{x \in \mathbb{R}^m} \frac{1}{2} x^t A x + b \cdot x \quad (16)$$

is uniquely achieved at $x = -A^{-1}b$ and equals $-\frac{1}{2}b^t A b$.

Proof. The function is proper with the only critical point at $x = -A^{-1}b$ which is a local minimum since the Hessian of A is positive definite. \square

For a vector $v \in \mathbb{R}^m$, we let v_i for $i = 1, \dots, m$ denote its i th coordinate, so that $v = (v_1, \dots, v_m)$. When v_i 's are nonzero for all i , we set $v^{-1} = (v_1^{-1}, \dots, v_m^{-1})$.

The next lemma concerns optimization of convex separable functions $f(x)$, that is, functions of the form

$$f(x) = \sum_{i=1}^m f_i(x_i), \quad f_i(x_i) = a_i x_i^2 + b_i x_i \quad (17)$$

where $a_i > 0$ and b_i are real for all i . The terminology follows Onn [Onn10, Sec.3.2].

Lemma 4.2. (a) Fix a separable convex function $f(x)$ as in (17) and a real number $t \in \mathbb{R}$. Then the minimum

$$\min\{f(x) \mid \sum_i x_i = t, x \in \mathbb{R}^m\} \quad (18)$$

is uniquely achieved at $x^*(t)$ where

$$x_i^*(t) = \frac{a_i^{-1}t + \frac{1}{2} \sum_j (b_j - b_i) a_i^{-1} a_j^{-1}}{\sum_j a_j^{-1}}, \quad (19)$$

and

$$f(x^*(t)) = \frac{1}{1 \cdot a^{-1}} t^2 + \frac{b \cdot a^{-1}}{1 \cdot a^{-1}} t + s_0(a, b) \quad (20)$$

where $1 \in \mathbb{Z}^m$ denotes the vector with all coordinates equal to 1, and $s_0(a, b)$ is a rational function in coordinates $a = (a_1, \dots, a_m)$ and $b = (b_1, \dots, b_m)$.

(b) If $t \gg 0$, then the minimum

$$\min\{f(x) \mid \sum_i x_i = t, x \in \mathbb{R}^m, 0 \leq x_i, i = 1, \dots, m\} \quad (21)$$

is uniquely achieved at (19) and given by (20).

Note that the coordinates of the minimizer $x^*(t)$ are linear functions of t for $t \gg 0$; we will call such minimizers linear. It is obvious that the minimal value is then quadratic in t for $t \gg 0$.

Proof. Let $f(x) = \sum_j a_j x_j^2 + b_j x_j$ and $g(x) = \sum_j x_j$ and use Lagrange multipliers.

$$\begin{cases} \nabla f = \lambda \nabla g \\ g = t. \end{cases}$$

So, $2a_j x_j + b_j = \lambda$ for all j , hence $x_j + b_j/(2a_j) = \lambda/(2a_j)$ for all j . Summing up, we get $t + \sum_j b_j/(2a_j) = \lambda \sum_j 1/(2a_j)$. Solving for λ , we get $\lambda = \frac{2t + \sum_j b_j a_j^{-1}}{\sum_j a_j^{-1}}$ and using

$$x_i = \frac{\lambda - b_i}{2a_i} = \frac{2t + \sum_j (b_j - b_i) a_j^{-1}}{2a_i \sum_j a_j^{-1}} = \frac{a_i^{-1} t + \frac{1}{2} \sum_j (b_j - b_i) a_i^{-1} a_j^{-1}}{\sum_j a_j^{-1}},$$

Equation (19) follows. Observe that $x^*(t)$ is an affine linear function of t . It follows that $f(x^*(t))$ is a quadratic function of t . An elementary calculation by plugging in x^* into f gives (20) for an explicit rational function $s_0(a, b)$, which is the portion of $f(x^*(t))$ that does not involve t .

If in addition $t \gg 0$ observe that $x^*(t) = \frac{t}{1-a^{-1}} a^{-1} + O(1)$, therefore $x^*(t)$ is in the simplex $x_i \geq 0$ for all i and $\sum_i x_i = t$. The result follows. \square

4.2. Quadratic lattice optimization. In this section we discuss the lattice optimization problem

$$\min\{f(x) \mid Ax = t, x \in \mathbb{Z}^m, 0 \leq x \leq t\} \quad (22)$$

for a nonnegative integer t , where $A = (1, 1, \dots, 1)$ is a $1 \times m$ matrix and $f(x)$ is a convex separable function (17) with $a, b \in \mathbb{Z}^m$ with $a > 0$. We will follow the terminology and notation from Onn's book [Onn10]. In particular the set $x \in \mathbb{Z}^m$ satisfying the above conditions $Ax = t$ and $0 \leq x_i \leq t$ is called a feasible set. Lemma 3.8 of Onn [Onn10] gives a necessary and sufficient condition for a lattice vector x to be optimal. In the next lemma, suppose that a feasible $x \in \mathbb{Z}^m$ is non-degenerate, that is, $x_i < t$ and $x_j > 0$ for all i, j . Note that this is not a serious restriction since otherwise the problem reduces to a lattice optimization problem of the same shape in one dimension less.

Lemma 4.3. [Onn10] Fix a feasible $x \in \mathbb{Z}^m$ which is non-degenerate. Then it is optimal (i.e., a lattice optimizer for the problem (22)) if and only if it satisfies the certificate

$$2(a_i x_i - a_j x_j) \leq (a_i + a_j) - (b_i - b_j). \quad (23)$$

Proof. Lemma 3.8 of Onn [Onn10] implies that x is optimal if and only if $f(x) \leq f(x + g)$ for all $g \in G(A)$ where $G(A)$ is the Graver basis of A . In our case, the Graver basis is given by the roots of the A_{m-1} lattice, i.e., by

$$G((1, 1, \dots, 1)) = \{e_j - e_i \mid 1 \leq i, j \leq m, i \neq j\}.$$

Let $g = e_j - e_i \in G(A)$ and $f(x)$ as in (17). Then $f(x) \leq f(x + g)$ is equivalent to (23). \square

Below, we will call a vector quasi-linear if its coordinates are linear quasi-polynomials.

Proposition 4.4. (a) Every non-degenerate lattice optimizer $x^*(t)$ of (22) is quasi-linear of the form

$$x_i^*(t) = \frac{a_i^{-1}}{\sum_j a_j^{-1}} t + c_i(t) \quad (24)$$

for some ϖ -periodic functions c_i , where

$$\varpi = \sum_i \prod_{j \neq i} a_j. \quad (25)$$

(b) When $t \gg 0$ is an integer, the minimum value of (22) is a quadratic quasi-polynomial

$$\frac{1}{1 \cdot a^{-1}}t^2 + \frac{b \cdot a^{-1}}{1 \cdot a^{-1}}t + s_0(a, b)(t) \quad (26)$$

where $s_0(a, b)$ is a ϖ -periodic function of t .

(c) For all $t > 0$ the minimum value of (22) is

$$\frac{1}{1 \cdot a^{-1}}t^2 + \frac{b \cdot a^{-1}}{1 \cdot a^{-1}}t + O(1). \quad (27)$$

Part (c) of Proposition 4.4 is what we will apply to the degree of the colored Jones polynomial. Note that in general there are many minimizers of (22). Comparing with (19) it follows that any lattice minimizer of (22) is within $O(1)$ from the real minimizer.

Proof. Let $A_i = \prod_{j \neq i} a_j = a_1 \dots \hat{a}_i \dots a_m$, then $\varpi = A_1 + \dots + A_m$. Suppose x^* satisfies the optimality criterion (23) and $Ax^* = t$ where $A = (1, 1, \dots, 1)$. Let $x^{**} = x^* + (A_1, \dots, A_m)$. Since $a_i A_i - a_j A_j = 0$ for $i \neq j$, it follows that

$$2(a_i x_i^* - a_j x_j^*) = 2(a_i x_i^{**} - a_j x_j^{**}).$$

Hence x^* satisfies the optimality criterion (23) if and only if x^{**} does. Moreover, $Ax^{**} = Ax^* + \varpi = t + \varpi$. Since $a_i^{-1}/(\sum_j a_j^{-1}) = A_i/\varpi$, it follows that every minimizer $x^*(t)$ satisfies the property that $x_i^*(t) - \frac{a_i^{-1}}{\sum_j a_j^{-1}}t$ is a ϖ -periodic function of t . Part (a) follows. For part (b), write $x^*(t) = \frac{t}{1 \cdot a^{-1}}a^{-1} + c(t)$ and use the fact that $Ac(t) = 0$ to deduce that $f(x^*(t))$ is a quadratic quasi-polynomial of t with constant quadratic and linear term given by (2). For part (c), note that by (b) there is a constant $C > 0$ such that we get (27) for all $t > C$ by taking the maximum absolute value of the periodic $s_0(a, b)$. For $0 \leq t \leq C$ both the function f and the quadratic are bounded by a constant so the conclusion still holds. \square

4.3. Application: the degree of the colored Jones polynomial. Recall that our aim is to compute the maximum of the degree function $\delta(k) = \delta(n, k)$ of the states in the state sum of the colored Jones polynomial with tight parameters $k_0 = \sum_{i=1}^m k_i$, see Theorem 3.2. Here $k = (k_0, k_1, \dots, k_m)$ and $q = (q_0, q_1, \dots, q_m)$ are $(m+1)$ -vectors and we make use of the assumption that q_i is odd for all $0 \leq i \leq m$. We will compute the maximum in two steps.

Step 1: We will apply Proposition 4.4 to the function $\delta(k)$ (divided by -2 , and ignoring the terms that depend on n and $q = (q_0, \dots, q_m)$ but not on k):

$$-\frac{1}{2}\delta(k) = \sum_{i=1}^m (q_i - 1)k_i^2 + (q_0 + 1) \left(\sum_{i=1}^m k_i \right)^2 + \sum_{i=1}^m k_i(-2 + q_0 + q_i) \quad (28)$$

under the usual assumptions that $q_0 < 0$, $q_i > 0$ for $i = 1, \dots, m$. We assume that $k = (k_1, \dots, k_m) \in \mathbb{Z}^m$. Restricting $\delta(k)$ to the simplex $k_i \geq 0$ and $t = k_1 + \dots + k_m$, we apply Proposition 4.4 (c). It follows that for $t > 0$,

$$\min_{\substack{k_i \geq 0 \\ \sum_i k_i \leq n}} \delta(k) = \min_{0 \leq t \leq n} Q_0(t) + O(1),$$

where

$$Q_0(t) = s(q)t^2 + s_1(q)t, \quad (29)$$

and $s(q)$, $s_1(q)$ are given by (2).

Step 2: Next it follows that $Q_0(t)$ is positive definite, degenerate, or negative definite if and only if $s(q) > 0$, $s(q) = 0$, or $s(q) < 0$, respectively.

Case 1: $s(q) < 0$. Then $Q_0(t)$ is negative definite and the minimum is achieved at the boundary $t = n$. It follows that

$$\min_{\substack{k_i \geq 0 \\ \sum_i k_i \leq n}} \delta(k) = s(q)n^2 + s_1(q)n + O(1).$$

Case 2a: $s(q) = 0$, $s_1(q) \neq 0$. Then $Q_0(t)$ is a linear function of t and the minimum is achieved at $t = 0$ or $t = n$ depending on whether $s_1(q) > 0$ or $s_1(q) < 0$, so we have

$$\min_{\substack{k_i \geq 0 \\ \sum_i k_i \leq n}} \delta(k) = \begin{cases} O(1) & \text{if } s_1(q) > 0 \\ s_1(q)n + O(1) & \text{if } s_1(q) < 0. \end{cases}$$

Case 2b: $s(q) = 0 = s_1(q)$. Now $t = 0$ and $t = n$ both contribute equally so cancellation may occur. It does not because the sign of the leading term is constant due to the parities of the q_i 's.

Case 3: $s(q) > 0$. Then $Q_0(t)$ is positive definite and Proposition 4.4 implies that the lattice minimizers are near $-s_1(q)/(2s(q))$ or at 0, when $s_1(q) < 0$ or $s_1(q) \geq 0$ and the minimum value is given by:

$$\min_{\substack{k_i \geq 0 \\ \sum_i k_i \leq n}} \delta(k) = \begin{cases} -\frac{s_1(q)^2}{4s(q)} + O(1) & \text{if } s_1(q) < 0 \\ O(1) & \text{if } s_1(q) \geq 0. \end{cases}$$

Note that cancellation of multiple lattice minimizers is ruled out because the signs of the leading terms are always the same due to the assumption on the parities of the q_i 's. Note also that the uncomputed $O(1)$ term above does not affect the proof of Theorem 1.2.

Remark 4.5. It may be of interest to note that there are very few pretzel knots with $s(q) \geq 0$ and $s_1(q) = 0$. These are cases 2b and 3 above where cancellations might occur if we had no control on the sign of the leading coefficients. The case $P(-3, 5, 5)$ is mentioned in [LvdV] for its colored Jones polynomial with growing leading coefficient.

Lemma 4.6. (Exceptional Pretzel knots)

The only pretzel knots with $q_0 \leq -2 < 3 \leq q_1, \dots, q_m$ for which $s(q) \geq 0$ and $s_1(q) = 0$ are

- (1) $P(-3, 5, 5)$, $P(-3, 4, 7)$, $P(-2, 3, 5, 5)$, with $s(q) = 0$.
- (2) $P(-2, 3, 7)$, with $s(q) = \frac{1}{2}$.

Proof. Changing variables to $f_i = q_i - 1$ turns the two equations $s(q) \geq 0$ and $s_1(q) = 0$ into: $f_0(f_1^{-1} + \dots + f_m^{-1}) + m = 0$ and $2 + f_0 + \frac{1}{f_1^{-1} + \dots + f_m^{-1}} = c$ for some $c \geq 0$. Solving for f_0 yields $f_0 = (c - 2)\frac{m}{m-1}$. Since $f_0 \leq -3$ we must have $0 \leq c \leq 2 - 3\frac{m-1}{m}$. This means there can only be such c when $m = 2$ or 3 . Suppose $m = 2$ then $c = 0$ or $c = \frac{1}{2}$. In the first case we find $f_2 = \frac{2f_1}{f_1-2}$ so the positive integer solutions are $(f_1, f_2) \in \{(3, 6), (4, 4), (6, 3)\}$. In the case $c = \frac{1}{2}$ we find $f_2 = \frac{3f_1}{2f_1-3}$ so $(f_1, f_2) \in \{(2, 6), (3, 3), (6, 2)\}$. Finally the case $m = 3, c = 0, f_0 = -3$ yields $(f_1, f_2, f_3) \in \{(2, 4, 4), (2, 3, 6), (3, 3, 3)\}$ and permutations. \square

5. THE COLORED JONES POLYNOMIAL OF MONTESINOS KNOTS

In this section we will extend Theorem 3.2 to the class of Montesinos knots. For a Montesinos knot $K = K(r_0, r_1, \dots, r_m)$, we will always consider the *standard diagram*, also denoted by K , coming from the unique continued fraction expansion of even length of each rational number as in the case of pretzel knots. Recall that our restriction to Montesinos links with precisely one negative tangle and the existence of reduced diagrams for Montesinos links means that we can assume $r_i[0] = 0$ for all $0 \leq i \leq m$, see Section 2.2. To build the diagram from simpler diagrams we introduce the tangle replacement move (in short, TR-move), and study its effect on the state-sum formula for the colored Jones polynomial.

5.1. **The TR-move.** A TR-move is a local modification of a link diagram D . Suppose D contains a twist region T . Viewing T as a rational tangle $T = \frac{1}{t}$ for some integer t we may consider a new diagram D_1 obtained by replacing T by the rational tangle $T_1 = r * \frac{1}{t}$ for some non-zero integer r with the same sign as t . Alternatively, viewing T as an integer tangle t we replace it with $T_2 = \frac{1}{r} \oplus t$, also with r having the same sign. Collectively these two operations are referred to as the TR-moves. Recall from Section 2.1, Equations (6), (7) that we can construct a diagram of any rational tangle by a combination of TR-moves, see also Figures 22 and 23. We extend this to n -cabled tangle diagrams by labeling each arc in the diagram by n .

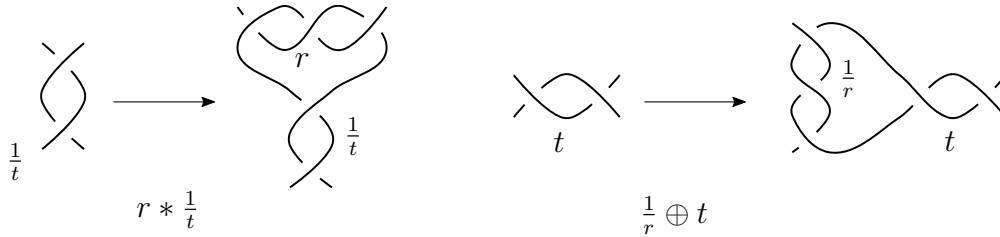

FIGURE 22. Two types of TR-moves.

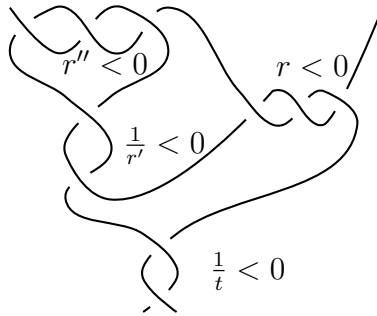

FIGURE 23. Any rational tangle is produced by a combination of TR-moves. In the picture shown, we have performed three TR-moves: first on $1/t$, then r , then $1/r'$.

We will use the TR-moves to reduce a Montesinos knot to the associated pretzel knot by first reducing it to a special Montesinos knot.

5.2. Special Montesinos knot case. We start by considering the case of Montesinos links $K(r_0, \dots, r_m)$ where $\ell_{r_i} = 2$ for all $0 \leq i \leq m$. This includes the pretzel links by choosing the unique even length continued fraction expansion with $r_0[2] = -1$ and $r_i[2] = 1$ for each $1 \leq i \leq m$. We call these links *special Montesinos links*. We prove the main theorem, Theorem 5.1, for special Montesinos links.

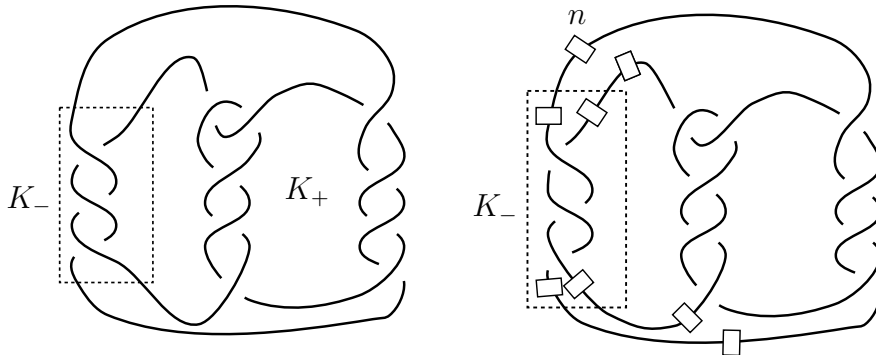

FIGURE 24. A special Montesinos knot $K = K(-\frac{1}{3} = \frac{1}{-2+\frac{1}{-1}}, \frac{2}{7} = \frac{1}{3+\frac{1}{2}}, \frac{1}{4} = \frac{1}{3+\frac{1}{1}}) = N(K_- \oplus K_+)$, and $K^n = N(K_-^n \oplus K_+^n)$.

As in the case of pretzel links we use a customized state sum to compute the colored Jones polynomial, splitting $K = N(K_- \oplus K_+)$. In this case K_- is the single vertical 2-tangle $1/(r_0[1] - 1)$ and K_+ is the 2-tangle that is the rest of the diagram. As before we apply the fusion and untwisting formulas (9), (10) to K_-^n and the Kauffman state sum to K_+^n after cabling with the n th Jones-Wenzl idempotent for the n th colored Jones polynomial. See Figure 24.

The methods used previously on the pretzel links also apply to this case with minor modifications. In particular the notion of global through strands $c(\sigma)$ for a Kauffman state σ on K_+^n still makes sense and $k_i(\sigma)$ is still well-defined by restricting σ to the i th tangle. In this case $c_i(\sigma)$ means the number of through strands of the i th tangle of K_+^n that are also global through strands, and as before $k_i = \lceil \frac{c_i}{2} \rceil$. Let

$$\mathcal{G}_{c,k} = \sum_{k_0} \sum_{\sigma: k_i(\sigma) = k_i, c(\sigma) = c} G_{k_0}(v) v^{\text{sgn}(\sigma)} \langle N(I_{k_0} \oplus (K_+^n)_\sigma) \rangle,$$

where as in the case of pretzel links, I_{k_0} is the skein element in TL_{2n} in the sum obtained by applying the fusion and untwisting formulas to K_-^n , and $G_{k_0}(v)$ are the coefficients in rational functions of v .

We have

$$\langle K^n \rangle = \sum_{(k_0, \sigma)} G_{k_0}(v) v^{\text{sgn}(\sigma)} \langle N(I_{k_0} \oplus (K_+^n)_\sigma) \rangle = \sum_{c,k} \mathcal{G}_{c,k}.$$

We prove the following theorem.

Theorem 5.1. Consider $K = K(\frac{1}{r_0[1]+\frac{1}{-1}}, \frac{1}{r_1[1]+\frac{1}{r_1[2]}}, \dots, \frac{1}{r_m[1]+\frac{1}{r_m[2]}})$. Assume $|r_i[1]| > 1$, $|r_i[2]| > 0$, $r_0[1] < 0 < r_i[1]$, and define $q_0 = r_0[1] - 1$, $q_i = r_i[1] + 1$ for $1 \leq i \leq m$, $q'_i = r_i[2]$

for $1 \leq i \leq m$. Referring to the state sum $\langle K^n \rangle = \sum_{c,k} \mathcal{G}_{c,k}$ we have the following: For a Kauffman state σ , define the parameters $c = c(\sigma), k = k(\sigma)$ to be tight if $k_0 = k_1 + \dots + k_m = \frac{c}{2}$. For tight c, k we have $\mathcal{G}_{c,k} = (-1)^{q_0(n-k_0)+n+k_0+\sum_{i=1}^m(n-k_i)(q_i-1)} v^{\delta(n,k)} + l.o.t.$ ² and $\frac{-\delta(n,k)}{2} =$

$$(q_0+1)k_0^2 + \sum_{i=1}^m (q_i-1)k_i^2 + \sum_{i=1}^m (-2+q_0+q_i)k_i - \frac{n(n+2)}{2} \sum_{i=0}^m q_i + (m-1)n - \frac{n^2}{2} \sum_{i=1}^m (q'_i-1). \quad (30)$$

If c, k are not tight then there exists a tight pair c', k' (coming from some Kauffman state) such that $\deg_v \mathcal{G}_{c,k} < \deg_v \mathcal{G}_{c',k'}$.

Proof. The proof is analogous to that of Theorem 3.2 for pretzel links. As in the pretzel case we identify the minimal states and show that they maximize the degree and do not cancel out. Since these arguments are exactly the same we focus on describing the minimal states, one for each set of tight parameters of through strands c, k . The minimal states are produced by choosing a minimal state τ_P for the pretzel link $P = P(q_0, \dots, q_m)$ and extending it to a minimal Kauffman state τ of $\langle K_+^n \rangle$. The set A_τ on which τ chooses the A -resolution is a union of the restriction of A_{τ_P} on the twist region $(1/r_i[1])^n$ and a set of k_i^2 crossings in pyramidal position with k_i through strands in $(r_i[2])^n$, $1 \leq i \leq m$. This set exists whenever $|r_i[2]| > 0$. We have

$$d(k, \tau) = d(k, \tau_P) + n^2 \sum_{i=1}^m (q'_i - 1),$$

to account for the additional crossings from $r_i[2]$ for $1 \leq i \leq m$ on which τ chooses the B -resolution. This gives $\delta(n, k)$ in the theorem.

²The abbreviation *l.o.t.* means lower order terms in v .

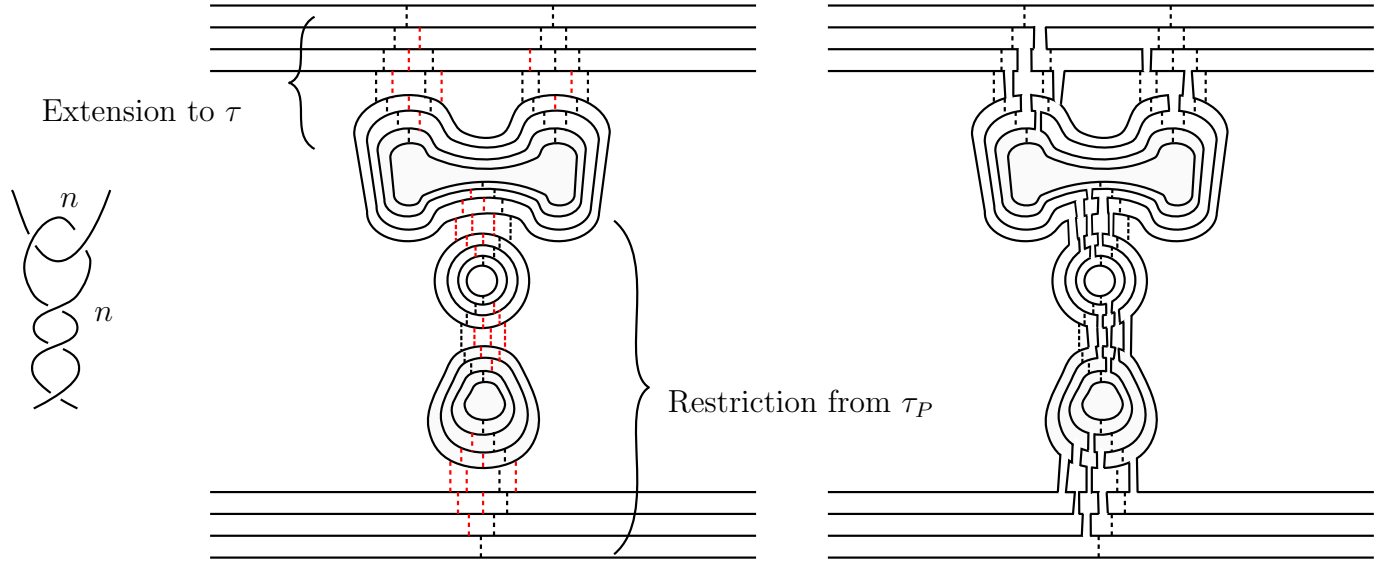

FIGURE 25. An example with $n = 4$ showing a minimal state with 3 through strands through a rational tangle r where $\ell_r = 2$ and $r[2] > 1$. One can see the extension of the minimal state on the vertical twist region $1/r[1]$. We choose $3^2 = 9$ crossings in pyramidal position in the twist region $(r[2])^n$.

□

5.3. The general case. Given $K = K(r_0, r_1, \dots, r_m)$, we decompose the standard diagram $K = N(K_- \oplus K_+)$, where K_- is the single negative tangle, and K_+ is the rest of the diagram. We further decompose $K_- = D_- \cup V_-$ where D_- consists of the negative twist region $1/r_0[1]$ if $r_0[2] \neq -1$, or $1/(r_0[1] - 1)$ if $r_0[2] = -1$ and $\ell_{r_0} = 2$, while V_- is the rest of K_- . Note D_- and V_- are joined as they are in the diagram K . For the 2-tangle diagram corresponding to r_i in K , where $i \leq 1 \leq m$, let the tangle diagram T_i be the portion corresponding to the first two (with respect to the continued fraction expansion) twist regions $1/r_i[1]$ and $r_i[2]$. If $\ell_{r_i} = 2$, then $T_i = r_i[2] * \frac{1}{r_i[1]}$. Otherwise if $\ell_{r_i} > 2$, then T_i is a $(4, 2)$ -tangle diagram obtained by joining the upper right strand of $\frac{1}{r_i[1]}$ to the lower right strand of $r_i[2]$. We decompose K_+ as $K_+ = D_+ \cup V_+$, where $D_+ = \cup_{i=1}^m T_i$ is the portion of the standard diagram K obtained by arranging T_i side by side in a row in order, and joining each pair T_i, T_{i+1} for $1 \leq i \leq m - 1$ according to the rules as follows:

- If $\ell_{r_i} = \ell_{r_{i+1}} = 2$, then T_i and T_{i+1} are both 2-tangles. The lower right strand of T_i is joined to lower left strand of T_{i+1} , and the upper right strand of T_i is joined to the upper left strand of T_{i+1} .
- If $\ell_{r_i} = 2$ and $\ell_{r_{i+1}} > 2$, or $\ell_{r_i} > 2$ and $\ell_{r_{i+1}} > 2$, only the lower right strand of T_i is joined to the lower left strand of T_{i+1} .
- If $\ell_{r_i} > 2$ and $\ell_{r_{i+1}} = 2$, then the upper right strand of T_i is joined to the upper left strand of T_{i+1} , and the lower right strand of T_i is joined to the lower left strand of T_{i+1} .

Define V_+ to be the rest of K_+ . See Figure 26 for examples of T_i 's and Figure 27 for an illustration of the decomposition of a Montesinos knot K . The union defined extends to the n -cable of the tangle diagrams by decorating each strand with n , so $(D_+ \cup V_+)^n = D_+^n \cup V_+^n$ and $(D_- \cup V_-)^n = D_-^n \cup V_-^n$.

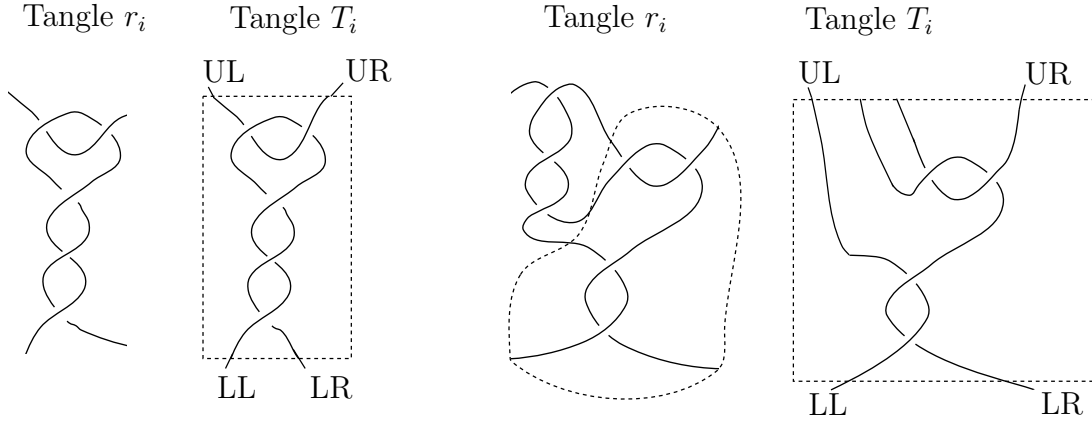

FIGURE 26. Two cases of the T_i 's corresponding to the r_i 's are shown. UL stands for upper left; UR stands for upper right; LL stands for lower left; LR stands for lower right.

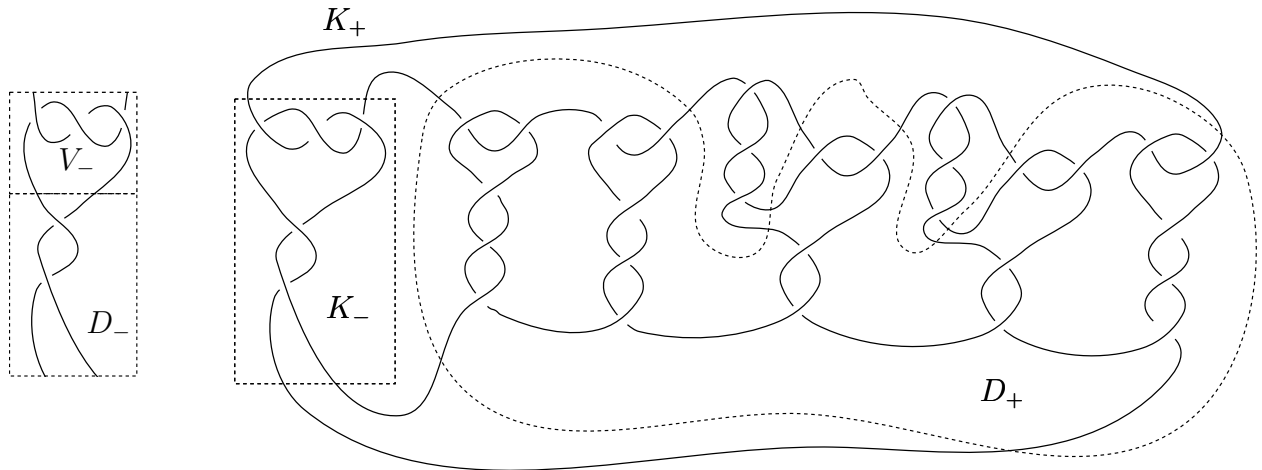

FIGURE 27. We show the decomposition $K = N(K_- \oplus K_+)$ of a Montesinos knot $K = K(-\frac{3}{7} = \frac{1}{-2+\frac{1}{-3}}, \frac{2}{7} = \frac{1}{3+\frac{1}{2}}, \frac{2}{7} = \frac{1}{3+\frac{1}{2}}, \frac{7}{17} = \frac{1}{2+\frac{1}{2+\frac{1}{\frac{1}{17}}}}, \frac{7}{17} = \frac{1}{2+\frac{1}{2+\frac{1}{\frac{1}{17}}}}, \frac{2}{7} = \frac{1}{3+\frac{1}{2}})$. In the figure, $K_- = D_- \cup V_-$ (decomposed on the left) is the 2-tangle enclosed in the dashed rectangular box on K . On the right, D_+ is the tangle enclosed in the dashed curve on K_+ , and V_+ is the rest of the diagram K_+ .

Let

$$q_0 = \begin{cases} r_0[1] + \frac{1}{-1} & \text{if } \ell_{r_0} = 2 \text{ and } r_0[2] = -1. \\ r_0[1] & \text{otherwise} \end{cases}.$$

The link $L = K(\frac{1}{q_0}, \frac{1}{r_1[1] + \frac{1}{r_1[2]}}, \dots, \frac{1}{r_m[1] + \frac{1}{r_m[2]}})$ is a special Montesinos link. We approach the general case as insertion of the union of rational tangles $V = V_- \cup V_+$ into this special Montesinos link via TR-moves. The essential feature of V is that its all- B state acts like the identity on $\langle L \rangle$ plus some closed loops, see Figure 28.

Lemma 5.2. Suppose we have the standard diagram of a Montesinos knot $K = K(r_0, r_1, \dots, r_m) = N(K_- \oplus K_+) = N((D_- \cup V_-) \oplus (D_+ \cup V_+))$, where $L = K(\frac{1}{q_0}, \frac{1}{r_1[1] + \frac{1}{r_1[2]}}, \dots, \frac{1}{r_m[1] + \frac{1}{r_m[2]}})$ is a special Montesinos knot. Let $V = V_- \cup V_+$, joined as they are in the diagram K . If $q_0 < -1$ is odd, and $q_i = r_i[1] + 1 > 1$ is odd for every $i > 0$, then we have

$$\deg_v \langle K^n \rangle = \deg_v \langle L^n \rangle + c(V)n^2 + 2n o(V_B),$$

where $c(V)$ is the number of crossings in V and $o(V_B)$ is the number of disjoint circles resulting from applying the all- B state to V .

Proof. Decompose the n -cable of the standard diagram $L^n = N(L_-^n \oplus L_+^n)$ as in Figure 24. Applying quadratic integer programming to the formula of Theorem 5.1 for the degree-maximizing states of $\langle L^n \rangle$, discarding any terms that depend only on q_i , q'_i and n and not on k_i , we see that there are minimal states of the state sum of any special Montesinos knot that attain the maximal degree. Fix one such minimal state τ .

We decompose $K^n = N(K_-^n \oplus K_+^n) = N((D_-^n \cup V_-^n) \oplus (D_+^n \cup V_+^n))$ and write down a state sum for $\langle K^n \rangle$ by applying the fusion and untwisting formulas to the n -cable of the single negative twist region in D_-^n and applying Kauffman states on the set of crossings in the rest of the diagram K^n . Let $\sigma \cup \sigma'$ denote a Kauffman state on K^n where σ is a Kauffman state on D_+^n and σ' is a Kauffman state on $V^n = (V_-^n \cup V_+^n)$. We have

$$\langle K^n \rangle = \sum_{(k_0, \sigma \cup \sigma')} G_{k_0}(v) v^{\text{sgn}(\sigma \cup \sigma')} \langle N((I_{k_0} \cup (V_-^n)_{\sigma'}) \oplus ((D_+^n)_{\sigma} \cup (V_+^n)_{\sigma'})) \rangle.$$

Because $V = V_- \cup V_+$ is a (possibly disjoint) union of alternating tangles, applying the all- B state on V^n results in a set $O(V_B^n)$ of $n o(V_B)$ disjoint circles, and

$$N((I_{k_0} \cup (V_-^n)_B) \oplus ((D_+^n)_{\sigma} \cup (V_+^n)_B)) = N(I_{k_0} \oplus (L_+^n)_{\sigma}) \sqcup O(V_B^n)$$

by visual inspection of the diagrams involved. Letting B_V denote the all- B state on V^n , we get

$$\begin{aligned}
\langle K^n \rangle &= \sum_{(k_0, \sigma \cup \sigma'), \sigma' \neq B_V} G_{k_0}(v) v^{\text{sgn}(\sigma \cup \sigma')} \langle N((I_{k_0} \cup (V_-^n)_{\sigma'}) \oplus ((D_+^n)_{\sigma} \cup (V_+^n)_{\sigma'})) \rangle \\
&+ \sum_{(k_0, \sigma \cup B_V)} G_{k_0}(v) v^{\text{sgn}(\sigma \cup B_V)} \langle N((I_{k_0} \cup (V_-^n)_{B_V}) \oplus ((D_+^n)_{\sigma} \cup (V_+^n)_{B_V})) \rangle \\
&= \sum_{(k_0, \sigma \cup \sigma'), \sigma' \neq B_V} G_{k_0}(v) v^{\text{sgn}(\sigma \cup \sigma')} \langle N((I_{k_0} \cup (V_-^n)_{\sigma'}) \oplus ((D_+^n)_{\sigma} \cup (V_+^n)_{\sigma'})) \rangle \\
&+ \sum_{(k_0, \sigma \cup B_V)} G_{k_0}(v) v^{\text{sgn}(\sigma \cup B_V)} \langle N(I_{k_0} \oplus (L_+^n)_{\sigma} \sqcup O(V_B^n)) \rangle \\
&= \sum_{(k_0, \sigma \cup \sigma'), \sigma' \neq B_V} G_{k_0}(v) v^{\text{sgn}(\sigma \cup \sigma')} \langle N((I_{k_0} \cup (V_-^n)_{\sigma'}) \oplus ((D_+^n)_{\sigma} \cup (V_+^n)_{\sigma'})) \rangle \\
&+ \langle L^n \sqcup O(V_B^n) \rangle.
\end{aligned}$$

Let

$$d(k_0, \sigma \cup \sigma') = \deg_v \left(G_{k_0}(v) v^{\text{sgn}(\sigma \cup \sigma')} \langle N((I_{k_0} \cup (V_-^n)_{\sigma'}) \oplus ((D_+^n)_{\sigma} \cup (V_+^n)_{\sigma'})) \rangle \right).$$

The diagram V being a union of alternating tangles also implies that a state on V^n that is not the all- B state merges a circle from $O(V_B^n)$. Therefore, by an application of Lemma 2.12,

$$d(k_0, \sigma \cup B_V) > d(k_0, \sigma \cup \sigma'),$$

for any $\sigma' \neq B_V$.

Thus for a pair (k_0, τ) where $d(k_0, \tau)$ maximizes the degree in the state sum of $\langle L^n \rangle$, the term

$$G_{k_0}(v) v^{\text{sgn}(\tau \cup B_V)} N(I_{k_0} \oplus (L_+^n)_{\tau} \sqcup O(V_B^n))$$

also maximizes the degree in the state sum for $\langle K^n \rangle$. The leading terms all have the same sign because of the assumption on the parities of the q_i 's and Theorem 5.1. Thus there is no cancellation of these maximal terms, and we can determine $\deg_v \langle K^n \rangle$ relative to $\deg_v \langle L^n \rangle$ by counting the number of disjoint circles in $O(V_B)$, giving the formula in the lemma. \square

It is useful to reformulate Lemma 5.2 in a more relative sense, pinpointing how the degree changes as a result of applying a TR-move. Let TR_1^- denote the TR-move that sends $\frac{1}{t}$ to $r * \frac{1}{t}$. We define two composite moves $\text{TR}_2^-(T) = (\frac{1}{r_1} \oplus r_2) * T$, and $\text{TR}^+(T) = (r_1 * \frac{1}{r_2}) \oplus T$.

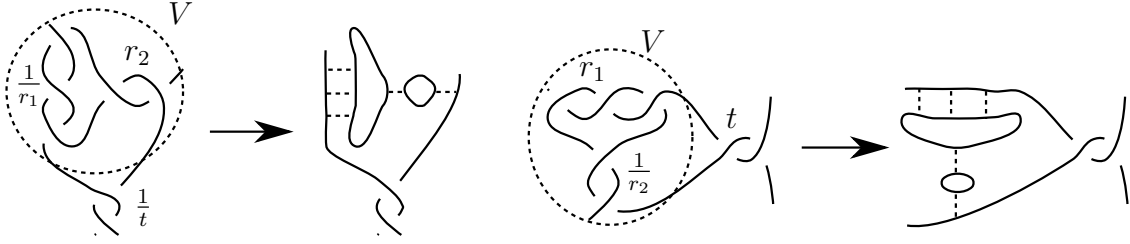

FIGURE 28. Examples of applying the all-B state to V and the resulting disjoint circles for moves sending tangles $\frac{1}{t}$ to $(\frac{1}{r_1} \oplus r_2) * \frac{1}{t}$ and sending t to $(r_1 * \frac{1}{r_2}) \oplus t$. The tangles that form part of V are encircled.

Lemma 5.3. Suppose two standard diagrams K, L of Montesinos knots satisfy the conditions of Lemma 5.2, where K is obtained from L by applying one of the moves $\text{TR}_1^-, \text{TR}_2^-, \text{TR}^+$, locally replacing tangle $(T)^n$ by $(T')^n$, then the degree of the colored Jones polynomial changes as follows. See Figure 28 for examples of the moves $\text{TR}_2^-, \text{TR}^+$.

TR_1^- -move: Suppose $r, t < 0$, and $T = \frac{1}{t}$ is a vertical twist region, and $T' = r * \frac{1}{t}$, then

$$\deg\langle K^n \rangle = \deg\langle L^n \rangle - rn^2 + 2(-r - 1)n.$$

TR_2^- -move: Suppose $r_1, r_2, t < 0$, $T = \frac{1}{t}$ is a vertical twist region, and $T' = (\frac{1}{r_1} \oplus r_2) * \frac{1}{t}$, then

$$\deg\langle K^n \rangle = \deg\langle L^n \rangle - (r_1 + r_2)n^2 - 2r_2n.$$

TR^+ -move: Suppose $r_1, r_2, t > 0$, $T = t$ is a horizontal twist region, and $T' = (r_1 * \frac{1}{r_2}) \oplus t$, then

$$\deg\langle K^n \rangle = \deg\langle L^n \rangle + (r_1 + r_2)n^2 + 2r_2n.$$

Proof. Applying Lemma 5.2 we count the number of crossings and the number of state circles from applying the all-B state to the newly added tangle V in each of these cases, and determine the resulting degree. \square

We use Lemma 5.3 to prove the part of Theorem 1.3 concerning the degree of the colored Jones polynomial for the Montesinos knots that we consider.

Theorem 5.4. With the same definitions for q_i 's for $0 \leq i \leq m$ as in Lemma 5.2, let $K = K(r_0, r_1, \dots, r_m)$ be a Montesinos knot such that $r_0 < 0$, $r_i > 0$ for all $1 \leq i \leq m$, and $|r_i| < 1$ for all $0 \leq i \leq m$ with $m \geq 2$ even. Suppose $q_0 < -1 < 1 < q_1, \dots, q_m$ are all odd, and q'_0 is an integer that is defined to be 0 if $r_0 = 1/q_0$, and defined to be $r_0[2]$ otherwise. Let $P = P(q_0, \dots, q_m)$ be the associated pretzel knot, and let $\omega(D_K), \omega(D_P)$ denote the writhe of standard diagrams D_K, D_P with orientations. For all $n > N_K$ we have:

$$\text{js}_K(n) = \text{js}_P(n) - q'_0 - [r_0] - \omega(D_P) + \omega(D_K) + \sum_{i=1}^m (r_i[2] - 1) + \sum_{i=1}^m [r_i],$$

$$\text{jx}_K(n) = \text{jx}_P(n) - 2\frac{q'_0}{r_0[2]} + 2[r_0]_o - 2\sum_{i=1}^m (r_i[2] - 1) - 2\sum_{i=1}^m [r_i]_e.$$

Proof. Suppose $K = K(r_0, r_1, \dots, r_m) = N(K_- \oplus K_+)$ is a Montesinos knot, then K is obtained from a special Montesinos knot $L = K(\frac{1}{q_0}, \frac{1}{r_1[1] + \frac{1}{r_1[2]}}, \dots, \frac{1}{r_m[1] + \frac{1}{r_m[2]}}) = N(L_- \oplus L_+)$ by a combination of TR-moves on the tangles in L following the unique even length positive continued fraction expansions of r_i for $0 \leq i \leq m$. Recall each rational tangle diagram corresponding to r_i has an algebraic expression of the form

$$\left((r_i[\ell_{r_i}] * \frac{1}{r_i[\ell_{r_i} - 1]}) \oplus r_i[\ell_{r_i} - 2] * \dots * \frac{1}{r_i[1]} \right).$$

The diagram K_+ is obtained by applying successive TR^+ -moves to $r_i[j]$ in L_+ , $1 \leq i \leq m$, sending $r_i[j]$ to $(r_i[j + 2] * \frac{1}{r_i[j + 1]}) \oplus r_i[j]$ for each even $2 \leq j \leq \ell_{r_i}$ starting with $j = 2$. Similarly, the rational tangle K_- is obtained from L_- by applying the TR_2^- -moves to $\frac{1}{r_0[j]}$, sending $\frac{1}{r_0[j]}$ to $(\frac{1}{r_0[j+2]} \oplus r_0[j + 1]) * \frac{1}{r_0[j]}$, for each odd $1 \leq j < \ell_{r_0}$ starting with $j = 1$, with a final TR_1^- -move sending $\frac{1}{r_0[\ell_{r_0-1}]}$ to $(r_0[\ell_{r_0}] * \frac{1}{r_0[\ell_{r_0-1}]})$.

Recall

$$[r]_e = \sum_{3 \leq j \leq \ell_r, j=\text{even}} r[j], \quad [r]_o = \sum_{3 \leq j \leq \ell_r, j=\text{odd}} r[j], \quad [r] = [r]_e + [r]_o.$$

We have two cases for the degree of $\langle K^n \rangle$ relative to $\langle L^n \rangle$, where K^n is obtained from applying the combination of TR-moves to L^n as described above:

- (1) $r_0 = 1/q_0$. By Lemma 5.3, each application of the TR^+ -move adds $(r_i[j + 2] + r_i[j + 1])n^2 + 2r_i[j + 1]n$ to the degree for each even $2 \leq j \leq \ell_{r_i}$ where $1 \leq i \leq m$. We have

$$\begin{aligned} & \deg_v \langle K^n \rangle \\ &= \deg_v \langle L^n \rangle + \sum_{i=1}^m \sum_{j \text{ even}, 2 \leq j \leq \ell_{r_i}} (r_i[j + 2] + r_i[j + 1])n^2 + 2r_i[j + 1]n \\ &= \deg_v \langle L^n \rangle + n^2 \sum_{i=1}^m [r_i] + 2n \sum_{i=1}^m [r_i]_o. \end{aligned}$$

Applying quadratic integer programming to (30) for $\deg_v \langle L^n \rangle$ and ignoring the part of the degree function that only depends on n, q_i , and q_i' 's, we see that as long as the q_i 's for $0 \leq i \leq m$ satisfy the hypotheses of the theorem,

$$\begin{aligned} & \deg_v \langle K^n \rangle \\ &= \underbrace{-2s(q)(n)n^2 - 2s_1(q)(n)n + \text{lower order terms}}_{\deg_v \langle L^n \rangle} + n^2 \sum_{i=1}^m (q_i' - 1) + n^2 \sum_{i=1}^m [r_i] + 2n \sum_{i=1}^m [r_i]_o. \end{aligned}$$

Gathering the coefficients multiplying n^2 and accounting for the writhes of standard diagrams D_K, D_P , we get

$$\text{js}_K(n) = \text{js}_P(n) - \omega(D_P) + \omega(D_K) + \sum_{i=1}^m (q_i' - 1) + \sum_{i=1}^m [r_i].$$

Note that $q'_i = r_i[2]$, and $q'_0 = [r_0] = 0$ for this case, and so trivially

$$js_K(n) = js_P(n) - q'_0 - [r_0] - \omega(D_p) + \omega(D_K) + \sum_{i=1}^m (r_i[2] - 1) + \sum_{i=1}^m [r_i].$$

Now we compute $jx_K(n)$ by considering $\deg_v \langle K^{n-1} \rangle$ and collecting coefficients of n . This gives

$$\begin{aligned} jx_K(n) &= jx_P(n) - 2 \sum_{i=1}^m (q'_i - 1) - 2 \sum_{i=1}^m [r_i] + 2 \sum_{i=1}^m [r_i]_o. \\ &= jx_P(n) - 2 \sum_{i=1}^m (q'_i - 1) - 2 \sum_{i=1}^m [r_i]_e. \end{aligned}$$

Trivially we have

$$jx_K(n) = jx_P(n) - 2 \frac{q'_0}{r_0[2]} + 2[r_0]_o - 2 \sum_{i=1}^m (r_i[2] - 1) - 2 \sum_{i=1}^m [r_i]_e.$$

- (2) $r_0 \neq 1/q_0$. In this case, we account for the degree change for the TR^+ -moves applied to L_+^n in the same way as in case (1). It remains to account for the change to the degree based on applying TR_2^- -moves with a final TR_1^- -move to the n -cabled negative tangle of the special Montesinos knot L . Each application of the TR_2^- -move adds $-(r_0[j+2] + r_0[j+1])n^2 - 2(r_0[j+1])n$ to the degree, and the final application of the TR_1^- -move adds $-r_0[\ell_{r_0}]n^2 + 2(-r_0[\ell_{r_0}] - 1)n$. We sum the contribution over j odd from 1 to ℓ_{r_0} .

$$\begin{aligned} &\sum_{j \text{ odd}, 1 \leq j < \ell_{r_0}} -(r_0[j+2] + r_0[j+1])n^2 - 2(r_0[j+1])n \\ &= -(r_0[2] + [r_0] - r_0[\ell_{r_0}])n^2 - 2([r_0]_e - r_0[\ell_{r_0}] + r_0[2])n. \end{aligned} \quad (31)$$

We compute similarly the quadratic growth rate and the linear growth rate of the final TR_1^- -move:

$$-r_0[\ell_{r_0}]n^2 + 2(-r_0[\ell_{r_0}] - 1)n. \quad (32)$$

Adding (31), (32), we have

$$(31) + (32) = -(r_0[2] + [r_0])n^2 - 2([r_0]_e + r_0[2] + 1)n. \quad (33)$$

Plugging in $n - 1$ for n and expanding, the result is

$$(31) + (32) = -(r_0[2] + [r_0])n^2 - 2([r_0]_e + r_0[2] + 1 - (r_0[2] + [r_0]))n. \quad (34)$$

When we add the coefficients multiplying n^2 and the coefficients multiplying n from (33) from the moves on K_+^n , we get in this case

$$\text{js}_K(n) = \left(\text{js}_P(n) - \omega(D_p) + \omega(D_K) + \sum_{i=1}^m (r_i[2] - 1) + \sum_{i=1}^m [r_i] \right) - (r_0[2] + [r_0]), \quad (35)$$

and

$$\text{jx}_K(n) = \left(\text{jx}_P(n) - 2 \sum_{i=1}^m (r_i[2] - 1) - 2 \sum_{i=1}^m [r_i]_e \right) + 2[r_0]_o - 2 \frac{q'_0}{r_0[2]}, \quad (36)$$

as in the statement of the theorem. □

6. ESSENTIAL SURFACES OF MONTESINOS KNOTS

Let Σ be a compact, connected, non boundary-parallel, and properly embedded surface in a compact, orientable 3-manifold Y with torus boundary. We say that Σ is *essential* if the map on fundamental groups $\iota^* : \pi_1(\Sigma) \rightarrow \pi_1(Y)$ induced by inclusion of Σ into Y is injective. The surface Σ is *incompressible* if for each disk $D \subset Y$ with $D \cap \Sigma = \partial D$, there is a disk $D' \subset \Sigma$ with $\partial D' = \partial D$. The surface Σ is called *∂ -incompressible* if for each disk $D \subset Y$ with $D \cap \Sigma = \alpha$, $D \cap \partial Y = \beta$ (α and β are arcs), $\alpha \cup \beta = \partial D$, and $\alpha \cap \beta = S^0$, there is a disk $D' \subset \Sigma$ with $\partial D' = \alpha' \cup \beta'$ such that $\alpha' = \alpha$ and $\beta' \subset \partial \Sigma$.

Orient the torus boundary ∂Y with the choice of the canonical meridian-longitude basis μ, λ from the standard framing (so the linking number of the longitude and the knot is 0) given an orientation on the knot. The boundary curves $\partial \Sigma$ of an essential surface Σ with boundary in ∂Y are homologous and thus determines a homology class $[p\mu + q\lambda]$ in $H_1(\partial Y)$. The *boundary slope* of Σ is the fraction $p/q \in \mathbb{Q} \cup \{1/0\}$, reduced to lowest terms. Hatcher showed that the set of boundary slopes of a compact orientable irreducible 3-manifold with torus boundary (in particular a knot exterior) is finite [Hat82].

An orientable surface is essential if and only if it is incompressible. On the other hand, a non-orientable surface is essential if and only if its orientable double cover in the ambient manifold is incompressible. In an irreducible orientable 3-manifold whose boundary consists of tori (such as a link complement), an orientable incompressible surface is either ∂ -incompressible or a ∂ -parallel annulus [Wal67]. Therefore, the problem of finding boundary slopes for Montesinos knots may be reduced to the problem of finding orientable incompressible and ∂ -incompressible surfaces, and we will only consider such surfaces for the rest of the paper.

In this section, we summarize the Hatcher-Oertel algorithm for finding all boundary slopes of Montesinos knots [HO89], based on the classification of orientable incompressible and ∂ -incompressible surfaces of rational (also known as 2-bridge) knots in [HT85]. For every Jones slope that we find in Sections 4.3 and 5.3, we will use the algorithm to produce an orientable, incompressible and ∂ -incompressible surface, whose boundary slope, number of boundary components, and Euler characteristic realize the strong slope conjecture. This completes the proof of Theorem 1.2 and Theorem 1.3.

We will follow the conventions of [HO89] and [HT85]. For further exposition of the algorithm, the reader may also consult [IM07]. It will be useful to introduce the negative continued fraction expansion [BS, Ch.13]

$$[[a_0, a_1, \dots, a_\ell]] = [a_0, -a_1, \dots, (-1)^\ell a_\ell] = a_0 - \frac{1}{a_1 - \frac{1}{a_2 - \frac{1}{a_3 - \dots - \frac{1}{a_\ell}}}}. \quad (37)$$

with $a_i \in \mathbb{Z}$ and $a_i \neq 0$ for $i > 0$.

6.1. Incompressible and ∂ -incompressible surfaces for a rational knot. A notion originally due to Haken [Hak61], a *branched surface* B in a 3-manifold Y is a subspace locally modeled on the space as shown on the left in the Figure 29. This means every point has a neighborhood diffeomorphic to the neighborhood of a point in the model space. A properly embedded surface Σ in Y is *carried by* B if Σ can be isotoped so that it runs nearly parallel to B , i.e., S lies in a fibered regular neighborhood $N(B)$ of B , and such that S meets every fiber of $N(B)$ ³.

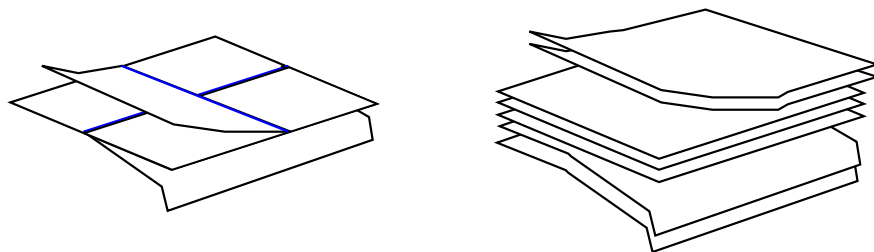

FIGURE 29. Left: local picture of a branched surface, with the blue lines indicating the singularities. Right: a surface carried by the branch surface.

Using branched surfaces, Hatcher and Thurston [HT85] classify all orientable, incompressible and ∂ -incompressible surfaces with nonempty boundary for a rational knot $K_r = K(1/r)$ where $r \in \mathbb{Q} \cup \{1/0\}$ in terms of negative continued fraction expansions of r . For each negative continued fraction expansion $[[b_0, b_1, \dots, b_k]]$ of r as in (37) they construct a branched surface $\Sigma(b_1, \dots, b_k)$ and associated surfaces $S_M(M_1, \dots, M_k)$ carried by $\Sigma(b_1, \dots, b_k)$, where $M \geq 1$ and $0 \leq M_j \leq M$.

We will now describe their representation of a surface $S_M(M_1, \dots, M_k)$ carried by a branched surface $\Sigma(b_1, \dots, b_k)$ in terms of an *edge-path* on a one-complex \mathcal{D} . Here, \mathcal{D} is the Farey ideal triangulation of \mathbb{H}^2 on which $\text{PSL}_2(\mathbb{Z})$ is the group of orientation-preserving symmetries, see Figure 30. Recall that the vertices (in the natural compactification) of \mathcal{D}

³In [FO84] and [Hat82], a surface is carried by a branched surface if it lies in a fibered regular neighborhood of the branched surface. A surface is carried by a branched surface with *positive weights* if in addition the surface intersects every fiber of the fibered regular neighborhood of the branched surface. Here we add the condition that the surface meets every fiber of the fibered regular neighborhood of the branched surface to simplify the summary of results from [FO84], [Hat82].

are $\mathbb{Q} \cup \infty$ and we set $\infty = \frac{1}{0}$ in projective coordinates. A typical vertex of \mathcal{D} will be denoted by $\langle \frac{p}{q} \rangle$ for coprime integers p, q with $q \geq 0$. There is an edge between two vertices $\langle \frac{p}{q} \rangle$ and $\langle \frac{r}{s} \rangle$, denoted by $\langle \frac{p}{q} \rangle \text{---} \langle \frac{r}{s} \rangle$, whenever $|ps - rq| = 1$. An *edge-path* is a path on the 1-skeleton of \mathcal{D} which may have endpoints on an edge rather than on a vertex.

Given a negative continued fraction expansion $[[b_0, \dots, b_k]]$ of r , the vertices of the corresponding edge-path are the sequence of partial sums

$$[[b_0, b_1, \dots, b_k]], [[b_0, b_1, \dots, b_{k-1}]], \dots, [[b_0, b_1]], [[b_0]], \infty.$$

Given a choice of integers $M \geq 1$ and $0 \leq M_j \leq M$, we construct a surface $S_M(M_1, \dots, M_k)$ in the exterior of K_r from this edge-path as follows. We isotope the 2-bridge knot presentation of K_r so that it lies in $S^2 \times [0, 1]$, with the two bridges intersecting $S^2 \times \{1\}$ in two arcs of slope ∞ , and the arcs of slope r lying in $S^2 \times \{0\}$. See [HT85, p.1 Fig. 1(b)]. The slope here is determined by the lift of those arcs to \mathbb{R}^2 , where $S^2 \times \{i\} \setminus K$ is identified with the orbit space of Γ , the isometry group of \mathbb{R}^2 generated by 180°-degree rotation about the integer lattice points.

Given an edge-path with vertices $\{\langle v \rangle\}$, choose heights $\{i_v\}$, $i_v \in [0, 1]$ respecting the ordering of the vertices in the path. At $S^2 \times \{0\}$, we have $2M$ arcs of slope r , and at $S^2 \times \{1\}$ we have $2M$ arcs of slope ∞ . For a fixed M , each vertex $\langle v \rangle$ of an edge-path determines a curve system on $S^2 \times \{i_v\}$, consisting of $2M$ arcs of slope v with ends on the four punctures representing the intersection with the knot. The surface $S_M(M_1, \dots, M_k)$ is constructed by having its intersections with $S^2 \times \{i_v\}$ coincide with the curve system at $\langle v \rangle$. Between one vertex $\langle v \rangle$ to another, say $\langle v' \rangle$ connected by an edge, M saddles are added to change all $2M$ arcs of slope v to $2M$ arcs of slope v' , with M_j indicating one of the two possible choices of such saddles. At the end of the edge-path, $2M$ disks are added to the slope ∞ curve system, which corresponds to closing the knot by the two bridges.

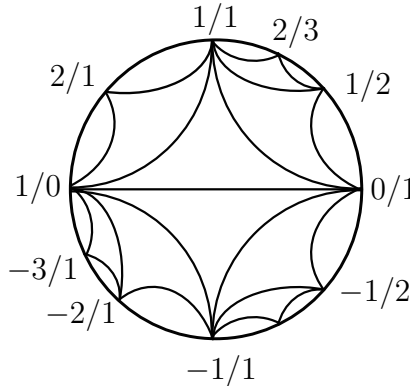

FIGURE 30. Some edges of the 1-complex \mathcal{D} .

Hatcher and Thurston have shown that every non-closed incompressible, ∂ -incompressible surface in $S^3 \setminus K_r$ is isotopic to $S_M(M_1, \dots, M_k)$ for some M and M_j 's. Furthermore, a surface $S_M(M_1, \dots, M_k)$ carried by $\Sigma(b_1, \dots, b_k)$ is incompressible and ∂ -incompressible if and only if $|b_j| \geq 2$ for each $1 \leq j \leq k$ [HT85, Theorem 1.(b) and (c)]. For more details on the construction of the branched surface $\Sigma(b_1, \dots, b_k)$, and how it is used in the proof, see

[HT85]. Floyd and Oertel have shown that there is a finite, constructible set of branched surfaces for every Haken 3-manifold with incompressible boundary, which carries all the two-sided, incompressible and ∂ -incompressible surfaces [FO84]. For the general theory of branched surfaces applied to the question of finding boundary slopes in a 3-manifold, interested readers may consult these references. We will continue to specialize to the case of knots.

Let B be a branched surface in a 3-manifold Y with torus boundary, and let S be a properly embedded surface in Y carried by B . There is an orientation on ∂B such that all the boundary circles of S , oriented with the induced orientations from the orientation on ∂B , are homologous in the torus boundary of Y . See [Hat82, p.375, Lemma] for the full statement and a proof of this result that generalizes to the case where an orientable, compact, and irreducible 3-manifold has boundary the union of multiple tori. Thus to compute a boundary slope it suffices to specify a branched surface, and hence the edge-path representing the surface as described above in the case of rational knots. This is how we will describe the surfaces we consider for computing the boundary slopes of a Montesinos knot for the rest of this paper.

6.2. Edge-paths and candidate surfaces for Montesinos knots. Hatcher and Oertel [HO89] give an algorithm that provides a complete classification of boundary slopes of Montesinos knots by decomposing $K(r_0, r_1, \dots, r_m)$ via a system of Conway spheres $\{S_i^2\}_{i=1}^m$, each of which contains a rational tangle T_{r_i} . Their algorithm determines the conditions under which the incompressible and the ∂ -incompressible surfaces in the complement of each rational tangle, as classified by [HT85] and put in the form in terms of edge-paths as discussed in Section 6.1, may be glued together across the system of Conway spheres to form an incompressible surface in $S^3 \setminus K(r_0, r_1, \dots, r_m)$.

To describe the algorithm, it is now necessary to give coordinates to curve systems on a Conway sphere. The curve system $S \cap S_i^2$ for a connected surface $S \subset S^3 \setminus K(r_0, r_1, \dots, r_m)$ may be described by homological coordinates A_i , B_i , and C_i as shown in Figure 31 [Hat88].

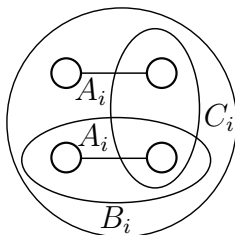

FIGURE 31. The Conway sphere containing the tangle corresponding to r_i and the curve system on it.

Since an incompressible surface S must also be incompressible when restricting to a tangle inside a Conway sphere, the classification of [HT85] applies, and the representation by Hatcher-Thurston of such a surface in terms of an edge-path also carries over. However, the edge-paths lie instead in an augmented 1-complex $\hat{\mathcal{D}}$ in the plane obtained by splitting open \mathcal{D} along the slope ∞ edge and adjoining constant edge-paths $\langle \frac{p}{q} \rangle \text{---} \langle \frac{p}{q} \rangle$. See [HO89, Fig.

1.3]. The additional edges in $\hat{\mathcal{D}}$ incorporate the new possibilities of curve systems that arise when gluing the surfaces following the tangle sum.

Again, an edge-path in $\hat{\mathcal{D}}$ is a path in the 1-skeleton of $\hat{\mathcal{D}}$ which may or may not end on a vertex. It describes a surface in the complement of a rational tangle in $K(r_0, r_1, \dots, r_m)$ consisting of saddles joining curve systems corresponding to vertices, as described in the last paragraph of Section 6.1. The main adjustment is that the endpoint of an edge-path may not end at $\langle \infty \rangle$. In order for the endpoint representing the curve system to come from the intersection with an incompressible and ∂ -incompressible surface, it must be on an edge $\langle \frac{p}{q} \rangle \text{---} \langle \frac{r}{s} \rangle$ and has the form

$$\frac{K}{M} \langle \frac{p}{q} \rangle + \frac{M-K}{M} \langle \frac{r}{s} \rangle,$$

for integers $K \in \mathbb{Z}$, $M > 0$. If $\frac{p}{q} \neq \frac{r}{s}$, this describes a curve system on a Conway sphere consisting of K arcs of slope p/q , of (A, B, C) -coordinates $K(1, q-1, p)$, and $M-K$ arcs of slope r/s , of (A, B, C) -coordinates $(M-K)(1, s-1, r)$. The coordinate of the point is the sum: $(M, K(q-1) + (M-K)(s-1), Kp + (M-K)r)$. If $\frac{p}{q} = \frac{r}{s}$, this describes a curve system on a Conway sphere consisting of $(M-K)$ arcs of slope p/q , of (A, B, C) -coordinates $(M-K)(1, q-1, p) = (M-K, (M-K)(q-1), (M-K)p)$, and K circles of slope p/q , of (A, B, C) -coordinates $K(0, q, p) = (0, Kq, Kp)$. The coordinate of the point is again the sum: $(M-K, (M-K)(q-1) + Kq, Mp)$.

The algorithm is as follows.

- (1) For each fraction r_i , pick an edge-path γ_i in the 1-complex $\hat{\mathcal{D}}$ corresponding to a continued fraction expansion

$$r_i = [[b_0, b_1, \dots, b_k]], b_j \in \mathbb{Z}, |b_j| \geq 2 \text{ for } 1 \leq j \leq k.$$

As discussed in Section 6.1, these continued fraction expansions correspond to essential surfaces in the complement of the rational knot K_{r_i} . For example, for $1/3$ the choices are either $[[0, -3]]$ or $[[1, 2, 2]]$. Or, choose the constant edge-path $\langle r_i \rangle \text{---} \langle r_i \rangle$.

- (2) For each edge $\langle \frac{p}{q} \rangle \text{---} \langle \frac{r}{s} \rangle$ in γ_i , determine the integer parameters $\{K_i\}_{i=0}^m$, $\{M_i\}_{i=0}^m$ satisfying the following constraints.

- (a) $A_i = A_j$ and $B_i = B_j$ for all the A -coordinates A_i and the B -coordinates B_i of the point

$$\frac{K_i}{M_i} \langle \frac{p}{q} \rangle + \frac{M_i - K_i}{M_i} \langle \frac{r}{s} \rangle.$$

- (b) $\sum_{i=0}^m C_i = 0$ where C_i is the C -coordinate of the point

$$\frac{K_i}{M_i} \langle \frac{p}{q} \rangle + \frac{M_i - K_i}{M_i} \langle \frac{r}{s} \rangle.$$

The edge-paths chosen in (1) with endpoints specified by the solutions to (a) and (b) of (2) determine a candidate edge-path system $\{\gamma_i\}_{i=0}^m$, corresponding to a connected and properly embedded surface S in $S^3 \setminus K(r_0, r_1, \dots, r_m)$. We call this the *candidate surface* associated to a candidate edge-path system.

- (3) Apply incompressibility criteria [HO89, Prop. 2.1, Cor. 2.4, and Prop. 2.5-2.9] to determine if a candidate surface is an incompressible surface and thus actually gives a boundary slope.

Remark 6.1. We would like to remark that Dunfield [Dun01] has written a computer program implementing the Hatcher-Oertel algorithm, which will output the set of boundary slopes given a Montesinos knot and give other information like the set of edge-paths representing an incompressible, ∂ -incompressible surface, Euler characteristic, number of sheets, etc. The program has provided most of the data we use in our examples in this paper. Interested readers may download the program at his website <https://faculty.math.illinois.edu/~nmd/montesinos/index.html>.

We will write $S(\{\gamma_i\}_{i=0}^m)$ to indicate a candidate surface associated to a candidate edge-path system $\{\gamma_i\}_{i=0}^m$. Note that for a candidate edge-path system without constant edge-paths, M_i is identical for $i = 0, \dots, m$ by condition (2a) in the algorithm. We will only consider this type of edge-path systems for the rest of this paper, and simply write M for M_i for a candidate surface S .

We will mainly be applying [HO89, Corollary 2.4], which we restate here. Note that for an edge $\langle \frac{p}{q} \rangle \xrightarrow{\frac{K}{M}} \langle \frac{p}{q} \rangle + \frac{M-K}{M} \langle \frac{r}{s} \rangle$, the ∇ -value (called the “ r -value” in [HO89]) is 0 if $\frac{p}{q} = \frac{r}{s}$ or if the edge is vertical, and the ∇ -value is $|q - s|$ when $\frac{p}{q} \neq \frac{r}{s}$.

Theorem 6.2. [HO89, Corollary 2.4] *A candidate surface $S(\{\gamma_i\}_{i=0}^m)$ is incompressible unless the cycle of ∇ -values for the final edges of the γ_i 's is of one of the following types: $\{0, \nabla_1, \dots, \nabla_m\}$, $\{1, 1, \dots, 1, \nabla_m\}$, or $\{1, \dots, 1, 2, \nabla_m\}$.*

6.3. The boundary slope of a candidate surface. The *twist number* $\text{tw}(S)$ for a candidate surface $S(\{\gamma_i\}_{i=0}^m)$ is defined as

$$\text{tw}(S) := \frac{2}{M} \sum_{i=0}^m (s_i^- - s_i^+) = 2 \sum_{i=0}^m (e_i^- - e_i^+), \tag{38}$$

where s_i^- is the number of slope-decreasing saddles of γ_i , s_i^+ is the number of slope-increasing saddles of γ_i , and M is the number of sheets of S [HO89, p.460]. Let an edge be given by $\langle \frac{p}{q} \rangle \xrightarrow{\frac{r}{s}} \langle \frac{r}{s} \rangle$, we say that the edge decreases slope if $\frac{r}{s} < \frac{p}{q}$, and that the edge increases slope if $\frac{r}{s} > \frac{p}{q}$. In terms of edge-paths, $\text{tw}(S)$ can be written in terms of the number e_i^- of edges of γ_i that decreases slope and e_i^+ , the number of edges of γ_i that increases slope as shown. If γ_i has a final edge

$$\langle \frac{p}{q} \rangle \xrightarrow{\frac{K_i}{M}} \langle \frac{p}{q} \rangle + \frac{M - K_i}{M} \langle \frac{r}{s} \rangle,$$

then the final edge of γ_i is called a fractional edge and counted as a fraction $\frac{M-K_i}{M}$. Finally, the boundary slope $\text{bs}(S)$ of a candidate surface S is given by

$$\text{bs}(S) = \text{tw}(S) - \text{tw}(S_0) \tag{39}$$

where S_0 is a Seifert surface that is a candidate surface from the Hatcher-Oertel algorithm. For the relation of the twist numbers to boundary slopes, see [HO89, p.460].

6.4. The Euler characteristic of a candidate surface. We compute the Euler characteristic of a candidate surface $S = S(\{\gamma_i\}_{i=0}^m)$, where none of the γ_i 's are constant or end in $\langle \infty \rangle$ as follows. M is again the number of sheets of the surface S . We begin with $2M$ disks which intersect $S_i^2 \times \{0\}$ in slope r_i arcs in each 3-ball B_i^3 containing the rational tangle corresponding to r_i .

- From left to right in an edge-path γ_i , each non-fractional edge $\langle \frac{p}{q} \rangle \text{---} \langle \frac{r}{s} \rangle$ is constructed by gluing M saddles that change $2M$ arcs of slope $\frac{p}{q}$ (representing the intersections with $S_i^2 \times \{i \frac{p}{q}\}$) to slope $\frac{r}{s}$ (representing the intersections with $S_i^2 \times \{i \frac{r}{s}\}$), therefore decreasing the Euler characteristic by M .
- A fractional final edge of γ_i of the form $\langle \frac{p}{q} \rangle \text{---} \frac{K}{M} \langle \frac{p}{q} \rangle + \frac{M-K}{M} \langle \frac{r}{s} \rangle$ changes $2(M-K)$ out of $2M$ arcs of slope $\frac{p}{q}$ to $2(M-K)$ arcs of slope $\frac{r}{s}$ via $M-K$ saddles, thereby decreasing the Euler characteristic by $M-K$.

This takes care of the individual contribution to the Euler characteristic of an edge-path $\{\gamma_i\}$. Now the identification of the surfaces on each of the 4-punctured spheres will also affect the Euler characteristic of the resulting surface. In terms of the common (A, B, C) -coordinates of each edge-path, there are two cases:

- The identification of hemispheres between neighboring balls B_i^3 and B_{i+1}^3 identifies $2M$ arcs and B_i half circles. Thus it subtracts $2M + B_i$ from the Euler characteristic for each identification.
- The final step of identifying hemispheres from B_0^3 and B_m^3 on a single sphere adds B_i to the Euler characteristic.

6.5. Matching the growth rate to topology for pretzel knots. We consider two candidate surfaces from the Hatcher-Oertel algorithm whose boundary slopes and the ratios of Euler characteristic to the number of sheets will be shown to match the growth rate of the degree of the colored Jones polynomial from the previous sections as predicted by the strong slope conjecture.

6.5.1. *The surface $S(M, x^*)$.* For $1 \leq i \leq m$ write

$$x_i^* = \frac{(q_i - 1)^{-1}}{\sum_{j=1}^m (q_j - 1)^{-1}}. \quad (40)$$

The x_i^* 's come from the coefficients of t in (19) in the real maximizers $x_i^*(t)$ of the degree function $\delta(n, k)$ from the state sum of the n th colored Jones polynomial. Let M be the least common multiple of the denominators of $\{x_i^*\}_{i=1}^m$, reduced to lowest terms. For example, suppose we have the pretzel knot $P(-11, 7, 9)$, then

$$x_1^* = \frac{\frac{1}{7-1}}{\frac{1}{7-1} + \frac{1}{9-1}} = \frac{4}{7}, \quad x_2^* = \frac{\frac{1}{8}}{\frac{1}{7-1} + \frac{1}{9-1}} = \frac{3}{7},$$

and M is 7. We show that $\{x_i^*\}$ and M determine a candidate surface from the Hatcher-Oertel algorithm.

Recall for $q = (q_0, q_1, \dots, q_m)$,

$$s(q) = 1 + q_0 + \frac{1}{\sum_{i=1}^m (q_i - 1)^{-1}}.$$

Lemma 6.3. Suppose $q = (q_0, q_1, \dots, q_m)$ is such that $s(q) \leq 0$. There is a candidate surface $S(M, x^*)$ from the Hatcher-Oertel algorithm with $M > 0$ sheets and C -coordinates

$$\{-M, Mx_1^*, Mx_2^*, \dots, Mx_m^*\}.$$

Proof. Directly from the proof of Lemma 4.1, the elements of the set $\{x_i^*\}_{i=1}^m$ satisfy the following equations.

$$\begin{aligned} x_i^*(q_i - 1) &= x_j^*(q_j - 1), \text{ for } i \neq j, \text{ and} \\ \sum_{i=1}^m x_i^* &= 1. \end{aligned} \tag{41}$$

Consider the edge-path systems determined by the following choice of continued fraction expansions for $\{1/q_i\}_{i=0}^m$.

$$\begin{aligned} 1/q_0 &= [[-1, \underbrace{-2, -2, \dots, -2}_{-q_0-1}], \text{ and} \\ 1/q_i &= [[0, -q_i]], \text{ for } 1 \leq i \leq m. \end{aligned}$$

Note that they represent locally incompressible surfaces since $|-2| \geq 2$ and $q_i \geq 2$ for $1 \leq i \leq m$ as discussed in Section 6.1. Let $K_i = Mx_i^*$ for $1 \leq i \leq m$, and suppose we have $0 \leq K_0 \leq M$, $2 \leq q \leq -q_0$ such that

$$K_0 + M(q - 2) = K_1(q_1 - 1). \tag{42}$$

This condition is the same as requiring $B_0 = B_1$ from (a) of Step (2) of the Hatcher-Oertel algorithm. We specify a candidate surface $S(M, x^*)$ in terms of edge-paths $\{\gamma_i\}_{i=0}^m$:

The edge-path γ_0 for q_0 is

$$\left\langle \frac{-1}{-q_0} \right\rangle \text{---} \left\langle \frac{-1}{-q_0 - 1} \right\rangle \text{---} \dots \text{---} \frac{K_0}{M} \left\langle \frac{-1}{q} \right\rangle + \frac{M - K_0}{M} \left\langle \frac{-1}{q - 1} \right\rangle.$$

For $1 \leq i \leq m$, we have the edge-path γ_i :

$$\left\langle \frac{1}{q_i} \right\rangle \text{---} \frac{K_i}{M} \left\langle \frac{1}{q_i} \right\rangle + \frac{M - K_i}{M} \left\langle \frac{0}{1} \right\rangle. \tag{43}$$

Provided that K_0, q satisfying (42) exist, together with (41) this edge-path system satisfies the equations coming from (a) and (b) of Step (2) of the algorithm. Thus, there is a candidate surface with $\{-M, Mx_1^*, Mx_2^*, \dots, Mx_m^*\}$ as the C -coordinates in the tangles corresponding to r_i 's.

It remains to show that the assumption $s(q) \leq 0$ implies the existence of K_0, q satisfying (42).

Write

$$x_i^* = \frac{(q_i - 1)^{-1}}{\sum_{j=1}^m (q_j - 1)^{-1}} = \frac{\sum_{j=1}^m (q_j - 1)}{(q_i - 1)\prod_{j=1}^m (q_j - 1)}.$$

Recall $s(q) \leq 0$ means

$$1 + q_0 + \frac{1}{\sum_{i=1}^m (q_i - 1)^{-1}} = 1 + q_0 + \frac{\sum_{i=1}^m (q_i - 1)}{\prod_{i=1}^m (q_i - 1)} \leq 0.$$

Multiply both sides by M , we get

$$M(1 + q_0) + M \frac{\sum_{i=1}^m (q_i - 1)}{\prod_{i=1}^m (q_i - 1)} \leq 0.$$

This implies that a pair of integers K_0, q such that $0 \leq K_0 \leq M$, $q_0 \leq q \leq -2$ exist such that (42) is satisfied, since by definition

$$M \frac{\sum_{i=1}^m (q_i - 1)}{\prod_{i=1}^m (q_i - 1)} = Mx_1^*(q_1 - 1) = K_1(q_1 - 1),$$

which is the same as saying

$$M(1 + q_0) + K_1(q_1 - 1) \leq 0.$$

So if $M > K_1(q_1 - 1)$, we can choose $q = 2$ and $K_0 = K_1(q_1 - 1)$. Otherwise, we choose some $q_0 \leq -q \leq -2$ such that

$$0 \leq K_1(q_1 - 1) - M(q - 2) \leq M.$$

Let K_0 be the difference $K_1(q_1 - 1) - M(q - 2)$. □

The twist number of $S(M, x^*)$. With the given edge-path system (43) in the proof of Lemma 6.3 and applying the formula for computing the boundary slope in Section 6.3, we compute the twist number of $S(M, x^*)$. For the edge-path γ_0 of q_0 , since $q_0 < 0$, each edge of the edge-path is slope-decreasing. Similarly, each edge in γ_i for q_i is slope-decreasing (since $q_i > 0$, the edge $\langle 1/q_i \rangle \text{---} \langle 0/1 \rangle$ is decreasing in slope). Each non-fractional path contributes 1, and then the single fractional edge at the end contributes $(M - K_i)/M$ for $0 \leq i \leq m$. Thus

$$\begin{aligned} \frac{\text{tw}(S(M, x^*))}{2} &= \underbrace{\frac{(-q - q_0)}{2}}_{\text{contribution of the non-fractional edges of } \gamma_0} + \underbrace{\frac{M - K_0}{M}}_{\text{contribution of the single fractional edge at the end of } \gamma_0} \\ &+ \underbrace{\sum_{i=1}^m \frac{M - K_i}{M}}_{\text{contribution of the single fractional edge for each of the } \gamma_i\text{'s for } 1 \leq i \leq m}. \end{aligned}$$

By construction, $\sum_{i=1}^m \frac{K_i}{M} = 1$ and $-q - \frac{K_0}{M} = -\frac{K_1}{M}(q_1 - 1) - 2$ from (42), so

$$\text{tw}(S(M, x^*)) = 2(-q_0 - x_1^*(q_1 - 1) + m - 2). \tag{44}$$

The Euler characteristic of $S(M, x^*)$. With the given edge-path system and applying the formula for computing the Euler characteristic in Section 6.4, we compute the Euler characteristic over the number of sheets for $S(M, x^*)$. We start with $2M$ disks for each tangle. Each non-fractional edge of an edgepath in $\{\gamma_i\}_{i=0}^m$ subtracts M from the Euler characteristic, while the final fractional edges subtract $\sum_{i=0}^m M - K_i$ from the Euler characteristic. At the final step of gluing surfaces across Conway spheres, we subtract $2M + B_i$ for each identification out of m identifications, then add a single B_i back. We have, since $B_i = K_i(q_i - 1) = B_j$,

$$\sum_{i=1}^m B_i = mK_i(q_i - 1). \quad (45)$$

All together, the Euler characteristic over the number of sheets of $S(M, x^*)$ is given by

$$\begin{aligned} \frac{2\chi(S(M, x^*))}{\#S(M, x^*)} = & 2\left(\underbrace{\frac{2M(m+1)}{M}}_{\text{contribution from } 2M \text{ disks in each tangle}} - \underbrace{\frac{(-q - q_0)M + (\sum_{i=0}^m M - K_i)}{M}}_{\text{contribution from the edges of the edge-path system}} \right. \\ & \left. - \underbrace{\left(\sum_{i=1}^m \frac{(2M + B_i)}{M} \right)}_{\text{contribution from the } m \text{ identifications}} + \underbrace{\frac{B_i}{M}}_{\text{contribution from the final identification}} \right) \end{aligned} \quad (46)$$

Using (41), (44), and (45) to simplify, we get

$$\begin{aligned} \frac{2\chi(S(M, x^*))}{\#S(M, x^*)} &= 4 - \text{tw}(S(M, x^*)) - 2(m-1)x_i^*(q_1 - 1) \\ &= 4 - 2(-q_0 - x_i^*(q_1 - 1) + m - 2) - 2(m-1)x_i^*(q_1 - 1) \\ &= 8 - 2m + 2q_0 - 2(m-2)x_i^*(q_1 - 1). \end{aligned} \quad (47)$$

The cycle of ∇ -values of $S(M, x^*)$. For $i = 0$, the last edge of the edge-path γ_0 is

$$\left\langle \frac{-1}{q} \right\rangle \text{---} \frac{K_0}{M} \left\langle \frac{-1}{q} \right\rangle + \frac{M - K_0}{M} \left\langle \frac{-1}{q-1} \right\rangle,$$

so the ∇ -value for this edge-path is $|q - (q-1)| = 1$. For $1 \leq i \leq m$, the final edge of the edge-path γ_i is of the form

$$\left\langle \frac{1}{q_i} \right\rangle \text{---} \frac{K_i}{M} \left\langle \frac{1}{q_i} \right\rangle + \frac{M - K_i}{M} \left\langle \frac{0}{1} \right\rangle.$$

So the value of each $1 \leq i \leq m$ is $q_i - 1$ following the discussion preceding Theorem 6.2.

The cycle of ∇ -values for the edge-path system is $(1, q_1 - 1, q_2 - 1, \dots, q_m - 1)$.

6.5.2. *The reference surface R .* Note that the sequence of parameters $(0)_{i=0}^m$ also trivially satisfy the equations from Step 2(a) and 2(b) of the Hatcher-Oertel algorithm with the choice of continued fraction expansion $1/q_i = [[0, -q_i]]$ for $0 \leq i \leq m$, and therefore defines a connected candidate surface in the complement of $K(1/q_0, \dots, 1/q_m)$. We will call this surface the *reference surface R* .

In the framework of the Hatcher-Oertel algorithm, the edge-path corresponding to the reference surface has the following form for each q_i , $0 \leq i \leq m$:

$$\left\langle \frac{1}{q_i} \right\rangle \text{ --- } \langle 0 \rangle.$$

The twist number of R . With the exception of γ_0 , which has a single slope-increasing edge (reading from left to right, the edge increases in slope from $1/q_0 < 0$ to 0), each edge-path γ_i is slope-decreasing (the edge decreases in slope from $1/q_i > 0$ to 0) of length 1, thus the twist number of the reference surface R is

$$\text{tw}(R) = 2(m - 1). \quad (48)$$

The Euler characteristic of R . The surface R has 1 sheet. The Euler characteristic is computed similarly as for $S(M, x^*)$, (46), except that there are only non-fractional edges in the edge-path system.

$$\begin{aligned} \frac{2\chi(R)}{\#R} &= 2\left(\frac{2M(m+1)}{M} - \sum_{i=0}^m \frac{M}{M} - \left(\sum_{i=1}^m \frac{2M+0}{M}\right) + \frac{0}{M}\right) \\ &= 2(1 - m). \end{aligned}$$

The cycle of ∇ -values of R . The cycle of ∇ -values of R is $(-q_0 - 1, q_1 - 1, \dots, q_m - 1)$.

6.5.3. *Matching the Jones slope.* The results of Section 4.3 applied to the class of pretzel knots we consider gives the degree of the n th colored Jones polynomial. We show that the quadratic growth rate with respect to n matches the boundary slope of an incompressible surface. The claim is that the Jones slope is either realized by the surface $S(M, x^*)$ or the reference surface R in Section 6.5 depending on $s(q)$ and $s_1(q)$. Note that both $S(M, x^*)$ (if $s(q) \leq 0$) and R are incompressible by an immediate application of Theorem 6.2, since $m \geq 2$ and $|q_i| > 2$ for all i . By the Hatcher-Oertel algorithm, the reference surface is incompressible for a Montesinos knot except $K(-\frac{1}{2}, \frac{1}{3}, \frac{1}{3})$, $K(-\frac{1}{2}, \frac{1}{3}, \frac{1}{4})$, and $K(-\frac{1}{2}, \frac{1}{3}, \frac{1}{5})$.

Lemma 6.4. Suppose $s(q) \leq 0$. Let R be the reference surface and $S(M, x^*)$ the surface by Lemma 6.3 with boundary slopes $\text{bs}(R)$ and $\text{bs}(S(M, x^*))$, respectively. If

$$-2s(q) = \text{tw}(S(M, x^*)) - \text{tw}(R),$$

then $-2s(q)$ equals the boundary slope of the surface $S(M, x^*)$.

Proof. Note that R is a Seifert surface from the Hatcher-Oertel algorithm, so $\text{bs}(R) = 0$, and

$$\text{bs}(S(M, x^*)) = \text{tw}(S(M, x^*)) - \text{tw}(R)$$

by (39). □

Theorem 6.5. Suppose $s(q) \leq 0$, we have:

$$-2s(q) = \text{tw}(S(M, x^*)) - \text{tw}(R).$$

Proof. From Equations (44) and (48) we have

$$\text{tw}(S(M, x^*)) - \text{tw}(R) = 2(-q_0 - x_1^*(q_1 - 1) + m - 2) - 2(m - 1).$$

By the definition of x_i^* ,

$$\begin{aligned} \text{tw}(S(M, x^*)) - \text{tw}(R) &= -2(q_0 + \frac{(q_1 - 1)^{-1}}{\sum_{j=1}^m (q_j - 1)^{-1}}(q_1 - 1) + 1) \\ &= -2s(q). \end{aligned}$$

□

6.5.4. *Matching the Euler characteristic.* Recall that for $q = (q_0, q_1, \dots, q_m)$,

$$s_1(q) = \frac{\sum_{i=1}^m (q_i + q_0 - 2)(q_i - 1)^{-1}}{\sum_{i=1}^m (q_i - 1)^{-1}}.$$

Lemma 6.6. We have

$$-2s_1(q) + 4s(q) - 2(m - 1) = 2 \frac{\chi(S(M, x^*))}{\#S(M, x^*)},$$

where $\chi(S(M, x^*))$ is the Euler characteristic and $\#S(M, x^*)$ is the number of sheets M of the surface $S(M, x^*)$.

Proof. We have by (46) and substituting for x_i^* by definition,

$$\begin{aligned} \frac{2\chi(S(M, x^*))}{\#S(M, x^*)} &= 8 - 2m + 2q_0 - 2(m - 2)x_1^*(q_1 - 1) \\ &= 8 - 2m + 2q_0 - 2(m - 2) \frac{(q_1 - 1)^{-1}}{\sum_{j=1}^m (q_j - 1)^{-1}}(q_1 - 1) \\ &= 8 - 2m + 2q_0 - 2(m - 2) \frac{1}{\sum_{j=1}^m (q_j - 1)^{-1}}. \end{aligned} \quad (*)$$

On the other hand, also substituting $s(q)$, $s_1(q)$ by definition,

$$\begin{aligned} -2s_1(q) + 4s(q) - 2(m - 1) &= -2 \left(\frac{\sum_{i=1}^m (q_i + q_0 - 2)(q_i - 1)^{-1}}{\sum_{i=1}^m (q_i - 1)^{-1}} \right) + 4 \left(1 + q_0 + \frac{1}{\sum_{j=1}^m (q_j - 1)^{-1}} \right) \\ &\quad - 2(m - 1) \\ &= -2 \left(\frac{m}{\sum_{j=1}^m (q_j - 1)^{-1}} + q_0 - 1 \right) + 4 \left(1 + q_0 + \frac{1}{\sum_{j=1}^m (q_j - 1)^{-1}} \right) \\ &\quad - 2(m - 1). \end{aligned}$$

The last line is easily seen to be equal to (*) by expanding and gathering like terms. □

6.6. Proof of Theorem 1.2. Now we prove Theorem 1.2. Fix odd integers q_0, \dots, q_m with $q_0 < -1 < 1 < q_1, \dots, q_m$. Let $P = P(q_0, \dots, q_m)$ denote the pretzel knot. By Theorem 6.2, both of the surfaces $S(M, x^*)$ (if $s(q) \leq 0$) and R are incompressible by examining their edge-paths and computing their ∇ -values. Lemma 6.4, Theorem 6.5, and Lemma 6.6 show that $-2s(q) = \text{bs}(S(M, x^*))$ and $-2s_1(q) + 4s(q) - 2(m-1) = 2\frac{\chi(S(M, x^*))}{\#S(M, x^*)}$. For the reference surface R , it is immediate also from the Hatcher-Oertel algorithm that its boundary slope $\text{bs}(R) = 0$ and $2\frac{\chi(R)}{\#R} = -2(m-1)$.

From Section 4.3, we have the following cases for the degree of the colored Jones polynomial $J_{P,n}(v)$. The choice of the surface detected by the Jones slope swings between the surface $S(M, x^*)$ and the reference surface R .

Case 1: $s(q) < 0$. We have that the maximum of $\delta(n, k)$ is given by

$$-2s(q)n^2 - 2s_1(q)n - 2(m-1)n + (n^2 + 2n) \sum_{i=0}^m q_i + O(1),$$

where recall that $s(q)$ and $s_1(q)$ are explicitly defined by (2). We see that $s(q)$ and $s_1(q)$ for any $n \gg 0$ are actually constant in n . The fact that $\text{js}_P = -2s(q) = \text{bs}(S(M, x^*))$ and $\text{jx}_P = -2s_1(q) + 4s(q) - 2(m-1) = 2\frac{\chi(S(M, x^*))}{\#S(M, x^*)}$ (by considering $J_{K,n} = (-1)^{n-1}((-1)^{n-1}v)^{\omega(K)(n^2-1)}\langle K^{n-1} \rangle$) verifies the strong slope conjecture in this case.

Case 2: $s(q) = 0$, $s_1(q) \neq 0$. If $s_1(q) \geq 0$, the maximum of $\delta(n, k)$ has no quadratic term, but its linear term is $-2(m-1)n$, so the reference surface R verifies the conjecture. If $s_1(q) < 0$, then the maximum

$$-2s_1(q)n - 2(m-1)n + (n^2 + 2n) \sum_{i=0}^m q_i + O(1)$$

of $\delta(n, k)$ is found at maximizers τ^* with parameters n, k^* , again all satisfying $n = k_0^* = k_1^* + \dots + k_m^*$. Thus the surface $S(M, x^*)$ verifies the conjecture.

Case 3: $s(q) > 0$. In this case the maximum of $\delta(n, k)$ also does not have quadratic term but has a linear term $-2(m-1)n$, and the reference surface R verifies the conjecture.

6.7. Matching the growth rate to topology for Montesinos knots. Let $K(r_0, \dots, r_m)$ be a Montesinos knot satisfying the assumptions of Theorem 1.3, and let $P(q_0, \dots, q_m)$ be the associated pretzel knot. Similar to the case of pretzel knots, we define a surface $S(M, x^*)$ where

$$x_i^* = \frac{(q_i - 1)^{-1}}{\sum_{j=1}^m (q_j - 1)^{-1}}. \quad (49)$$

We give the explicit description of the surface in terms of an edge-path system from the Hatcher-Oertel algorithm below. We will see that these surfaces are built from extending the surfaces of the associated pretzel knots.

6.7.1. The surface $S(M, x^*)$. The edge-path system of $S(M, x^*)$ is described as follows.

For $i = 0$, say $r_0 = [0, a_1, a_2, \dots, a_{\ell_{r_0}}]$ the unique even length continued fraction expansion for $a_j < 0, 1 \leq j \leq \ell_{r_0}$, we take the following continued fraction expansion

$$r_0 = \left[[-1, \underbrace{-2, \dots, -2}_{-a_1-1 \text{ times}}, a_2 - 1 - 1, \underbrace{-2, \dots, -2}_{-a_3-1 \text{ times}}, a_{2j} - 1 - 1, \underbrace{-2, \dots, -2}_{-a_{2j+1}-1 \text{ times}}, \dots, a_{\ell_{r_0}} - 1 \right], \quad (50)$$

with corresponding edge-path (reading backwards from the continued fraction expansion)

$$\langle [[-1, -2, \dots, a_{\ell_{r_0}} - 1]] \rangle \text{---} \dots \text{---} \langle [[-1, -2, -2]] \rangle \text{---} \langle [[-1, -2]] \rangle \text{---} \langle -1 \rangle.$$

For $1 \leq i \leq m$, say $r_i = [0, a_1, a_2, \dots, a_{\ell_{r_i}}]$ for $a_j > 0, 1 \leq j \leq \ell_{r_i}$, we take the following continued fraction expansion

$$r_i = \left[[0, -a_1 - 1, \underbrace{-2, \dots, -2}_{a_2-1 \text{ times}}, -a_3 - 1 - 1, \underbrace{-2, \dots, -2}_{a_4-1 \text{ times}}, -a_{2j+1} - 1 - 1, \underbrace{-2, \dots, -2}_{a_{2j+2}-1 \text{ times}}, \dots, \underbrace{-2, \dots, -2}_{a_{\ell_{r_i}}-1 \text{ times}} \right], \quad (51)$$

with corresponding edge-path (reading backwards from the continued fraction expansion)

$$\left\langle \left[[0, -a_1 - 1, \dots, \underbrace{-2, \dots, -2}_{a_{\ell_{r_i}}-1 \text{ times}}] \right] \right\rangle \text{---} \dots \text{---} \langle [[0, -a_1 - 1, -2]] \rangle \text{---} \langle [[0, -a_1 - 1]] \rangle \text{---} \langle 0 \rangle.$$

We let M be the least common multiple of the denominators of $\{x_i^*\}$. We similarly have

Lemma 6.7. Let q_0, q_1, \dots, q_m be defined as they are for Theorem 1.3 for a Montesinos knot $K = K(r_0, \dots, r_m)$. Suppose $q = (q_0, q_1, \dots, q_m)$ is such that $s(q) \leq 0$. There is a candidate surface $S(M, x^*)$ for K from the Hatcher-Oertel algorithm with M sheets and C -coordinates

$$\{-M, Mx_1^*, Mx_2^*, \dots, Mx_m^*\}.$$

Proof. Let $K_i = Mx_i^*$ for $1 \leq i \leq m$, and $0 \leq K_0 \leq M, 2 \leq q \leq -q_0$ such that

$$K_0 + M(q - 2) = K_1(q_1 - 1), \quad (52)$$

We specify a candidate surface $S(M, x^*)$ in terms of edge-paths $\{\gamma_i\}_{i=0}^m$, by tacking onto the existing edge-path system for the associated pretzel knot $P(q_0, q_1, \dots, q_m)$:

The edge-path γ_0 for r_0 from (50) is

$$\langle [[-1, -2, \dots, a_{\ell_{r_0}} - 1]] \rangle \text{---} \dots \text{---} \left\langle \frac{-1}{-q_0} \right\rangle \text{---} \left\langle \frac{-1}{-q_0 - 1} \right\rangle \text{---} \dots \text{---} \frac{K_0}{M} \left\langle \frac{-1}{q} \right\rangle + \frac{M - K_0}{M} \left\langle \frac{-1}{q - 1} \right\rangle.$$

For $i \neq 0$, we have the edge-path γ_i from (51):

$$\left\langle \left[[0, -a_1 - 1, \dots, \underbrace{-2, \dots, -2}_{a_{\ell_{r_i}}-1 \text{ times}}] \right] \right\rangle \text{---} \dots \text{---} \left\langle \frac{1}{q_i} \right\rangle \text{---} \frac{K_i}{M} \left\langle \frac{1}{q_i} \right\rangle + \frac{M - K_i}{M} \left\langle \frac{0}{1} \right\rangle.$$

Provided that K_0, q satisfying (52) exist, this edge-path system satisfies the equations coming from (a) and (b) of Step (2) of the algorithm. We have already verified that K_0, q exist when $s(q) \leq 0$ in Lemma 6.3. Thus, there is a candidate surface with $\{-M, Mx_1^*, Mx_2^*, \dots, Mx_m^*\}$ as the C -coordinates in the tangle corresponding to r_i . \square

We also define a reference surface R for $K(r_0, r_1, \dots, r_m)$.

6.7.2. The reference surface R . For the reference surface R , we have for each r_i , the edge-path system corresponding to the following continued fraction expansion

For $r_0 = [0, a_1, a_2, \dots, a_{\ell_{r_0}}]$ for $a_j < 0$, $1 \leq j \leq \ell_{r_0}$, we take the following continued fraction expansion.

$$r_0 = \left[[0, -a_1, a_2 - 1, \underbrace{-2, \dots, -2}_{-a_3 - 1 \text{ times}}, a_4 - 1 - 1, \underbrace{-2, \dots, -2}_{-a_5 - 1 \text{ times}}, a_{2j} - 1 - 1, \underbrace{-2, \dots, -2}_{-a_{2j+1} - 1 \text{ times}}, \dots, a_{\ell_{r_0}} - 1] \right], \quad (53)$$

with corresponding edge-path

$$\langle [0, -a_1, \dots, a_{\ell_{r_0}} - 1] \rangle \text{---} \dots \text{---} \langle [0, -a_1] \rangle \text{---} \langle 0 \rangle.$$

For $1 \leq i \leq m$, say $r_i = [0, a_1, a_2, \dots, a_{\ell_{r_i}}]$ for $a_j > 0$, $1 \leq j \leq \ell_{r_i}$, we take the following continued fraction expansion.

$$r_i = \left[[0, -a_1 - 1, \underbrace{-2, \dots, -2}_{a_2 - 1 \text{ times}}, -a_3 - 1 - 1, \underbrace{-2, \dots, -2}_{a_4 - 1 \text{ times}}, -a_{2j+1} - 1 - 1, \underbrace{-2, \dots, -2}_{a_{2j+2} - 1 \text{ times}}, \dots, \underbrace{-2, \dots, -2}_{a_{\ell_{r_i}} - 1 \text{ times}}] \right], \quad (54)$$

with corresponding edge-path

$$\left\langle [0, -a_1 - 1, \dots, \underbrace{-2, \dots, -2}_{a_{\ell_{r_i}} - 1 \text{ times}}] \right\rangle \text{---} \dots \text{---} \langle [0, -a_1 - 1, -2] \rangle \text{---} \langle [0, -a_1 - 1] \rangle \text{---} \langle 0 \rangle.$$

Again, both R and $S(M, x^*)$ are incompressible by a direct application of Proposition 6.2.

6.8. Proof of Theorem 1.3. Putting everything together we prove Theorem 1.3.

Proof. Let $K = K(r_0, \dots, r_m)$. Recall $q = (q_0, \dots, q_m) \in \mathbb{Z}^{m+1}$ denotes the associated tuple of integers to (r_0, \dots, r_m) where $q_i = r_i[1] + 1$ for $1 \leq i \leq m$ and

$$q_0 = \begin{cases} r_0[1] - 1 & \text{if } \ell_{r_0} = 2 \text{ and } r_0[2] = -1, \\ r_0[1] & \text{otherwise} \end{cases}.$$

from the unique even length positive continued fraction expansions of r_i 's, and q'_0 is an integer that is defined to be 0 if $r_0 = 1/q_0$, and defined to be $r_0[2]$ otherwise. Theorem 5.4 gives js_K and jx_K in terms of the Jones slope js_P and the normalized Euler characteristic jx_P of the associated pretzel knot $P = P(q_0, q_1, \dots, q_m)$. Depending on the signs of $s(q)$ and $s_1(q)$ we have three cases by Theorem 1.2.

(1) If $s(q) < 0$, then

$$\text{js}_P(n) = -2s(q), \quad \text{jx}_P(n) = -2s_1(q) + 4s(q) - 2(m - 1).$$

(2) If $s(q) = 0$, then

$$\text{js}_P(n) = 0, \quad \text{jx}_P(n) = \begin{cases} -2(m - 1) & \text{if } s_1(q) \geq 0 \\ -2s_1(q) - 2(m - 1) & \text{if } s_1(q) < 0 \end{cases}.$$

(3) If $s(q) > 0$, then

$$js_P(n) = 0, \quad jx_P(n) = -2(m-1).$$

When $s(q) = 0$ and $s_1(q) \geq 0$, or $s(q) > 0$, applying Theorem 5.4 we get

$$js_K(n) = -q'_0 - [r_0] - \omega(D_P) + \omega(D_K) + \sum_{i=1}^m (r_i[2] - 1) + \sum_{i=1}^m [r_i]$$

and

$$jx_K(n) = -2(m-1) - 2\frac{q'_0}{r_0[2]} + 2[r_0]_o - 2\sum_{i=1}^m (r_i[2] - 1) - 2\sum_{i=1}^m [r_i]_e.$$

The reference surface R is easily seen to verify the strong slope conjecture using [FKP11], by viewing it as a *state surface*. Since this material is well-known, we will briefly describe what a state surface is and indicate the state surface corresponding to the reference surface R .

A state surface from a Kauffman state σ on a link diagram D is a surface that comes from filling in the state circles of the σ -state graph D_σ by disks and replacing the segments recording the original locations of the crossings by twisted bands.

With the standard diagram that we are using for a Montesinos knot $K(r_0, \dots, r_m)$ with $r_0 < 0 < r_1, \dots, r_m$, the reference surface R is the state surface that comes from the Kauffman state which chooses the A -resolution on the negative twist region $1/r_0[1]$ (or $1/(r_0[1] - 1)$ if $r_0 = 1/q_0$) in the negative tangle corresponding to r_0 , and the B -resolution everywhere else. Using [FKP11], [Lee] shows that

$$bs(R) = -q'_0 - [r_0] - \omega(D_P) + \omega(D_K) + \sum_{i=1}^m (r_i[2] - 1) + \sum_{i=1}^m [r_i],$$

and

$$2\frac{\chi(R)}{\#R} = -2(m-1) - 2\frac{q'_0}{r_0[2]} + 2[r_0]_o - 2\sum_{i=1}^m (r_i[2] - 1) - 2\sum_{i=1}^m [r_i]_e.$$

We use this fact to prove that $S(M, x^*)$ realizes the strong slope conjecture when the reference surface R does not realize the Jones slope.

When $s(q) < 0$ or $s(q) = 0$ and $s_1(q) < 0$, the candidate surface $S(M, x^*)$ exists by Lemma 6.3. It suffices to verify that

$$js_K - bs(R) = tw(S(M, x^*)) - tw(R)$$

for the part of the strong slope conjecture concerning relationship of js_K to boundary slopes. This is because if the equation is true, then

$$js_K - (tw(R) - tw(S_0)) = tw(S(M, x^*)) - tw(R),$$

where S_0 is a Seifert surface from the Hatcher-Oertel algorithm, by (39). Rearranging terms in the equation gives

$$js_K = tw(S(M, x^*)) - tw(S_0) = bs(S(M, x^*)).$$

By Theorem 5.4,

$$\text{js}_K - \underbrace{\left(-q'_0 - [r_0] - \omega(D_P) + \omega(D_K) + \sum_{i=1}^m (r_i[2] - 1) + \sum_{i=1}^m [r_i] \right)}_{\text{bs}(R)} = \text{js}_P.$$

Notice that the edge-path systems of the two surfaces $S(M, x^*)$ (from (50), (51)) and R (from (53), (54)) coincide beyond the first segments of their edge-path systems, which define candidate surfaces $S_P(M, x^*)$ and the reference surface R_P for the associated pretzel knot P . Now by Theorem 6.5, we have

$$\text{js}_P = \text{tw}(S_P(M, x^*)) - \text{tw}(R_P).$$

Since $S(M, x^*)$ and R are identical beyond the first edges of their edge-path systems, we get

$$\text{tw}(S_P(M, x^*)) - \text{tw}(R_P) = \text{tw}(S(M, x^*)) - \text{tw}(R),$$

and we are done.

The proof that $\text{jx}_K = \frac{2\chi(S(M, x^*))}{\#S(M, x^*)}$ is similar. □

ACKNOWLEDGMENTS

S.G. wishes to thank Shmuel Onn for enlightening conversations on quadratic integer programming and for the structure of the lattice optimizers in Proposition 4.4. C.L. would like to thank the Max-Planck Institute for Mathematics in Bonn for excellent working conditions where the bulk of this work was conceived.

REFERENCES

- [Arm13] Cody Armond, *The head and tail conjecture for alternating knots*, *Algebr. Geom. Topol.* **13** (2013), no. 5, 2809–2826.
- [BMT18] Kenneth L Baker, Kimihiko Motegi, and Toshie Takata, *The strong slope conjecture for graph knots*, arXiv:1809.01039, 2018.
- [Bon79] Francis Bonahon, *Involution et fibrés de Seifert dans les variétés de dimension 3*, Ph.D. thesis, Orsay, 1979.
- [BS] Francis Bonahon and L. C. Siebenmann, *New geometric splittings of classical knots, and the classification and symmetries of arborescent knots*, <http://www-bcf.usc.edu/~fbonahon/Research/Preprints/BonSieb.pdf>, Preprint 2011.
- [BZ03] Gerhard Burde and Heiner Zieschang, *Knots*, second ed., *De Gruyter Studies in Mathematics*, vol. 5, Walter de Gruyter & Co., Berlin, 2003.
- [Con70] John Conway, *An enumeration of knots and links, and some of their algebraic properties*, *Computational Problems in Abstract Algebra (Proc. Conf., Oxford, 1967)*, Pergamon, Oxford, 1970, pp. 329–358.
- [Dun01] Nathan Dunfield, *A table of boundary slopes of Montesinos knots*, *Topology* **40** (2001), no. 2, 309–315.
- [FKP11] David Futer, Efstratia Kalfagianni, and Jessica S. Purcell, *Slopes and colored Jones polynomials of adequate knots*, *Proc. Amer. Math. Soc.* **139** (2011), no. 5, 1889–1896.
- [FKP13] David Futer, Efstratia Kalfagianni, and Jessica Purcell, *Guts of surfaces and the colored Jones polynomial*, *Lecture Notes in Mathematics*, vol. 2069, Springer, Heidelberg, 2013.
- [FO84] W. Floyd and U. Oertel, *Incompressible surfaces via branched surfaces*, *Topology* **23** (1984), no. 1, 117–125.

- [Gar11a] Stavros Garoufalidis, *The degree of a q -holonomic sequence is a quadratic quasi-polynomial*, Electron. J. Combin. **18** (2011), no. 2, Paper 4, 23.
- [Gar11b] ———, *The Jones slopes of a knot*, Quantum Topol. **2** (2011), no. 1, 43–69.
- [GHR16] Stavros Garoufalidis, Craig D. Hodgson, Neil R. Hoffman, and J. Hyam Rubinstein, *The 3D-index and normal surfaces*, Illinois J. Math. **60** (2016), no. 1, 289–352.
- [GvdV16] Stavros Garoufalidis and Roland van der Veen, *Quadratic integer programming and the slope conjecture*, New York J. Math. **22** (2016), 907–932.
- [Hak61] Wolfgang Haken, *Theorie der Normalflächen*, Acta Math. **105** (1961), 245–375.
- [Hat82] Allen Hatcher, *On the boundary curves of incompressible surfaces*, Pacific J. Math. **99** (1982), no. 2, 373–377.
- [Hat88] A. E. Hatcher, *Measured lamination spaces for surfaces, from the topological viewpoint*, Topology Appl. **30** (1988), no. 1, 63–88.
- [HO89] Allen Hatcher and Ulrich Oertel, *Boundary slopes for Montesinos knots*, Topology **28** (1989), no. 4, 453–480.
- [How] Joshua Howie, *Coiled surfaces and slope conjectures*, in preparation.
- [HT85] Allen Hatcher and William Thurston, *Incompressible surfaces in 2-bridge knot complements*, Invent. Math. **79** (1985), no. 2, 225–246.
- [IM07] Kazuhiro Ichihara and Shigeru Mizushima, *Bounds on numerical boundary slopes for Montesinos knots*, Hiroshima Math. J. **37** (2007), no. 2, 211–252.
- [Jon87] Vaughan Jones, *Hecke algebra representations of braid groups and link polynomials*, Ann. of Math. (2) **126** (1987), no. 2, 335–388.
- [Kau87] Louis H. Kauffman, *State models and the Jones polynomial*, Topology **26** (1987), no. 3, 395–407.
- [KL94] Louis H. Kauffman and Sóstenes L. Lins, *Temperley-Lieb recoupling theory and invariants of 3-manifolds*, Annals of Mathematics Studies, vol. 134, Princeton University Press, Princeton, NJ, 1994.
- [KL04] Louis H. Kauffman and Sofia Lambropoulou, *On the classification of rational tangles*, Adv. in Appl. Math. **33** (2004), no. 2, 199–237.
- [KT15] Efstratia Kalfagianni and Anh T. Tran, *Knot cabling and the degree of the colored Jones polynomial*, New York J. Math. **21** (2015), 905–941.
- [Lee] Christine Ruey Shan Lee, *Jones slopes and coarse volume of near-alternating links*, arXiv:1708.04900, to appear in Communications in Analysis and Geometry.
- [Lic97] W. B. Raymond Lickorish, *An introduction to knot theory*, Graduate Texts in Mathematics, vol. 175, Springer-Verlag, New York, 1997.
- [LT88] W. B. R. Lickorish and M. B. Thistlethwaite, *Some links with nontrivial polynomials and their crossing-numbers*, Comment. Math. Helv. **63** (1988), no. 4, 527–539.
- [LvdV] Christine Ruey Shan Lee and Roland van der Veen, *Colored Jones polynomials without tails*, Preprint 2018, arXiv:1806.04565.
- [LvdV16] ———, *Slopes for pretzel knots*, New York J. Math. **22** (2016), 1339–1364.
- [LYL19] Xudong Leng, Zhiqing Yang, and Ximin Liu, *The slope conjectures for 3-string Montesinos knots*, New York J. Math. **25** (2019), 45–70.
- [Mon73] José M. Montesinos, *Seifert manifolds that are ramified two-sheeted cyclic coverings*, Bol. Soc. Mat. Mexicana (2) **18** (1973), 1–32.
- [MT17] Kimihiko Motegi and Toshie Takata, *The slope conjecture for graph knots*, Math. Proc. Cambridge Philos. Soc. **162** (2017), no. 3, 383–392.
- [MV94] Gregor Masbaum and Pierre Vogel, *3-valent graphs and the Kauffman bracket*, Pacific J. Math. **164** (1994), no. 2, 361–381.
- [Oht01] Tomotada Ohtsuki, *Quantum invariants*, World Scientific, 2001.
- [Onn10] Shmuel Onn, *Nonlinear discrete optimization*, Zurich Lectures in Advanced Mathematics, European Mathematical Society (EMS), Zürich, 2010, An algorithmic theory.
- [Prz91] Józef H. Przytycki, *Skein modules of 3-manifolds*, Bull. Polish Acad. Sci. Math. **39** (1991), no. 1-2, 91–100.

- [TL71] H. N. V. Temperley and E. H. Lieb, *Relations between the “percolation” and “colouring” problem and other graph-theoretical problems associated with regular planar lattices: some exact results for the “percolation” problem*, Proc. Roy. Soc. London Ser. A **322** (1971), no. 1549, 251–280.
- [Tur88] Vladimir Turaev, *The Yang-Baxter equation and invariants of links*, Invent. Math. **92** (1988), no. 3, 527–553.
- [Wal67] Friedhelm Waldhausen, *Eine Klasse von 3-dimensionalen Mannigfaltigkeiten. I, II*, Invent. Math. **3** (1967), 308–333; *ibid.* **4** (1967), 87–117.
- [Wen87] Hans Wenzl, *On sequences of projections*, C. R. Math. Rep. Acad. Sci. Canada **9** (1987), no. 1, 5–9.
- [Zie84] Heiner Zieschang, *Classification of Montesinos knots*, Topology (Leningrad, 1982), Lecture Notes in Math., vol. 1060, Springer, Berlin, 1984, pp. 378–389.

MAX PLANCK INSTITUTE FOR MATHEMATICS, VIVATSGASSE 7, 53111 BONN, GERMANY
<http://people.mpim-bonn.mpg.de/stavros>
E-mail address: stavros@mpim-bonn.mpg.de

DEPARTMENT OF MATHEMATICS, UNIVERSITY OF SOUTH ALABAMA, MOBILE, AL 36608, USA
<https://sites.google.com/a/southalabama.edu/crslee/home>
E-mail address: crslee@southalabama.edu

MATHEMATISCH INTSTITUUT, LEIDEN UNIVERSITY, LEIDEN, NIELS BOHRWEG 1, THE NETHERLANDS
<http://www.rolandvdv.nl>
E-mail address: r.i.van.der.veen@math.leidenuniv.nl