

**Development of Vaccine Candidates
Against Emerging Bacteria
via Chemical Syntheses of Antigens**

Inaugural-Dissertation
to obtain the academic degree
Doctor rerum naturalium (Dr. rer. nat.)

Submitted to the Department of Biology, Chemistry and Pharmacy
of Freie Universität Berlin

by
Dacheng Shen

From Zhejiang, China

2019

This work was performed between August 2016 and December 2019 under the supervision of Prof. Dr. Peter H. Seeberger in the Department of Biomolecular Systems, Max Planck Institute of Colloids and Interfaces Potsdam, and the Department of Biology, Chemistry and Pharmacy, Freie Universität Berlin.

1st Reviewer: Prof. Dr. Peter H. Seeberger

2nd Reviewer: Prof. Dr. Kevin Pagel

Date of oral defense:

Acknowledgement

First of all, I want to express my deepest gratitude to my supervisor and mentor, Prof. Dr. Peter H. Seeberger for giving me the chance to perform my work in his group. His inspiration and encouragement has enabled me to think and work creatively, independently, efficiently and happily. This thesis could never have been completed without his invaluable suggestions and support during my work.

I would also like to thank Prof. Dr. Kevin Pagel for kindly agreeing to review my thesis.

I want to dedicate my thankfulness to my colleagues and friends in the Vaccine group, especially Dr. Maria Bräutigam, Mauro Sella, Shuo Zhang, Dr. Madhu Emmadi and Dr. Petra Ménová of the same lab for providing a friendly and helpful working environment; Bruna Seco for cooperation on the project; Dr. Feifei Xu, Mónica Guberman, Xiaopeng Zou, Guangzong Tian, Juntao Cai, Dr. Someswara Sanapala, Dr. Michael Downey, Dr. Julinton Sianturi, Dr. Abragam Joseph, Sabrina Leichnitz, Dr. Paulina Kaplonek, Katrin Sellrie and Annette Wahlbrink for their invaluable help.

I must thank Dr. Daniel Varón Silva, Dr. Yuntao Zhu, Yang Yu and Dr. Jamal Malik for a lot of beneficial suggestions which motivated me a lot during my research; Dr. Christian Roth for cooperation; Dr. Martina Delbianco, Dr. Bartholomäus Pieber, Dr. Kerry Gilmore, Dr. Oren Moscovitz, Dr. Felix Löffler and Dr. Fabian Pfrengle for their interesting and helpful points of view. I also need to express my gratitude to Dr. Maria Bräutigam for translation of the abstract into German, and to Dr. Jamal Malik, Dr. Daniel Varón Silva, Dr. Yuntao Zhu, Dr. Julinton Sianturi, Bruna Seco, Shuo Zhang and my parents for their precious suggestions for this thesis.

I am also grateful to our technicians Eva Settles, Olaf Niemeyer, Felix Hentschel and Sabine Siegmund, and our secretary Dorothee Böhme for their help in my work and life.

Thank all the other members in the Department of Biomolecular Systems for having an amazing time in the past three and a half years with you.

Last but not least, I must thank my parents and fiancée for their love, understanding and support for my research work.

Table of Contents

TABLE OF CONTENTS	I
ABBREVIATIONS	III
ABSTRACT	V
ZUSAMMENFASSUNG	VII
1 INTRODUCTION	1
1.1 MULTIDRUG-RESISTANT INFECTIOUS BACTERIA	1
1.1.1 <i>Bacteria and Infectious Diseases</i>	1
1.1.2 <i>Antibiotics and Antibiotic Resistance</i>	2
1.1.3 <i>Emergence of the Current Situation and Possible Solutions</i>	3
1.2 IMMUNE SYSTEM AND VACCINES	4
1.2.1 <i>Antigens and Immune Response</i>	4
1.2.2 <i>Vaccines and Glycoconjugate Vaccines</i>	5
1.3 DEVELOPMENT OF THE VACCINES VIA CHEMICAL SYNTHESIS	8
1.4 SYNTHETIC SUGAR CHEMISTRY	10
1.4.1 <i>Monosaccharide Modifications</i>	11
1.4.2 <i>Glycosylations to Construct Complex Oligosaccharids</i>	13
1.5 GOAL AND OBJECTIVES OF THIS THESIS	15
2 DEVELOPMENT OF A VACCINE CANDIDATE AGAINST <i>KLEBSIELLA PNEUMONIAE</i> ST 258	17
2.1 INTRODUCTION.....	17
2.2 RESULTS AND DISCUSSIONS.....	20
2.2.1 <i>Retro-synthetic Analysis of Oligosaccharides 2-1 and 2-2</i>	20
2.2.2 <i>Total Synthesis of the Trisaccharide Epitope 2-1</i>	22
2.2.3 <i>Total Synthesis of the Hexasaccharide Epitope 2-2</i>	27
2.2.4 <i>Evaluation of the Synthesized Epitopes by Glycan Array</i>	30
2.2.5 <i>Immunological Evaluation of Epitopes 2-1 and 2-2</i>	31
2.3 CONCLUSION AND OUTLOOK.....	34
3 DEVELOPMENT OF VACCINE CANDIDATES AGAINST <i>STREPTOCOCCUS SUI</i> 3 AND 18	35
3.1 INTRODUCTION.....	35
3.2 RETROSYNTHETIC ANALYSIS OF THE CHEMICAL SYNTHESSES OF 3-1, 3-2 AND 3-3	37

Table of Contents

3.3	RESULTS AND DISCUSSIONS.....	39
3.3.1	<i>Study of the Synthesis of the Epitopes from SS3.....</i>	39
3.3.2	<i>Study of the Synthesis of the Epitope from SS18.....</i>	45
3.4	CONCLUSION AND OUTLOOKS	49
4	EXPERIMENTAL SECTION.....	51
4.1	REAGENTS AND GENERAL PROCEDURES.....	51
4.2	CHEMICAL SYNTHESIS FOR THE EPITOPES FROM KPST258.....	52
4.3	CONJUGATION OF THE ANTIGENS	81
4.4	METHODS FOR IMMUNOLOGICAL EVALUATIONS	84
4.5	CHEMICAL SYNTHETIC STUDY ABOUT SS3 AND SS18	86
4.6	SPECTRA OF IMPORTANT COMPOUNDS	122
5	REFERENCES.....	129

Abbreviations

Å	angstrom, 10^{-10} m
Ac	acetyl
All	allyl
aq.	aqueous
Ar	aromatic
Bn	benzyl
Bu	butyl
Bz	benzoyl
c	concentration
CAN	ceric (IV) ammonium nitrate
cat.	catalytic
Cbz	benzyloxycarbonyl
CSA	camphorsulfonic acid
CPS	capsular polysaccharide
δ	chemical shift
d	doublet
DBU	1,8-diazabicyclo[5.4.0]undec-7-ene
DDQ	2,3-dichloro-5,6-dicyano-1,4-benzoquinone
DIPEA	diisopropylethylamine
DMAP	4-(<i>N,N</i> -dimethylamino)pyridine
DMF	<i>N,N</i> -dimethylformamide
DMSO	dimethylsulfoxide
EDC	<i>N</i> -(3-dimethylaminopropyl)- <i>N'</i> -ethylcarbodiimide
eq.	equivalent
ESI	electrospray ionization
Et	ethyl
Fmoc	9-fluorenylmethyloxycarbonyl <i>N</i> -acetyl fucosamine
Gal	galactose
Glc	glucose
GlcA	glucuronic acid
GlcNAc	<i>N</i> -acetyl glucosamine
GPI	glycosylphosphatidylinositol
h	hour(s)
HRMS	high resolution mass spectroscopy
Hz	hertz
Ig	immunoglobulin
IR	infrared spectroscopy
<i>J</i>	coupling constant
Lev	levulinoyl
LevOH	levulinic acid
m	multiplet
M	molar

Abbreviations

MALDI	matrix assisted laser desorption/ionization
Man	mannose
Me	methyl
min	minute(s)
MP	<i>para</i> -methoxyphenyl
MS	molecular sieves
Nap	2-naphthylmethyl
NBS	<i>N</i> -bromosuccinimide
NIS	<i>N</i> -iodosuccinimide
nm	nanometer
NMR	nuclear magnetic resonance
PBB	<i>para</i> -bromobenzyl
PG	protecting group
Ph	phenyl
Piv	pivaloyl
PMB	<i>para</i> -methoxybenzyl
ppm	parts per million
Pr	propyl
quant.	quantitative
Rha	rhamnose
r.t.	room temperature
s	singlet
t	triplet
TBAF	tetrabutylammonium fluoride
TBAI	tetrabutylammonium iodide
TBS	<i>tert</i> -butyldimethylsilyl
TCA	trichloroacetimidate
TEMPO	(2,2,6,6-tetramethylpiperidin-1-yl)oxidanyl
Tf	trifluoromethanesulfonyl
TFA	trifluoroacetic acid
THF	tetrahydrofuran
TLC	thin layer chromatography
TMS	trimethylsilyl
ToF	time of flight
Tol	toluene
Ts	tosyl
TTBP	2,4,6-tri- <i>tert</i> -butylpyrimidine
PS	polysaccharide
<i>p</i>-TsOH	<i>para</i> -toluenesulfonic acid

Abstract

Bacterial infections have long been an ever-emerging problem with the appearance of antibiotic resistant bacteria which is deteriorating with the misuse and abuse of antibiotics. As infections of these emerging bacteria can hardly be treated, we are seeking a protective method to fight bacteria by the development of glycoconjugate vaccines. Chemical syntheses to obtain pure structures of the target antigens are essential for further glycobiology and immunity studies.

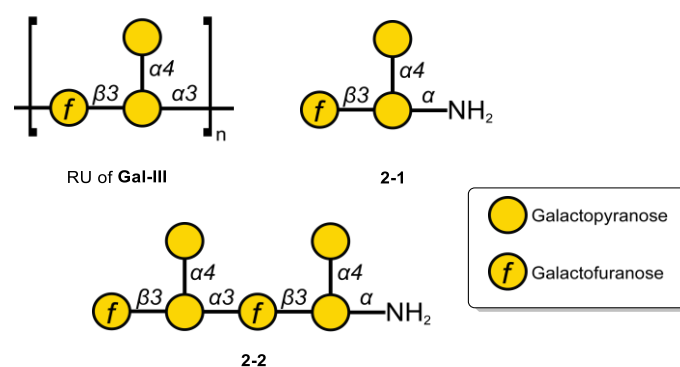

Figure 1 Repeating unit of KPST258 antigen Gal-III and designed epitopes as vaccine candidates

Chapter 2 describes my work on the development of the vaccine candidates against *Klebsiella pneumoniae* sequence type 258 (KPST258). This “super bug” can produce *K. pneumoniae* carbapenemases (KPC) to protect it from almost all the available antibiotics. I designed and synthesized the two structures, trisaccharide **2-1** containing one repeating unit and hexasaccharide **2-2** containing two repeating units. (**Figure 1**) The repeating unit contains a C3, C4-branched galactose with a galactofuranose connected to its C3 position. This kind of oligosaccharide had never been well studied and chemical synthesis to obtain such a dense branched structure in the hexasaccharide bridged via a galactofuranose at C1 and C3 positions has never been reported either. Each oligosaccharide carries an amino linker, making it possible for further glycan array tests or conjugation for immunization and other biological evaluations. In collaboration with Bruna M. S. Seco, we performed glycan array tests and found sera from infected patients contained antibodies against both **2-1** and **2-2**. The glycans were further conjugated to carrier protein CRM₁₉₇ for immunization tests. CRM₁₉₇-**2-2** triggered a robust immune response in rabbits, indicating that it is a promising vaccine candidate against *Klebsiella pneumoniae* ST258.

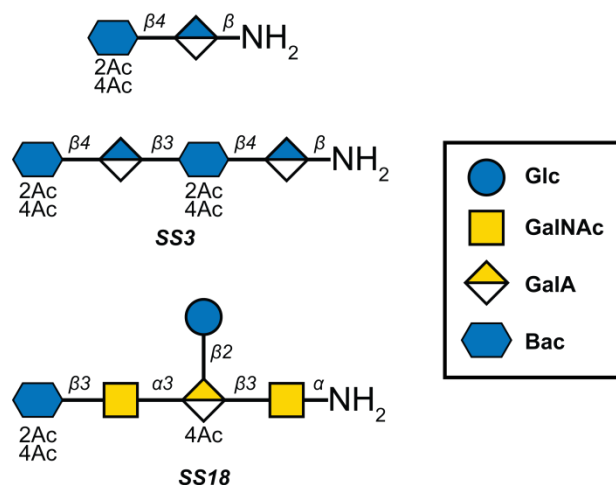

Figure 2 Antigens of *S. suis* serotypes 3 and 18

Chapter 3 describes my work regarding an important swine pathogen *Streptococcus suis*. This bacterium exists in almost every pig farm around the world. Huge economic loss has been caused every year in swine industry and humans can also be infected. We became interested in *S. suis* serotypes 3 and 18, and the antigens I have been developing contain rare and interesting bacillosamine residues. Chemical modification of L-Bacillosamine has never been reported before, so I did some pioneering study on this sugar structure, hoping to achieve a better understanding of its properties and provide some reference for possible future study. The experience with monosaccharide modifications can be applied in D-bacillosamine modification for the synthesis of *S. suis* antigens. The final antigens are not finished yet, but most of the synthetic problems have been solved including the most complicated parts to establish the synthesis routes to the target molecules. The last stage of the antigen syntheses and immunological evaluations will be investigated in the future.

Zusammenfassung

Bakterielle Infektionen sind durch das Auftreten von antibiotikaresistenten Bakterien zu einem zunehmenden Problem geworden. Dieser Prozess wird durch Fehlgebrauch und missbräuchlichen Einsatz von Antibiotika zusätzlich beschleunigt. Um ein wirksames Mittel gegen diese sich ausbreitenden, schwer zu behandelnden Bakterien zu haben, arbeiten wir an der Entwicklung von Glykokonjugat-Impfstoffen. Dabei liegt der Fokus auf der chemischen Synthese, da es essentiell ist, die Ziel-Antigene als reine Substanzen zu erhalten, um diese für biologische und immunologische Studien einsetzen zu können.



Abbildung 1 Wiederholeinheit des KPST258 Antigen Gal-III und Epitop-Fragmente, die potentielle Impfstoffe darstellen.

Kapitel 2 dieser Arbeit beschreibt die Entwicklung eines Impfstoff-Kandidaten gegen *Klebsiella pneumoniae* Sequenztyp 258 (KPST258). Dieses Bakterium wird auch als „Super-Keim“ bezeichnet, da es *K. pneumoniae* Carbapenemasen (KPC) produziert und es so gegen fast alle verfügbaren Antibiotika resistent ist. Es wurden zwei Verbindungen, das Trisaccharid **2-1**, das aus einer Wiederholeinheit besteht, und das Hexasaccharid **2-2**, das aus zwei Wiederholeinheiten aufgebaut ist, konzipiert und synthetisiert (**Abbildung 1**). Die Wiederholeinheit enthält eine Galactose, die an C3 und C4 verzweigt ist; in Position C3 ist eine Galactofuranose verknüpft. Diese Art von Struktur wurde noch nicht umfangreich untersucht und auch die Synthese des Hexasaccharids, das eine hohe Verzweigungs-Dichte aufweist und über die C1 und C3 Positionen in der Galactofuranose verknüpft ist, oder ähnlicher Strukturen wurde bis jetzt nicht in der Literatur beschrieben. Am reduzierenden Ende jedes Oligosaccharids wurde ein Linker mit einer Aminofunktion eingeführt, um die Glykane einfach an Oberflächen, z.B. für Glykan-Array, oder an Proteine, z.B. für Immunisierungen,

Zusammenfassung

koppeln zu können. In Zusammenarbeit mit Bruna M. S. Seco wurden Glykan-Arrays durchgeführt, die gezeigt haben, dass Seren von infizierten Patienten Antikörper enthalten, die die Strukturen **2-1** und **2-2** binden. Die Glykane wurden im nächsten Schritt für Immunisierungen an das Träger-Protein CRM₁₉₇ gekoppelt. Das CRM₁₉₇-**2-2**-Konjugat hat eine stabile Immunantwort in Kaninchen ausgelöst, was die Vermutung nahelegt, dass es sich bei dieser synthetischen Struktur um einen vielversprechenden Impfstoff-Kandidaten gegen KPST258 handelt.

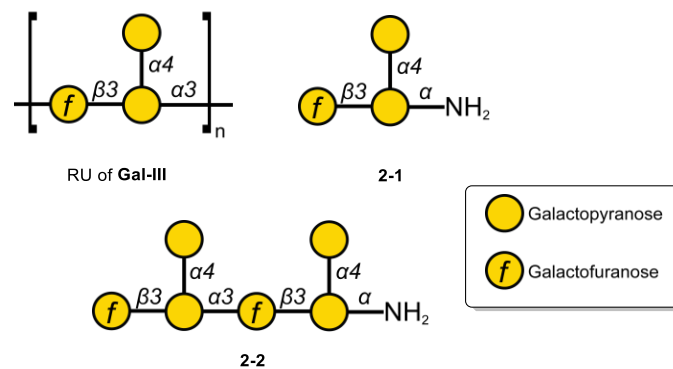

Abbildung 2 Antigene der *S. suis* Serotypen 3 und 18

In Kapitel 3 wird die Arbeit an dem wichtigen porzinen Pathogen *Streptococcus suis* beschrieben. Dieses Bakterium kann in nahezu jeder Schweinemast weltweit nachgewiesen werden. Dadurch kommt es jedes Jahr zu großen finanziellen Verlusten in der Schweinemast und auch Menschen können sich mit diesem Bakterium infizieren. Unser Interesse an *S. suis* Serotyp 3 und Serotyp 18 wurde geweckt, da die Antigene seltene Bacillosamin-Reste tragen. L-Bacillosamin ist nicht literaturbekannt, so dass in der vorliegenden Dissertation Pionierarbeit geleistet wurde, um die Eigenschaften dieser Struktur zu verstehen und um Referenzen für mögliche Arbeiten in der Zukunft zu liefern. Die Modifikationen des Monosaccharids könnten auch für die Synthese von *S. suis* Antigenen bei D-Bacillosamin zum Einsatz kommen. Aufgrund des begrenzten Zeitrahmens dieser Arbeit sind die finalen Antigene noch nicht fertiggestellt. Allerdings liegen für alle Probleme, die während der Synthese auftreten, Lösungsansätze bereit, inklusive den komplexesten Schritten, um die Syntheserouten für die Zielmoleküle zu etablieren. Die letzten Schritte der Antigen-Synthese und die immunologische Evaluation werden in naher Zukunft durchgeführt werden.

1 Introduction

1.1 Multidrug-Resistant Infectious Bacteria

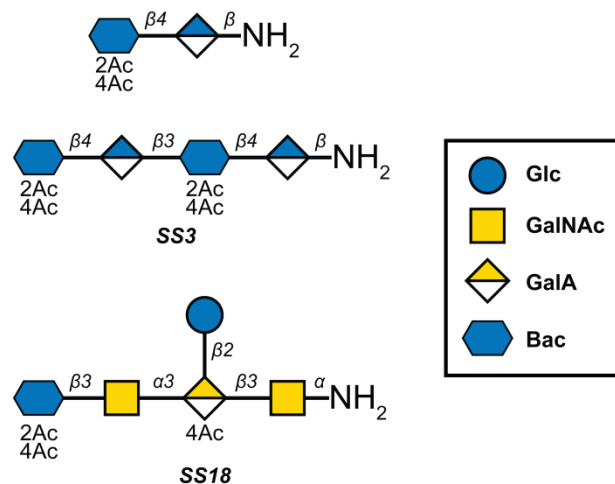
1.1.1 Bacteria and Infectious Diseases

Bacteria are ubiquitous around the world.¹ They were among the earliest forms of life that appeared on earth and nowadays they are not only everywhere in the environment: in soil, air, water etc., but also in plants and animals symbiotically or parasitically. While most bacteria are harmless to the human body thanks to our immunogenic system, many species are pathogenic and may cause infectious diseases like pneumoniae or meningitis. We call them pathogenic bacteria.²

Infectious diseases can be caused by different microbiomes among which pathogenic bacteria have been threatening human health worldwide since long ago.³ Invasions by bacteria into the host result in the host's disorders such as pneumonia, meningitis and food poisoning.⁴ Pathogens can be passed from one to another directly or indirectly causing disease outbreaks as well as deaths.⁵ A famous case was the infection of cholera that happened in September 1854 around Broad and Cambridge Streets in London. Water was polluted with the bacterium *Vibrio cholerae* (**Figure 3**) and within 10 days, more than 500 people were infected and killed. Though cholera infection is no longer a problem nowadays, a lot of other infectious diseases are still problematic around the world.⁶

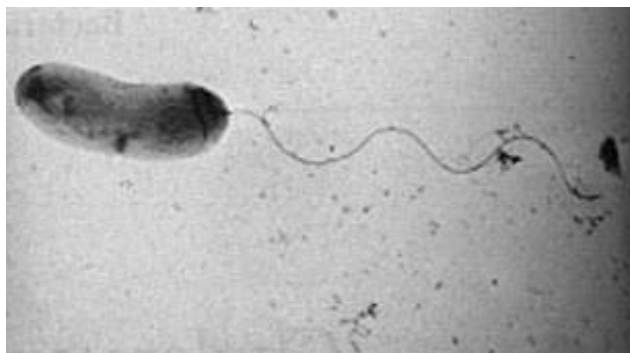

Figure 3 Electron micrograph of *Vibrio cholerae**

* Photo by Leodotia Pope, Department of Microbiology, University of Texas at Austin.

1.1.2 Antibiotics and Antibiotic Resistance

The discovery of Penicillin by Alexander Fleming, the earliest antibiotic used to cure bacterial infections in the 1920s, was a milestone in human history.⁷ The core structure of penicillin is the β -lactam 4-membered ring colored in red in **Figure 4**. β -Lactams can inhibit the cell wall synthesis of the bacteria and prevent them from reproducing.⁸

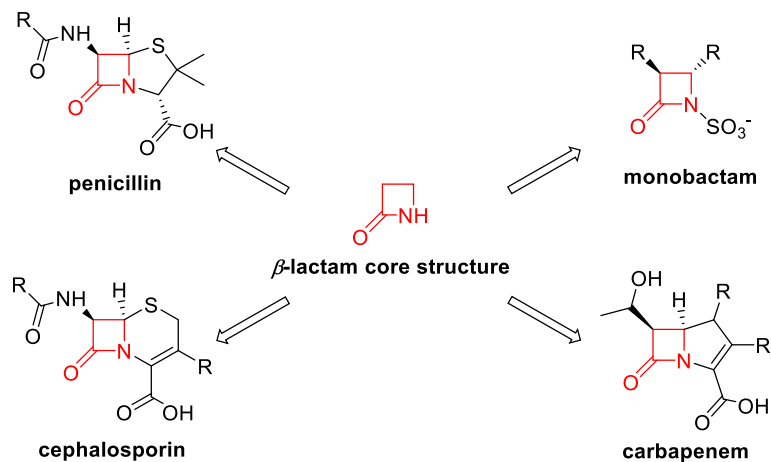

Figure 4 Structures of β -lactam antibiotics⁹

A lot of other antibiotics have been developed after penicillin and due to their wide-spectrum as well as high efficiency against different types of bacteria, they soon became widely used medicines for the prevention and treatment of almost all kinds of bacterial infections.¹⁰

However, there is the other side of the coin: the development of antibiotic resistance of the bacteria. Antibiotic resistance appears naturally as a result of the selection of survived bacteria by the antibiotics, but has been greatly accelerated because of people's misuse and abuse of these drugs.¹¹ Although regulations have been established to prevent antibiotic resistance from developing too fast among the bacteria, it has already been a threat to human health worldwide: more multidrug resistant (MDR) bacteria are identified and infections of these bacteria become more and more challenging for treatment.¹²

Bacteria have several mechanisms to resist antibiotics: a) they can produce antibiotic hydrolyzing enzymes such as β -lactamases that can catalyze the hydrolysis of β -lactams; b) they can alternate their binding site of the antibiotics so they will not be

targeted; c) they can change the metabolic pathways that are inhibited by antibiotics; d) they can pump the antibiotic molecules out of their cells to avoid the damage they might suffer.¹³ (Figure 5)

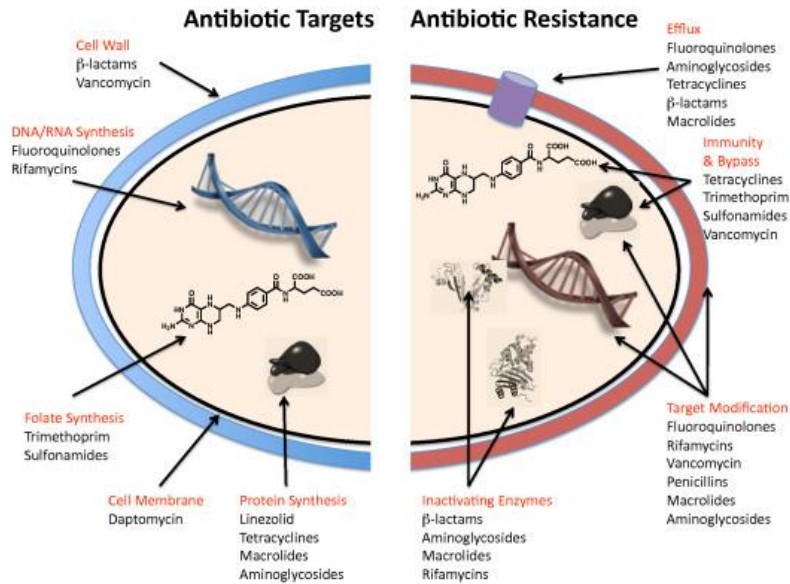

Figure 5 Antibiotic targets and mechanisms of resistance¹⁴

1.1.3 Emergence of the Current Situation and Possible Solutions

Decades have passed since the golden era of antibiotics from 1930s to 1960s, yet research into new antibiotic development has failed to follow the pace of the bacteria that are becoming increasingly resistant. At the end of April 2014, the world health organization (WHO) revealed its first report to the public on the antibiotic resistance with data of more than 100 countries, announcing the emergency of new methods to control the lethal and worldwide spread MDR bacteria or “superbugs”.¹⁵

Antibiotics are vital in preventing infections following surgeries. It is estimated that almost half of the surgical infections are caused by resistant bacteria; they also make infections more difficult to treat thus higher morbidity and mortality; domestic animals like pets or livestock can be infected as well, causing huge economic loss worldwide. A study has shown that almost 2 million people in the US get infected under hospital-acquired conditions every year among which 99,000 die and the antibiotic-

Introduction

resistant pathogens play an important role in most cases; in Europe, 25,000 people die every year because of MDR bacterial infections.¹⁶

Besides controlling the infections by regulation to limit the use of antibiotics to proper situations, many people are also trying to develop new kinds of antibiotics. However, risks still exist that bacteria soon gain resistance again and it becomes even harder to treat the infection. A better way to fight against the superbugs could be a protective way to help us prevent the infection of bacteria through vaccination.¹⁷

1.2 Immune System and Vaccines

Vaccines are used to trigger the immune system by simulating the invasion of pathogens so the body can get prepared and respond fast once the specific pathogens are detected in the future. To explain the mechanism of how a bacterial vaccine works, I start from bacterial polysaccharides and the immune response.

1.2.1 Antigens and Immune Response

The surface of the bacterial cell is covered with a thick layer of conjugated sugars, including capsular polysaccharides (CPS) and lipopolysaccharides (LPS).¹⁸ These sugars are important virulence factors as well as recognition receptors for the immune system, termed antigens.¹⁹ Antigens can be unspecifically recognized by the innate immune system via pattern recognition receptors (PRR) and thus eliminated.²⁰ In some cases, the innate immune response is not efficient enough. In addition, non-specific recognition does not have memory effect. In order to provide efficient and long-period protection against some particular bacteria, we need to take advantage of the adaptive immune system. After a B cell has digested the antigen, it can produce a complex containing the antigen fragments called major histocompatibility complex (MHC) molecules.²¹ Helper T cells can not recognize antigens directly but can mature if prompted by MHC molecules.

Differing from innate immune system, the adaptive immune system is specific in dealing with foreign antigens. Antigen presentation mediated by MHC can initiate this process where both B and T lymphocytes (white blood cells) are involved. B cells mature into plasma cells which can produce antibodies to mark or block the invader with matched antigens. T cells can become helper T cells or killer T cells (cytotoxic T

lymphocytes or CTLs). Helper T cells are able to help activate B cells to produce antibodies, macrophages to smash target cells, and killer T cells can interact directly with the tagged cells and destroy them.²² (**Figure 6**)

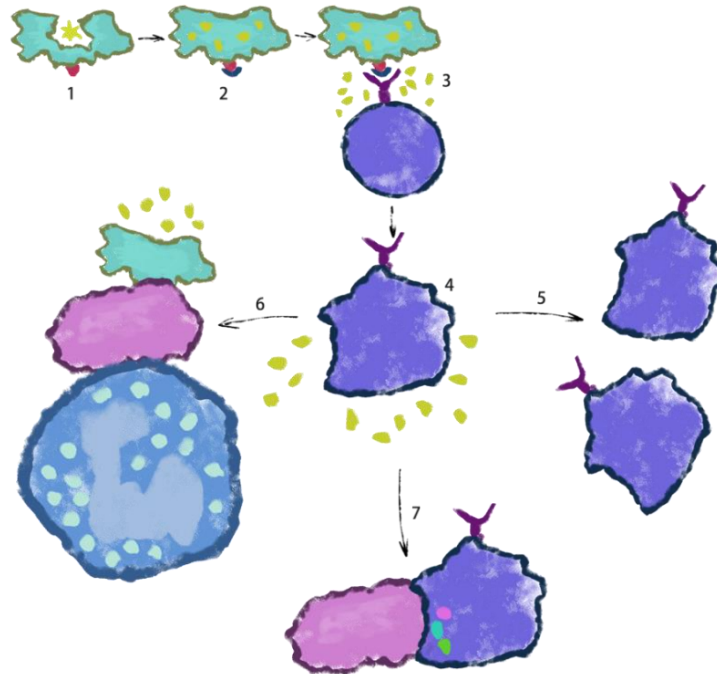

Figure 6 A brief progress of the adaptive immune response.²² 1. An antigen is digested by a macrophage or a B cell; 2. The antigen fragments are bounded to its MHC molecules; 3. The MHC molecules are displayed to a T cell helping it mature with the presence of lymphokines; 4. When a T cell is activated, it will secrete lymphokines; 5. Lymphokines will accelerate more T cells to mature; 6. Lymphokines will direct more other immune cells as fresh macrophages, granulocytes and other lymphocytes to the infection site to kill the infected cells; 7. Some T cells become killer T cells and kill the infected cells.

Importantly in addition, memory B cells and T cells will be generated during the initial response to the antigen. As a result, once the same antigen is recognized in the future, the immune response will be significantly accelerated, and this is the base of vaccination aiming to provide a protective way to fight against infectious diseases.²³

1.2.2 Vaccines and Glycoconjugate Vaccines

People in ancient China had already learned to prevent smallpox by inoculating the pus from smallpox patients.²⁴ The scientific practice was adopted by Edward Jenner, who studied the prevention of smallpox by inoculating his family with cowpox pus.²⁵ Since then, a large number of vaccines have been developed to help us control the infectious diseases efficiently.²⁶ There are several types of vaccines including attenuated

Introduction

vaccines, inactivated vaccines, subunit vaccines, recombinant vaccines and DNA vaccines, and for bacterial vaccines one of the most successful stories belongs to the glycoconjugate vaccines.²⁷

As mentioned in the previous part, bacterial pathogens are usually covered by capsular sugars that are essential in protecting these organisms and acting as a recognizer of specific antibodies.²⁸ Different kinds of bacterial vaccines were developed for preventing infectious diseases such as pneumonia and meningitis, using the unconjugated capsular polysaccharides based on this knowledge in the late 20th century.²⁹ However, it was soon noticed that these vaccines were unable to trigger the immune response of young children, infants or immune-compromised individuals. Polysaccharide vaccines did not raise memory effect after repeated doses which prevented people in gaining long-period protection.³⁰

Glycoconjugate vaccines where the antigens were conjugated with carrier proteins solved this problem.³¹ Polysaccharides (PS) are T cell independent antigens and only stimulate B cells by cross-linking their receptors. B cells are able to process glycoconjugate vaccines on the other hand, by internalizing them into the specific MHC II molecules and presenting them to T cells. In this case, B cells can mature into memory cells and produce antigen-specific IgG to help with long-term protection.³²

The development of glycoconjugate has succeeded in helping people fight against bacterial infections and many vaccines are already commercially available. Examples of the glycoconjugate vaccines licensed by FDA as well as some brief information are listed in **Table 1**.³³

Table 1 Glycoconjugate vaccines licensed by FDA³³

Pathogen	Commercial trade name /manufacturer	Carrier protein	Saccharide chain length	Conjugation chemistry
<i>Haemophilus influenzae</i> type B	ActHIB/Sanofi Pasteur (monovalent)	TT	Native polysaccharide	Information not available
	Hiberix/GSK vaccines	TT	Size-reduced polysaccharide	Information not available
	Quinvaxem/GSK vaccines (multivalent formulation containing DTP, HepB and Hib conjugate)	CRM ₁₉₇	Depolymerized polysaccharide	Active ester chemistry
	PedvaxHIB/Merck	OMPC	Native polysaccharide	Information not available
<i>Neisseria meningitidis</i> serogroup C	NeisVac-C/Pfizer	TT	Native polysaccharide	Reductive amination
	Meningitec/Nuron Biotech	CRM ₁₉₇		Reductive amination
	Menjugate/GSK vaccines	CRM ₁₉₇	Depolymerized polysaccharide	Active ester chemistry
	Menitorix/GSK vaccines (with Hib)	TT	Size-reduced polysaccharide	Information not available
<i>Neisseria meningitidis</i> serogroup CY	MenHibrix/GSK vaccines (with Hib)	TT		Information not available
<i>Neisseria meningitidis</i> serogroup ACWY	Menactra/Sanofi Pasteur	DT	Depolymerized polysaccharide	Information not available
	Menveo/GSK	CRM ₁₉₇	Depolymerized polysaccharide	Active ester chemistry
	Nimenrix/Pfizer	TT	Size-reduced polysaccharide	Active ester chemistry
<i>Streptococcus pneumoniae</i> serogroup 4, 6B, 9V, 14, 18C, 19F, 23F	Prenar/Pfizer	CRM ₁₉₇	Native polysaccharide	Reductive amination
<i>Streptococcus pneumoniae</i> serogroup 1, 4, 5, 6B, 7F, 9V, 14, 18C, 19F, 23F	Synflorix/GSK	NTHi PD, DT, TT	Size-reduced polysaccharide	Reductive amination

The most important part of the glycoconjugate vaccines are the antigens where specific oligosaccharides are conjugated to non-toxic carrier proteins.³⁴ We can get the specific oligosaccharides needed for conjugation from natural sources. However, isolation and purification remain the most challenging steps even today.³⁵ Synthetic carbohydrate chemistry is promising in the search for a more efficient way to access the antigens via chemical synthesis of the glycan from a specific bacterial antigen, as this

process can provide a precise structure thus much better reproducible biological properties and safety.³⁶

1.3 Development of the Vaccines via Chemical Synthesis

Sugar chemistry is the key to obtaining an oligosaccharide with the desired structure by chemical synthesis. **Figure 7** shows a brief process step by step of how to develop glycoconjugate vaccines via chemical synthesis in the Seeberger lab.

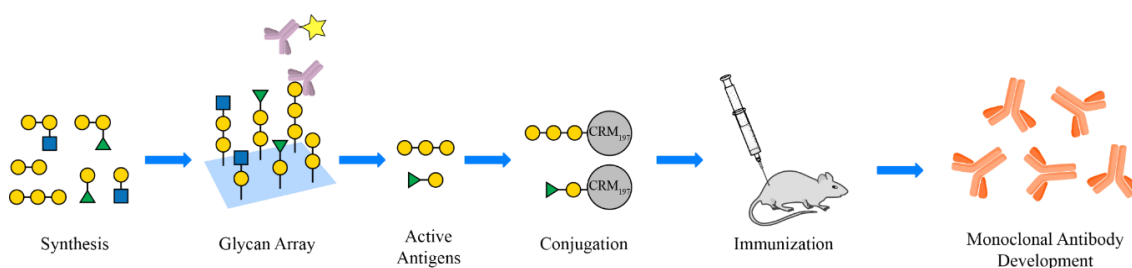

Figure 7 Development of the vaccine via chemical synthesis*

Based on the knowledge from the characterization work where the structures of promising antigens were determined, we start by chemical syntheses of the oligosaccharides to obtain the sugar candidates which usually contain one or two repeating units. The advantage of chemical synthesis is that we are able to determine the structure using modern analyzing methods such as mass spectroscopy (MS), optical rotation (OR), infrared spectroscopy (IR) and nuclear magnetic resonance (NMR) to make sure the compounds we have prepared are correct and pure.

Unlike the isolated oligosaccharides, the high purity and homogeneity of the glycan synthesized allows for a better repeatability in further immunological experiments. Chemical synthesis also allows us to study the properties of the glycan more flexibly by doing modification at the positions we wish, changing the length of the sugar chain or switching the order of the monosaccharide residues in the repeating unit.

The reducing end of the oligosaccharide is usually anchored to the hydroxyl group of a bifunctionalized alkyl linker, where the other end is an amino group. Immobilization of the amino end makes it possible for us to evaluate the sugar with

* Figure illustrated by Dacheng Shen and Dr. Maria Bräutigam.

glycan array technology, or conjugate it to a carrier protein for further immunization and other biological evaluations.

Glycan array screening is a standard technology to study the interactions between glycans and proteins, and a very useful high-throughput method to identify biomarkers or help vaccine development. With the glycan array screening platform established by the Seeberger group, it is very efficient to perform first immune tests of our synthetic sugars. First, the glycans are covalently immobilized onto a surface modified glass slide. Subsequent incubation with glycan-binding antibodies, labelling with a fluorescent secondary antibody and washing of unbound reagent is followed by further fluorescent read-out. The intensity of the fluorescence is quantified.³⁷

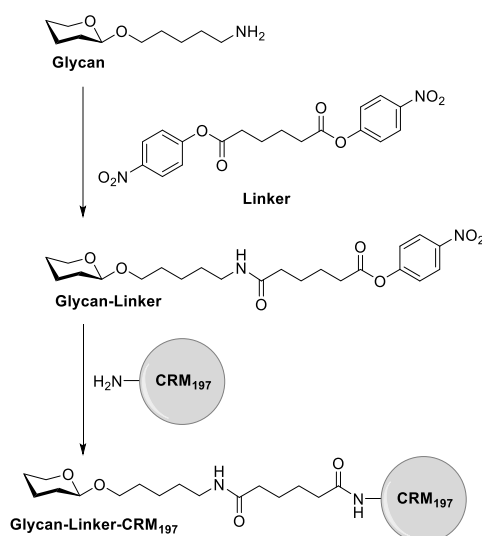

Scheme 1 Conjugation of the glycan to carrier protein CRM₁₉₇

Promising glycans will be conjugated to carrier proteins for further immunization and other biological experiments in animal models. Several different carrier proteins have already been applied in licensed vaccines such as TT (tetanus toxoid), DT (diphtheria toxoid) and CRM₁₉₇ (cross-reacting material 197).³⁸ The Seeberger group is using CRM₁₉₇ as the carrier protein which is a commercially available non-toxic mutant of diphtheria toxin isolated from *Corynebacterium diphtheria* strain C7 (β 197) cultures.³⁹ **Scheme 1** shows a commonly used method for the preparation of neo-glycoprotein. In this method, the linker is a homobifunctional reagent, p -nitrophenyl adipate ester (PNP), which performs as a bridge between the saccharide and the carrier protein to obtain the glycoconjugate vaccine candidate. Each

Introduction

CRM₁₉₇ protein molecule can react with several glycans to mimic the pathogen and to trigger an immune response.

With aluminum-based adjuvants such as Al(OH)₃,⁴⁰ the conjugated glycoprotein can be injected into animal models (most commonly mice or rabbits) for further immunological evaluation. The immune test usually includes prime injection of the vaccine candidate and a second injection after about two weeks to boost the immunity. Blood samples are collected at different time points and the immune response is indicated by the concentration of the corresponding antibody, which is determined by an enzyme-linked immunosorbent assay (ELISA).⁴¹ Effective vaccine candidates could go further for industrial vaccine development or monoclonal antibody development.

The chemical synthesis to provide the target oligosaccharide is vital within the workflow. Unlike DNA or protein where the primary structures of the molecules are linear, the number of potential linkages between sugar residues can be countless, with different hydroxyl groups and α/β selection on each sugar residue.⁴² The complexity grows exponentially if the glycan is highly branched. Chemical synthesis is a time-consuming step but the most important one from a chemistry point of view to approach the chemical synthesized glycoconjugate vaccine, and requires a deep understanding of the structure, careful design of the synthetic route, and many trials and modifications of reaction conditions or even pathway of synthesis. The knowledge of carbohydrate synthesis as well as practical experience is essential in performing experiments in this field.⁴³

1.4 Synthetic Sugar Chemistry

Synthetic sugar chemistry is the key to accomplishing the syntheses of different structurally well-defined oligosaccharides. Numerous complex glycans have been achieved including glycoprotein and mycobacterial arabinogalactan.^{44,45,54,46–53} The synthetic progress usually consists of two main parts before final deprotection to get the target molecule: modification of the monosaccharides to get desired building blocks, and the construction of the glycosidic bonds by glycosylation reactions.

1.4.1 Monosaccharide Modifications

Monosaccharides are the simplest sugar molecules that cannot be further hydrolyzed to smaller sugars.⁵⁵ The most common configurations of bacterial sugar residues appearing in bacterial epitopes are in cyclic pyranose or furanose forms.

Scheme 2 shows the reversible cyclization reactions of D-galactose as an example.⁵⁶

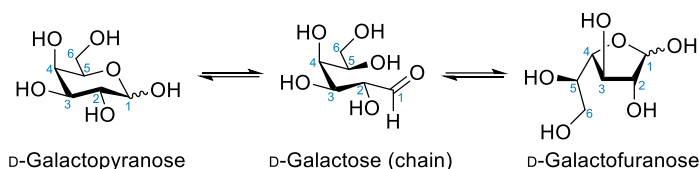

Scheme 2 Cyclization of acyclic D-galactose to form pyranose and furanose structures
Cyclization reactions usually produce both α and β anomers.

A significant feature of the sugar molecules is the high density of hydroxyl groups. The reactivity of these hydroxyl groups differs but without dramatic distinction. The building blocks can be used for further glycosylations as donors (which react at position 1) or acceptors (which react at other positions). Building block design often requires the arming of all the undesired hydroxyl groups of the acceptor with protective groups except the only hydroxyl group needed for further coupling.

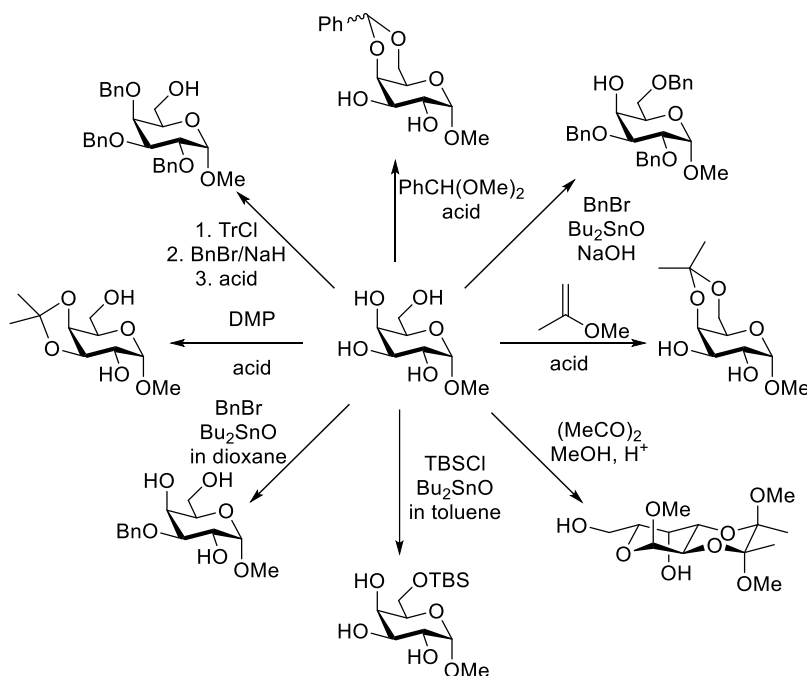

Scheme 3 The selectivity in protecting the methyl α -D-galactopyranoside as an example⁵⁷

Selective protection of particular hydroxyl groups is vital in shielding these undesired reaction sites. **Scheme 3** shows how this can be achieved by applying

Introduction

different reagents and catalysts to protect some of the hydroxyl groups and leave others free. The protective groups could be divided into two types: permanent and temporary protective groups. Permanent protective groups are functional groups that are relatively stable when modifications on other positions or glycosylations are taking place. They will only be removed during global deprotection when the final deprotected sugar is prepared. On the other hand, temporary protective groups are more fragile and can be cleaved under specific conditions where other functional groups are not affected. Sometimes, two or even more protective groups can be orthogonal to allow for the building block to be used in various situations to fulfill different requirements.

Blocking specific hydroxyl groups is not the only effect of protective groups; they will also introduce electronic and spatial effects into the sugar molecule, change the sugar ring conformation or participate in the reaction directly, thus possibly bringing significant difference of the sugar's chemistry properties and reactivity. Many selective reactions are based on these effects. A commonly acknowledged example is to introduce an acetyl group for 2-OH protection in a glucopyranose which will result in β product in the glycosylation reaction from neighboring participation effect.⁵⁸ An example with detailed mechanism is shown in **Scheme 5**.

Besides hydroxyl groups, there are also amino groups in amino sugars where modifications are needed as well during synthesis. Acetyl-derivatives protected amino groups or more stable azido groups are commonly utilized in the synthesis and they will finally be converted into acetyl amino or free amino groups in the target molecule.

Many useful strategies and methods have been developed through the past decades and simple sugar molecules can be converted into almost any building blocks required for the synthesis of our target molecule. Yet, many unexpected problems may occur when running reactions. A tiny change of the structure, even at a far-away position, might bring about a totally different result. Even equipped with knowledge of many similar examples as well as relative experience, a successful synthesis route can never be guaranteed before the final compound is obtained.

1.4.2 Glycosylations to Construct Complex Oligosaccharids

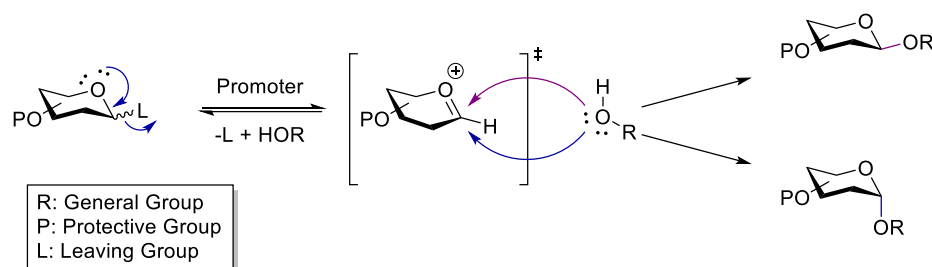

Scheme 4 General mechanism of a glycosylation reaction

The glycosylation is the key step in oligosaccharide synthesis where a glycosidic bond is formed to connect the glycosyl donor and acceptor. The majority of the glycosylation methods start from the activation of the leaving group in the glycosyl donor at anomeric position. It forms an oxocarbenium intermediate that can be attacked by the nucleophilic acceptor to form the glycoside product.⁵⁹ (**Scheme 4**) The glycosylation mechanism is still not completely understood but some new technologies such as ion mobility–mass spectrometry and cold-ion infrared spectroscopy have provided more solid mechanistic insights of glycan synthesis.^{60,61}

A lot of work has been done since the pioneering approach of Hermann Emil Fischer and Arthur Michael who performed the first glycosylation experiments. Chloride was used as the leaving group and the reaction proceeded with a nucleophilic substitution just as many modern glycosylations do.⁶² Nowadays, commonly used donor types include glycosyl halides, thioglycosides, glycosyl imidates,⁶³ glycosyl phosphates,⁶⁴ glycosyl *O*-alkynyl benzoates^{65–67} and others.⁶⁸ The leaving groups for glycosylation frequently applied in this thesis include thioglycosides and glycosyl imidates.

Thioglycosides can be prepared by the nucleophilic attack of thiol on the anomeric position of the sugar in the presence of Lewis acids as $\text{BF}_3 \cdot \text{Et}_2\text{O}$, TMSOTf, SnCl_4 , *etc.* They can be stored for a long time and are chemically stable during many other protection and deprotection reactions as well as some glycosylation procedures. However, they are also excellent donors and can be easily activated with NIS and TfOH, which makes them quite versatile for oligosaccharide syntheses. Compared to thioglycosides, glycosyl imidates, usually 2,2,2-trichloroacetimidate or 2,2,2-trifluoro-*N*-phenylacetimidate, are more reactive. Although not as stable as thioglycosides, they

Introduction

are more reactive and could still be smoothly obtained from the coupling of numerically hydrolyzed sugar and the imidate precursor. Glycosylation of the imidate donor takes place with catalytic amount of Lewis acid. This very reliable reaction has already been used in the syntheses of a number of glycoconjugate natural products and the activation condition can be distinguished from thioglycoside donors. New glycosylation methods are being developed. Gold(I) catalyzed glycosylations are applied when the building blocks are very labile in acidic conditions,^{69,70} enzyme mediated glycosylations are used for the installation of sialic acid.⁷¹ Reagents are also updated to improve the reaction yields or selectivity, or reduce the reagent cost or toxicity. Examples include the usage of 1,3-dibromo-5,5-dimethylhydantoin instead of NIS or NBS as promoter to activate thioglycosides,⁷² and the introduction of cheap metal⁷² to reduce the amount of gold(I) catalyst needed in the gold catalyzed glycosylation.⁶⁷

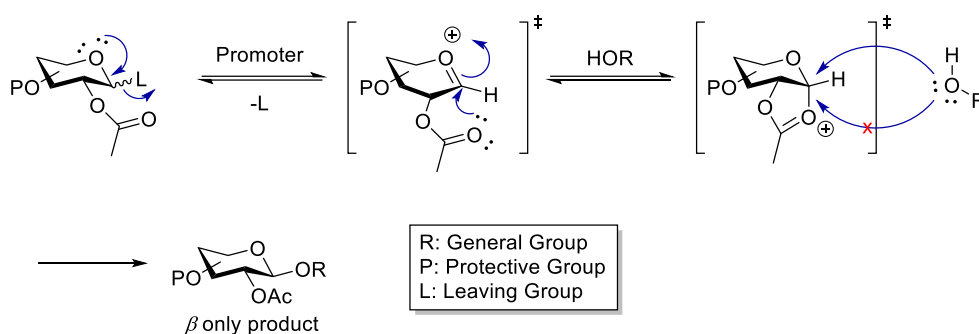

Scheme 5 Proposed mechanism of the neighbouring group participating effect to form a 1,2-*trans* glycoside

The control of regioselective and stereoselective glycosylations is essential for the chemical synthesis of oligosaccharides. Apart from the different types of leaving groups, glycosylation reactions can be affected by many other factors such as temperature, solvents, promoters, substituents especially at the C2 position of the donor (**Scheme 5**), distortion of the sugar rings and so on.

Recently, the Seeberger group reported using computer learning to fit the parameters in the glycosylation and was able to predict the α/β selectivity with given data of glycosylation conditions.⁷³ A long way remains to go before a general solution can be reached. Many real structures are much larger and far more complex, making it overwhelmingly beyond the limit of the computer to make reliable predictions. While we have made many complex sugar molecules and their derivatives, the famous lines by Hans Paulsen are still unquestionable even today:

“Although we have now learned to synthesize oligosaccharides, it should be emphasized that each oligosaccharide synthesis remains an independent problem, whose resolution requires considerable systematic research and a good deal of knowhow. There are no universal reaction conditions for oligosaccharide syntheses.”⁷⁴

Each oligosaccharide synthesis is a journey to explore the nature’s unknown. And I will provide a lot of details of my exploration in Chapter 2 and Chapter 3.

1.5 Goal and Objectives of This Thesis

The overall goal of the thesis is the development of vaccines against emerging bacteria that are threatening humans as well as other species all around the world. My target bacteria are *Klebsiella pneumoniae* sequence type 258 in Chapter 2 and *Streptococcus suis* serotypes 3 and 18 in Chapter 3.

The last few decades have witnessed the discovery and worldwide spread of drug resistant bacteria including *Klebsiella pneumoniae* and no effective treatment has been found yet to combat these “super bugs” since they can produce *K. pneumoniae* carbapenemases (KPC) which can protect them from almost all available antibiotics. The lethal infection caused by the KPC producing bacteria prompted us to seek a protective method to fight against them through the development of a vaccine. The first objective of Chapter 2 is to prepare pure antigen of the bacteria by chemical synthesis according to the literature⁷⁵ where the structure of the most predominant antigen was determined. The second objective is the biological evaluation of the synthetic antigen. The antigen needs to be conjugated to a carrier protein to obtain the candidate of the vaccine against this KPC producing bacteria. In collaboration with Bruna M. S. Seco, a biologist, we tested glycan arrays and further immunized rabbits as our animal model. Different lengths of the oligosaccharides not only helped us to find the best solution in this project, but also provided us with a deeper understanding of the structure factor related to the vaccine effectiveness and will be a useful reference for future vaccine development.

Chapter 3 focuses on *Streptococcus suis* bacteria, a very important swine pathogen. Almost all pig farms worldwide have carrier animals and the bacteria result in

Introduction

huge economic losses in the swine industry every year. What's worse, human beings also have a chance to get infected by direct contact with the carrier pigs or contaminated derived products. The objective of this chapter is to synthesize the antigens from *Streptococcus suis* serotypes 3 and 18 as vaccine candidates. Although the final compounds have not been obtained, the strategy has been established and the target molecules are within reach. Some serendipity worth further investigation during the work will also be described in this chapter.

2 Development of a Vaccine Candidate against *Klebsiella pneumoniae* ST 258

2.1 Introduction

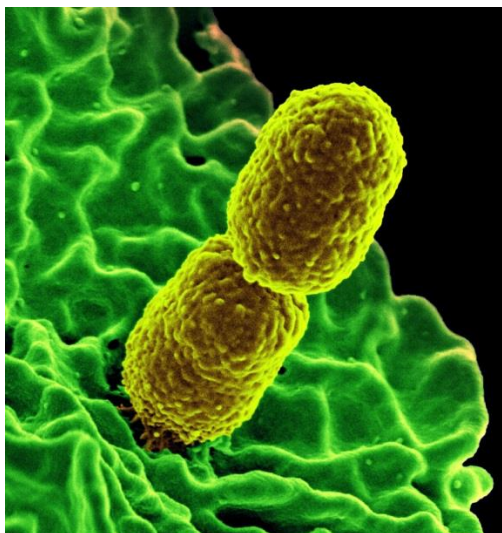

Figure 8 Carbapenem-resistant *Klebsiella pneumoniae* bacteria, on a green-colored neutrophil*

Klebsiella pneumoniae is a Gram-negative bacterium named after Edwin Klebs, a 19th century German microbiologist. The non-motile, rod-shaped bacterium are covered by a prominent polysaccharide capsule. *Klebsiella pneumoniae* exists ubiquitously in the environment, and is asymptotically part of the human microbiome, on the skin, in the mouth, and mostly in the intestines. However, *Klebsiella pneumoniae* is an opportunistic pathogen that can cause pneumonia, urinary tract infections, bacteremia and liver abscesses in immunocompromised people. Conventionally, antibiotics have been applied to treat *Klebsiella pneumoniae*. However, recent studies have shown the development of drug-resistance in them which has been accelerated by the antibiotics abuse.⁷⁶

Carbapenem-resistant *Klebsiella pneumoniae* (CRKP) infections have raised global apprehension with high morbidity and mortality resulting from the bacterium's extraordinary resistance to almost all currently available antibiotics. The first case where *Klebsiella pneumoniae* carbapenemases (KPCs) were identified was in the USA in 1996.⁷⁷ The bacteria could produce KPCs to hydrolyze almost all the available

* Scanning electron microscopic (SEM) image, by National Institute of Allergy and Infectious Diseases (NIAID), digitally recolored.

antibiotics: penicillins, cephalosporins, monobactams, carbapenems and even β -lactamase inhibitors.⁷⁵

Difficulties in treating these bacteria have helped them to spread very quickly around the world in the past two decades and cases have been reported globally with the ST258 lineage being the predominant clone worldwide.⁷⁸ (Figure 9) As the outbreaks become increasingly frequent, no efficient therapeutic method is available yet. A solution needs to be found soon. Vaccination is an advantageous preventive way to fight against the KPC producing *K. pneumoniae*.⁷⁹

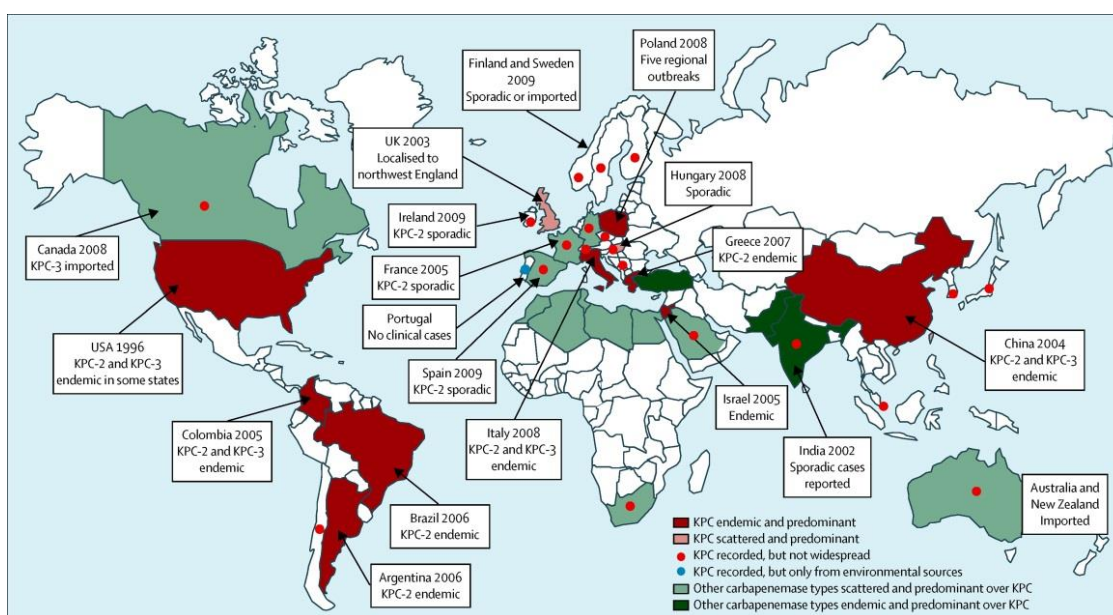

Figure 9 Epidemiology of KPC producing bacteria by original countries⁷⁸
Other carbapenemase types: VIM, OXA-48, or NDM

Capsular polysaccharides (CPS, *K*-antigens) and lipopolysaccharides (LPS, *O*-antigens) are the most important virulent factors of KPST258. Fragments of these antigens may be used for the development of glycoconjugate vaccines for KPST258 infections. More than 77 CPS structures have been discovered and a pioneering vaccine candidate based on a *K*-antigen has already been reported by the Seeberger group.⁸⁰ However, the high diversity of *K*-antigens makes it laborious to cover all the serotypes and many newly-appearing CPS structures are yet unidentified.⁸¹ On the other hand, *O*-antigens have a quite limited variation of structures.⁸² The *O*-antigens are classified to nine serotypes, and among them **O2afg**, or **Gal-III** was figured out to be preponderant in the KPST258 isolates.

The repeating unit (RU) of **Gal-III**, shown in **Figure 10-a**, is a branched frame of two galactopyranose and one galactofuranose, and an oligosaccharide based on this structure might be able to stimulate the immune response.^{75,83} A synthetic epitope would also include an aminoalkyl linker attached to its anomeric carbon from the hydroxyl end and the other NH₂ end of the linker could be applied to glycan array immobilization or conjugation to CRM₁₉₇ for immunization investigations.

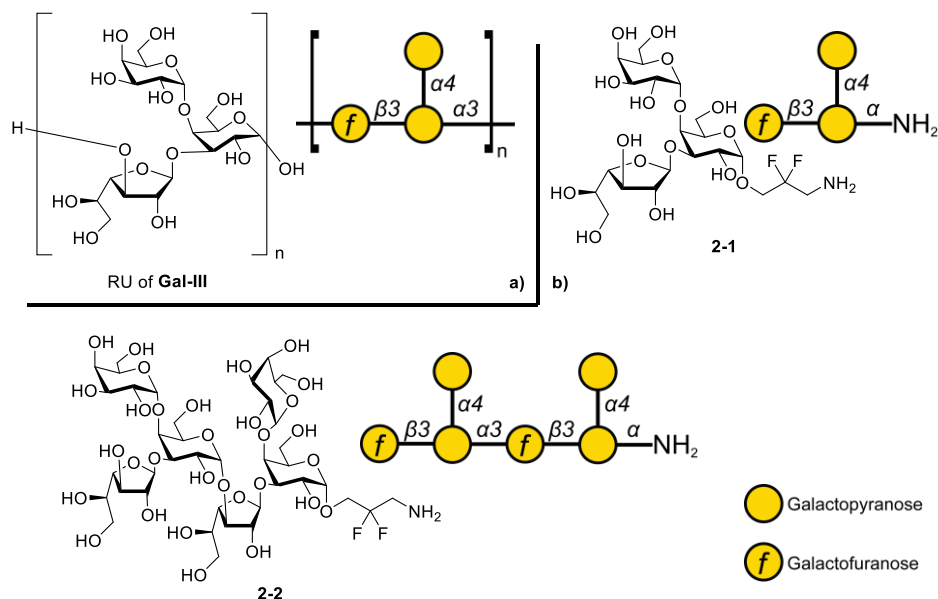

Figure 10 Structures of target oligosaccharides for KPST258 vaccine development. **a)** Trisaccharide repeating unit of **Gal-III** from **KPST258**. **b)** Chemical synthetic trisaccharide repeating unit **1** and hexasaccharide **2** containing two repeating units, each connected to a fluorinated linker.

In this thesis work, the chemical syntheses of the trisaccharide KPST258 repeating unit **2-1** and hexasaccharide **2-2** consisting of two repeating units (**Figure 10-b**) as well as their conjugation followed by glycan arrays and immunization tests were performed. The evaluations of the two vaccine candidates CRM₁₉₇₋₂₋₁ and CRM₁₉₇₋₂₋₂ were carried out so we could compare the influence of the sugar chain length to the immunization results which would allow us to gain a better understanding of how the antigens work and benefit in further vaccine development against KPST258.

2.2 Results and Discussions

2.2.1 Retro-synthetic Analysis of Oligosaccharides 2-1 and 2-2

Retrosynthetic analyses of **2-1** and **2-2** are depicted in **Scheme 6**. The target molecules were obtained from global deprotection of the protected compounds **2-3** and **2-4** separately, where the protective groups were carefully designed for successful assembly of the monosaccharide building blocks.

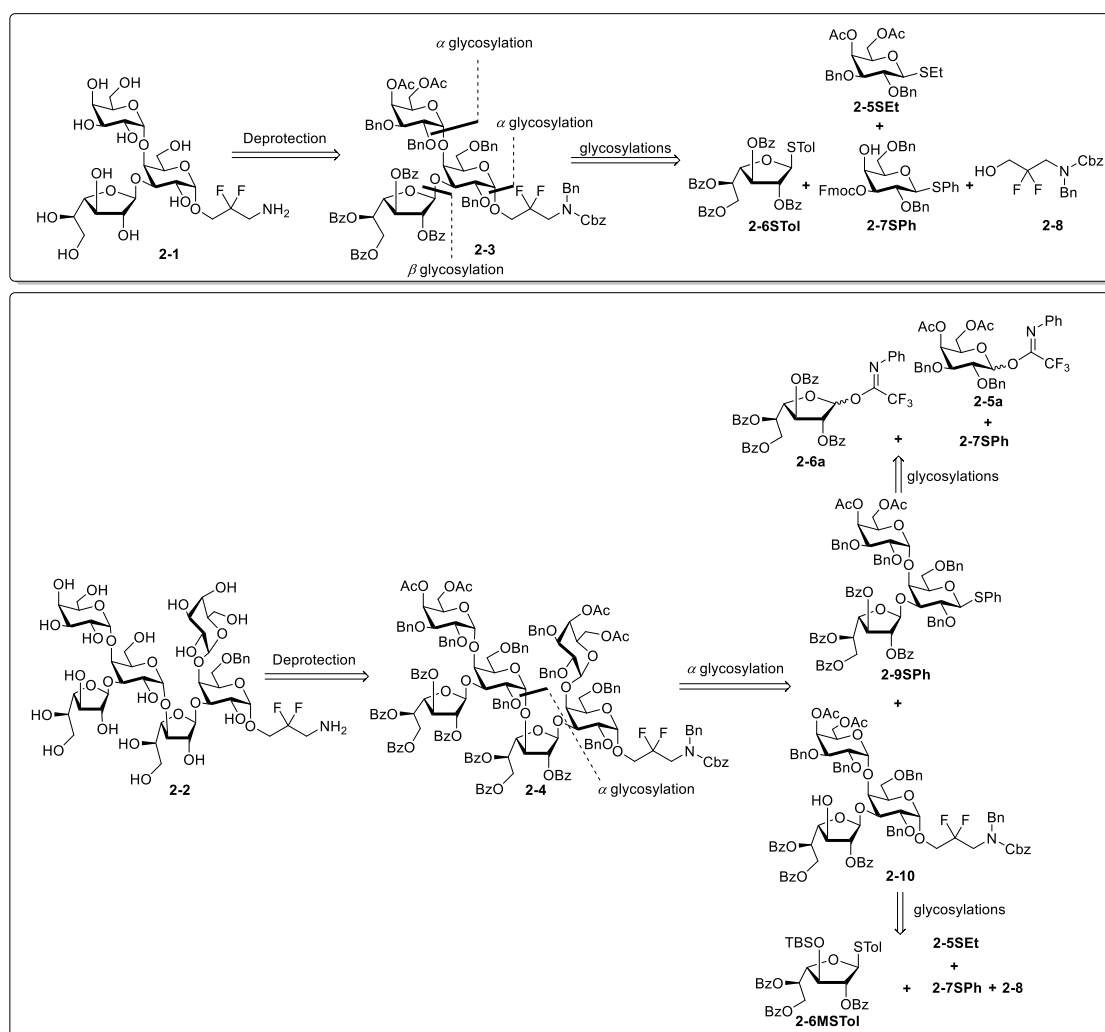

Scheme 6 Retrosynthetic analysis of trisaccharide **2-1** and hexasaccharide **2-2**

The core residue of the challenging target trisaccharide **2-1** is a galactopyranose where the linker and both of the other two sugar residues are connected at C1, C3 and C4 positions independently. The key element of the strategy was how to assemble the linker (**2-8**) and two terminal sugar building blocks (**2-5SEt** and **2-6STol**) to the core **2-7SPh** at the right locations with proper stereoselectivity. To assemble hexasaccharide

2-2, different strategies could be employed. The first trial was to synthesize the backbone tetrasaccharide before installation of the two branched galactopyranoses. Unfortunately, the installation of galactopyranoses was not working well. In order to solve the problem, an alternative extendable 3+3 strategy (trisaccharide plus trisaccharide strategy) was applied in designing the synthesis of hexasaccharide **2-2** containing two trisaccharide repeating units.

By changing the C3 protective group of **2-6STol** from permanent protecting benzoyl group to a temporary protective group, a further glycosylation of **2-10** was possible with **2-9SPh** as a donor, whose difference from **2-3** was that the trisaccharide was not connected to the linker but had a thiol leaving group. In this case, assembly of the building blocks required the tolerance of glycosylation conditions by the thiol leaving group. The solution to this problem was to use more reactive leaving groups on monosaccharide donors **2-5a** and **2-6a** so the glycosylation could be performed at milder conditions where the thiol could tolerate.

2.2.2 Total Synthesis of the Trisaccharide Epitope 2-1

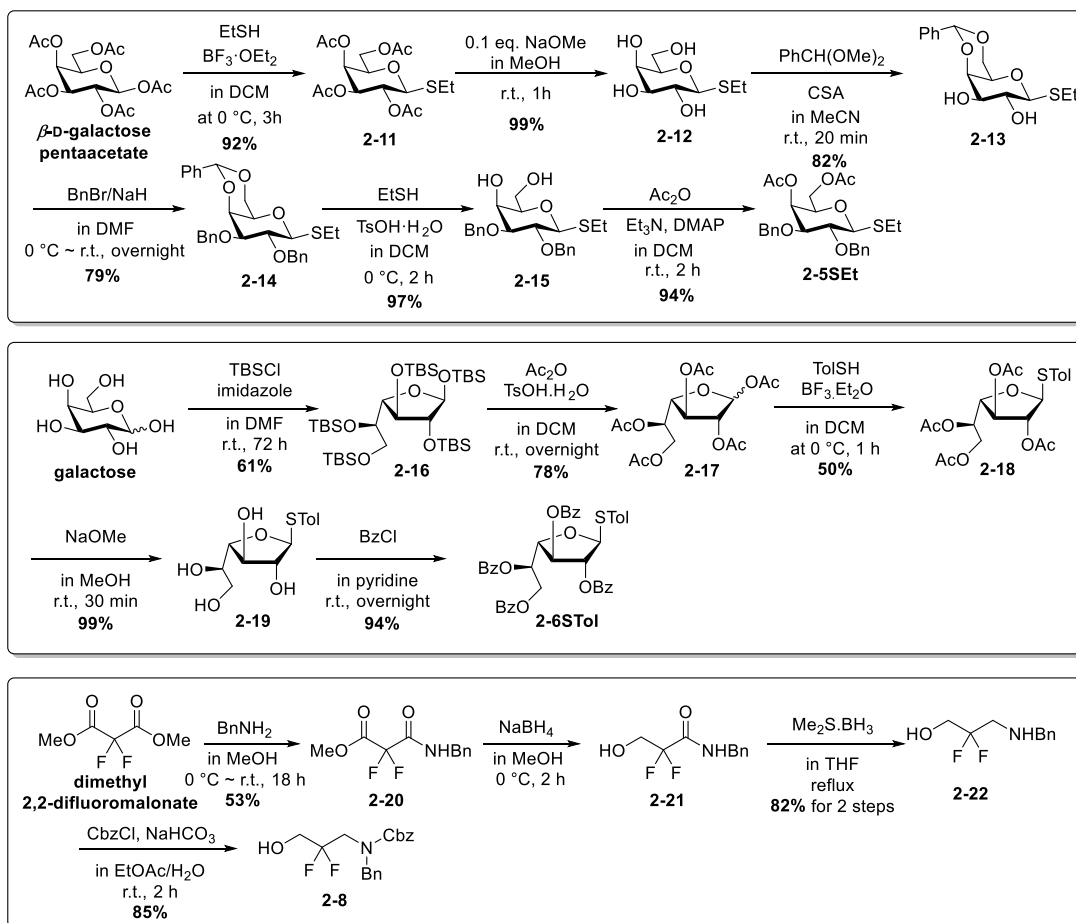
Scheme 7 Preparation of 2-5SEt, 2-6STol and 2-8^{84,85}

To synthesize trisaccharide 2-1, the galactopyranose building blocks 2-5SEt, 2-7SPh, galactofuranose building block 2-6STol and the fluorinated linker 2-8 had to be prepared. The fluorinated linker 2,2-difluoro-3-aminopropanol (2-8) was a newly developed linker favoring α -glycosylation.⁸⁴ The stereo control of α -glycosylation with linker is not easy in many cases and we mostly rely on the reaction conditions to enhance α -selectivity. After introduction of the fluorine atoms to the linker, the nucleophilicity of the linker would be reduced dramatically and hence much better α -selectivity due to the anomeric effect.⁸⁴

2-5SEt was first reported in the Automation Glycan Assembly (AGA) strategy where pure α -glycosylation was observed.⁸⁵ Synthesis of 2-5SEt started from β -D-galactopyranose pentaacetate which was a very cheap commercially available starting material. After several modification steps, C2 and C3 positions were protected with benzyl groups while C4 and C6 were acetate protected. The α -selection when

performing glycosylation was favored probably because of the remote participating of C4 and C6 acetyl groups. Although situations might be different between automated synthesis and solution synthesis, we still assume that a good α selectivity could be achieved.⁸⁵

2-6STol is a galactofuranose that has different properties compared to the other galactopyranose building blocks. I started from unprotected galactose and the first step was *tert*-butyldimethylsilyl (TBS) protection on every hydroxyl group. TBS group is a very bulky protective group. The *cis*-positions of C3 and C4 hydroxyl groups would severely repulse each other in pyranose configuration after TBS protection, distort the sugar ring and raise the energy to a very high level. On the other hand, the neighboring hydroxyl groups on the sugar ring of galactofuranose are all *trans*-positioned and this galactofuranose configuration has a lower energy which will push the reaction equilibrium to the major galactofuranose product **2-16** which was further converted to **2-6STol** after a few steps. β -Glycosylation selectivity of **2-6STol** as the donor was guaranteed by the benzoyl participating group at C2 position.

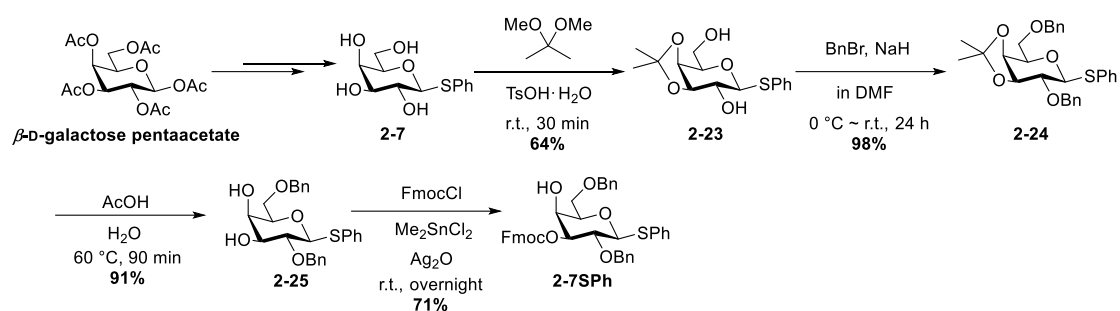

Scheme 8 Synthesis of the core building block **BB2SPH**

The core building block **2-7SPH** was synthesized from commercially available β -D-galactose pentaacetate. (**Scheme 8**) Following a described procedure, we prepared 2,6-benzylthiolgalactose **2-25** and the problem was to distinguish the C3 and C4 positions.⁸⁶ A linker usually has a higher activity than a sugar building block as an acceptor, especially for less reactive 4-hydroxyl group, we only selectively protected C3 position with fluorenylmethyloxycarbonyl group (Fmoc) and left the 4-OH unprotected via dimethyltin dichloride catalyzed conditions.⁸⁷ The building block **2-7SPH** can first react as donor with **2-8** followed by another glycosylation with **2-5SEt** on its C4 position to obtain the disaccharide intermediate. Subsequent deprotection of Fmoc and

glycosylation with **2-6STol** at C3 position could then provide the desired protected trisaccharide **2-3**.

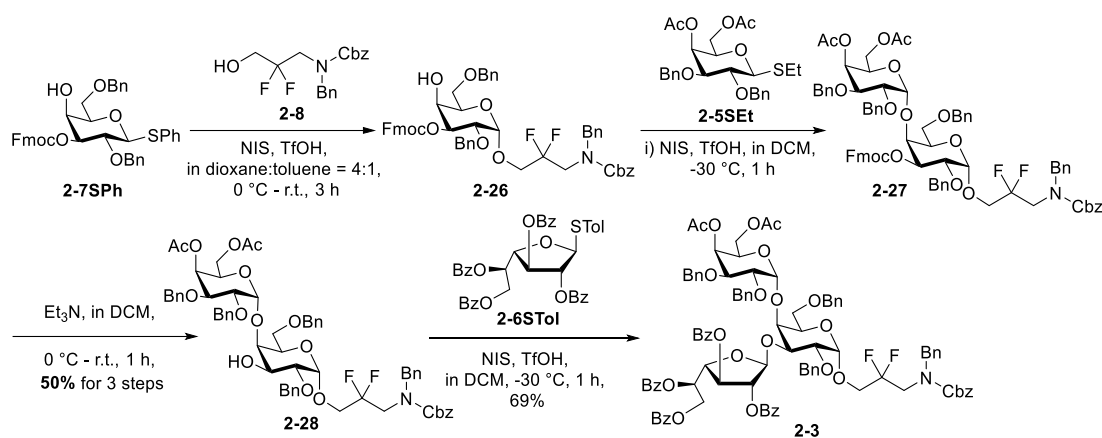

Scheme 9. Assembly of the building blocks to form protected trisaccharide 2-3.

After I obtained all the required building blocks, **2-7SPH** was first coupled with **2-8**. The α -product was favored because of a weaker nucleophilicity of the acceptor, the solvent effect and higher temperature. These factors led to a slower nucleophilic attack during the glycosylation hence thermodynamic control of the reaction to give a much better α -selection. β -Isomer could not be identified by NMR in the previous step as it was produced in trace amount only. The α/β ratio of the glycosylation reaction was 36/1, indicated by HPLC of the product, which was very encouraging (**Figure 11**).

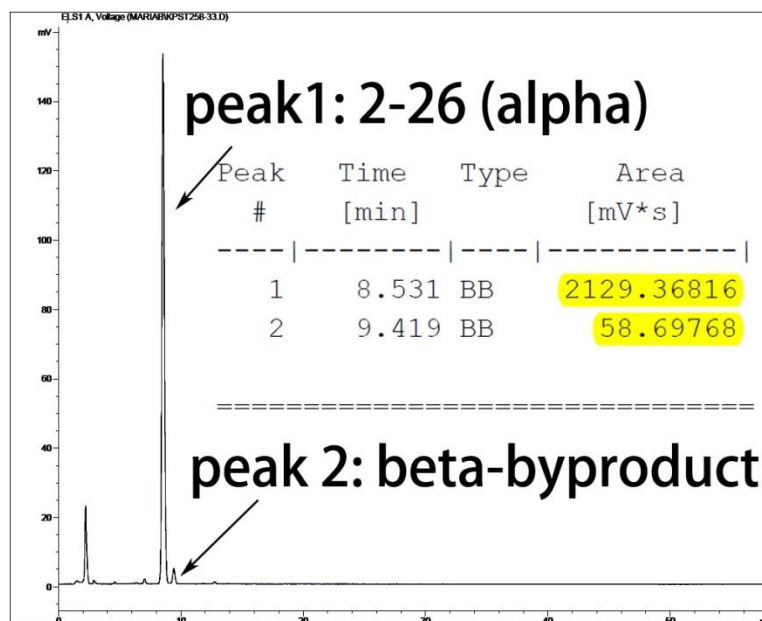
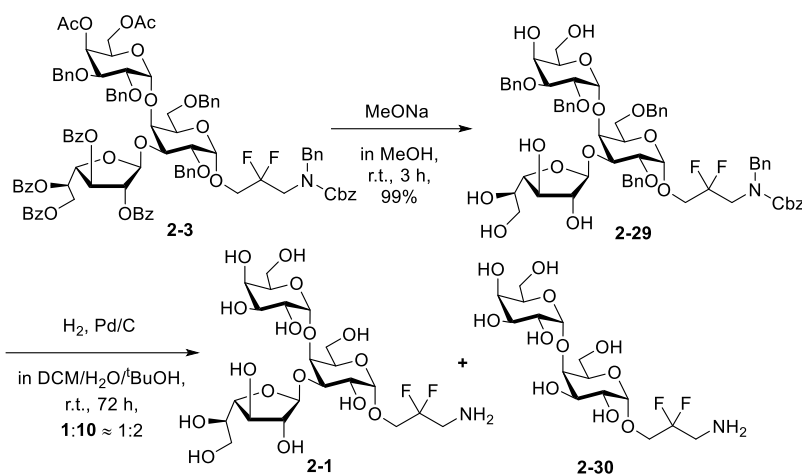

Figure 11 HPLC trace of the glycosylation to obtain 2-26; $\alpha/\beta = 36$

However, the product was unable to be purified until **2-5SEt** was installed at the C4 position and Fmoc was cleaved. Both of the glycosidic linkages in the disaccharide **2-26** were confirmed α according to the H-C coupling constant (~ 170 Hz). We assumed that the excellent α -stereoselectivity in the second glycosylation came from the 4,6-acetyl groups on **2-5SEt** via remote participation. Next, β -glycosylation with **2-6STol** gave us the protected trisaccharide **2-3**.



Scheme 10 Global deprotection of **3**. Galactofuranose partially cleaved during hydrogenation.

With the protected trisaccharide **2-3** in hand, global deprotection with commonly used conditions was carried out, and the cleavage of ester groups was working well. However, partially decomposition of the product was observed in the hydrogenation step where the galactofuranose was cleaved. (Scheme 10) We tried to change Pd/C into

$\text{Pd}(\text{OH})_2/\text{C}$ as we assumed the hydrogenation environment might become acidic during the reaction and result in the cleavage of the galactofuranose. Since the furanose residue cleavage was not avoided, I tried to reduce the reaction time, trying to stop hydrogenation before the start of the cleavage. Unfortunately, mass spectra of the reaction solution during hydrogenation monitored by MALDI showed that the cleavage happened before **2-29** was fully converted.

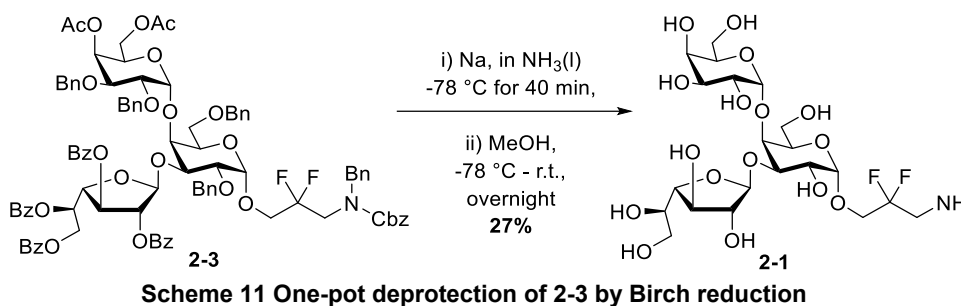

I moved to the alternative Birch reduction conditions where all the protective groups can be cleaved in one pot. This was a reaction in whose first stage a strong basic and reductive environment created by $\text{Na}(\text{NH}_3)$ could deprotect Bn and Cbz groups, and after being quenched by methanol, sodium methoxide formed and could disarm the acyl groups in the second stage to obtain the desired trisaccharide **2-1**. (**Scheme 11**) The NMR spectra of the product indicated an agreement with the data from the natural isolated epitopes. (See experimental section.)

2.2.3 Total Synthesis of the Hexasaccharide Epitope 2-2

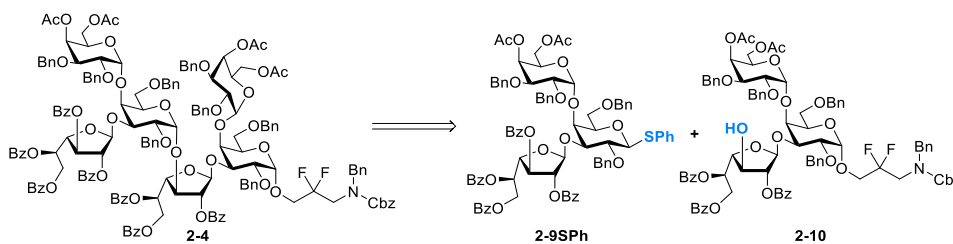

Scheme 12 The 3+3 strategy for the synthesis of hexasaccharide 2-4

Synthesis of hexasaccharide **2-2** followed an extendable 3+3 strategy based on the successful assembly of trisaccharide **2-1**. As specified in **Scheme 12**, the hexasaccharide could be synthesized through glycosylation between donor **2-9SPH** and acceptor **2-10**. Syntheses of **2-9SPH** and **2-10** were based on the previous strategy but more complicated, and modifications of the building blocks were required. For the acceptor **2-10**, only one place needed to be changed. The C3 position of **2-6STol** needed to be replaced by a temporary protective group which could be deprotected selectively to form a hydroxyl group for further extension with the trisaccharide donor.

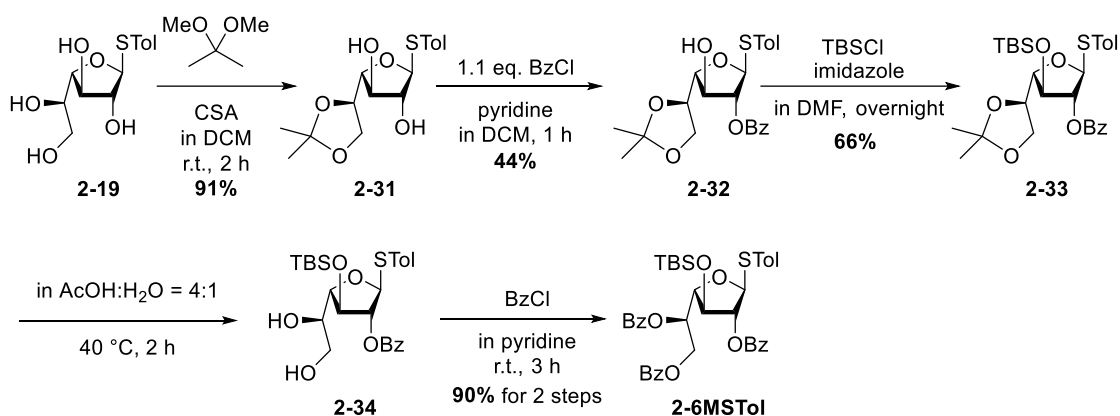

Scheme 13 Synthesis of the modified galactofuranose building block **2-6MSTol**.

The key step to achieve the modified building block **2-6MSTol** was to distinguish the C2 and C3 positions. Benzoylation of **2-31** with 1.1 eq. of benzoyl chloride (BzCl) gave C2 benzoylated product **2-32**, after which the C3 position could be protected by a silyl group,⁸⁸ and subsequently C5 and C6 were changed to benzoyl group due to the vulnerability of the isopropylidene under acidic glycosylation conditions to obtain the modified building block **2-6MSTol**. (**Scheme 13**) More hindered bases (DIPEA, 2,4,6-collidine and TTBP) were tried in order to improve the yield or regioselectivity from **2-31** to **2-32**, yet neither of them worked better and the original conditions were kept.

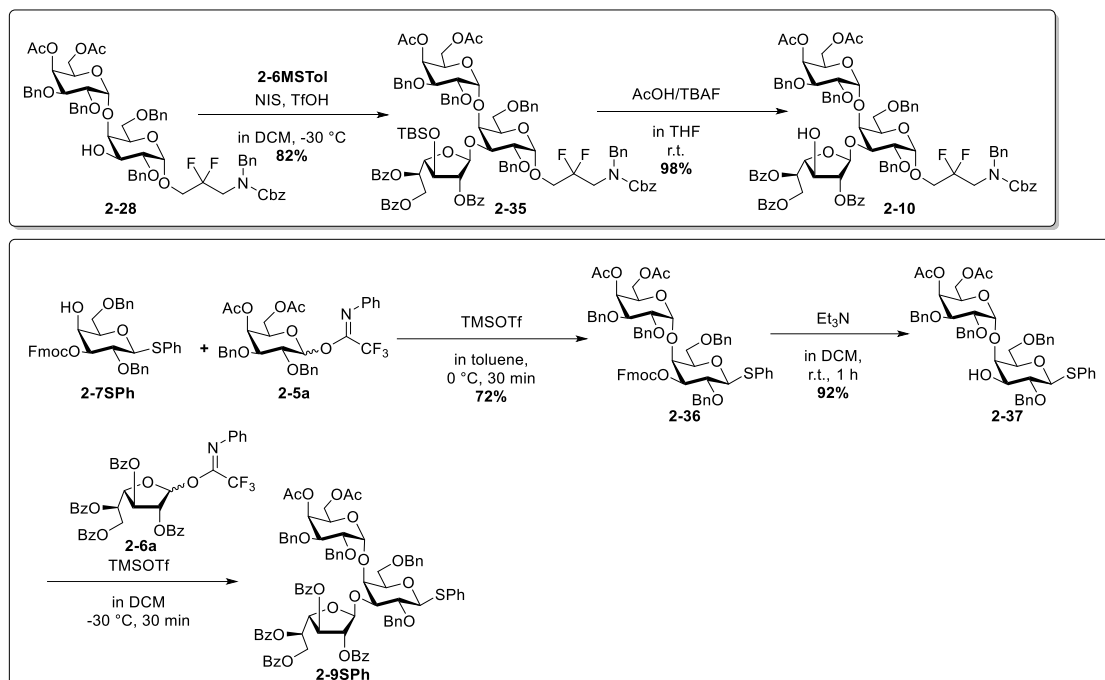

Scheme 14 Assembly of trisaccharide fragments **2-10** as acceptor and **2-9SPH** as donor.

The installation of **2-6MSTol** on disaccharide **2-28** allowed us to prepare the trisaccharide **2-35** without any problem. TBAF was then used to deprotect the TBS group on the galactofuranose. However, under basic conditions, the acetyl groups would be cleaved. This issue was solved by the addition of acetic acid together with TBAF to adjust the pH to neutral, and the modified conditions yielded trisaccharide acceptor **2-10** in a surprisingly high yield.

Meanwhile, the trisaccharide donor **2-9SPH** was synthesized from **2-7SPH**. Without the linker's attachment on its anomeric position, **2-7SPH** must carry the thiol leaving group during the following assembly steps, which required a compatible glycosylation condition with thiol. To solve the problem, **2-5SEt** and **2-6STol** were converted to glycosyl trifluoroacetimidates⁸⁹ **2-5a** and **2-6a** separately by hydrolysis and installation of the *N*-phenyl trifluoroacetimidate. The glycosylation steps to **2-9SPH** were performed under milder conditions where TMSOTf was used instead of TfOH and NIS, and thiol was steady enough to stay unaffected. (**Scheme 14**)

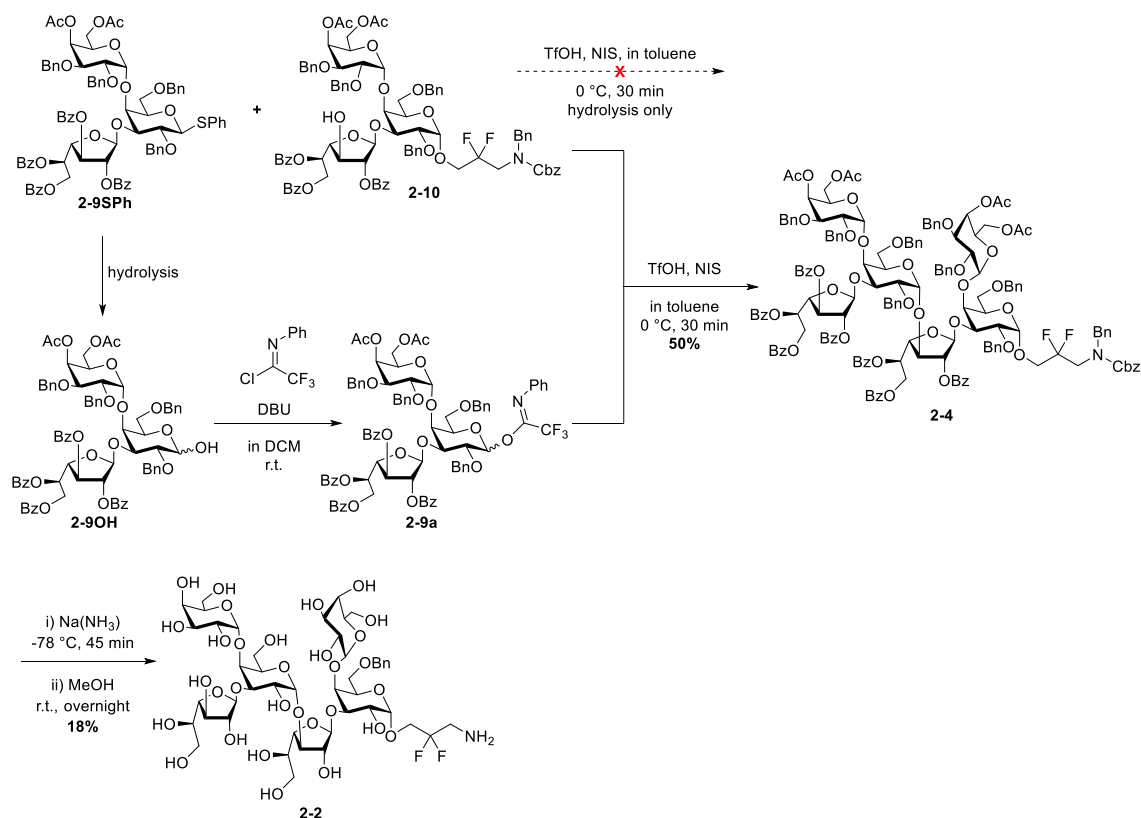

Scheme 15 Synthesis of the protected hexasaccharide **2-4** and further deprotection to get final hexasaccharide target **2-2**

With both the trisaccharides **2-9SPh** and **2-10** in hand, I first did the 3+3 glycosylation under standard thiol activation conditions, but did not obtain the desired hexasaccharide. The acceptor **2-10** remained unreacted while **2-9SPh** was hydrolyzed. The hydrolyzed donor **2-9OH** was detected, indicating that the activation happened as expected, yet the following nucleophilic attack by the acceptor **2-10** didn't occur. The unsuccessful reaction might result from the mismatch of the reactivity of the donor and acceptor.

This type of mismatch was previously observed during the synthesis of the *N. meningitidis* LPS by Dr. You Yang, in the Seeberger group. He solved the problem by changing the leaving group from thiol to imidate.⁴⁹ Fortunately, **2-9OH** was recovered and **2-9a** was acquired by introduction of the *N*-phenyl trifluoroacetimidate. This imidate was successfully coupled with **2-10** with an appealing yield to get protected hexasaccharide **2-4**. Deprotection of **2-4** by Birch reduction was successful and after desalting by size exclusion column (Sephadex G25) and HPLC purification, the

deprotected hexasaccharide **2-2** was obtained. Hexasaccharide **2-2** was ready for glycan array screening and protein conjugation. (Scheme 15)

2.2.4 Evaluation of the Synthesized Epitopes by Glycan Array*

Glycan arrays are high throughput method to evaluate the glycan-antigen binding. The glycans **2-1** and **2-2** I prepared were printed on the glass plate through immobilization of the amino end.

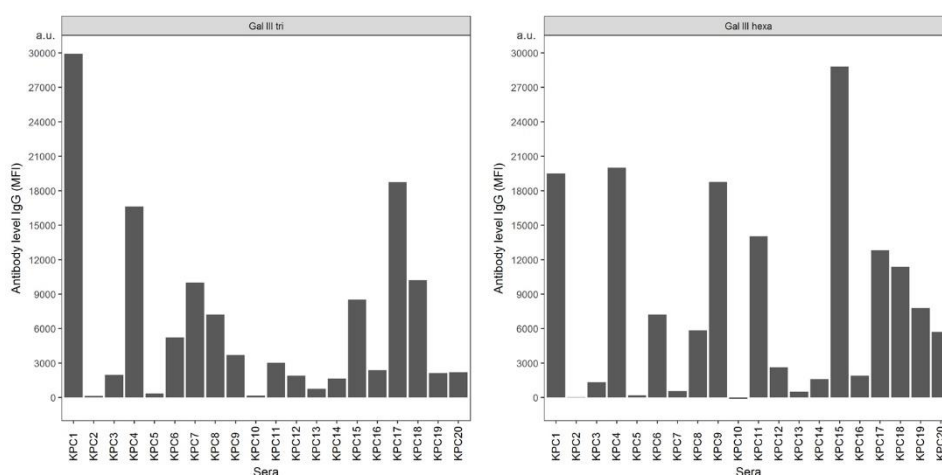

Figure 12 Glycan array evaluation of the synthesized epitopes 2-1 (left) and 2-2 (right)†

Figure 12 shows the glycan array results of synthetic trisaccharide **2-1** and hexasaccharide **2-2**. The epitopes were immobilized and evaluated by sera from 20 patients infected by *Klebsiella pneumoniae*. Seventeen of the twenty sera contained antibodies that bound both **2-1** and **2-2**, indicating the positive immune activity of our synthetic antigens. Negative results of the three sera (KPC2, KPC5 and KPC10) resulted from the immunosuppression of the patients.

With these fast and exciting results, we were able to continue further evaluation of the synthesized epitopes in animal models to provide us with more detailed information for the development of the vaccine against KPST258.

* Printing of the glycan array was performed by Ms. Katrin Sellrie. Glycan array evaluation and data analysis was performed by Ms. Bruna M. S. Seco.

† Figure by Bruna M. S. Seco. Sera provided by Prof. Dr. Bettina Fries, Stony Brook University, NY, USA.

2.2.5 Immunological Evaluation of Epitopes 2-1 and 2-2*

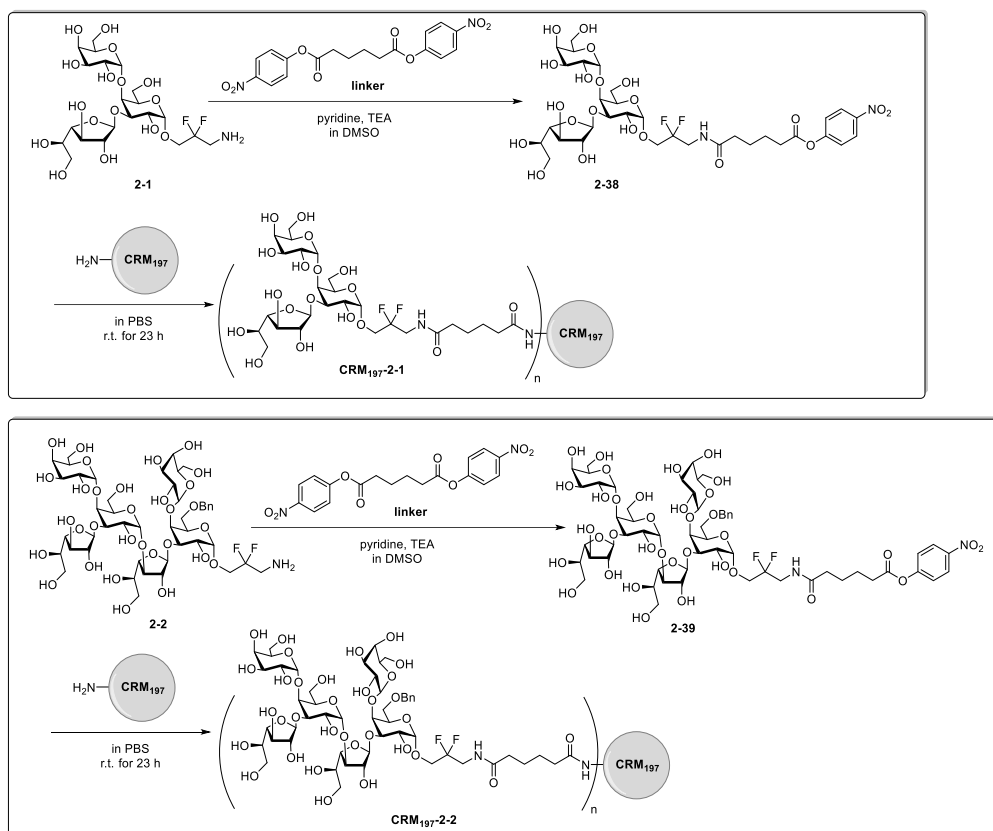
Scheme 16 Conjugation of the trisaccharide 2-1 and hexasaccharide 2-2 to carrier protein CRM₁₉₇

Since the glycan arrays showed good binding results for 2-1 and 2-2, we moved on to further immune tests which required the glycoconjugate of our sugar to a carrier protein, in our case CRM₁₉₇. Conjugation of the sugar epitopes 2-1 and 2-2 contained two steps. The first was the coupling between the oligosaccharide and *p*-nitrophenyl adipate ester (PNP) as a linker or spacer; the second was a further conjugation to the commercially available protein CRM₁₉₇ in PBS solution with a pH at around 8.

Each CRM₁₉₇ molecule was conjugated to several epitopes and the average number of the epitopes attached to each CRM₁₉₇ molecule is the loading number. The mass of unconjugated CRM₁₉₇ and conjugated CRM₁₉₇-2-1 or CRM₁₉₇-2-2 were determined by matrix-assisted laser desorption/ionization-time of flight mass spectrometry (MALDI-ToF MS) so the loading number was calculated.

* Unless otherwise stated, all the immunization experiments mentioned in this chapter were performed by Ms. Bruna M. S. Seco.

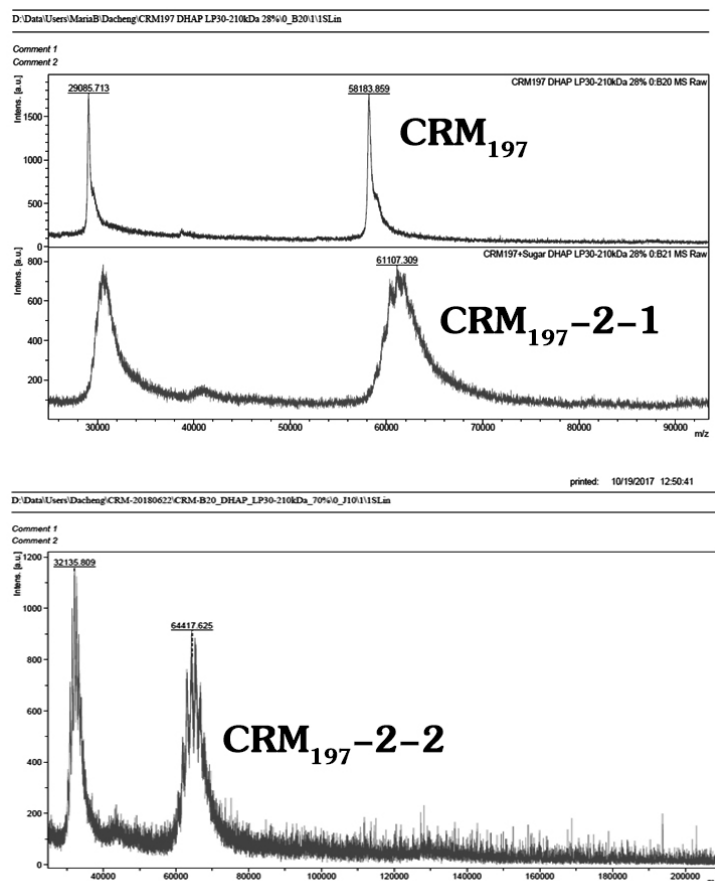

Figure 13 MALDI results of the Mass Spectra of CRM₁₉₇, CRM₁₉₇-2-1 and CRM₁₉₇-2-2

The CRM₁₉₇ protein itself is not a single structure, as well as the conjugated glycoproteins. (Figure 13) We picked the average value and the loading numbers were calculated as 4.1 for CRM₁₉₇-2-1 and 5.2 for CRM₁₉₇-2-2. (For details see Experimental Section.) The conjugated glycoproteins we got were stored in PBS buffer at 4 °C, and was used for further immunological evaluations.

As the immunization evaluation experiments are the work of Ms. Bruna M. S. Seco, the results are only briefly described in this thesis.

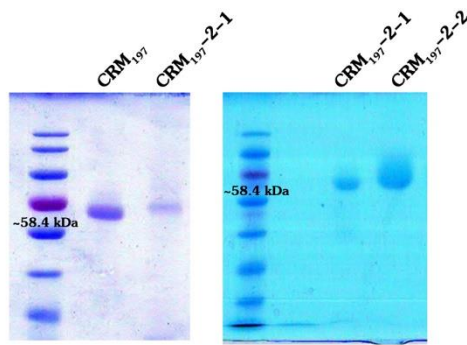

Figure 14 SDS-PAGE of CRM₁₉₇-2-1 and CRM₁₉₇-2-2*

Sodium dodecyl sulfate–polyacrylamide gel electrophoresis (SDS-PAGE) was used for further confirmation of the conjugated glycoproteins CRM₁₉₇-2-1 and CRM₁₉₇-2-2. The band of these two glycoconjugates shifted to a higher molecular weight when compared to CRM₁₉₇ alone. This result indicated the successful introduction of the epitopes onto the carrier protein. (Figure 14) Due to the limitation of available materials, we immunized rabbits with only CRM₁₉₇-2-2.

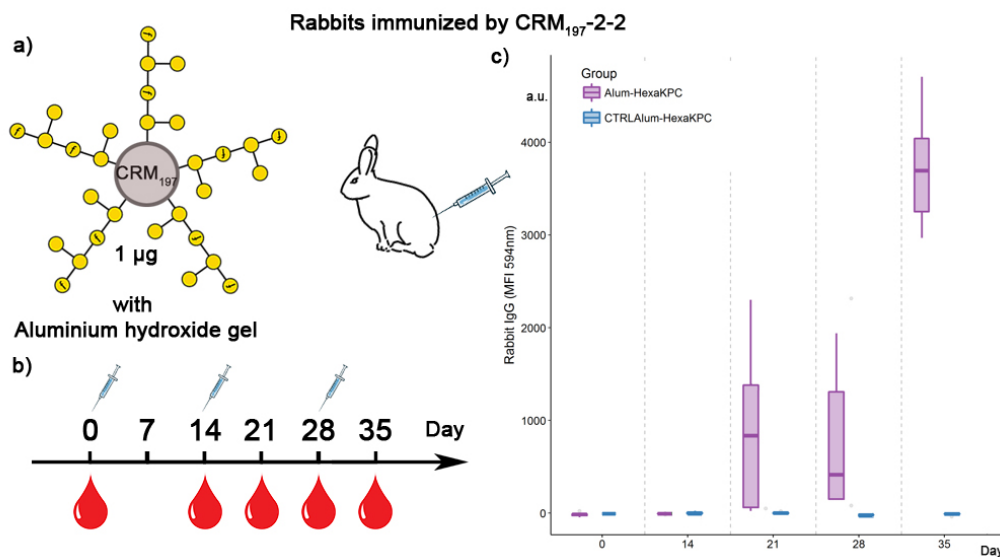

Figure 15 Immunization of rabbits with CRM₁₉₇-2-2. a) Formulation: 1 µg of CRM₁₉₇-2-2 with Al(OH)₃ as adjuvant; b) Immunization schedule: 3 doses were injected on days 0, 14 and 28. Rabbit sera were collected weekly; c) Concentrations of antibodies were detected by Glycan array and mean fluorescence intensities (MFI) were calculated.†

Five rabbits were immunized with CRM₁₉₇-2-2 (formulation: 100 µL dose, 1 µg of CRM₁₉₇-2-1 + 125 µg of aluminum hydroxide). In a control group, three rabbits were injected with PBS and aluminum hydroxide as negative control. The rabbits were injected on days 0, 14 and 28 and blood was taken every week until day 35. From the

* Figure by Bruna M. S. Seco.

† Procedure, data and Figure 15-c from Bruna M. S. Seco.

results shown in **Figure 15**, we can see that the concentration of antibodies rose after two doses and reached a very high level on day 35 after the third dose on day 28. This indicated that rabbits could be efficiently immunized by **CRM₁₉₇-2-2**.

2.3 Conclusion and Outlook

After retro-synthetic analysis of the structure of the antigen Gal-III from the emerging bacterium *Klebsiella pneumoniae* ST 258, I designed and synthesized the two structures, trisaccharide **2-1** containing one repeating unit and hexasaccharide **2-2** containing two repeating units. The repeating unit contained a 3,4-branched galactose and galactofuranose connected to its C3 position had never been studied before and the chemical synthesis of the high density branched structure in the hexasaccharide bridged via a galactofuranose at C1,C3 positions was never reported for any similar structures. After significant efforts, the structural barriers were crossed and the problem of the instability of many intermediates was solved, to accomplish the total syntheses of **2-1** and **2-2**. At the end of each oligosaccharide, an amino linker was connected for printing onto glycan arrays and for conjugation for immunization and other biological tests.

In collaboration with Ms. Bruna M. S. Seco, we performed immunological evaluations of the antigens. Glycan array test showed sera from infected patients contained antibodies binding to both **2-1** and **2-2**. Conjugation of the glycans to CRM₁₉₇, a commonly used protein carrier for glycoconjugate vaccines, worked well to obtain glycoconjugates **CRM₁₉₇-2-1** and **CRM₁₉₇-2-2**. Rabbits were immunized with **CRM₁₉₇-2-2** and this antigen triggered a robust immune response after initial injection and two boosts, indicating that the structures I synthesized are promising vaccine candidates against *Klebsiella pneumoniae*. Hopefully, development of the vaccine can help people fight against KPC-producing KPST258 and provide an example of a possible solution to other drug-resistant emerging bacteria.

3 Development of Vaccine Candidates against *Streptococcus suis* 3 and 18

3.1 Introduction

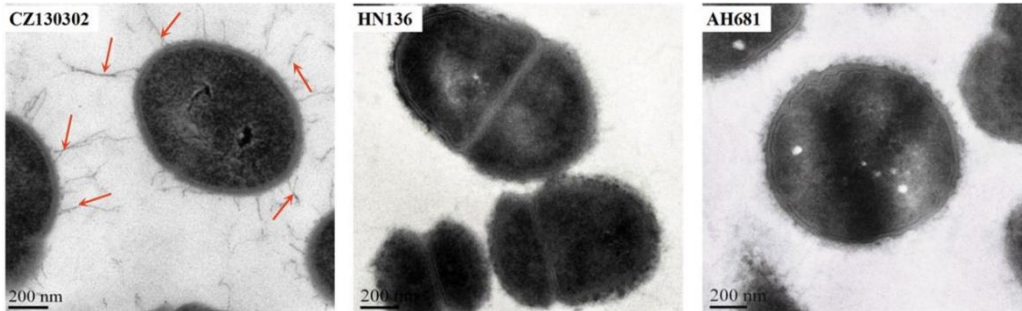

Figure 16 TEM of *S. suis* from recent isolated strains. Red arrows: fimbria-like structures.⁹⁰

Streptococcus suis (*S. suis*) is a Gram-positive, peanut-shaped bacterium and an important swine pathogen that exists in almost all pig farms throughout the world. It causes huge economic losses for the swine industry by causing meningitis, septicemia, endocarditis, deafness *etc.* in infected pigs. It has been reported that the bacteria can infect humans by direct contact with the diseased pigs or contaminated products.^{91,92}

Capsular polysaccharides (CPS) have been considered one of the most important virulence factors of *S. suis*^{93,94} and so far 35 serotypes have been determined. *S. suis* serotype 3 (SS3) is among the most problematic serotypes causing clinical swine disease, yet not much information has been revealed.⁹⁵ During the structural determination by the Segura group, a rare bacterial sugar, bacillosamine, was found involved in the antigen, which may be responsible for its virulence.⁹⁶ This rare sugar also exists in another serotype, *S. suis* serotype 18 (SS18), whose antigen had a more complicated structure.⁹⁷

Here, we wanted to synthesize the antigens containing the oligosaccharide repeating units of SS3 and SS18 in order to reveal more information about the bacteria as well as to provide promising candidates in the development of vaccines against them.

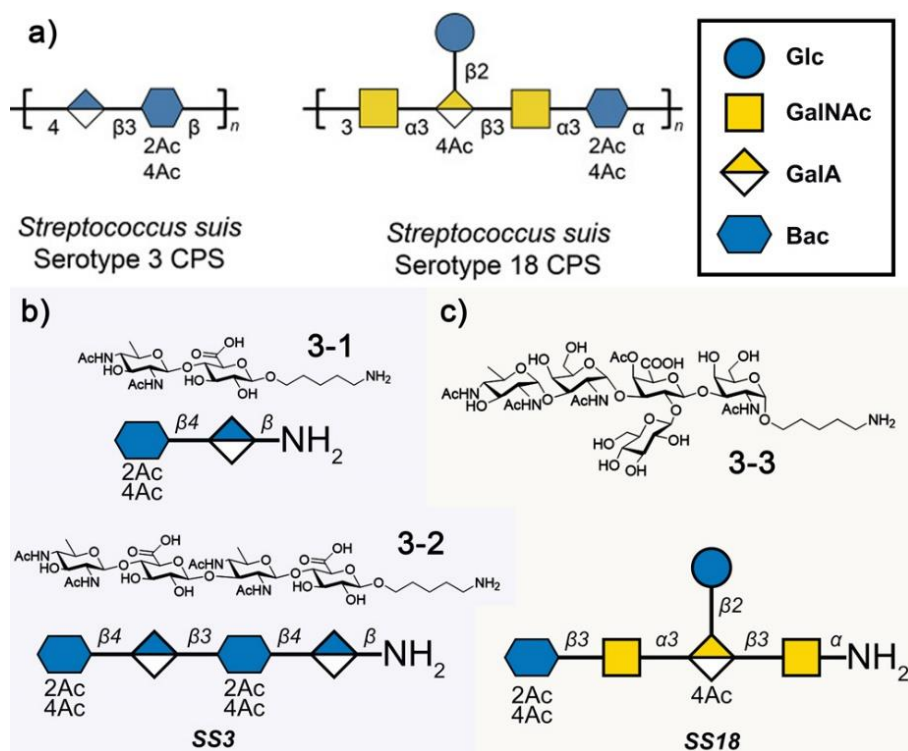

Figure 17 Structures of antigens from *S. suis* serotypes 3 and 18. a) Repeating units determined by Segura group;⁹⁷ **b)** Chemical synthetic antigens designed for SS3, **3-1** contains one repeating unit and **3-2** contains two repeating units; **c)** Chemical synthetic antigen **3-3** designed for SS18.

The structures of the repeating units from SS3 and SS18 determined by Segura group and the conjugate-ready glycans I planned to make are shown in **Figure 17**.⁹⁷ The structure of SS3 is linear but contains the rare bacillosamine residue. During assembly of the sugar building blocks, the stereo selectivity of glycosylations and reactivity of monosaccharides also needs to be considered. SS18 has a more complicated structure. It is a branched pentasaccharide including rare sugar residues of bacillosamine and a galacturonic acid as the branching center with its C4 position acetylated. Regioselectivity and stereoselectivity must be carefully designed especially at the galacturonic acid residue and the global deprotection should avoid basic conditions to prevent the cleavage of the acetyl group.

As bacillosamine is a rare amino sugar found in bacteria, its properties are poorly studied. Most sugars exist with both L- and D- configurations naturally, just with different abundances. However, only D-bacillosamine has been reported so far. Since we had a precursor directly available in stock which could be easily converted to L-bacillosamine, here I also inadvertently did some work on L-bacillosamine which could possibly be a useful reference for future study.

The synthesis work has not been finished but my study has established the main route towards the target molecules and the final compounds are within reach.

3.2 Retrosynthetic Analysis of the Chemical Syntheses of 3-1, 3-2 and 3-3

Disaccharide **3-1** and tetrasaccharide **3-2** are from *S. suis* serotype 3 containing one repeating unit and two repeating units respectively.

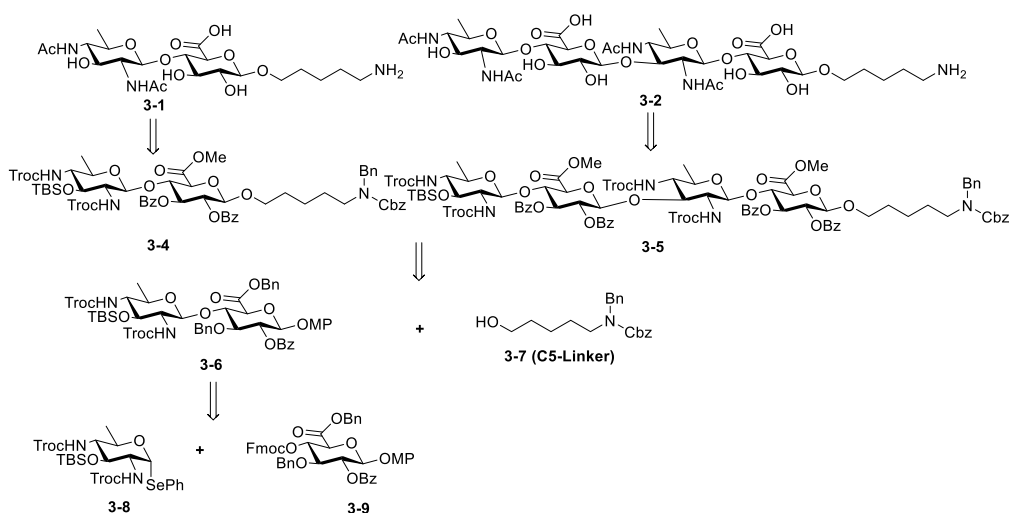

Scheme 17 Retrosynthetic analysis of the epitopes **3-1** and **3-2** from SS3

Scheme 17 shows an extendable strategy to synthesize **3-1** and **3-2**. Both protected oligosaccharides **3-4** and **3-5** before global deprotection could be synthesized using the disaccharide building block **3-6** and a commonly used amino linker, C-5 linker (**3-7**). Glycosylation between the two sugar building blocks **3-8** and **3-9** required β selectivity by a neighboring participating group. Mechanism of the participating of 2-NHTroc group is similar as described in **Scheme 5**. The 2-NHAc group can also act as a participating group, but it would significantly decrease the reactivity of the donor and lead to an extremely low yield of the glycosylation reaction. Alternative protective groups also include TCA instead of Troc and can be used in different strategies according to the conditions needed.

After the synthesis of disaccharide **3-4** and TBS deprotection at C3 position of the bacillosamine residue, another disaccharide could be glycosylated to obtain tetrasaccharide **3-5**. The target molecules **3-1** and **3-2** could then be realized after deprotection.

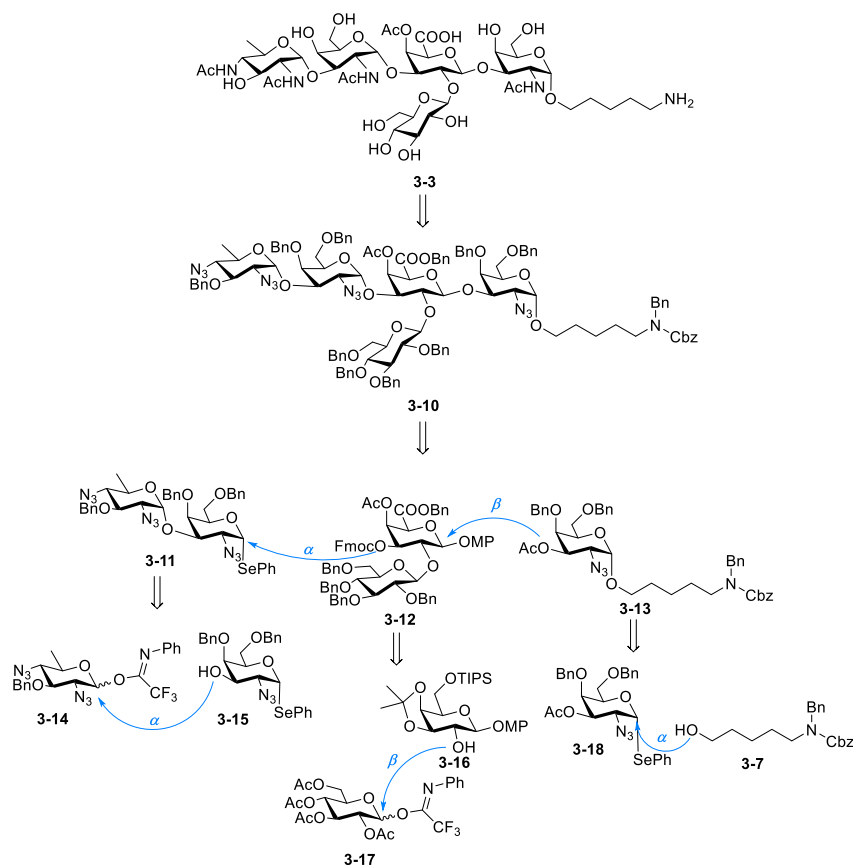

Scheme 18 Retrosynthetic analysis of the epitope 3-3 from SS18

As the structure of **3-3** from SS18 is more complicated, I decided to divide the protected pentasaccharide **3-10** into three parts, **3-11**, **3-12** and **3-13** which could be synthesized from monosaccharide building blocks and C-5 linker. All the sugar building blocks to form residues with 2-amino group in the final compound, **3-14**, **3-15** and **3-18** were donors for α glycosylations, so their C2 positions were all converted to azido groups for better α selectivity. Compounds **3-15** and **3-18** were quite similar building blocks and **3-18** could just be obtained from **3-15** by the installation of 4-acetate group.

The most complicated part as shown in **Scheme 18** was **3-12**. As **3-17** was connected to **3-16** with a β glycosylation bond, I planned to use per-acetylated glucose to do the reaction and change all of its Ac groups into Bn groups on the disaccharide before the acetylation at C4 position of **3-16** residue. Oxidation at the C6 position and selective acetylation at the C4 position at the galacturonic acid residue could produce the core **3-12** disaccharide building block.

3.3 Results and Discussions

3.3.1 Study of the Synthesis of the Epitopes from SS3

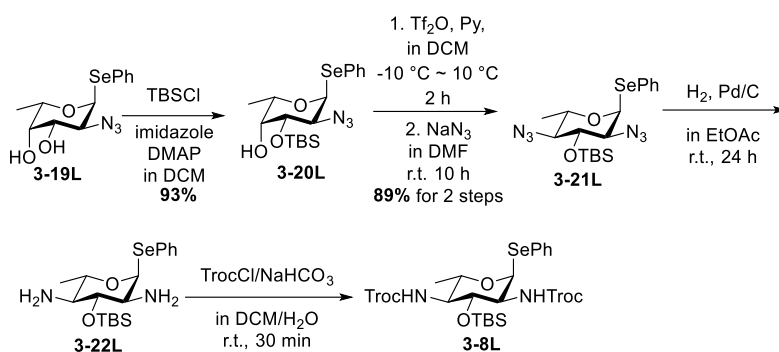

Scheme 19 Synthesis of L-bacillosamine building block **3-8L**

Commercially available **3-19L** is an L-fucose building block which could be converted to L-bacillosamine by the inversion of 4-OH into 4-azido group. Before conversion of the C4 position, the 3-hydroxyl group was first protected with TBS. Excess TBSCl and DMAP were used for a higher yield and 4-OH was safe to stay unprotected. After **3-21L** was made, the two azido groups were reduced by hydrogenation and protected with a 2,2,2-trichloroethoxycarbonyl group (Troc) to obtain **3-8L** for further β -glycosylation.

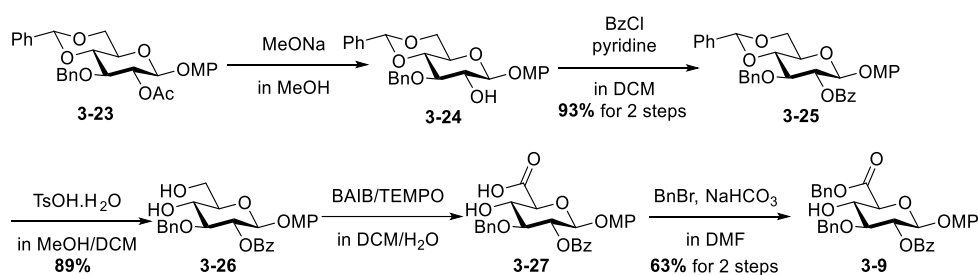

Scheme 20 Synthesis of the glycuronic acid building block **3-9**

Another building block **3-9** was synthesized from a glucose intermediate **3-23** that was prepared by Dr. Someswara R. Sanapala. The acetyl group at the C2 position was changed to benzoyl since deacetylation occurred during glycosylations with the bacillosamine building block. The cleavage mechanism was not clear, but the benzoyl group at the C2 position was stable during glycosylations. The C6 position was oxidized to carboxyl group and protected with a benzyl group. As glucuronic acid is a relatively unreactive building block for glycosylation, the 3-OBn and 6-COObn were used instead of 3-OBz and 6-COOMe to enhance the reactivity for a better glycosylation yield. The

benzoyl group at the C2 position was kept for neighboring participating effect in future glycosylation to ensure β selection as a donor.

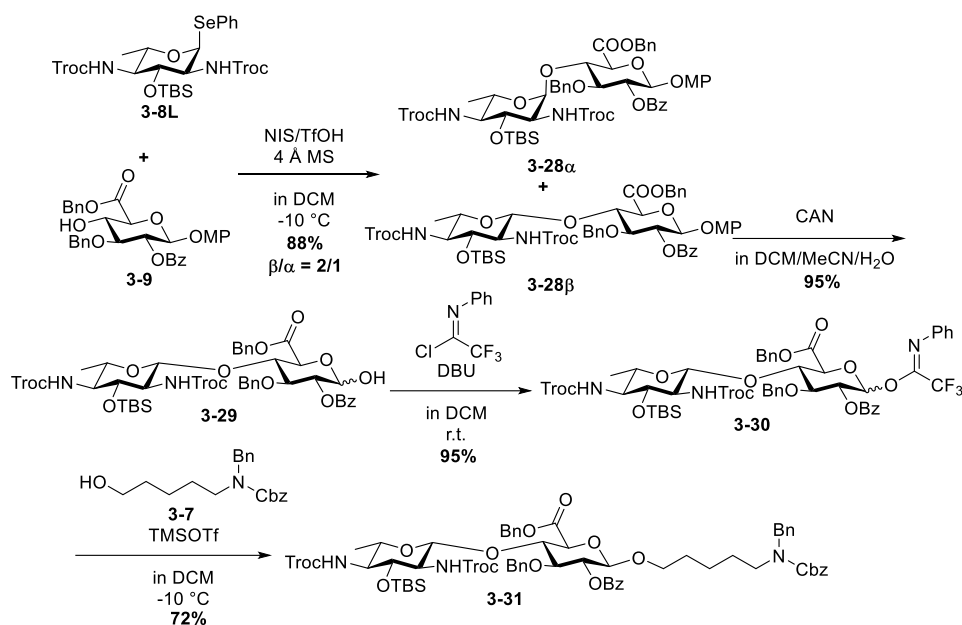

Scheme 21 Assembly of the disaccharide 3-31

Glycosylation of **3-8L** and **3-9** gave mixed α and β disaccharide products. Although more β product was produced, the existence of α product was unexpected considering the participation of the 2-NHTroc group. Further replacement of OMP at the anomeric position was modified to imidate and glycosylation with C-5 linker gave the disaccharide **3-31**.

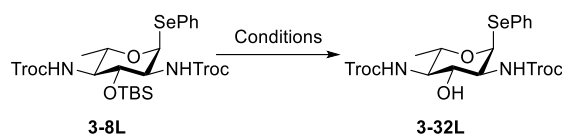

Entry	Condition	Result
1	TBAF	Troc also deprotected;
2	AcOH	No reaction;
3	HCl	No reaction;
4	CSA 0.5 eq.	~5% overnight (TLC);
5	CSA 1.0 eq.	~20% overnight (TLC);
6	CSA 4.0 eq.	~50% overnight (TLC);
7	CSA 6.0 eq.	63% overnight (isolated);
8	CSA 10 eq.	93% overnight (isolated);

Table 2 Different conditions for TBS deprotection of 3-8L

Cleavage of TBS on **3-31** would allow for further coupling of another disaccharide to obtain tetrasaccharide. Different conditions were first tested on the monosaccharide model molecule **3-8L**. (**Table 2**) Regular deprotection of TBS did not work well in this case as Troc groups were deprotected at the same time. As TBS is an acidic labile protecting group, different acids were used for its cleavage. After different trials, I found that 10 eq. of CSA worked excellently for the TBS deprotection and this condition was used on **3-31**.



Scheme 22 TBS deprotection of **3-31**

Unfortunately, the deprotection on the disaccharide **3-31** did not work as planned. The product was observed but the yield was quite low compared to the model reaction. In order to improve the yield, the trichloroacetyl group (TCA) was used instead of Troc to protect the amino groups.

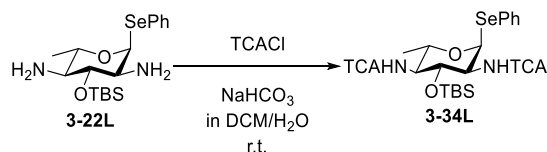

Scheme 23 Synthesis of **3-34L**

TCA protected **3-34L** could be easily made from **3-22L** for next steps.

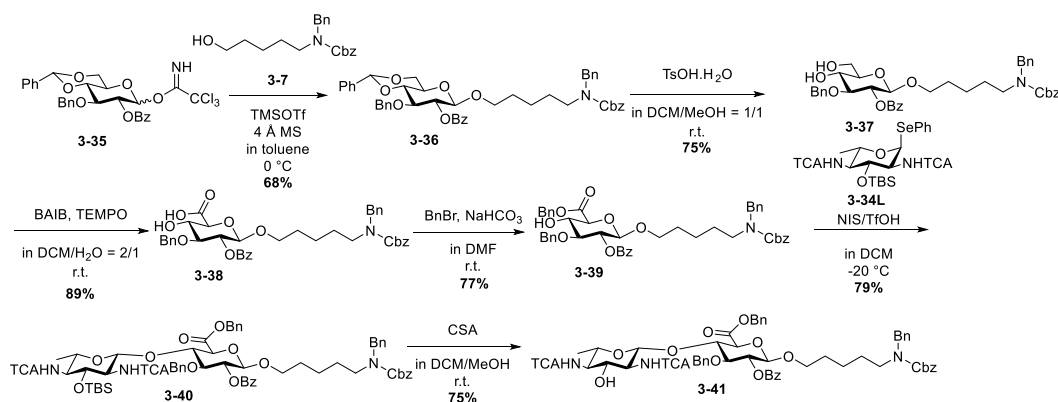

Scheme 24 Synthesis of disaccharide **3-41**

With the new bacillosamine building block **3-34L** in hand, I made **3-40** with similar procedure for TBS deprotection and this time the yield improved to 75% so that I had **3-41** ready for further coupling of another molecule of disaccharide **3-30**.

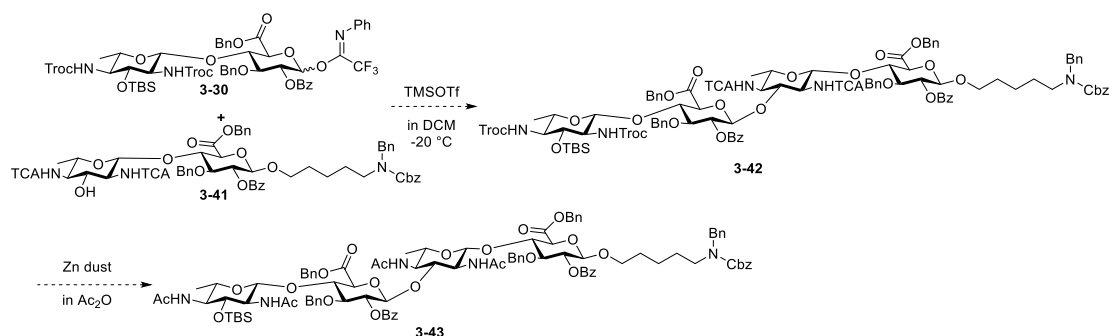

Scheme 25 A 2+2 glycosylation to get tetrasaccharide, but product not pure.

With **3-30** and **3-41** in hand, a 2+2 glycosylation was performed to obtain tetrasaccharide **3-42**. The mass of **3-42** could be nicely detected. However, isolation was quite problematic. TLC showed severe tailing of the spots with different eluent systems, and the product could not be purified using a normal silica gel column or even HPLC. Further reaction with activated zinc powder in acetic anhydride over night gave **3-43** where the amino groups all became NHAc. But the problematic tailing was still observed. Based on experience of previous work, these isolation difficulties were assumed to be from too many amino groups.

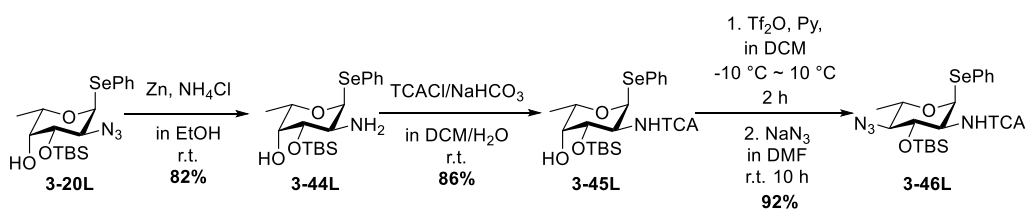

Scheme 26 Remodification of the L-bacillosamine to obtain **3-46L**

Remodification of the L-bacillosamine building block is shown in **Scheme 26** where the reduction of the 2-azido group was performed before the inversion of 4-OH. In the reduction step, mild conditions were applied to avoid the cleavage of TBS and SePh groups to get **3-44L**. Following TCA protection on 2-amino group and inversion of 4-OH gave the desired structure **3-46L**.

The assembly of the tetrasaccharide was similar as before, shown in **Scheme 27**. This time the product of the 2+2 glycosylation could be isolated but the yield was still very low.

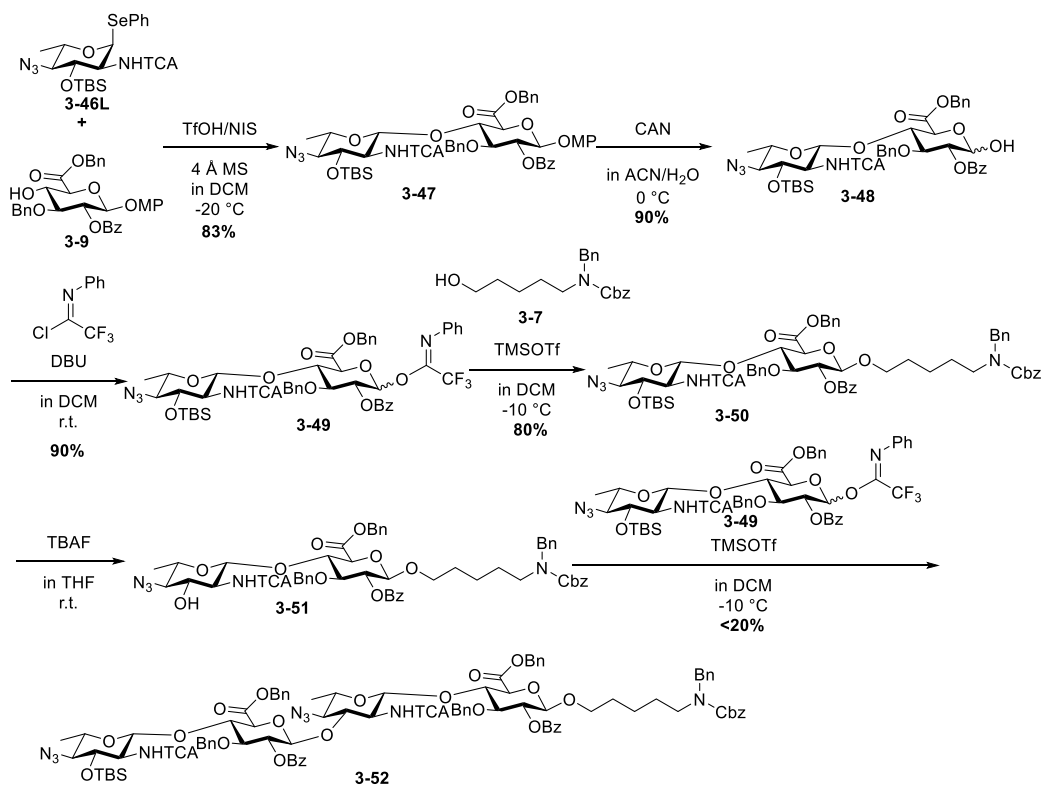

Since the study showed a low yield of the 2+2 glycosylation, it was assumed that this result came from the configuration of the disaccharide with the unnatural L-bacillosamine.

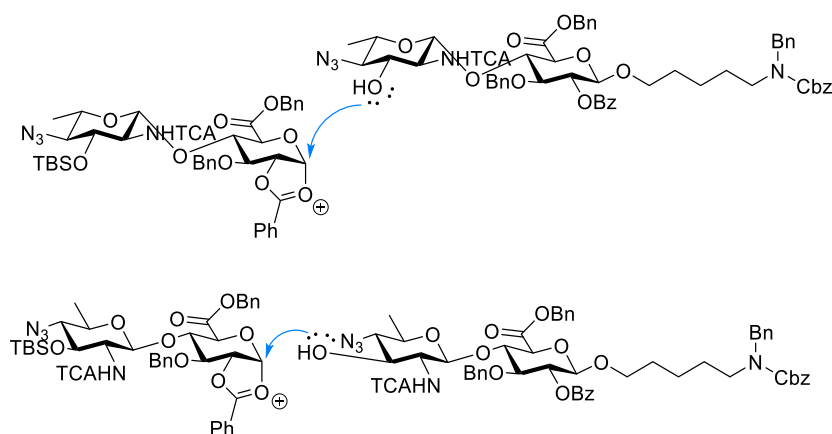

If I change the L-bacillosamine into natural D-bacillosamine, the situation would probably be different. More importantly, it is also needed to synthesize the final compounds **3-1** and **3-2** as epitopes of vaccine candidates against SS3.

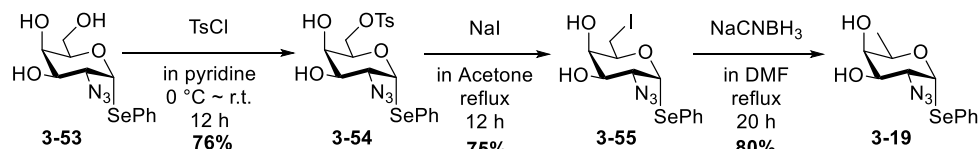

Scheme 28 Synthesis for D-fucose building block **3-19**

Reactions for modification of the monosaccharide building block would be just the same as L- or D- configurations for the same sugar. To synthesize the D-bacillosamine, I made **3-19** (the D-configuration of **3-19L**), starting from commercially available **3-53**. The C6 position was first converted to 6-OTs by toluenesulfonation, followed by the substitution of iodine to provide **3-55**. The 2-azido group was sensitive to strong reductive reagents, and benzeneselenol leaving group at the anomeric position was incompatible with $n\text{Bu}_3\text{SnH/AIBN}$ conditions. In order to convert **3-55** into a 6-deoxy sugar, a mild reductive reagent NaCNBH_3 was applied and **3-19** was obtained in good yield.

Schmidt+Haensch Serial No.: 2-azido-FucSePh.dmp Page 1 12.09.2019							Schmidt+Haensch Serial No.: SS3-A-35-191108-OR.dmp Page 1 08.11.2019						
SEEBERGER Method C User name TEST SampleID BAC-SM							SEEBERGER Method C User name SDC SampleID SS3-A-35						
09/12/2019 19:02							11/08/2019 11:53						
Angle	Temp. [°C]	Abs.	Tube mm	Conc. g/100ml	[α]		Angle	Temp. [°C]	Abs.	Tube mm	Conc. g/100ml	[α]	
-2.872	25.00	2.0	100	1.00	-287.24	3-19L	2.469	25.00	0.6	100	0.90	274.26	3-19
-2.866	25.00	2.0	100	1.00	-286.59		2.472	25.00	0.6	100	0.90	274.54	
-2.859	25.00	2.0	100	1.00	-285.94		2.470	25.00	0.6	100	0.90	274.35	
-2.845	25.00	2.0	100	1.00	-284.58		2.470	25.00	0.6	100	0.90	274.41	
-2.835	25.00	2.1	100	1.00	-283.57		2.472	25.00	0.6	100	0.90	274.58	
-2.855	25.00	2.0	1.00	1.00	-285.58		Mean	2.470	25.00	0.6	0.90	274.43	
0.014959	0.000	0.03	0.00000	0.00000	1.49609	Std.dev.	0.001208	0.000	0.00	0.00000	0.13419	Std.dev.	

Figure 19 Optical rotations of **3-19L** and **3-19**

The optical rotation values of **3-19L** and **3-19** were almost the opposite. Together with the same NMR data, we concluded that these two structures were enantiomers. Further modification procedures on monosaccharide will be the same for **3-19** and **3-19L**, and the final compound could hopefully be obtained without much difficulty.

3.3.2 Study of the Synthesis of the Epitope from SS18

To synthesize the epitope from SS18, I started from the most challenging part, **3-12** where the most complicated modifications were required.

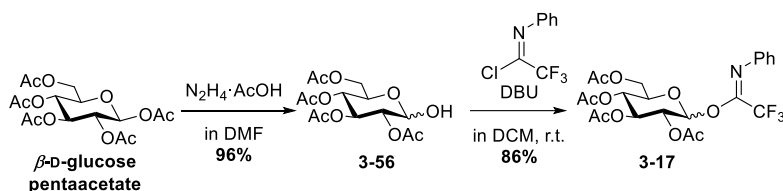

Scheme 29 Synthesis of **3-17**

Glycosyl acetimidate **3-17** was easily made from β -D-glucose pentaacetate, through a selective hydrolysis at the anomeric position and the installation of the imidate leaving group. The acetyl group at the C2 position guaranteed the β glycosylation and acetyl groups could also be easily changed into other protective groups needed at a later stage of the synthesis route.

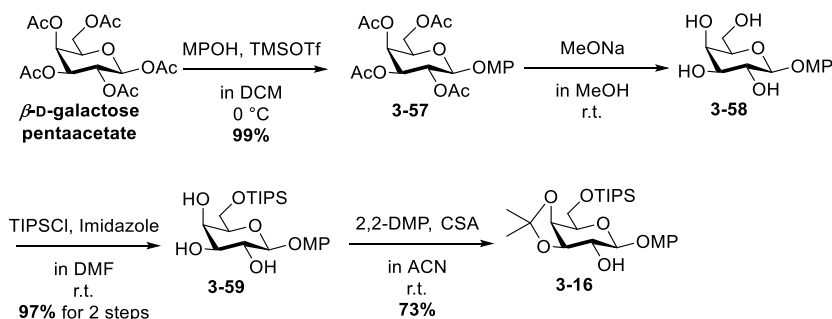

Scheme 30 Synthesis of **3-16**

Scheme 30 shows the modification of building block **3-16**, which was the core residue in the final compound of SS18. During the modification, the C6 position was selectively protected with bulky triisopropylsilyl group (TIPS), followed by isopropylidene protection at C3 and C4 positions. The unprotected 2-hydroxyl group would be glycosylated by **3-17** and the disaccharide building block could be further modified.

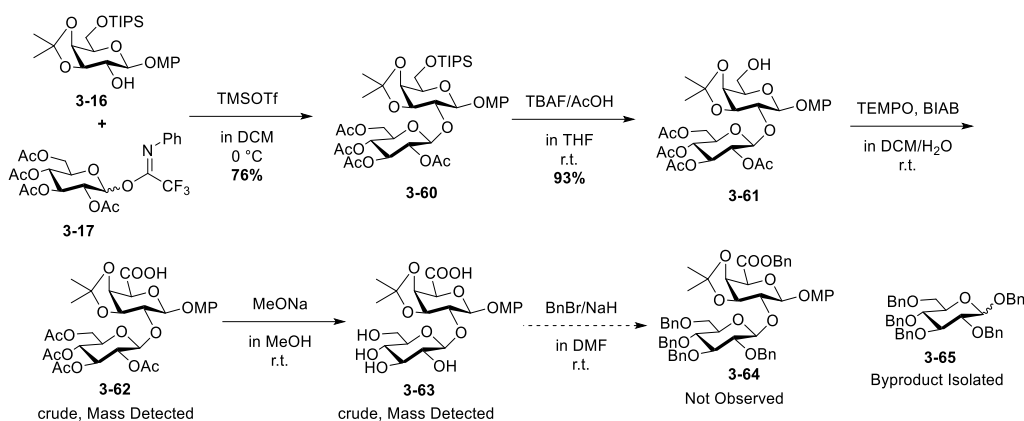

Scheme 31 Glycosylation to get 3-60 and first modification strategy

The glycosylation between **3-16** and **3-17** was smooth to give β -selective disaccharide **3-60**. After the deprotection of TIPS at the C6 position, oxidation of the primary 6-OH mediated by (2,2,6,6-tetramethylpiperidin-1-yl)oxyl (TEMPO) and bis(acetoxy)iodobenzene (BIAB) gave **3-62**. In order to protect all the hydroxyl groups on the glucose residue as well as the 6-carboxyl position with benzyl groups, I cleaved the acetyl groups first to get **3-63** and tried to do perbenzylation at all the unprotected positions all at once. Unfortunately, the desired product **3-64** was not observed, while cleavage of the glycosidic bond was observed by the detection of the mass of **3-65**.

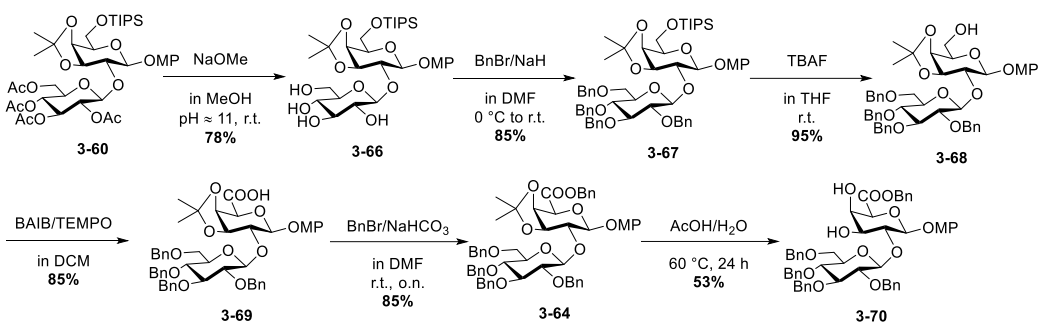

Scheme 32 Second modification strategy of 3-60

An alternative strategy was used where the acetyl groups were changed into benzyl groups before deprotection of TIPS. This time, the glycosidic remained intact during the benzylation and further modification of the C6 position did not cause any problem. Benzylation of the carboxyl group only required mild base such as NaHCO_3 and other places would not be affected under these conditions. After **3-64** was obtained, isopropylidene was cleaved and the next step was to selectively put a temporary protective group at the C3 position that must be orthogonal to acetyl group. This was

required by the final compound where the C4 position was acetylated in the deprotected form.

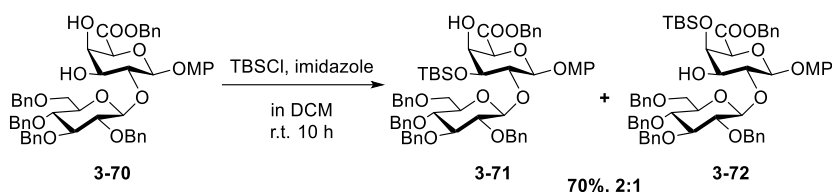

Scheme 33 Selective TBS protection of 3-70

I first tried selective TBS protection as the C4 position is usually much less reactive than the C3 position. In this case, however, I did get more desired compound **3-71** but the selectivity was not very good.

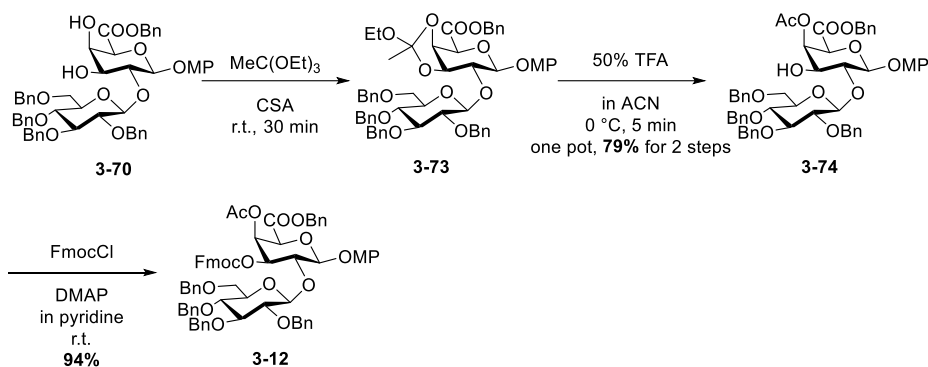

Scheme 34 Selective acetylation of 3-70

After literature research, I thought the selective acetylation at C4 position mediated by an orthoester intermediate method was worth trying.⁹⁸ The orthoester is installed under similar conditions as the isopropylidene protection, and with TFA to open the 5-membered ring, I only obtained the desired product **3-74**. I assume that the reason was that the oxygen at the C3 position was much easier to be protonated and after cleavage the acetyl group would stay at C4 position. Fmoc protection of **3-74** using pyridine could keep 4-OAc to get the desired core disaccharide **3-12**.

Successful synthesis of the most complicated disaccharide part **3-12** gave me confidence to prepare the target pentasaccharide **3-3** and the next step is the syntheses of the other two parts **3-13** and **3-11**.

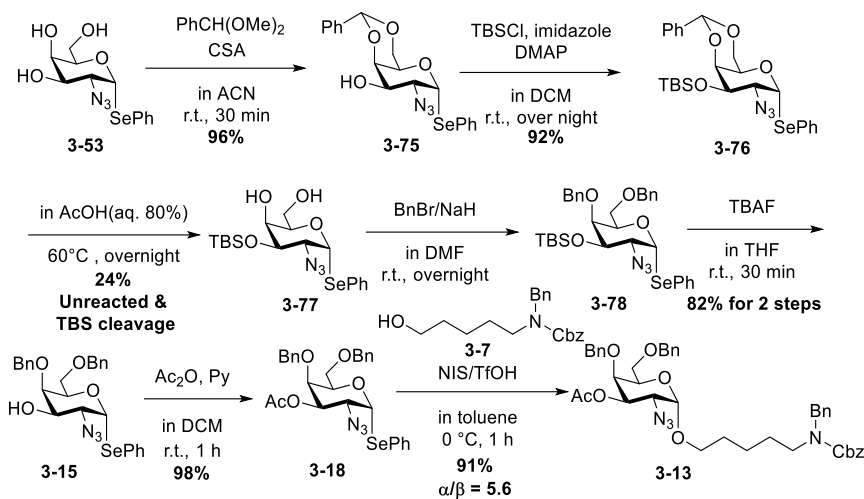

Synthesis of **3-13**, a 2-azido galactose connected to the C-5 linker, started from **3-53** which was also used in the SS3 part. The C4 and C6 positions were protected with benzylidene, followed by the installation of TBS at the C3 position. After benzylidene was cleaved, the C4 and C6 positions were benzylated to get **3-78**. 2-Azido group was kept as it favored α -glycosylation. As TBS was labile in acidic conditions, it was changed into 3-OAc and the glycosylation of **3-18** with the linker **3-7** provided **3-13**. The intermediate of the synthesis, **3-15** could also be used in the synthesis of the third part **3-11**.

With the most challenging problem of the synthesis route solved, after synthesis of the bacillosamine building block **3-14**, the assembly of the saccharides and deprotection, **3-3** will be obtainable.

3.4 Conclusion and Outlooks

In this chapter, I have described some initial study by chemical synthesis of the antigens for the development of the vaccine candidates against the important swine pathogen *Streptococcus suis*. The unique character of the serotypes I focused on, SS3 and SS18, was the bacillosamine they contained. Bacillosamine is considered as an important virulence factor of the bacteria, but has been studied poorly before, especially for its L-configuration. My work on the L-bacillosamine provided some initial understanding of its structure and properties.

I also established the synthetic route to get the final epitopes **3-1**, **3-2** and **3-3** for the development of the vaccines against SS3 and SS18. Although the final compounds were not obtained due to time limitation, most of the obstacles had been overcome through my study.

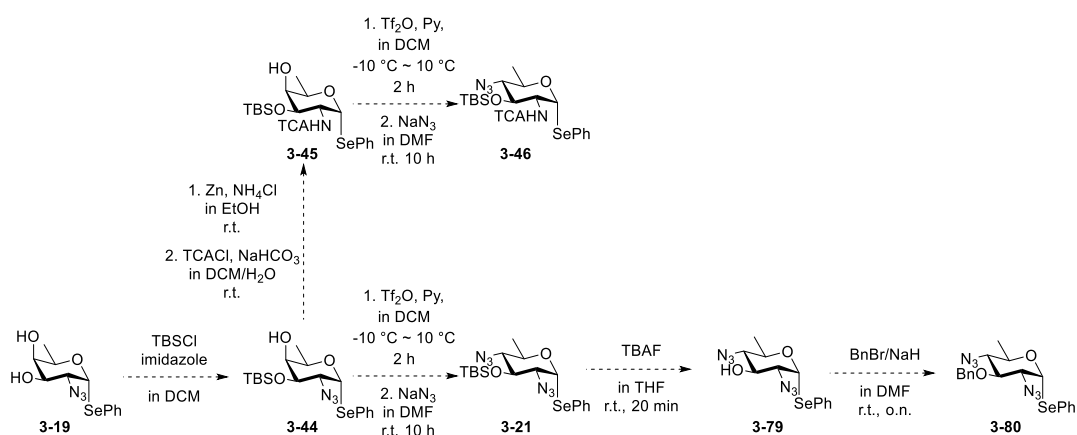

Scheme 36 3-46 and 3-80 could be made from 3-19 for syntheses of final epitopes.

Based on the work in this chapter, future work will be the synthesis of the D-bacillosamine building blocks and finally target epitopes **3-1**, **3-2** and **3-3** for further vaccine development against SS3 and SS18.

4 Experimental Section

4.1 Reagents and General Procedures

Commercially available reagents were used without further purification except otherwise indicated. All batch reactions were conducted under an N₂ or Ar atmosphere. ¹H-NMR and ¹³C-NMR spectra were measured with an Ascend 400-MHz, Agilent 400-MHz, Agilent 600-MHz or Ascend 700-MHz spectrometer. The proton signal of residual, non-deuterated solvent (δ 7.26 ppm for CHCl₃; δ 4.87 ppm for Methanol; δ 4.79 ppm for H₂O) was used as an internal reference for ¹H spectra. For ¹³C spectra, the chemical shifts were reported relative to the respective solvent (δ 77.16 ppm for CHCl₃). Coupling constants were reported in Hertz (Hz). The following abbreviations are used to indicate the multiplicities: s, singlet; d, doublet; t, triplet; m multiplet. Infrared (IR) spectra were recorded as thin films on a Perkin Elmer Spectrum 100 FTIR spectrophotometer. Optical rotations (OR) were measured with a Schmidt & Haensch UniPol L 1000 at 589 nm and a concentration (c) expressed in g/100 mL. High-resolution mass spectra (HRMS) were recorded with an Agilent 6210 ESI-ToF mass spectrometer. MALDI-ToF spectra were recorded on a Bruker Daltonics Autoflex Speed, using a 2,5-dihydroxybenzoic acid (DHB) or 2',6'-dihydroxyacetophenone (DHAP) matrix. Analytical thin layer chromatography (TLC) was performed on Macherey-Nagel pre-coated TLC plates SIL G-25 UV₂₅₄. The TLC plates were visualized with UV light and by staining with CAM (ceric sulfate and ammonium molybdate in aqueous sulfuric acid) or sugar stain (2N H₂SO₄ and resorcinol monomethyl ether (0.2%) in ethanol). Column chromatography was performed using silica gel 60 (230–400 mesh). Size exclusion chromatography (SEC) was performed using Sephadex[®] LH-20 or G-25 (GE Healthcare).

4.2 Chemical Synthesis for the Epitopes from KPST258

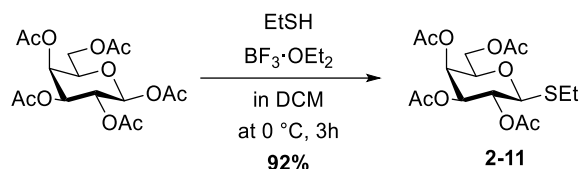
Ethyl 2,3,4,6-tetra-*O*-acetyl-1-thio- β -D-galactopyranoside (2-11)

1,2,3,4,6-Penta-*O*-acetyl- β -D-galactose (5.3 g, 13.6 mmol) was dissolved in anhydrous DCM (65 mL). EtSH (1.4 mL) was added and the mixture was cooled to 0 °C (water-ice bath). $\text{BF}_3 \cdot \text{OEt}_2$ (2.8 mL, 22.5 mmol) was then added and the mixture was allowed to be stirred at that temperature for 5 h. TLC showed the starting material was fully converted and the reaction was quenched by $\text{NaHCO}_3(\text{aq.})$ The product was extracted with DCM for three times and the organic layer was combined and washed with brine, dried with $\text{Na}_2\text{SO}_4(\text{s})$ and concentrated *in vacuo*. The product was further purified by flash chromatography to get **2-11** (4.9234 g, 92%, white solid, $\beta:\alpha = 5:1$). ^1H NMR (400 MHz, Chloroform-*d*) δ 5.42 (dd, $J = 3.4, 1.1$ Hz, 1H), 5.23 (t, $J = 10.0$ Hz, 1H), 5.04 (dd, $J = 10.0, 3.4$ Hz, 1H), 4.49 (d, $J = 10.0$ Hz, 1H), 4.19 – 4.06 (m, 2H), 3.93 (td, $J = 6.7, 1.2$ Hz, 1H), 3.19 (qd, $J = 7.3, 4.8$ Hz, 1H), 2.83 – 2.61 (m, 2H), 2.15 (s, 3H), 2.06 (s, 3H), 2.04 (s, 3H), 1.98 (s, 3H), 1.39 (t, $J = 7.3$ Hz, 1H), 1.28 (t, $J = 7.5$ Hz, 3H). ^{13}C NMR (101 MHz, Chloroform-*d*) δ 170.6, 170.4, 170.2, 169.7, 84.2, 77.5, 77.4, 77.2, 76.8, 74.5, 72.0, 67.4, 67.3, 61.6, 47.1, 24.5, 21.0, 20.8, 20.8, 15.0, 8.9. Data compatible with literature reported.⁹⁹

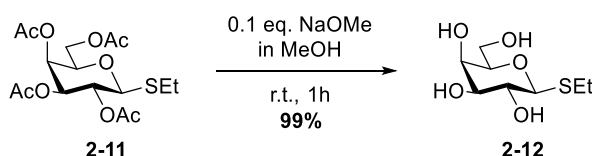
Ethyl 1-thio- β -D-galactopyranoside (2-12)

Thioglycoside **2-11** (5.2238 g) was dissolved in methanol (120 mL) and MeONa (0.5 M in MeOH, 3 mL) was added to the mixture. The solvent was stirred at r.t. and the reaction was monitored by TLC. After the starting material was disappeared, the reaction was quenched with Amberlite and the pH of the mixture was adjusted to 7. **2-12** was obtained by filtration and the removal of the solvent to get white foam

2.9620 g. Yield: 99%. ^1H NMR (400 MHz, CD_3OD) δ 4.32 (d, $J = 9.5$ Hz, 1H), 3.92 – 3.83 (m, 1H), 3.71 (qd, $J = 11.4, 6.1$ Hz, 2H), 3.58 – 3.49 (m, 2H), 3.46 (dd, $J = 9.2, 3.3$ Hz, 1H), 2.83 – 2.66 (m, 2H), 1.29 (t, $J = 7.5$ Hz, 3H). ^{13}C NMR (101 MHz, CD_3OD) δ 87.4, 80.6, 76.3, 71.4, 70.5, 62.6, 49.6, 49.4, 49.2, 49.0, 48.8, 48.6, 48.4, 24.9, 15.5.

Data compatible as reported.¹⁰⁰

Ethyl 4,6-*O*-benzylidene-1-thio- β -D-galactopyranoside (2-13)

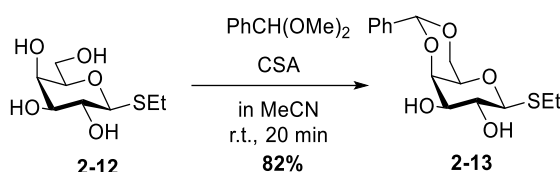

Thioglycoside **2-12** (2.0934g, 9.33 mmol) was put into a flask and anhydrous MeCN (80 mL) was added as solvent. The white solid didn't dissolve well. CSA (1.0917 g, 4.7 mmol) and benzaldehyde dimethyl acetal (2.80 mL, 18.67 mmol) was then added. Shortly after that, the solid totally dissolved and after 10 min, TLC showed that the starting material was fully converted. Et_3N was added to quench the reaction and the mixture was evaporated *in vacuo*. After most of the solvents were gone, the mixture (colorless syrup) was extracted with EtOAc and washed with water (100 mL) and brine (100 mL). The organic layer was then evaporated and the resultant (white solid) was put under vacuum overnight to get 2.3930 g **2-13**, 82%. ^1H NMR (400 MHz, Chloroform-*d*) δ 7.56 – 7.45 (m, 2H), 7.41 – 7.33 (m, 3H), 5.54 (s, 1H), 4.35 (d, $J = 10.8$ Hz, 2H), 4.25 (d, $J = 3.7$ Hz, 1H), 4.03 (d, $J = 12.6$ Hz, 1H), 3.81 (t, $J = 9.3$ Hz, 1H), 3.69 (td, $J = 8.9, 3.6$ Hz, 1H), 3.52 (s, 1H), 3.33 (s, 1H), 2.94 – 2.70 (m, 2H), 2.70 – 2.44 (m, 2H), 1.35 (t, $J = 7.4$ Hz, 3H). ^{13}C NMR (101 MHz, Chloroform-*d*) δ 137.7, 129.5, 128.4, 126.5, 101.6, 85.4, 77.5, 77.4, 77.2, 76.8, 75.7, 74.0, 70.2, 69.8, 69.4, 23.6, 15.4. Data compatible as reported.¹⁰¹

Experimental Section

Ethyl 2,3-di-*O*-benzyl-4,6-*O*-benzylidene-1-thio- β -D-galactopyranoside (2-14)

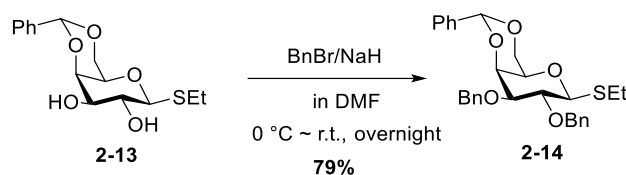

Thioglycoside **2-13** (2.8942 g, 9.26 mmol, 1 eq.) was dissolved in anhydrous DMF (45 mL) and cooled to 0 °C using ice-water bath. NaH (60% in mineral oil, 1.112 g, 27.8 mmol, 3.0 eq.) was then added to the solution and the resultant suspension was stirred for 15 min before BnBr (3.31 mL, 27.8 mmol, 3 eq.) was injected slowly into the mixture. After 10 min, the ice-water bath was removed and the mixture was allowed to be stirred overnight. TLC showed that the starting material was totally converted and the reaction was quenched by MeOH at 0 °C. After the solvents were evaporated, the product was extracted with EtOAc, washed with water and brine, dried with Na₂SO₄(s), and concentrated *in vacuo*. The product was further purified by silica gel chromatography (hexane:EtOAc = 6:1) to get **2-14**, 3.604 g, white solid, Yield: 79%. ¹H NMR (400 MHz, Chloroform-*d*) δ 7.59 – 7.44 (m, 2H), 5.47 (s, 1H), 4.95 – 4.81 (m, 2H), 4.80 – 4.71 (m, 2H), 4.43 (d, *J* = 9.6 Hz, 1H), 4.30 (dd, *J* = 12.3, 1.6 Hz, 1H), 4.15 (dd, *J* = 3.5, 1.0 Hz, 1H), 3.96 (dd, *J* = 12.4, 1.8 Hz, 1H), 3.89 (t, *J* = 9.4 Hz, 1H), 3.59 (dd, *J* = 9.2, 3.5 Hz, 1H), 3.35 (q, *J* = 1.5 Hz, 1H), 2.80 (ddq, *J* = 44.0, 12.5, 7.4 Hz, 2H), 1.33 (t, *J* = 7.4 Hz, 3H). ¹³C NMR (101 MHz, Chloroform-*d*) δ 138.5, 138.4, 138.1, 129.2, 128.5, 128.5, 128.4, 128.3, 127.9, 127.9, 127.8, 126.7, 101.6, 84.6, 81.3, 77.5, 77.2, 77.0, 76.8, 75.8, 74.1, 71.9, 69.9, 69.6, 23.9, 15.2. Data compatible as reported.¹⁰²

Ethyl 2,3-di-*O*-benzyl-1-thio- β -D-galactopyranoside (2-15)

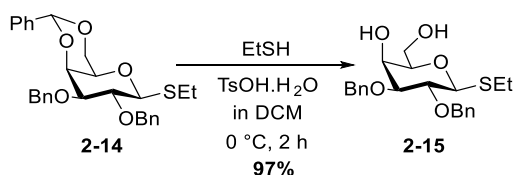

Thioglycoside **2-14** (0.8494g, 1.724 mmol, 1 eq.) was dissolved in 15 mL DCM. Ethane thiol (3.73 mL, 51.7 mmol, 30 eq.) and TsOH.H₂O (0.066g, 0.345 mmol, 0.2 eq.) was then added to the solution. The mixture was stirred at room temperature until the starting material was disappeared. The reaction was quenched with Et₃N, extracted with

EtOAc, washed with water, NaHCO₃ and brine, dried with Na₂SO₄(s) and concentrated *in vacuo*. **2-15** was then purified by FC to get 0.676 g white solid. Yield: 97%. ¹H NMR (400 MHz, Chloroform-*d*) δ 7.42 – 7.36 (m, 2H), 7.36 – 7.25 (m, 8H), 4.88 (d, *J* = 10.3 Hz, 1H), 4.75 (d, *J* = 10.3 Hz, 1H), 4.71 (s, 2H), 4.42 (d, *J* = 9.7 Hz, 1H), 4.04 (dd, *J* = 3.3, 1.1 Hz, 1H), 3.94 (dd, *J* = 11.8, 6.6 Hz, 1H), 3.78 (dd, *J* = 11.8, 4.5 Hz, 1H), 3.66 (t, *J* = 9.3 Hz, 1H), 3.54 (dd, *J* = 9.0, 3.3 Hz, 1H), 3.47 (ddd, *J* = 6.3, 4.6, 1.1 Hz, 1H), 2.75 (qq, *J* = 12.5, 7.4 Hz, 2H), 2.25 (s, 3H), 1.30 (t, *J* = 7.4 Hz, 3H). ¹³C NMR (101 MHz, Chloroform-*d*) δ 138.3, 137.8, 128.7, 128.5, 128.5, 128.2, 128.0, 128.0, 85.3, 82.4, 78.0, 78.0, 77.5, 77.2, 76.8, 76.0, 72.4, 67.6, 62.9, 25.0, 15.3. Data compatible as reported.⁸⁵

Ethyl 2,3-di-*O*-benzyl-4,6-di-*O*-acetyl-1-thio-β-D-galactopyranoside (**2-5SEt**)

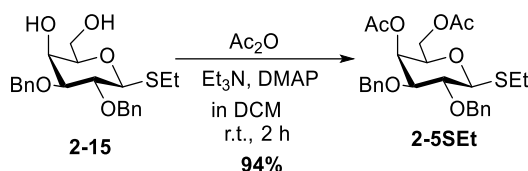

Thioglycoside **2-15** (0.6878 g, 1.7 mmol, 1 eq.) was dissolved in 10 mL anhydrous DCM and Et₃N (0.71 mL, 5.1 mmol, 3 eq.), Ac₂O (0.96 mL, 10.2 mmol, 6 eq.) and DMAP (0.042 g, 0.34 mmol, 0.2 eq.) were added sequentially into the solvent. After the starting material was disappeared, the mixture was diluted with EtOAc, washed with water twice, NaHCO₃ (aq.) and brine, dried with Na₂SO₄ (s) and concentrated *in vacuo*. **2-5SEt** was further purified by silica gel chromatography to get 0.778 g whitish syrup. Yield: 94%. ¹H NMR (400 MHz, Chloroform-*d*) δ 7.41 – 7.36 (m, 2H), 7.36 – 7.27 (m, 8H), 5.55 (d, *J* = 2.8 Hz, 1H), 4.82 (d, *J* = 10.2 Hz, 1H), 4.76 (d, *J* = 10.8 Hz, 2H), 4.52 (d, *J* = 11.1 Hz, 1H), 4.48 (d, *J* = 8.8 Hz, 1H), 4.15 (d, *J* = 2.0 Hz, 1H), 4.14 (d, *J* = 1.2 Hz, 1H), 3.78 (t, *J* = 6.4 Hz, 1H), 3.68 – 3.55 (m, 2H), 2.87 – 2.65 (m, 2H), 2.16 (s, 3H), 2.07 (s, 3H), 1.33 (t, *J* = 7.4 Hz, 3H). ¹³C NMR (101 MHz, d₂o) δ 170.7, 170.6, 138.2, 137.7, 128.5, 128.5, 128.5, 128.3, 128.0, 128.0, 85.6, 81.0, 77.8, 77.5, 77.2, 76.8, 76.0, 74.6, 72.2, 66.8, 62.4, 25.3, 21.1, 20.9, 15.2. Data compatible as reported.⁸⁵

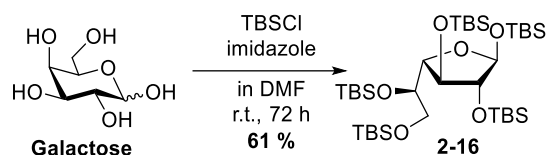
1,2,3,5,6-Penta-*O*-*tert*-butyldimethylsilyl- β -D-galactofuranose (2-16)

Galactose (10.0 g, 55.5 mmol, 1 eq.) was dissolved in 250 mL anhydrous DMF before imidazole (56.7 g, 833 mmol, 15 eq.) and TBSCl (52 g, 345 mmol, 6.22 eq.) was added to the solution. The mixture was stirred at room temperature overnight. The next day it became yellow transparent solution with white ball-like solid floating inside. TLC showed that the starting material was totally converted. The mixture was filtrated and washed with MeOH to get 25.5 g (33.9 mmol) white solid **2-16**. Yield: 61.1%. ^1H NMR (400 MHz, Chloroform-*d*) δ 5.15 (d, $J = 2.4$ Hz, 1H), 4.09 (dd, $J = 4.8, 2.9$ Hz, 1H), 4.00 (dd, $J = 4.8, 3.4$ Hz, 1H), 3.91 (t, $J = 2.7$ Hz, 1H), 3.74 (td, $J = 6.0, 3.3$ Hz, 1H), 3.67 (dd, $J = 9.8, 6.4$ Hz, 1H), 3.55 (dd, $J = 9.8, 5.7$ Hz, 1H), 0.91 – 0.86 (m, 46H), 0.11 – 0.03 (m, 35H). ^{13}C NMR (101 MHz, Chloroform-*d*) δ 103.0, 86.0, 84.5, 79.6, 77.5, 77.4, 77.2, 76.8, 74.2, 64.8, 26.2, 26.1, 26.1, 26.0, 25.9, 25.9, 25.8, 18.5, 18.5, 18.1, 18.1, 18.0, -3.7, -4.0, -4.0, -4.1, -4.4, -4.5, -4.9, -5.2, -5.2. Data compatible as reported.

103

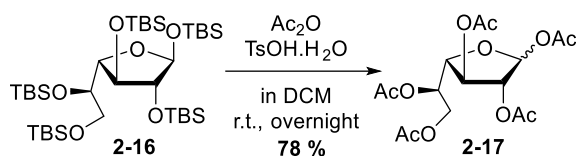
1,2,3,5,6-Penta-*O*-acetyl- β -D-galactofuranose (2-17)

Compound **2-16** (9.5 g, 12.64 mmol, 1 eq.) and *p*-toluenesulfonic acid (48.1 g, 253 mmol, 20 eq.) was put into a 500 mL flask and 100 mL anhydrous DCM was added as solvent. The mixture was stirred at r.t. and Ac₂O (59.6 mL, 632 mmol, 50 eq.) was dropped slowly into the mixture. It became transparent after 90 min. After 72 h, the TLC showed that the starting material was fully converted. The reaction was quenched by Et₃N and extracted using DCM. After being washed with H₂O (2 x 250mL), NaHCO₃ and brine, the organic layer was dried by Na₂SO₄(s) and concentrated *in vacuo*. The product **2-17** was further purified by flash chromatography to get light yellow syrup 3.8629 g. Yield: 78%. ^1H NMR (400 MHz, Chloroform-*d*) δ 6.18 (s, 1H), 5.36 (dt, $J =$

6.9, 4.1 Hz, 1H), 5.18 (dd, $J = 2.1, 0.7$ Hz, 1H), 5.08 (dd, $J = 5.4, 2.0$ Hz, 1H), 4.39 – 4.33 (m, 1H), 4.32 (d, $J = 4.0$ Hz, 1H), 4.21 (dd, $J = 11.9, 6.8$ Hz, 1H), 2.12 (dd, $J = 5.9, 2.2$ Hz, 14H), 2.08 (d, $J = 2.2$ Hz, 1H), 2.05 (s, 4H), 2.04 (s, 1H). ^{13}C NMR (101 MHz, Chloroform- d) δ 171.2, 170.6, 170.4, 170.1, 169.9, 169.9, 169.9, 169.8, 169.5, 169.3, 169.1, 99.1, 93.1, 82.1, 80.6, 79.1, 77.4, 77.2, 77.0, 76.7, 76.3, 75.3, 73.4, 70.3, 69.2, 62.6, 62.1, 60.4, 21.1, 21.0, 20.8, 20.8, 20.7, 20.7, 20.7, 20.5, 14.2. Data compatible as reported.¹⁰³

***p*-Tolyl 2,3,5,6-tetra-*O*-acetyl-1-thio- β -D-galactofuranoside (2-18)**

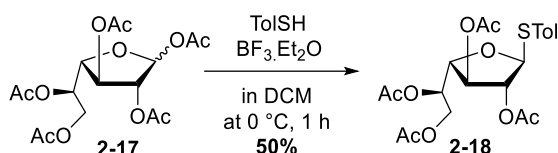

2-17 (1.9772 g, 5.07 mmol, 1 eq.) was put into a flask with a stirring bar.

p-Toluenethiol (1.573 g, 12.66 mmol, 2.5 eq.) was added and anhydrous DCM (35 mL) was added as solvent. After cooled with ice-water bath and stirred for 5 min, the mixture was added $\text{BF}_3 \cdot \text{OEt}_2$ (0.963 mL, 7.60 mmol, 1.5 eq.) dropwise and stirred at 0 °C until the starting material was fully converted. The reaction was then quenched with Et_3N , extracted with EtOAc , washed with water and brine, dried with $\text{Na}_2\text{SO}_4(\text{s})$ and concentrated *in vacuo*. The product was further purified with silica gel chromatography to get **2-18** as light yellow syrup. 1.048 g, 2.307 mmol, yield: 50%. ^1H NMR (400 MHz, Chloroform- d) δ 7.41 – 7.34 (m, 2H), 7.12 (d, $J = 7.9$ Hz, 2H), 5.43 (d, $J = 2.6$ Hz, 1H), 5.39 (dt, $J = 7.5, 4.2$ Hz, 1H), 5.21 (t, $J = 2.6$ Hz, 1H), 5.08 (dd, $J = 6.1, 2.7$ Hz, 1H), 4.47 (dd, $J = 6.2, 3.8$ Hz, 1H), 4.32 (dd, $J = 11.8, 4.6$ Hz, 1H), 4.18 (dd, $J = 11.7, 7.0$ Hz, 1H), 2.34 (s, 3H), 2.12 (d, $J = 0.7$ Hz, 3H), 2.10 (d, $J = 1.1$ Hz, 6H), 2.05 (s, 3H). ^{13}C NMR (101 MHz, Chloroform- d) δ 170.6, 170.1, 170.1, 169.7, 138.4, 133.1, 129.9, 129.3, 90.8, 81.3, 79.7, 77.5, 77.4, 77.2, 76.8, 76.6, 69.2, 62.7, 60.5, 21.3, 20.9, 20.9, 20.8, 20.8, 14.3. Data compatible as reported.¹⁰⁴

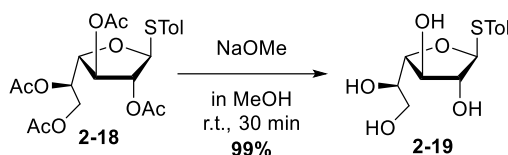
***p*-Tolyl 1-thio- β -D-galactofuranoside (2-19)**

Thioglycoside **2-18** (1.0483 g, 2.307 mmol, 1 eq.) was put into a flask and MeOH was added as solvent. MeONa (25 mg, 0.461 mmol, 0.2 eq.) was added and the mixture was allowed to be stirred at r.t.. After the full conversion of the starting material, Amberlite was added to the mixture and the pH was adjusted to 7. After filtration and the evaporation of the solvent, **2-19** (0.618 g, 2.158 mmol, yield: 99%) was obtained as white solid. ^1H NMR (400 MHz, Methanol- d_4) δ 7.41 (d, $J = 8.0$ Hz, 2H), 7.14 (d, $J = 7.8$ Hz, 2H), 4.14 – 4.05 (m, 1H), 3.99 – 3.90 (m, 2H), 3.74 (td, $J = 6.4, 2.7$ Hz, 1H), 3.62 (d, $J = 6.4$ Hz, 2H), 2.31 (s, 3H). ^{13}C NMR (101 MHz, $\text{CD}_3\text{OD_SPE}$) δ 138.9, 133.7, 131.7, 130.6, 93.0, 82.8, 82.7, 77.5, 71.8, 64.4, 49.6, 49.4, 49.3, 49.2, 49.0, 48.8, 48.6, 48.4, 21.1. Data compatible as reported.¹⁰⁵

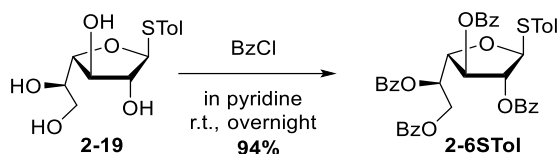
***p*-Tolyl 2,3,5,6-tetra-*O*-benzoyl-1-thio- β -D-galactofuranoside (2-6STol)**

Thioglycoside **2-19** (0.0710 g, 0.248 mmol, 1 eq.) was dissolved in pyridine (2 mL), BzCl (1, 0.138 mL, 1.190 mmol, 4.8 eq.) was added dropwise into the solvent and the resulted mixture was stirred at r.t. until the TLC showed a full conversion of the starting material. The mixture was concentrated, extracted with EtOAc, dried with Na_2SO_4 (s) and concentrated *in vacuo*. **2-6STol** was then purified by FC to get colorless syrup 0.164 g, 0.234 mmol. Yield: 94%. ^1H NMR (400 MHz, Chloroform- d) δ 8.07 (ddt, $J = 8.4, 7.1, 1.6$ Hz, 4H), 8.00 – 7.93 (m, 2H), 7.91 – 7.84 (m, 2H), 7.59 (ddt, $J = 8.8, 7.1, 1.3$ Hz, 1H), 7.52 (dddd, $J = 8.6, 5.1, 2.4, 1.4$ Hz, 3H), 7.48 – 7.41 (m, 4H), 7.41 – 7.27 (m, 6H), 7.11 – 7.04 (m, 2H), 6.14 – 6.06 (m, 1H), 5.77 (dt, $J = 1.6, 0.7$ Hz, 1H), 5.69 (ddd, $J = 5.1, 1.6, 0.9$ Hz, 1H), 5.65 (t, $J = 1.6$ Hz, 1H), 4.94 (ddd, $J = 4.9, 3.8, 0.7$ Hz, 1H), 4.73 (qd, $J = 11.8, 5.8$ Hz, 2H), 2.31 (s, 3H). ^{13}C NMR (101 MHz, Chloroform- d) δ 166.2, 165.8, 165.7, 165.5, 138.4, 133.8, 133.6, 133.4, 133.3, 133.2,

130.2, 130.1, 130.0, 129.9, 129.6, 129.5, 129.3, 129.0, 128.9, 128.7, 128.6, 128.5, 128.5, 91.7, 82.4, 81.5, 78.0, 77.5, 77.4, 77.2, 76.8, 70.4, 63.5, 60.6, 21.3, 21.2, 14.3. Data compatible as reported.¹⁰⁵

***N*-Benzyl-*N*-benzyloxycarbonyl-2,2-difluoro-3-amino-1-propanol (**2-8**)**

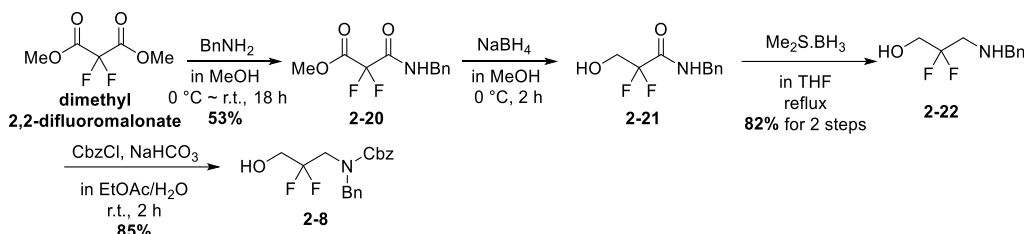

Fluorinated linker **2-8** was prepared following reported procedure and data were also matched.⁸⁴ Dimethyl 2,2-difluoromalonate (3.123 g, 18.58 mmol, 1.3 eq.) was dissolved in MeOH (100 mL) and the mixture was cooled to 0 °C using water-ice bath. A solution of BnNH₂ in MeOH (10 mL) was then added dropwise into the mixture. The ice-water bath was removed and the reaction was put at r.t. overnight. The mixture was filtrated, concentrated *in vacuo*, and purified by FC to get colorless syrup **2-20**, 1.808 g, 7.44 mmol. Yield: 52.1%. **2-20** (1.172 g, 4.82 mmol, 1.0 eq.) was dissolved in 25 mL MeOH. The mixture was cooled to 0 °C and NaBH₄ (0.911 g, 24.09 mmol, 5 eq.) was added. After 2 h, the reaction was quenched with water and the mixture was concentrated and extracted with EtOAc. The organic layer was washed with water and brine, dried with Na₂SO₄(s), filtrated and evaporated to get a crude product of **2-21**. The crude product was used at the next step without further purification. Crude **2-21** (0.854 g, 3.97 mmol, 1.0 eq.) was dissolved in THF (20.0 mL) and borane dimethylsulfide (2 M in THF, 5.95 mL, 11.9 mmol) was added to the solution. The mixture was refluxed for 3 h, quenched with MeOH and cooled to r.t.. After being stirred overnight, the mixture was evaporated to get 0.954 g crude **2-22** as colorless oil. To a stirred solution of **2-22** from last step in EtOAc (10 mL) was added NaHCO₃ (aq., sat., 10 mL) and CbzCl (0.744 mL, 5.21 mmol) at ambient temperature. After 90 min, TLC showed the full conversion of the starting material. The mixture was transferred to a separator and the the inorganic layer was extracted with EtOAc (20 mL x 3). The organic fractions were combined together, dried with Na₂SO₄(s) and concentrated *in vacuo*. The crude product was further purified by chromatography to get **2-8** (1.345 g,

Experimental Section

4.01 mmol). Yield: 85%. ^1H NMR (400 MHz, Chloroform-*d*) δ 7.42 – 7.27 (m, 8H), 7.22 – 7.10 (m, 2H), 5.23 (s, 2H), 4.60 (s, 2H), 3.66 (td, $J = 12.0, 10.3$ Hz, 4H). ^{13}C NMR (101 MHz, Chloroform-*d*) δ 158.3, 136.2, 135.7, 129.0, 128.8, 128.6, 128.2, 128.0, 127.7, 77.5, 77.2, 76.8, 68.7, 61.4, 51.8, 47.0.

Phenyl 3,4-*O*-isopropylidene-1-thio- β -D-galactopyranoside (2-23)

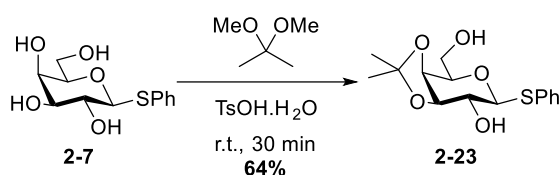

Thioglycoside **2-7** was synthesized and provided by Mr. Shuo Zhang from the Seeberger group via a known procedure.¹⁰⁵ **2-7** (2.027 g, 7.5 mmol, 1.0 eq.) was dissolved in 2,2-dimethoxypropane (40 mL). TsOH·H₂O (152 mg, 0.8 mmol, 0.1 eq.) was added to the solution and the mixture was stirred at r.t. until TLC showed a full conversion of the starting material. The reaction was quenched with TEA and the solvent was evaporated *in vacuo*. The crude product was extracted with EtOAc (100 mL), washed with water (100 mL) and brine (100 mL), dried with Na₂SO₄(s), concentrated and further purified with FC to get **2-23** (1.488 g, 4.77 mmol, yield: 64%). Data compatible as reported.¹⁰⁶

Phenyl 3,4-*O*-isopropylidene-2,6-di-*O*-benzyl-1-thio- β -D-galactopyranoside (2-24)

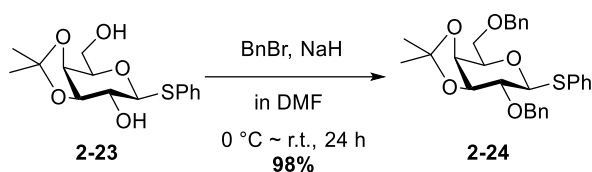

Thioglycoside **2-23** (3.415 g, 10.9 mmol, 1.0 eq.) was dissolved in anhydrous DMF (50 mL). The mixture was cooled to 0 °C and NaH (60% in mineral oil, 1313 mg, 32.8 mmol, 3.0 eq.) was added to the mixture. BnBr (4.0 mL, 32.8 mmol, 3.0 eq.) was added dropwise, the cooling bath was removed and the mixture was stirred overnight. TLC showed a full conversion of the starting material and the reaction was quenched with MeOH. Most of the solvent was removed by evaporation *in vacuo* and the residue was extracted with EtOAc, washed with water and brine, dried by Na₂SO₄(s),

concentrated and further purified by FC to obtain **2-24** (5.288 g, 10.7 mmol, yield: 98%). **2-24** was used in the next step directly.

Phenyl 2,6-di-*O*-benzyl-1-thio- β -D-galactopyranoside (**2-25**)

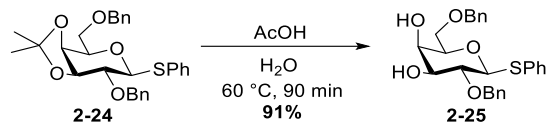

Thioglycoside **2-24** (2.160 g, 5.6 mmol) was dissolved in a mixed solvent of AcOH/H₂O (40 mL/10 mL). The mixture was stirred at 60 °C until the starting material was fully converted. The temperature was cooled to r.t. and the product was extracted with EtOAc (200 mL), washed with water (200 mLx2), NaHCO₃ (sat. aq., 200 mL) and brine (200 mL), dried with Na₂SO₄(s), concentrated and purified by FC to get **2-25** (1.806 g, 3.99 mmol). ¹H NMR (400 MHz, Chloroform-*d*) δ 7.49 – 7.42 (m, 2H), 7.33 – 7.14 (m, 13H), 4.73 (d, *J* = 10.3 Hz, 1H), 4.65 (d, *J* = 10.4 Hz, 1H), 4.60 (d, *J* = 3.0 Hz, 2H), 4.56 (d, *J* = 9.7 Hz, 1H), 3.96 (d, *J* = 3.2 Hz, 1H), 3.85 (dd, *J* = 11.7, 6.6 Hz, 1H), 3.76 – 3.63 (m, 2H), 3.48 (dd, *J* = 8.9, 3.1 Hz, 1H), 3.38 (dd, *J* = 6.6, 4.4 Hz, 1H), 2.61 (s, 2H). ¹³C NMR (101 MHz, Chloroform-*d*) δ 138.1, 137.6, 133.8, 131.7, 129.1, 128.6, 128.5, 128.3, 128.1, 128.0, 127.9, 127.5, 87.6, 82.4, 78.1, 77.5, 77.2, 77.0, 76.8, 75.8, 72.2, 67.3, 62.6. Data compatible as reported.¹⁰⁶

Phenyl 2,6-di-*O*-benzyl-3-*O*-fluorenylmethyloxycarbonyl-1-thio- β -D-galactopyranoside (**2-7SPh**)

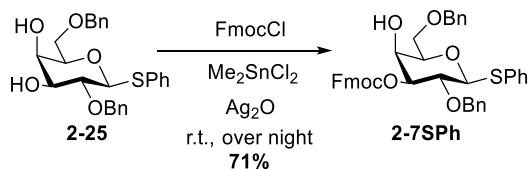

Thioglycoside **2-25** (1.806 g, 3.99 mmol, 1.0 eq.) was put into a flask and Ag₂O (1.017 g, 4.38 mmol, 1.1 eq.) and Me₂SnCl₂ (44 mg, 0.199 mmol, 0.05 eq.) were added. After MeCN (anhydrous, 35 mL) was added as solvent, FmocCl (1.576 g, 6.09 mmol, 1.5 eq.) was added to the suspension and the mixture was allowed to be stirred at r.t. over night. From TLC the starting material was fully converted. The mixture was

Experimental Section

filtrated with Celite and concentrated *in vacuo*. Thioglycoside **2-7SPh** was further purified with FC to get white solid 1.906 g (2.82 mmol), yield: 71%. ¹H NMR (400 MHz, Chloroform-*d*) δ 7.77 (d, *J* = 7.5 Hz, 2H), 7.65 – 7.56 (m, 4H), 7.44 – 7.22 (m, 18H), 4.86 (d, *J* = 10.5 Hz, 1H), 4.80 (dd, *J* = 9.5, 3.0 Hz, 1H), 4.70 (d, *J* = 9.7 Hz, 1H), 4.66 (d, *J* = 10.5 Hz, 1H), 4.64 – 4.54 (m, 2H), 4.45 (dd, *J* = 10.5, 7.2 Hz, 1H), 4.37 (dd, *J* = 10.4, 7.4 Hz, 1H), 4.29 (d, *J* = 3.0 Hz, 1H), 4.23 (t, *J* = 7.2 Hz, 1H), 3.93 (t, *J* = 9.6 Hz, 1H), 3.82 (qd, *J* = 10.2, 4.9 Hz, 2H), 3.69 (t, *J* = 4.9 Hz, 1H), 2.81 (s, 1H). ¹³C NMR (101 MHz, Chloroform-*d*) δ 154.5, 143.4, 143.2, 141.4, 137.9, 137.6, 133.3, 132.3, 129.1, 128.7, 128.5, 128.2, 128.1, 128.1, 128.0, 128.0, 127.9, 127.8, 127.3, 127.3, 125.3, 125.2, 120.2, 120.2, 87.8, 80.9, 77.5, 77.4, 77.2, 76.8, 76.5, 75.8, 75.2, 74.0, 70.3, 70.0, 68.4, 46.8. HRMS (Q-ToF): calculated for C₄₁H₃₈NaO₇S⁺ [M+Na]⁺ 697.2230, found 697.2234 m/z.

2,6-Di-*O*-benzyl-3-*O*-fluorenylmethyloxycarbonyl- α -D-galactopyranosyl-(1 \rightarrow 1)-(3-*N*-benzyl-*N*-benzyloxycarbonylamino)-2,2-difluoropropanol (**2-26**)

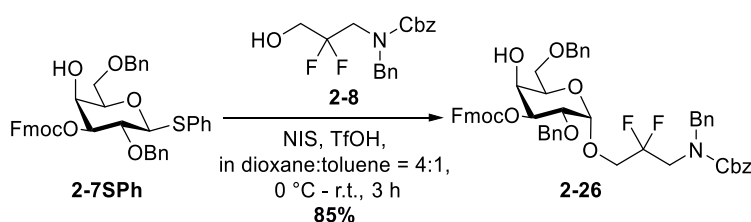

The donor **2-7SPh** (68 mg, 100 μ mol, 1 eq.) and the acceptor **2-8** (40 mg, 120 μ mol, 1.2 eq.) were coevaporated with toluene and put under high vacuum to remove trace water. After being dissolved in a mixed solvent (1,4-Dioxane:Toluene = 4:1), 4 Å AWMS was added and the system was cooled to 0 °C. NIS (34 mg, 150 μ mol, 1.5 eq.) and TfOH (1 μ L, 10 μ mol, 0.1 eq.) was added and the temperature was raised to r.t.. The reaction was put overnight but some starting material was still left. The reaction was quenched with NaHCO₃ (sat. aq.), extracted with EtOAc, washed with water and brine, dried with Na₂SO₄(s) and concentrated *in vacuo*. The product was further purified with FC to get **2-26** as white foam. 76 mg, 84 μ mol, crude yield: 85%. Clean spectra could not be obtained and **2-26** was used in the next step directly.

2,3-Di-*O*-benzyl-4,6-di-*O*-acetyl-1-thio- α -D-galactopyranosyl-(1 \rightarrow 4)-2,6-di-*O*-benzyl-3-*O*-fluorenylmethyloxycarbonyl- α -D-galactopyranosyl-(1 \rightarrow 1)-(3-*N*-benzyl-*N*-benzyloxycarbonylamino)-2,2-difluoropropanol (2-27)

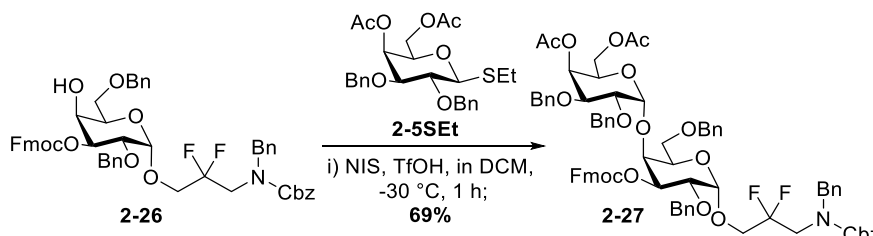

Acceptor **2-26** (0.115 g, 0.128 mmol, 1.0 eq.) and donor **2-5SEt** (0.075 g, 0.154 mmol, 1.2 eq.) were coevaporated with toluene and put under vacuum overnight to remove the trace water in them. After being dissolved in a mixed solvent of Dioxane:Toluene=4:1 (1.0 mL : 0.25 mL) and 4 Å MS were added, the mixture was cooled to -40 °C using acetone-dry ice bath. NIS (0.043 g, 0.192 mmol, 1.5 eq.) and TfOH (1.7 μ L, 0.019 mmol, 0.15 eq.) were then added sequentially to the mixture and the reaction was performed at that temperature until the TLC showed a full conversion of **2-26**. The reaction was quenched with Na₂S₂O₃(aq., 10%), extracted with EtOAc, washed with water and brine, dried with Na₂SO₄(s) and concentrated *in vacuo*. The crude product was further purified with FC to get **2-27**. 0.117 g, 0.089 mmol, crude yield: 69%. The spectra were not clean and **2-27** was used in the next step directly.

2,3-Di-*O*-benzyl-4,6-di-*O*-acetyl-1-thio- α -D-galactopyranosyl-(1 \rightarrow 4)-2,6-di-*O*-benzyl- α -D-galactopyranosyl-(1 \rightarrow 1)-(3-*N*-benzyl-*N*-benzyloxycarbonylamino)-2,2-difluoropropanol (2-28)

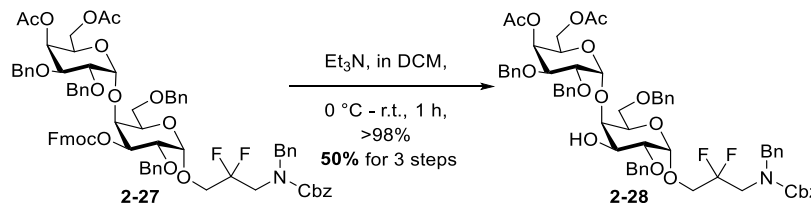

The starting material **2-27** (0.0704 g, 0.053 mmol, 1.0 eq.) was dissolved in DCM (1.0 mL) and Et₃N (0.5 mL) was added. The solvent was stirred at ambient temperature overnight. TLC showed a full conversion of the starting material. The mixture was evaporated and purified with FC to get **2-28**. 0.029 g, 0.026 mmol, yield

Experimental Section

for this step > 98%, yield for 3 steps: 50%. ¹H NMR (400 MHz, Chloroform-*d*) δ 7.43 – 7.09 (m, 36H), 5.59 (dd, *J* = 3.3, 1.4 Hz, 1H), 5.18 (s, 2H), 4.99 (t, *J* = 25.2 Hz, 2H), 4.85 (d, *J* = 11.7 Hz, 1H), 4.78 (d, *J* = 10.8 Hz, 1H), 4.70 (d, *J* = 17.0 Hz, 2H), 4.66 – 4.59 (m, 4H), 4.53 (d, *J* = 10.8 Hz, 1H), 4.48 (s, 1H), 4.27 (d, *J* = 11.7 Hz, 2H), 4.20 – 4.13 (m, 1H), 4.11 – 3.97 (m, 3H), 3.94 (dd, *J* = 10.2, 3.3 Hz, 2H), 3.88 (s, 1H), 3.83 (dd, *J* = 10.1, 3.5 Hz, 3H), 3.79 – 3.72 (m, 2H), 3.72 – 3.44 (m, 4H), 2.85 – 2.51 (m, 1H), 2.14 (s, 3H), 2.08 (s, 3H), 1.36 (s, 2H), 1.31 (s, 4H), 1.28 (s, 12H). ¹³C NMR (101 MHz, Chloroform-*d*) δ 170.70, 170.38, 138.35, 137.94, 128.67, 128.52, 128.45, 128.37, 128.13, 128.05, 127.97, 127.72, 127.57, 127.31, 124.48, 100.26, 97.28, 77.36, 77.04, 76.72, 76.15, 75.42, 74.33, 72.85, 71.82, 69.65, 68.47, 68.12, 67.86, 67.54, 67.25, 62.46, 51.22, 31.95, 31.46, 30.20, 29.73, 29.40, 22.73, 20.92, 20.89, 14.17, 1.05. HRMS (Q-ToF): calculated for C₆₂H₆₇F₂NO₁₅Na⁺ [M+Na]⁺ 1126.4371, found 1126.4342 m/z. [α]_D²⁵ = 60.48°. IR/cm⁻¹: 2927.19, 1745.22, 1707.37, 1497.87, 1455.42, 1372.50, 1231.18, 1095.45, 1050.64, 908.43, 734.51, 699.47.

2,3,5,6-Tetra-*O*-benzoyl-β-D-galactofuranosyl-(1→3)-4-*O*-[4,6-di-*O*-acetyl-2,3-di-*O*-benzyl-α-D-galactopyranosyl-(1→)]-2,6-di-*O*-benzyl-α-D-galactopyranosyl-(1→1)-(3-*N*-benzyl-*N*-benzyloxycarbonylamino)-2,2-difluoropropanol (2-3)

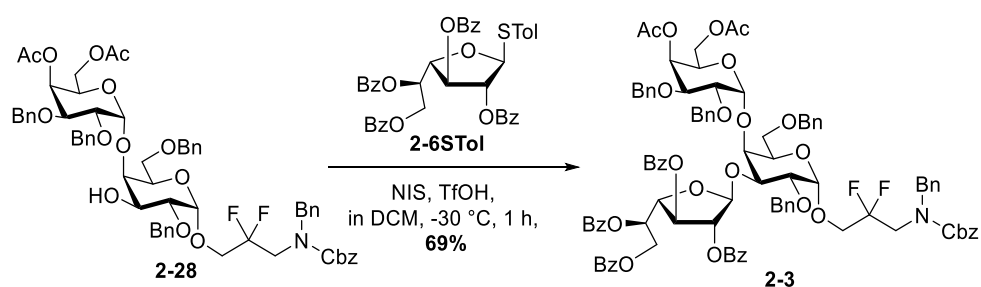

The donor **2-6STol** (7.9 mg, 11 μmol, 1.2 eq.) and the acceptor **2-28** (10.3 mg, 9.33 μmol, 1.0 eq.) were dissolved in DCM and the solution was cooled to -30 °C. After 5 min, NIS (3.2 mg, 14 μmol, 1.5 eq.) and TfOH (0.1 μL, 0.933 μmol, 0.1 eq.) were added sequentially to the mixture and the solution was allowed to be stirred at low temperature for 3 h. (-30 °C ~ -10 °C) Most of the starting material were shown reacted on TLC and the reaction was quenched with Na₂S₂O₃(aq., sat.). After filtration,

extraction and wash with water and brine, the mixture was dried with Na₂SO₄(s), concentrated *in vacuo* and further purified with FC to get white solid like syrup **2-3**. 29.5 mg, 0.018 mmol, yield: 69%. ¹H NMR (400 MHz, Chloroform-*d*) δ 8.04 (d, *J* = 7.7 Hz, 4H), 8.00 – 7.93 (m, 2H), 7.78 (d, *J* = 7.8 Hz, 2H), 7.57 – 7.48 (m, 3H), 7.51 – 7.42 (m, 3H), 7.41 (t, *J* = 7.7 Hz, 3H), 7.38 – 7.00 (m, 38H), 6.08 (dt, *J* = 7.2, 3.7 Hz, 1H), 5.82 (d, *J* = 10.2 Hz, 1H), 5.66 (s, 1H), 5.64 – 5.56 (m, 2H), 5.15 (s, 2H), 5.03 (d, *J* = 3.2 Hz, 1H), 4.94 (d, *J* = 36.6 Hz, 1H), 4.76 – 4.40 (m, 11H), 4.36 – 4.21 (m, 4H), 4.24 – 4.06 (m, 2H), 4.04 – 3.87 (m, 4H), 3.78 (dd, *J* = 25.2, 12.1 Hz, 2H), 3.73 – 3.46 (m, 5H), 2.14 (s, 3H), 2.01 (s, 3H), 0.87 (dt, *J* = 12.9, 7.1 Hz, 1H). ¹³C NMR (101 MHz, Chloroform-*d*) δ 170.45, 170.32, 166.11, 165.70, 165.64, 165.07, 138.38, 138.07, 136.98, 133.39, 133.27, 133.13, 130.13, 129.97, 129.79, 129.74, 129.54, 129.40, 128.89, 128.57, 128.49, 128.47, 128.40, 128.35, 128.33, 128.29, 128.06, 128.01, 127.96, 127.85, 127.68, 127.52, 127.35, 107.08, 99.84, 97.40, 81.66, 79.31, 78.06, 77.36, 77.04, 76.72, 75.89, 74.10, 73.44, 72.95, 71.93, 70.22, 67.78, 67.24, 67.11, 63.72, 61.38, 30.99, 29.73, 21.08, 20.77, 1.05. HRMS (Q-ToF): calculated for C₉₆H₉₃F₂NO₂₄Na⁺ [M+Na]⁺ 1704.5948, found 1704.5884 m/z. [α]_D²⁵ = 50.03°. IR/cm⁻¹: 3022.25, 1711.59, 1419.71, 1362.74, 1218.75, 1091.92, 902.27, 746.48, 667.23.

β-D-Galatofuranosyl-(1→3)-4-O-[α-D-galactopyranosyl-(1→)]-α-D-galactopyranosyl-(1→1)-3-amino-2,2-difluoropropanol (2-1)

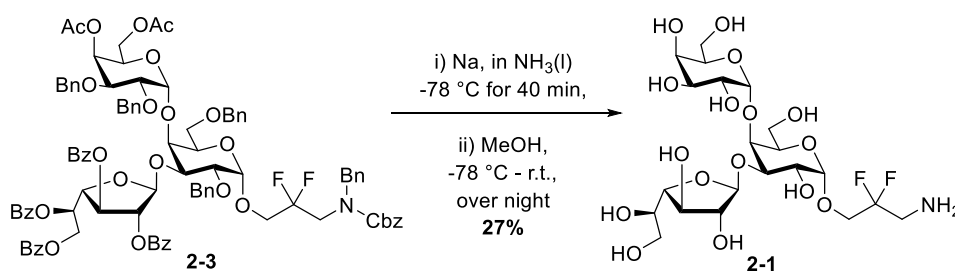

Ammonia(g) was liquefied at -78 °C (dry ice-acetone bath) to get ~20 mL NH₃(l) in a 50 mL three-neck flask with a stirring bar in it. **2-3** (8.5 mg, 5.05 μmol, 1.0 eq.) in a 5 mL flask was dissolved in 0.5 mL THF and a drop of *t*BuOH was added as the initiator. The solvent of **2-3** was transferred into the NH₃(l) and the small flask was washed and transferred again with 0.3 mL THF. A thin piece of Na(s) was cut off and put into the NH₃(l) and the color turned dark blue. The mixture stayed blue so no more

Experimental Section

Na(s) was added and it was stirred at $-78\text{ }^{\circ}\text{C}$ for 30 min. Then MeOH (1 mL) was added to the mixture dropwise and the solution turned transparent immediately. The mixture was slowly warmed to r.t. and stirred overnight. The mixture was then evaporated, purified with size-exclusion column and HPLC semi-preparation and lyophilized to get **2-1** (0.77 mg) as white solid. Yield: 27%. ^1H NMR (700 MHz, Deuterium Oxide) δ 5.24 (d, $J = 2.8$ Hz, 1H), 5.12 (d, $J = 3.8$ Hz, 1H), 5.08 (d, $J = 3.7$ Hz, 1H), 4.27 – 4.20 (m, 3H), 4.18 – 4.08 (m, 4H), 4.08 – 3.96 (m, 4H), 3.96 – 3.89 (m, 2H), 3.89 – 3.82 (m, 3H), 3.82 – 3.75 (m, 2H), 3.72 (dd, $J = 11.6, 4.7$ Hz, 1H), 3.70 – 3.68 (m, 1H), 3.63 (t, $J = 15.4$ Hz, 2H). ^{13}C NMR (176 MHz, D_2O) δ 109.0, 100.2, 99.1, 82.1, 80.9, 78.2, 76.5, 76.1, 72.1, 70.9, 70.5, 69.1, 68.9, 67.7, 66.6, 62.7, 60.6, 60.3, 41.5. HRMS (Q-ToF) $\text{C}_{21}\text{H}_{37}\text{F}_2\text{NO}_{16}\text{Na}^+$ $[\text{M}+\text{Na}]^+$ calculated 620.1973, found 620.1978 m/z.

p-Tolyl 5,6-*O*-isopropylidene-1-thio- β -D-galactofuranoside (**2-31**)

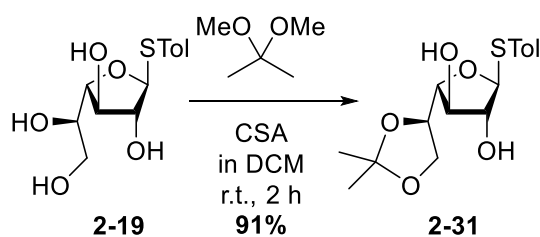

Thioglycoside **2-19** (669 mg, 2.34 mmol, 1 eq.) was put into a flask and anhydrous DCM (10 mL) was added as solvent. 2,2-DMP (0.4 mL, 3.27 mmol, 1.4 eq.) was added. After 15 min, CSA (54 mg, 0.23 mmol, 0.1 eq.) was added and the mixture was allowed to be stirred at ambient temperature for 2 hours. After the full conversion of the starting material, TEA (2 mL) was added to quench the reaction. After evaporation and chromatography, **2-31** (694 mg, 2.13 mmol, yield: 91%) was obtained as colorless syrup. ^1H NMR (400 MHz, Chloroform-*d*) δ 7.41 – 7.35 (m, 2H), 7.17 – 7.11 (m, 2H), 5.47 (s, 1H), 4.37 (ddd, $J = 8.2, 6.7, 1.7$ Hz, 1H), 4.22 (dd, $J = 4.0, 2.2$ Hz, 2H), 4.16 (t, $J = 1.3$ Hz, 1H), 4.11 (dd, $J = 10.0, 6.9$ Hz, 1H), 4.07 (d, $J = 6.8$ Hz, 1H), 3.99 (t, $J = 8.1$ Hz, 1H), 2.34 (s, 3H), 1.39 (d, $J = 3.0$ Hz, 6H). ^{13}C NMR (101 MHz, Chloroform-*d*) δ 138.2, 132.8, 130.1, 129.4, 110.3, 93.8, 85.1, 81.0, 79.7, 77.5, 77.4, 77.2, 76.8, 75.9, 65.7, 60.6, 31.1, 25.8, 25.7, 21.3, 21.2, 14.3. Data compatible as reported.¹⁰⁷

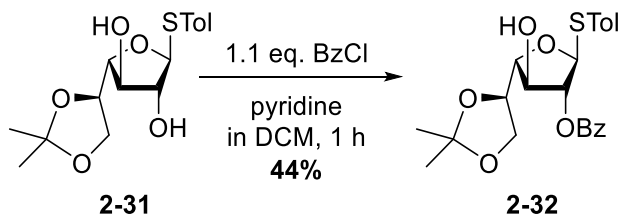
***p*-Tolyl 2-*O*-benzoyl-5,6-*O*-isopropylidene-1-thio- β -D-galactofuranoside (2-32)**

Thioglycoside **2-31** (639 mg, 1.96 mmol, 1.0 eq.) was dissolved in DCM (10 mL) and the temperature was cooled to 0 °C with ice-water bath. Pyridine (0.50 mL, 3.91 mmol, 2.0 eq.) and BzCl (0.25 mL, 2.15 mmol, 1.1 eq.) were added sequentially and the mixture was allowed to be stirred at that temperature for 1 h. The mixture was washed with H₂O, 1 M HCl(aq.), NaHCO₃(aq.) and brine, dried with Na₂SO₄(s), concentrated and purified by FC to get **2-32** (*R_f* = 0.4 on TLC with a gradient of 30% EtOAc in Hex), 369 mg, 0.86 mmol, yield: 44%. ¹H NMR (400 MHz, Chloroform-*d*) δ 8.09 – 7.94 (m, 2H), 7.67 – 7.56 (m, 1H), 7.52 – 7.40 (m, 4H), 7.20 – 7.07 (m, 2H), 5.64 (d, *J* = 3.8 Hz, 1H), 5.07 (t, *J* = 3.7 Hz, 1H), 4.33 (td, *J* = 6.7, 4.6 Hz, 1H), 4.22 (qd, *J* = 7.3, 4.2 Hz, 2H), 4.08 (dd, *J* = 8.4, 6.6 Hz, 1H), 4.00 (dd, *J* = 8.5, 6.8 Hz, 1H), 2.34 (s, 3H), 1.43 (s, 3H), 1.37 (s, 3H). Data compatible as reported.¹⁰⁷

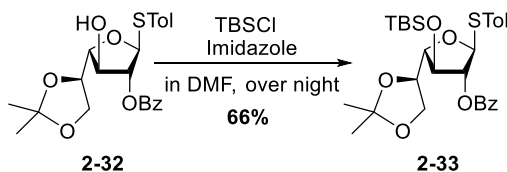
***p*-Tolyl 2-*O*-benzoyl-3-*O*-*tert*-butyldimethylsilyl-5,6-*O*-isopropylidene-1-thio- β -D-galactofuranoside (2-33)**

Thioglycoside **2-32** (369 mg, 0.857 mmol, 1.0 eq.) was dissolved in anhydrous DMF (8.0 mL). Imidazole (117 mg, 1.72 mmol, 2.0 eq.) was added to the solution and the mixture was cooled to 0 °C (ice-water bath). TBSCl (194 mg, 1.29 mmol, 1.5 eq.) was added, the cooling bath was removed and the resultant mixture was stirred overnight. The reaction was quenched by the addition of MeOH and the mixture was evaporated to remove most of the DMF. After being extracted with EtOAc, washed with water and brine, dried with Na₂SO₄(s) and concentrated again, the product was further

Experimental Section

purified with FC to get **2-33** (304 mg, 0.556 mmol, yield: 66%). ^1H NMR (400 MHz, Chloroform-*d*) δ 8.17 – 7.94 (m, 2H), 7.66 – 7.55 (m, 1H), 7.52 – 7.38 (m, 4H), 7.10 (d, $J = 7.8$ Hz, 2H), 5.49 (d, $J = 2.7$ Hz, 1H), 5.37 (t, $J = 2.9$ Hz, 1H), 4.39 – 4.26 (m, 2H), 4.22 (dd, $J = 6.0, 4.5$ Hz, 1H), 4.06 (dd, $J = 8.1, 6.6$ Hz, 1H), 3.93 (t, $J = 7.7$ Hz, 1H), 2.31 (s, 3H), 1.43 (s, 3H), 1.39 (s, 3H), 0.90 (s, 9H), 0.09 (d, $J = 3.0$ Hz, 6H). ^{13}C NMR (101 MHz, Chloroform-*d*) δ 165.5, 137.8, 133.6, 132.7, 130.8, 130.0, 129.8, 129.4, 128.6, 109.8, 91.2, 84.3, 83.1, 77.5, 77.2, 76.8, 74.8, 65.7, 32.1, 29.9, 26.5, 25.8, 25.7, 22.9, 21.3, 18.0, 14.3, -4.4, -4.9. HRMS (Q-ToF): calculated for $\text{C}_{29}\text{H}_{40}\text{NaO}_6\text{SSi}^+$ $[\text{M}+\text{Na}]^+$ 567.2207, found 567.2220 m/z.

p-Tolyl 2,5,6-tri-*O*-benzoyl-3-*O*-*tert*-butyldimethylsilyl-1-thio- β -D-galactofuranoside (**2-6MSTol**)

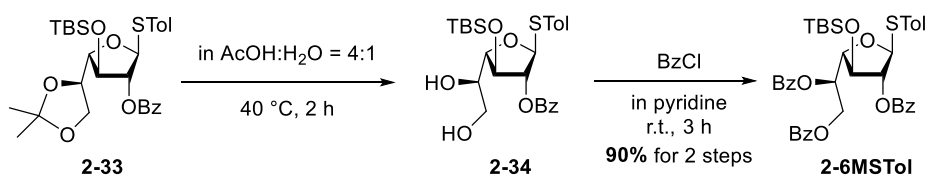

Thioglycoside **2-33** (251 mg, 0.46 mmol, 1.0 eq.) was dissolved in a mixed solvent of AcOH and H₂O (5 mL, v/v = 4/1) and the mixture was stirred at 40 °C until **2-33** was fully converted. The time should be controlled to prevent TBS from cleavage. The mixture was then extracted with EtOAc, washed with H₂O, NaHCO₃(aq.) and brine, dried with Na₂SO₄(s), concentrated *in vacuo* and used for next step without further purification. The crude product was dissolved in pyridine (5 mL) and BzCl (0.16 mL, 0.69 mmol, 3.0 eq.) was added at 0 °C. After stirring for 1 h, the reaction was quenched with EtOAc, washed with H₂O, HCl(aq., 1 M), NaHCO₃(aq.) and brine, dried with Na₂SO₄(s), concentrated and purified by FC to get colorless syrup **2-6MSTol** (397 mg, 0.417 mmol), yield: 90% for two steps. ^1H NMR (400 MHz, Chloroform-*d*) δ 8.14 – 8.01 (m, 2H), 8.01 – 7.94 (m, 2H), 7.94 – 7.84 (m, 2H), 7.64 – 7.48 (m, 3H), 7.45 – 7.29 (m, 8H), 7.05 (d, $J = 7.9$ Hz, 2H), 5.86 (ddd, $J = 7.8, 4.3, 3.3$ Hz, 1H), 5.63 – 5.51 (m, 1H), 5.37 – 5.24 (m, 1H), 4.77 – 4.56 (m, 3H), 4.43 (ddd, $J = 5.9, 2.3, 0.9$ Hz, 1H), 2.30 (s, 3H), 0.90 (s, 9H), 0.08 (s, 3H), 0.06 (s, 3H). ^{13}C NMR (101 MHz, Chloroform-*d*) δ 166.2, 166.0, 165.6, 138.0, 133.5, 133.5, 133.3, 133.0, 130.3, 130.0, 129.9, 129.9, 129.8, 129.7, 129.6, 129.1, 128.6, 128.5, 91.5, 85.0, 82.8, 77.5, 77.4, 77.2, 76.9, 76.8, 69.9,

63.8, 32.1, 29.9, 29.5, 25.7, 22.9, 21.3, 17.9, 14.3, -4.6, -5.0. HRMS (Q-ToF)

$C_{40}H_{44}O_8SSiNa^+$ $[M+Na]^+$ calculated 735.2418, found 735.2419.

2,5,6-Tri-*O*-benzoyl-3-*tert*-butyldimethylsilyl- β -D-galatofuranosyl-(1 \rightarrow 3)-4-*O*-[4,6-di-*O*-acetyl-2,3-di-*O*-benzyl- α -D-galactopyranosyl-(1 \rightarrow)]-2,6-di-*O*-benzyl- α -D-galactopyranosyl-(1 \rightarrow 1)-(3-*N*-benzyl-*N*-benzyloxycarbonylamino)-2,2-difluoropropanol (2-35)

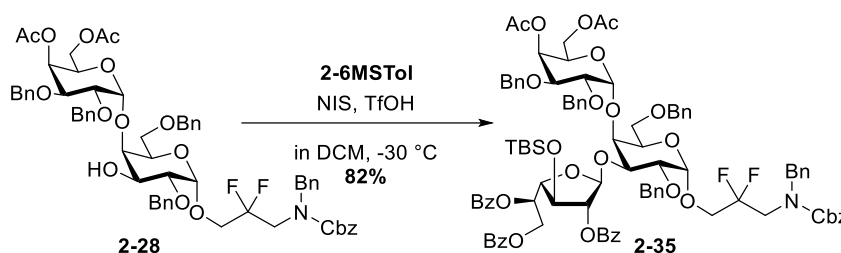

The acceptor **2-28** (40 mg, 36 μ mol, 1.0 eq.) and the donor **2-6MSTol** (38 mg, 54 μ mol, 1.5 eq.) were coevaporated with toluene and put under high vacuum to remove the trace water. After being dissolved in DCM, dried with 4 Å MS and cooled to -30 °C, the mixture was added NIS (16 mg, 72 μ mol, 2.0 eq.) and TfOH (1.0 μ L, 4 μ mol, 0.2 eq.) and stirred for 30 min. The reaction was quenched with $Na_2S_2O_3$ (aq., sat.). After filtration, extraction and wash with water and brine, the mixture was dried with Na_2SO_4 (s), concentrated *in vacuo* and further purified with FC to get **2-35**, 50 mg, 30 μ mol, yield: 82%. 1H NMR (400 MHz, Chloroform-*d*) δ 8.09 (d, J = 7.6 Hz, 2H), 8.00 – 7.94 (m, 2H), 7.83 (d, J = 7.7 Hz, 2H), 7.64 – 7.45 (m, 3H), 7.45 – 7.14 (m, 33H), 7.10 (d, J = 5.6 Hz, 5H), 5.78 (dt, J = 6.3, 3.2 Hz, 1H), 5.61 (dd, J = 3.4, 1.4 Hz, 1H), 5.56 (d, J = 10.3 Hz, 1H), 5.46 (d, J = 3.9 Hz, 1H), 5.15 (d, J = 2.6 Hz, 2H), 5.10 (d, J = 3.3 Hz, 1H), 4.98 – 4.83 (m, 1H), 4.77 (dd, J = 11.3, 5.0 Hz, 2H), 4.72 – 4.42 (m, 10H), 4.38 (dp, J = 9.1, 5.3 Hz, 2H), 4.24 – 4.18 (m, 2H), 4.18 – 4.07 (m, 2H), 4.02 – 3.46 (m, 11H), 2.13 (s, 3H), 2.10 (s, 3H), 0.85 (s, 9H). ^{13}C NMR (101 MHz, Chloroform-*d*) δ 170.6, 170.5, 166.1, 166.0, 165.1, 156.8, 138.7, 138.5, 138.3, 138.2, 137.1, 136.5, 136.3, 133.5, 133.4, 133.2, 130.0, 129.8, 129.8, 129.7, 129.6, 129.3, 128.6, 128.6, 128.5, 128.5, 128.4, 128.4, 128.3, 128.2, 128.1, 128.0, 127.9, 127.8, 127.7, 127.6, 127.5, 127.4, 121.6, 114.2, 107.7, 99.9, 97.8, 84.2, 82.3, 82.2, 79.6, 77.5, 77.2, 76.8, 76.5, 76.3, 75.6, 74.8, 74.3, 73.1, 72.9, 71.8, 70.8, 70.7, 69.5, 69.3, 67.9, 67.2, 67.1, 66.4, 63.8, 61.2, 60.6,

Experimental Section

51.3, 51.1, 47.8, 46.9, 34.0, 32.1, 31.6, 30.3, 29.8, 29.8, 29.8, 29.6, 29.5, 29.3, 29.1, 25.8, 22.8, 21.2, 21.1, 21.0, 18.0, 14.3, 14.3, 13.9, -4.7, -5.3. HRMS (Q-ToF): calculated for $C_{95}H_{103}F_2NO_{23}SiNa^+ [M+Na]^+$ 1714.6550, found 1714.6553 m/z.

2,5,6-Tri-*O*-benzoyl- β -D-galactofuranosyl-(1 \rightarrow 3)-4-*O*-[4,6-di-*O*-acetyl-2,3-di-*O*-benzyl- α -D-galactopyranosyl-(1 \rightarrow)]-2,6-di-*O*-benzyl- α -D-galactopyranosyl-(1 \rightarrow 1)-(3-*N*-benzyl-*N*-benzyloxycarbonylamino)-2,2-difluoropropanol (**2-10**)

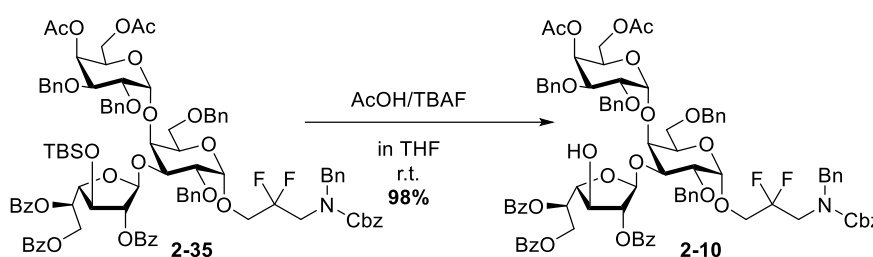

The trisaccharide **2-35** (13 mg, 7.7 μ mol, 1.0 eq.) was dissolved in 0.5 mL THF. AcOH (5 μ , 77 μ mol, 10 eq.) and TBAF (1 M in THF, 77 μ L, 77 μ mol, 10 eq.) were added to the solution and the mixture was allowed to be stirred at ambient temperature until TLC showed a full conversion of the starting material. The resultant was diluted with, EtOAc (20 mL), washed with $NaHCO_3$ (sat. aq.) and brine, dried with Na_2SO_4 (s), concentrated *in vacuo* and purified with FC (30% EtOAc in Hexane) to get 12 mg white syrup **2-10**, 7.6 μ mol, yield: 98%. 1H NMR (600 MHz, Chloroform-*d*) δ 8.02 (d, J = 7.6 Hz, 2H), 7.98 – 7.93 (m, 2H), 7.88 (d, J = 7.7 Hz, 2H), 7.54 (t, J = 7.6 Hz, 1H), 7.48 (td, J = 7.7, 3.5 Hz, 2H), 7.39 – 7.26 (m, 21H), 7.26 – 7.06 (m, 15H), 5.81 (dt, J = 8.4, 4.5 Hz, 1H), 5.68 (d, J = 22.5 Hz, 1H), 5.60 (dd, J = 3.4, 1.5 Hz, 1H), 5.24 (d, J = 2.3 Hz, 1H), 5.15 (s, 2H), 5.02 – 4.88 (m, 3H), 4.77 (dd, J = 21.1, 11.2 Hz, 2H), 4.71 (dd, J = 11.9, 4.1 Hz, 1H), 4.69 – 4.61 (m, 4H), 4.58 (d, J = 11.5 Hz, 1H), 4.53 (d, J = 11.6 Hz, 1H), 4.51 – 4.46 (m, 2H), 4.44 (t, J = 7.0 Hz, 1H), 4.28 – 4.22 (m, 3H), 4.14 (dt, J = 20.9, 7.6 Hz, 3H), 4.07 (t, J = 6.7 Hz, 1H), 3.95 (dd, J = 10.2, 3.5 Hz, 3H), 3.88 – 3.81 (m, 2H), 3.78 (dd, J = 10.2, 3.3 Hz, 2H), 3.74 – 3.58 (m, 4H), 3.55 (t, J = 8.8 Hz, 1H), 2.11 (s, 3H), 2.10 (s, 3H), 0.94 (t, J = 7.4 Hz, 1H), 0.91 – 0.82 (m, 5H). ^{13}C NMR (151 MHz, Chloroform-*d*) δ 171.4, 170.8, 170.5, 166.3, 166.2, 166.0, 156.8, 139.4, 138.5, 138.5, 138.2, 137.1, 133.6, 133.4, 133.2, 130.0, 130.0, 129.9, 129.8, 129.7, 129.0, 128.7, 128.6, 128.6, 128.5, 128.5, 128.5, 128.4, 128.2, 128.2, 128.1, 127.9, 127.9, 127.8, 127.8,

127.6, 127.4, 124.6, 114.2, 107.2, 100.8, 97.4, 84.7, 83.5, 80.4, 77.4, 77.2, 76.9, 76.2, 76.1, 75.9, 74.6, 74.4, 72.9, 72.8, 72.6, 72.0, 70.7, 70.5, 69.1, 67.9, 67.6, 67.4, 64.5, 63.5, 61.8, 51.3, 37.3, 34.0, 32.1, 31.6, 30.8, 30.3, 29.8, 29.8, 29.8, 29.7, 29.5, 29.4, 29.3, 29.1, 22.8, 21.2, 21.1, 21.0, 19.3, 14.3, 13.9. HRMS (Q-ToF): calculated for $C_{89}H_{89}F_2NO_{23}Na^+ [M+Na]^+$ 1600.5686, found 1600.5693 m/z.

4,6-Di-O-acetyl-2,3-di-O-benzyl- α/β -D-galactopyranoside (2-5OH)

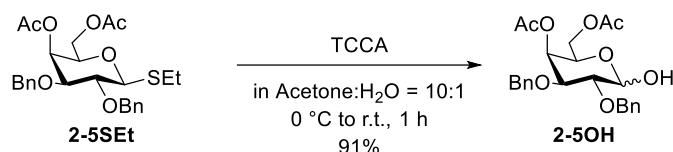

Thioglycoside **2-5SEt** (103 mg, 211 μ mol, 1.0 eq.) was dissolved in a mixture of acetone (5 mL) and water (0.5 mL), the solvent was cooled to 0 °C (ice-water bath) and TCCA (59 mg, 253 μ mol, 1.2 eq.) was added. Ice-water bath was removed and the mixture was stirred at r.t. until TLC showed a full conversion of the starting material. The mixture was evaporated *in vacuo* to remove the acetone, extracted with EtOAc, washed with $NaHCO_3$ (sat. aq.) and brine, dried with Na_2SO_4 (s), concentrated and further purified by FC (25% to 30% EtOAc in Hexane) to get 85 mg colorless syrup **2-5OH** ($\alpha:\beta = 5/3$, 191 μ mol), yield: 91%. 1H NMR (400 MHz, Chloroform-*d*) δ 7.39 – 7.27 (m, 16H), 5.57 (dd, $J = 3.5, 1.4$ Hz, 1H), 5.50 (dd, $J = 3.1, 1.2$ Hz, 1H), 5.27 (d, $J = 3.6$ Hz, 1H), 4.86 (dd, $J = 11.3, 7.7$ Hz, 2H), 4.82 – 4.73 (m, 2H), 4.72 – 4.64 (m, 2H), 4.53 (dd, $J = 11.2, 8.3$ Hz, 2H), 4.36 (ddd, $J = 7.1, 5.7, 1.4$ Hz, 1H), 4.22 – 4.02 (m, 4H), 3.95 (dd, $J = 9.8, 3.4$ Hz, 1H), 3.83 – 3.75 (m, 2H), 3.60 – 3.55 (m, 1H), 3.13 (s, 1H), 2.15 (s, 2H), 2.13 (s, 3H), 2.08 (s, 2H), 2.07 (s, 3H). ^{13}C NMR (101 MHz, Chloroform-*d*) δ 170.7, 170.4, 170.4, 138.3, 138.0, 137.8, 137.6, 128.5, 128.4, 128.4, 128.1, 128.1, 128.1, 128.0, 128.0, 127.9, 127.8, 97.4, 92.0, 79.7, 79.1, 77.4, 77.3, 77.1, 76.8, 75.6, 75.5, 75.4, 73.9, 72.2, 72.0, 71.0, 67.5, 66.9, 66.5, 62.5, 62.4, 20.9, 20.9. HRMS (Q-ToF): calculated for $C_{24}H_{28}NaO_8^+ [M+Na]^+$ 467.1676, found 467.1683 m/z.

4,6-Di-*O*-acetyl-2,3-di-*O*-benzyl- α/β -D-galactopyranosyl *N*-phenyltrifluoroacetimidate (**2-5a**)

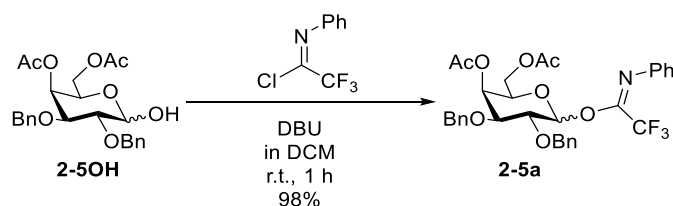

2-5OH (155 mg, 349 μmol , 1.0 eq.) and trifluoro-*N*-phenylacetimidoyl Chloride (340 μL , 2.10 mmol, 6.0 eq.) were dissolved in DCM (2 mL), the solvent was cooled to 0 °C (ice-water bath) and DBU (178 μL , 1.05 μmol , 3 eq.) was added. The mixture was stirred at r.t. until TLC showed a full conversion of the starting material. After evaporation, the crude product was further purified by FC (15% EA in Hex) to obtain yellowish syrup **2-5a** ($\alpha:\beta = 5/3$, 111 mg, 180 μmol), yield 98%. ^1H NMR (400 MHz, Chloroform-*d*) δ 7.39 – 7.24 (m, 13H), 7.10 (tq, $J = 7.4, 1.4$ Hz, 1H), 6.79 (d, $J = 7.7$ Hz, 2H), 5.65 – 5.48 (m, 1H), 4.86 – 4.67 (m, 3H), 4.57 (dd, $J = 21.8, 11.2$ Hz, 1H), 4.16 (qd, $J = 11.4, 6.5$ Hz, 2H), 3.85 (t, $J = 8.7$ Hz, 1H), 3.66 (s, 1H), 2.16 (d, $J = 23.6$ Hz, 3H), 2.06 (d, $J = 21.9$ Hz, 3H). ^{13}C NMR (101 MHz, Chloroform-*d*) δ 170.5, 170.3, 170.2, 143.4, 138.0, 137.8, 137.7, 137.4, 129.4, 128.8, 128.5, 128.5, 128.4, 128.2, 128.1, 128.0, 128.0, 128.0, 127.8, 127.8, 127.5, 124.3, 119.1, 79.1, 77.4, 77.0, 76.7, 75.8, 75.4, 74.7, 73.8, 72.3, 71.8, 69.4, 67.1, 66.1, 62.1, 61.7, 29.7, 20.9, 20.8, 20.7, 1.1. HRMS (Q-ToF): calculated for $\text{C}_{32}\text{H}_{32}\text{F}_3\text{NNaO}_8^+ [\text{M}+\text{Na}]^+$ 638.1972, found 638.1980 m/z.

Phenyl 2,3-di-*O*-benzyl-4,6-di-*O*-acetyl- α -D-galactopyranosyl-(1 \rightarrow 4)-2,6-di-*O*-benzyl-3-*O*-fluorenylmethyloxycarbonyl-1-thio- β -D-galactopyranoside (**2-36**)

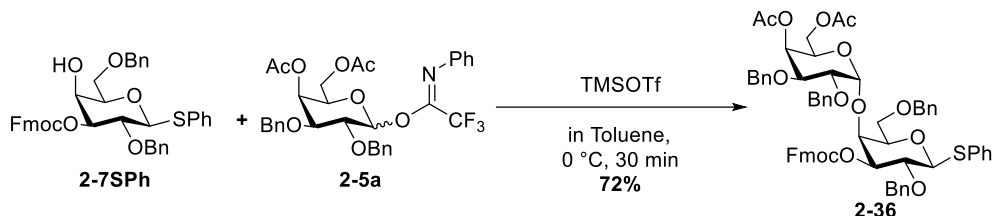

Thioglycoside **2-7SPh** (64 mg, 95 μmol , 1.0 eq.) and **2-5a** (70 mg, 114 μmol , 1.2 eq.) were evaporated with toluene (5 mL x 3) and put into high vacuum to remove trace water before they were dissolved in anhydrous toluene (2 mL). Acid washed 4 Å

MS were added to the solution and the mixture was cooled to 0 °C with ice-water bath. TMSOTf (2 μL, 11 μmol, 0.1 eq.) was added to the mixture and the reaction was put at 0 °C until TLC showed the disappearance of the starting material. The reaction was quenched with Na₂S₂O₃(aq.), washed with brine, dried with Na₂SO₄(s), concentrated *in vacuo* and purified with FC to get **2-36**, 158 mg, 144 μmol, 72%. ¹H NMR (400 MHz, Chloroform-*d*) δ 7.75 (ddt, *J* = 7.6, 1.7, 0.8 Hz, 2H), 7.71 – 7.66 (m, 2H), 7.59 (dd, *J* = 7.5, 1.0 Hz, 1H), 7.54 (dt, *J* = 7.6, 1.0 Hz, 1H), 7.43 – 7.27 (m, 19H), 7.25 – 7.14 (m, 11H), 5.60 (dd, *J* = 3.2, 1.4 Hz, 1H), 4.96 (d, *J* = 3.7 Hz, 1H), 4.93 (d, *J* = 11.6 Hz, 1H), 4.85 (d, *J* = 10.7 Hz, 1H), 4.83 – 4.79 (m, 1H), 4.76 (d, *J* = 10.6 Hz, 1H), 4.66 (d, *J* = 6.2 Hz, 1H), 4.64 – 4.59 (m, 2H), 4.53 (d, *J* = 10.6 Hz, 1H), 4.44 – 4.40 (m, 2H), 4.31 (ddd, *J* = 7.8, 6.3, 1.5 Hz, 1H), 4.26 (s, 2H), 4.24 (d, *J* = 3.0 Hz, 1H), 4.18 (d, *J* = 7.0 Hz, 1H), 4.06 (d, *J* = 7.7 Hz, 2H), 3.97 – 3.92 (m, 1H), 3.92 – 3.88 (m, 1H), 3.88 – 3.81 (m, 2H), 3.74 (dd, *J* = 7.7, 6.0 Hz, 1H), 3.62 (dd, *J* = 9.4, 5.9 Hz, 1H), 2.12 (s, 3H), 1.90 (s, 3H). ¹³C NMR (101 MHz, Chloroform-*d*) δ 170.5, 170.5, 154.7, 143.6, 143.0, 141.4, 141.4, 138.5, 138.1, 137.9, 137.6, 133.4, 132.0, 129.1, 128.6, 128.6, 128.5, 128.5, 128.4, 128.2, 128.1, 128.1, 128.0, 128.0, 127.9, 127.9, 127.8, 127.8, 127.3, 127.3, 125.2, 125.1, 120.2, 100.0, 86.6, 79.9, 77.5, 77.4, 77.2, 77.1, 76.8, 76.6, 75.6, 75.1, 74.8, 74.7, 73.7, 73.2, 71.7, 70.3, 67.3, 66.9, 66.7, 61.2, 46.7, 21.1, 20.9. HRMS (Q-ToF): calculated for C₆₁H₆₈NO₁₄S⁺ [M+NH₄]⁺ 1118.4355, found 1118.4377 *m/z*.

Phenyl 2,3-di-*O*-benzyl-4,6-di-*O*-acetyl- α -D-galactopyranosyl-(1 \rightarrow 4)-2,6-di-*O*-benzyl-1-thio- β -D-galactopyranoside (2-37)

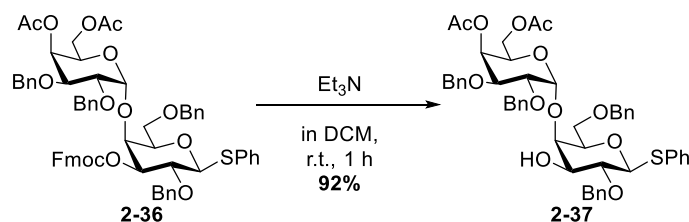

Disaccharide **2-36** (30 mg, 27 μmol, 1.0 eq.) was dissolved in 2 mL DCM and 1 mL Et₃N was added to the solution. The mixture was stirred at r.t. until TLC showed a full conversion of the starting material. The solvent was removed *in vacuo* and the crude product was purified with FC to get 22 mg **2-37** (25 μmol), yield: 92%. ¹H NMR (600 MHz, Chloroform-*d*) δ 7.67 – 7.62 (m, 2H), 7.42 – 7.39 (m, 2H), 7.37 (t, *J* = 7.4 Hz,

Experimental Section

2H), 7.34 – 7.26 (m, 14H), 7.24 – 7.20 (m, 5H), 5.48 (dd, $J = 3.3, 1.4$ Hz, 1H), 5.00 (d, $J = 3.6$ Hz, 1H), 4.87 (d, $J = 11.7$ Hz, 1H), 4.82 (t, $J = 11.3$ Hz, 2H), 4.72 (d, $J = 10.9$ Hz, 1H), 4.65 (d, $J = 11.7$ Hz, 1H), 4.59 (dd, $J = 12.2, 10.1$ Hz, 2H), 4.28 (d, $J = 3.0$ Hz, 2H), 4.08 (ddd, $J = 7.0, 5.3, 1.5$ Hz, 1H), 4.04 – 4.00 (m, 2H), 3.96 (dd, $J = 11.3, 7.5$ Hz, 1H), 3.91 (dd, $J = 10.1, 3.2$ Hz, 1H), 3.87 (dd, $J = 9.6, 6.5$ Hz, 1H), 3.82 (dd, $J = 10.1, 3.6$ Hz, 1H), 3.71 (t, $J = 6.2$ Hz, 1H), 3.67 (td, $J = 9.9, 4.4$ Hz, 2H), 3.49 (t, $J = 9.4$ Hz, 1H), 2.12 (s, 3H), 2.01 (s, 3H). ^{13}C NMR (101 MHz, Chloroform- d) δ 170.6, 170.4, 138.5, 138.1, 138.1, 138.0, 133.4, 132.5, 128.9, 128.7, 128.6, 128.5, 128.5, 128.4, 128.2, 128.1, 128.0, 128.0, 127.9, 127.9, 127.8, 127.7, 127.4, 100.4, 86.3, 79.1, 77.6, 77.5, 77.4, 77.2, 77.0, 76.8, 76.0, 75.5, 74.8, 74.5, 74.4, 73.2, 71.9, 68.5, 67.5, 67.4, 62.5, 29.8, 21.0, 21.0. HRMS (Q-ToF): calculated for $\text{C}_{50}\text{H}_{58}\text{NO}_{12}\text{S}^+ [\text{M}+\text{NH}_4]^+$ 896.3674, found 896.3688 m/z.

Phenyl 2,3,5,6-tetra-*O*-benzoyl- β -D-galactofuranosyl-(1 \rightarrow 3)-4-*O*-[4,6-di-*O*-acetyl-2,3-di-*O*-benzyl- α -D-galactopyranosyl-(1 \rightarrow)]-2,6-di-*O*-benzyl-1-thio- β -D-galactopyranoside (2-9SPh)

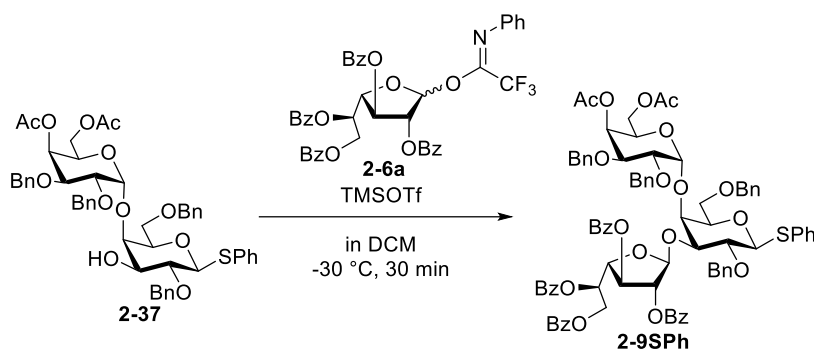

Donor **2-6a** was prepared using the same procedure for **2-5a** and was used for this glycosylation directly. The acceptor **2-37** (32 mg, 36 μmol , 1.0 eq.) and donor **2-6a** (41 mg, 54 μmol , 1.5 eq.) were coevaporated with toluene (5 mL x 3) and put into high vacuum to remove trace water before they were dissolved in anhydrous DCM (1 mL). Acid washed 4 Å MS were added to the solution and the mixture was cooled to -30 °C with dry ice-acetone bath. TMSOTf (2 μL , 8 μmol , 0.2 eq.) was added to the mixture and the reaction was put at -30 °C until TLC showed the disappearance of the starting material. The reaction was quenched with $\text{Na}_2\text{S}_2\text{O}_3(\text{aq.})$, extracted with EtOAc, washed with brine, dried with $\text{Na}_2\text{SO}_4(\text{s})$, concentrated *in vacuo* and purified with FC to get

2-9SPh, 40 mg, 27 μmol , 75%. ^1H NMR (600 MHz, Chloroform-*d*) δ 8.09 (d, $J = 7.6$ Hz, 2H), 8.04 – 8.00 (m, 6H), 7.98 (d, $J = 7.8$ Hz, 4H), 7.88 (d, $J = 7.7$ Hz, 2H), 7.78 (d, $J = 7.7$ Hz, 2H), 7.62 (dd, $J = 7.4, 2.2$ Hz, 2H), 7.50 (dddd, $J = 21.4, 10.9, 8.4, 5.9$ Hz, 10H), 7.40 (dd, $J = 11.5, 7.5$ Hz, 5H), 7.36 – 7.27 (m, 22H), 7.20 (d, $J = 6.5$ Hz, 4H), 7.18 – 7.16 (m, 2H), 7.07 (dd, $J = 8.5, 3.0$ Hz, 2H), 6.09 (dt, $J = 7.4, 3.9$ Hz, 1H), 6.04 (dt, $J = 6.8, 3.7$ Hz, 1H), 5.10 (d, $J = 3.3$ Hz, 1H), 4.92 (dd, $J = 5.1, 3.7$ Hz, 1H), 4.84 (d, $J = 10.3$ Hz, 1H), 4.79 (td, $J = 13.2, 12.6, 2.8$ Hz, 3H), 4.76 – 4.66 (m, 6H), 4.59 – 4.55 (m, 2H), 4.51 (d, $J = 11.1$ Hz, 1H), 4.34 (d, $J = 17.2$ Hz, 3H), 4.25 (d, $J = 7.3$ Hz, 2H), 4.08 – 4.03 (m, 1H), 3.97 – 3.91 (m, 2H), 3.87 (dd, $J = 9.6, 2.5$ Hz, 1H), 3.80 (d, $J = 9.4$ Hz, 1H), 3.79 – 3.75 (m, 1H), 3.69 (ddd, $J = 15.6, 9.8, 6.5$ Hz, 2H), 3.59 (dd, $J = 10.0, 3.3$ Hz, 1H), 2.15 (s, 3H), 1.99 (s, 3H). ^{13}C NMR (151 MHz, Chloroform-*d*) δ 170.4, 170.4, 166.3, 166.2, 165.9, 165.8, 165.7, 165.7, 165.3, 138.6, 138.4, 138.3, 138.0, 133.7, 133.6, 133.5, 133.5, 133.4, 133.4, 133.3, 133.1, 132.3, 130.2, 130.2, 130.1, 130.1, 130.1, 130.0, 130.0, 130.0, 129.9, 129.9, 129.9, 129.9, 129.7, 129.7, 129.6, 129.5, 129.0, 128.9, 128.9, 128.6, 128.6, 128.6, 128.5, 128.5, 128.5, 128.4, 128.3, 128.2, 128.0, 127.9, 127.8, 127.8, 127.7, 127.7, 127.4, 107.2, 101.2, 99.8, 87.1, 82.6, 82.3, 82.1, 82.0, 79.0, 78.6, 78.5, 78.3, 77.6, 77.5, 77.4, 77.2, 76.9, 76.8, 76.0, 75.1, 74.3, 73.2, 71.9, 70.5, 70.4, 69.7, 67.5, 67.3, 63.9, 63.7, 61.6, 22.8, 21.2, 20.9, 14.3. HRMS (Q-ToF): calculated for $\text{C}_{84}\text{H}_{80}\text{O}_{21}\text{SNa}^+ [\text{M}+\text{Na}]^+$ 1479.4805, found 1479.4836 m/z .

2,3,5,6-Tetra-*O*-benzoyl- β -D-galactofuranosyl-(1 \rightarrow 3)-4-*O*-[4,6-di-*O*-acetyl-2,3-di-*O*-benzyl- α -D-galactopyranosyl-(1 \rightarrow)]-2,6-di-*O*-benzyl- α/β -D-galactopyranoside (2-9OH)

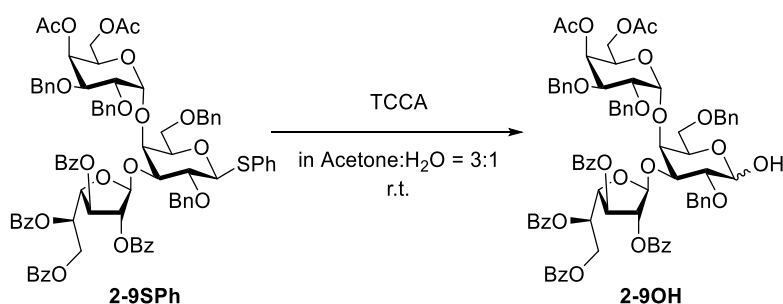

Thioglycoside **2-9SPh** (31 mg, 21 μmol , 1.0 eq.) was dissolved in a mixed solvent of acetone and water ($v/v = 3/1$, 2 mL) and trichloroisocyanuric acid (6 mg, 26 μmol , 1.2 eq.) was added to the solvent. The mixture was stirred at r.t. for 1 h but some

Experimental Section

of the starting material was not converting. The reaction was quenched with NaHCO₃ (sat. aq.), washed with NaCl(aq.), dried with Na₂SO₄(s), concentrated in vacuo and further purified with FC to get white syrup **2-9OH** ($\alpha:\beta = 2:1$, 21 mg, 15 μ mol), yield: 72%. Starting material **2-9SPh** recovered 5 mg. ¹H NMR (600 MHz, Chloroform-*d*) δ 8.09 – 7.95 (m, 6H), 7.79 (ddd, $J = 14.7, 8.3, 1.4$ Hz, 2H), 7.57 – 7.45 (m, 4H), 7.42 (dt, $J = 9.4, 7.7$ Hz, 2H), 7.37 – 7.26 (m, 12H), 7.25 – 7.20 (m, 4H), 7.16 (ddd, $J = 9.6, 5.2, 2.7$ Hz, 5H), 7.13 – 7.03 (m, 3H), 6.10 – 6.04 (m, 1H), 5.79 (d, $J = 11.0$ Hz, 1H), 5.67 – 5.54 (m, 3H), 5.29 (d, $J = 3.4$ Hz, 1H), 5.10 (dd, $J = 55.7, 3.3$ Hz, 1H), 5.02 – 4.89 (m, 1H), 4.79 – 4.70 (m, 4H), 4.69 – 4.65 (m, 1H), 4.62 – 4.55 (m, 2H), 4.54 – 4.42 (m, 3H), 4.35 – 4.27 (m, 3H), 4.27 – 4.21 (m, 2H), 4.21 – 4.15 (m, 1H), 4.15 – 4.11 (m, 1H), 4.07 (t, $J = 6.7$ Hz, 1H), 3.97 – 3.86 (m, 3H), 3.82 – 3.63 (m, 3H), 3.61 – 3.51 (m, 2H), 2.15 (d, $J = 16.5$ Hz, 3H), 2.05 (s, 1H), 2.03 (s, 1H), 2.01 (s, 2H). ¹³C NMR (151 MHz, Chloroform-*d*) δ 170.9, 170.5, 170.4, 170.4, 166.3, 166.3, 165.8, 165.8, 165.8, 165.3, 147.2, 139.4, 138.5, 138.5, 138.3, 138.3, 138.2, 138.2, 137.9, 133.5, 133.5, 133.4, 133.4, 133.4, 133.3, 133.2, 130.3, 130.2, 130.1, 130.1, 130.0, 129.9, 129.9, 129.9, 129.7, 129.6, 129.5, 129.0, 129.0, 129.0, 128.6, 128.6, 128.6, 128.5, 128.5, 128.4, 128.4, 128.3, 128.2, 128.1, 128.1, 128.0, 127.9, 127.9, 127.8, 127.8, 127.8, 127.7, 124.6, 124.1, 114.2, 107.3, 107.2, 99.9, 99.4, 98.1, 91.5, 82.6, 82.0, 81.9, 81.9, 80.9, 79.5, 78.4, 78.2, 77.4, 77.2, 76.9, 76.8, 76.1, 74.8, 74.7, 74.1, 74.1, 73.9, 73.5, 73.3, 73.2, 72.1, 72.0, 70.6, 70.4, 70.4, 70.2, 69.8, 67.4, 67.4, 67.2, 67.1, 64.5, 63.8, 63.8, 61.8, 61.5, 37.2, 35.0, 34.7, 34.0, 32.1, 31.6, 30.8, 30.5, 30.3, 30.2, 29.8, 29.8, 29.8, 29.7, 29.5, 29.3, 29.2, 29.1, 27.2, 22.8, 22.8, 21.6, 21.2, 21.2, 21.0, 20.9, 19.3, 14.3, 13.9, 1.2. HRMS (Q-ToF): calculated for C₇₈H₇₆O₂₂Na⁺ [M+Na]⁺ 1387.4720, found 1387.4723 m/z.

2,3,5,6-Tetra-*O*-benzoyl- β -*D*-galatofuranosyl-(1 \rightarrow 3)-4-*O*-[4,6-di-*O*-acetyl-2,3-di-*O*-benzyl- α -*D*-galactopyranosyl-(1 \rightarrow)]-2,6-di-*O*-benzyl- α/β -*D*-galactopyranosyl-*N*-phenyltrifluoroacetimidate (2-9a)

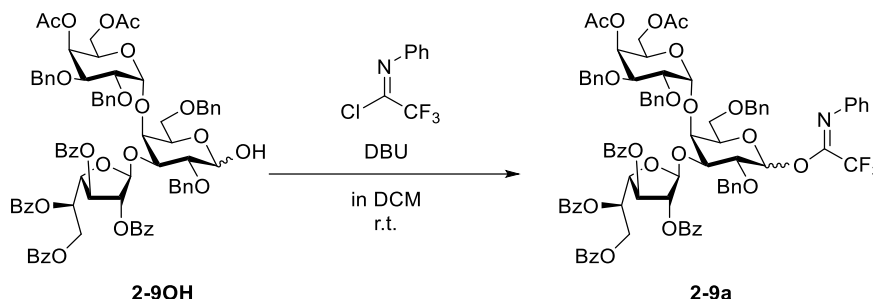

Trisaccharide **2-9OH** (20 mg, 15 μ mol, 1.0 eq.) and trifluoro-*N*-phenylacetimidoyl chloride (15 μ L, 90 μ mol, 6 eq.) were dissolved in anhydrous DCM (2 mL). DBU (8 μ L, 45 μ mol, 3.0 eq.) was added to the solvent and the resultant was stirred at ambient temperature until TLC showed a disappearance of the starting material. The crude product was concentrated *in vacuo* and purified by FC to get white syrup as **2-9a** (α : β = 1:4, 21 mg, 14 μ mol), yield: 93%. ^1H NMR (400 MHz, Chloroform-*d*) δ 8.09 – 7.96 (m, 6H), 7.78 (ddd, J = 12.4, 8.3, 1.4 Hz, 2H), 7.61 – 7.27 (m, 18H), 7.25 – 7.04 (m, 18H), 6.77 (d, J = 7.8 Hz, 1H), 6.08 (ddt, J = 25.6, 6.9, 3.3 Hz, 1H), 5.87 – 5.73 (m, 1H), 5.68 – 5.58 (m, 3H), 5.09 (dd, J = 26.5, 3.3 Hz, 1H), 4.85 – 4.60 (m, 6H), 4.59 – 4.40 (m, 3H), 4.36 – 4.24 (m, 4H), 4.23 – 4.05 (m, 2H), 4.05 – 3.52 (m, 8H), 2.15 (d, J = 3.7 Hz, 3H), 2.03 (d, J = 5.2 Hz, 3H). ^{13}C NMR (101 MHz, Chloroform-*d*) δ 170.6, 170.4, 166.4, 166.3, 165.9, 165.8, 165.8, 165.3, 165.3, 147.2, 143.5, 139.4, 138.5, 138.4, 138.3, 138.2, 138.2, 138.1, 138.1, 138.1, 137.8, 137.6, 137.6, 135.2, 133.6, 133.5, 133.4, 133.3, 130.3, 130.2, 130.1, 130.1, 130.0, 129.9, 129.8, 129.7, 129.6, 129.5, 129.5, 129.4, 129.0, 128.9, 128.9, 128.8, 128.7, 128.7, 128.7, 128.6, 128.6, 128.5, 128.5, 128.5, 128.5, 128.4, 128.4, 128.3, 128.2, 128.2, 128.1, 128.1, 128.1, 128.0, 127.9, 127.9, 127.8, 127.8, 127.8, 127.7, 127.7, 127.7, 127.6, 126.5, 124.6, 124.4, 124.1, 120.5, 120.4, 119.4, 114.2, 107.2, 107.2, 99.9, 91.0, 82.8, 82.4, 82.1, 81.9, 81.8, 78.2, 77.5, 77.2, 76.8, 75.9, 75.8, 75.2, 74.3, 74.2, 74.1, 74.0, 73.7, 73.4, 73.4, 73.3, 73.2, 73.1, 72.1, 72.0, 71.9, 70.5, 70.3, 69.7, 67.6, 67.5, 67.5, 67.2, 63.8, 63.7, 61.9, 61.8, 61.4, 45.4, 37.2, 35.0, 34.0, 33.8, 32.9, 32.1, 31.6, 30.3, 30.2, 29.8, 29.8, 29.8, 29.7, 29.5, 29.3, 29.1, 28.1, 27.7, 27.6, 27.2, 22.8, 22.8, 21.6, 21.2, 20.9, 20.9, 19.9, 14.3, 1.2. MS not available due to instability of the imidate.

2,3,5,6-Tetra-*O*-benzoyl- β -D-galatofuranosyl-(1 \rightarrow 3)-4-*O*-[4,6-di-*O*-acetyl-2,3-di-*O*-benzyl- α -D-galactopyranosyl-(1 \rightarrow)]-2,6-di-*O*-benzyl- α -D-galactopyranosyl-(1 \rightarrow 3)-2,5,6-Tri-*O*-benzoyl- β -D-galatofuranosyl-(1 \rightarrow 3)-4-*O*-[4,6-di-*O*-acetyl-2,3-di-*O*-benzyl- α -D-galactopyranosyl-(1 \rightarrow)]-2,6-di-*O*-benzyl- α -D-galactopyranosyl-(1 \rightarrow 1)-(3-*N*-benzyl-*N*-benzyloxycarbonylamino)-2,2-difluoropropanol (2-4)

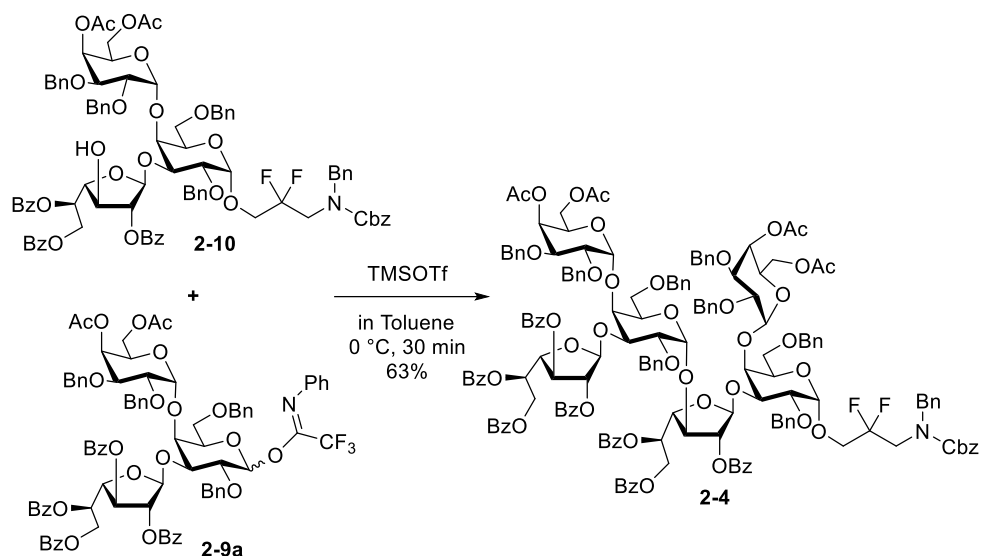

Donor **2-9a** (5 mg, 3.2 μ mol, 1.0 eq.) and acceptor **2-10** (9 mg, 5.7 μ mol, 1.7 eq.) were coevaporated with toluene and put under high vacuum to remove trace water before they were dissolved in anhydrous toluene (0.5 mL). 4 Å molecular sieves were added and the mixture was cooled to 0 °C with ice water bath. TMSOTf (0.1 μ L, 0.2 μ mol, 0.2 eq.) was added and after TLC showed a full conversion of the donor, the reaction was quenched by Et₃N(l), diluted with EtOAc, washed with NaCl(sat. aq.), dried with Na₂SO₄(s), concentrated *in vacuo* and further purified with FC to get colorless syrup **2-4** (6 mg, 2 μ mol), yield: 63%. ¹H NMR (700 MHz, Chloroform-*d*) δ 8.12 (d, *J* = 8.6 Hz, 2H), 8.01 (d, *J* = 7.8 Hz, 2H), 7.97 (d, *J* = 7.7 Hz, 4H), 7.86 (t, *J* = 7.9 Hz, 4H), 7.74 (d, *J* = 7.8 Hz, 2H), 7.58 (t, *J* = 7.5 Hz, 1H), 7.44 (ddq, *J* = 26.6, 14.0, 7.8, 4.9 Hz, 9H), 7.35 – 7.27 (m, 17H), 7.19 (dtd, *J* = 33.8, 17.7, 16.0, 8.4 Hz, 29H), 7.11 – 7.05 (m, 6H), 7.01 (t, *J* = 7.5 Hz, 2H), 6.97 (t, *J* = 9.4 Hz, 4H), 6.92 (dd, *J* = 10.4, 6.9 Hz, 3H), 6.04 (dd, *J* = 7.6, 3.5 Hz, 1H), 5.88 (s, 1H), 5.76 (dd, *J* = 14.6, 8.5 Hz, 2H), 5.70 – 5.65 (m, 2H), 5.62 (d, *J* = 6.2 Hz, 1H), 5.56 – 5.46 (m, 2H), 5.13 (d, *J* = 11.0 Hz, 3H), 4.96 (t, *J* = 3.9 Hz, 2H), 4.92 – 4.86 (m, 1H), 4.83 – 4.72 (m, 4H), 4.69 – 4.58 (m,

8H), 4.58 – 4.31 (m, 13H), 4.30 – 4.24 (m, 2H), 4.20 – 4.02 (m, 6H), 4.01 – 3.95 (m, 2H), 3.94 – 3.79 (m, 5H), 3.78 – 3.57 (m, 8H), 3.52 (dd, $J = 10.1, 3.1$ Hz, 1H), 3.49 (t, $J = 8.3$ Hz, 1H), 3.08 (dd, $J = 9.9, 6.0$ Hz, 1H), 2.36 (s, 5H), 2.07 (s, 3H), 2.00 (s, 3H), 1.96 (s, 3H), 1.90 (s, 3H), 0.90 – 0.81 (m, 3H). ^{13}C NMR (176 MHz, Chloroform- d) δ 207.4, 185.8, 170.6, 170.5, 170.5, 170.4, 166.2, 166.1, 165.9, 165.8, 165.7, 165.1, 165.1, 158.5, 156.7, 148.8, 138.7, 138.5, 138.3, 138.3, 138.0, 137.1, 133.6, 133.2, 133.2, 133.2, 133.1, 133.0, 130.2, 130.1, 130.0, 130.0, 129.9, 129.9, 129.9, 129.8, 129.7, 129.6, 129.5, 129.2, 128.8, 128.7, 128.7, 128.6, 128.5, 128.4, 128.4, 128.4, 128.4, 128.3, 128.2, 128.2, 128.2, 128.1, 128.1, 127.9, 127.7, 127.6, 127.6, 127.5, 127.5, 127.5, 127.4, 127.4, 127.3, 127.2, 125.4, 117.2, 108.3, 108.0, 106.9, 100.5, 99.9, 99.7, 98.1, 91.3, 83.2, 81.9, 81.4, 79.9, 79.4, 79.0, 78.7, 77.3, 77.2, 77.0, 76.4, 76.4, 76.1, 74.4, 74.2, 74.0, 73.9, 73.1, 73.0, 72.9, 72.8, 72.6, 72.2, 71.9, 70.6, 70.2, 69.2, 68.4, 67.9, 67.5, 67.4, 67.2, 67.1, 64.0, 61.6, 61.4, 51.3, 34.2, 32.1, 29.9, 29.8, 29.5, 24.9, 22.8, 22.8, 21.6, 21.1, 21.0, 20.8, 17.0, 14.3, 9.3, 1.2, -0.2. HRMS (Q-ToF): calculated for $\text{C}_{167}\text{H}_{163}\text{F}_2\text{NO}_{44}\text{Na}_2^{2+}$ $[\text{M}+2\text{Na}]^{2+}$ 1485.0150, found 1485.0155 m/z.

β -D-Galactofuranosyl-(1 \rightarrow 3)-4-O-[α -D-galactopyranosyl-(1 \rightarrow)]- α -D-galactopyranosyl-(1 \rightarrow 3)- β -D-galactofuranosyl-(1 \rightarrow 3)-4-O-[α -D-galactopyranosyl-(1 \rightarrow)]- α -D-galactopyranosyl-(1 \rightarrow 1)-3-amino-2,2-difluoropropanol (2-2)

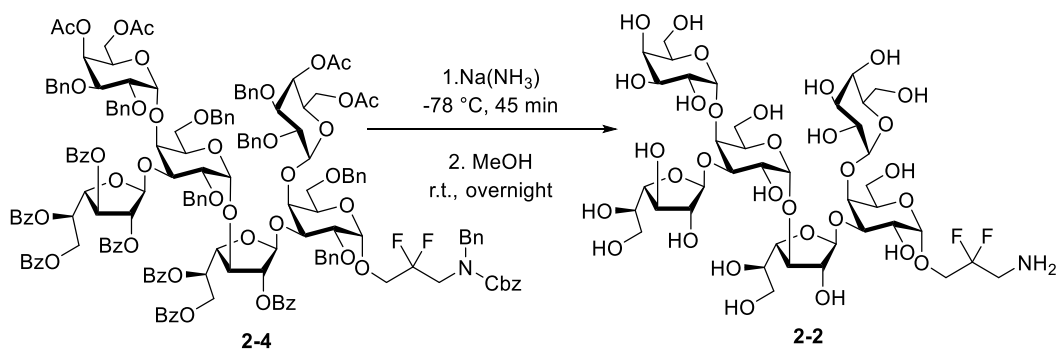

Ammonia was liquefied in a 3-necked flask with a stirring bar in it at $-78\text{ }^{\circ}\text{C}$ (dry ice-acetone bath). A small piece of Na(s) was added to the ammonia(l) and the color of the mixture turned dark blue. **2-4** (28 mg, 9.5 μmol) and $^t\text{BuOH}$ (0.1 mL) was transferred to $\text{Na}(\text{NH}_3)$ with anhydrous THF (0.5 mL + 0.2 mL) and the mixture was stirred at $-78\text{ }^{\circ}\text{C}$ for 40 min while the color kept dark blue. MeOH was added dropwise until the mixture turned transparent to quench the first step of the reaction. $\text{N}_2(\text{g})$ was

Experimental Section

bubbled slowly until most of the NH_3 was taken away and the temperature was slowly raised to room temperature. The mixture was stirred overnight, added AcOH until $\text{pH} \approx 7$, evaporated *in vacuo* and purified with Sephadex G-25 and HPLC (hypercarb) to get **2-2** (1.8 mg, 1.7 μmol), yield: 18%. ^1H NMR (600 MHz, Deuterium Oxide) δ 5.27 – 5.23 (m, 2H), 5.12 (dt, $J = 7.7, 2.6$ Hz, 2H), 5.07 (d, $J = 3.8$ Hz, 1H), 5.03 (d, $J = 3.8$ Hz, 1H), 4.36 (ddd, $J = 5.5, 2.9, 1.1$ Hz, 1H), 4.32 (ddd, $J = 8.5, 3.0, 1.1$ Hz, 1H), 4.28 – 4.17 (m, 6H), 4.17 – 4.07 (m, 7H), 4.07 – 4.03 (m, 2H), 4.00 (tt, $J = 10.6, 2.1$ Hz, 3H), 3.93 (ddd, $J = 11.0, 8.9, 3.1$ Hz, 4H), 3.90 – 3.82 (m, 7H), 3.82 – 3.79 (m, 1H), 3.79 – 3.76 (m, 2H), 3.75 – 3.66 (m, 4H), 3.64 – 3.55 (m, 2H). ^{13}C NMR (151 MHz, d_2O) δ 170.9, 109.4, 109.0, 100.2, 100.1, 100.0, 98.9, 84.5, 82.0, 80.8, 80.3, 79.6, 78.1, 76.5, 76.4, 76.0, 72.2, 72.0, 70.8, 70.5, 70.5, 69.8, 69.0, 69.0, 68.8, 68.5, 67.8, 67.5, 66.7, 66.5, 66.3, 62.7, 62.6, 60.5, 60.2, 60.2, 59.8, 41.5. HRMS (Q-ToF) m/z $[\text{M}+\text{H}]^+$ calculated 1084.3738, found 1084.3738 m/z .

4.3 Conjugation of the Antigens

General Procedure of the Conjugation

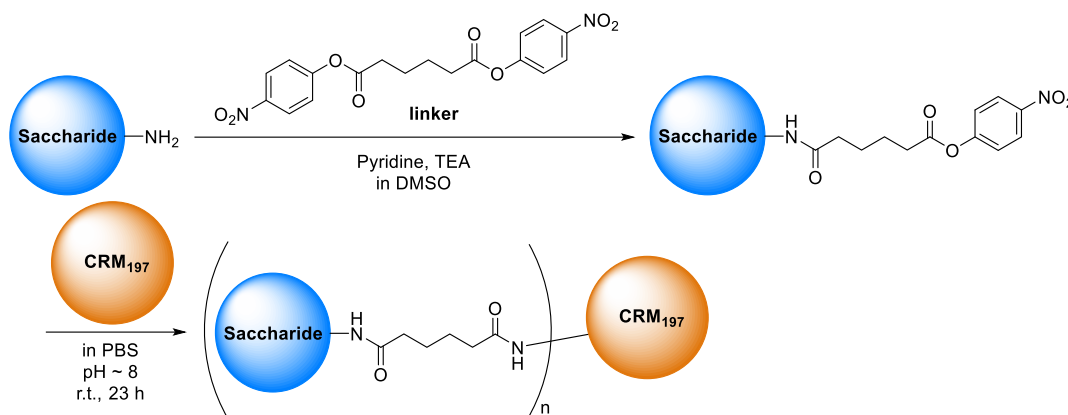

The saccharide (**2-1** or **2-2**) in a vial was dissolved in 200 μL DMSO, 25 μL Pyridine and 10 μL TEA were added. The **linker** [bis(4-nitrophenyl) adipate, 4.90 mg, in a vial] was dissolved in 100 μL DMSO and the solution was added to the saccharide solution. After stirring for 3 h, the stirring bar was removed and the reaction mixture was frozen in liquid nitrogen and lyophilized overnight to remove all the solvent. The residue was very carefully washed with chloroform (5x 1 mL) and DCM (3x 1 mL). TLC (40% EtOAc in Hexane) showed that all excess linker was washed away and no sugar dissolved. The washed residue was solved in DMSO and transferred to a 1.5 mL vial for conjugation and lyophilized again. CRM₁₉₇ (1 mg) was dissolved in 750 μL autoclaved water. The CRM₁₉₇ solution was transferred into Amicon 10k filter and washed with water by centrifuge to remove most of the salt. The filtrate (~ 60 μL) was transferred to the conjugation vial with phosphate buffer solution (PBS, 2x 30 μL , pH = 8) and the solution was stirred at r.t. for 23 h. The solution was then transferred onto Amicon 10k filter, washed with PBS (4x 400 μL , pH = 8) by centrifuge, transferred to a clean vial and diluted with PBS to 400 μL . The solution of conjugated saccharide was kept at 4 $^{\circ}\text{C}$ for further biological study.

Experimental Section

CRM₁₉₇-2-1

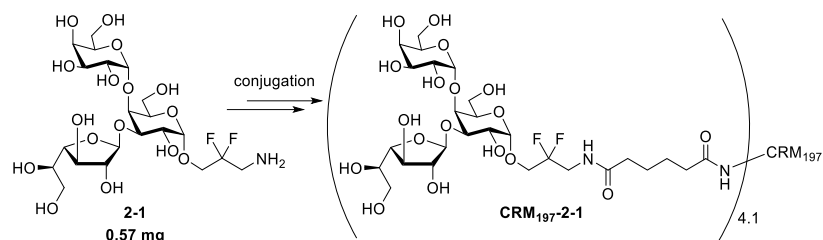

Calculation of the loading number:

MALDI of CRM₁₉₇ and CRM₁₉₇-2-1

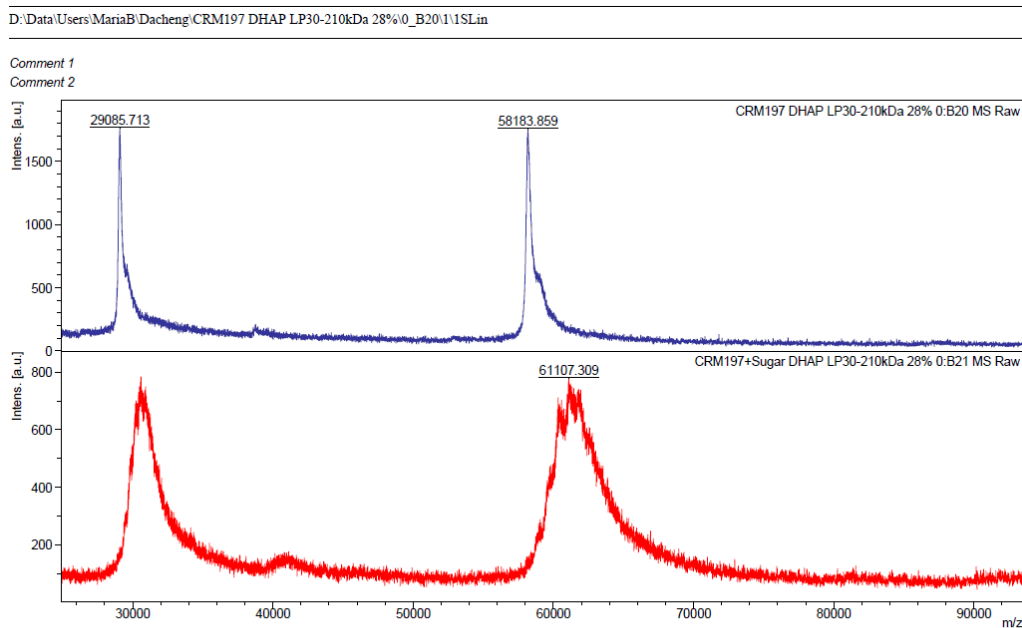

printed: 10/19/2017 12:50:41

MALDI DHAP Matrix of CRM₁₉₇-2-1: 61107 Da

MALDI DHAP Matrix of CRM₁₉₇: 58184 Da

Sugar + Linker: 709 Da

CRM₁₉₇-2-1 - CRM₁₉₇ = 2923 Da

Loading Number $n = 2923 / 709 = 4.1$

CRM₁₉₇-2-2

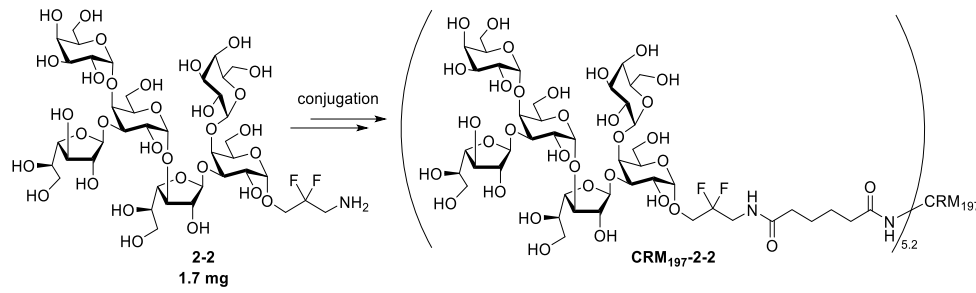

Calculation of the loading number:

MALDI of CRM₁₉₇-2-2

D:\Data\Users\Dacheng\CRM-20180622\CRM-B20_DHAP_LP30-210kDa_70%0_110\1\1SLin

Comment 1
Comment 2

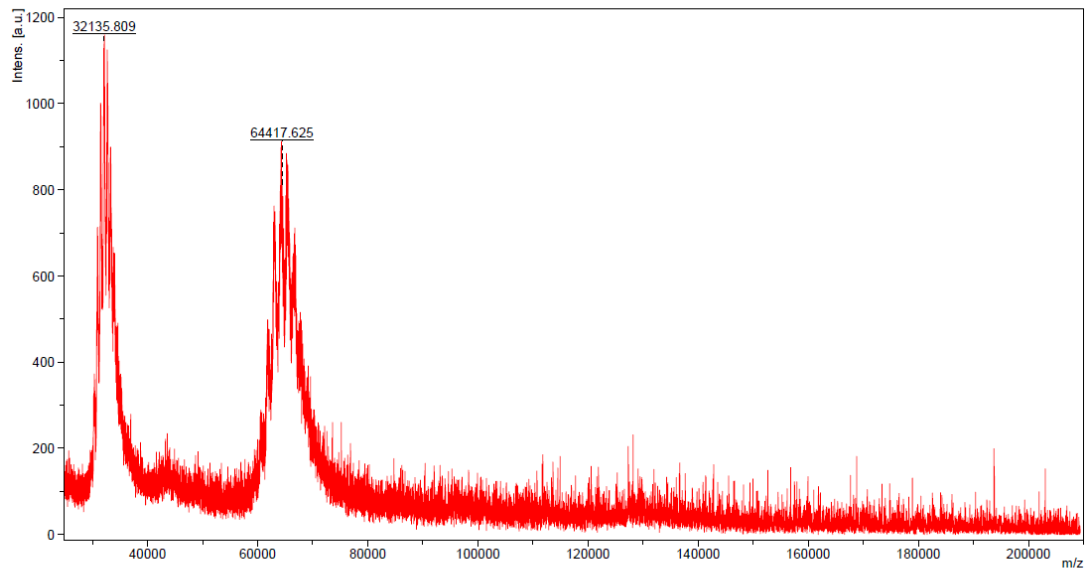

Bruker Daltonics flexAnalysis

printed: 6/22/2018 2:39:56 PM

MALDI DHAP Matrix of CRM₁₉₇-2-2: 64417 Da

MALDI DHAP Matrix of CRM₁₉₇: 58184 Da

Sugar + Linker: 1210 Da

CRM₁₉₇-2-2 - CRM₁₉₇ = 6233 Da

Loading Number **n** = 6233 / 1210 = **5.2**

4.4 Methods for Immunological Evaluations

Printing of Glycan Arrays

Synthetic oligosaccharides were dissolved in 50 mM sodium phosphate buffer (PH 8.5) and spotted on *N*-hydroxysuccinimide activated hydrogel coated glass slides (CodeLink slides; Surmodics) using an S3 robotic non-contact microarray printer. Slides were incubated in a humidified chamber overnight and quenched with 100 mM ethanolamine and 50 mM sodium phosphate (PH 9.0) for 1 h at room temperature. Slides were washed with water, dried by centrifugation and stored at 4 °C until use.

General Procedures for Glycan Array Analysis

Slides were blocked by incubation with 1% bovine serum albumin in phosphate buffered saline (1% BSA-PBS) for at least 30 min at r.t.. Slides were washed twice with PBS and dried by centrifugation. A 64-well incubation grid (Grace Biolabs) was applied to the slide. 1:10, 1:100 and 1:1000 dilutions of human sera from the patients infected by *Klebsiella pneumoniae* were performed in order to find the best signal without saturation. The dilutions in 1% BSA-PBS were applied to the wells and incubated for 1 h at 37 °C in a humid and dark chamber. Wells were washed three times with PBS containing 0.1% Tween-20 (PBS-T). Secondary antibody dilutions in 1% BSA-PBS were applied to the wells and incubated for 1 h at 37 °C in a humid and dark chamber. The following secondary antibodies were used: goat anti-human IgG H+L AlexaFluor 635 (Thermo Fisher Scientific Invitrogen). Wells were washed twice with PBS-T and once with PBS. The incubation grid was removed and the slides were rinsed with water and dried by centrifugation. Slides were scanned using a GenePix 4300A microarray scanner (Molecular Devices, Sunnyvale, CA, USA) with a wavelength of 635 nm and evaluated using GenePix Pro 7.2 (both from Molecular Devices). The photomultiplier tube (PMT) voltage was adjusted until scans were free of saturation signals.

Immunization of Rabbits

A group of five rabbits (obtained from BioGenes, Berlin, Germany) were immunized with glycoconjugate (antigen CRM₁₉₇-2-2 per dose) mixed with aluminum hydroxide as adjuvant (Brenntag, Mülheim, Germany). The negative control group contained three rabbits (BioGenes, Berlin, Germany) and they were injected with only PBS with aluminum hydroxide. On days 14 and 28, the rabbits received booster immunizations with the same formulation. Rabbits were bled weekly and the antibody levels were measured by glycan microarrays.

ELISA Analysis of Blood Samples

High binding 96-well polystyrene micro titer plates (Corning, USA) were coated overnight at 4 °C with 10 $\mu\text{g}\cdot\text{mL}^{-1}$ of CRM₁₉₇ in PBS, PH = 7.2 (50 μL per well). The plates were washed with PBS-T for three times and blocked with 1% BSA in PBS for 1 h at room temperature. After three times of washing with PBS-T, the plates were incubated with each individual rabbit serum at different dilutions in duplicate or triplicate for 1 h at room temperature. The plates were washed for four or five times with PBS-T and incubated with horseradish peroxidase (HRP) conjugated anti-rabbit IgG antibodies H+L (Sigma-Aldrich, USA), then washed thoroughly with PBS-T. The absorbance was recorded at 450 nm using an ELISA reader (Infinite[®] 200 NanoQuant, Tecan, Switzerland).

4.5 Chemical Synthetic Study about SS3 and SS18

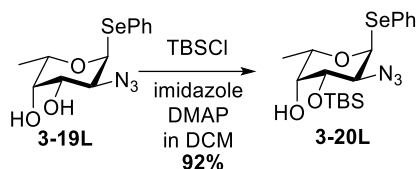
Phenyl 2-azido-3-*O*-*tert*-butyldimethylsilyl-2,6-di-deoxy-1-seleno- α -L-galactopyranoside (3-20L)

Selenoglycoside **3-19L** (701 mg, 2.14 mmol, 1.0 eq.) was dissolved in DCM and TBSCl (968 mg, 6.41 mmol, 3.0 eq.), imidazole (727 mg, 10.7 mmol, 5.0 eq.) and DMAP (130 mg, 1.07 mmol, 0.5 eq.) were added sequentially and the mixture was stirred at r.t. overnight. The mixture became turbid and more DMAP was added later till the mixture was transparent again. After TLC showed that most of the starting material disappeared, MeOH was added to the mixture to quench the reaction. The solvent was evaporated directly and the crude was purified by FC. Selenoglycoside **3-20L** (871 mg, 1.97 mmol, yield: 92%) was obtained as white solid. ^1H NMR (400 MHz, Chloroform-*d*) δ 7.63 – 7.54 (m, 2H), 7.32 – 7.26 (m, 3H), 5.92 (d, $J = 5.3$ Hz, 1H), 4.33 (qt, $J = 6.5$, 1.5 Hz, 1H), 4.03 (dd, $J = 9.8$, 5.2 Hz, 1H), 3.79 (dd, $J = 9.8$, 3.3 Hz, 1H), 3.68 (dt, $J = 2.8$, 1.2 Hz, 1H), 2.47 (t, $J = 1.3$ Hz, 1H), 1.28 (d, $J = 6.6$ Hz, 3H), 0.95 (s, 9H), 0.23 (s, 3H), 0.18 (s, 3H). ^{13}C NMR (101 MHz, Chloroform-*d*) δ 134.5, 134.5, 129.2, 128.8, 127.9, 85.4, 85.0, 77.5, 77.2, 76.8, 72.9, 71.9, 71.8, 68.6, 62.5, 25.9, 18.1, 16.2, -4.6, -4.7. HRMS (Q-ToF): calculated for $\text{C}_{18}\text{H}_{29}\text{N}_3\text{O}_3\text{SeSiNa}^+$ $[\text{M}+\text{Na}]^+$ 466.1036, found 466.1091 *m/z*.

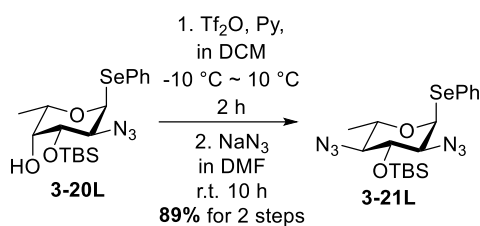
Phenyl 2,4-di-azido-3-*O*-*tert*-butyldimethylsilyl-2,4,6-tri-deoxy-1-seleno- α -L-glucopyranoside (3-21L)

Selenoglycoside **3-20L** (769 mg, 1.74 mmol, 1.0 eq.) was dissolved in DCM (10 mL). Pyridine (0.84 mL, 10.42 mmol, 6.0 eq.) and Tf_2O (0.35 mL, 2.083 mmol, 1.2 eq.)

were added sequentially at $-10\text{ }^{\circ}\text{C}$ (salt-ice-water bath) and the temperature was slowly raised to r.t.. After TLC showed a full conversion of **3-20L**, the mixture was evaporated *in vacuo* and then dissolved in anhydrous DMF. NaN_3 (1.13 g, 17.36 mmol, 10.0 eq.) was added and the mixture was stirred overnight. The crude product was extracted with EtOAc, washed with H_2O and brine, dried with $\text{Na}_2\text{SO}_4(\text{s})$, evaporated *in vacuo* and purified by FC. Selenoglycoside **3-21L** (722 mg, 1.543 mmol, yield: 89%) was obtained as yellow oil. ^1H NMR (400 MHz, Chloroform-*d*) δ 7.64 – 7.48 (m, 2H), 7.41 – 7.27 (m, 3H), 5.85 (d, $J = 5.2$ Hz, 1H), 4.07 (dq, $J = 10.1, 6.2$ Hz, 1H), 3.71 (dd, $J = 9.7, 5.2$ Hz, 1H), 3.52 (t, $J = 9.3$ Hz, 1H), 3.02 (dd, $J = 10.1, 9.1$ Hz, 1H), 1.31 (d, $J = 6.2$ Hz, 3H), 0.96 (s, 9H), 0.23 (d, $J = 1.4$ Hz, 6H). ^{13}C NMR (101 MHz, Chloroform-*d*) δ 134.7, 129.3, 128.5, 128.2, 84.9, 77.5, 77.4, 77.2, 76.8, 73.4, 70.4, 69.6, 66.8, 25.9, 18.4, 18.2, -4.4, -4.6. HRMS (Q-ToF): calculated for $\text{C}_{18}\text{H}_{28}\text{N}_6\text{O}_2\text{SeSiNa}^+ [\text{M}+\text{Na}]^+$ 491.1100, found 491.1315 m/z.

Phenyl 2,4-di-(2,2,2-trichloroethoxycarbonylamino)-3-*O*-*tert*-butyldimethylsilyl-2,4,6-tri-deoxy-1-seleno- α -L-glucopyranoside (3-8L**)**

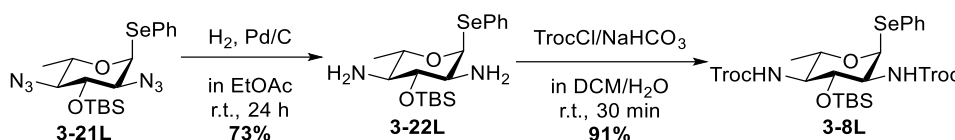

Selenoglycoside **3-21L** (165 mg, 353 μmol , 1.0 eq.) was dissolved in EtOAc (2 mL) and a portion of Pd/C was added. The solution was bubbled with $\text{N}_2(\text{g})$ and $\text{H}_2(\text{g})$ and the resultant was stirred under $\text{H}_2(\text{g})$ with a balloon at r.t. over night. After LCMS showed a full reduction of the azide groups, the suspension was filtrated, concentrated and purified with FC to get **3-22L** (190 mg, 457 μmol , yield: 73%). Selenoglycoside **3-22L** (103 mg, 248 μmol , 1.0 eq.) was taken and dissolved in a mixed solvent of water (1 mL) and DCM (4 mL). NaHCO_3 (62 mg, 743 μmol , 3.0 eq.) and TrocCl (157 mg, 743 μmol , 3.0 eq.) were added and stirred at r.t. for 30 min. After TCL showed a full conversion of the starting material, the mixture was extracted with EtOAc, washed with $\text{HCl}(1\text{ M aq.})$, $\text{NaHCO}_3(\text{sat. aq.})$ and brine, dried with $\text{Na}_2\text{SO}_4(\text{s})$ and concentrated *in vacuo*, the crude product was further purified with FC to get **3-8L** (172 mg, 225 μmol , yield: 91%). ^1H NMR (600 MHz, Chloroform-*d*) δ 7.59 – 7.54 (m, 2H), 7.31 – 7.27 (m, 3H), 5.74 (d, $J = 4.7$ Hz, 1H), 5.15 (d, $J = 9.4$ Hz, 1H), 4.88 (d, $J = 9.4$ Hz, 1H), 4.81 (d,

Experimental Section

$J = 11.9$ Hz, 1H), 4.73 (d, $J = 11.9$ Hz, 1H), 4.63 (dd, $J = 12.0, 3.5$ Hz, 2H), 4.19 (dq, $J = 12.2, 6.2$ Hz, 1H), 4.05 (td, $J = 9.7, 4.6$ Hz, 1H), 3.61 (t, $J = 9.6$ Hz, 1H), 3.48 – 3.34 (m, 1H), 1.34 (d, $J = 6.2$ Hz, 3H), 0.86 (s, 9H), 0.13 (s, 3H), 0.11 (s, 3H), 0.07 (s, 2H). ^{13}C NMR (101 MHz, Chloroform-*d*) δ 167.9, 165.1, 155.4, 154.2, 143.2, 141.4, 138.0, 137.9, 136.9, 135.4, 133.5, 129.8, 129.6, 129.2, 128.8, 128.6, 128.6, 128.5, 128.4, 128.3, 128.2, 127.9, 127.9, 127.6, 127.4, 127.3, 125.4, 125.3, 120.3, 101.0, 100.4, 95.5, 82.5, 77.5, 77.2, 76.8, 76.1, 74.6, 74.5, 73.7, 71.0, 70.8, 70.7, 69.9, 69.5, 67.2, 67.1, 63.2, 57.6, 56.3, 50.6, 50.3, 47.3, 47.1, 46.5, 46.1, 32.1, 31.9, 29.8, 29.7, 29.5, 29.0, 27.8, 27.4, 25.6, 23.1, 22.8, 22.8, 21.6, 17.7, 14.3, 14.1, 11.9. HRMS (Q-ToF): calculated for $\text{C}_{24}\text{H}_{38}\text{Cl}_6\text{N}_3\text{O}_6\text{SeSi}^+ [\text{M}+\text{NH}_4]^+$ 781.9821, found 781.9813 m/z .

4-Methoxyphenyl 2-*O*-benzoyl-3-*O*-benzyl-4,6-di-*O*-benzylidene- β -D-glucopyranoside (**3-25**)

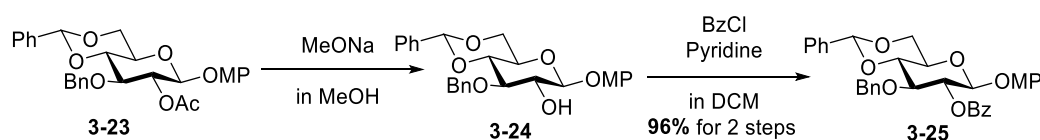

Starting material **3-23** (552 mg, 1.09 mmol, 1.0 eq.) was dissolved in methanol (10 mL). Sodium methoxide (0.5 M in MeOH, 0.44 mL, 0.22 mmol) was added and the mixture was stirred until TLC showed a full conversion of the starting material. Amberlite (H^+) was added to adjust the pH to 7. After filtration and removal of solvent, **3-24** was put under high vacuum overnight and used in the next step without further purification. DCM (20 mL) was added as solvent. Pyridine (0.26 mL, 3.27 mmol, 3.0 eq.) and BzCl (0.38 mL, 3.27 mmol, 3.0 eq.) were added and the solution was stirred at r.t. overnight. TLC showed a full conversion of **3-24** and the mixture was evaporated and purified with FC to get white solid **3-25**, 598 mg, 1.05 mmol, yield: 96% for 2 steps. ^1H NMR (400 MHz, Chloroform-*d*) δ 8.05 – 7.96 (m, 2H), 7.65 – 7.57 (m, 1H), 7.56 – 7.50 (m, 2H), 7.49 – 7.37 (m, 5H), 7.16 (td, $J = 7.4, 6.8, 1.6$ Hz, 3H), 7.12 – 7.06 (m, 2H), 6.92 – 6.85 (m, 2H), 6.78 – 6.72 (m, 2H), 5.65 (s, 1H), 5.58 – 5.50 (m, 1H), 5.07 (d, $J = 7.9$ Hz, 1H), 4.86 (d, $J = 12.1$ Hz, 1H), 4.73 (d, $J = 12.1$ Hz, 1H), 4.43 (dd, $J = 10.6, 5.0$ Hz, 1H), 4.00 – 3.87 (m, 3H), 3.73 (s, 3H), 3.66 – 3.56 (m, 1H). ^{13}C NMR (101 MHz, Chloroform-*d*) δ 165.2, 155.8, 151.2, 137.8, 137.2, 133.4, 130.0, 129.8, 129.2, 128.6, 128.5, 128.5, 128.4, 128.3, 128.2, 127.7, 126.2, 119.0, 114.6, 101.5, 101.5, 81.6,

77.9, 77.5, 77.4, 77.2, 76.8, 74.2, 73.4, 68.8, 66.6, 55.7. LCMS (ESI): calculated for $C_{34}H_{32}O_8Na^+$ $[M+Na]^+$ 591.2, found 591.1 m/z. Data compatible as reported.¹⁰⁸

4-Methoxyphenyl 2-*O*-benzoyl-3-*O*-benzyl- β -D-glucopyranoside (**3-26**)

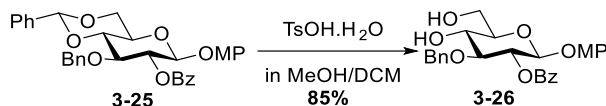

Starting material **3-25** (248 mg, 435 μ mol, 1.0 eq.) was dissolved in a mixed solvent of DCM (3 mL) and MeOH (3 mL). TsOH·H₂O (83 mg, 435 μ mol, 1.0 eq.) was added and the reaction was monitored by TLC. As soon as the cleavage of benzylidene was completed, the reaction was quenched with TEA, concentrated *in vacuo* and the crude product was further purified with FC to give **3-26** (178 mg, 370 μ mol, yield: 85%). ¹H NMR (400 MHz, Chloroform-*d*) δ 8.09 – 8.04 (m, 2H), 7.62 – 7.56 (m, 1H), 7.49 – 7.41 (m, 2H), 7.23 (s, 5H), 6.92 – 6.83 (m, 2H), 6.80 – 6.71 (m, 2H), 5.49 (dd, J = 9.4, 7.9 Hz, 1H), 5.05 (d, J = 7.9 Hz, 1H), 4.78 (d, J = 11.5 Hz, 1H), 4.63 (d, J = 11.6 Hz, 1H), 3.97 (ddd, J = 11.9, 5.9, 3.4 Hz, 1H), 3.90 – 3.81 (m, 2H), 3.77 (d, J = 9.2 Hz, 1H), 3.73 (s, 3H), 3.56 (ddd, J = 9.5, 5.1, 3.4 Hz, 1H), 2.51 (d, J = 3.0 Hz, 1H), 2.10 (t, J = 6.8 Hz, 1H). ¹³C NMR (101 MHz, Chloroform-*d*) δ 165.3, 155.6, 151.3, 137.8, 133.5, 129.9, 129.7, 128.7, 128.7, 128.2, 128.2, 118.5, 114.7, 100.9, 82.5, 77.5, 77.4, 77.2, 76.8, 75.6, 74.8, 73.6, 70.4, 62.6, 55.7. LCMS (ESI): calculated for $C_{27}H_{28}O_8Na^+$ $[M+Na]^+$ 503.2, found 503.1 m/z. Data compatible as reported.¹⁰⁹

4-Methoxyphenyl (benzyl 2-*O*-benzoyl-3-*O*-benzyl- β -D-glucopyranosyluronate) (**3-9**)

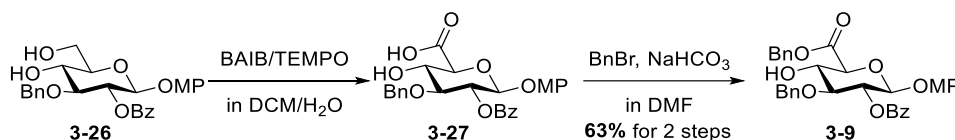

Diol **3-26** (100 mg, 239 μ mol, 1.0 eq.) was dissolved in a DCM (2 mL) and H₂O (1 mL). BAIB (193 mg, 598 μ mol, 2.5 eq.) and TEMPO (19 mg, 120 μ mol, 0.5 eq.) were added to the mixture sequentially. The resultant was stirred at r.t. and after TLC showed a full conversion of the starting material. The solvent was evaporated and the

Experimental Section

crude product was purified by FC (30% EtOAc in Hex) to get **3-27** as white foam (486 mg, 0.839 mmol, yield: 84%). **3-27** (100 mg, 239 μ mol, 1.0 eq.) was dissolved in a DCM (2 mL) and H₂O (1 mL). BAIB (193 mg, 598 μ mol, 2.5 eq.) and TEMPO (19 mg, 120 μ mol, 0.5 eq.) were added to the mixture sequentially. The resultant was stirred at r.t. and after TLC showed a full conversion of the starting material, the solvent was evaporated and the crude product was purified by FC (30% EtOAc in Hex) to get **3-9** as white foam (486 mg, 0.839 mmol, yield: 84%). ¹H NMR (400 MHz, Chloroform-*d*) δ 8.07 – 7.96 (m, 2H), 7.64 – 7.54 (m, 1H), 7.45 (t, *J* = 7.4 Hz, 2H), 7.37 (p, *J* = 2.7, 2.0 Hz, 5H), 7.23 – 7.12 (m, 5H), 6.96 – 6.86 (m, 2H), 6.71 (dt, *J* = 8.9, 1.2 Hz, 2H), 5.50 (ddt, *J* = 9.2, 7.7, 1.3 Hz, 1H), 5.33 – 5.18 (m, 2H), 5.00 (dt, *J* = 7.7, 1.3 Hz, 1H), 4.85 – 4.72 (m, 2H), 4.21 (t, *J* = 9.3 Hz, 1H), 4.04 (dt, *J* = 9.7, 1.4 Hz, 1H), 3.82 – 3.75 (m, 1H), 3.73 (d, *J* = 1.2 Hz, 3H), 3.07 (s, 1H), 2.05 (d, *J* = 1.2 Hz, 1H), 1.29 – 1.21 (m, 2H). ¹³C NMR (101 MHz, Chloroform-*d*) δ 168.7, 165.1, 155.7, 151.1, 137.7, 134.9, 133.3, 130.0, 129.8, 129.6, 128.7, 128.6, 128.5, 128.3, 128.1, 128.1, 127.8, 119.3, 119.2, 114.4, 101.3, 80.6, 77.4, 77.1, 76.7, 74.5, 74.3, 72.8, 71.8, 67.5, 60.4, 55.6, 29.7, 21.1, 14.2. Data compatible as reported.¹¹⁰

4-Methoxyphenyl 2,4-di-(2,2,2-trichloroethoxycarbonylamino)-3-*O*-*tert*-butyldimethylsilyl-2,4,6-tri-deoxy- α/β -L-glucopyranosyl-(1 \rightarrow 4)-(benzyl 2-*O*-benzoyl-3-*O*-benzyl- β -D-glucopyranosyluronate) (**3-28 α/β**)

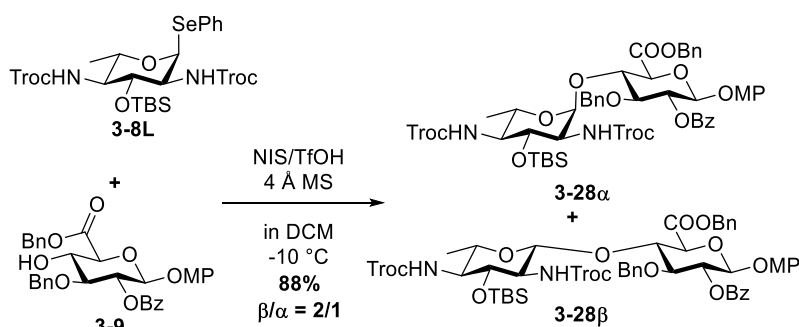

Donor **3-8L** (188 mg, 245 μ mol, 1.0 eq.) and acceptor **3-9** (144 mg, 245 μ mol, 1.0 eq.) were coevaporated with toluene for three times and put under high vacuum overnight to remove trace water in them. The starting materials were dissolved in anhydrous toluene (3 mL), 4 Å molecular sieves were added and the suspension was stirred at -10 °C for 5 min. NIS (83 mg, 368 μ mol, 1.5 eq.) and TfOH (3.3 μ L, 37 μ mol,

0.15 eq.) were added and the resultant mixture was stirred at that temperature until TLC showed a full conversion of the donor. The reaction was quenched with Na₂S₂O₃(aq.), extracted with EtOAc, washed with Na₂S₂O₃(aq.) and brine, dried with Na₂SO₄(s), concentrated and purified with FC to get the glycosylation products (257 mg, 215 μmmol, yield: 88%). **3-28α** (107 mg) and **3-28β** (150 mg) could be well separated. Only desired **3-28β** was characterized: ¹H NMR (600 MHz, Chloroform-*d*) δ 8.02 (d, *J* = 7.7 Hz, 2H), 7.58 (t, *J* = 7.4 Hz, 1H), 7.45 (t, *J* = 7.7 Hz, 2H), 7.38 (t, *J* = 6.2 Hz, 4H), 7.34 (d, *J* = 7.9 Hz, 3H), 7.29 (d, *J* = 7.5 Hz, 1H), 7.20 (ddt, *J* = 29.8, 13.9, 7.0 Hz, 2H), 6.88 (d, *J* = 8.8 Hz, 2H), 6.75 – 6.67 (m, 2H), 5.55 (t, *J* = 8.1 Hz, 1H), 5.26 (d, *J* = 12.4 Hz, 1H), 5.10 (d, *J* = 12.5 Hz, 1H), 5.03 (d, *J* = 7.3 Hz, 1H), 4.81 (dd, *J* = 11.8, 6.3 Hz, 2H), 4.76 (d, *J* = 11.9 Hz, 1H), 4.66 (t, *J* = 10.8 Hz, 2H), 4.57 (dd, *J* = 10.6, 6.8 Hz, 2H), 4.48 (d, *J* = 12.0 Hz, 1H), 4.29 (q, *J* = 8.3, 7.2 Hz, 2H), 4.18 (d, *J* = 9.4 Hz, 1H), 3.91 (t, *J* = 9.0 Hz, 1H), 3.72 (s, 3H), 3.42 – 3.28 (m, 2H), 3.23 (t, *J* = 9.5 Hz, 1H), 3.00 (q, *J* = 9.5 Hz, 1H), 1.17 (d, *J* = 6.1 Hz, 3H), 0.81 (s, 9H), -0.12 (s, 3H). ¹³C NMR (151 MHz, Chloroform-*d*) δ 167.6, 165.2, 155.9, 154.0, 153.9, 151.2, 138.2, 135.5, 133.6, 130.0, 129.5, 129.2, 128.8, 128.8, 128.7, 128.6, 128.5, 128.4, 128.4, 128.3, 128.1, 127.6, 125.4, 119.2, 114.6, 101.0, 100.7, 95.3, 82.8, 77.4, 77.2, 76.9, 76.4, 75.1, 74.9, 74.6, 74.5, 73.7, 72.7, 70.5, 67.1, 60.4, 59.0, 55.7, 25.7, 21.6, 18.0, 18.0, 1.2, -4.2, -4.4. HRMS (Q-ToF): calculated for C₅₂H₆₀Cl₆N₂O₁₅SiNa⁺ [M+Na]⁺ 1213.1786, found 1213.1804 m/z.

2,4-Di-(2,2,2-trichloroethoxycarbonylamino)-3-*O*-*tert*-butyldimethylsilyl-2,4,6-tri-deoxy-β-L-glucopyranosyl-(1→4)-(benzyl 2-*O*-benzoyl-3-*O*-benzyl-α/β-D-glucopyranosyluronate) (3-29)

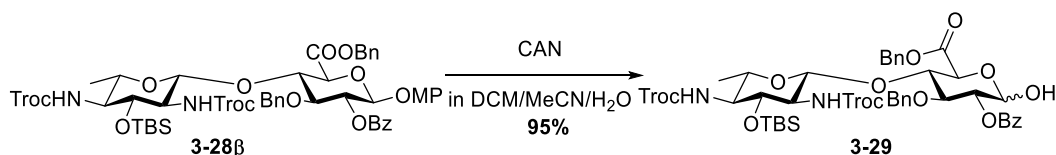

Disaccharide **3-28β** (134 mg, 112 μmol, 1.0 eq.) was dissolved in a mixed solvent of DCM (1 mL), MeCN (2 mL) and H₂O (1 mL). CAN (237 mg, 432 μmol, 4.0 eq.) was added and the mixture was stirred at r.t.. Color of the mixture turned orange. The reaction was monitored by TLC and as soon as the starting material was fully hydrolyzed, the reaction was quenched with TEA. The product was extracted with

Experimental Section

EtOAc, washed with water and brine, dried with Na₂SO₄(s), concentrated and purified with FC to get **3-29** (116 mg, 107 μmol, yield: 95%). NMR pure spectra could not be obtained. HRMS (Q-ToF): calculated for C₄₅H₅₄Cl₆N₂O₁₄SiNa⁺ [M+Na]⁺ 1107.1368, found 1107.1406 m/z.

2,4-Di-(2,2,2-trichloroethoxycarbonylamino)-3-*O*-*tert*-butyldimethylsilyl-2,4,6-trideoxy-β-L-glucopyranosyl-(1→4)-(benzyl 2-*O*-benzoyl-3-*O*-benzyl-α/β-D-glucopyranosyluronoyl) *N*-phenyltrifluoroacetimidate (**3-30**)

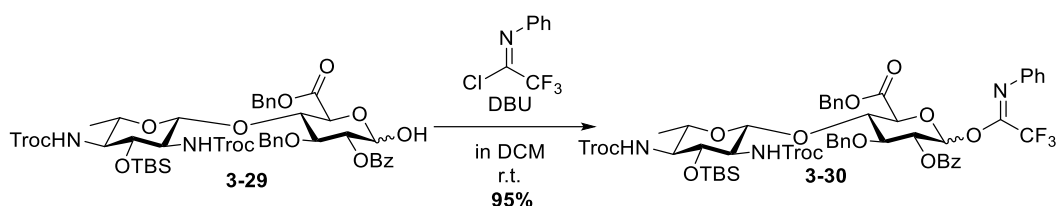

Disaccharide **3-29** (98 mg, 90 μmol, 1.0 eq.) and trifluoro-*N*-phenylacetimidoyl chloride (88 μL, 540 μmol, 6.0 eq.) were dissolved in DCM (1 mL), the solvent was cooled to 0 °C (ice-water bath) and DBU (40 μL, 270 μmol, 3.0 eq.) was added. The mixture was stirred at r.t. until TLC showed a full conversion of the starting material. After evaporation, the crude product was further purified by FC (15% EA in Hex) to get yellowish syrup **3-30** (108 mg, 86 μmol, yield: 95%). NMR pure spectra could not be obtained. HRMS (Q-ToF): calculated for C₅₃H₅₈Cl₆F₃N₃O₁₄SiNa⁺ [M+Na]⁺ 1278.1663, found 1278.1633 m/z.

2,4-Di-(2,2,2-trichloroethoxycarbonylamino)-3-*O*-*tert*-butyldimethylsilyl-2,4,6-trideoxy-β-L-glucopyranosyl-(1→4)-(benzyl 2-*O*-benzoyl-3-*O*-benzyl-β-D-glucopyranosyluronoyl)-(1→1)-5-(*N*-benzyl-*N*-benzyloxycarbonyl)aminopentanol (**3-31**)

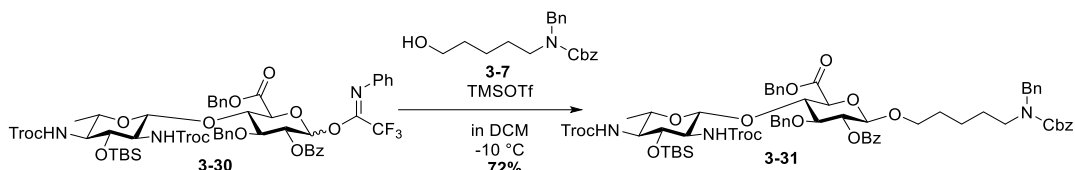

Disaccharide **3-30** (50 mg, 40 μmol, 1.0 eq.) and **3-7** (32 mg, 100 μmol, 2.5 eq.) were coevaporated with toluene and put under high vacuum to remove trace water

before they were dissolved in anhydrous DCM (1.0 mL). Acid washed 4 Å molecular sieves were added and the mixture was cooled to -10 °C with ice-salt water bath. TMSOTf (1.6 µL, 10 µmol, 0.25 eq.) was added and after TLC showed a full conversion of the donor, the reaction was quenched by Et₃N(l), diluted with EtOAc, washed with NaCl(sat. aq.), dried with Na₂SO₄(s), concentrated *in vacuo* and further purified with FC to get colorless syrup **3-31** (40 mg, 29 µmol), yield: 72%. ¹H NMR (600 MHz, Chloroform-*d*) δ 8.06 – 7.92 (m, 2H), 7.52 – 7.27 (m, 19H), 7.25 – 7.04 (m, 5H), 5.41 – 5.20 (m, 2H), 5.15 (dd, *J* = 16.2, 9.7 Hz, 4H), 5.04 – 4.88 (m, 1H), 4.85 (d, *J* = 11.8 Hz, 1H), 4.77 (t, *J* = 12.9 Hz, 2H), 4.68 (dd, *J* = 22.9, 10.5 Hz, 1H), 4.62 – 4.55 (m, 2H), 4.55 – 4.45 (m, 3H), 4.43 – 4.28 (m, 3H), 4.20 (d, *J* = 7.8 Hz, 1H), 4.06 (dt, *J* = 11.7, 7.0 Hz, 2H), 3.87 – 3.74 (m, 2H), 3.33 (dd, *J* = 22.9, 14.1 Hz, 3H), 3.15 (t, *J* = 9.6 Hz, 1H), 3.06 – 2.90 (m, 3H), 2.05 (s, 3H), 0.81 (s, 10H), 0.07 (d, *J* = 1.2 Hz, 2H), -0.07 (d, *J* = 5.2 Hz, 3H), -0.14 (d, *J* = 7.2 Hz, 3H). ¹³C NMR (151 MHz, Chloroform-*d*) δ 171.3, 168.0, 165.1, 154.1, 153.9, 139.4, 138.1, 135.6, 133.5, 129.8, 129.7, 128.8, 128.7, 128.7, 128.6, 128.6, 128.4, 128.2, 128.0, 127.4, 114.2, 101.0, 100.7, 95.3, 77.4, 77.2, 76.9, 76.6, 75.2, 74.9, 74.4, 73.9, 72.8, 70.5, 69.9, 67.2, 67.0, 64.5, 60.5, 60.4, 58.9, 50.3, 47.2, 36.8, 34.0, 32.1, 31.6, 30.8, 30.3, 29.8, 29.8, 29.8, 29.7, 29.5, 29.3, 29.1, 29.1, 28.6, 25.7, 24.9, 24.8, 24.0, 23.5, 23.1, 22.8, 21.2, 21.2, 20.7, 19.3, 18.0, 18.0, 14.3, 14.3, 13.8, 8.1, 1.2, -4.2, -4.4. HRMS (Q-ToF): calculated for C₆₅H₇₇Cl₆N₃O₁₆SiNa⁺ [M+Na]⁺ 1416.3096, found 1416.3086 m/z.

Phenyl 2,4-di-(2,2,2-trichloroethoxycarbonylamino)-2,4,6-tri-deoxy-1-seleno- α -L-glucopyranoside (**3-32L**)

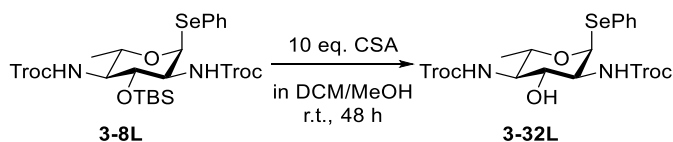

Selenoglycoside **3-8L** (81 mg, 106 µmol, 1.0 eq.) was dissolved in a mixed solvent of DCM (1.5 mL) and MeOH (1.5 mL). CSA (247 mg, 1060 µmol, 10 eq.) was added to the solution and the mixture was stirred at r.t. for 48h. TLC showed a full conversion of the starting material. The reaction was quenched with TEA and concentrated *in vacuo*. The crude product was extracted with EtOAc, washed with water and brine, dried with Na₂SO₄(s), concentrated again and purified with FC to get **3-32L**

Experimental Section

(64 mg, 98 μmol , yield: 93%). ^1H NMR (400 MHz, Chloroform-*d*) δ 7.58 – 7.52 (m, 2H), 7.32 – 7.26 (m, 3H), 5.85 (d, $J = 4.8$ Hz, 1H), 5.67 – 5.52 (m, 1H), 5.27 (t, $J = 16.6$ Hz, 1H), 4.85 (d, $J = 12.1$ Hz, 1H), 4.81 – 4.62 (m, 4H), 4.11 (dddd, $J = 29.9, 13.7, 9.4, 5.4$ Hz, 2H), 3.55 (dt, $J = 23.9, 9.7$ Hz, 2H), 1.35 (d, $J = 6.2$ Hz, 4H), 1.28 – 1.20 (m, 2H). ^{13}C NMR (151 MHz, Chloroform-*d*) δ 176.5, 155.2, 154.9, 134.1, 129.6, 129.0, 128.3, 88.8, 77.4, 77.2, 76.9, 75.0, 74.9, 73.0, 70.7, 70.4, 69.5, 63.2, 59.9, 57.6, 47.3, 32.1, 31.9, 29.9, 29.8, 29.7, 29.5, 25.6, 22.8, 22.8, 17.9, 14.3, 14.1, 11.9. HRMS (Q-ToF): calculated for $\text{C}_{18}\text{H}_{20}\text{Cl}_6\text{N}_2\text{O}_6\text{SeK}^+ [\text{M}+\text{K}]^+$ 688.8249, found 688.8206 m/z .

2,4-Di-(2,2,2-trichloroethoxycarbonylamino)-2,4,6-tri-deoxy- β -L-glucopyranosyl-(1 \rightarrow 4)-(benzyl 2-*O*-benzoyl-3-*O*-benzyl- β -D-glucopyranosyluronoyl)-(1 \rightarrow 1)-5-(*N*-benzyl-*N*-benzyloxycarbonyl)aminopentanol (3-33)

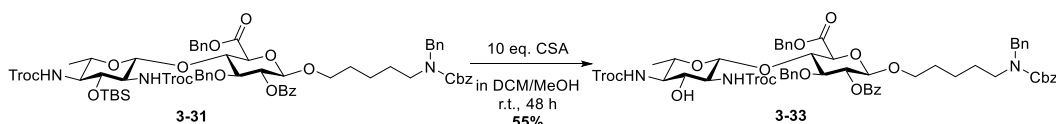

Disaccharide **3-31** (28 mg, 20 μmol , 1.0 eq.) was dissolved in a mixed solvent of DCM (0.5 mL) and MeOH (0.5 mL). CSA (47 mg, 200 μmol , 10 eq.) was added to the solution and the mixture was stirred at r.t. for 48h. TLC showed a full conversion of the starting material. The reaction was quenched with TEA and concentrated *in vacuo*. The crude product was extracted with EtOAc, washed with water and brine, dried with $\text{Na}_2\text{SO}_4(\text{s})$, concentrated again and purified with FC to get **3-33** (14 mg, 11 μmol , yield: 55%). ^1H NMR (600 MHz, Chloroform-*d*) δ 7.96 (s, 2H), 7.50 (t, $J = 7.4$ Hz, 1H), 7.45 – 7.27 (m, 14H), 7.23 – 7.07 (m, 4H), 5.36 – 5.28 (m, 1H), 5.23 (d, $J = 12.5$ Hz, 1H), 5.18 (d, $J = 12.5$ Hz, 1H), 5.16 – 5.10 (m, 2H), 4.85 (s, 1H), 4.77 (t, $J = 11.1$ Hz, 3H), 4.71 – 4.60 (m, 3H), 4.58 – 4.49 (m, 1H), 4.47 (d, $J = 8.4$ Hz, 1H), 4.39 (d, $J = 10.6$ Hz, 2H), 4.18 (s, 1H), 4.07 (s, 1H), 3.92 (dt, $J = 46.3, 7.6$ Hz, 1H), 3.79 (d, $J = 31.7$ Hz, 1H), 3.59 – 3.47 (m, 1H), 3.40 – 3.11 (m, 6H), 3.05 (s, 1H), 2.95 (s, 1H), 1.26 (s, 6H), 1.21 (dd, $J = 7.0, 1.4$ Hz, 4H), 1.15 (dd, $J = 6.4, 1.3$ Hz, 2H), 0.90 – 0.85 (m, 2H). ^{13}C NMR (151 MHz, Chloroform-*d*) δ 133.5, 129.8, 128.8, 128.6, 128.6, 128.3, 128.0, 127.6, 77.4, 77.2, 76.9, 75.0, 74.7, 73.9, 67.3, 59.1, 29.9, 17.9, 15.3, 1.2. HRMS (Q-ToF): calculated for $\text{C}_{59}\text{H}_{63}\text{Cl}_6\text{N}_3\text{O}_{16}\text{Na}^+ [\text{M}+\text{Na}]^+$ 1302.2232, found 1302.2246 m/z .

Phenyl 2,4-di-trichloroacetamido-2,4,6-tri-deoxy-1-seleno- α -L-glucopyranoside (3-34L)

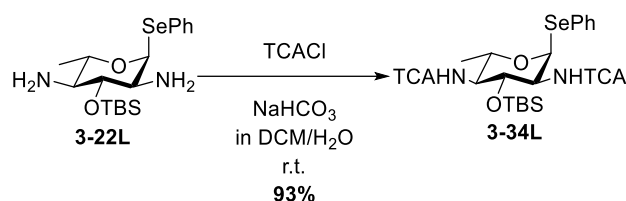

Selenoglycoside **3-22L** (50 mg, 120 μmol , 1.0 eq.) was taken and dissolved in a mixed solvent of water (0.3 mL) and DCM (1.2 mL). NaHCO_3 (30 mg, 360 μmol , 3.0 eq.) and TCACl (43 μL , 360 μmol , 3.0 eq.) were added and stirred at r.t. for 30 min. After TLC showed a full conversion of the starting material, the mixture was extracted with EtOAc , washed with HCl (1 M aq.), NaHCO_3 (sat. aq.) and brine, dried with Na_2SO_4 (s) and concentrated *in vacuo*, the crude product was further purified with FC to get **3-34L** (85 mg, 111 μmol , yield: 93%). HRMS (Q-ToF): calculated for $\text{C}_{22}\text{H}_{30}\text{Cl}_6\text{N}_2\text{O}_4\text{SeSiNa}^+ [\text{M}+\text{Na}]^+$ 726.9163, found 726.9153 m/z.

5-(N-Benzyl-N-benzyloxycarbonyl)aminopentanyl 2-O-benzoyl-3-O-benzyl-4,6-di-O-benzylidene- β -D-glucopyranoside (3-36)

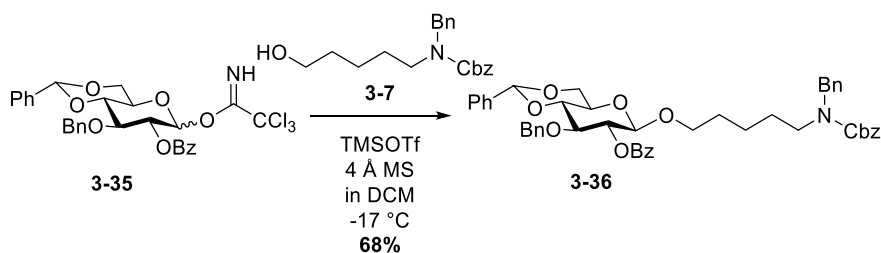

The donor **3-35** (225 mg, 370 μmol , 1.0 eq.) and the acceptor **3-7** (145 mg, 445 μmol , 1.5 eq.) were coevaporated with anhydrous toluene three times and put under high vacuum overnight to remove trace water inside. The mixture was dissolved in DCM (1 mL) and 4 \AA MS was added. After being stirred for 15 min, the mixture was cooled to -17°C and TMSOTf (7 μL , 37 μmol , 0.1 eq.) was added and the resultant mixture continued to be stirred until TLC showed a full conversion of the starting material. The reaction was quenched with $\text{Na}_2\text{S}_2\text{O}_3$ (aq.), extracted with EtOAc , washed with $\text{Na}_2\text{S}_2\text{O}_3$ (aq.) and brine, dried with Na_2SO_4 (s), and further purified with FC to get

Experimental Section

3-36 (195 mg, 110 μmol , yield: 68%). ^1H NMR (600 MHz, Chloroform-*d*) δ 7.95 (d, J = 7.7 Hz, 2H), 7.54 – 7.47 (m, 3H), 7.43 – 7.25 (m, 13H), 7.13 (ddt, J = 33.0, 24.3, 6.6 Hz, 7H), 5.60 (s, 1H), 5.26 (t, J = 8.0 Hz, 1H), 5.13 (d, J = 8.2 Hz, 2H), 4.82 (d, J = 12.1 Hz, 1H), 4.70 (d, J = 12.1 Hz, 1H), 4.54 (dd, J = 28.5, 8.4 Hz, 1H), 4.42 – 4.32 (m, 3H), 3.88 – 3.75 (m, 4H), 3.48 (s, 1H), 3.44 – 3.31 (m, 1H), 3.08 – 2.90 (m, 2H), 1.61 – 1.26 (m, 6H), 1.13 (d, J = 31.4 Hz, 2H). ^{13}C NMR (151 MHz, Chloroform-*d*) δ 165.0, 137.9, 137.2, 133.1, 129.9, 129.8, 129.8, 129.0, 128.5, 128.3, 128.3, 128.3, 128.1, 128.0, 127.8, 127.5, 126.1, 126.0, 101.8, 101.3, 81.7, 77.8, 77.2, 77.0, 76.8, 73.9, 73.4, 70.0, 68.7, 67.1, 66.3, 50.5, 50.2, 47.0, 46.0, 29.0, 27.6, 27.2, 23.0. HRMS (Q-ToF): calculated for $\text{C}_{47}\text{H}_{49}\text{NO}_9\text{Na}^+$ $[\text{M}+\text{Na}]^+$ 794.3300, found 794.3315 m/z .

5-(*N*-Benzyl-*N*-benzyloxycarbonyl)aminopentanyl 2-*O*-benzoyl-3-*O*-benzyl- β -D-glucopyranoside (**3-37**)

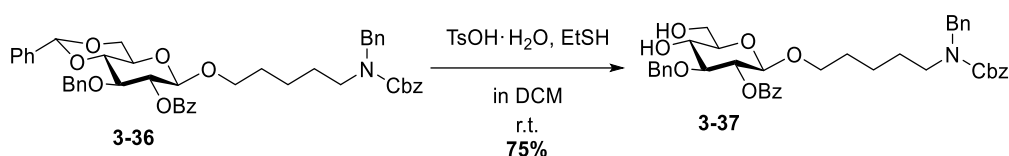

Starting material **3-36** (166 mg, 215 μmol , 1.0 eq.) was dissolved in DCM (1.0 mL). EtSH (0.5 mL) was added and the solution was stirred at r.t. followed by addition of TsOH·H₂O (8 mg, 43 μmol , 0.2 eq.). As soon as TLC showed full conversion of the starting material, the reaction was quenched with TEA, concentrated in vacuo and purified with FC to get **3-37** (110 mg, 161 μmol , yield: 75%). ^1H NMR (600 MHz, Chloroform-*d*) δ 8.01 (d, J = 8.2 Hz, 2H), 7.50 (t, J = 7.4 Hz, 1H), 7.40 – 7.15 (m, 16H), 7.15 – 7.07 (m, 1H), 5.21 (t, J = 8.8 Hz, 1H), 5.13 (d, J = 6.7 Hz, 2H), 4.73 (d, J = 11.5 Hz, 1H), 4.60 (dd, J = 11.5, 5.2 Hz, 1H), 4.51 (dd, J = 27.5, 7.9 Hz, 1H), 4.36 (d, J = 15.6 Hz, 2H), 3.91 (dd, J = 11.9, 3.3 Hz, 1H), 3.81 (dd, J = 12.1, 5.1 Hz, 2H), 3.76 – 3.71 (m, 1H), 3.67 (t, J = 9.1 Hz, 1H), 3.46 – 3.29 (m, 2H), 3.09 – 2.88 (m, 2H), 0.85 (dt, J = 22.3, 6.6 Hz, 3H). ^{13}C NMR (151 MHz, Chloroform-*d*) δ 165.2, 138.0, 133.3, 130.0, 129.8, 128.7, 128.7, 128.6, 128.6, 128.6, 128.1, 128.1, 128.0, 127.9, 127.4, 127.3, 101.5, 82.6, 77.4, 77.2, 76.9, 75.5, 74.6, 73.8, 70.7, 69.9, 67.3, 62.7, 50.6, 50.4, 47.2, 46.2, 32.1, 31.6, 29.8, 29.5, 29.2, 27.8, 27.2, 23.1, 22.8, 14.3. HRMS (Q-ToF): calculated for $\text{C}_{40}\text{H}_{45}\text{NO}_9\text{Na}^+$ $[\text{M}+\text{Na}]^+$ 706.2987, found 706.3000 m/z .

5-(*N*-Benzyl-*N*-benzyloxycarbonyl)aminopentanyl (benzyl 2-*O*-benzoyl-3-*O*-benzyl- β -D-glucopyranosyluronate) (3-39)

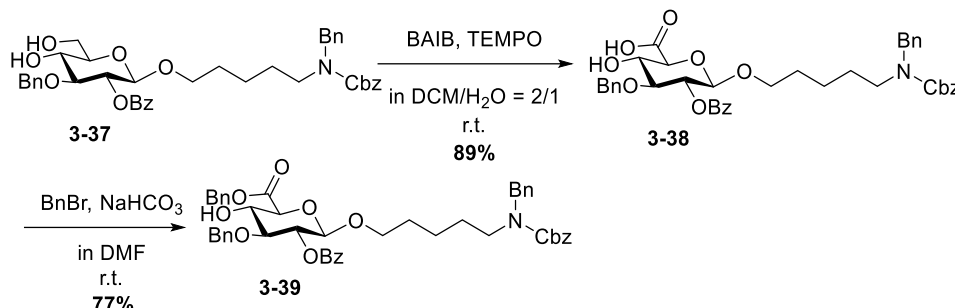

Starting material **3-37** (33 mg, 48 μ mol, 1.0 eq.) was dissolved in a mixed solvent of DCM (0.6 mL) and H₂O (0.3 mL). BAIB (47 mg, 145 μ mol, 3.0 eq.) and TEMPO (4 mg, 24 μ mol, 0.5 eq.) were added and the mixture was stirred at r.t. until LC-MS showed a full conversion of the starting material. The mixture was extracted with EtOAc, dried with Na₂SO₄(s) and filtrated with silica gel to get crude product **3-38** (30 mg, 43 μ mol, yield: 89%). Crude **3-38** (30 mg, 43 μ mol, 1.0 eq.) was put under high vacuum overnight and dissolved in anhydrous DMF (0.8 mL). NaHCO₃ (36 mg, 430 μ mol, 10 eq.) and BnBr (26 μ L, 215 μ mol, 10 eq.) were added sequentially and the mixture was stirred at r.t. until TLC showed the disappearance of the starting material. The mixture was filtrated, evaporated and purified with FC to get **3-39** (26 mg, 33 μ mol, yield: 77%). ¹H NMR (400 MHz, Chloroform-*d*) δ 8.03 – 7.93 (m, 2H), 7.51 (t, *J* = 7.4 Hz, 1H), 7.41 – 7.27 (m, 17H), 7.23 – 7.10 (m, 7H), 5.14 (d, *J* = 4.7 Hz, 2H), 4.75 (d, *J* = 2.2 Hz, 2H), 4.70 (s, 1H), 4.54 (dt, *J* = 20.2, 11.2 Hz, 1H), 4.42 – 4.32 (m, 2H), 4.08 (td, *J* = 9.3, 2.4 Hz, 1H), 3.95 (dd, *J* = 9.5, 3.8 Hz, 1H), 3.89 – 3.74 (m, 1H), 3.71 (t, *J* = 9.1 Hz, 1H), 3.45 – 3.27 (m, 1H), 3.12 – 2.86 (m, 3H). ¹³C NMR (101 MHz, Chloroform-*d*) δ 169.1, 165.1, 156.7, 156.2, 141.0, 138.0, 138.0, 137.9, 137.0, 136.8, 135.1, 133.3, 130.1, 129.8, 128.8, 128.7, 128.7, 128.6, 128.6, 128.5, 128.5, 128.4, 128.4, 128.2, 128.0, 128.0, 127.9, 127.8, 127.7, 127.4, 127.3, 127.2, 127.1, 101.6, 80.8, 80.8, 77.5, 77.4, 77.2, 76.8, 74.5, 73.0, 72.1, 72.0, 70.1, 70.0, 67.6, 67.2, 65.4, 50.5, 50.2, 47.1, 46.1, 32.0, 29.8, 29.5, 29.0, 27.7, 27.3, 23.1, 22.8, 14.3. HRMS (Q-ToF): calculated for C₄₇H₄₉NO₁₀Na⁺ [*M*+Na]⁺ 810.3249, found 810.3298 *m/z*.

2,4-Di-trichloroacetamido-3-*O*-*tert*-butyldimethylsilyl-2,4,6-tri-deoxy- β -L-glucopyranosyl-(1 \rightarrow 4)-(benzyl 2-*O*-benzoyl-3-*O*-benzyl- β -D-glucopyranosyluronoyl)-(1 \rightarrow 1)-5-(*N*-benzyl-*N*-benzyloxycarbonyl)aminopentanol (3-40)

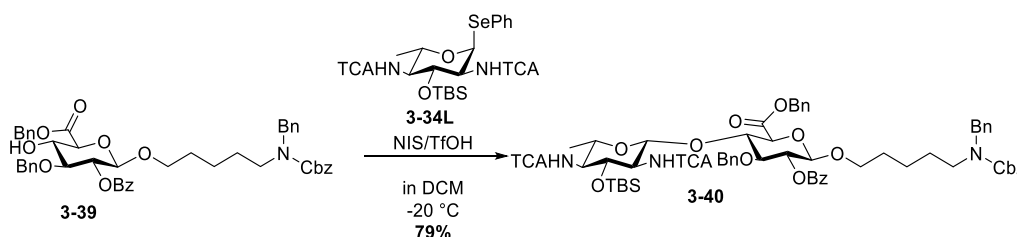

Acceptor **3-34L** (28 mg, 36 μ mol, 1.1 eq.) and donor **3-39** (26 mg, 33 μ mol, 1.0 eq.) were coevaporated with toluene for three times and put under high vacuum overnight to remove trace water in them. The starting materials were dissolved in anhydrous DCM (1.0 mL), 4 Å molecular sieves were added and the suspension was stirred at -20 °C for 5 min. NIS (11 mg, 49 μ mol, 1.5 eq.) and TfOH (0.5 μ L, 5 μ mol, 0.15 eq.) were added and the resultant mixture was stirred at that temperature until TLC showed a full conversion of the donor. The reaction was quenched with Na₂S₂O₃(aq.), extracted with EtOAc, washed with Na₂S₂O₃(aq.) and brine, dried with Na₂SO₄(s), concentrated and purified with FC to get **3-40** (β only, 35 mg, 26 μ mmol, yield: 79%).

¹H NMR (600 MHz, Chloroform-*d*) δ 7.98 – 7.92 (m, 2H), 7.52 – 7.47 (m, 1H), 7.47 – 7.43 (m, 2H), 7.41 (t, *J* = 7.6 Hz, 2H), 7.39 – 7.27 (m, 8H), 7.25 – 7.21 (m, 4H), 7.20 – 7.16 (m, 2H), 7.11 (d, *J* = 7.3 Hz, 1H), 6.58 (d, *J* = 8.2 Hz, 1H), 6.47 (d, *J* = 9.3 Hz, 1H), 5.44 – 5.25 (m, 5H), 5.19 – 5.10 (m, 3H), 5.00 (d, *J* = 8.4 Hz, 1H), 4.66 (s, 2H), 4.54 (dd, *J* = 23.7, 6.9 Hz, 1H), 4.41 – 4.30 (m, 3H), 4.05 (d, *J* = 9.5 Hz, 1H), 4.02 (t, *J* = 9.3 Hz, 1H), 3.84 (t, *J* = 8.5 Hz, 1H), 3.78 (s, 1H), 3.62 (d, *J* = 31.4 Hz, 1H), 3.34 (q, *J* = 9.5 Hz, 2H), 3.21 (dd, *J* = 10.3, 6.3 Hz, 2H), 3.00 (d, *J* = 61.8 Hz, 2H), 2.21 (t, *J* = 7.6 Hz, 2H), 2.01 (q, *J* = 6.5 Hz, 2H), 1.66 – 1.58 (m, 4H), 1.13 (d, *J* = 6.1 Hz, 4H), 0.88 (t, *J* = 7.0 Hz, 5H), 0.84 (s, 9H). ¹³C NMR (151 MHz, Chloroform-*d*) δ 168.0, 165.1, 161.8, 161.7, 138.2, 135.6, 133.5, 130.2, 129.9, 129.8, 129.7, 128.8, 128.6, 128.6, 128.6, 128.5, 128.5, 128.0, 128.0, 127.9, 127.9, 100.9, 97.6, 92.6, 92.5, 82.5, 77.4, 77.2, 76.9, 74.7, 74.3, 73.6, 73.5, 71.0, 70.2, 67.2, 67.1, 60.9, 36.1, 32.1, 32.0, 29.9, 29.8, 29.8, 29.7, 29.7, 29.5, 29.5, 29.4, 29.4, 29.4, 29.3, 29.1, 27.4, 27.3, 25.9, 25.7, 25.7, 23.1, 22.8,

18.1, 17.9, 14.3, 14.3, 1.2, -3.7, -3.9. HRMS (Q-ToF): calculated for $C_{63}H_{73}Cl_6N_3O_{14}SiNa^+$ $[M+Na]^+$ 1356.2885, found 1356.2924 m/z.

2,4-Di-trichloroacetamido-2,4,6-tri-deoxy- β -L-glucopyranosyl-(1 \rightarrow 4)-(benzyl 2-O-benzoyl-3-O-benzyl- β -D-glucopyranosyluronoyl)-(1 \rightarrow 1)-5-(N-benzyl-N-benzyloxycarbonyl)aminopentanol (3-41)

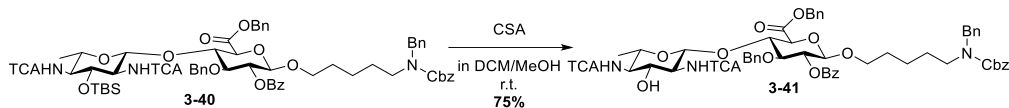

Disaccharide **3-40** (32 mg, 24 μ mol, 1.0 eq.) was dissolved in a mixed solvent of DCM (0.4 mL) and MeOH (0.4 mL). CSA (56 mg, 240 μ mol, 10 eq.) was added to the solution and the mixture was stirred at r.t. for 48h. TLC showed a full conversion of the starting material. The reaction was quenched with TEA and concentrated *in vacuo*. The crude product was extracted with EtOAc, washed with water and brine, dried with $Na_2SO_4(s)$, concentrated again and purified with FC to get **3-41** (22 mg, 18 μ mol, yield: 75%). 1H NMR (600 MHz, Chloroform-*d*) δ 7.92 (t, $J = 6.3$ Hz, 2H), 7.50 (t, $J = 7.4$ Hz, 1H), 7.46 – 7.27 (m, 14H), 7.25 – 7.23 (m, 1H), 7.21 – 7.07 (m, 7H), 6.91 (d, $J = 7.0$ Hz, 1H), 6.60 (d, $J = 8.5$ Hz, 1H), 5.41 (d, $J = 30.1$ Hz, 1H), 5.36 – 5.30 (m, 2H), 5.28 (d, $J = 12.9$ Hz, 1H), 5.21 – 5.07 (m, 4H), 4.86 (d, $J = 8.3$ Hz, 1H), 4.69 (d, $J = 11.4$ Hz, 1H), 4.62 (d, $J = 11.5$ Hz, 1H), 4.57 – 4.48 (m, 1H), 4.42 – 4.35 (m, 2H), 4.32 (t, $J = 9.3$ Hz, 1H), 4.12 – 3.96 (m, 3H), 3.87 (t, $J = 8.9$ Hz, 1H), 3.82 – 3.76 (m, 2H), 3.62 (d, $J = 32.2$ Hz, 4H), 3.43 (ddd, $J = 26.5, 14.1, 7.4$ Hz, 3H), 3.37 – 3.26 (m, 1H), 3.10 – 2.92 (m, 3H), 2.32 (dq, $J = 13.8, 7.2$ Hz, 1H), 2.21 (t, $J = 7.7$ Hz, 1H). ^{13}C NMR (151 MHz, Chloroform-*d*) δ 168.0, 165.1, 163.2, 162.7, 137.5, 135.5, 133.5, 130.2, 129.9, 129.8, 129.6, 128.9, 128.7, 128.6, 128.6, 128.6, 128.4, 128.1, 127.9, 127.8, 124.4, 99.1, 81.8, 77.4, 77.2, 76.9, 75.5, 74.5, 73.3, 73.0, 71.6, 70.4, 67.2, 60.1, 60.1, 39.9, 36.1, 32.1, 32.1, 29.9, 29.9, 29.8, 29.8, 29.7, 29.5, 29.5, 29.4, 29.4, 29.3, 29.0, 28.8, 28.4, 27.4, 27.3, 26.9, 26.8, 25.7, 22.8, 19.3, 17.9, 14.3, 13.9. HRMS (Q-ToF): calculated for $C_{57}H_{59}Cl_6N_3O_{14}Na^+$ $[M+Na]^+$ 1242.2020, found 1242.2019 m/z.

Phenyl 2-amino-3-*O*-*tert*-butyldimethylsilyl-2,6-di-deoxy-1-seleno- α -L-galactopyranoside (3-44L)

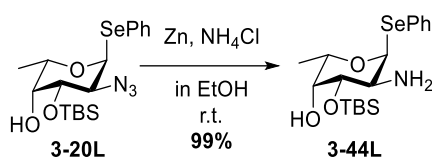

Selenoglycoside **3-20L** (1.99 g, 4.5 mmol, 1.0 eq.) was dissolved in EtOH (25 mL). NH₄Cl (477 mg, 9.0 mmol, 2.0 eq.) and activated zinc power (439 mg, 6.8 mmol, 1.5 eq.) were added into the solution. The mixture was stirred at r.t. until TLC showed a full conversion of the starting material. The mixture was filtrated, and EtOH was removed *in vacuo*. Further purification gave the product **3-44L** (1.86 g, 4.5 mmol, yield 99%). ¹H NMR (400 MHz, Chloroform-*d*) δ 7.64 – 7.56 (m, 2H), 7.29 – 7.23 (m, 4H), 5.88 (d, *J* = 4.7 Hz, 1H), 4.33 (qd, *J* = 6.6, 1.5 Hz, 1H), 3.64 (dd, *J* = 3.3, 1.4 Hz, 1H), 3.54 (dd, *J* = 9.8, 3.3 Hz, 1H), 3.32 (dd, *J* = 9.8, 4.7 Hz, 1H), 2.40 (s, 1H), 1.47 (d, *J* = 6.6 Hz, 2H), 1.32 (d, *J* = 6.5 Hz, 3H), 0.94 (s, 9H), 0.17 (d, *J* = 8.9 Hz, 6H). ¹³C NMR (101 MHz, Chloroform-*d*) δ 134.0, 129.8, 129.2, 127.5, 91.2, 90.8, 77.5, 77.4, 77.2, 76.8, 75.5, 71.8, 69.1, 52.4, 25.9, 18.2, 16.4, -4.2, -4.3. HRMS (Q-ToF): calculated for C₁₈H₃₂NO₃SeSi⁺ [M+H]⁺ 418.1311, found 418.1319 m/z.

Phenyl 2-trichloroacetamido-3-*O*-*tert*-butyldimethylsilyl-2,6-di-deoxy-1-seleno- α -L-galactopyranoside (3-45L)

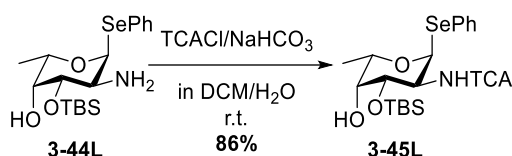

Selenoglycoside **3-44L** (1408 mg, 3.38 mmol, 1.0 eq.) was dissolved in a mixed solvent of water (6 mL) and DCM (24 mL). NaHCO₃ (426 mg, 5.08 mmol, 1.5 eq.) and TCACl (570 μ L, 5.08 mmol, 1.5 eq.) were added and stirred at r.t. for 30 min. After TCL showed a full conversion of the starting material, the mixture was extracted with EtOAc, washed with HCl (1 M aq.), NaHCO₃ (sat. aq.) and brine, dried with Na₂SO₄(s) and concentrated *in vacuo*, the crude product was further purified with FC to get **3-45L** (1663 mg, 2.96 mmol, yield: 86%). ¹H NMR (400 MHz, Chloroform-*d*) δ 7.60 – 7.52 (m, 2H), 7.33 – 7.27 (m, 3H), 6.98 (d, *J* = 8.9 Hz, 1H), 5.79 (d, *J* = 4.7 Hz, 1H), 4.59 –

4.47 (m, 1H), 4.35 – 4.20 (m, 1H), 3.72 (d, $J = 9.0$ Hz, 2H), 2.51 (t, $J = 1.2$ Hz, 1H), 1.41 (d, $J = 6.5$ Hz, 3H), 0.91 (s, 9H), 0.16 (d, $J = 0.8$ Hz, 6H). ^{13}C NMR (101 MHz, Chloroform- d) δ 161.5, 134.1, 134.1, 129.5, 128.9, 128.2, 92.4, 90.1, 77.4, 77.3, 77.1, 76.7, 71.8, 71.6, 70.0, 52.4, 25.7, 17.9, 16.3, -4.3, -4.7. HRMS (Q-ToF): calculated for $\text{C}_{20}\text{H}_{30}\text{Cl}_3\text{NO}_4\text{SeSiNa}^+ [\text{M}+\text{Na}]^+$ 574.0067, found 574.0079 m/z.

Phenyl 2-trichloroacetamido-3-*O*-*tert*-butyldimethylsilyl-4-azido-2,4,6-tri-deoxy-1-seleno- α -L-glucopyranoside (3-46L)

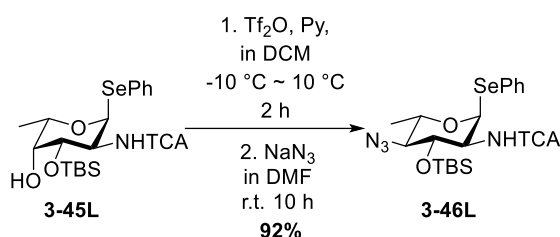

Selenoglycoside **3-45L** (496 mg, 883 μmol , 1.0 eq.) was dissolved in DCM (5 mL). Pyridine (0.43 mL, 5.3 mmol, 6.0 eq.) and Tf_2O (0.18 mL, 1.06 mmol, 1.2 eq.) were added sequentially at -10 $^\circ\text{C}$ (salt-ice-water bath) and the temperature was slowly raised to r.t.. After TLC showed full conversion of **3-45L**, the mixture was evaporated *in vacuo* and then dissolved in anhydrous DMF. NaN_3 (574 mg, 8.83 mmol, 10.0 eq.) was added and the mixture was stirred overnight. The crude product was extracted with EtOAc, washed with H_2O and brine, dried with $\text{Na}_2\text{SO}_4(\text{s})$, evaporated *in vacuo* and purified by FC to obtain **3-46L** (478 mg, 814 μmol , yield: 92%). ^1H NMR (600 MHz, Chloroform- d) δ 7.94 (d, $J = 7.7$ Hz, 2H), 7.51 (t, $J = 7.4$ Hz, 1H), 7.46 – 7.39 (m, 4H), 7.39 – 7.27 (m, 9H), 7.25 – 7.08 (m, 8H), 6.76 (d, $J = 5.8$ Hz, 1H), 5.36 – 5.31 (m, 1H), 5.29 (d, $J = 12.5$ Hz, 1H), 5.17 (d, $J = 12.6$ Hz, 1H), 5.13 (d, $J = 8.8$ Hz, 2H), 4.68 – 4.61 (m, 3H), 4.53 (dd, $J = 27.2, 7.2$ Hz, 1H), 4.37 (d, $J = 22.7$ Hz, 2H), 4.28 (t, $J = 9.2$ Hz, 1H), 4.07 (d, $J = 9.5$ Hz, 1H), 3.89 (t, $J = 9.0$ Hz, 1H), 3.84 – 3.74 (m, 1H), 3.52 – 3.41 (m, 2H), 3.33 (d, $J = 37.5$ Hz, 1H), 3.13 (d, $J = 19.8$ Hz, 1H), 3.09 – 2.89 (m, 3H), 2.77 (t, $J = 9.1$ Hz, 1H). ^{13}C NMR (151 MHz, Chloroform- d) δ 167.9, 165.1, 163.5, 137.4, 135.5, 133.5, 129.8, 129.6, 128.9, 128.8, 128.7, 128.6, 128.6, 128.6, 128.3, 128.2, 128.0, 127.6, 101.1, 99.3, 81.9, 77.4, 77.2, 76.9, 75.3, 74.4, 72.8, 70.9, 70.0, 68.5, 67.2, 67.1, 59.2, 29.8, 29.0, 23.1, 18.6, 18.3. HRMS (Q-ToF): calculated for $\text{C}_{20}\text{H}_{33}\text{Cl}_3\text{N}_5\text{O}_3\text{SeSi}^+ [\text{M}+\text{NH}_4]^+$ 604.0578, found 604.0499 m/z.

4-Methoxyphenyl 2-trichloroacetamido-3-*O*-*tert*-butyldimethylsilyl-4-azido-2,4,6-tri-deoxy- β -L-glucopyranosyl-(1 \rightarrow 4)-(benzyl 2-*O*-benzoyl-3-*O*-benzyl- β -D-glucopyranosyluronate) (3-47)

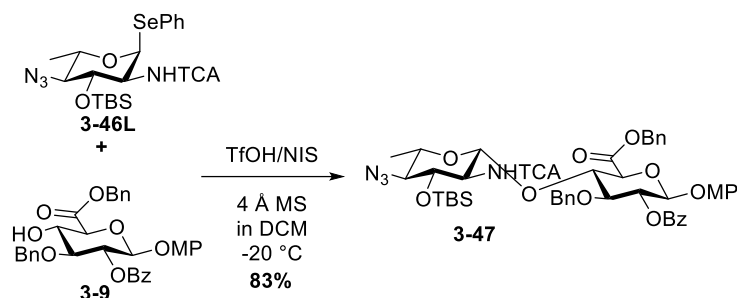

Donor **3-46L** (128 mg, 218 μ mol, 1.1 eq.) and acceptor **3-9** (116 mg, 198 μ mol, 1.0 eq.) were coevaporated with toluene for three times and put under high vacuum overnight to remove trace water in them. The starting materials were dissolved in anhydrous DCM (2 mL), 4 Å molecular sieves were added and the suspension was stirred at -20 °C for 5 min. NIS (67 mg, 297 μ mol, 1.5 eq.) and TfOH (3.5 μ L, 40 μ mol, 0.2 eq.) were added and the resultant mixture was stirred at that temperature until TLC showed a full conversion of the donor. The reaction was quenched with Na₂S₂O₃(aq.), extracted with EtOAc, washed with Na₂S₂O₃(aq.) and brine, dried with Na₂SO₄(s), concentrated and purified with FC to get **3-47** (183 mg, 180 μ mmol, yield: 83%). ¹H NMR (600 MHz, Chloroform-*d*) δ 8.05 – 7.98 (m, 2H), 7.62 – 7.55 (m, 1H), 7.47 – 7.37 (m, 6H), 7.35 – 7.30 (m, 1H), 7.24 – 7.18 (m, 5H), 6.91 – 6.85 (m, 2H), 6.76 – 6.68 (m, 2H), 6.31 (d, *J* = 8.9 Hz, 1H), 5.55 (dd, *J* = 8.4, 7.0 Hz, 1H), 5.35 (d, *J* = 12.6 Hz, 1H), 5.08 (d, *J* = 12.6 Hz, 1H), 5.06 (d, *J* = 7.0 Hz, 1H), 4.74 (d, *J* = 8.4 Hz, 1H), 4.73 – 4.66 (m, 2H), 4.41 (t, *J* = 8.8 Hz, 1H), 4.20 (d, *J* = 9.2 Hz, 1H), 3.91 (t, *J* = 8.4 Hz, 1H), 3.73 (s, 3H), 3.46 (q, *J* = 9.0 Hz, 1H), 3.34 (t, *J* = 9.3 Hz, 1H), 3.07 (dq, *J* = 9.9, 6.1 Hz, 1H), 2.51 (t, *J* = 9.3 Hz, 1H), 1.23 (d, *J* = 6.1 Hz, 3H), 0.88 (s, 9H), 0.13 (s, 3H), -0.01 (s, 3H), -0.03 (s, 3H). ¹³C NMR (151 MHz, Chloroform-*d*) δ 207.1, 167.7, 165.2, 161.7, 155.8, 151.2, 138.0, 135.7, 133.6, 129.9, 129.6, 128.8, 128.7, 128.6, 128.5, 128.1, 128.0, 127.5, 119.2, 114.6, 100.7, 98.8, 92.6, 82.2, 77.4, 77.2, 76.9, 74.6, 74.4, 73.5, 73.1, 72.7, 70.9, 70.5, 66.9, 59.2, 58.6, 55.7, 53.6, 31.1, 25.9, 18.6, 18.4, 18.1, 1.2, -4.2, -4.4. HRMS (Q-ToF): calculated for C₄₈H₅₅Cl₃N₄O₁₂SiNa⁺ [M+Na]⁺ 1035.2544, found 1035.2567 m/z.

2-Trichloroacetamido-3-*O*-*tert*-butyldimethylsilyl-4-azido-2,4,6-tri-deoxy- β -L-glucofuranosyl-(1 \rightarrow 4)-(benzyl 2-*O*-benzoyl-3-*O*-benzyl- α/β -D-glucofuranosyluronoyl) *N*-phenyltrifluoroacetimidate (3-49)

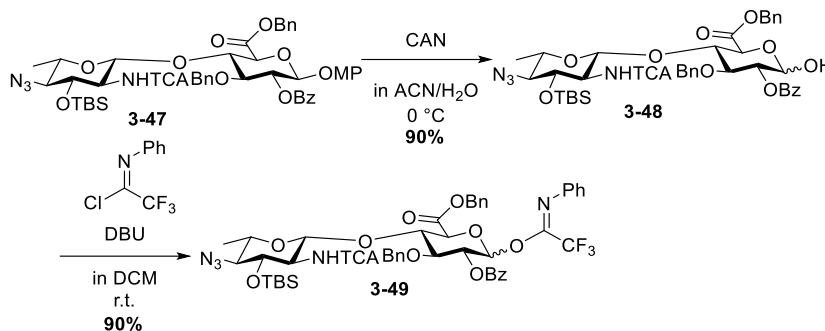

Disaccharide **3-47** (47 mg, 46 μ mol, 1.0 eq.) was dissolved in a mixed solvent of MeCN (1 mL) and H₂O (0.5 mL). CAN (76 mg, 139 μ mol, 3.0 eq.) was added and the mixture was stirred at r.t.. Color of the mixture turned orange. The reaction was monitored by TLC and as soon as the starting material was fully hydrolyzed, the reaction was quenched with TEA. The product was extracted with EtOAc, washed with water and brine, dried with Na₂SO₄(s), concentrated and purified with FC to get **3-48** (38 mg, 42 μ mol, yield: 90%). Disaccharide **3-48** (37 mg, 41 μ mol, 1.0 eq.) and trifluoro-*N*-phenylacetimidoyl chloride (40 μ L, 244 μ mol, 6.0 eq.) were dissolved in DCM (1 mL), the solvent was cooled to 0 °C (ice-water bath) and DBU (18 μ L, 122 μ mol, 3.0 eq.) was added. The mixture was stirred at r.t. until TLC showed a full conversion of the starting material. After evaporation, the crude product was further purified by FC to get yellowish syrup **3-49** (38 mg, 35 μ mol, yield: 90%). ¹H NMR (400 MHz, Chloroform-*d*) δ 8.06 – 7.97 (m, 2H), 7.64 – 7.57 (m, 1H), 7.13 – 7.04 (m, 1H), 6.72 (d, *J* = 7.8 Hz, 2H), 6.28 (d, *J* = 8.5 Hz, 1H), 5.52 (t, *J* = 6.1 Hz, 1H), 5.37 (d, *J* = 12.7 Hz, 1H), 5.12 (d, *J* = 12.7 Hz, 1H), 4.80 (d, *J* = 8.3 Hz, 1H), 4.69 (q, *J* = 11.7 Hz, 2H), 4.44 (d, *J* = 7.4 Hz, 1H), 4.12 (q, *J* = 7.1 Hz, 3H), 3.88 (s, 1H), 3.46 (t, *J* = 9.3 Hz, 1H), 3.36 (h, *J* = 8.5 Hz, 1H), 3.11 (dq, *J* = 12.1, 6.1 Hz, 1H), 2.48 (dd, *J* = 10.0, 8.6 Hz, 1H), 2.05 (s, 4H), 1.30 – 1.19 (m, 9H), 0.87 (s, 9H), 0.13 (s, 3H), 0.07 (s, 2H), -0.03 (s, 3H). HRMS (Q-ToF): calculated for C₄₉H₅₃Cl₃F₃N₅O₁₁SiNa⁺ [M+Na]⁺ 1100.2421, found 1100.2422 m/z.

2-Trichloroacetamido-3-*O*-*tert*-butyldimethylsilyl-4-azido-2,4,6-tri-deoxy- β -L-glucopyranosyl-(1 \rightarrow 4)-(benzyl 2-*O*-benzoyl-3-*O*-benzyl- β -D-glucopyranosyluronoyl)-(1 \rightarrow 1)-5-(*N*-benzyl-*N*-benzyloxycarbonyl)aminopentanol (3-50)

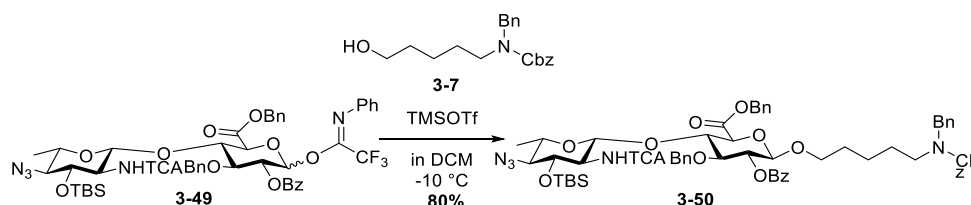

The donor **3-46** (20 mg, 18.5 μ mol, 1.0 eq.) and the acceptor **3-7** (12 mg, 37.0 μ mol, 2.0 eq.) were coevaporated three times with anhydrous toluene and put under high vacuum overnight to remove trace water inside. The mixture was dissolved in DCM (1 mL) and 4 Å MS was added. After being stirred for 15 min, the mixture was cooled to -10 °C and TMSOTf (1.2 μ L, 7.4 μ mol, 0.4 eq.) was added and the resultant mixture continued to be stirred until TLC showed a full conversion of the starting material. The reaction was quenched with Na₂S₂O₃(aq.), extracted with EtOAc, washed with Na₂S₂O₃(aq.) and brine, dried with Na₂SO₄(s), and further purified with FC to get **3-50** (18 mg, 14.8 μ mol, yield: 80%). ¹H NMR (600 MHz, Chloroform-*d*) δ 7.99 – 7.90 (m, 2H), 7.50 (t, *J* = 7.4 Hz, 1H), 7.46 (d, *J* = 7.5 Hz, 2H), 7.41 (t, *J* = 7.5 Hz, 2H), 7.39 – 7.27 (m, 9H), 7.25 – 7.16 (m, 8H), 7.11 (d, *J* = 7.2 Hz, 1H), 6.29 (d, *J* = 9.1 Hz, 1H), 5.38 (d, *J* = 12.8 Hz, 1H), 5.30 (d, *J* = 1.0 Hz, 7H), 5.17 – 5.08 (m, 4H), 4.69 – 4.61 (m, 3H), 4.52 (d, *J* = 20.3 Hz, 1H), 4.43 – 4.31 (m, 2H), 4.26 (t, *J* = 9.0 Hz, 1H), 4.06 (d, *J* = 9.6 Hz, 1H), 3.84 (d, *J* = 8.7 Hz, 1H), 3.72 (q, *J* = 7.0 Hz, 12H), 3.48 (q, *J* = 9.2, 8.0 Hz, 1H), 3.40 – 3.24 (m, 2H), 3.08 – 2.92 (m, 3H), 2.46 (t, *J* = 9.4 Hz, 1H), 0.12 (s, 3H), 0.07 (d, *J* = 1.1 Hz, 9H). MS (MALDI-ToF) calculated for C₆₁H₇₂Cl₃N₅O₁₃SiNa⁺ [M+Na]⁺ 1240.382 (most abundant), found 1240.490 m/z.

2-Trichloroacetamido-4-azido-2,4,6-tri-deoxy- β -L-glucopyranosyl-(1 \rightarrow 4)-(benzyl *O*-benzoyl-3-*O*-benzyl- β -D-glucopyranosyluronoyl)-(1 \rightarrow 1)-5-(*N*-benzyl-*N*-benzyloxycarbonyl)aminopentanol (3-51)

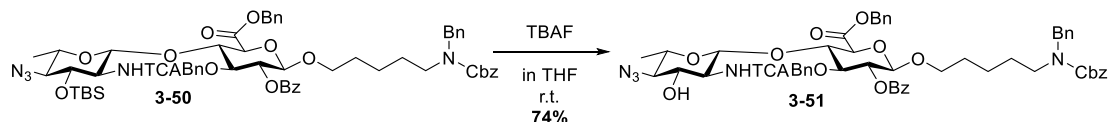

Disaccharide **3-50** (15 mg, 12 μ mol, 1.0 eq.) was dissolved in THF (1.0 mL). TBAF (1 M in THF, 14 μ L, 14 μ mol, 1.2 eq.) was added dropwise and the solution was stirred at r.t. until TLC showed a full conversion of the starting material. The product was extracted with EtOAc, washed with H₂O and brine, dried with Na₂SO₄(s), concentrated and purified with FC to obtain **3-51** (10 mg, 9 μ mol, yield: 74%). ¹H NMR (600 MHz, Chloroform-*d*) δ 7.94 (d, *J* = 7.7 Hz, 2H), 7.51 (t, *J* = 7.4 Hz, 1H), 7.46 – 7.39 (m, 4H), 7.39 – 7.27 (m, 9H), 7.25 – 7.08 (m, 8H), 6.76 (d, *J* = 5.8 Hz, 1H), 5.36 – 5.31 (m, 1H), 5.29 (d, *J* = 12.5 Hz, 1H), 5.17 (d, *J* = 12.6 Hz, 1H), 5.13 (d, *J* = 8.8 Hz, 2H), 4.68 – 4.61 (m, 3H), 4.53 (dd, *J* = 27.2, 7.2 Hz, 1H), 4.37 (d, *J* = 22.7 Hz, 2H), 4.28 (t, *J* = 9.2 Hz, 1H), 4.07 (d, *J* = 9.5 Hz, 1H), 3.89 (t, *J* = 9.0 Hz, 1H), 3.84 – 3.74 (m, 1H), 3.52 – 3.41 (m, 2H), 3.33 (d, *J* = 37.5 Hz, 1H), 3.13 (d, *J* = 19.8 Hz, 1H), 3.09 – 2.89 (m, 3H), 2.77 (t, *J* = 9.1 Hz, 1H). ¹³C NMR (151 MHz, Chloroform-*d*) δ 167.9, 165.1, 163.5, 137.4, 135.5, 133.5, 129.8, 129.6, 128.9, 128.8, 128.7, 128.6, 128.6, 128.6, 128.3, 128.2, 128.0, 127.6, 101.1, 99.3, 81.9, 77.4, 77.2, 76.9, 75.3, 74.4, 72.8, 70.9, 70.0, 68.5, 67.2, 67.1, 59.2, 29.8, 29.0, 23.1, 18.6, 18.3. HRMS (Q-ToF) calculated for C₅₅H₅₈Cl₃N₅O₁₃Na⁺ [M+Na]⁺ 1124.2989, found 1124.2683 m/z.

2-Trichloroacetamido-3-*O*-*tert*-butyldimethylsilyl-4-azido-2,4,6-tri-deoxy- β -L-glucopyranosyl-(1 \rightarrow 4)-(benzyl 2-*O*-benzoyl-3-*O*-benzyl- β -D-glucopyranosyluronoyl)-(1 \rightarrow 3)-2-trichloroacetamido-4-azido-2,4,6-tri-deoxy- β -L-glucopyranosyl-(1 \rightarrow 4)-(benzyl 2-*O*-benzoyl-3-*O*-benzyl- β -D-glucopyranosyluronoyl)-(1 \rightarrow 1)-5-(*N*-benzyl-*N*-benzyloxycarbonyl)aminopentanol (3-52)

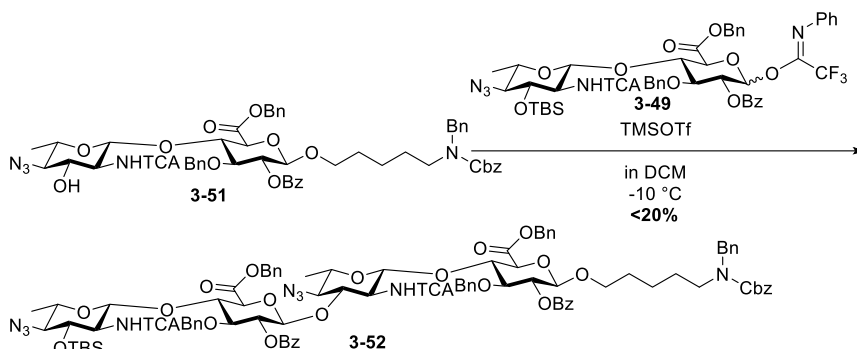

The donor **3-51** (10 mg, 9 μ mol, 1.5 eq.) and the acceptor **3-49** (7 mg, 6 μ mol, 1.0 eq.) were coevaporated three times with anhydrous toluene and put under high vacuum overnight to remove trace water inside. The mixture was dissolved in DCM (1 mL) and 4 Å MS was added. After being stirred for 15 min, the mixture was cooled to -10 °C and TMSOTf (0.5 μ L, 3 μ mol, 0.5 eq.) was added and the resultant mixture continued to be stirred until TLC showed a full conversion of the starting material. The reaction was quenched with Na₂S₂O₃(aq.), extracted with EtOAc, washed with Na₂S₂O₃(aq.) and brine, dried with Na₂SO₄(s), and further purified with FC to get 10 mg **3-52**. But the spectra were not clean. Further purification by prep TLC gave much cleaner **3-52** (2.5 mg, 1.25 μ mol, yield: 20%). ¹H NMR (600 MHz, Chloroform-*d*) δ 8.11 – 8.04 (m, 2H), 7.93 – 7.85 (m, 2H), 7.60 (td, *J* = 7.4, 1.4 Hz, 1H), 7.51 – 7.28 (m, 20H), 7.24 – 7.04 (m, 16H), 6.98 (d, *J* = 6.2 Hz, 1H), 6.91 – 6.83 (m, 1H), 6.25 (d, *J* = 9.2 Hz, 1H), 5.40 – 5.31 (m, 3H), 5.30 (d, *J* = 1.4 Hz, 1H), 5.26 (td, *J* = 8.1, 7.4, 1.3 Hz, 1H), 5.21 (t, *J* = 8.3 Hz, 1H), 5.15 – 5.09 (m, 3H), 5.05 (t, *J* = 12.4 Hz, 2H), 4.89 (dd, *J* = 7.4, 1.2 Hz, 1H), 4.67 (d, *J* = 11.3 Hz, 1H), 4.66 – 4.58 (m, 4H), 4.53 (d, *J* = 11.4 Hz, 1H), 4.51 – 4.44 (m, 1H), 4.37 (d, *J* = 9.0 Hz, 2H), 4.25 (ddd, *J* = 6.9, 3.9, 1.5 Hz, 4H), 4.20 – 4.13 (m, 2H), 4.08 (d, *J* = 9.6 Hz, 2H), 3.82 (td, *J* = 8.5, 1.2 Hz, 1H), 3.78 (t, *J* = 8.9 Hz, 2H), 3.71 – 3.68 (m, 4H), 3.64 (d, *J* = 1.2 Hz, 4H), 3.49 (t, *J* = 6.9 Hz, 2H), 3.40 (q, *J* = 9.2 Hz, 1H), 3.36 – 3.26 (m, 1H), 3.23 (q, *J* = 9.8, 8.2 Hz, 1H), 3.08 – 2.88 (m, 4H), 0.12 (d, *J* = 1.2 Hz, 3H), 0.07 (d, *J* = 1.3 Hz, 9H). ¹³C NMR (151 MHz,

Chloroform-*d*) δ 176.5, 168.0, 167.5, 164.9, 162.6, 161.7, 137.8, 135.9, 135.4, 133.7, 133.3, 130.1, 129.9, 129.8, 129.3, 129.0, 128.8, 128.8, 128.7, 128.6, 128.5, 128.4, 128.3, 128.3, 128.3, 128.1, 128.0, 128.0, 127.8, 127.5, 100.9, 100.0, 98.7, 82.7, 82.4, 77.4, 77.2, 76.9, 75.4, 74.9, 74.4, 74.2, 74.1, 73.9, 73.4, 73.2, 72.7, 70.9, 70.7, 70.2, 69.5, 68.0, 67.2, 66.9, 66.4, 63.2, 58.9, 56.4, 47.3, 32.1, 32.1, 31.9, 29.9, 29.8, 29.8, 29.7, 29.7, 29.5, 29.5, 29.4, 29.3, 29.0, 27.4, 25.9, 25.9, 25.6, 22.8, 22.8, 18.3, 18.1, 17.9, 14.3, 14.1, 11.9, 1.2, -4.3, -4.5. HRMS (Q-ToF) calculated for $C_9H_{10}Cl_6N_9O_{23}SiNa^+$ $[M+Na]^+$ 2012.5116, found 2012.5253 m/z .

Phenyl 2-azido-6-iodo-2,6-di-deoxy-1-seleno- α -D-galactopyranoside (**3-55**)

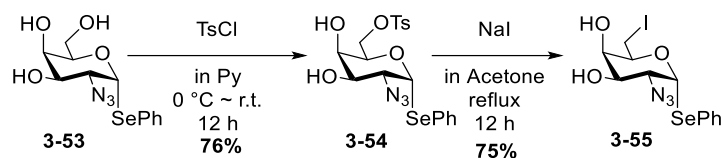

Selenoglycoside **3-53** (426 mg, 1235 μmol , 1.0 eq.) was dissolved in anhydrous pyridine (12 mL). TsCl (307 mg, 1605 μmol , 1.3 eq.) was added and the solution was stirred at r.t. overnight until TLC showed a full conversion of the starting material. Most of the solvent was removed by evaporation and the crude product was purified by FC to get **3-54** (466 mg, 934 μmol , yield: 76%). **3-54** was used in the next step without further characterization. **3-54** (460 mg, 922 μmol , 1.0 eq.) was dissolved in anhydrous acetone (30 mL). NaI (691 mg, 4609 μmol , 5.0 eq.) was added and the solution was stirred and fluxed overnight. The solvent was removed by evaporation and further purification by FC gave **3-55** (315 mg, 692 μmol , yield: 75%). ^1H NMR (400 MHz, Chloroform-*d*) δ 7.69 – 7.58 (m, 2H), 7.31 (dd, $J = 5.2, 2.0$ Hz, 3H), 5.93 (d, $J = 5.3$ Hz, 1H), 4.40 (t, $J = 7.2$ Hz, 1H), 4.28 (td, $J = 3.4, 1.5$ Hz, 1H), 4.09 (dd, $J = 10.3, 5.3$ Hz, 1H), 3.78 (ddd, $J = 10.3, 5.4, 3.2$ Hz, 1H), 3.38 (dd, $J = 10.1, 7.8$ Hz, 1H), 3.19 (dd, $J = 10.1, 6.5$ Hz, 1H), 2.60 (d, $J = 5.5$ Hz, 1H), 2.41 (d, $J = 3.4$ Hz, 1H). ^{13}C NMR (101 MHz, Chloroform-*d*) δ 134.6, 129.4, 128.3, 128.2, 85.2, 77.5, 77.4, 77.2, 76.8, 73.2, 71.2, 68.8, 61.6, 1.2. LCMS (ESI) calculated for $C_{12}H_{14}IN_3O_3\text{SeNa}^+$ $[M+NH_4]^+$ 477.9, found 477.5 m/z . Data compatible as reported.¹¹¹

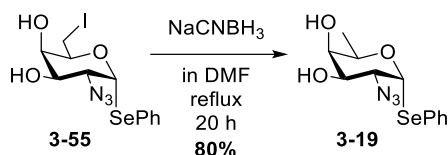
Phenyl 2-azido-2,6-di-deoxy-1-seleno- α -D-galactopyranoside (3-19)

Selenoglycoside **3-55** (112 mg, 246 μmol , 1.0 eq.) was dissolved in anhydrous DMF (5 mL) and NaCNBH₃ (77 mg, 1231 μmol , 5.0 eq.) was added to the solution. The mixture was stirred and refluxed for 20 h and TLC showed a full conversion of the starting material. The product was extracted with EtOAc and washed with water and brine. After each wash, the product was extracted several times until TLC showed its disappearance from the aq. phase. Organic layers were combined, dried with Na₂SO₄(s), filtrated, concentrated and further purified with FC to get **3-19** (64 mg, 195 μmol , yield: 80%). ¹H NMR (400 MHz, Chloroform-*d*) δ 7.66 – 7.54 (m, 2H), 7.30 (hd, *J* = 4.8, 1.7 Hz, 3H), 5.91 (d, *J* = 5.3 Hz, 1H), 4.39 (qd, *J* = 6.6, 1.4 Hz, 1H), 4.05 (dd, *J* = 10.1, 5.3 Hz, 1H), 3.84 (d, *J* = 3.3 Hz, 1H), 3.80 (dd, *J* = 10.2, 3.3 Hz, 1H), 2.68 (s, 1H), 2.34 (s, 1H), 1.27 (d, *J* = 6.6 Hz, 3H). ¹³C NMR (101 MHz, Chloroform-*d*) δ 134.6, 129.3, 128.0, 85.1, 77.5, 77.4, 77.2, 76.8, 71.6, 71.4, 68.8, 62.0, 16.1. LCMS (ESI) calculated for C₁₂H₁₅N₃O₃SeNa⁺ [M+NH₄]⁺ 352.0, found 352.0 m/z. $[\alpha]_{\text{D}}^{25} = 274.43^\circ$. Data compatible as reported.¹¹¹

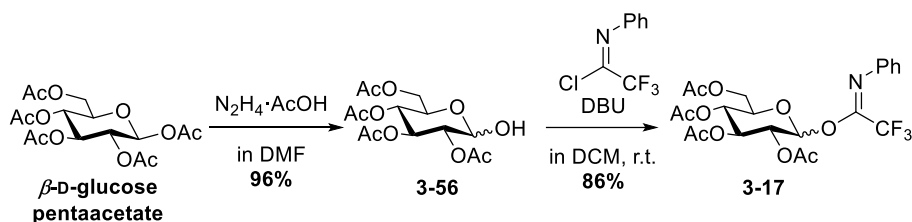
2,3,4,6-Tetra-*O*-acetyl- α/β -D-glucopyranosyl 1-(*N*-phenyl)-2,2,2-trifluoroacetimidate (3-17)

Imidate **3-17** was prepared according to known procedure, starting from β -D-glucose pentaacetate. The anomeric acetate of the starting material was selectively hydrolysed with N₂H₄·AcOH and following coupling with trifluoro-*N*-phenylacetimidoyl chloride gave desired compound **3-17**.¹¹²

4-Methoxyphenyl 6-*O*-triisopropylsilyl- β -D-galactopyranoside (**3-59**)

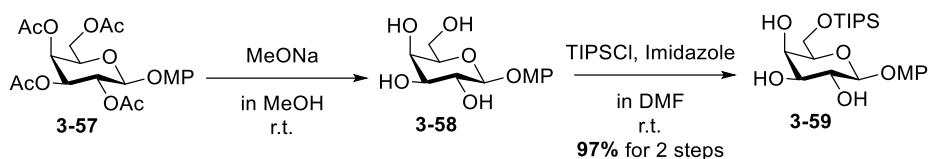

Monosaccharide **3-57** was prepared according to known procedure.¹¹² Starting material **3-57** (3.69 g, 8.13 mmol, 1.0 eq.) was dissolved in MeOH (80 mL) and MeONa (44 mg, 0.8 mmol, 0.1 eq.) was added to the solution. The mixture was stirred at r.t. until LC-MS showed a full conversion of the starting material to get **3-58**. Amberlite(H⁺) was added to the mixture to adjust the pH to 7. After filtration, **3-58** was concentrated *in vacuo* and put under high vacuum overnight. Crude **3-58** (1.52 g, 5.3 mmol, 1.0 eq.) from the previous step was dissolved in anhydrous DMF (25 mL). Imidazole (722 mg, 10.6 mmol, 2.0 eq.) and TIPSCl (1.7 mL, 8.0 mmol, 1.5 eq.) was added and the mixture was stirred until TLC showed a full conversion of the starting material. The mixture was evaporated *in vacuo* to remove most of DMF and further purified with FC to obtain **3-59** (2.286 g, 5.16 mmol, 97% for 2 steps). ¹H NMR (400 MHz, Chloroform-*d*) δ 7.07 – 6.98 (m, 2H), 6.87 – 6.75 (m, 2H), 4.74 (d, $J = 7.8$ Hz, 1H), 4.14 (s, 1H), 4.01 (tt, $J = 10.4, 5.4$ Hz, 2H), 3.97 – 3.88 (m, 1H), 3.77 (s, 3H), 3.73 – 3.65 (m, 1H), 3.60 (t, $J = 5.4$ Hz, 1H), 3.08 (s, 1H), 2.90 (s, 1H), 2.72 (s, 1H), 1.25 (s, 3H), 1.05 (d, $J = 6.0$ Hz, 19H). ¹³C NMR (101 MHz, Chloroform-*d*) δ 155.6, 151.3, 118.9, 114.6, 102.5, 77.5, 77.2, 76.8, 74.8, 73.8, 72.0, 69.2, 63.3, 55.8, 32.1, 29.8, 29.8, 29.5, 22.8, 18.1, 18.0, 14.3, 11.9, 1.2. HRMS (Q-ToF): calculated for C₂₂H₄₂O₇NSi⁺ [M+Na]⁺ 460.2725, found 460.2748 m/z.

4-Methoxyphenyl 3,4-di-*O*-isopropylidene-6-*O*-triisopropylsilyl- β -D-galactopyranoside (**3-16**)

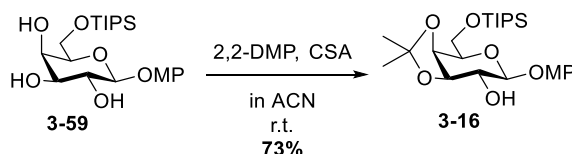

Starting material **3-59** (1389 mg, 3.14 mmol, 1.0 eq.) was dissolved in anhydrous acetonitrile (15 mL). 2,2-DMP (0.77 mL, 6.27 mmol, 2.0 eq.) and CSA (112 mg, 0.63 mmol, 0.2 eq.) were added, and the mixture was stirred at r.t. until TLC

Experimental Section

showed a full conversion of the starting material. The reaction was quenched with TEA, concentrated *in vacuo* and purified by FC to get **3-16** (1105 mg, 2.29 mmol, yield: 73%). ¹H NMR (400 MHz, Chloroform-*d*) δ 7.07 – 6.98 (m, 2H), 6.80 (dd, *J* = 9.0, 1.7 Hz, 2H), 4.65 (dd, *J* = 8.3, 1.5 Hz, 1H), 4.27 (dd, *J* = 5.4, 2.0 Hz, 1H), 4.14 (dd, *J* = 7.4, 5.3 Hz, 1H), 4.04 – 3.88 (m, 3H), 3.81 (t, *J* = 7.8 Hz, 1H), 3.76 (d, *J* = 1.6 Hz, 3H), 1.55 (s, 3H), 1.35 (s, 3H), 1.06 (d, *J* = 5.9 Hz, 18H). ¹³C NMR (101 MHz, Chloroform-*d*) δ 155.5, 151.3, 118.7, 114.6, 110.4, 102.0, 78.8, 78.7, 77.5, 77.2, 76.8, 74.4, 73.7, 73.3, 62.6, 55.7, 28.4, 26.4, 18.1, 18.1, 12.0. HRMS (Q-ToF): calculated for C₂₅H₄₂O₇SiNa⁺ [M+Na]⁺ 835.3543, found 835.3309 m/z.

4-Methoxyphenyl 2,3,4,6-tetra-*O*-acetyl-β-D-glucopyranosyl-(1→2)-3,4-di-*O*-isopropylidene-6-*O*-triisopropylsilyl-β-D-galactopyranoside (**3-60**)

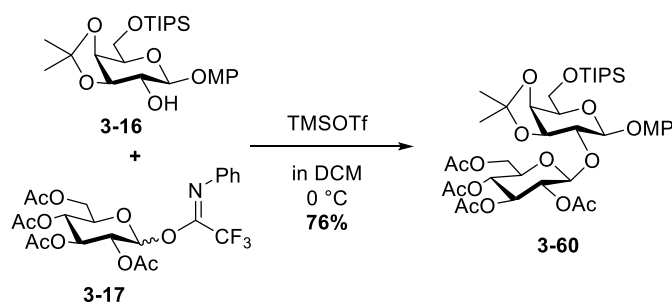

The donor **3-17** (372 mg, 770 μmol, 1.5 eq.) and the acceptor **3-16** (423 mg, 815 μmol, 1.05 eq.) were coevaporated three times with anhydrous toluene and put under high vacuum overnight to remove trace water inside. The mixture was dissolved in DCM (1 mL) and 4 Å MS was added. After being stirred for 15 min, the mixture was cooled to -0 °C and TMSOTf (0.5 μL, 3 μmol, 0.5 eq.) was added and the resultant mixture continued to be stirred until TLC showed full conversion of the starting material. The reaction was quenched with Na₂S₂O₃(aq.), extracted with EtOAc, washed with Na₂S₂O₃(aq.) and brine, dried with Na₂SO₄(s), and further purified with FC to get **3-60** (515 mg, 633 μmol, yield: 82%). ¹H NMR (400 MHz, Chloroform-*d*) δ 7.04 – 6.95 (m, 2H), 6.82 – 6.73 (m, 2H), 5.24 (t, *J* = 9.4 Hz, 1H), 5.10 (t, *J* = 9.7 Hz, 1H), 5.01 (td, *J* = 9.5, 8.8, 2.1 Hz, 1H), 4.89 (dd, *J* = 7.9, 2.1 Hz, 1H), 4.79 (dd, *J* = 7.9, 2.1 Hz, 1H), 4.26 – 4.21 (m, 1H), 4.15 (tt, *J* = 12.3, 5.3 Hz, 2H), 4.01 – 3.88 (m, 2H), 3.88 – 3.78 (m, 3H), 3.75 (d, *J* = 1.3 Hz, 3H), 3.71 – 3.62 (m, 1H), 2.08 (d, *J* = 2.1 Hz, 3H), 2.00 (d, *J* = 2.1 Hz, 6H), 1.98 (d, *J* = 1.3 Hz, 3H), 1.52 (s, 3H), 1.32 (s, 3H), 1.04 (d, *J* = 5.7 Hz,

18H). ^{13}C NMR (101 MHz, Chloroform-*d*) δ 170.8, 170.5, 169.7, 169.5, 155.4, 151.3, 118.7, 117.0, 114.5, 110.2, 101.4, 100.9, 81.9, 78.6, 77.5, 77.4, 77.2, 76.8, 73.8, 73.1, 72.9, 72.1, 71.8, 68.4, 62.5, 61.8, 60.5, 55.7, 36.7, 29.8, 28.2, 26.4, 20.9, 20.8, 20.7, 18.1, 18.0, 14.3, 12.3, 12.0, 11.7, 1.1. HRMS (Q-ToF): calculated for $\text{C}_{39}\text{H}_{60}\text{O}_{16}\text{SiNa}^+$ $[\text{M}+\text{Na}]^+$ 835.3542, found 835.3557 m/z.

4-Methoxyphenyl 2,3,4,6-tetra-*O*-acetyl- β -D-glucopyranosyl-(1 \rightarrow 2)-3,4-di-*O*-isopropylidene- β -D-galactopyranoside (**3-61**)

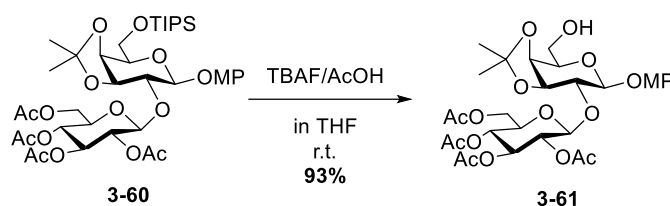

Disaccharide **3-60** (502 mg, 617 μmol , 1.0 eq.) was dissolved in THF (6 mL). AcOH (35 μL , 617 μmol , 1.0 eq.) and TBAF (1 M in THF, 617 μL , 617 μmol , 1.0 eq.) were added sequentially and the mixture was stirred at r.t. until TLC showed a full conversion of the starting material. The solvent was removed *in vacuo* and the mixture was extracted with EtOAc. After being washed with water, NaHCO_3 (sat. aq.), and brine, dried with $\text{Na}_2\text{SO}_4(\text{s})$ and concentration *in vacuo*, the crude product was further purified by CF to give **3-61** (378 mg, 575 μmol , yield: 93%). ^1H NMR (400 MHz, Chloroform-*d*) δ 6.96 (dd, $J = 8.8, 1.7$ Hz, 2H), 6.84 – 6.75 (m, 2H), 5.24 (td, $J = 9.4, 1.6$ Hz, 1H), 5.09 (t, $J = 9.7$ Hz, 1H), 5.06 – 4.97 (m, 1H), 4.87 (t, $J = 8.7$ Hz, 2H), 4.22 – 4.12 (m, 3H), 4.00 – 3.77 (m, 5H), 3.76 (d, $J = 1.6$ Hz, 3H), 3.66 (ddd, $J = 10.2, 4.3, 2.3$ Hz, 1H), 2.08 (d, $J = 1.6$ Hz, 3H), 2.00 (d, $J = 1.6$ Hz, 6H), 1.97 (d, $J = 1.7$ Hz, 3H), 1.55 (d, $J = 9.9$ Hz, 3H), 1.33 (s, 3H). ^{13}C NMR (101 MHz, Chloroform-*d*) δ 170.8, 170.5, 169.7, 169.5, 155.5, 151.0, 118.4, 114.7, 110.7, 101.4, 100.5, 81.7, 78.7, 77.5, 77.4, 77.2, 76.8, 73.6, 73.4, 72.9, 72.1, 71.8, 68.3, 62.4, 61.8, 55.8, 28.0, 26.4, 20.9, 20.8, 20.8, 20.7.

4-Methoxyphenyl β -D-glucopyranosyl-(1 \rightarrow 2)-3,4-di-O-isopropylidene-6-O-triisopropylsilyl- β -D-galactopyranoside (3-66)

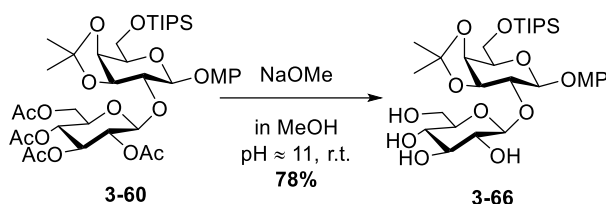

Disaccharide **3-60** (515 mg, 633 μ mol, 1.0 eq.) was dissolved in MeOH (12 mL). MeONa (5 M in THF) was added and the pH was adjusted to around 11. After TLC showed a full conversion of the starting material, Amberlite(H⁺) was added to the mixture and the pH was adjusted to 7. After filtration and removal of the solvent, **3-66** was obtained (316 mg, 490 μ mol, yield: 78%). ¹H NMR (700 MHz, Chloroform-*d*) δ 7.00 (dd, *J* = 8.7, 4.7 Hz, 2H), 6.79 (dd, *J* = 9.0, 4.7 Hz, 2H), 4.78 (dd, *J* = 8.3, 4.5 Hz, 1H), 4.69 (dd, *J* = 7.8, 4.4 Hz, 1H), 4.26 (d, *J* = 4.7 Hz, 2H), 4.01 – 3.93 (m, 2H), 3.92 – 3.84 (m, 3H), 3.75 (d, *J* = 4.6 Hz, 3H), 3.73 – 3.68 (m, 2H), 3.60 (t, *J* = 7.1 Hz, 2H), 3.45 (q, *J* = 8.2, 7.1 Hz, 1H), 3.41 – 3.33 (m, 1H), 2.66 (s, 1H), 1.76 (s, 2H), 1.34 (d, *J* = 4.6 Hz, 3H), 1.13 – 1.08 (m, 3H), 1.05 (d, *J* = 6.6 Hz, 18H). ¹³C NMR (176 MHz, Chloroform-*d*) δ 155.6, 151.4, 118.6, 114.7, 110.8, 104.1, 101.1, 81.1, 78.5, 77.3, 77.2, 77.0, 76.1, 74.7, 73.9, 73.3, 70.1, 62.5, 62.1, 55.8, 28.0, 26.3, 18.1, 18.1, 12.0. HRMS (Q-ToF): calculated for C₃₁H₅₂O₁₂SiNa⁺ [M+Na]⁺ 667.3120, found 667.3135 m/z.

4-Methoxyphenyl 2,3,4,6-tetra-O-benzyl- β -D-glucopyranosyl-(1 \rightarrow 2)-3,4-di-O-isopropylidene-6-O-triisopropylsilyl- β -D-galactopyranoside (3-67)

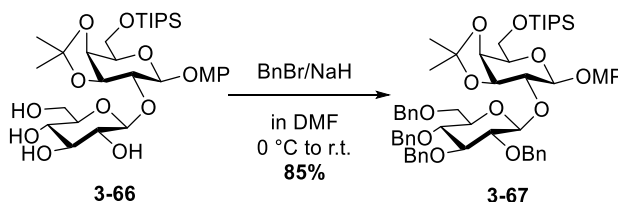

Disaccharide **3-66** (316 mg, 490 μ mol, 1.0 eq.) was dissolved in anhydrous DMF (5 mL). The mixture was cooled to 0 °C and NaH (60% in mineral oil, 158 mg, 3.92 mmol, 8.0 eq.) was added to the mixture. BnBr (0.47 mL, 3.92 mmol, 8.0 eq.) was added dropwise, the cooling bath was removed and the mixture was stirred overnight. TLC showed a full conversion of the starting material and the reaction was quenched

with MeOH. Most of the solvent was removed by evaporation *in vacuo* and the residue was extracted with EtOAc, washed with water and brine, dried by Na₂SO₄(s), concentrated and further purified by FC to obtain **3-67** (417 mg, 415 μmol, yield: 85%). ¹H NMR (600 MHz, Chloroform-*d*) δ 7.42 – 7.35 (m, 2H), 7.31 – 7.26 (m, 11H), 7.26 – 7.22 (m, 5H), 7.13 (dd, *J* = 7.4, 2.1 Hz, 2H), 6.97 – 6.90 (m, 2H), 6.75 – 6.68 (m, 2H), 5.01 (d, *J* = 11.0 Hz, 1H), 4.99 (d, *J* = 7.3 Hz, 1H), 4.92 (d, *J* = 10.9 Hz, 1H), 4.83 – 4.79 (m, 2H), 4.78 (d, *J* = 8.4 Hz, 1H), 4.73 (d, *J* = 11.0 Hz, 1H), 4.53 (d, *J* = 3.6 Hz, 1H), 4.52 (d, *J* = 2.0 Hz, 1H), 4.34 (d, *J* = 12.3 Hz, 1H), 4.31 (t, *J* = 5.9 Hz, 1H), 4.26 (dd, *J* = 5.9, 1.8 Hz, 1H), 4.04 (dd, *J* = 7.2, 5.9 Hz, 1H), 3.98 (dd, *J* = 9.8, 6.6 Hz, 1H), 3.94 (dd, *J* = 9.8, 6.2 Hz, 1H), 3.87 (td, *J* = 6.4, 1.9 Hz, 1H), 3.73 (s, 3H), 3.71 (d, *J* = 9.5 Hz, 1H), 3.65 (t, *J* = 9.1 Hz, 1H), 3.55 (dd, *J* = 11.0, 3.2 Hz, 1H), 3.47 (dd, *J* = 9.0, 7.9 Hz, 1H), 3.29 (dt, *J* = 9.8, 2.4 Hz, 1H), 3.09 (dd, *J* = 11.0, 2.0 Hz, 1H), 1.46 (s, 3H), 1.32 (s, 3H), 1.06 (dd, *J* = 6.8, 1.9 Hz, 18H). ¹³C NMR (151 MHz, Chloroform-*d*) δ 155.0, 151.4, 138.9, 138.9, 138.4, 138.4, 128.5, 128.4, 128.4, 128.3, 128.1, 128.0, 127.9, 127.8, 127.7, 127.7, 127.6, 117.8, 114.5, 110.4, 102.7, 100.6, 84.9, 82.7, 79.8, 78.6, 77.7, 77.4, 77.2, 76.9, 75.8, 75.1, 75.0, 73.7, 73.6, 73.0, 68.0, 62.7, 55.8, 27.8, 26.4, 18.1, 18.1, 12.1. HRMS (Q-ToF): calculated for C₅₉H₇₆O₁₂SiNa⁺ [M+Na]⁺ 1027.4998, found 1027.4990 m/z.

4-Methoxyphenyl 2,3,4,6-tetra-*O*-benzyl-β-D-glucopyranosyl-(1→2)-3,4-di-*O*-isopropylidene-β-D-galactopyranoside (**3-68**)

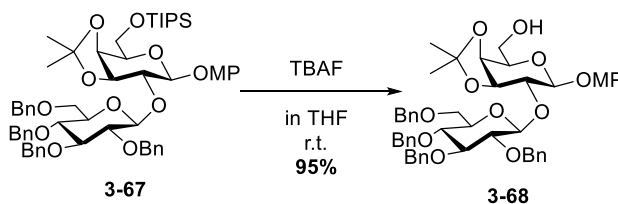

Disaccharide **3-67** (412 mg, 410 μmol, 1.0 eq.) was dissolved in THF (4 mL). TBAF (1 M in THF, 500 μL, 500 μmol, 1.2 eq.) was added and the mixture was stirred at r.t. until TLC showed a full conversion of the starting material. The solvent was removed *in vacuo* and the mixture was extracted with EtOAc. After being washed with water, NaHCO₃ (sat. aq.), and brine, dried with Na₂SO₄(s) and concentration *in vacuo*, the crude product was further purified by CF to give **3-68** (331 mg, 390 μmol, yield:

Experimental Section

95%). ^1H NMR (400 MHz, Chloroform-*d*) δ 7.38 – 7.31 (m, 2H), 7.29 – 7.18 (m, 17H), 7.08 (dq, $J = 7.8, 2.6$ Hz, 2H), 6.90 – 6.83 (m, 2H), 6.74 – 6.66 (m, 2H), 5.04 (d, $J = 7.0$ Hz, 1H), 4.96 (dd, $J = 11.2, 2.2$ Hz, 1H), 4.89 (dd, $J = 11.0, 2.2$ Hz, 1H), 4.79 – 4.67 (m, 4H), 4.47 (dd, $J = 11.3, 3.9$ Hz, 2H), 4.33 – 4.24 (m, 2H), 4.13 (dd, $J = 6.1, 1.9$ Hz, 1H), 4.00 (dd, $J = 7.0, 5.9$ Hz, 1H), 3.95 – 3.85 (m, 2H), 3.81 – 3.72 (m, 1H), 3.69 (s, 3H), 3.67 (d, $J = 9.4$ Hz, 1H), 3.61 (dd, $J = 10.0, 7.9$ Hz, 1H), 3.48 (dd, $J = 10.9, 3.1$ Hz, 1H), 3.43 (dd, $J = 8.9, 7.9$ Hz, 1H), 3.23 (ddd, $J = 9.5, 3.1, 1.9$ Hz, 1H), 2.99 (dd, $J = 10.8, 2.0$ Hz, 1H), 2.05 – 1.97 (m, 1H), 1.42 (s, 3H), 1.29 (s, 3H). ^{13}C NMR (101 MHz, Chloroform-*d*) δ 155.0, 150.9, 138.8, 138.7, 138.3, 138.2, 128.5, 128.5, 128.4, 128.4, 128.3, 128.1, 128.0, 128.0, 127.9, 127.7, 127.7, 127.7, 117.3, 114.6, 110.8, 102.7, 100.0, 84.8, 82.6, 79.6, 78.4, 77.5, 77.5, 77.4, 77.2, 76.8, 75.8, 75.1, 75.0, 74.9, 73.5, 73.4, 73.1, 67.8, 62.6, 55.8, 27.6, 26.3. HRMS (Q-ToF): calculated for $\text{C}_{50}\text{H}_{56}\text{O}_{12}\text{Na}^+$ $[\text{M}+\text{Na}]^+$ 871.3664, found 871.3672 m/z.

(4-Methoxyphenyl 2,3,4,6-tetra-*O*-benzyl- β -D-glucopyranosyl-(1 \rightarrow 2)-3,4-di-*O*-isopropylidene- β -D-galactopyranosid)uronate (3-69)

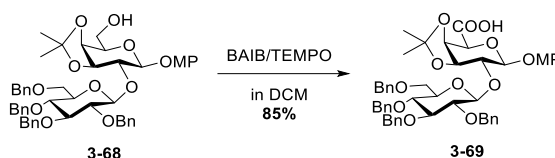

Disaccharide **3-68** (318 mg, 375 μmol , 1.0 eq.) was dissolved in a mixed solvent of DCM (2 mL) and H_2O (1 mL). BAIB (362 mg, 1124 μmol , 3.0 eq.) and TEMPO (29 mg, 187 μmol , 0.5 eq.) were added and the mixture was stirred at r.t. until LC-MS showed a full conversion of the starting material. The mixture was extracted with EtOAc, dried with $\text{Na}_2\text{SO}_4(\text{s})$ and purified with FC to get product **3-69** (274 mg, 317 μmol , yield: 85%). ^1H NMR (600 MHz, Chloroform-*d*) δ 7.43 – 7.08 (m, 21H), 6.97 (d, $J = 8.4$ Hz, 2H), 6.75 (d, $J = 8.4$ Hz, 2H), 5.38 – 5.13 (m, 1H), 4.92 (d, $J = 11.0$ Hz, 1H), 4.89 (d, $J = 10.9$ Hz, 1H), 4.84 – 4.78 (m, 2H), 4.73 (dd, $J = 35.6, 9.5$ Hz, 2H), 4.51 (t, $J = 11.3$ Hz, 3H), 4.34 (d, $J = 14.0$ Hz, 2H), 4.09 (s, 1H), 3.76 – 3.55 (m, 6H), 3.40 – 3.31 (m, 1H), 3.29 (s, 1H). ^{13}C NMR (151 MHz, Chloroform-*d*) δ 155.5, 138.7, 138.3, 138.2, 128.5, 128.5, 128.5, 128.1, 128.0, 127.9, 127.8, 127.8, 127.7, 114.8, 103.1,

84.9, 82.5, 77.6, 77.4, 77.2, 76.9, 75.8, 75.1, 75.0, 73.5, 68.2, 55.7. HRMS (Q-ToF): calculated for $C_{50}H_{54}O_{13}Na^+$ $[M+Na]^+$ 885.3457, found 885.3466 m/z.

Benzyl (4-methoxyphenyl 2,3,4,6-tetra-*O*-benzyl- β -D-glucoopyranosyl-(1 \rightarrow 2)-3,4-di-*O*-isopropylidene- β -D-galactopyranosid)uronate (3-64)

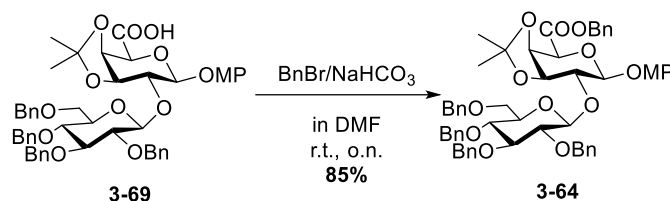

Disaccharide **3-69** (209 mg, 242 μ mol, 1.0 eq.) was put under high vacuum overnight and dissolved in anhydrous DMF (5.0 mL). $NaHCO_3$ (203 mg, 2422 μ mol, 10 eq.) and BnBr (144 μ L, 1211 μ mol, 5.0 eq.) were added sequentially and the mixture was stirred at r.t. until TLC showed the disappearance of the starting material. The mixture was filtrated, evaporated and purified with FC to get **3-64** (197 mg, 207 μ mol, yield: 85%). 1H NMR (400 MHz, Chloroform-*d*) δ 7.35 (qdt, $J = 5.6, 3.3, 2.0$ Hz, 7H), 7.31 – 7.21 (m, 19H), 7.13 (dt, $J = 6.6, 2.3$ Hz, 2H), 7.03 – 6.97 (m, 2H), 6.77 – 6.70 (m, 2H), 5.34 (d, $J = 12.3$ Hz, 1H), 5.22 (d, $J = 12.4$ Hz, 1H), 5.12 (d, $J = 5.8$ Hz, 1H), 4.92 (dd, $J = 11.0, 5.2$ Hz, 2H), 4.83 – 4.71 (m, 4H), 4.55 – 4.48 (m, 3H), 4.45 (d, $J = 2.3$ Hz, 1H), 4.38 (dd, $J = 6.3, 5.0$ Hz, 1H), 4.33 (d, $J = 12.2$ Hz, 1H), 4.16 – 4.10 (m, 1H), 3.73 (s, 3H), 3.70 (d, $J = 9.3$ Hz, 1H), 3.66 (d, $J = 8.8$ Hz, 1H), 3.58 (dd, $J = 10.9, 3.3$ Hz, 1H), 3.46 (t, $J = 8.3$ Hz, 1H), 3.32 (ddd, $J = 9.5, 3.4, 1.9$ Hz, 1H), 3.21 (dd, $J = 10.8, 2.0$ Hz, 1H), 1.31 (s, 3H). ^{13}C NMR (101 MHz, Chloroform-*d*) δ 167.0, 155.3, 151.2, 138.7, 138.7, 138.2, 138.2, 135.5, 128.6, 128.5, 128.5, 128.5, 128.4, 128.3, 128.1, 128.1, 128.0, 127.9, 127.9, 127.8, 127.8, 127.7, 118.7, 114.5, 111.0, 103.0, 101.1, 84.8, 82.5, 78.2, 77.6, 77.5, 77.4, 77.2, 77.0, 76.8, 75.8, 75.1, 75.1, 75.0, 73.6, 73.3, 71.7, 68.0, 67.1, 55.7, 27.2, 26.0. HRMS (Q-ToF): calculated for $C_{57}H_{60}O_{13}Na^+$ $[M+Na]^+$ 975.3926, found 975.3922 m/z.

Benzyl (4-methoxyphenyl 2,3,4,6-tetra-*O*-benzyl- β -D-glucopyranosyl-(1 \rightarrow 2)- β -D-galactopyranosid)uronate (3-70)

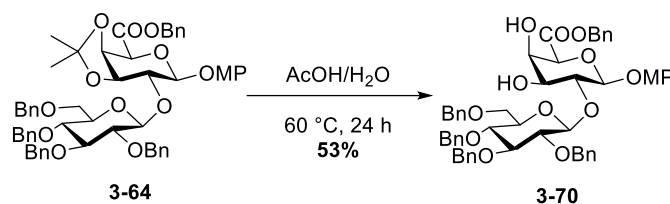

Disaccharide **3-64** (197 mg, 207 μ mol, 1.0 eq.) was dissolved in a mixed solvent of AcOH (3.2 mL) and H₂O (0.8 mL). The mixture was heated and stirred at 60 °C until TLC showed a full conversion of the starting material. The product was extracted with EtOAc (100 mL), washed with H₂O (100 mL x 2), NaHCO₃ (sat. aq., 100 mL) and brine, dried with Na₂SO₄(s), concentrated *in vacuo* and purified with FC to get **3-70** (100 mg, 110 μ mol, yield: 53%). ¹H NMR (400 MHz, Chloroform-*d*) δ 7.39 – 7.22 (m, 26H), 7.16 (dd, *J* = 7.1, 2.5 Hz, 2H), 7.11 – 7.03 (m, 2H), 6.75 – 6.64 (m, 2H), 5.29 (d, *J* = 12.3 Hz, 1H), 5.17 (d, *J* = 12.3 Hz, 1H), 4.94 – 4.82 (m, 5H), 4.79 (d, *J* = 10.8 Hz, 1H), 4.68 (d, *J* = 7.8 Hz, 1H), 4.58 (dd, *J* = 11.5, 7.3 Hz, 2H), 4.45 (d, *J* = 12.1 Hz, 1H), 4.28 (td, *J* = 3.6, 1.6 Hz, 1H), 4.18 (d, *J* = 1.5 Hz, 1H), 3.98 (dd, *J* = 9.0, 7.4 Hz, 1H), 3.43 (ddd, *J* = 9.4, 3.7, 1.9 Hz, 1H), 2.53 (d, *J* = 3.8 Hz, 1H). ¹³C NMR (101 MHz, Chloroform-*d*) δ 167.5, 155.6, 151.5, 138.4, 138.2, 138.1, 137.7, 135.3, 128.7, 128.7, 128.6, 128.6, 128.5, 128.4, 128.2, 128.2, 128.1, 128.0, 127.9, 127.9, 127.8, 127.7, 119.5, 114.4, 104.0, 101.0, 85.3, 82.1, 81.0, 78.0, 77.5, 77.4, 77.2, 76.8, 75.7, 75.4, 75.1, 73.6, 73.6, 72.8, 69.3, 68.4, 67.3, 55.7. HRMS (Q-ToF): calculated for C₅₄H₅₆O₁₃Na⁺ [M+Na]⁺ 935.3613, found 935.3627 m/z.

Benzyl (4-methoxyphenyl 2,3,4,6-tetra-*O*-benzyl- β -D-glucopyranosyl-(1 \rightarrow 2)-4-*O*-acetyl- β -D-galactopyranosid)uronate (3-74)

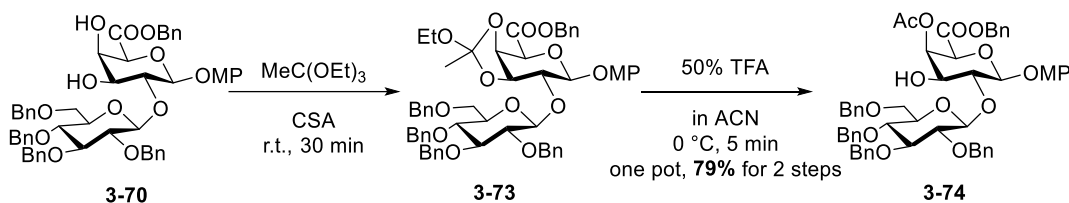

Disaccharide **3-70** (31 mg, 34 μ mol, 1.0 eq.) was dissolved in triethyl orthoacetate (1 mL) followed by the addition of CSA (4 mg, 17 μ mol, 0.5 eq.). The

solution was stirred at r.t. for 30 min and TLC showed a full conversion of the starting material. The mixture was evaporated *in vacuo* and dissolved in acetonitrile (1 mL). The temperature was cooled to 0 °C, TFA (50% aq., 0.3 mL) was added to the solution and TLC showed a completion of the reaction after 5 min. The mixture was extracted with EtOAc, washed with water, NaHCO₃ (aq.) and brine, dried with Na₂SO₄ (s), concentrated and further purified by FC to get **3-74** (28 mg, 29 μmol, yield: 79%). ¹H NMR (600 MHz, Chloroform-*d*) δ 7.96 (d, *J* = 7.7 Hz, 2H), 7.55 – 7.48 (m, 3H), 7.46 – 7.07 (m, 24H), 5.61 (s, 1H), 5.27 (t, *J* = 8.0 Hz, 1H), 5.15 (t, *J* = 9.2 Hz, 2H), 4.83 (d, *J* = 12.1 Hz, 1H), 4.71 (d, *J* = 12.1 Hz, 1H), 4.55 (dd, *J* = 28.6, 8.4 Hz, 1H), 4.43 – 4.33 (m, 3H), 3.91 – 3.81 (m, 4H), 3.79 – 3.66 (m, 1H), 3.49 (s, 1H), 3.44 – 3.33 (m, 1H), 3.10 – 2.89 (m, 2H). ¹³C NMR (151 MHz, Chloroform-*d*) δ 165.1, 138.0, 137.4, 133.2, 130.0, 129.9, 129.9, 129.2, 128.6, 128.5, 128.5, 128.4, 128.3, 128.2, 127.9, 127.7, 126.2, 126.2, 102.0, 101.4, 81.9, 78.0, 77.4, 77.2, 76.9, 74.1, 73.6, 70.2, 68.9, 67.2, 66.5, 50.6, 50.3, 47.2, 46.2, 29.2, 27.8, 27.4, 23.1. HRMS (Q-ToF): calculated for C₅₆H₅₈O₁₄Na⁺ [M+Na]⁺ 977.3719, found 977.3723 m/z.

Benzyl (4-methoxyphenyl 2,3,4,6-tetra-*O*-benzyl-β-D-glucopyranosyl-(1→2)-3-*O*-fluorenylmethoxycarbonyl-4-*O*-acetyl-β-D-galactopyranosid)uronate (3-12)

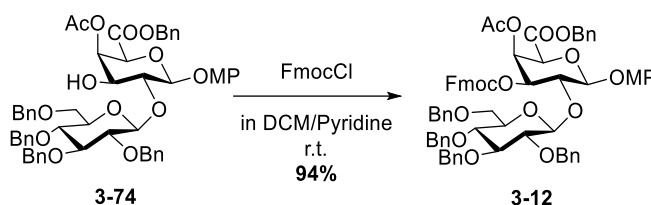

Disaccharide **3-74** (13 mg, 14 μmol, 1.0 eq.) was dissolved in a mixed solvent of DCM (0.9 mL) and pyridine (0.1 mL). FmocCl (18 mg, 68 μmol, 5.0 eq.) was added and the solution was stirred at r.t. until TLC showed a full conversion of the starting material. The mixture was evaporated and purified with FC to obtain **3-12** (15 mg, 13 μmol, yield: 94%). ¹H NMR (700 MHz, Chloroform-*d*) δ 7.72 (dd, *J* = 13.3, 7.6 Hz, 2H), 7.54 (d, *J* = 7.6 Hz, 1H), 7.48 (d, *J* = 7.5 Hz, 1H), 7.41 – 7.32 (m, 7H), 7.28 (d, *J* = 8.6 Hz, 9H), 7.25 – 7.17 (m, 8H), 7.13 (dd, *J* = 4.8, 2.6 Hz, 3H), 7.08 – 7.03 (m, 2H), 6.72 – 6.64 (m, 2H), 5.89 – 5.84 (m, 1H), 5.24 (dd, *J* = 12.0, 1.8 Hz, 1H), 5.12 (dd, *J* = 12.0, 1.9 Hz, 1H), 5.06 – 5.01 (m, 1H), 4.98 (dd, *J* = 7.6, 1.7 Hz, 1H), 4.82 (ddd, *J* =

Experimental Section

13.7, 9.3, 3.6 Hz, 3H), 4.80 – 4.73 (m, 2H), 4.63 – 4.56 (m, 3H), 4.46 (dd, $J = 12.2, 1.7$ Hz, 1H), 4.37 (s, 1H), 4.37 – 4.32 (m, 2H), 4.18 (ddd, $J = 10.1, 7.5, 1.7$ Hz, 1H), 4.11 (t, $J = 7.5$ Hz, 1H), 3.73 (d, $J = 1.9$ Hz, 4H), 3.67 (dt, $J = 10.6, 2.9$ Hz, 1H), 3.63 (td, $J = 9.1, 1.7$ Hz, 1H), 3.40 (ddd, $J = 16.6, 10.7, 3.5$ Hz, 3H), 1.88 (d, $J = 1.8$ Hz, 3H). ^{13}C NMR (176 MHz, Chloroform-*d*) δ 169.9, 165.7, 155.8, 154.2, 151.5, 143.6, 143.4, 141.4, 141.4, 138.7, 138.6, 138.5, 138.4, 135.0, 129.2, 128.8, 128.8, 128.5, 128.5, 128.5, 128.4, 128.3, 128.1, 128.0, 128.0, 127.9, 127.8, 127.8, 127.7, 127.7, 127.6, 127.5, 127.3, 125.4, 125.4, 120.1, 120.1, 119.2, 114.6, 103.1, 101.8, 85.1, 82.7, 77.8, 77.3, 77.2, 77.0, 76.6, 75.8, 75.2, 75.0, 74.8, 74.5, 73.7, 72.0, 70.5, 68.5, 68.0, 67.7, 55.8, 46.7, 20.5. HRMS (Q-ToF): calculated for $\text{C}_{71}\text{H}_{68}\text{O}_{16}\text{Na}^+$ $[\text{M}+\text{Na}]^+$ 1199.4400, found 1199.4390 m/z .

Phenyl 2-azido-4,6-di-*O*-benzylidene-2-deoxy-1-seleno- α -D-galactopyranoside (**3-75**)

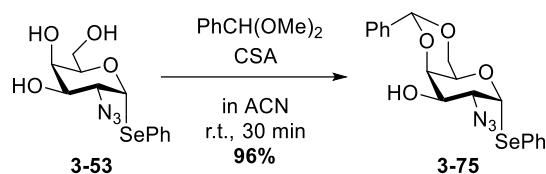

Selenoglycoside **3-53** (9.01 g, 26 mmol, 1.0 eq.) was dissolved in anhydrous acetonitrile (52 mL). Benzaldehyde dimethyl acetal (12 mL, 78 mmol, 3.0 eq.) and CSA (177 mg, 2.6 mmol, 3.0 eq.) were added to the solution and the mixture was stirred at r.t. for 30 min. TLC showed a full conversion of the starting material and the reaction was quenched with TEA. After evaporation *in vacuo*, the mixture was extracted with EtOAc, washed with water and brine, dried with Na_2SO_4 (s), concentrated *in vacuo* and further purified by FC to get **3-77** (10.88 g, 25 mmol, yield: 96%). ^1H NMR (600 MHz, Chloroform-*d*) δ 7.58 (dd, $J = 7.2, 2.3$ Hz, 2H), 7.52 – 7.47 (m, 2H), 7.40 (q, $J = 3.2, 2.3$ Hz, 3H), 7.32 – 7.26 (m, 3H), 6.04 (d, $J = 5.1$ Hz, 1H), 5.61 (s, 1H), 4.31 (d, $J = 3.7$ Hz, 1H), 4.18 (dd, $J = 11.1, 1.9$ Hz, 2H), 4.14 (dd, $J = 10.2, 5.1$ Hz, 1H), 4.09 (dd, $J = 13.1, 2.4$ Hz, 1H), 3.94 (td, $J = 10.2, 3.5$ Hz, 1H), 2.59 (dd, $J = 10.2, 1.9$ Hz, 1H). ^{13}C NMR (151 MHz, Chloroform-*d*) δ 137.3, 133.9, 129.6, 129.4, 129.3, 128.7, 128.5, 127.9, 126.4, 101.5, 85.3, 77.4, 77.2, 76.9, 75.1, 70.8, 69.2, 65.2, 62.2. Data compatible as reported.¹¹³

Phenyl 2-azido-3-*O*-*tert*-butyldimethylsilyl-4,6-di-*O*-benzylidene-2-deoxy-1-seleno- α -D-galactopyranoside (3-76)

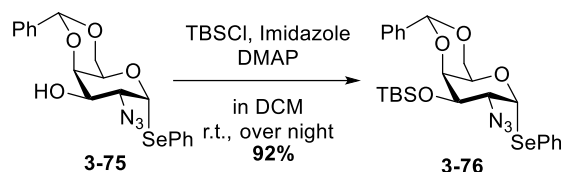

Selenoglycoside **3-75** (1.063 g, 2.46 mmol, 1.0 eq.) was dissolved in anhydrous DCM (25 mL). TBSCl (743 mg, 4.92 mmol, 2.0 eq.), imidazole (418 mg, 6.15 mmol, 2.5 eq.) and DMAP (60 mg, 0.49 mmol, 0.2 eq.) were added sequentially and the mixture was stirred at r.t. overnight. After TLC showed a full conversion of the starting material, MeOH was added to the mixture to quench the reaction. The solvent was evaporated and the crude was purified by FC to get **3-76** (1.236 g, 2.26 mmol, yield 92%). ^1H NMR (400 MHz, Chloroform-*d*) δ 7.60 – 7.55 (m, 2H), 7.54 – 7.49 (m, 2H), 7.40 – 7.33 (m, 3H), 7.27 (d, J = 2.2 Hz, 2H), 6.06 (d, J = 5.1 Hz, 1H), 5.57 (s, 1H), 4.26 (dd, J = 10.0, 5.1 Hz, 1H), 4.21 – 4.13 (m, 2H), 4.13 – 4.05 (m, 2H), 3.93 (dd, J = 10.0, 3.4 Hz, 1H), 0.95 (s, 9H), 0.21 (s, 3H), 0.18 (s, 3H). ^{13}C NMR (101 MHz, Chloroform-*d*) δ 137.7, 133.8, 129.3, 129.0, 129.0, 128.3, 127.8, 126.1, 100.8, 85.9, 77.5, 77.4, 77.2, 76.8, 76.3, 72.1, 69.3, 65.4, 61.9, 25.8, 18.2, -4.3, -4.6. LCMS (ESI): calculated for $\text{C}_{25}\text{H}_{33}\text{N}_3\text{O}_4\text{SeSiNa}^+$ $[\text{M}+\text{Na}]^+$ 570.1, found 570.0 m/z.

Phenyl 2-azido-3-*O*-*tert*-butyldimethylsilyl-2-deoxy-1-seleno- α -D-galactopyranoside (3-77)

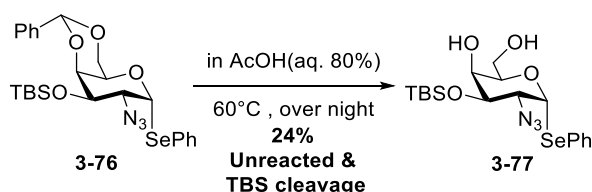

Selenoglycoside **3-76** (1227 mg, 2.24 mmol, 1.0 eq.) was dissolved in a mixture of AcOH (8 mL) and H₂O (2 mL). The mixture was stirred at 60 °C and TLC showed a full conversion of the starting material and two spots. After being extracted with EtOAc, washed with water, NaHCO₃ (sat. aq.) and brine, dried with Na₂SO₄ (s), concentrated *in vacuo* and purified with FC, **3-77** (247 mg, 0.54 mmol, yield: 24%) was obtained. ^1H NMR (600 MHz, Chloroform-*d*) δ 7.64 – 7.56 (m, 2H), 7.33 – 7.27 (m, 3H), 6.00 (d, J

Experimental Section

= 5.3 Hz, 1H), 4.26 (td, $J = 4.6, 2.2$ Hz, 1H), 4.07 (dd, $J = 9.8, 5.2$ Hz, 1H), 3.94 – 3.91 (m, 1H), 3.91 – 3.88 (m, 1H), 3.81 (dd, $J = 9.8, 3.3$ Hz, 1H), 3.78 – 3.68 (m, 1H), 2.65 (s, 1H), 1.97 – 1.85 (m, 1H), 0.95 (s, 9H), 0.24 (s, 3H), 0.19 (s, 3H). ^{13}C NMR (151 MHz, Chloroform-*d*) δ 171.3, 135.0, 129.4, 128.2, 128.0, 84.7, 84.4, 77.4, 77.2, 76.9, 72.4, 72.3, 70.7, 62.9, 62.5, 60.5, 25.9, 21.2, 18.1, 14.3, 1.2, -4.5, -4.7. LCMS (ESI): calculated for $\text{C}_{18}\text{H}_{29}\text{N}_3\text{O}_4\text{SeSiNa}^+ [\text{M}+\text{Na}]^+$ 482.1, found 482.0 *m/z*.

Phenyl 2-azido-4,6-di-*O*-benzyl-2-deoxy-1-seleno- α -D-galactopyranoside (**3-15**)

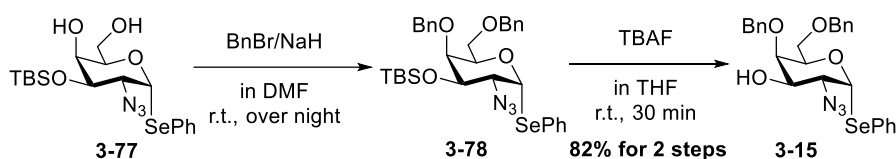

Selenoglycoside **3-77** (244 mg, 533 μmol , 1.0 eq.) was dissolved in anhydrous DMF (6 mL). The mixture was cooled to 0 $^{\circ}\text{C}$ and NaH (60% in mineral oil, 128 mg, 3.20 mmol, 6.0 eq.) was added to the mixture. BnBr (0.38 mL, 3.20 mmol, 6.0 eq.) was added dropwise, the cooling bath was removed and the mixture was stirred overnight. TLC showed a full conversion of the starting material and the reaction was quenched with MeOH. Most of the solvent was removed by evaporation *in vacuo* and the residue was extracted with EtOAc, washed with water and brine, dried by $\text{Na}_2\text{SO}_4(\text{s})$, concentrated and further purified by FC to obtain crude **3-78** which was used in the next step directly. After **3-78** from the previous step was dissolved in THF (2 mL), TBAF (1 M in THF, 0.6 mL) was added to the solution and the reaction was monitored by TLC. After the starting material was fully converted, the mixture was extracted with EtOAc, washed with water and brine, dried by $\text{Na}_2\text{SO}_4(\text{s})$, concentrated and further purified by FC to obtain **3-15** (230 mg, 439 μmol , 82% for two steps). ^1H NMR (600 MHz, Chloroform-*d*) δ 7.43 – 7.08 (m, 21H), 6.97 (d, $J = 8.4$ Hz, 2H), 6.75 (d, $J = 8.4$ Hz, 2H), 5.38 – 5.13 (m, 1H), 4.92 (d, $J = 11.0$ Hz, 1H), 4.89 (d, $J = 10.9$ Hz, 1H), 4.84 – 4.78 (m, 2H), 4.73 (dd, $J = 35.6, 9.5$ Hz, 2H), 4.51 (t, $J = 11.3$ Hz, 3H), 4.34 (d, $J = 14.0$ Hz, 2H), 4.09 (s, 1H), 3.76 – 3.55 (m, 6H), 3.40 – 3.31 (m, 1H), 3.29 (s, 1H). ^{13}C NMR (151 MHz, Chloroform-*d*) δ 155.5, 138.7, 138.3, 138.2, 128.5, 128.5, 128.5, 128.1, 128.0, 127.9, 127.8, 127.8, 127.7, 114.8, 103.1, 84.9, 82.5, 77.6, 77.4, 77.2, 76.9, 75.8, 75.1, 75.0, 73.5, 68.2, 55.7. Data compatible as reported.¹¹⁴

2-Azido-3-acetyl-4,6-di-O-benzyl-2-deoxy- α -D-galactopyranosyl-(1 \rightarrow 1)-5-(*N*-benzyl-*N*-benzyloxycarbonyl)aminopentanol (3-13**)**

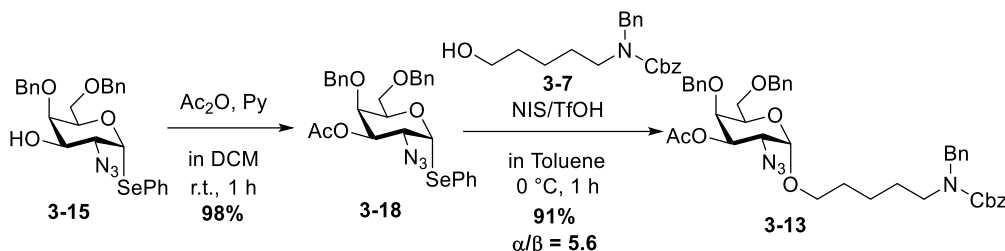

Selenoglycoside **3-15** (93 mg, 177 μmol , 1.0 eq.) was dissolved in a mixture of anhydrous DCM (0.8 mL), pyridine (0.1 mL) and Ac_2O (0.1 mL). The solution was stirred at r.t. until TLC showed a full conversion of the starting material. The product was extracted with EtOAc, washed with water and brine, dried by $\text{Na}_2\text{SO}_4(\text{s})$, concentrated and further purified by FC to obtain **3-18** (99 mg, 439 μmol , yield: 98%). Donor **3-15** (39 mg, 69 μmol , 1.0 eq.) and acceptor **3-7** (29 mg, 89 μmol , 1.3 eq.) were coevaporated with toluene for three times and put under high vacuum overnight to remove trace water in them. The starting materials were dissolved in anhydrous toluene (0.8 mL), 4 Å molecular sieves were added and the suspension was stirred at -0 °C for 5 min. NIS (67 mg, 297 μmol , 1.5 eq.) and TfOH (1.2 μL , 14 μmol , 0.2 eq.) were added and the resultant mixture was stirred at that temperature until TLC showed a full conversion of the donor. The reaction was quenched with $\text{Na}_2\text{S}_2\text{O}_3(\text{aq.})$, extracted with EtOAc, washed with $\text{Na}_2\text{S}_2\text{O}_3(\text{aq.})$ and brine, dried with $\text{Na}_2\text{SO}_4(\text{s})$, concentrated and purified with FC to get **3-13**, 46 mg, α/β = 5.6, 62 μmmol , yield: 91%, yield for **3-13 α** : 77%. $^1\text{H NMR}$ of **3-13 α** (600 MHz, Chloroform-*d*) δ 7.44 – 7.22 (m, 20H), 7.17 (s, 1H), 5.17 (d, J = 17.4 Hz, 2H), 4.92 (d, J = 11.6 Hz, 1H), 4.74 (d, J = 3.0 Hz, 2H), 4.62 (d, J = 11.6 Hz, 1H), 4.49 (d, J = 10.6 Hz, 2H), 4.20 (dd, J = 11.2, 6.5 Hz, 1H), 4.18 – 4.11 (m, 1H), 4.06 (dd, J = 11.2, 6.3 Hz, 1H), 3.87 (s, 1H), 3.81 (dd, J = 10.4, 8.0 Hz, 1H), 3.74 (d, J = 2.7 Hz, 1H), 3.50 – 3.38 (m, 2H), 3.29 (dd, J = 10.5, 2.7 Hz, 1H), 3.23 (d, J = 39.5 Hz, 2H), 1.97 (d, J = 0.7 Hz, 3H), 1.61 (d, J = 7.7 Hz, 6H), 1.45 – 1.18 (m, 4H). HRMS (Q-ToF): calculated for $\text{C}_{42}\text{H}_{48}\text{N}_4\text{O}_8\text{Na}^+$ [$\text{M}+\text{Na}$] $^+$ 759.3364, found 759.3376 m/z.

Experimental Section

4.6 Spectra of Important Compounds

¹H NMR of 2-1

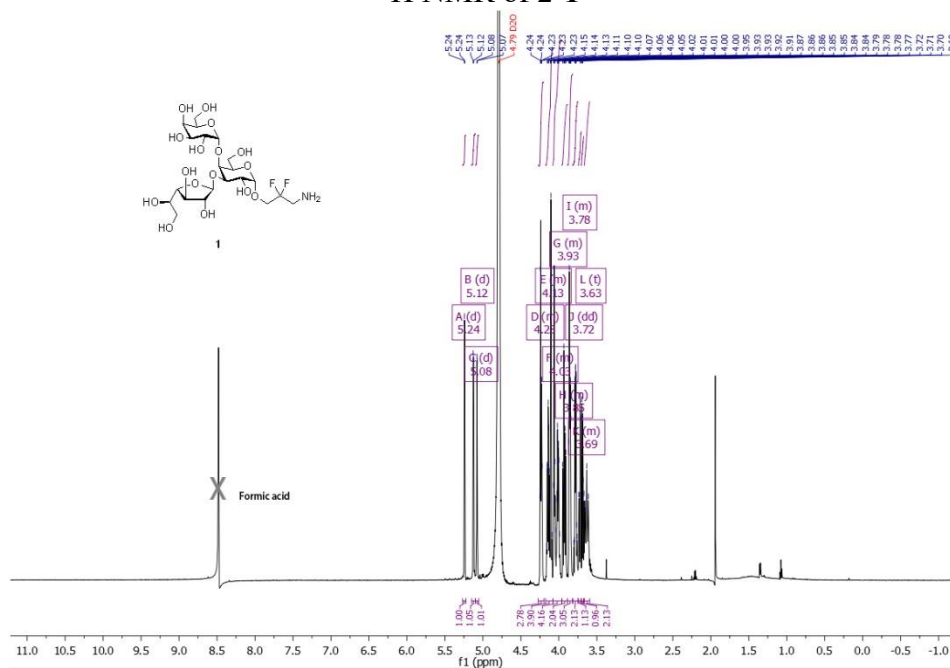

¹³C NMR of 2-1

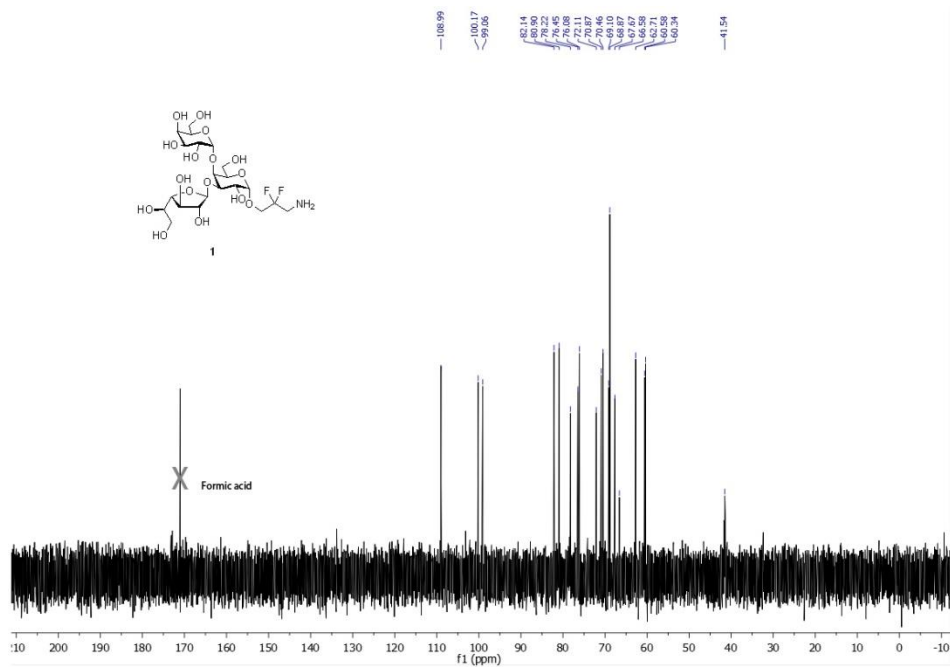

Decoupled H-C HSQC of 2-1

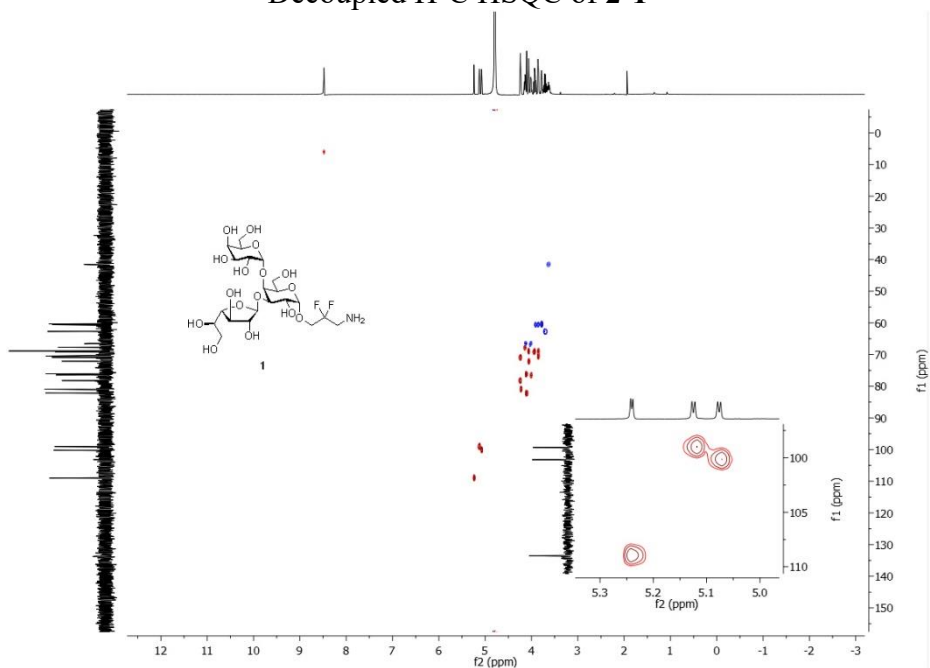

¹H NMR of 2-2

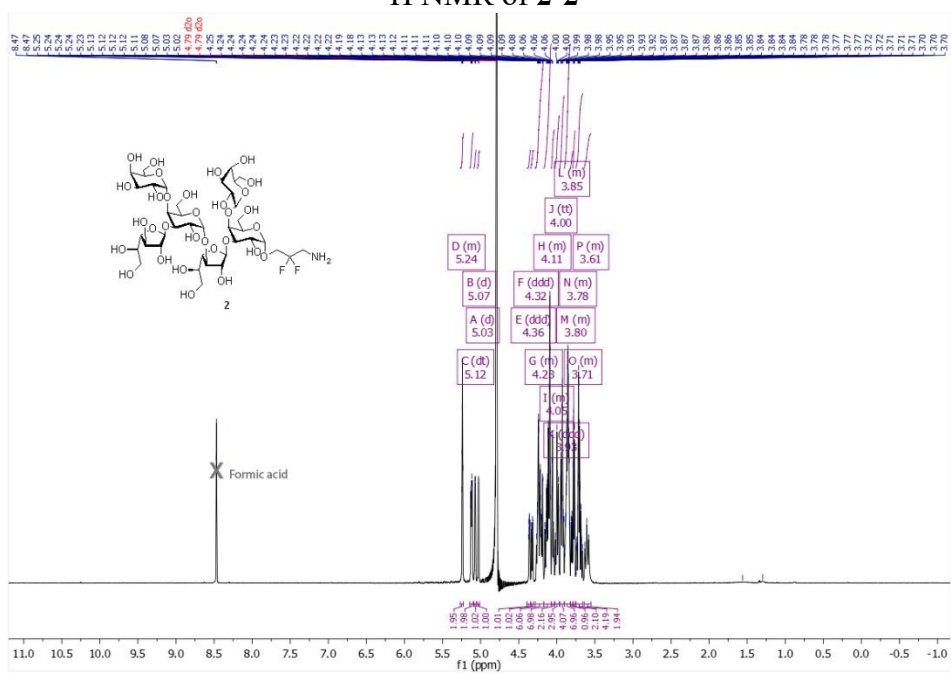

Coupled H-C HSQC of 2-2

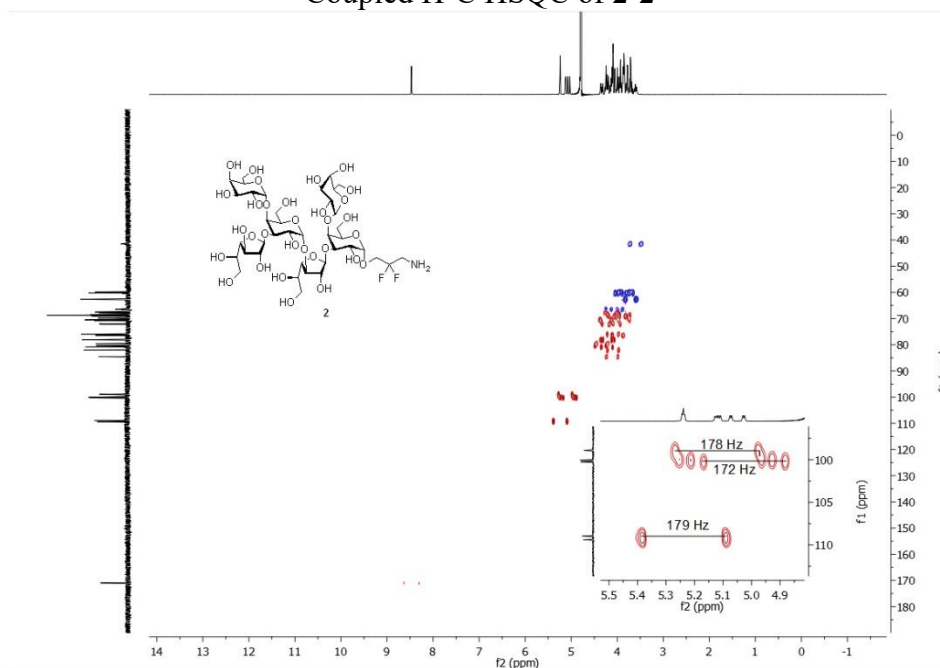

¹H NMR of 2-3

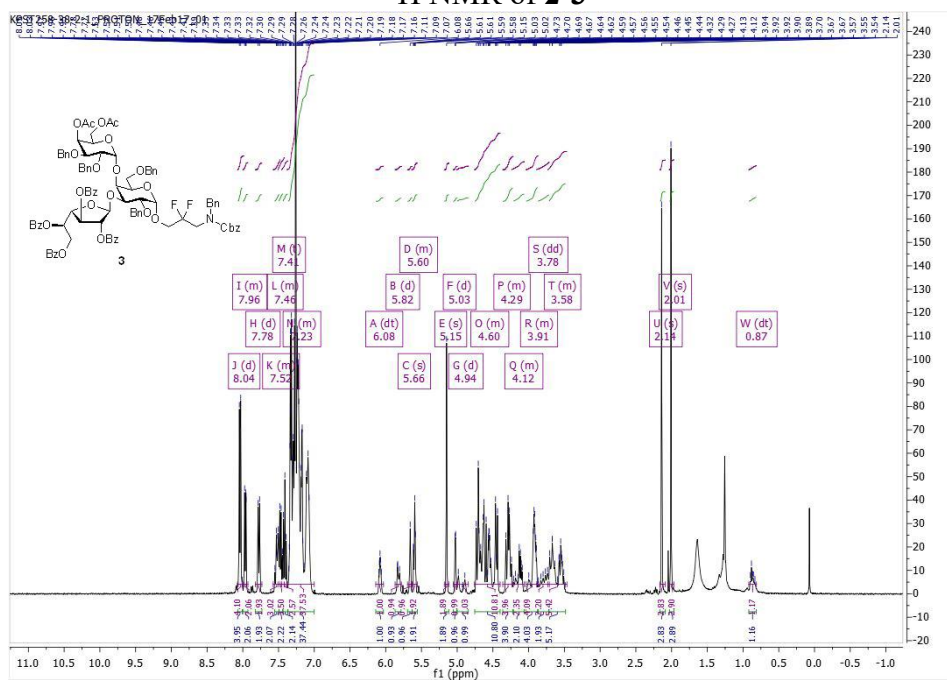

Experimental Section

^{13}C NMR of 2-3

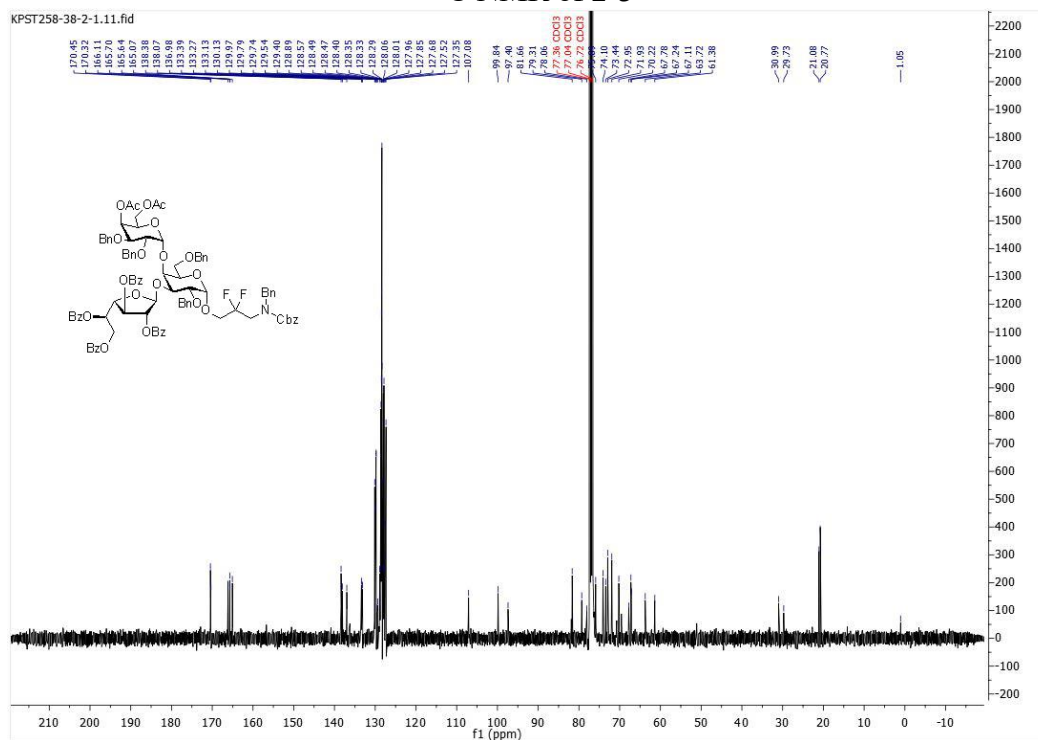

Decoupled H-C HSQC of 2-3

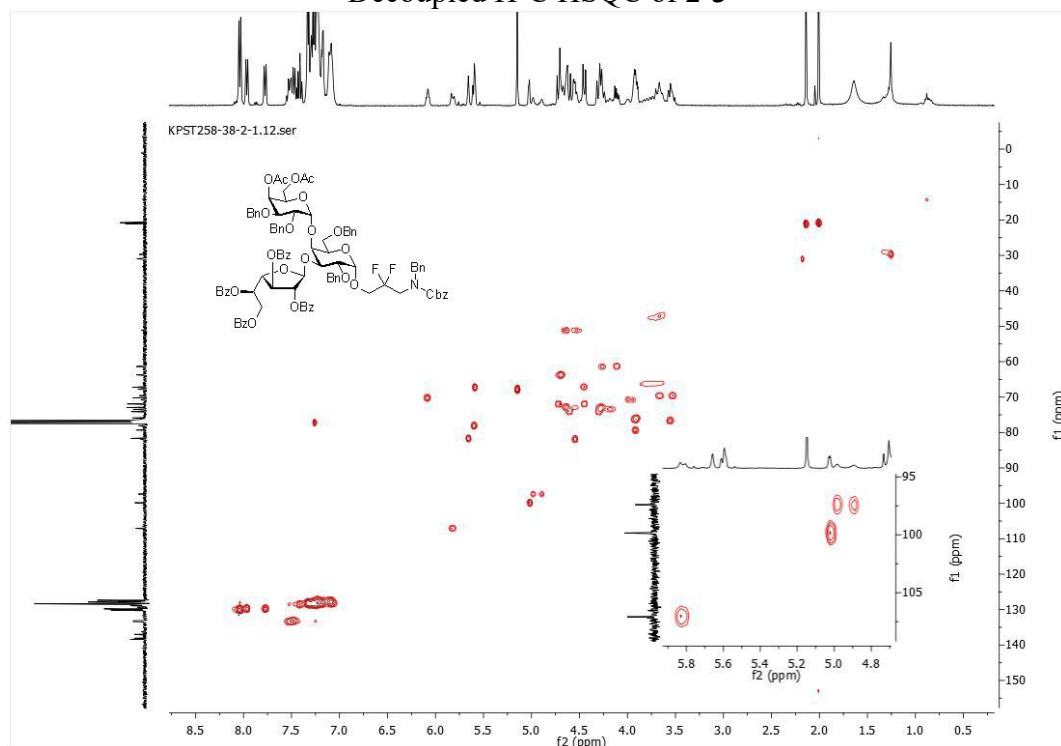

¹H NMR of 2-4

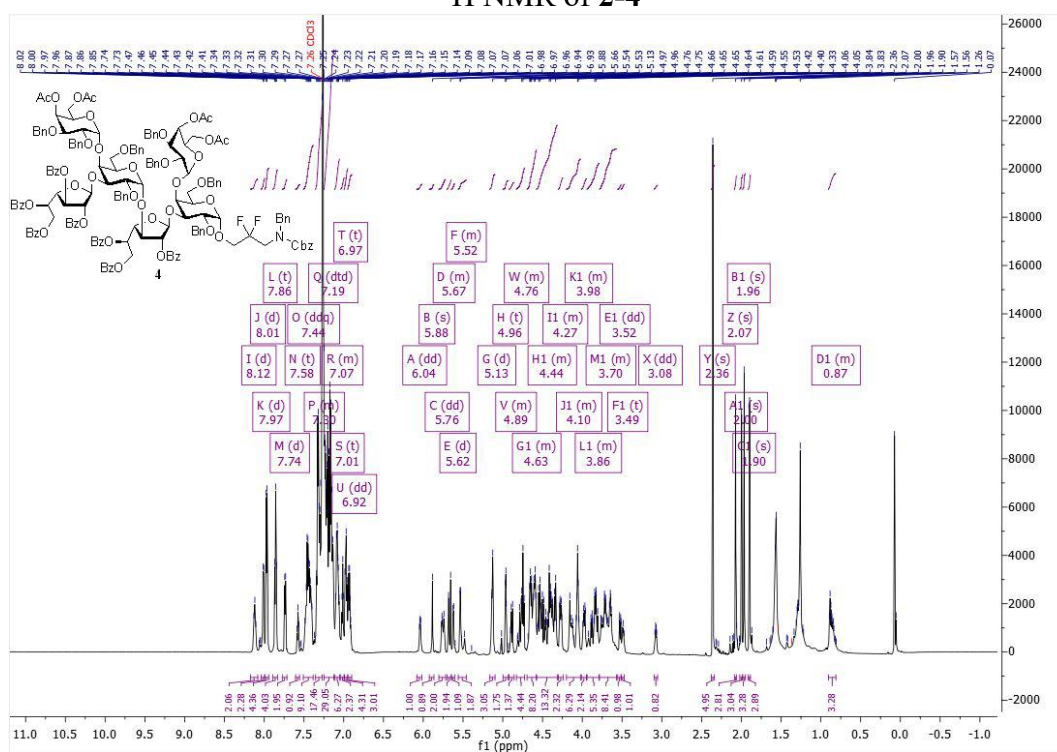

¹³C NMR of 2-4

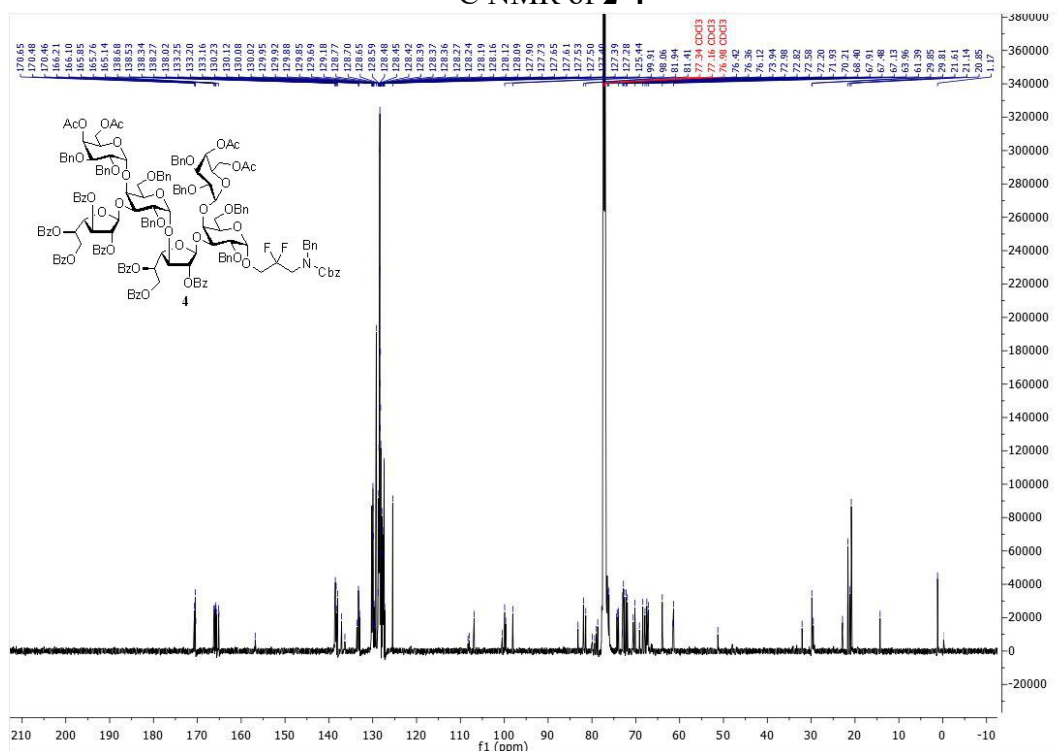

Decoupled H-C HSQC of **2-4**

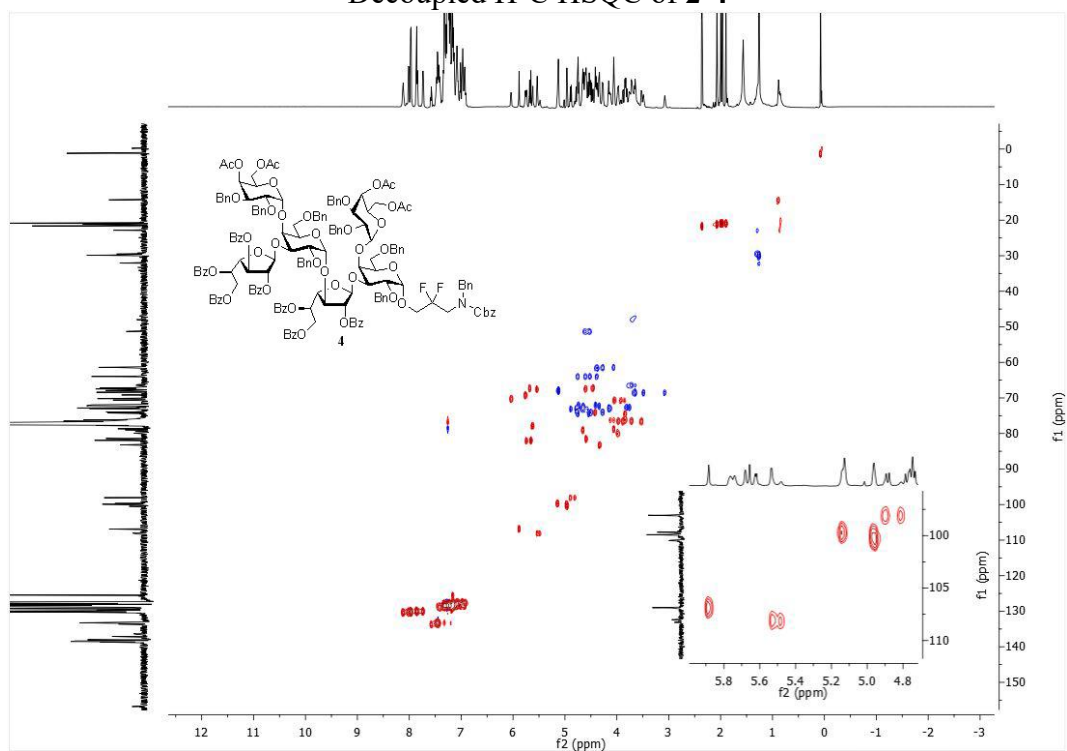

5 References

- (1) Coates, J. D.; Michaelidou, U.; Bruce, R. A.; O'Connor, S. M.; Crespi, J. N.; Achenbach, L. A. Ubiquity and Diversity of Dissimilatory (per)Chlorate-Reducing Bacteria. *Appl. Environ. Microbiol.* **1999**, *65* (12), 5234–5241.
- (2) Váradi, L.; Luo, J. L.; Hibbs, D. E.; Perry, J. D.; Anderson, R. J.; Orenge, S.; Groundwater, P. W. Methods for the Detection and Identification of Pathogenic Bacteria: Past, Present, and Future. *Chem. Soc. Rev.* **2017**, *46* (16), 4818–4832. <https://doi.org/10.1039/c6cs00693k>.
- (3) BEUCHAT, L. R. Pathogenic Microorganisms Associated with Fresh Produce. *J. Food Prot.* **1996**, *59* (2), 204–216. <https://doi.org/10.4315/0362-028X-59.2.204>.
- (4) Simon, L.; Gauvin, F.; Amre, D. K.; Saint-Louis, P.; Lacroix, J. Serum Procalcitonin and C-Reactive Protein Levels as Markers of Bacterial Infection: A Systematic Review and Meta-Analysis. *Clin. Infect. Dis.* **2004**, *39* (2), 206–217. <https://doi.org/10.1086/421997>.
- (5) Deisingh, A. K.; Thompson, M. Detection of Infectious and Toxigenic Bacteria. *Analyst* **2002**, *127* (5), 567–581. <https://doi.org/10.1039/b109895k>.
- (6) Yogesh, R. E.; Sekaran, V. COD Removal Efficiency of Activated Carbon Adsorbent for Tannery Wastewater. *Lancet* **2016**, *379* (9835), 18213–18215. [https://doi.org/10.1016/S0140-6736\(12\)60436-X](https://doi.org/10.1016/S0140-6736(12)60436-X).
- (7) Ligon, B. L. Penicillin: Its Discovery and Early Development. *Semin. Pediatr. Infect. Dis.* **2004**, *15* (1), 52–57. <https://doi.org/10.1053/j.spid.2004.02.001>.
- (8) Kotra, L. P.; Mobashery, S. β -Lactam Antibiotics, β -Lactamases and Bacterial Resistance. *Bull. Inst. Pasteur* **1998**, *96* (3), 139–150. [https://doi.org/10.1016/S0020-2452\(98\)80009-2](https://doi.org/10.1016/S0020-2452(98)80009-2).
- (9) Bush, K.; Bradford, P. A. Interplay between β -Lactamases and New β -Lactamase Inhibitors. *Nat. Rev. Microbiol.* **2019**, *17* (5), 295–306. <https://doi.org/10.1038/s41579-019-0159-8>.
- (10) Oates, J. A.; Wood, A. J. J.; Donowitz, G. R.; Mandell, G. L. Beta-Lactam

References

- Antibiotics. *N. Engl. J. Med.* **1988**, *318* (7), 419–426.
<https://doi.org/10.1056/NEJM198802183180706>.
- (11) Silver, L. L.; Bostian, K. A. Discovery and Development of New Antibiotics: The Problem of Antibiotic Resistance. *Antimicrob. Agents Chemother.* **1993**, *37* (3), 377–383. <https://doi.org/10.1128/AAC.37.3.377>.
- (12) Gerlach, J. H.; Kartner, N.; Bell, D. R.; Ling, V. Multidrug Resistance. *Cancer Surv.* **1986**, *5* (1), 25–46.
- (13) Bradley, G.; Juranka, P. F.; Ling, V. Mechanism of Multidrug Resistance. *Biochim. Biophys. Acta - Rev. Cancer* **1988**, *948* (1), 87–128.
[https://doi.org/10.1016/0304-419X\(88\)90006-6](https://doi.org/10.1016/0304-419X(88)90006-6).
- (14) Wright, G. D. Q&A: Antibiotic Resistance: Where Does It Come from and What Can We Do about It? *BMC Biol.* **2010**, *8* (1), 123. <https://doi.org/10.1186/1741-7007-8-123>.
- (15) Wright, G. D. Resisting Resistance: New Chemical Strategies for Battling Superbugs. *Chem. Biol.* **2000**, *7* (6). [https://doi.org/10.1016/S1074-5521\(00\)00126-5](https://doi.org/10.1016/S1074-5521(00)00126-5).
- (16) Spellberg, B.; Blaser, M.; Guidos, R. J.; Boucher, H. W.; Bradley, J. S.; Eisenstein, B. I.; Gerding, D.; Lynfield, R.; Reller, L. B.; Rex, J.; et al. Combating Antimicrobial Resistance: Policy Recommendations to Save Lives. *Clin. Infect. Dis.* **2011**, *52* (SUPPL. 5), S397–S428.
<https://doi.org/10.1093/cid/cir153>.
- (17) Mishra, R. P. N.; Oviedo-Orta, E.; Prachi, P.; Rappuoli, R.; Bagnoli, F. Vaccines and Antibiotic Resistance. *Curr. Opin. Microbiol.* **2012**, *15* (5), 596–602.
<https://doi.org/10.1016/j.mib.2012.08.002>.
- (18) Evrard, B.; Balestrino, D.; Dosgilbert, A.; Bouya-Gachancard, J. L. J.; Charbonnel, N.; Forestier, C.; Tridon, A. Roles of Capsule and Lipopolysaccharide O Antigen in Interactions of Human Monocyte-Derived Dendritic Cells and *Klebsiella Pneumoniae*. *Infect. Immun.* **2010**, *78* (1), 210–219.
<https://doi.org/10.1128/IAI.00864-09>.

- (19) Calderone, R. A.; Fonzi, W. A. Virulence Factors of *Candida Albicans*. *Trends Microbiol.* **2001**, *9* (7), 327–335. [https://doi.org/10.1016/S0966-842X\(01\)02094-7](https://doi.org/10.1016/S0966-842X(01)02094-7).
- (20) Kawai, T.; Akira, S. The Role of Pattern-Recognition Receptors in Innate Immunity: Update on Toll-like Receptors. *Nat. Immunol.* **2010**, *11* (5), 373–384. <https://doi.org/10.1038/ni.1863>.
- (21) Groh, V.; Bahram, S.; Bauer, S.; Herman, A.; Beauchamp, M.; Spies, T. Cell Stress-Regulated Human Major Histocompatibility Complex Class I Gene Expressed in Gastrointestinal Epithelium. *Proc. Natl. Acad. Sci. U. S. A.* **1996**, *93* (22), 12445–12450. <https://doi.org/10.1073/pnas.93.22.12445>.
- (22) Nih. Understanding the Immune System How It Works. *Heal. San Fr.* **2003**, 63. <https://doi.org/10.1097/00129804-200303000-00003>.
- (23) Powers, D. C.; Belshe, R. B. Effect of Age on Cytotoxic T Lymphocyte Memory as Well as Serum and Local Antibody Responses Elicited by Inactivated Influenza Virus Vaccine. *J. Infect. Dis.* **1993**, *167* (3), 584–592. <https://doi.org/10.1093/infdis/167.3.584>.
- (24) Geddes, A. M. The History of Smallpox. *Clin. Dermatol.* **2006**, *24* (3), 152–157. <https://doi.org/10.1016/j.clindermatol.2005.11.009>.
- (25) Willis, N. J. Edward Jenner and the Eradication of Smallpox. *Scott. Med. J.* **1997**, *42* (4), 118–121. <https://doi.org/10.1177/003693309704200407>.
- (26) Kaech, S. M.; Wherry, E. J.; Ahmed, R. Effector and Memory T-Cell Differentiation: Implications for Vaccine Development. *Nat. Rev. Immunol.* **2002**, *2* (4), 251–262. <https://doi.org/10.1038/nri778>.
- (27) Koff, W. C.; Burton, D. R.; Johnson, P. R.; Walker, B. D.; King, C. R.; Nabel, G. J.; Ahmed, R.; Bhan, M. K.; Plotkin, S. A. Accelerating Next-Generation Vaccine Development for Global Disease Prevention. *Science (80-.)*. **2013**, *340* (6136). <https://doi.org/10.1126/science.1232910>.
- (28) Tomcsik, J. Complex Structure of the Bacterial Capsule in the Genus *Bacillus*. *Experientia* **1951**, *7* (12), 459–460. <https://doi.org/10.1007/BF02168692>.

References

- (29) Guo, Y. Y.; Anderson, R.; McIver, J.; Gupta, R. K.; Siber, G. R. A Simple and Rapid Method for Measuring Unconjugated Capsular Polysaccharide (PRP) of Haemophilus Influenzae Type b in PRP-Tetanus Toxoid Conjugate Vaccine. *Biologicals* **1998**, *26* (1), 33–38. <https://doi.org/10.1006/biol.1997.0121>.
- (30) Musher, D. M.; Groover, J. E.; Watson, D. A.; Rodriguez-Barradas, M. C.; Baughn, R. E. IgG Responses to Protein-Conjugated Pneumococcal Capsular Polysaccharides in Persons Who Are Genetically Incapable of Responding to Unconjugated Polysaccharides. *Clin. Infect. Dis.* **1998**, *27* (6), 1487–1490. <https://doi.org/10.1086/515039>.
- (31) Black, S.; Shinefield, H.; Fireman, B.; Lewis, E.; Ray, P.; Hansen, J. R.; Elvin, L.; Ensor, K. M.; Hackell, J.; Siber, G.; et al. Efficacy, Safety and Immunogenicity of Heptavalent Pneumococcal Conjugate Vaccine in Children. *Pediatr. Infect. Dis. J.* **2000**, *19* (3), 187–195. <https://doi.org/10.1097/00006454-200003000-00003>.
- (32) Bonten, M. J. M.; Huijts, S. M.; Bolkenbaas, M.; Webber, C.; Patterson, S.; Gault, S.; Van Werkhoven, C. H.; Van Deursen, A. M. M.; Sanders, E. A. M.; Verheij, T. J. M.; et al. Polysaccharide Conjugate Vaccine against Pneumococcal Pneumonia in Adults. *N. Engl. J. Med.* **2015**, *372* (12), 1114–1125. <https://doi.org/10.1056/NEJMoa1408544>.
- (33) Berti, F.; Adamo, R. Antimicrobial Glycoconjugate Vaccines: An Overview of Classic and Modern Approaches for Protein Modification. *Chem. Soc. Rev.* **2018**, *47* (24), 9015–9025. <https://doi.org/10.1039/c8cs00495a>.
- (34) West, D. J.; Calandra, G. B. Vaccine Induced Immunologic Memory for Hepatitis B Surface Antigen: Implications for Policy on Booster Vaccination. *Vaccine* **1996**, *14* (11), 1019–1027. [https://doi.org/10.1016/0264-410X\(96\)00062-X](https://doi.org/10.1016/0264-410X(96)00062-X).
- (35) Alvarez, C. A.; Cobb, B. A. Purification of Capsular Polysaccharide Complex from Gram-Negative Bacteria. *Methods Mol. Biol.* **2019**, *1954*, 25–35. https://doi.org/10.1007/978-1-4939-9154-9_3.
- (36) Colombo, C.; Pitirollo, O.; Lay, L. Recent Advances in the Synthesis of

- Glycoconjugates for Vaccine Development. *Molecules* **2018**, *23* (7), 1712.
<https://doi.org/10.3390/molecules23071712>.
- (37) Geissner, A.; Anish, C.; Seeberger, P. H. Glycan Arrays as Tools for Infectious Disease Research. *Curr. Opin. Chem. Biol.* **2014**, *18* (1), 38–45.
<https://doi.org/10.1016/j.cbpa.2013.11.013>.
- (38) Peeters, C. C. A. M.; Tenbergen-Meekes, A. M.; Poolman, J. T.; Beurret, M.; Zegers, B. J. M.; Rijkers, G. T. Effect of Carrier Priming on Immunogenicity of Saccharide-Protein Conjugate Vaccines. *Infect. Immun.* **1991**, *59* (10), 3504–3510.
- (39) Anderson, P.; Pichichero, M. E.; Insel, R. A. Immunogens Consisting of Oligosaccharides from the Capsule of Haemophilus Influenzae Type b Coupled to Diphtheria Toxoid or the Toxin Protein CRM197. *J. Clin. Invest.* **1985**, *76* (1), 52–59. <https://doi.org/10.1172/JCI111976>.
- (40) Aguilar, J. C.; Rodríguez, E. G. Vaccine Adjuvants Revisited. *Vaccine* **2007**, *25* (19), 3752–3762. <https://doi.org/10.1016/j.vaccine.2007.01.111>.
- (41) Klaamas, K.; Held, M.; Wadström, T.; Lipping, A.; Kurtenkov, O. IgG Immune Response to Helicobacter Pylori Antigens in Patients with Gastric Cancer as Defined by ELISA and Immunoblotting. *Int. J. Cancer* **1996**, *67* (1), 1–5.
[https://doi.org/10.1002/\(SICI\)1097-0215\(19960703\)67:1<1::AID-IJC1>3.0.CO;2-0](https://doi.org/10.1002/(SICI)1097-0215(19960703)67:1<1::AID-IJC1>3.0.CO;2-0).
- (42) Hölemann, A.; Seeberger, P. H. Carbohydrate Diversity: Synthesis of Glycoconjugates and Complex Carbohydrates. *Curr. Opin. Biotechnol.* **2004**, *15* (6), 615–622. <https://doi.org/10.1016/j.copbio.2004.10.001>.
- (43) Seeberger, P. H. The Logic of Automated Glycan Assembly. *Acc. Chem. Res.* **2015**, *48* (5), 1450–1463. <https://doi.org/10.1021/ar5004362>.
- (44) Deng, S.; Yu, B.; Lou, Y.; Hui, Y. First Total Synthesis of an Exceptionally Potent Antitumor Saponin, OSW- 1. *J. Org. Chem.* **1999**, *64* (1), 202–208.
<https://doi.org/10.1021/jo981685c>.
- (45) Hewitt, M. C.; Snyder, D. A.; Seeberger, P. H. Rapid Synthesis of a

References

- Glycosylphosphatidylinositol-Based Malaria Vaccine Using Automated Solid-Phase Oligosaccharide Synthesis. *J. Am. Chem. Soc.* **2002**, *124* (45), 13434–13436. <https://doi.org/10.1021/ja027538k>.
- (46) Orgueira, H. A.; Bartolozzi, A.; Schell, P.; Litjens, R. E. J. N.; Palmacci, E. R.; Seeberger, P. H. Modular Synthesis of Heparin Oligosaccharides. *Chem. - A Eur. J.* **2003**, *9* (1), 140–169. <https://doi.org/10.1002/chem.200390009>.
- (47) Werz, D. B.; Seeberger, P. H. Total Synthesis of Antigen Bacillus Anthracis Tetrasaccharide - Creation of an Anthrax Vaccine Candidate. *Angew. Chemie - Int. Ed.* **2005**, *44* (39), 6315–6318. <https://doi.org/10.1002/anie.200502615>.
- (48) Yang, X.; Fu, B.; Yu, B. Total Synthesis of Landomycin A, a Potent Antitumor Angucycline Antibiotic. *J. Am. Chem. Soc.* **2011**, *133* (32), 12433–12435. <https://doi.org/10.1021/ja205339p>.
- (49) Yang, Y.; Martin, C. E.; Seeberger, P. H. Total Synthesis of the Core Tetrasaccharide of Neisseria Meningitidis Lipopolysaccharide, a Potential Vaccine Candidate for Meningococcal Diseases. *Chem. Sci.* **2012**, *3* (3), 896–899. <https://doi.org/10.1039/c1sc00804h>.
- (50) Wang, P.; Dong, S.; Shieh, J. H.; Peguero, E.; Hendrickson, R.; Moore, M. A. S.; Danishefsky, S. J. Erythropoietin Derived by Chemical Synthesis. *Science (80-.)*. **2013**, *342* (6164), 1357–1360. <https://doi.org/10.1126/science.1245095>.
- (51) Nie, S.; Li, W.; Yu, B. Total Synthesis of Nucleoside Antibiotic A201A. *J. Am. Chem. Soc.* **2014**, *136* (11), 4157–4160. <https://doi.org/10.1021/ja501460j>.
- (52) Wu, Y.; Xiong, D. C.; Chen, S. C.; Wang, Y. S.; Ye, X. S. Total Synthesis of Mycobacterial Arabinogalactan Containing 92 Monosaccharide Units. *Nat. Commun.* **2017**, *8*, 14851. <https://doi.org/10.1038/ncomms14851>.
- (53) Qin, C.; Schumann, B.; Zou, X.; Pereira, C. L.; Tian, G.; Hu, J.; Seeberger, P. H.; Yin, J. Total Synthesis of a Densely Functionalized Plesiomonas Shigelloides Serotype 51 Aminoglycoside Trisaccharide Antigen. *J. Am. Chem. Soc.* **2018**, *140* (8), 3120–3127. <https://doi.org/10.1021/jacs.8b00148>.
- (54) Yin, J.; Tian, G.; Qin, C.; Liu, Z.; Shen, D.; Zou, X.; Fu, J.; Hu, J.; Seeberger, P.

- Total Synthesis of the Helicobacter Pylori Serotype O2 O-Antigen α -(1 \rightarrow 2)- and α -(1 \rightarrow 3)-Linked Oligoglucosides. *Chem. Commun.* **2019**.
<https://doi.org/10.1039/C9CC07915G>.
- (55) Chaplin, M. F. I. Monosaccharides. *MASS Spectrom.* **1986**, *1*, 7.
- (56) Genicot-Joncour, S.; Poinas, A.; Richard, O.; Potin, P.; Rudolph, B.; Kloareg, B.; Helbert, W. The Cyclization of the 3, 6-Anhydro-Galactose Ring of β -Carrageenan Is Catalyzed by Two D-Galactose-2, 6-Sulfurylases in the Red Alga *Chondrus Crispus*. *Plant Physiol.* **2009**, *151* (3), 1609–1616.
- (57) Stick, R.; Williams, S. J. *Carbohydrates: The Essential Molecules of Life*; Elsevier, 2009. <https://doi.org/10.1016/B978-0-240-52118-3.X0001-4>.
- (58) Goodman, L. Neighboring-Group Participation in Sugars. In *Advances in Carbohydrate Chemistry*; Elsevier, 1967; Vol. 22, pp 109–175.
- (59) Crich, D. Mechanism of a Chemical Glycosylation Reaction. *Acc. Chem. Res.* **2010**, *43* (8), 1144–1153.
- (60) Mucha, E.; González Flórez, A. I.; Marianski, M.; Thomas, D. A.; Hoffmann, W.; Struwe, W. B.; Hahm, H. S.; Gewinner, S.; Schöllkopf, W.; Seeberger, P. H.; et al. Glycan Fingerprinting via Cold-Ion Infrared Spectroscopy. *Angew. Chemie - Int. Ed.* **2017**, *56* (37), 11248–11251. <https://doi.org/10.1002/anie.201702896>.
- (61) Mucha, E.; Marianski, M.; Xu, F. F.; Thomas, D. A.; Meijer, G.; von Helden, G.; Seeberger, P. H.; Pagel, K. Unravelling the Structure of Glycosyl Cations via Cold-Ion Infrared Spectroscopy. *Nat. Commun.* **2018**, *9* (1).
<https://doi.org/10.1038/s41467-018-06764-3>.
- (62) Mydock, L. K.; Demchenko, A. V. Mechanism of Chemical O-Glycosylation: From Early Studies to Recent Discoveries. *Org. Biomol. Chem.* **2010**, *8* (3), 497–510. <https://doi.org/10.1039/b916088d>.
- (63) Yu, B.; Sun, J. Glycosylation with Glycosyl N-Phenyltrifluoroacetimidates (PTFAI) and a Perspective of the Future Development of New Glycosylation Methods. *Chem. Commun.* **2010**, *46* (26), 4668–4679.
<https://doi.org/10.1039/c0cc00563k>.

References

- (64) Plante, O. J.; Andrade, R. B.; Seeberger, P. H. Synthesis and Use of Glycosyl Phosphates as Glycosyl Donors. *Org. Lett.* **1999**, *1* (2), 211–214.
- (65) Zhu, Y.; Yu, B. Characterization of the Isochromen-4-Yl-Gold(I) Intermediate in the Gold(I)-Catalyzed Glycosidation of Glycosyl Ortho-Alkynylbenzoates and Enhancement of the Catalytic Efficiency Thereof. *Angew. Chemie Int. Ed.* **2011**, *50* (36), 8329–8332. <https://doi.org/10.1002/anie.201103409>.
- (66) Tang, Y.; Li, J.; Zhu, Y.; Li, Y.; Yu, B. Mechanistic Insights into the Gold(I)-Catalyzed Activation of Glycosyl Ortho -Alkynylbenzoates for Glycosidation. *J. Am. Chem. Soc.* **2013**, *135* (49), 18396–18405. <https://doi.org/10.1021/ja4064316>.
- (67) Ehianeta, T. S.; Shen, D.; Xu, P.; Yu, B. Synthesis of Spirostanol Saponins via Gold(I)-catalyzed Glycosylation in the Presence of Ga(OTf)₃, In(OTf)₃, or HOTf. *Chinese J. Chem.* **2019**, *37* (8), 827–833. <https://doi.org/10.1002/cjoc.201900126>.
- (68) Das, R.; Mukhopadhyay, B. Chemical O-Glycosylations: An Overview. *ChemistryOpen* **2016**, *5* (5), 401–433. <https://doi.org/10.1002/open.201600043>.
- (69) Li, Y.; Yang, X.; Liu, Y.; Zhu, C.; Yang, Y.; Yu, B. Gold(I)-Catalyzed Glycosylation with Glycosyl Ortho-Alkynylbenzoates as Donors: General Scope and Application in the Synthesis of a Cyclic Triterpene Saponin. *Chem. - A Eur. J.* **2010**, *16* (6), 1871–1882. <https://doi.org/10.1002/chem.200902548>.
- (70) Li, Y.; Yang, Y.; Yu, B. An Efficient Glycosylation Protocol with Glycosyl Ortho-Alkynylbenzoates as Donors under the Catalysis of Ph₃PAuOTf. *Tetrahedron Lett.* **2008**, *49* (22), 3604–3608. <https://doi.org/10.1016/j.tetlet.2008.04.017>.
- (71) Li, T.; Liu, L.; Wei, N.; Yang, J. Y.; Chapla, D. G.; Moremen, K. W.; Boons, G. J. An Automated Platform for the Enzyme-Mediated Assembly of Complex Oligosaccharides. *Nat. Chem.* **2019**, *11* (3), 229–236. <https://doi.org/10.1038/s41557-019-0219-8>.
- (72) Xu, F. F.; Pereira, C. L.; Seeberger, P. H. 1,3-Dibromo-5,5-Dimethylhydantoin as Promoter for Glycosylations Using Thioglycosides. *Beilstein J. Org. Chem.* **2017**,

- 13, 1994–1998. <https://doi.org/10.3762/bjoc.13.195>.
- (73) Chatterjee, S.; Moon, S.; Hentschel, F.; Gilmore, K.; Seeberger, P. H. An Empirical Understanding of the Glycosylation Reaction. *J. Am. Chem. Soc.* **2018**, *140* (38), 11942–11953. <https://doi.org/10.1021/jacs.8b04525>.
- (74) Paulsen, H. Advances in Selective Chemical Syntheses of Complex Oligosaccharides. *Angew. Chemie Int. Ed. English* **1982**, *21* (3), 155–173. <https://doi.org/10.1002/anie.198201553>.
- (75) Szijártó, V.; Guachalla, L. M.; Hartl, K.; Varga, C.; Banerjee, P.; Stojkovic, K.; Kaszowska, M.; Nagy, E.; Lukasiewicz, J.; Nagy, G. Both Clades of the Epidemic KPC-Producing *Klebsiella Pneumoniae* Clone ST258 Share a Modified Galactan O-Antigen Type. *Int. J. Med. Microbiol.* **2016**, *306* (2), 89–98. <https://doi.org/10.1016/j.ijmm.2015.12.002>.
- (76) Marsh, J. W.; Mustapha, M. M.; Griffith, M. P.; Evans, D. R.; Ezeonwuka, C.; Pasculle, A. W.; Shutt, K. A.; Sundermann, A.; Ayres, A. M.; Shields, R. K.; et al. Evolution of Outbreak-Causing Carbapenem-Resistant *Klebsiella Pneumoniae* ST258 at a Tertiary Care Hospital over 8 Years. *MBio* **2019**, *10* (5). <https://doi.org/10.1128/mBio.01945-19>.
- (77) Del Puente, F.; Giacobbe, D. R.; Salsano, A.; Maraolo, A. E.; Ong, D. S. Y.; Yusuf, E.; Tutino, S.; Marchese, A.; Santini, F.; Viscoli, C. Epidemiology and Outcome of *Klebsiella Pneumoniae* Carbapenemase-Producing *Klebsiella Pneumoniae* (KPC-KP) Infections in Cardiac Surgery Patients: A Brief Narrative Review. *J. Chemother.* **2019**, 1–8. <https://doi.org/10.1080/1120009X.2019.1685794>.
- (78) Munoz-Price, L. S.; Poirel, L.; Bonomo, R. A.; Schwaber, M. J.; Daikos, G. L.; Cormican, M.; Cornaglia, G.; Garau, J.; Gniadkowski, M.; Hayden, M. K.; et al. Clinical Epidemiology of the Global Expansion of *Klebsiella Pneumoniae* Carbapenemases. *Lancet Infect. Dis.* **2013**, *13* (9), 785–796. [https://doi.org/10.1016/S1473-3099\(13\)70190-7](https://doi.org/10.1016/S1473-3099(13)70190-7).
- (79) Diago-Navarro, E.; Motley, M. P.; Ruiz-Peréz, G.; Yu, W.; Austin, J.; Seco, B. M. S.; Xiao, G.; Chikhalya, A.; Seeberger, P. H.; Fries, B. C. Novel, Broadly

References

- Reactive Anticapsular Antibodies against Carbapenem-Resistant *Klebsiella Pneumoniae* Protect from Infection. *MBio* **2018**, *9* (2).
<https://doi.org/10.1128/mBio.00091-18>.
- (80) Seeberger, P. H.; Pereira, C. L.; Khan, N.; Xiao, G.; Diago-Navarro, E.; Reppe, K.; Opitz, B.; Fries, B. C.; Witzenrath, M. A Semi-Synthetic Glycoconjugate Vaccine Candidate for Carbapenem-Resistant *Klebsiella Pneumoniae*. *Angew. Chemie Int. Ed.* **2017**, *56* (45), 13973–13978.
<https://doi.org/10.1002/anie.201700964>.
- (81) Rollenske, T.; Szijarto, V.; Lukasiewicz, J.; Guachalla, L. M.; Stojkovic, K.; Hartl, K.; Stulik, L.; Kocher, S.; Lasitschka, F.; Al-Saeedi, M.; et al. Cross-Specificity of Protective Human Antibodies against *Klebsiella Pneumoniae* LPS O-Antigen. *Nat. Immunol.* **2018**, *19* (6), 617–624.
<https://doi.org/10.1038/s41590-018-0106-2>.
- (82) Clarke, B. R.; Ovchinnikova, O. G.; Kelly, S. D.; Williamson, M. L.; Butler, J. E.; Liu, B.; Wang, L.; Gou, X.; Follador, R.; Lowary, T. L.; et al. Molecular Basis for the Structural Diversity in Serogroup O2-Antigen Polysaccharides in *Klebsiella Pneumoniae*. *J. Biol. Chem.* **2018**, *293* (13), 4666–4679.
<https://doi.org/10.1074/jbc.RA117.000646>.
- (83) Kelly, R. F.; Perry, M. B.; MacLean, L. L.; Whitfield, C. Structures of the O-Antigens of *Klebsiella* Serotypes O2 (2a,2e), O2 (2a,2e,2h), and O2 (2a,2f,2g), Members of a Family of Related D-Galactan O-Antigens in *Klebsiella* Spp. *J. Endotoxin Res.* **1995**, *2* (2), 131–140.
<https://doi.org/10.1177/096805199500200208>.
- (84) Schumann, B.; Parameswarappa, S. G.; Lisboa, M. P.; Kottari, N.; Guidetti, F.; Pereira, C. L.; Seeberger, P. H. Nucleophile-Directed Stereocontrol Over Glycosylations Using Geminal-Difluorinated Nucleophiles. *Angew. Chemie Int. Ed.* **2016**, *55* (46), 14431–14434. <https://doi.org/10.1002/anie.201606774>.
- (85) Hahm, H. S.; Hurevich, M.; Seeberger, P. H. Automated Assembly of Oligosaccharides Containing Multiple Cis-Glycosidic Linkages. *Nat. Commun.* **2016**, *7*, 12482.

- (86) Ágoston, K.; Kerékgyártó, J.; Hajkó, J.; Batta, G.; Lefeber, D. J.; Kamerling, J. P.; Vliegthart, J. F. G. Synthesis of Fragments of the Glycocalyx Glycan of the Parasite *Schistosoma Mansoni*. *Chem. - A Eur. J.* **2002**, *8* (1), 151–161. [https://doi.org/10.1002/1521-3765\(20020104\)8:1<151::AID-CHEM151>3.0.CO;2-C](https://doi.org/10.1002/1521-3765(20020104)8:1<151::AID-CHEM151>3.0.CO;2-C).
- (87) Saikam, V.; Dara, S.; Yadav, M.; Singh, P. P.; Vishwakarma, R. A. Dimethyltin Dichloride Catalyzed Regioselective Alkylation of Cis-1,2-Diols at Room Temperature. *J. Org. Chem.* **2015**, *80* (24), 11916–11925. <https://doi.org/10.1021/acs.joc.5b01898>.
- (88) Wang, S.; Meng, X.; Huang, W.; Yang, J. S. Influence of Silyl Protections on the Anomeric Reactivity of Galactofuranosyl Thioglycosides and Application of the Silylated Thiogalactofuranosides to One-Pot Synthesis of Diverse β -D-Oligogalactofuranosides. *J. Org. Chem.* **2014**, *79* (21), 10203–10217. <https://doi.org/10.1021/jo5018684>.
- (89) Yu, B.; Tao, H. Glycosyl Trifluoroacetimidates. Part 1: Preparation and Application as New Glycosyl Donors. *Tetrahedron Lett.* **2001**, *42* (12), 2405–2407. [https://doi.org/10.1016/S0040-4039\(01\)00157-5](https://doi.org/10.1016/S0040-4039(01)00157-5).
- (90) Zhang, Y.; Lu, P.; Pan, Z.; Zhu, Y.; Ma, J.; Zhong, X.; Dong, W.; Lu, C.; Yao, H. SssP1, a *Streptococcus Suis* Fimbria-like Protein Transported by the SecY2/A2 System, Contributes to Bacterial Virulence. *Appl. Environ. Microbiol.* **2018**, *84* (18). <https://doi.org/10.1128/AEM.01385-18>.
- (91) Yu, H.; Jing, H.; Chen, Z.; Zheng, H.; Zhu, X.; Wang, H.; Wang, S.; Liu, L.; Zu, R.; Luo, L.; et al. Human *Streptococcus Suis* Outbreak, Sichuan, China. *Emerg. Infect. Dis.* **2006**, *12* (6), 914–920. <https://doi.org/10.3201/eid1206.051194>.
- (92) Huang, Y. T.; Teng, L. J.; Ho, S. W.; Hsueh, P. R. *Streptococcus Suis* Infection. *J. Microbiol. Immunol. Infect.* **2005**, *38* (5), 306–313. <https://doi.org/10.4161/viru.28595>.
- (93) Roy, D.; Auger, J. P.; Segura, M.; Fittipaldi, N.; Takamatsu, D.; Okura, M.; Gottschalk, M. Role of the Capsular Polysaccharide as a Virulence Factor for *Streptococcus Suis* Serotype 14. *Can. J. Vet. Res.* **2015**, *79* (2), 141–146.

References

- (94) Gottschalk, M.; Segura, M. The Pathogenesis of the Meningitis Caused by *Streptococcus Suis*: The Unresolved Questions. *Vet. Microbiol.* **2000**, *76* (3), 259–272. [https://doi.org/10.1016/S0378-1135\(00\)00250-9](https://doi.org/10.1016/S0378-1135(00)00250-9).
- (95) Goyette-Desjardins, G.; Auger, J. P.; Xu, J.; Segura, M.; Gottschalk, M. *Streptococcus Suis*, an Important Pig Pathogen and Emerging Zoonotic Agent—an Update on the Worldwide Distribution Based on Serotyping and Sequence Typing. *Emerg. Microbes Infect.* **2014**, *3* (1), 1–20. <https://doi.org/10.1038/emi.2014.45>.
- (96) Morrison, M. J.; Imperiali, B. The Renaissance of Bacillosamine and Its Derivatives: Pathway Characterization and Implications in Pathogenicity. *Biochemistry* **2014**, *53* (4), 624–638. <https://doi.org/10.1021/bi401546r>.
- (97) Goyette-Desjardins, G.; Vinogradov, E.; Okura, M.; Takamatsu, D.; Gottschalk, M.; Segura, M. *Streptococcus Suis* Serotype 3 and Serotype 18 Capsular Polysaccharides Contain Di-N-Acetyl-Bacillosamine. *Carbohydr. Res.* **2018**, *466*, 18–29. <https://doi.org/10.1016/j.carres.2018.07.003>.
- (98) Dasgupta, S.; Pramanik, K.; Mukhopadhyay, B. Oligosaccharides through Reactivity Tuning: Convergent Synthesis of the Trisaccharides of the Steroid Glycoside Sokodoside B Isolated from Marine Sponge *Erylus Placenta*. *Tetrahedron* **2007**, *63* (50), 12310–12316. <https://doi.org/10.1016/j.tet.2007.09.072>.
- (99) Ibatullin, F. M.; Selivanov, S. I.; Shavva, A. G. A General Procedure for Conversion of S-Glycosyl Isothiourea Derivatives into Thioglycosides, Thiooligosaccharides and Glycosyl Thioesters. *Synthesis (Stuttg.)* **2001**, *2001* (3), 419–422. <https://doi.org/10.1055/s-2001-835058>.
- (100) Calosso, M.; Tambutet, G.; Charpentier, D.; St-Pierre, G.; Vaillancourt, M.; Bencheqroun, M.; Gratton, J. P.; Prévost, M.; Guindon, Y. Acyclic Tethers Mimicking Subunits of Polysaccharide Ligands: Selectin Antagonists. *ACS Med. Chem. Lett.* **2014**, *5* (9), 1054–1059. <https://doi.org/10.1021/ml500266x>.
- (101) Traboni, S.; Bedini, E.; Giordano, M.; Iadonisi, A. Three Solvent-Free Catalytic Approaches to the Acetal Functionalization of Carbohydrates and Their

- Applicability to One-Pot Generation of Orthogonally Protected Building Blocks. *Adv. Synth. Catal.* **2015**, *357* (16–17), 3562–3572. <https://doi.org/10.1002/adsc.201500745>.
- (102) Toth, I.; Dekany, G.; Kellam, B. Oligosaccharide Synthesis. US6573337, 2003.
- (103) Dureau, R.; Legentil, L.; Daniellou, R.; Ferrières, V. Two-Step Synthesis of per-O-Acetylfuranoses: Optimization and Rationalization. *J. Org. Chem.* **2012**, *77* (3), 1301–1307. <https://doi.org/10.1021/jo201913f>.
- (104) Bai, Y.; Lowary, T. L. 2,3-Anhydrosugars in Glycoside Bond Synthesis. Application to α -D-Galactofuranosides. *J. Org. Chem.* **2006**, *71* (26), 9658–9671. <https://doi.org/10.1021/jo061713o>.
- (105) Bordoni, A.; De Lederkremer, R. M.; Marino, C. Synthesis of 5-Deoxy- β -d-Galactofuranosides as Tools for the Characterization of β -d-Galactofuranosidases. *Bioorganic Med. Chem.* **2010**, *18* (14), 5339–5345. <https://doi.org/10.1016/j.bmc.2010.05.038>.
- (106) Janczuk, A. J.; Zhang, W.; Andreana, P. R.; Warrick, J.; Wang, P. G. The Synthesis of Deoxy- α -Gal Epitope Derivatives for the Evaluation of an Anti- α -Gal Antibody Binding. *Carbohydr. Res.* **2002**, *337* (14), 1247–1259. [https://doi.org/10.1016/S0008-6215\(02\)00159-3](https://doi.org/10.1016/S0008-6215(02)00159-3).
- (107) Zhu, S. Y.; Yang, J. S. Synthesis of Tetra- and Hexasaccharide Fragments Corresponding to the O-Antigenic Polysaccharide of *Klebsiella Pneumoniae*. *Tetrahedron* **2012**, *68* (20), 3795–3802. <https://doi.org/10.1016/j.tet.2012.03.074>.
- (108) Karst, N.; Jacquinet, J. C. Chemical Synthesis of β -D-GlcA(2SO₄)-(1→3)-D-GalpNAc(6SO₄), the Disaccharide Repeating Unit of Shark Cartilage Chondroitin Sulfate D, and of Its Methyl β -D-Glycoside Derivative. *J. Chem. Soc. Perkin Trans. 1* **2000**, No. 16, 2709–2717. <https://doi.org/10.1039/b002835p>.
- (109) Karst, N.; Jacquinet, J. C. Stereocontrolled Total Syntheses of Shark Cartilage Chondroitin Sulfate D-Related Tetra- and Hexasaccharide Methyl Glycosides. *European J. Org. Chem.* **2002**, No. 5, 815–825. [https://doi.org/10.1002/1099-0690\(200203\)2002:5<815::AID-EJOC815>3.0.CO;2-A](https://doi.org/10.1002/1099-0690(200203)2002:5<815::AID-EJOC815>3.0.CO;2-A).

References

- (110) Maza, S.; Mar Kayser, M.; MacChione, G.; López-Prados, J.; Angulo, J.; De Paz, J. L.; Nieto, P. M. Synthesis of Chondroitin/Dermatan Sulfate-like Oligosaccharides and Evaluation of Their Protein Affinity by Fluorescence Polarization. *Org. Biomol. Chem.* **2013**, *11* (21), 3510–3525. <https://doi.org/10.1039/c3ob40306h>.
- (111) Yin, J.; Hu, J.; Liu, Z.; Qin, C. Chemical Synthesis Method of Bacillus Pyocyaneus 011 Serotype O Antigen Oligosaccharide. CN109627270 (A).
- (112) Andersen, S. M.; Heuckendorff, M.; Jensen, H. H. 3-(Dimethylamino)-1-Propylamine: A Cheap and Versatile Reagent for Removal of Byproducts in Carbohydrate Chemistry. *Org. Lett.* **2015**, *17* (4), 944–947. <https://doi.org/10.1021/acs.orglett.5b00041>.
- (113) Chen, C. T.; Weng, S. S.; Kao, J. Q.; Lin, C. C.; Jan, M. D. Stripping off Water at Ambient Temperature: Direct Atom-Efficient Acetal Formation between Aldehydes and Diols Catalyzed by Water-Tolerant and Recoverable Vanadyl Triflate. *Org. Lett.* **2005**, *7* (15), 3343–3346. <https://doi.org/10.1021/ol051178z>.
- (114) van der Es, D.; Groenia, N. A.; Laverde, D.; Overkleeft, H. S.; Huebner, J.; van der Marel, G. A.; Codée, J. D. C. Synthesis of E. Faecium Wall Teichoic Acid Fragments. *Bioorganic Med. Chem.* **2016**, *24* (17), 3893–3907. <https://doi.org/10.1016/j.bmc.2016.03.019>.