

# Print-A-Sketch: A Handheld Printer for Physical Sketching of Circuits and Sensors on Everyday Surfaces

Narjes Pourjafarian<sup>1</sup>, Marion Koelle<sup>1</sup>, Fjolla Mjaku<sup>1</sup>, Paul Strohmeier<sup>1,2</sup>, Jürgen Steimle<sup>1</sup>

<sup>1</sup>Saarland University, Saarland Informatics Campus, Saarbrücken, Germany.

<sup>2</sup>Max Planck Institute for Informatics, Saarland Informatics Campus, Saarbrücken, Germany.

<sup>1</sup>{lastname}@cs.uni-saarland.de, <sup>2</sup>paul.strohmeier@mpi-inf.mpg.de

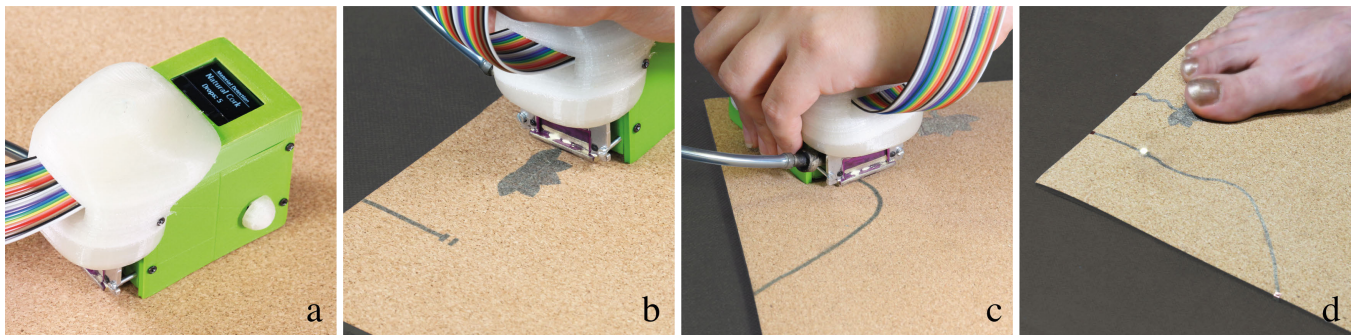

**Figure 1:** *Print-A-Sketch* uses a handheld printer (a) to create high-resolution conductive traces and circuits on everyday materials (b). It integrates the expressiveness of sketching with computational support (c), for direct fabrication of interactive interfaces on everyday surfaces and objects, such as this yoga mat (d).

## ABSTRACT

We present *Print-A-Sketch*, an open-source handheld printer prototype for sketching circuits and sensors. *Print-A-Sketch* combines desirable properties from free-hand sketching and functional electronic printing. Manual human control of large strokes is augmented with computer control of fine detail. Shared control of *Print-A-Sketch* supports sketching interactive interfaces on everyday objects – including many objects with materials or sizes which otherwise are difficult to print on. We present an overview of challenges involved in such a system and show how these can be addressed using context-aware, dynamic printing. Continuous sensing ensures quality prints by adjusting inking-rate to hand movement and material properties. Continuous sensing also enables the print to adapt to previously printed traces to support incremental and iterative sketching. Results show good conductivity on many materials and high spatial precision, supporting on-the-fly creation of functional interfaces.

## CCS CONCEPTS

• Human-centered computing → Interaction devices.



This work is licensed under a Creative Commons Attribution-NonCommercial International 4.0 License.

CHI '22, April 29-May 5, 2022, New Orleans, LA, USA

© 2022 Copyright held by the owner/author(s).

ACM ISBN 978-1-4503-9157-3/22/04.

<https://doi.org/10.1145/3491102.3502074>

## KEYWORDS

Fabrication, prototyping, printed electronics, conductive inkjet printing, sketching interfaces, new materials

## ACM Reference Format:

Narjes Pourjafarian<sup>1</sup>, Marion Koelle<sup>1</sup>, Fjolla Mjaku<sup>1</sup>, Paul Strohmeier<sup>1,2</sup>, Jürgen Steimle<sup>1</sup>. 2022. *Print-A-Sketch: A Handheld Printer for Physical Sketching of Circuits and Sensors on Everyday Surfaces*. In *CHI Conference on Human Factors in Computing Systems (CHI '22)*, April 29-May 5, 2022, New Orleans, LA, USA. ACM, New York, NY, USA, 17 pages. <https://doi.org/10.1145/3491102.3502074>

## 1 INTRODUCTION

Sketching in hardware (e.g.: [34, 50]) is becoming increasingly important for designing interactive objects that are embedded in our environment. Sketching in hardware captures not only the look and feel of such an object, but also how one might interact with it [20]. If this hardware sketch is created directly on the object where it will be used, effects of the object's affordances and physical environment on the interaction can also be experienced. Like physical sketching with pen and paper, situated sketching in hardware is usually a practice based on physical craft and skill, such as paperwork [50], textile crafts [19, 24, 29], or body art [47, 63].

Manual methods support expressive and creative design (e.g.: [2, 15]). However, they come with limitations in terms of both fabrication speed and precision: manual processes are poorly suited for interfacing with the miniature world of discrete components and embedded circuits. Printing, on the other hand, can be used to create complex [41] and high-resolution [18] electronics, and do so rapidly [26]. However, printing lacks the expressive and exploratory nature of hand-held sketching methods.

Combining desirable properties from both approaches, we present *Print-A-Sketch*, a handheld digital printer for rapid free-hand sketching of high resolution electrical interfaces. *Print-A-Sketch* is designed to support free-hand sketching practices while providing the high resolution and detail of a piezo-inkjet printhead for added precision and for interfacing with existing electrical components. In addition to the ability of printing conductive traces, *Print-A-Sketch* is also augmented with a pair of visual sensors for sensing the print context. This information can be used to continuously adjust the printing parameters to free-hand motion, pre-existing sketch elements, as well as the material properties of the target material.

This paper makes three primary contributions:

**1) Conductive handheld printing:** We present the first handheld printer for in-situ design and fabrication of customized circuits and sensors on existing objects. We demonstrate a) how to print high-resolution conductive structures with a readily available inkjet printhead on a wide array of materials and b) how to control the printhead in real-time, including detailed print parameters, using a commodity Arduino microcontroller platform. By open-sourcing the printer controller (hardware schematic and firmware for controlling the printhead), we envision this work to also make a practical contribution to the maker community. Evaluation results show good conductivity on many materials (e.g., various types of paper and cardboard, textiles, plywood, and stoneware) with sheet resistance ranging from  $0.036 \Omega/\square$  to  $29.6 \Omega/\square$ .

**2) Dynamic, context-aware handheld printing:** We propose to continuously integrate printing and sketching. To this end, the handheld printer is context-aware: it continuously monitors how it is being moved on a surface, including its speed and relative position, using an optical motion sensor; furthermore, it detects patterns that were printed earlier with a wide-angle miniature camera. This contextual information allows the system to dynamically adapt print patterns in real-time with  $<0.5$  mm precision. This opens up a novel hybrid design space where sketching and printing unify in one integrated task. We provide a conceptual overview of solution strategies and basic operating principles, and present a working implementation.

**3) Interaction techniques for on the fly design and fabrication of circuits and sensors:** We explore the novel opportunities of interactions that integrate manual sketching with dynamic high-resolution printing. *Print-A-Sketch* offers techniques for printing different types of traces, such as serpentine conductors or footprints, for creating functional electronic components, and for adding high-resolution shapes and patterns. By detecting and dynamically adapting to prior printed patterns, the system can automatically connect to existing traces or pins, avoid short-circuits, route around obstacles, but also scan & print existing elements. Built-in measurement with 98% accuracy helps the user to print elements of defined length, parallel lines and precise angles. Finally, integrating with existing components is near seamless, as optical sensing enables generating of IC footprints on-the-fly.

In this paper, after discussing related work, we first present an overview of the three main challenges of free-hand sketching with a handheld printer. These relate to the irregular nature of human motion, the iterative nature of sketching, and interactions between print-quality and various material. After presenting the

implementation we discuss each challenge separately. We then conclude with example applications and demonstrations of *Print-A-Sketch* in use. With exception of Figure 1, Figure 21, and materials samples, all photographs used in this paper can be viewed as videos in the accompanying video submission. Video demonstrations are organized in the same order as the figures in the paper.

## 2 RELATED WORK

Our contribution builds on prior work on fabrication of electronic circuits, in-place and interactive fabrication, and sketching interfaces.

### 2.1 Fabricating Electronic Circuits

**2.1.1 Printed Electronics.** Conventional approaches for fabricating customised interfaces with printed electronics include inkjet printing [5, 25, 26, 40], screen printing [41], and hydrography [18]. Recent advances in fabrication techniques allow to more easily deploy new interfaces in everyday environments. These methods and techniques consist of applying sensors and actuators over existing elements and objects while maintaining their original form-factor. For instance, they allow to deploy interfaces to furniture, household items, and textiles e.g., by attaching a functional sticker [6], or ironing-on a functional patch [58], as well as bringing interfaces to more flexible and sensitive surfaces such as skin [47]. They can even enhance architectural structures, for instance by spraying functional graffiti [65].

**2.1.2 Sketching Electronics.** Sketches are traditionally delivered physically on paper, however almost any medium is possible: HCI has a long tradition of exploring sketches that are spatially integrated within the real-world [60]. While a product or graphical design can be sketched with pencil on paper, sketching an interactive product requires not only implementation of its static look, but also its dynamic behavior [20]. This means that electronic systems need to be sketched as functional devices. This process is typically referred to as sketching in hardware. Mellis et al. describe their approach to sketching in hardware as an Untoolkit [34]. Their strategy is to provide tools and techniques that allow existing components and materials to be used in new ways, rather than designing high-level components as kits such like the Phidgets system [22]. Follow-up work married this approach with traditional craft. For example Qi extended this work by combining it with traditional papercraft [50]; her work has led to the successful Chibitronics platform [7]. Buechley and Perner-Wilson extend the idea of sketching in hardware to textiles [3]. Together with Satomi, they presented a Kit of no parts which shows how to build electrical prototypes from a diverse palette of craft materials [44]. To present the support of digital design in creation of functional circuits, researchers introduced several design tools [33, 51, 70]. While these approaches enable incremental and iterative sketching of interactive electronics in a much broader range of settings than traditionally possible, the fidelity of the resulting pieces is limited to what can be manually fabricated.

*Print-A-Sketch* combines the expressiveness of *sketching*, with the ability of *printing* to deliver high-precision elements at reproducible quality in a *hand-held* printer.

## 2.2 In-place and Interactive Fabrication

There is a variety of objects and surfaces that prove challenging: some objects are very large (e.g., furniture) or immobile (e.g., windows or doors), which makes it difficult to transport them. Other objects are meaningful in-context (e.g., because of their orientation or location with respect to the environment) which causes their design context to be lost when they are moved elsewhere. As a result, it is desirable to be able to fabricate directly on objects and in-place without the need of moving them or transporting them out of their respective context. Wessely et al. [65] created sprayable interfaces, which provide a great flexibility in terms of the geometry and scale of deployment. Stemasov et al. [57] demonstrated in-place adaptation of the mixed reality model and Roumen et al. [54] presented 3D printing as a solution for fabrication on the go. In-place fabrication is common in eTextile research, as most textile craft methods are intrinsically in-place [19, 21, 24]. Moreover, these methods have been extended by printing directly on the body and creating body-worn accessories [8, 17, 47].

Transition to software-based fabrication and design tools moves designers closer to screens and distances them from their work piece. Interactive fabrication addresses this issue by allowing real-time manipulation of a fabrication device [66]. As an example, FreeD [71] uses a handheld milling tool to sculpt and carve 3D models with computer supported guidance. Other approaches leverage customised tools for interactive fabrication of laser cut objects [36], making 3D models [42, 43], creating e-textiles [29], and more recently around the body [8, 16, 17, 47].

*Print-A-Sketch* takes up the idea of interactively adjusting to-be-fabricated designs in real-time, and presents the first handheld printer for in-place fabrication of interactive electronic interfaces.

## 2.3 Sketching Interfaces

Sketching is a common way of manifesting, sharing and discussing ideas (e.g.: [52]). However, it requires a certain level of manual skill. To make sketching more accessible a variety of sketching interfaces have been developed which are used to improve the fidelity of rough sketches. For example, SILK can be used to add interactive behavior to simple line-drawn interface elements [30], while [67] corrects digitally drawn lines, to make the sketch better match a predefined template.

Another approach is providing visual or tactile guidance during the sketching process to support users in creating better sketches. For example, Illumipaper [28] and Penlight [56] can be used to highlight target areas, similarly Exoskin [17] creates visual guides for on-body fabrication and BodyStylus [47] uses visual indicators to support creating on-body interfaces.

Unlike visual guides, tactile guides are only experienced while actively sketching. For example, [68] actuates a pen by magnetically attracting it to positions using a permanent magnet. Langerak et al. show how using an electromagnet can create variable force, and investigate algorithms for minimizing tracing errors [31, 32]. Soheil et al. use friction based haptic guides in Phasking Interfaces [27] to outline how the sketching process can be shaped by shared control between user and system.

When sketching with a pencil, one might switch between soft and hard tips, or adjust the angle to produce the desired stroke.

This idea can also be supported by sketching tools, for example, automatically providing software multi-stroke for shading [67]. FlexStylus takes a different route and allows adjusting parameters like stroke-width or color based on how a digital pen makes contact with a display [14]. BodyStylus presents a pen which can automatically retract the inking element, to switch between inking and non-inking states [47]. Klamka et al. presented a prototyping tool based on manually switching between tool-tips for different tasks.

*Print-A-Sketch* expands upon these ideas. By selectively activating print nozzles, *Print-A-Sketch* can simulate a multi-tooltip tool. Such a simulated multi-tip tool can also be used to counteract user error, providing an alternative to tactile guides.

## 3 SKETCHING WITH A HANDHELD PRINTER

An artist might sketch a painting with a pencil, switch to a large soft brush for painting the general structure and switch back to a tool with a finer tip for details, or may use ruler or mask to create desired pattern. For this artist, the ultimate tool might be one that changes the properties of its tip or selectively dispenses paint in a desired pattern, as required by the task at hand. Such a dynamic tool would also be invaluable for sketching in hardware. It would allow the designer to draw thick leads for connecting power-traces, thin lines for connecting control signals to fine-pitched integrated circuits (ICs), as well as decorative lines and custom patterns. With *Print-A-Sketch* we demonstrate that a commercial printhead can be used to implement such a dynamic tool. Integrated in a handheld tool, the printhead can be used for sketching electrical interfaces on the objects and surfaces around us, supporting the expressivity of human motion, while providing the precision and detail required for interfacing with commercial electronics.

However, a conventional printhead operates in a relatively controlled environment. Printhead designs typically make a number of assumptions. For example, printers dispense ink on a controlled surface – typically a sheet of paper. The image to be printed is not modified once the print has started. The printhead moves with a known, fixed, speed. All aspects of using a printhead for free-hand sketching on everyday objects break these assumptions.

Therefore, this vision creates a number of challenges. (1) **Free-hand** sketching comes with hand movement. Our hands move with varying speed, they do not always move in straight lines, they might shake or shiver. This is a problem not only for printing small high-detail features, such as IC footprints, but also for ensuring constant and continuous dispensing of ink. (2) **Sketching is incremental and iterative** and needs to support spontaneous decision making; but printing iteratively can easily lead to misaligned sections, or additions which break existing functionality. Finally, (3) **everyday objects and surface** come in many materials; the amount of ink required for a conductive trace can change from material to material.

To address these challenges we suggest that a handheld printing device needs to be paired with appropriate sensing capabilities. This can then support dynamic control, where the printing process is continuously adjusted in real-time to contextual factors (Figure 2). Relevant context includes a) the current position of the device and its movement, to compensate for the variations of hand movement,

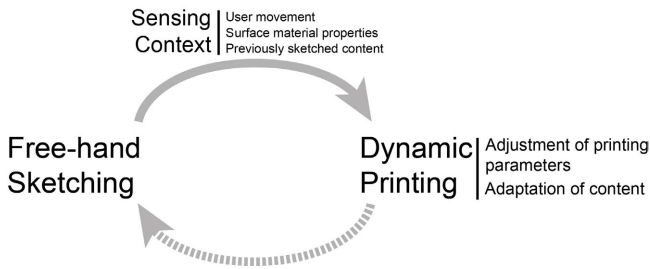

**Figure 2: Free-hand sketching and dynamic printing are intertwined: Sketching is done by printing, printing requires sketching. This tight coupling of printing and sketching requires continuous sensing of hand-movements to ensure consistent quality of resulting prints. While adapting to free-hand movement, other information such as previously sketched traces or substrate material is used to contextually adapt the print.**

b) existing patterns on a surface, so designs can be modified on-the-fly to accommodate any previously sketched content, and c) the material properties of the surface, such that ink dispensing can be adjusted for high-quality results. We do so by example of *Print-A-Sketch*, a prototype handheld printer consisting of a Xaar piezoelectric printhead with 128 nozzles, which are complemented by two optical sensors for detecting movement, materials and previously sketched designs (Figure 3).

In the next section, we present the implementation of *Print-A-Sketch* and detail on how the printhead is paired with sensing technology. Then we discuss how *Print-A-Sketch* addresses the three main challenges and present novel ways of sketching in hardware.

## 4 IMPLEMENTATION

*Print-A-Sketch* is designed around a flexible, hackable, high resolution inkjet printhead, paired with two visual sensors capable of detecting user movement, surface visual texture and material properties (Figure 3). Here we first discuss conductive printing, then sensing and finally the user interface for controlling *Print-A-Sketch*.

### 4.1 Conductive Printing in a Handheld Form Factor

**Piezoelectric Inkjet Printhead.** *Print-A-Sketch* makes use of *piezoelectric* inkjet technology for printing conductive circuits. While there is a range of ready-made compact, handheld *thermal* inkjet printers (e.g., Prinker [49], COLOP e-mark [9]) commercially available, they have undesirable effects on conductive inks. This issue is caused by their operating principle where the ink is heated, up to the point where it vaporizes and expands out of the nozzle. Heating functional materials (e.g., silver nano-particle ink) may lead to degeneration and loss of the desired functionality, which is a known issue in Material Science research [10, 26]. In contrast, piezoelectric printheads create patterns of expansion and contraction to jet the ink out of the nozzle in response to an electric impulse. Hence, they can work with a wider range of inks such as electro-conductive ink [13]. For this reason, we decided for a custom setup featuring

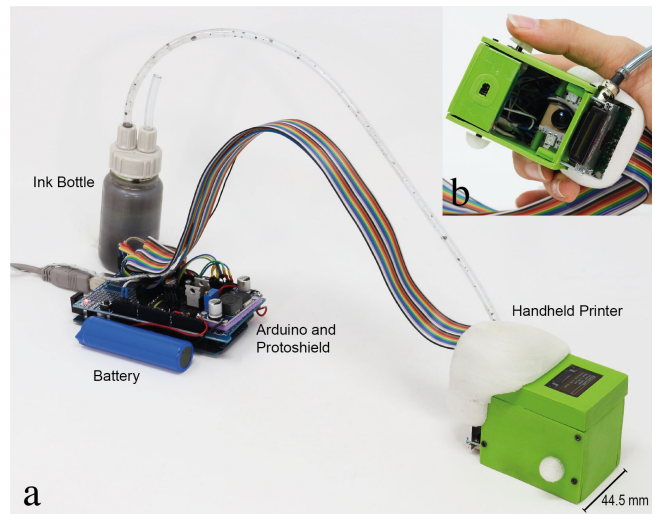

**Figure 3: (a) The hardware setup includes the handheld printer, conductive ink, Arduino Mega and Protoshield. (b) Bottom view, revealing integrated optical flow sensor and RGB camera.**

a Xaar 128 piezoelectric printhead (Xaar plc, approx. 220-240\$). With its 16.5 mm printhead, Xaar 128 has a conveniently small form factor (37.2 x 11.3 x 40.8 mm). It is lightweight (15.5 g) and able to function in various orientations, which makes it suitable for printing on diverse surfaces and geometries. In addition, it allows for high resolution prints (200 x 200 dpi); an important factor for printing cohesive, functional circuits. We use the integrated control circuitry of the printhead for low-level adjustment and tuning of the printing parameters [46]<sup>1</sup>.

**Driver Board and Firmware.** All electrical components are assembled on an Arduino Protoshield to ease replication (Figure 3). The Protoshield provides high voltage (35 V) to power the printhead using a rechargeable battery (3.7V, 2200mAh), and links up the printhead with an Arduino. The Arduino also controls the power up and power down sequencing (cf., Tables 6.3 and 6.4 in [46]) which is essential for the printhead to function. The custom firmware is written in C++ and deployed on an Arduino Mega. It controls low-level parameters of the printhead and samples the data from sensors. Print data and nozzle firing parameters are updated based on sensor data and sent to the printhead using SPI. The circuit diagram of our hardware setup, and firmware code for controlling the printhead are made available open-source.<sup>2</sup>

**Conductive Ink.** Selecting functional inks that are suitable to be printed with a *piezoelectric inkjet printhead* is challenging, because the ink's composition and viscosity needs to be compatible with the printhead (for our model below 12 cps). Simultaneously, the inks should be highly conductive and applicable to surfaces that are both porous and non-porous. In addition, printing on arbitrary every-day surfaces such as wood, textiles, or ceramic tiles requires a relatively

<sup>1</sup>The printhead we use is active-low. For simplicity and generalization our figures show active-high control

<sup>2</sup><https://hci.cs.uni-saarland.de/projects/print-a-sketch/>

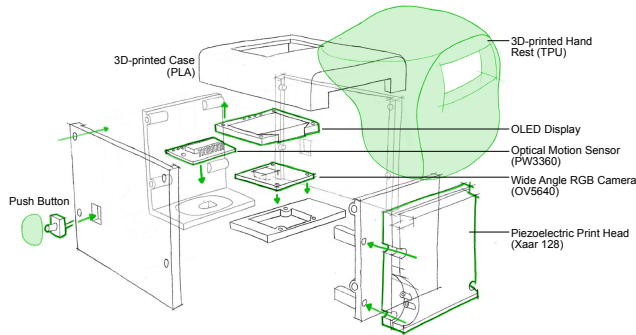

**Figure 4: The handheld printer includes a printhead, an optical flow sensor and an RGB camera for sensing and tracking. A display and two buttons enable selecting functions of the device.**

low curing temperature to enable in-situ curing, for instance with a household iron (max. 100°C), a blow-dryer or a heat lamp. From the available off-the-shelf conductive inks, we selected nanosilver ink (Metalon® JS-A102A) from Novacentrix [39] which is highly conductive ( $0.100 \Omega/\square$  on Melinex ST505) and offers the needed viscosity. The 50 ml ink container is connected to the printhead using a 3 mm ID tube. In the current implementation power circuitry and ink container are offloaded from the hand-held printer. Overall, the handheld printer (green box in Figure 3) and the complete hardware setup (Arduino, battery, and ink bottle) weigh 110 g and 200 g, respectively.

## 4.2 Movement and Context Sensing

*Print-A-Sketch* draws strength from continuously adapting to the surface context and adjusting the print parameters accordingly. To capture *device movement* and the surface’s *visual texture*, we employ a combination of two different optical sensors, an RGB camera and an infrared-based optical flow camera (Figure 4).

**Optical Flow Camera.** The optical flow sensor captures precise records of the device’s movement speed, movement direction, relative orientation, and hand jitter. This sensor’s accuracy is crucial for the quality of the resulting print. We thus opted for a highly accurate and fast sensor, namely PMW3360 [45], which is commonly used in optical gaming mice. It features a resolution of up to 12,000 Counts Per Inch (CPI), a speed of 250 inch per second, and acceleration of 50 g. The sensor measures displacement by capturing the surface image and calculating the movement direction and speed. The data is then passed on via the SPI interface to the microcontroller, where it serves to adjust the printhead’s firing frequency, printing direction, and to determine which of the 128 nozzles need to be fired. We further use the lift detection feature of the sensor to identify hovering states and signal the printhead accordingly (start/stop sequences).

**RGB Camera.** The presence or absence of a previously printed trace is a change to the visual texture of the surface. To detect visual

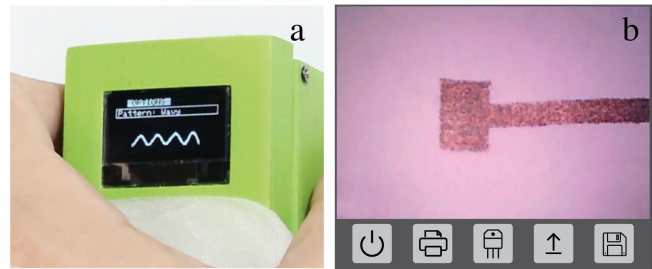

**Figure 5: *Print-A-Sketch* user interface: (a) the user controls most functionality directly on the hand-held tool (here: selecting the trace pattern), (b) the backend interface supports additional functionality (e.g., showing the live camera view).**

textures including previously printed traces, we use a  $2592 \times 1944$  pixel camera module (OV5640) [61] which is connected to a laptop via USB. We installed the camera inside the handheld tool’s case pointing down towards the print surface, together with two LEDs for controlled illumination (Figure 3 b). Previously printed designs or other surface features are detected and tracked visually using OpenCV’s blob detection feature. In addition, data from the RGB camera and optical flow sensor are combined for detecting material properties and adjust the print properties accordingly.

## 4.3 User Interface

To support rapid and convenient sketching in hardware, users are provided with a two-part user interface. Most functionality can be triggered directly on the hand-held tool (e.g., selecting the trace pattern, confirming/rejecting to connect to the detected trace) (Figure 5 a). For this purpose, it features an OLED display module [23] on its top, and a push button on each side of the case (Figure 4). The user’s hand is supported through an ergonomic hand rest printed from TPU. For more fine-grained control and access to less frequently used functionalities (e.g., uploading a new design, defining a new component) we implemented a backend interface in Python that runs on a Macbook Pro (2.3 GHz Core i5) (Figure 5 b). The backend interface shows the live camera view and also serves as a link between all of the components: it communicates with the Arduino microcontroller using a serial protocol to control the printhead and analyzes the visual data. When printing images, it sends linewise pixeldata to the Arduino. Both the backend interface as well as the Arduino firmware can manipulate the datastream based on contextual information.

## 5 ADAPTING TO FREE-HAND MOTION

In conventional desktop inkjet printers, the position and movement of the printhead is precisely controlled by stepper motors. In contrast, with the artist or draftsman freely moving their brush or pen, processes of painting or sketching are dynamic: speed and direction of the sketching tool are varied in one fluent motion. Preserving this freedom of movement in a handheld printer requires to dynamically adapt the print motif to speed and direction of movement. In this section, we present solutions to ensure **consistent print dimensions and quality** independent of the speed of movement—an aspect that is particularly critical when printing conductors,

as they need to be end-to-end conductive. We also show how to automatically compensate for unsteady motion or shaky hands, to realize **steady free-hand printing**.

## 5.1 Consistent Print Dimensions and Quality

With constant speed and line-wise movement, ink delivery in desktop printers is less complex than for handheld printing: the nozzles located on the printhead jet ink droplets at constant time intervals that are fixed relative to the printhead's speed. The *firing frequency* is constant. This allows for printing patterns with consistent dimensions and quality.

In contrast, the dynamic speed of movement of a handheld printhead affects the density of the delivered print. This causes two related problems: discontinuous traces for freehand sketching and distorted images of digital print. For freehand sketching, fast movement causes jetted droplets to spread out wider, creating discontinuous traces that are not end-to-end conductive. Slow movement, in contrast, causes droplets to encroach on another, creating image bleed and possibly even short circuits. Figure 6 a) illustrates the effect. Figure 6 c) shows an example printed with varied movement speed, but constant frequency of ink jetting, leading to a distorted and discontinuous print. Similarly, if one wishes to digitally print patterns, increasing movement speed elongates the pattern, while slow movement compresses it.

To address the issues cause by free-hand movement, *Print-A-Sketch* precisely adjusts the frequency of ink delivery (modulated by a waveform signal with signal where changes the level cause droplet release), to the speed of the printhead traveling over the substrate. This is illustrated in Figure 6 b). In our setup, the optical flow camera detects the distance and direction of movement, from which we calculate movement speed. It ensures that irrespective of movement speed, a pattern remains undistorted and printed with consistent dimensions while also maintaining consistent droplet density (Figure 6 d).

*Print-A-Sketch* does not have a set direction in which traces must be drawn. The user could reverse the direction of motion. When this happens the order of lines sent to the printhead via the SPI interface is reversed.

**5.1.1 Accuracy of Measuring and Printing.** To test the accuracy with which the printer can measure movement speed and adjust the print accordingly, we performed a technical experiment. It involved printing a 20 mm long trace at three different speeds.

A linear slider stepper motor [37] was used to move *Print-A-Sketch* at 6, 8, and 12 mm/s. At each speed, the trace was printed 3 times on standard office paper. Then the length of the printed traces were measured and the offset from the ideal length (20 mm) calculated. The results show a high accuracy of 98.0% (Absolute mean error: 0.4 mm, SD: 0.2 mm), with a maximum offset of 0.73 mm at speed 12 mm/s. This also suggests that *Print-A-Sketch* might be used as a measuring device, when designing on the fly.

## 5.2 Steady Free-Hand Printing

Free-hand sketching comes with all forms of unintentional hand motion. This introduces artifacts due to unsteady motion or shaky hands, which, in a sketch simply become a part of the resulting

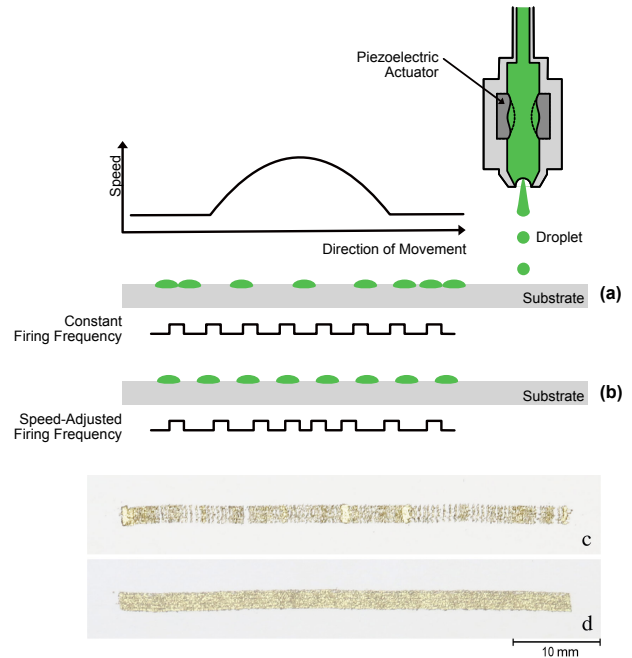
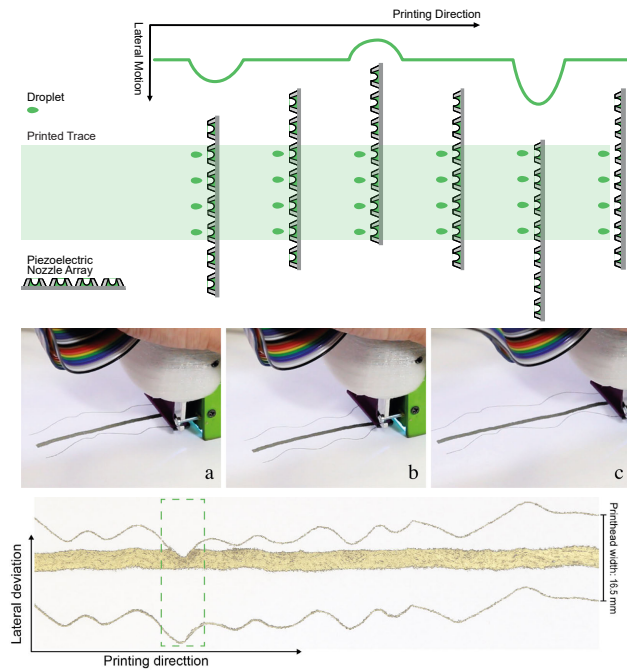

**Figure 6: Top (side view): (a) Irregular free-hand movement causes irregular gaps between droplets when the firing frequency is constant; (b) Speed adjusted firing frequency allows to maintain a consistent resolution. Bottom: (c) Free-hand printed trace with constant firing frequency cannot be used as a conductor and also has visual artifacts (d) Free-hand printed trace with speed adjusted firing frequency is visually consistent and has good conductance**

drawing. When, however, printing a detailed pattern, an IC footprint, or routing multiple traces, lateral movement by the hand holding the printer causes wobbly and jittery prints, or – in the worst case, if designing electronics – even creates undesired short circuits.

*Print-A-Sketch* continuously detects lateral movement of the print using the optical flow sensor and counteracts by adjusting the printed image on-the-fly. As illustrated in Figure 7, the print pattern is adjusted to side-ways motion by shifting the bits in the array of data that is to be printed to the left or right, corresponding to the extent of side-ways motion that has happened since the last row of droplets was printed. This cancels out artifacts created by movement orthogonal to the printing direction, as long as the extent of movement minus the width of the printed pattern does not exceed the width of the nozzle array. In practice, assuming the trace is centred under the printhead, the possible deviation is  $\pm(\text{printheadWidth} - \text{traceWidth})/2$  (e.g.:  $\pm 6.25$  mm for a 4 mm trace).

To demonstrate the performance of motion correction in practice, we printed several straight lines with movement correction activated. Figure 7 (middle) shows three different examples of printing with lateral movement correction. Figure 7 (bottom) shows an exemplary trace, it is 120 mm long, and 4 mm wide allowing



**Figure 7: Top (viewed from top):** To print a straight line, even when the user introduces lateral motion, nozzles can be selectively used to counteract the moment. **Middle: three examples of tracing with motion compensation.** **Bottom: Conductive trace printed with motion correction.** The thin traces on top and bottom show the strong lateral movement of the print head while the trace was printed.

correction for up to 6.25mm. The trace was printed on standard office paper while moving the handheld tool back and forth orthogonally to the printing direction. For reference, in Figure 7, while printing, the leftmost and rightmost nozzles of the printhead were continuously printing a thin trace; these traces visualize the lateral movement and indicate the printing range. For all other nozzles in-between, we applied the motion correction technique. As visible in the Figure 7 (bottom row), despite the extreme lateral deviation of the printhead, the printed trace is steady. However, as highlighted in green, exceeding the width of the printhead causes artifacts. These errors, however, were caused intentionally, typically visual feedback from *Print-A-Sketch*'s display would enable the user to prevent creating deviation of this magnitude.

Together, the ability to print consistent patterns and counteracting user movement form the basis for enabling sketching of functional circuits as we outline in the next section.

## 6 SUPPORTING SKETCHING

Like an artist who freely moves their brush over their canvas, users can freely move *Print-A-Sketch* to create ad-hoc free-hand patterns (see Figure 8). In this section, we present how such free sketching can be enhanced by high-resolution patterns that the handheld printhead is printing dynamically. As demonstrated in the following, this combination creates a new sketching experience that is

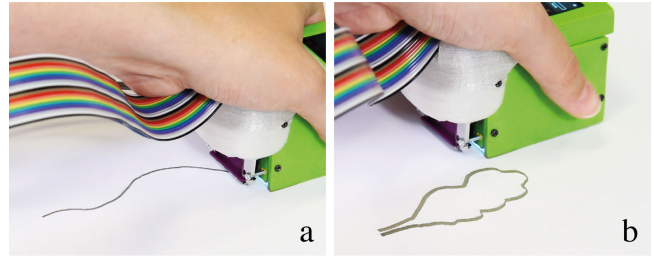

**Figure 8: Shapes and curves created by free-hand motion:** In both examples the digital printhead produces a constant straight line, following the human motion.

characterized by a synergetic workflow of free sketching and printing.

In addition to adding **digital detail**, this enables contextually informed **adaptive printing**, where the printhead adds intelligently to the tracing motion of the user. Finally, the RGB camera together with a library of electronic components support the user in easy **integration with existing electrical components**.

### 6.1 Adding Digital Detail

While users can manipulate the overall structure and design of the sketch by using *Print-A-Sketch* like a pen or a brush, the digital printhead of *Print-A-Sketch* can be used to further refine and manipulate details:

**6.1.1 Custom Brushes and Line Styles.** Both in physical and digital sketching, it is common to adjust the tool to the intended trace style. For example, in manual sketching one might select from different levels of graphite hardness; with digital sketching tools, one might select a textured digital brush for the desired effect. Following this metaphor *Print-A-Sketch* enables the user to use ‘brushes’ with different characteristics. For example, varying trace widths, styles (e.g., solid, dashed, or dotted) and patterns (e.g., serpentine and zigzag) can be selected directly on the device (see Figure 9a). Printing multiple parallel lines is also possible; in this case, the user defines the number of traces and the distance between parallel lines (Figure 9b).

**6.1.2 Stamping Shapes.** Similarly to a traditional stamp, *Print-A-Sketch* can be used to create basic shapes (including circles or rectangles) for users to develop into more complex designs. These basic shapes can also be used for creating electrically functional designs. For example, circles can be used as capacitive buttons, or a series of *stamped* triangles can be used to form an interdigitated slider. Users can add custom shapes by uploading a bitmap image to the backend interface.

**6.1.3 Scan & Print.** Custom images and shapes can also be manually designed. For example, the desired shape can be drawn with a pen or pencil, and then scanned by placing and moving the handheld printer over it. Subsequently, following a “copy and paste” metaphor, they can be re-printed at a different location. This technique is especially promising for building on or repairing circuit elements where no template exists (e.g., because they have been created free-hand) or where the template is unknown for another reason (Figure 10).

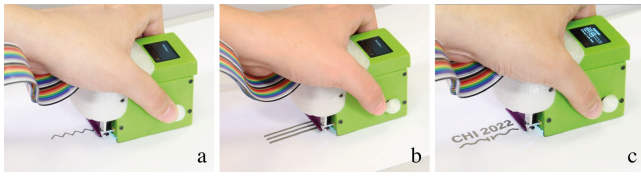

**Figure 9: Custom Brushes:** a) Printing traces with custom pattern and width, b) printing multiple lines, c) stamping an uploaded image.



**Figure 10: Scan & Print:** a) Sketching custom design, b) scanning, c) and printing the design.

## 6.2 Adaptive Printing

We use a RGB camera to enable *Print-A-Sketch* to sense previously sketched traces and footprints. In the same way as *Print-A-Sketch* can detect free-hand motion and intelligently compensate for it, *Print-A-Sketch* can also intelligently react to existing sketches. The precise control of nozzles allowed us to implement several automation routines to support creating functional electronic sketches:

**6.2.1 Stopping and Resuming Traces.** Sketching includes pausing to review and rethink a sketch, or returning to previously sketched traces to add further details. To allow for the continuation of previously printed traces or to connect a new trace to a previously printed pad, a handheld printing device needs to adapt ink delivery to existing traces to ensure precise alignment of old and new prints. Compared to common sketching tools, e.g., pencils, this is challenging to do manually as the printhead's miniaturized array of nozzles does not resemble a single tip and does not offer sufficient cues for which nozzles will activate when delivering a given pattern.

To overcome this issue, contact of *Print-A-Sketch* with the surface is detected by the optical flow camera. Then monitoring of the surface's visual features, for instance previously printed traces or pads for connecting components, enables continuing the print where one had left off.

When a user intends to resume a print, e.g., connecting a fresh trace to a previously printed trace or pad, they place the handheld printer roughly on the pre-existing element and move it in the desired direction (Figure 11). The image from the RGB camera is analyzed using blob detection. The software then autonomously determines the exact position of the connection point in the print area and modifies pixel data and data stream accordingly by bit-wise shifting of the image data in the shift registers. As a result, only those nozzles that are spatially aligned with the connection point are activated (pixel data, perpendicular to print direction), and fire at the precise point in time when the nozzle array traverses the pre-existing element's end point (data stream, aligned with print direction). We illustrate this principle in Figure 11.

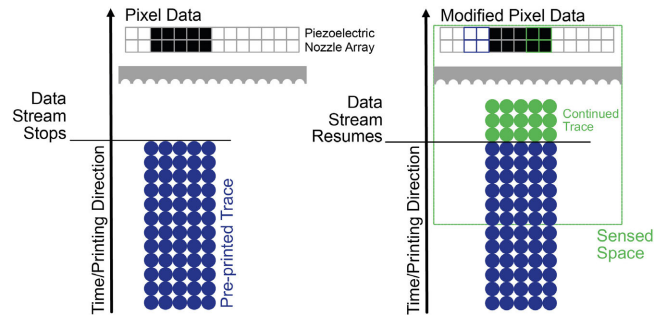
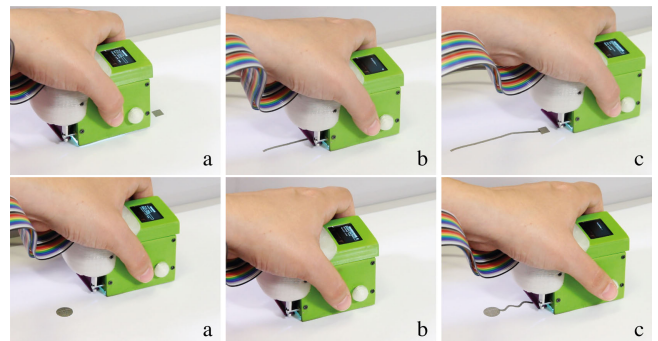

**Figure 11: Left:** Lifting the printer from the surface causes the data stream to stop and the nozzles to deactivate. **Right:** To resume the print, the printhead is placed roughly over the pre-printed trace. The trace is detected using the RGB camera. If the printhead is not perfectly aligned, as seen here, the data is shifted to correct for the offset. Printing automatically resumes where the previous trace left off.

**6.2.2 Connect-to Objects.** This principle is also used for stopping the print when connecting to a target component, as shown in Figure 12 top. When *Print-A-Sketch* encounters existing printed features, they are identified using blob-detection. *Print-A-Sketch* then provides the user with a *connect-to* function. If only one blob is detected, the system identifies the center of the blob's side facing the printhead as the point of connection. This generic implementation works for traces of diverse styles as well as pads or electrodes of rectangular or circular shape. If multiple blobs are visible in the camera view, the user has the option to select the desired element in the user interface.

Note that in frame c the trace dynamically adapted its direction to connect to the target pad. For starting a trace on an object, blob detection is used to decide when the print should begin (Figure 12, bottom).

**6.2.3 Routing.** While intelligent stopping and starting of prints is a required utility for functional designs, *Print-A-Sketch* can go one step further and also proactively support users in creating electrical designs:



**Figure 12: Top:** Connecting to existing footprint: a) selecting the end point, b) handheld tool detects the footprint, c) printing trace is routed to the footprint. **Bottom:** Starting from existing footprint: a) selecting the start point, b) handheld tool detects the footprint, user selects the width and pattern of the trace, c) printing the trace.



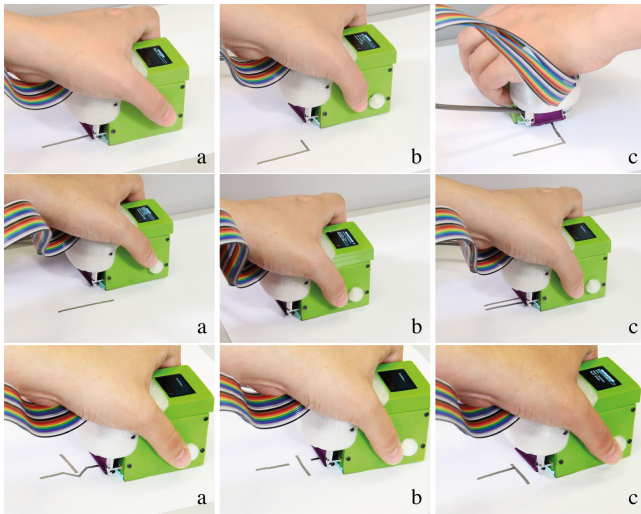
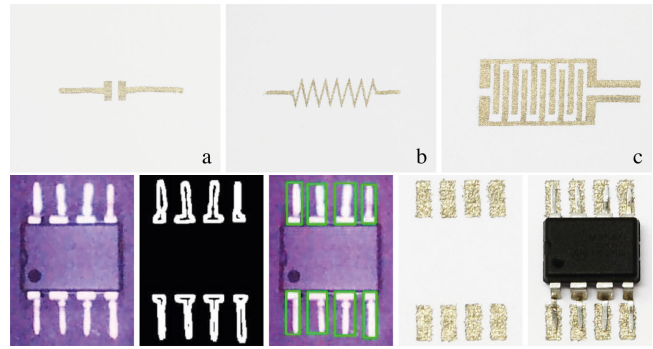

**Figure 13: Top: Printing angle: a) defining the size of angle on-the-fly, b) printing the angle, c) continuing the trace. Middle: Printing a trace parallel to a previously printed trace: a) selecting a previously printed trace, b) placing the printer on existing trace and defining the distance between the traces, c) printing the new trace. Bottom: Various actions after detecting a previously printed trace: a) routing around the detected trace if there is enough space, b) stop printing before reaching to the trace and continuing after the detected trace, c) forcing to connect to the detected trace.**

First, *Print-A-Sketch* enables printing corners with precise angles. In this case, the user sets the desired angle on the LCD menu and continues printing. The system ends the current trace with the defined corner. Then the user places the tool on the other side of the angle and the system continues the trace (Figure 13, top row).

Second, when routing multiple signals, space often becomes an issue. To support creating compact designs, one might wish to add a line as close as possible next to an existing trace. *Print-A-Sketch* can automatically place a new trace in close proximity to an existing trace, creating parallel lines, which never touch. *Print-A-Sketch* does this by continually monitoring the distance to existing traces, and printing the new trace in a predefined distance. The user can specify the distance between traces directly on the device (Figure 13, middle row).

Lastly, not all printed traces should be connected to previously printed elements. Avoiding the creation of short circuits is crucial, as unintentionally created connections may result in irreparable damage. Here, *Print-A-Sketch* can support the user during sketching by observing the surface, detecting existing previously printed traces in the print area, and alerting the user. By default, the system routes around detected objects if the size is less than the width of the print head (bottom row, Figure 13 a). If routing around is not possible, the system stops printing before reaching to the existing object or trace (bottom row, Figure 13 b). Finally, the user can override the action and force the printer to connect to the detected trace (bottom row, Figure 13 c) using the buttons on the printer.



**Figure 14: Top: (from left to right) Footprint for a 2835 component, printed resistor, moisture sensor. Bottom: IC footprints can be created on-the-fly by scanning the component to be used. (From left to right) RGB image, detected outlines, generated footprint, printed footprint and printed footprint together with surface-mount IC.**

**6.2.4 Accuracy of Adaptive Printing.** We performed a technical experiment to investigate the accuracy of detecting a pattern on a surface and registering subsequent prints to it. We first printed five squares with dimensions ranging from 4 to 12 mm (2 mm intermediate steps) on an office paper. Then, we moved the handheld tool around the surface and whenever a square was detected, the printer printed a crosshair over its center. Next, we measured the offset between the center of the crosshair and the center of the rectangle. The results indicate that the printed crosshairs are sufficiently close to the target; the mean offset was 0.478 mm (SD: 0.376) and the maximum offset was 0.813 mm.

### 6.3 Integration of Electrical Components

In most cases traces alone do not make an interactive interface. A functional circuit needs to connect to sensors, actuators and integrated circuits (ICs). To make this as effortless as possible, *Print-A-Sketch* supports two methods of interfacing with components:

**6.3.1 Adding Footprints from Component Library.** *Print-A-Sketch* contains with a basic library, which contains footprints of common electronic components and printable components. In our current implementation, the component library is stored as bitmapped footprints. Users can navigate these and select them on the device. In addition to common footprints, printable components include capacitive sensors (capacitive button, slider and pressure sensor) and resistive sensors (stretch and bend sensor, moisture sensor and level sensor). Some examples are depicted in Figure 14, top. Note that resistive elements need to be calibrated to the target surface. The resistor shown in Figure 14 b works by increasing the trace length. To achieve higher resistance, the amplitude of the zig-zag pattern is increased.

**6.3.2 Creating Footprints from Physical Parts.** Additionally, for minimal disruption of manual sketching, many physical electronic components can be scanned using the RGB camera. Using basic edge-detection, pins can be identified. Then appropriately sized and spaced pads are automatically generated. This feature is not

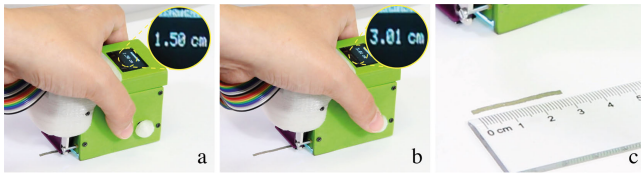

**Figure 15: *Print-A-Sketch* as measurement tool: a-b) the display visualises length of the printed trace, c) shows the accuracy of the printed trace.**

package type dependent, however, it has only been tested on SIP, DIP and SOIC packages (see Figure 14 bottom).

#### 6.4 *Print-A-Sketch* as measurement tool

As *Print-A-Sketch* already continuously monitors the optical flow sensor for detecting speed and determining inking rate, it is also possible to use this information for measurement. The user can use this feature to measure the length of printing traces or spacing between components on the fly. The system guides the user by showing the measured value on the LCD (Figure 15).

## 7 PRINTING ON EVERYDAY OBJECTS

Commodity desktop printers allow the user to manually define the substrate material (e.g., office paper or glossy paper). The printer's driver will then adjust the amount of ejected ink to best match the substrate's surface properties. A scenario involving a handheld printer may take up this principle, but extends it to include more diverse materials, for instance substrates that would not commonly be used in a desktop printer. Moreover, and contrary to a desktop printer, the user may sequentially print on multiple different materials, even during a simple trace. In this section, we discuss how continuous monitoring of the material and dynamic adjustment of print parameters allow users of *Print-A-Sketch* to freely sketch conductive patterns on everyday surfaces and objects. Moreover, we present results from an experiment which confirms that *Print-A-Sketch* prints conductive traces on a wide range of everyday materials.

### 7.1 Matching Print Parameters to Materials

The area that a jetted droplet covers on the substrate's surface varies depending on the substrate's ability to absorb ink. This has a direct effect on the conductivity of a printed pattern. As shown in Figure 16 top, droplets of a constant amount of ink may create end-to-end conductive traces on some type of substrate (top left), whereas on a more strongly absorbent substrate, ink drops are more strongly absorbed and therefore cover a smaller surface area, which creates a discontinuous pattern (top right). However, if the droplet size is too large, the ink will run, and detailed prints – such as the moisture sensor in Figure 14 c – will fail. Therefore, to ensure conductivity on all materials, the size of the ink droplet needs to be adjusted to match the material's properties. To this end, the electrical signal that activates the piezoelectric actuator of each nozzle is modulated [13]. Firing a single pulse results in dispensing one droplet (Figure 16 top). Larger droplets can be generated by firing a rapid burst of multiple consecutive pulses. This dispenses several droplets, which in turn results in formation of one single, but larger dot on the substrate

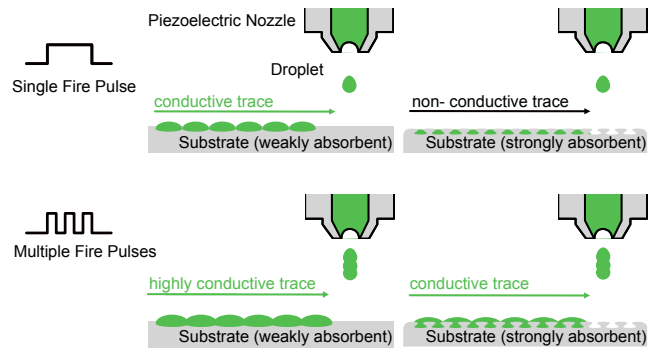

**Figure 16: Increasing the number of pulses of the fire signal results in creation of multi-drops and consequently larger drops. If drop sizes are too small, resulting traces will not be conductive. If drop sizes are too large, the ink will run, and detailed prints will fail.**

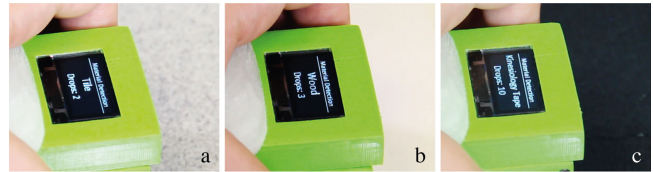

**Figure 17: Adjusting the printing parameters to the detected materials: a) tile, b) plywood, 3) kinesiology tape.**

(Figure. 16 bottom). Generally, the size of ink droplets needs to be larger when printing on absorbent substrates (e.g., plain office paper) compared to less absorbent substrates (e.g., glossy photo paper). Our implementation varies the size of droplets in a range between 1 and 10 droplets per dot or pixel<sup>3</sup>.

The Computer Vision community has demonstrated robust and advanced techniques for optical material detection from image data [1, 11, 62]. Inspired by this work, we trained a KNN classifier with the sensors data from materials that we used for the evaluation and application scenarios. The handheld device displays the detected material and adjusts printing parameters based on a lookup table (Figure 17). Our current setup classifies only a subset of materials: office paper, glossy photo paper, tile, plywood, kinesiology tape, felt sheet, and natural cork. The current implementation serves as proof-of-concept, it demonstrates the principle feasibility of dynamically adjusting print parameters based on automatically detecting the substrate material.

Knowing about the material and its mechanical properties does not only provide the basis for adjusting print parameters. Future implementations of *Print-A-Sketch* could automatically adjust the printed patterns themselves. For instance, when printing on more

<sup>3</sup>In our implementation all printable images are stored as bitmaps with a width of 128 pixels, each pixel corresponding to an individual nozzles of the printhead. Therefore we maintain a 1 to 1 correspondence between dots and pixels

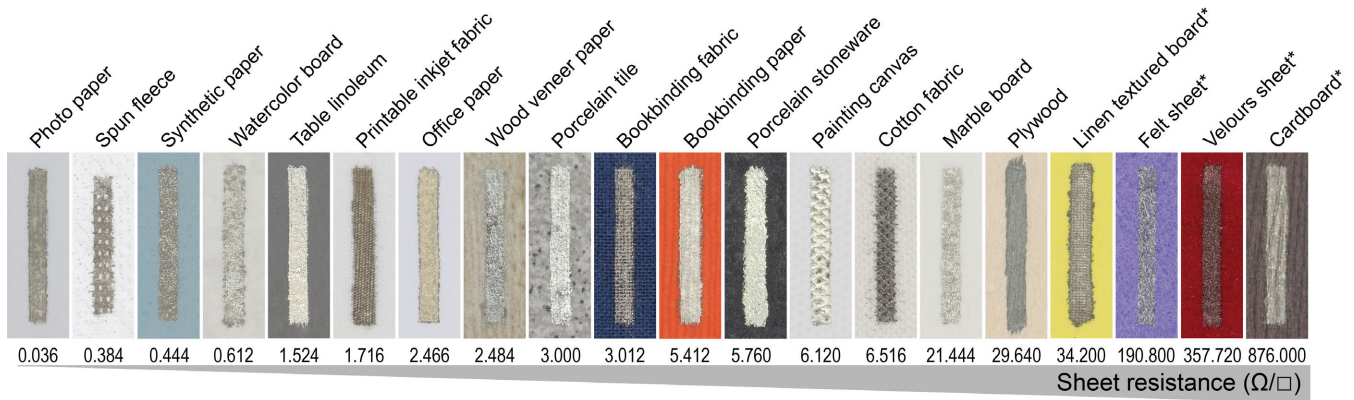

Figure 18: Sheet resistance of silver traces on different substrate materials, with single-drop printing.

stretchable substrates that undergo more deformation, straight conductive traces could be automatically replaced with horseshoe designs. Or when printing on very demanding substrates, traces could be made wider to further increase their end-to-end conductivity.

## 7.2 Conductivity of Prints on Everyday Materials

To validate that *Print-A-Sketch* can print functional designs on many everyday objects, we investigated the conductivity of printed traces on various substrate materials. We investigated the effect of substrate materials, number of droplets per pixel, and trace width.

**7.2.1 Effect of substrate material.** We selected a set of sample materials that are common on everyday objects and frequently used for prototyping (e.g., paper, cardboard, textile, plywood, and ceramics). We ensured that the selected samples cover a variety of material properties (i.e., surface texture and absorption). The tested materials are presented in Figure 18 and Figure 19.

On each material shown in Figure 18, we printed a trace of 20 mm length by activating 16 nozzles and firing a single pulse per byte of data (hence dispensing small ink droplets). We cured traces at 100 °C for 10 min. We used an electric oven (Sage, BOV820 BSS) to speed up the process by curing multiple samples simultaneously. As suggested by [25], we investigated the conductivity in terms of sheet resistance. To do this, we measured the resistance  $R$  of each sample using a Fluke 175 multi-meter, and then calculated the sheet resistance per square using the formula  $R_s = R * (width/length)$ , and averaged the results for each material.

The results are presented in Figure 18. As can be seen, most printed traces exhibit high conductivity. However, a handful of materials, such as cardboard, felt and velour sheet, result in very low conductivity. We show in the following how a increasing the size of ink droplets can boost their conductivity.

**7.2.2 Effect of number of droplets per pixel.** We next examined the effect of adjusting the number of droplets per pixel on conductivity. This promises to enhance conductivity on absorbent surfaces. For a first pilot experiment, we selected office paper as a frequently used material that is highly absorbent. Traces of 20 mm length were printed with 16 active nozzles, jetting different number of

ink droplets (1, 2, 3, or 5 droplets for each pixel data) We printed 3 samples per condition, resulting in a total of 12 traces. The printed samples were cured at  $\approx 100$  °C for 10 min using a household iron (Bosch TDA2329). Our findings revealed that the conductivity considerably increases with increasing the number of droplets, ranging from 2.466  $\Omega/\square$  for 1 pulse to 0.256  $\Omega/\square$  for 5 droplets per pixel.

Based on this finding, we opted for the best performing condition with 5 droplets for investigating more materials. We selected eight materials: four materials that have the highest sheet resistance in the previous experiment (group 1) and four materials that failed to become conductive in the previous experiment (group 2). On each material, we printed a 20 mm long trace with 16 active nozzles and 5 droplets per pixel, cured them as described above and calculated the sheet resistance.

Figure 19 depicts the results. For all but one material, jetting 5 droplets substantially enhanced the conductivity compared to single-droplet printing. For the four materials that were part of the above evaluation, we observed an impressive 25 to 348 fold decrease of sheet resistance which belong to linen texture board and wood textured cardboard, respectively.

For instance the sheet resistance of wood textured cardboard, which had the highest sheet resistance in the previous experiment, has decreased from 876  $\Omega/\square$  to 2.52  $\Omega/\square$ . However, the trace printed on Kinesiology tape was not conductive with 5-droplets printing

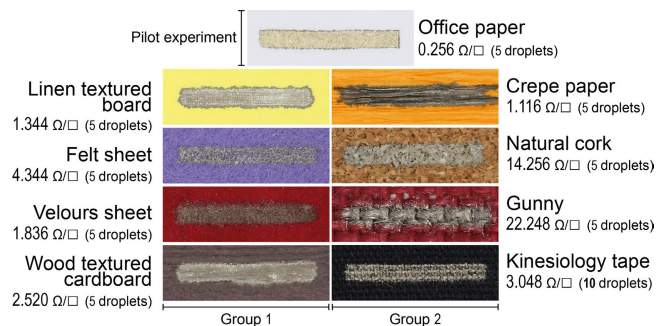
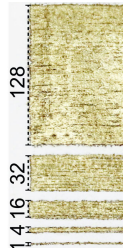

Figure 19: Improved sheet resistance with increased droplet size on highly absorbent substrate materials.

**Table 1: Sheet resistance of traces with various width on glossy and absorbent substrates (photo shows printed traces with five different width on an absorbent sheet - numbers on left are nozzle counts).**



| Nozzles | Glossy Sheet |            | Absorbent Sheet                   |            |                                   |
|---------|--------------|------------|-----------------------------------|------------|-----------------------------------|
|         | Max (128)    | Width (mm) | Sheet Resis. ( $\Omega/\square$ ) | Width (mm) | Sheet Resis. ( $\Omega/\square$ ) |
| 128     |              | 16.7       | 0.105                             | 17.6       | 2.76                              |
| 32      |              | 4.20       | 0.043                             | 4.60       | 2.32                              |
| 16      |              | 2.10       | 0.036                             | 2.30       | 2.47                              |
| 4       |              | 0.50       | 0.039                             | 0.60       | 3.33                              |
| 1       |              | 0.10       | 0.025                             | 0.15       | 50.6                              |

due to the highly porous composite material; we printed another sample with 10 droplets per pixel, which showed good conductivity.

**7.2.3 Effect of trace width.** To evaluate the effect of trace width and identify the minimum width of conductive traces, we printed 5 samples of 20 mm length and varying width (1, 4, 16, 32, 128 active nozzles, corresponding to 0.1–16.7mm width) on two different substrates using conductive silver ink [39], see Table 1. The substrates were selected from two different categories: a glossy paper which has a very smooth surface (Epson photo paper, 260  $\mu\text{m}$  thick), and a highly absorbent sheet (standard office paper). For each pixel data, the nozzles were fired once. The test was repeated 3 times and then the printed samples were cured at  $\approx 100^\circ\text{C}$  for 10 min using a household iron (Bosch TDA2329).

Table 1 summarizes the results. We found that with the same number of active nozzles, printed traces are wider on office paper than on glossy paper. Furthermore, due to high absorption of office paper, the conductivity is higher on glossy paper than on office paper. The sheet resistances on the glossy sheet range from 0.025  $\Omega/\square$  to 0.105  $\Omega/\square$  and are close to the reported value for silver ink (Metalon, JS-A102A) [39] which is  $<0.100 \Omega/\square$ . A minimum trace width of 0.1 mm is achievable on the glossy sheet by activating a single nozzle, resulting in a low sheet resistance of 0.025. In contrast, printing with a single nozzle on the absorbent sheet was challenging and resulted in the highest resistance (50.6  $\Omega/\square$ ). By activating 4 nozzles, resulting in a trace width of 0.6 mm, the sheet resistance decreased considerably to 3.33  $\Omega/\square$ .

## 8 APPLICATIONS AND CASE STUDY

To demonstrate the practical feasibility our technique and its applicability to the sketching of circuits and sensors on everyday surfaces, we present four functional application examples fabricated with *Print-A-Sketch*. These show various types of sensors and circuits realized on diverse materials that are commonly found in a household. Figure 20 shows the prototypes. In addition, we present findings from a hands-on case study with novice users.

### 8.1 Moisture sensor on a floor tile

The first application example demonstrates adding smart home functionality to a room’s tiled floor. We designed and fabricated a customized moisture sensor on a porcelain tile (Figure 20a). When water comes in contact with the sensor, the resistance changes and

the buzzer sounds an alarm. One use case of this application is detecting washing machine leakage. For fabrication of the interactive tile, we selected moisture sensor from the library of components and then printed the sensor, the footprint of the buzzer, and conductive terminals. Next, we created conductive lines that connect the buzzer to the terminals. The handheld tool helped by automatically printing a visually pleasing pattern, instead of straight lines, and by automatically connecting the line endings to the respective endpoints. Finally, we attached the buzzer using conductive paste and connected the terminals to an Arduino microcontroller using copper tape. Circuit elements which should not be in contact with water can be covered with isolation spray or silicone.

### 8.2 Interactive yoga mat

To demonstrate use on personal objects with demanding materials, we realized an interactive yoga mat that features four capacitive buttons for controlling playback of instructional videos (Figure 20b). The mat is made of natural cork and is flexible. When the yogi desires to control the video, she can use her toe, without changing her pose, to pause, resume or navigate within the video. For printing the design on the mat, we loaded the design in the backend interface, and used *stamping* technique. The traces are printed using *routing* feature. A D1 mini microcontroller, attached on the backside of the mat, wirelessly communicates with the video player running on a tablet computer.

### 8.3 Wearable stretch sensor on kinesiology tape

To demonstrate rapid integration of sensors for textile wearables and inspired by sketching on-body interactions [59], we implemented a custom stretch sensor on a kinesiology tape (Figure 20c). The sensor can be attached on different joints of the user’s body to detect flexion and extension. The terminals of the sensor are connected to an Arduino using standard copper cables. Stretch is detected by observing changes in resistance.

### 8.4 Capacitive slider on a table lamp

Next, we aimed to turn a conventional table lamp into a customised interactive piece of furnishing. We printed a capacitive button and two sliders onto a lamp’s textile shade. These are used to turn the lamp on or off, and change its color and brightness (Figure 20d). To create the visual design, we drew the full moon and crescents on a paper and then used our handheld printer to scan and then we print the designs on the lamp shade. The electrodes were then connected to the terminals and tethered to an Arduino microcontroller to control the lamp.

### 8.5 Hands-On Case Study with Novice Users

To gain additional insights into patterns of use, we conducted a hands-on case study with four novice users (3 females, 1 male). Two of them were familiar with sketching, painting and designing circuitry, having backgrounds in computer science (P1, female, 24) and electrical engineering (P2, female, 23). P3 (male, 30) was experienced in fabrication and DIY electronics; P4 (female, 62) was a language teacher with no hardware prototyping experience.



**Figure 20: Application examples demonstrate the the practical feasibility and applicability of our technique on everyday surfaces: a) moisture sensor on a floor tile, b) interactive yoga mat, c) wearable stretch sensor on kinesiology tape, and c) capacitive slider on a table lamp.**

After providing informed consent, we began the study with a short introduction to the project, handheld printer, and user interface, and gave participants time to practice using the device. Next, the participants were asked to perform a series of tasks from simple to more complex: (1) print a shape; (2) scan & print a shape; (3) print a trace with custom width and pattern; (4) connect a trace to an existing shape. We then discussed their experiences and challenges they faced in a semi-structured interview. We continued the study with a brainstorming session, asked participants to think about a possible application case of this device in making their environment more interactive. They had this option to select a material from our sample box. The participants then proceeded to fabricating their idea with *Print-A-Sketch*, using the sketching interactions they preferred.

**8.5.1 Results & Discussion.** All participants managed to complete the tasks and provided useful feedback. They commented that working with the device was simple and controlling the handheld device and moving it on the surface was smooth and easy to do. In addition, they commented on the usefulness of in-place printing using a handheld printer and its benefit for creating aesthetically pleasant prototypes. They stated that compared to traditional methods of designing and then printing, a handheld printer helps rapid prototyping and allows improvisation during fabrication. The possibility of printing and then embellishing the design was another interesting aspect for participants. Within an hour session, all participants were able to make a functional prototype without our intervention. Participants, however, felt that we could provide better feedback, for example P3 wished to have access to more information on the OLED display, while P4 – who had never before designed a circuit – felt that the breadth of options was overwhelming and would want to have more detailed guidance from the UI.

For their practical application case, they all decided to make capacitive buttons and sliders and used the *stamping* and *routing* features to fabricate the electrodes. P1 decided to create an electrode on her desk that uses capacitive sensing to detect touch contact, as a means to signal her when she is tapping constantly on the desk (Figure 21a). She fabricated the interface on a linoleum material, by printing a heart shape electrode from the library of components and then using the *connect-to* feature to print serpentine pattern as a

trace. P2 desired to make a slider on her bedside table to control the lighting of the room when she is in bed. Interestingly, she decided to customise the slider by sketching one custom-shaped electrode first and then used the *scan & print* feature to replicate the electrode to print a full slider on a sheet of plywood (Figure 21b).

Changing the TV program from the handle of a coach was interesting for P3. He used the *stamping* feature to print two capacitive buttons with a customised shape. Next, he used both *connect-to* and *motion correction* features to connect the traces to the printed electrodes. P3 was excited that the *motion correction* feature provides him with the ability to draw fine straight lines and highlighted that this feature is helpful for those who do not have sketching skills. Finally, P4 selected a diamond shape pattern electrode to fabricate an interface on her notebook. She intended to use this electrode to control the heating system at her home. While P4 was fabricating her electrode, we figured out that her understanding was that by pushing the handheld device, more ink would eject from the device, similar to pushing fountain pen. We will consider this interesting finding for the next iteration of the device.

While most participants focused on moving the handheld device carefully and in a straight line, P1 decided to use the printer as a brush and freely sketched a floral electrode (Figure 21c). Finally, *Print-A-Sketch* not only supported novices in fabrication of functional and visually pleasant prototypes, but also facilitated thinking about making the surrounding environment more interactive.



**Figure 21: Images from user study: (a) drawing a customised electrode to scan & print, (b) Printed design based on hand-drawn electrode. (c) free form sketching.**

## 9 DISCUSSION

Our implementation is subject to several limitations. We discuss these in the following and identify opportunities for future work.

**Materials and Printing.** *Ink adhesion* shows the material compatibility. We observed the silver ink adheres well to diverse materials. We couldn't remove or wipe off the ink from highly absorbent materials and the ink is robust on glossy surfaces.

The JS-A102A nanosilver ink is water-based, which causes it to have higher *surface tension* compared to other types of inks, such as solvent-based ink. On substrates with low surface energy, such as smooth glass, this causes poor wetting. This issue could be addressed by applying an additive to the substrate before printing which reduces the surface tension and results in a better print quality [4].

In our current implementation, we use silver ink [39] which can be *thermally cured* at temperatures as low as 100 °C. A wide range of substrate materials tolerate this curing temperature; however, eliminating the heat curing step would enable printing on a wider range of materials and accelerate the fabrication process. We can report that printed traces on specially prepared and coated surfaces (e.g., Epson photo paper and Mitsubishi NB-RC-3GR120 [35]) sinter at room temperature. Promising avenues for future work are sinter-free inks (such as sinter-free gold ink [53]) or applying a sintering aid layer to the substrate to reduce the sintering temperature to room temperature [69].

**Electrical circuits.** For *electrical isolation* and to protect printed patterns from damage, we used isolation spray (WEICON isolation spray [64]). However due to the crawling effect of the ink on the isolated layer, we were not able to print a second conductive layer. Therefore, our current approach is restricted to a *single-layer circuits*. In future work, we intend to address this by adding surface additives. This would allow creating layered designs, for example, to print multi-touch sensors [48].

While we have not performed any formal evaluation of *long-term conductivity*, we can anecdotally report that the conductivity of printed traces has not declined on tested materials (e.g., plywood, office paper, glossy sheet, and printable fabric) within a nine months period. As expected, we also observed that the printed traces are robust to *bending and stretching*. The response of inkjet printed traces to bending or stretching has been explored extensively in related research papers [6, 25, 26].

Iterative design and fabrication of a circuit may include *removing parts of a circuit* that was printed before [38]. We can anecdotally report that printed traces can be removed from coated paper (Mitsubishi NB-RC-3GR120 [35]) before heat curing using a sponge soaked in a mixture of water and polyvinyl alcohol (PVA). However, removing ink after sintering or from more absorbent materials requires additional investigation.

**Open-loop printing.** The size and form factor of selected printhead allows *printing on curved surfaces and across edges*; however our current implementation of position tracking using the optical motion sensor would not be reliable on non-planar surfaces. In future work, we plan to investigate alternative position sensing techniques that allow for absolute positioning on a wider range of surface geometries. *Recognizing materials* from images is a topic

of ongoing research [12, 55]. Our simple proof-of-concept implementation detects only a subset of all materials we successfully printed on. For the next iteration, we plan to extend the approach to a cover wider set of materials by sampling additional materials and tuning the printing parameters accordingly. The controlled lighting environment underneath the printer in combination with the dual data-sources from the IR visual flow camera and the RGB camera suggest that this approach has promise.

To improve the visibility of printed patterns in the Figures and the video that accompanies this paper, most examples were shown on white substrates. However, we demonstrated that the *blob detection feature* works on materials with different colors (e.g., black kinesiology tape, Figure 20c), visual patterns (e.g., non-solid colored floor tiles, Figure 20a and video figure), and material textures (e.g., uneven surface of natural cork, Figure 20b). We note that the accuracy of blob detection can be affected if the surface features visual patterns that are similar to the size or colors of the printed patterns. In future work, we plan to use the infrared spectrum [12] to improve the blob detection feature on surfaces with high-contrast colored patterns.

In our current setup, the RGB camera is located inside the handheld device, making the printed patterns in direct proximity to the printhead invisible to the user. To assist the user in precisely adjusting the printhead, the backend interface visualizes the live camera view (see Figure 5b), and the system automatically and precisely routes the printing trace toward the detected blob, if desired. In future iterations, we are considering displaying the location of the detected blobs on the OLED display. A simple alternative would be to make the casing of the handheld device out of a transparent material.

The *movement speed* of our handheld printer is restricted to 12 mm/sec. Of note, the printing speed of the Xaar 128 printhead is higher. The limiting factors are the Arduino system clock, the end-to-end latency between microcontroller, optical sensors, printhead, and the backend interface. We plan to address this issue by replacing the Arduino with a faster microcontroller (e.g., Teensy 4.1, 600 MHz).

In our current implementation, the backend interface is running on a laptop and communicates with the Arduino via the serial port. In the next iteration, we plan to implement the backend interface in a Raspberry Pi and make the setup fully portable. Finally, creating a fully closed loop system which not only measures the environment of the trace, but also samples the freshly printed trace itself to update inking parameters dynamically would be an exciting extension of this work.

## 10 CONCLUSION

In this paper we presented *Print-A-Sketch*, an open-source handheld printer prototype for sketching circuits and sensors. *Print-A-Sketch* combines desirable properties from manual sketching and functional electronic printing. Manual human control of large strokes allows designing the overall interactive system while computer control provides fine detail, an interface to the miniature world of discrete components and integrated systems. Shared control of *Print-A-Sketch* enables sketching interactive interfaces on everyday

objects which is especially exciting for objects so large or heavy that they could not easily be placed inside conventional printers.

We have shown that context-aware, dynamic printing can provide solutions for a number of challenges. Continuous sensing ensures quality prints by adjusting inking-rate to hand movement and material properties. *Print-A-Sketch's* sensing abilities also enables prints to intelligently adapt to previously printed traces for incremental and iterative sketching. Results show good conductivity on many materials (e.g.:  $3 \Omega/\square$  on tiles) and high spatial precision (traces are aligned with  $<0.5\text{mm}$  mean error), supporting on-the-fly creation of functional interfaces. Hardware and firmware of the printer driver will be made available on GitHub upon publication.

## ACKNOWLEDGMENTS

This project received funding from the German Research Foundation (DFG project 425869111 within the Priority Program SPP2199 Scalable Interaction Paradigms for Pervasive Computing Environments) and from the European Research Council (ERC) under the European Union's Horizon 2020 research and innovation program (grant agreement No 714797, StG Interactive Skin). We thank Sina Mavali for his help with implementing the python software and Marie Mühlhaus for her help with video editing.

## REFERENCES

- [1] Sean Bell, Paul Upchurch, Noah Snively, and Kavita Bala. 2015. Material recognition in the wild with the materials in context database. In *Proceedings of the IEEE conference on computer vision and pattern recognition*. IEEE Computer Society, Washington, DC, USA, 3479–3487.
- [2] Audrey Briot, Cedric Honnet, and Paul Strohmaier. 2020. Stymphalian Birds - Exploring the Aesthetics of A Hybrid Textile. In *Companion Publication of the 2020 ACM Designing Interactive Systems Conference (Eindhoven, Netherlands) (DIS '20 Companion)*. Association for Computing Machinery, New York, NY, USA, 437–440. <https://doi.org/10.1145/3393914.3395840>
- [3] Leah Buechley and Hannah Perner-Wilson. 2012. Crafting Technology: Reimagining the Processes, Materials, and Cultures of Electronics. *ACM Trans. Comput.-Hum. Interact.* 19, 3, Article 21 (Oct. 2012), 21 pages. <https://doi.org/10.1145/2362364.2362369>
- [4] BYK. 2020. Substrate wetting. <https://ebooks.byk.com/en/surface-additives/substrate-wetting/> Accessed: 2021-02-02.
- [5] Varun Perumal C and Daniel Wigdor. 2015. Printem: Instant Printed Circuit Boards with Standard Office Printers and amp; Inks. In *Proceedings of the 28th Annual ACM Symposium on User Interface Software and Technology* (Charlotte, NC, USA) (*UIST '15*). Association for Computing Machinery, New York, NY, USA, 243–251. <https://doi.org/10.1145/2807442.2807511>
- [6] Tingyu Cheng, Koya Narumi, Youngwook Do, Yang Zhang, Tung D. Ta, Takuya Sasatani, Eric Markvicka, Yoshihiro Kawahara, Lining Yao, Gregory D. Abowd, and HyunJoo Oh. 2020. Silver Tape: Inkjet-Printed Circuits Peeled-and-Transferred on Versatile Substrates. *Proceedings of the ACM on Interactive, Mobile, Wearable and Ubiquitous Technologies* 4, 1 (March 2020), 1–17. <https://doi.org/10.1145/3381013>
- [7] chibitronics. 2021. Expressive Technology with Paper Circuits. <https://chibitronics.com/> Accessed: 2021-02-02.
- [8] Youngkyung Choi, Neung Ryu, Myung Jin Kim, Artem Dementyev, and Andrea Bianchi. 2020. BodyPrinter: Fabricating Circuits Directly on the Skin at Arbitrary Locations Using a Wearable Compact Plotter. In *Proceedings of the 33rd Annual ACM Symposium on User Interface Software and Technology (Virtual Event, USA) (UIST '20)*. Association for Computing Machinery, New York, NY, USA, 554–564. <https://doi.org/10.1145/3379337.3415840>
- [9] Colop. 2021. <https://emark.colop.com/>. Accessed: 2021-06-15.
- [10] Gerard Cummins and Marc P.Y. Desmulliez. 2012. Inkjet printing of conductive materials: a review. *Circuit World* 38, 4 (Jan. 2012), 193–213. <https://doi.org/10.1108/03056121211280413> Publisher: Emerald Group Publishing Limited.
- [11] Joseph DeGol, Mani Golparvar-Fard, and Derek Hoiem. 2016. Geometry-informed material recognition. In *Proceedings of the IEEE conference on computer vision and pattern recognition*. IEEE Computer Society, Washington, DC, USA, 1554–1562.
- [12] Miroslav Dulik and Libor Ladanyi. 2014. Surface detection and recognition using infrared light. In *2014 ELEKTRO*, Vol. 1. IEEE Computer Society, Washington, DC, USA, 159–164. <https://doi.org/10.1109/ELEKTRO.2014.6847893>
- [13] Simon Eccles. 2017. The ultimate guide for printhead technologies. <https://www.fespa.com/en/news-media/features/the-ultimate-guide-for-printhead-technologies> Accessed: 2021-02-02.
- [14] Nicholas Fellion, Thomas Pietrzak, and Audrey Girouard. 2017. FlexStylus: Leveraging Bend Input for Pen Interaction. In *Proceedings of the 30th Annual ACM Symposium on User Interface Software and Technology* (Québec City, QC, Canada) (*UIST '17*). Association for Computing Machinery, New York, NY, USA, 375–385. <https://doi.org/10.1145/3126594.3126597>
- [15] Rachel Freire, Cedric Honnet, and Paul Strohmaier. 2017. Second Skin: An Exploration of ETextile Stretch Circuits on the Body. In *Proceedings of the Eleventh International Conference on Tangible, Embedded, and Embodied Interaction* (Yokohama, Japan) (*TEI '17*). Association for Computing Machinery, New York, NY, USA, 653–658. <https://doi.org/10.1145/3024969.3025054>
- [16] Madeline Gannon, Tovi Grossman, and George Fitzmaurice. 2015. Tactum: A Skin-Centric Approach to Digital Design and Fabrication. In *Proceedings of the 33rd Annual ACM Conference on Human Factors in Computing Systems* (Seoul, Republic of Korea) (*CHI '15*). ACM, New York, NY, USA, 1779–1788. <https://doi.org/10.1145/2702123.2702581>
- [17] Madeline Gannon, Tovi Grossman, and George Fitzmaurice. 2016. ExoSkin: On-Body Fabrication. In *Proceedings of the 2016 CHI Conference on Human Factors in Computing Systems* (San Jose, California, USA) (*CHI '16*). ACM, New York, NY, USA, 5996–6007. <https://doi.org/10.1145/2858036.2858576>
- [18] Daniel Groeger and Jürgen Steimle. 2018. ObjectSkin: Augmenting Everyday Objects with Hydroprinted Touch Sensors and Displays. *Proceedings of the ACM on Interactive, Mobile, Wearable and Ubiquitous Technologies* 1, 4 (Jan. 2018), 1–23. <https://doi.org/10.1145/3161165>
- [19] Nur Al-huda Hamdan, Simon Voelker, and Jan Borchers. 2018. Sketch&Stitch: Interactive Embroidery for E-Textiles. In *Proceedings of the 2018 CHI Conference on Human Factors in Computing Systems* (Montreal QC, Canada) (*CHI '18*). Association for Computing Machinery, New York, NY, USA, Article 82, 13 pages. <https://doi.org/10.1145/3173574.3173656>
- [20] Lars Erik Holmquist. 2006. Sketching in Hardware. *Interactions* 13, 1 (Jan. 2006), 47–60. <https://doi.org/10.1145/1109069.1109101>
- [21] Cedric Honnet, Hannah Perner-Wilson, Marc Teyssier, Bruno Fruchard, Jürgen Steimle, Ana C. Baptista, and Paul Strohmaier. 2020. PolySense: Augmenting Textiles with Electrical Functionality Using In-Situ Polymerization. Association for Computing Machinery, New York, NY, USA, 1–13. <https://doi.org/10.1145/1331831.3376841>
- [22] PHIDGETS INC. 2016. phidgets. <https://www.phidgets.com> Accessed: 2021-02-02.
- [23] Vishay Intertechnology. 2017. Graphic OLED. <https://www.vishay.com/docs/37902/oled128o64dbpp3n00000.pdf> Accessed: 2021-06-02.
- [24] Lee Jones. 2021. The E-Darning Sampler: Exploring E-Textile Repair with Darning Looms. In *Proceedings of the Fifteenth International Conference on Tangible, Embedded, and Embodied Interaction* (Salzburg, Austria) (*TEI '21*). Association for Computing Machinery, New York, NY, USA, Article 82, 5 pages. <https://doi.org/10.1145/3430524.3444700>
- [25] Yoshihiro Kawahara, Steve Hodges, Benjamin S. Cook, Cheng Zhang, and Gregory D. Abowd. 2013. Instant Inkjet Circuits: Lab-Based Inkjet Printing to Support Rapid Prototyping of UbiComp Devices. In *Proceedings of the 2013 ACM International Joint Conference on Pervasive and Ubiquitous Computing* (Zurich, Switzerland) (*UbiComp '13*). Association for Computing Machinery, New York, NY, USA, 363–372. <https://doi.org/10.1145/2493432.2493486>
- [26] Arshad Khan, Joan Sol Roo, Tobias Kraus, and Jürgen Steimle. 2019. Soft Inkjet Circuits: Rapid Multi-Material Fabrication of Soft Circuits Using a Commodity Inkjet Printer. In *Proceedings of the 32nd Annual ACM Symposium on User Interface Software and Technology* (New Orleans, LA, USA) (*UIST '19*). Association for Computing Machinery, New York, NY, USA, 341–354. <https://doi.org/10.1145/3332165.3347892>
- [27] Soheil Kianzad, Yuxiang Huang, Robert Xiao, and Karon E. MacLean. 2020. Phasking on Paper: Accessing a Continuum of Physically Assisted SketchING. In *Proceedings of the 2020 CHI Conference on Human Factors in Computing Systems* (Honolulu, HI, USA) (*CHI '20*). Association for Computing Machinery, New York, NY, USA, 1–12. <https://doi.org/10.1145/3313831.3376134>
- [28] Konstantin Klamka and Raimund Dachsel. 2017. IllumiPaper: Illuminated Interactive Paper. In *Proceedings of the 2017 CHI Conference on Human Factors in Computing Systems* (Denver, Colorado, USA) (*CHI '17*). Association for Computing Machinery, New York, NY, USA, 5605–5618. <https://doi.org/10.1145/3025453.3025525>
- [29] Konstantin Klamka, Raimund Dachsel, and Jürgen Steimle. 2020. Rapid Iron-On User Interfaces: Hands-on Fabrication of Interactive Textile Prototypes. In *Proceedings of the 2020 CHI Conference on Human Factors in Computing Systems* (Honolulu, HI, USA) (*CHI '20*). Association for Computing Machinery, New York, NY, USA, 1–14. <https://doi.org/10.1145/3313831.3376220>
- [30] James A. Landay. 1996. SILK: Sketching Interfaces like Crazy. In *Conference Companion on Human Factors in Computing Systems* (Vancouver, British Columbia, Canada) (*CHI '96*). Association for Computing Machinery, New York, NY, USA, 398–399. <https://doi.org/10.1145/257089.257396>

- [31] Thomas Langerak, Juan José Zárate, Velko Vechev, David Lindlbauer, Daniele Panozzo, and Otmár Hilliges. 2020. *Optimal Control for Electromagnetic Haptic Guidance Systems*. Association for Computing Machinery, New York, NY, USA, 951–965. <https://doi.org/10.1145/3379337.3415593>
- [32] Thomas Langerak, Juan Jose Zarate, Velko Vechev, Daniele Panozzo, and Otmár Hilliges. 2019. Dynamic Drawing Guidance via Electromagnetic Haptic Feedback. *CoRR* abs/1906.11753 (2019), 207–217. arXiv:1906.11753 <http://arxiv.org/abs/1906.11753>
- [33] Joanne Lo, Cesar Torres, Isabel Yang, Jasper O’Leary, Danny Kaufman, Wilmot Li, Mira Dontcheva, and Eric Paulos. 2016. Aesthetic Electronics: Designing, Sketching, and Fabricating Circuits through Digital Exploration. In *Proceedings of the 29th Annual Symposium on User Interface Software and Technology* (Tokyo, Japan) (UIST ’16). Association for Computing Machinery, New York, NY, USA, 665–676. <https://doi.org/10.1145/2984511.2984579>
- [34] David A. Mellis, Sam Jacoby, Leah Buechley, Hannah Perner-Wilson, and Jie Qi. 2013. Microcontrollers as Material: Crafting Circuits with Paper, Conductive Ink, Electronic Components, and an “Untoolkit”. In *Proceedings of the 7th International Conference on Tangible, Embedded and Embodied Interaction* (Barcelona, Spain) (TEI ’13). Association for Computing Machinery, New York, NY, USA, 83–90. <https://doi.org/10.1145/2460625.2460638>
- [35] Mitsubishi. 2020. Mitsubishi NanoBenefit 3G Series. <http://www.mitsubishiiimaging.com/digital-imaging-diamond-jet-NANOINK.html> Accessed: 2021-02-02.
- [36] Stefanie Mueller, Pedro Lopes, and Patrick Baudisch. 2012. Interactive Construction: Interactive Fabrication of Functional Mechanical Devices. In *Proceedings of the 25th Annual ACM Symposium on User Interface Software and Technology* (Cambridge, Massachusetts, USA) (UIST ’12). ACM, New York, NY, USA, 599–606. <https://doi.org/10.1145/2380116.2380191>
- [37] Nanotec. 2021. LINEAR ACTUATORS WITH STEPPER MOTORS. <https://en.nanotec.com/products/157-linear-actuator-stepper-motor> Accessed: 2021-06-25.
- [38] Koya Narumi, Xinyang Shi, Steve Hodges, Yoshihiro Kawahara, Shinya Shimizu, and Tohru Asami. 2015. Circuit Eraser: A Tool for Iterative Design with Conductive Ink. In *Proceedings of the 33rd Annual ACM Conference Extended Abstracts on Human Factors in Computing Systems* (Seoul, Republic of Korea) (CHI EA ’15). Association for Computing Machinery, New York, NY, USA, 2307–2312. <https://doi.org/10.1145/2702613.2732876>
- [39] NovaCentrix. 2018. Metalon Conductive Inks for Printed Electronics. <https://www.novacentrix.com/sites/default/files/pdf/Metalon%20JS-A102A%20rev1.pdf> Accessed: 2021-02-02.
- [40] Simon Olberding, Sergio Soto Ortega, Klaus Hildebrandt, and Jürgen Steimle. 2015. Foldio: Digital Fabrication of Interactive and Shape-Changing Objects With Foldable Printed Electronics. In *Proceedings of the 28th Annual ACM Symposium on User Interface Software and Technology* (Charlotte, NC, USA) (UIST ’15). Association for Computing Machinery, New York, NY, USA, 223–232. <https://doi.org/10.1145/2807442.2807494>
- [41] Simon Olberding, Michael Wessely, and Jürgen Steimle. 2014. PrintScreen: fabricating highly customizable thin-film touch-displays. In *Proceedings of the 27th annual ACM symposium on User interface software and technology - UIST ’14*. ACM Press, Honolulu, Hawaii, USA, 281–290. <https://doi.org/10.1145/2642918.2647413>
- [42] Huaishu Peng, Jimmy Briggs, Cheng-Yao Wang, Kevin Guo, Joseph Kider, Stefanie Mueller, Patrick Baudisch, and François Guimbretière. 2018. RoMA: Interactive Fabrication with Augmented Reality and a Robotic 3D Printer. In *Proceedings of the 2018 CHI Conference on Human Factors in Computing Systems* (Montreal QC, Canada) (CHI ’18). Association for Computing Machinery, New York, NY, USA, Article 579, 12 pages. <https://doi.org/10.1145/3173574.3174153>
- [43] Huaishu Peng, Amit Zoran, and François V. Guimbretière. 2015. D-Coil: A Hands-on Approach to Digital 3D Models Design. In *Proceedings of the 33rd Annual ACM Conference on Human Factors in Computing Systems* (Seoul, Republic of Korea) (CHI ’15). Association for Computing Machinery, New York, NY, USA, 1807–1815. <https://doi.org/10.1145/2702123.2702381>
- [44] Hannah Perner-Wilson, Leah Buechley, and Mika Satomi. 2010. Handcrafting Textile Interfaces from a Kit-of-No-Parts. In *Proceedings of the Fifth International Conference on Tangible, Embedded, and Embodied Interaction* (Funchal, Portugal) (TEI ’11). Association for Computing Machinery, New York, NY, USA, 61–68. <https://doi.org/10.1145/1935701.1935715>
- [45] PixArt. 2016. PMW3360DM-T2QU: Optical Gaming Navigation Chip. [https://d35r33r268y59.cloudfront.net/datasheets/9604/2017-05-07-18-19-11/PMS0058-PMW3360DM-T2QU-DS-R1.50-26092016\\_20161202173741.pdf](https://d35r33r268y59.cloudfront.net/datasheets/9604/2017-05-07-18-19-11/PMS0058-PMW3360DM-T2QU-DS-R1.50-26092016_20161202173741.pdf) Accessed: 2021-06-25.
- [46] Xaar plc. 2020. Adaptable printhead with trouble-free integration. [https://d1.amobbs.com/bbs\\_upload782111/files\\_36/ourdev\\_619324HXZTX0.pdf](https://d1.amobbs.com/bbs_upload782111/files_36/ourdev_619324HXZTX0.pdf) Accessed: 2021-02-02.
- [47] Narjes Pourjafarian, Marion Koelle, Bruno Fruchard, Sahar Mavali, Konstantin Klamka, Daniel Groeger, Paul Strohmeier, and Jürgen Steimle. 2021. BodyStylus: Freehand On-Body Design and Fabrication of Epidermal Interfaces. In *Proceedings of the 2021 ACM Conference on Human Factors in Computing Systems (to appear)* (Yokohama, Japan). ACM, New York, NY, USA, 15 pages. <https://doi.org/10.1145/3411764.3445475>
- [48] Narjes Pourjafarian, Anusha Withana, Joseph A. Paradiso, and Jürgen Steimle. 2019. Multi-Touch Kit: A Do-It-Yourself Technique for Capacitive Multi-Touch Sensing Using a Commodity Microcontroller. In *Proceedings of the 32nd Annual ACM Symposium on User Interface Software and Technology* (New Orleans, LA, USA) (UIST ’19). Association for Computing Machinery, New York, NY, USA, 1071–1083. <https://doi.org/10.1145/3332165.3347895>
- [49] Prinker. 2020. <https://prinker-europe.com/en/>. Accessed: 2020-02-15.
- [50] Jie Qi and Leah Buechley. 2014. Sketching in Circuits: Designing and Building Electronics on Paper. In *Proceedings of the SIGCHI Conference on Human Factors in Computing Systems* (Toronto, Ontario, Canada) (CHI ’14). Association for Computing Machinery, New York, NY, USA, 1713–1722. <https://doi.org/10.1145/2556288.2557391>
- [51] Raf Ramakers, Kashyap Todi, and Kris Luyten. 2015. PaperPulse: An Integrated Approach for Embedding Electronics in Paper Designs. In *Proceedings of the 33rd Annual ACM Conference on Human Factors in Computing Systems* (Seoul, Republic of Korea) (CHI ’15). ACM, New York, NY, USA, 2457–2466. <https://doi.org/10.1145/2702123.2702487>
- [52] Majken K. Rasmussen, Giovanni M. Troiano, Marianne G. Petersen, Jakob G. Simonsen, and Kasper Hornbæk. 2016. *Sketching Shape-Changing Interfaces: Exploring Vocabulary, Metaphors Use, and Affordances*. Association for Computing Machinery, New York, NY, USA, 2740–2751. <https://doi.org/10.1145/2858036.2858183>
- [53] Beate Reiser, Tobias Kraus, Lola Gonzalez-Garcia, Johannes H.M. Maurer, and Ioannis Kanelidis. 2017. Conductive nanocomposites. Retrieved 15.04.2020 from <https://www.leibniz-inm.de/wp-content/uploads/Handout-Sintering-free-ink.pdf> Patent No. WO2017045989A1, Filed September 8th., 2016, Issued March 23th., 2017.
- [54] Thijs Roumen, Bastian Kruck, Tobias Dürschmid, Tobias Nack, and Patrick Baudisch. 2016. Mobile Fabrication. In *Proceedings of the 29th Annual Symposium on User Interface Software and Technology* (Tokyo, Japan) (UIST ’16). Association for Computing Machinery, New York, NY, USA, 3–14. <https://doi.org/10.1145/2984511.2984586>
- [55] Gabriel Schwartz and Ko Nishino. 2018. Recognizing Material Properties from Images. *CoRR* abs/1801.03127 (2018), 207–217. arXiv:1801.03127 <http://arxiv.org/abs/1801.03127>
- [56] Hyunyoung Song, Tovi Grossman, George Fitzmaurice, François Guimbretière, Azam Khan, Ramtin Attar, and Gordon Kurtenbach. 2009. PenLight: Combining a Mobile Projector and a Digital Pen for Dynamic Visual Overlay. In *Proceedings of the SIGCHI Conference on Human Factors in Computing Systems* (Boston, MA, USA) (CHI ’09). Association for Computing Machinery, New York, NY, USA, 143–152. <https://doi.org/10.1145/1518701.1518726>
- [57] Evgeny Stemasov, Tobias Wagner, Jan Gugenheimer, and Enrico Rukzio. 2020. *MixMatch: Towards Omitting Modelling Through In-Situ Remixing of Model Repository Artifacts in Mixed Reality*. Association for Computing Machinery, New York, NY, USA, 1–12. <https://doi.org/10.1145/3313831.3376839>
- [58] Paul Strohmeier, Jarrod Knibbe, Sebastian Boring, and Kasper Hornbæk. 2018. ZPatch: Hybrid Resistive/Capacitive ETextile Input. In *Proceedings of the Twelfth International Conference on Tangible, Embedded, and Embodied Interaction* (Stockholm, Sweden) (TEI ’18). Association for Computing Machinery, New York, NY, USA, 188–198. <https://doi.org/10.1145/3173225.3173242>
- [59] Paul Strohmeier, Narjes Pourjafarian, Marion Koelle, Cedric Honnet, Bruno Fruchard, and Jürgen Steimle. 2020. Sketching On-Body Interactions Using Piezo-Resistive Kinesiology Tape. In *Proceedings of the Augmented Humans International Conference* (Kaiserslautern, Germany) (AHs ’20). Association for Computing Machinery, New York, NY, USA, Article 29, 7 pages. <https://doi.org/10.1145/3384657.3384774>
- [60] Ryo Suzuki, Rubaiat Habib Kazi, Li-yi Wei, Stephen DiVerdi, Wilmot Li, and Daniel Leithinger. 2020. *RealitySketch: Embedding Responsive Graphics and Visualizations in AR through Dynamic Sketching*. Association for Computing Machinery, New York, NY, USA, 166–181. <https://doi.org/10.1145/3379337.3415892>
- [61] OmniVision Technologies. 2011. OV5640 datasheet. [https://cdn.sparkfun.com/datasheets/Sensors/LightImaging/OV5640\\_datasheet.pdf](https://cdn.sparkfun.com/datasheets/Sensors/LightImaging/OV5640_datasheet.pdf) Accessed: 2021-06-02.
- [62] Manik Varma and Andrew Zisserman. 2009. A Statistical Approach to Material Classification Using Image Patch Exemplars. *IEEE Transactions on Pattern Analysis and Machine Intelligence* 31, 11 (2009), 2032–2047. <https://doi.org/10.1109/TPAMI.2008.182>
- [63] Katia Vega, Abel Arrieta, Felipe Esteves, and Hugo Fuks. 2014. FX e-Makeup for Muscle Based Interaction. In *Design, User Experience, and Usability. User Experience Design for Everyday Life Applications and Services*, Aaron Marcus (Ed.). Springer International Publishing, Cham, 643–652.
- [64] Weicon. 2020. <https://www.weicon.de/en/products/new-products/1219/isolation-spray>. Accessed: 2021-06-15.
- [65] Michael Wessely, Ticha Sethapakdi, Carlos Castillo, Jackson C. Snowden, Ollie Hanton, Isabel P. S. Qamar, Mike Fraser, Anne Roudaut, and Stefanie Mueller. 2020. Sprayable User Interfaces: Prototyping Large-Scale Interactive Surfaces with Sensors and Displays. In *Proceedings of the 2020 CHI Conference on Human Factors in Computing Systems*. ACM, Honolulu HI USA, 1–12. <https://doi.org/10.1145/3411764.3445475>



- 1145/3313831.3376249
- [66] Karl D.D. Willis, Cheng Xu, Kuan-Ju Wu, Golan Levin, and Mark D. Gross. 2011. Interactive Fabrication: New Interfaces for Digital Fabrication. In *Proceedings of the Fifth International Conference on Tangible, Embedded, and Embodied Interaction* (Funchal, Portugal) (*TEI '11*). ACM, New York, NY, USA, 69–72. <https://doi.org/10.1145/1935701.1935716>
- [67] Jun Xie, Aaron Hertzmann, Wilmot Li, and Holger Winnemöller. 2014. PortraitSketch: Face Sketching Assistance for Novices. In *Proceedings of the 27th Annual ACM Symposium on User Interface Software and Technology* (Honolulu, Hawaii, USA) (*UIST '14*). Association for Computing Machinery, New York, NY, USA, 407–417. <https://doi.org/10.1145/2642918.2647399>
- [68] Junichi Yamaoka and Yasuaki Kakehi. 2013. DePENd: Augmented Handwriting System Using Ferromagnetism of a Ballpoint Pen. In *Proceedings of the 26th Annual ACM Symposium on User Interface Software and Technology* (St. Andrews, Scotland, United Kingdom) (*UIST '13*). Association for Computing Machinery, New York, NY, USA, 203–210. <https://doi.org/10.1145/2501988.2502017>
- [69] Ling Zhang, Hongjun Ji, Houbing Huang, Ning Yi, Xiaoming Shi, Senpei Xie, Yaoyin Li, Ziheng Ye, Pengdong Feng, Tiesong Lin, Xiangli Liu, Xuesong Leng, Mingyu Li, Jiaheng Zhang, Xing Ma, Peng He, Weiwei Zhao, and Huanyu Cheng. 2020. Wearable Circuits Sintered at Room Temperature Directly on the Skin Surface for Health Monitoring. *ACS Applied Materials & Interfaces* 12, 40 (2020), 45504–45515. <https://doi.org/10.1021/acsami.0c11479> PMID: 32911929. arXiv:<https://doi.org/10.1021/acsami.0c11479>
- [70] Junyi Zhu, Yunyi Zhu, Jiaming Cui, Leon Cheng, Jackson Snowden, Mark Choumlakone, Michael Wessely, and Stefanie Mueller. 2020. MorphSensor: A 3D Electronic Design Tool for Reforming Sensor Modules. In *Proceedings of the 33rd Annual ACM Symposium on User Interface Software and Technology* (Virtual Event, USA) (*UIST '20*). Association for Computing Machinery, New York, NY, USA, 541–553. <https://doi.org/10.1145/3379337.3415898>
- [71] Amit Zoran and Joseph A. Paradiso. 2013. FreeD: A Freehand Digital Sculpting Tool. In *Proceedings of the SIGCHI Conference on Human Factors in Computing Systems* (Paris, France) (*CHI '13*). ACM, New York, NY, USA, 2613–2616. <https://doi.org/10.1145/2470654.2481361>