

STUDIES ON THE SEMANTICS OF QUESTIONS
AND THE PRAGMATICS OF ANSWERS

ACADEMISCH PROEFSCHRIFT

ter verkrijging van de graad van
doctor in de wijsbegeerte
aan de Universiteit van Amsterdam,
op gezag van de Rector Magnificus
dr. D.W. Bresters,
hoogleraar in de Faculteit
der Wiskunde en Natuurwetenschappen,
in het openbaar te verdedigen
in de Aula van de Universiteit,
(tijdelijk Roetersstraat 15)
op vrijdag 23 november 1984
te 13.30 uur en te 14.30 uur

door

JEROEN ANTONIUS GERARDUS GROENENDIJK
geboren te Amsterdam

en

MARTIN JOHAN BASTIAAN STOKHOF
geboren te Amsterdam

STUDIES ON THE SEMANTICS OF QUESTIONS
AND THE PRAGMATICS OF ANSWERS

Promotores: prof. dr. R.I. Bartsch
prof. dr. J.F.A.K. van Benthem

PREFACE

This book contains six studies on different subjects in the theory of questions and answers. They were written over a period of several years. Yet, we trust that they present a coherent view.

Except for the first paper, which being an introduction was written last, the papers appear in chronological order. The second paper was written in 1980, the third in 1982, and the fourth in 1983. These three papers have been published, and they are included here with permission of the copyright holders, which is gratefully acknowledged. Except for some minor corrections, they appear here as they were published. The remaining three papers were written specially for this volume, in 1984. There are some minor discrepancies in content and terminology between the earlier papers and the later ones. These are pointed out in the preliminary remarks. The later papers, like the earlier ones, were written as separate, independent papers. This has caused some overlap, which is the only excuse we have for the volume of this volume.

Our interest in the subject of questions and answers is a derivative of our main interest, which is the pragmatics of natural language, in particular the epistemic aspects thereof, and the role it plays in a general theory of meaning and understanding. It was some years ago that, while we were discussing the pragmatics of assertions, Simon Dik raised the problem of questions, and started us thinking about that subject. But in order to get a proper pragmatics, one needs a proper semantics, and so one thing starts another.

As the papers show, the enterprise in which we are engaged is one which does not eschew going into details. It bespeaks an attitude towards general philosophical claims that they can be, and sometimes need to be worked out in 'unphilosophical' detail in order to get a better idea of their contents and tenability. In this sense, formal semantics can also be viewed as the execution of a philosophical program. Quite generally, we think that this is a valuable and fruitful way to view the relationship between philosophy and science. And it depends on the actual division of labour what is classified as what.

Following good custom, we would like to express our gratitude here to all who have helped. Simon Dik, Johan van Benthem, Renate Bartsch, and Teun van Dijk initiated us in the ways and means of this profession, and encouraged and helped us getting started. Renate Bartsch and Johan van Benthem have been patient and careful supervisors ever since. Theo Janssen and Fred Landman helped us by their never-failing willingness to discuss problems and criticize our solutions, and by letting us share their knowledge and insights. Together with Renate Bartsch, Dick de Jongh and Frank Veltman, they provide an environment that is stimulating and pleasant to work in. Various other people have commented on earlier versions of the material as well. Of those who are mentioned in the papers themselves, we owe special thanks to Peter van Emde Boas, for his piercing and useful criticisms. We are grateful to Marjorie Pigge for performing a fine job typing and retyping various versions of various manuscripts. Finally, each of the authors would like to thank the other.

PRELIMINARY REMARKS

The second, third and fourth paper are published papers, and they have been included in the present volume without any essential changes. The main purpose of these remarks is to indicate how they are related to, and at which points they deviate from, or are revised in, the other papers, which were written later.

Sections 1, 2 and 3 of II, 'Semantic analysis of wh-complements', present the core of our semantic analysis of wh-complements and interrogatives. The latter are not within the scope of II, but in section 1 of V, 'Questions and linguistic answers', the analysis of wh-complements it contains is adopted for the analysis of interrogatives as well.

Section 5 of II deals with certain aspects of coordination. Coordination of interrogatives is treated in more depth and detail in VI, 'Coordinating interrogatives'. This holds also for the scope phenomenon discussed in section 6.1 of II. The analysis given there, is criticized and replaced by a different one in VI.

A more specific remark concerns the use of Ty2, the language of two-sorted type theory, as a translation medium, instead of PTQ's IL. In section 6.2 of II it is asserted that the increase in expressive power Ty2 has over IL is really needed for a statement of the semantics of interrogatives. This claim has been refuted by Zimmermann, in his paper 'Comments on an article by Groenendijk & Stokhof', which is to appear in *Linguistics and Philosophy*. Zimmermann shows that all semantic operations we use in II, can be formulated in IL as well, be it in a much less elegant and perspicuous way.

In the same paper, Zimmermann proves the conjecture made

in section 3.8 of II, that in order to obtain so-called 'de dicto' readings of interrogatives in a compositional way, the intermediary level of abstracts is necessary. Further empirical motivation for the level of abstracts is provided in V, where it is argued that it plays an essential role in the derivation and interpretation of linguistic answers.

The third paper, 'Interrogative quantifiers and Skolem-functions', deals with the analysis of so-called 'functional readings' of interrogatives. Within the volume as a whole, III has a rather isolated position. Functional readings are distinguished from so-called 'pair-list readings'. The analysis of the latter that is used in III, is that presented in II. As remarked above, VI contains a better and more thorough analysis of this phenomenon. However, the argumentation in III concerning the non-identity of functional and pair-list readings is independent of this.

One of the conclusions of III is that the syntactic analysis of functional readings presented there, though effective, is not very elegant. In note 39 of V, some suggestions are made how to improve upon it. The matter is once more touched upon in note 51 of VI.

The fourth paper, 'On the semantics of questions and the pragmatics of answers', has a central position. It connects the semantics of interrogatives with pragmatic notions of answerhood. The definitions of these notions in IV reappear in section 4 of V. There they are stated in a slightly different form, but their contents remain essentially the same.

The last remark concerns terminology. Being written over an extended period, the papers inevitably show discrepancies in terminology. Most of these will not cause confusion. One shift in terminology needs to be mentioned. In II and III, 'question' is used as 'interrogative' is used in the other papers, viz. to refer to linguistic objects. In IV, V and VI, 'question' refers to the specific semantic content we assign to interrogatives, in I it stands for the semantic interpretation of interrogatives in general.

I

PROBLEMS AND PROSPECTS
IN THE THEORY OF QUESTIONS

CONTENTS

1. The importance of studying questions	3
2. Some general constraints on a theory of questions and answers	8
2.1. Framework principles	8
2.1.1. Compositionality, syntax and semantics	8
2.1.2. Descriptive and explanatory adequacy	10
2.2. Domain principles	12
2.2.1. The equivalence thesis	12
2.2.2. The independent meaning thesis	13
2.2.3. The answerhood thesis	14
3. Some empirical issues in the theory of questions and answers	17
3.1. The semantics of interrogatives and wh-complements	18
3.2. Questions and answers	25
3.3. Interrogatives and presuppositions	30
3.4. Conclusion	37
4. Three approaches to the theory of questions and answers	38
4.1. A general characterization	38
4.2. The categorial approach	41
4.3. The propositional approach	48
4.4. The imperative-epistemic approach	57
4.5. Conclusion	62
Notes	65
References	73

1. The importance of studying questions

Of course, the semanticist's first answer to the perennial question 'Why?', is the same as that of the mountaineer. Questions and answers exert a fascination that some simply find impossible to resist.

But it seems that, in this particular case, there are also more principled reasons to consider the study of questions and answers a topic of special importance. And this holds especially for those who are working in what has become known as 'formal', or 'logical', semantics.

The enterprise of formal semantics is to try to understand the meaning of language, and of what lies behind it, by studying it with exact means. In this strand of thinking, the applicability of logical and mathematical techniques, in a certain sense, constitutes a criterion of adequacy, a measure of success. To the extent that we do not succeed in building a formal model of some domain, we are considered not to understand, in a cognitive sense of the word, what is going on.

The application of notions and methods derived from logic, more in particular from model-theoretic semantics, raises some important, perhaps even crucial questions. Logic deals, or so it seems, with just one aspect of natural language. Perhaps it is the most important aspect, or maybe that is not even true. But this does not really matter. The point is that the scope of logic as a theory of language, has seemed to many to be restricted in principle.

The assumed restriction, is, of course, that to descriptive language, or, perhaps more broadly, assertive language. From a logical point of view, this restriction is a natural

and a sound one. After all, logic as a theory of inference has little place for all that does not play a role in formal or informal reasoning. Consequently, for many it seemed that from the logical perspective, language can be identified with description, that asserting is the only relevant function of language, and that meaning exists only in virtue of this function and can be explained solely in terms of it.

This position is advocated today especially by those who uphold that natural language meaning is *sui generis*, and that the ways and means of formal, logical semantics can never be fruitfully applied to (all of) it. The very existence of non-descriptive language, and questions are, of course, a prime example, is taken to show that logical semantics, restricted as it is assumed to be, in principle will fall short of providing an adequate theory of meaning for natural language.¹

In view of this, questions form an outstanding challenge to the formal semanticist. If he succeeds to give a descriptively and explanatory adequate account of the semantics of interrogative sentences, he will, perhaps, be able to shake off the odium of being a myopic formalist with no real feeling for the intricacies and endless varieties of natural language.

So, here we come up against the great importance that lies behind the study of questions for the formal semanticist. Few would deny that, studying the semantics of indicatives, he has developed useful notions and has gained important insights. Should he succeed to come up with an analysis of interrogatives in which these notions and insights are equally helpful and illuminating, this would lend support to the claim that he has succeeded to uncover some fundamentals of language in general. It would support the wider applicability, and hence the general importance, of what was developed with the eye to a smaller area. And it would give us another reason to remain faithful to our gut feeling that, pace Wittgenstein, systematic and explanatory theories about language in general can be developed.

Of course, we do not want to suggest that those who have

concerned themselves with questions and answers, have done so for the reason just indicated. Most, if not all, of them have been motivated mainly by their fascination with the subject as such. And this, to be sure, is as good a reason as any. However, such considerations as expressed above, may serve to emphasize the great external importance of the results obtained in the area.

Besides this external importance, and the evident inherent significance of the subject, there seems to be good reason to suppose that the study of questions and answers might occupy a central position in the field of formal semantics and pragmatics of natural language. Let us indicate, very briefly, some of the reasons for thinking this to be the case.

Having been restricted to the study of sentence semantics for a long time, recent developments in formal semantics have shown an increasing interest in more comprehensive units of language, such as discourses. Question-answer sequences form a basic type of discourse, one of which the structural properties seem to be reasonably well-defined, and therefore, one which seems to be a promising starting point.

From our point of view, the prime importance of question-answer sequences as a discourse type, lies in the fact that these interactions constitute a discourse which explicitly aims at information exchange. The importance of the notion of information, not only for pragmatics, but also for semantics, is acknowledged increasingly. Notions of (partial) information, and of information growth, have proved to be helpful, if not essential, for giving an adequate account of the semantics of various constructions and expressions in natural language.² And, recently, some have even pleaded for an essentially informational perspective on meaning in natural language, as such.³

As is to be expected, the notion of information, and that of information exchange, has played a prominent role in pragmatics from the very start. To give a simple example, those who take a pragmatic view on presuppositions, account for them in terms

of the opposition between 'old' and 'new' information, a distinction which is also considered to be relevant for the analysis of topic/comment, and the like. Also, the entire theory of conversational maxims, initiated by Grice, and developed into an essential part of a theory of natural language meaning by him and others, makes essential use of the notions of information and of information exchange.

Despite the central role these notions play, their exact content, and their precise analysis, still calls for further study. Especially, this holds for partialness of information, for information growth, and for 'embedded' information.⁴ It seems reasonable to expect that the study of questions and answers, which is intimately related to such notions, can contribute to a better understanding of them.

Let us conclude with pointing out a specific topic in pragmatics that, we feel, an adequate theory of questions and answers can contribute to significantly. A notoriously difficult, but quite essential maxim proposed by Grice, is the Maxim of Relation. Relevance, it seems, is essentially tied to what a conversation is about, to what the topic of a conversation is. And a topic of conversation may very well be thought of as a (set of) questions.⁵ This is obvious for discourses which consist of explicit question-answer sequences, but seems to hold also for types of conversation that are not explicitly concerned with information exchange. Even if in some discourse, no question is explicitly raised, it still plays an important role at the background, viz. as the topic that makes the discourse a coherent whole, rather than a random sequence of assertions. The topic, i.e. an explicitly or implicitly raised question, is what defines the relevance of the assertions in a discourse for each other.

One might indeed go one step further, and uphold that the notion of an assertion as such, is intelligible only given the complementary notion of a question. If we did not have any questions, we would not have any need for assertions either. The study of questions is important for the study of assertions, and vice versa. Neither one is fundamental in the sense

that the other is a derivative of it. Each can be understood only in the context of the other.

2. Some general constraints on a theory of questions and answers

Our purpose in this section, is to formulate some methodological constraints on a theory of questions and answers. These will be helpful in evaluating existing proposals, and as ordering principles in stating the major empirical issues.

For the larger part, these constraints follow from, or are at least intimately related to, basic principles, or prejudices if you like, of the enterprise of logical semantics for natural language. It may therefore be useful to state some of these in a nutshell.

2.1. Framework principles

2.1.1. Compositionality, syntax and semantics

A fundamental principle, adhered to, implicitly or explicitly, by many who work in the formal semantics framework, is that of compositionality, or 'Frege's principle' as it is sometimes referred to. What it basically amounts to, is that it makes good sense to assume that meaning is a matter of composition, that the meaning of larger linguistic units is determined, in a systematic way, by the meanings of their parts. If this idea is to be made to work in an explicit theory, we need a syntax which tells us what the parts of a given linguistic expression are. In many respects, such a syntax may follow its own autonomous ways. But, if it is to serve our semantic purposes as well, it has to be designed in such a way that the syntactic operations can be matched by semantic ones, and that,

conversely, every semantic operation has a syntactic counterpart. As a consequence, every structural semantic ambiguity has to be the result of a corresponding derivational syntactic ambiguity.⁶

This means that compositionality imposes certain requirements on the content of a syntactic theory, i.e. that it contain a semantically motivated level of derivational structure, and that in this sense syntax is not autonomous. On the other hand, those parts of syntax for which an independent, purely syntactic, motivation can be given, should be respected by semantics. Assuming that, unlike derivational structure, constituent structure can and should be motivated on purely syntactic grounds, this means that semantic interpretation should respect constituent structure. In other words, syntactic units, constituents, should be considered semantic units as well. Adherence to such a principle seems reasonable enough. What it basically amounts to, is the belief that units of form are also units of content, that form and content are systematically related.⁷

Two remarks are in order. First of all, it should be stressed that principles of this kind are methodological principles, and not empirical hypotheses. They serve as guide-lines in developing and organizing a particular kind of grammar. Secondly, as far as compositionality is concerned, one need not believe that all of interest that can be said about meaning in natural language, can be said in a compositional semantic theory. Compositionality may have its limits. It may very well be that other principles are active as well. What is presupposed by those who adhere to compositionality, is that it leads to well-defined semantic theories that account for important, central aspects of natural language meaning and understanding.⁸

For example, with many other semanticists, we believe that an overall theory of meaning should encompass a pragmatic theory over and above a compositional semantic theory.⁹ Such a pragmatics may have principles of its own, such as the general principle of cooperation, on which the Gricean con-

versational maxims are founded. A Gricean theory starts from the assumption that a logical semantics provides an adequate basis for accounting for conventional aspects of meaning, and that other aspects of meaning can be explained in terms of the conversational principle that in using expressions, given their conventional meaning, language users behave in a cooperative way.¹⁰

2.1.2. Descriptive and explanatory adequacy

The principle of compositionality embodies a certain view on the structure of a semantic theory, but as such it does not tell us what kind of things meanings are, let alone what the meaning of some concrete linguistic expression is.

Doing the latter, i.e. assigning a proper meaning to (categories of) expressions in some domain of investigation, is, of course, the first requirement a descriptive semantic theory should meet. We want it to be at least descriptively adequate. But it is a first requirement only. We are not satisfied with a semantic theory that operates as a black box, assigning meanings to expressions. We want the theory to do this in a certain way, we want it to be explanatory adequate as well.

To be sure, the notion of explanation, especially in semantics, is a notoriously difficult one. There seems to be no general agreement yet on what constitutes an explanation, and hence on what makes a theory explanatory adequate. Still, we are confident that what will be said here about requirements an explanatory adequate theory should meet, is acknowledged, be it only implicitly, by the majority of those who are working in formal semantics.

Logical semantics is first and foremost interested in structural aspects of meaning. Descriptive adequacy thus means that a theory should associate with (categories of) expressions, semantic objects of a proper type, and having such a structure that relations between semantic objects

are accounted for. To the extent that this is done in a systematic way, the theory gains explanatory power. This requirement of being systematic has at least two sides. First of all, compositionality presupposes a certain amount of system in the types of semantic objects that will be used. Secondly, and more importantly, it seems natural to require of a semantic theory that deals with a certain domain of phenomena, that it account for such phenomena as occur elsewhere too, by using general principles, notions and operations, which can be applied outside the particular domain of the theory as well.

Let us try to make this a little more concrete. An example of a semantic relation that can be found in every descriptive domain, is the relation of entailment. Whatever concrete phenomena some particular analysis deals with, the relation of entailment will be one of the most fundamental relations that the analysis will have to account for. Descriptive adequacy requires only that the analysis give a correct account of whatever entailments hold in its descriptive domain. But, explanatory adequacy is achieved if this account is based on a general notion of entailment, one that applies in other domains equally well. In fact, the semantic framework one uses brings along a general definition of entailment. For example, if the framework is based on set theory, entailment will basically be inclusion. Hence, whenever some analysis in this framework is to account for the fact that one expression entails another, it should do so by assigning them meanings in such a way that the meaning of the one is included in the meaning of the other.¹¹

Another example that illustrates this point, is provided by the operations of coordination. Coordination, too, is to be found in all kinds of categories. Hence, the explanatory adequacy of an analysis that deals with coordinations of expressions of some particular category, is greatly enhanced if the account it gives is based on general semantic operations associated with the coordination processes. Again, the semantic framework defines these operations. If the frame-

work is based on set theory, conjunction and disjunction of expressions in whatever category, will have to be interpreted as intersection and union, respectively.¹²

Living up to these standards is, of course, not the only measure of explanatory adequacy. But, we feel, these requirements are really basic ones. They give us useful tools to compare theories with each other, and to evaluate them.

2.2. Domain principles

In what follows we will discuss three general constraints on a theory of questions and answers, which to a large extent are derivatives of general framework principles, such as discussed above, but which are specific for the particular empirical domain such theories range over. These constraints have been formulated by Belnap, and our discussion of them leans heavily on his work.¹³

2.2.1. The equivalence thesis

A first constraint that Belnap formulates, he calls the 'equivalence thesis'. Observing that interrogative sentences ('direct questions') and wh-complements ('indirect questions'), by and large, come in pairs, he requires that the semantics of the two should be treated equivalently. Belnap views the relation between interrogatives and wh-complements as analogous to that between indicative sentences and sentential complements, i.e. as the relation between what he calls a 'stand-alone' form and an 'embedded' form. Treating the semantics of the two equivalently, does not necessarily mean making them equivalent, but assigning them meanings which can be related to each other in a systematic way.

Obviously, the equivalence thesis is related to the general framework principle of compositionality. At least in such languages as English, Dutch, German, and French, in

which wh-complements clearly appear as noun-phrase-like forms of interrogatives, compositionality requires that the meaning of the former is derived from the meaning of the latter. For such languages, compositionality implies the equivalence thesis.

The equivalence thesis not only serves to evaluate theories which analyze both interrogatives and the corresponding wh-complements, it also allows us to do so with theories which analyze only one of these constructions. For, of some theories which deal with interrogatives, or wh-complements, only, it can be seen beforehand that they cannot be extended to a theory which deals with both and, at the same time, complies with the equivalence thesis.

Further, it has some descriptive implications as well. Among other things, it predicts that interrogatives and wh-complements exhibit the same kind of ambiguities. In this sense, the equivalence thesis also helps to structure the domain of relevant phenomena.

2.2.2. The independent meaning thesis

The independent meaning thesis is related, on the one hand, to the equivalence thesis, and hence to compositionality, and, on the other hand, to the requirement that semantics should respect constituent structure. This thesis says that interrogatives and wh-complements should be assigned a meaning of their own.

The relation with the equivalence thesis is the following. The latter actually puts a ban on all so-called 'paraphrase' theories, i.e. theories which try to define the meaning of an interrogative by way of some indicative paraphrase. Such paraphrases always contain the corresponding wh-complement. Given the equivalence thesis, this cannot work. Hence, interrogatives should be assigned a meaning of their own.

Considerations concerning the relation between constituent structure and semantic interpretation, lead to the same

conclusion. Clearly, interrogatives form a natural syntactic unit. There seem to be no syntactic reasons whatsoever not to regard them as a separate syntactic category. So, interrogatives should be assigned a meaning directly, as they appear, without recourse to syntactically unmotivated levels of analysis.

The same holds for wh-complements. As various simple syntactic tests show, they form a separate constituent of the larger expressions in which they occur. They can be preposed, referred to anaphorically, coordinated, and so on. Consequently, wh-complements, too, should be assigned a meaning of their own in a direct way, a meaning which, moreover, should be derived from that of the corresponding interrogatives, in keeping with the equivalence thesis.

2.2.3. The answerhood thesis

A last, but important, constraint is Belnap's answerhood thesis. His formulation of it, reads as follows: "The semantic representation of a question, whether direct or indirect, should give us enough information so as to determine which propositions count as possible answers to it."¹⁴

Concerning Belnap's formulation, the following has to be noticed. Belnap describes a possible answer as follows: "An answer with neither too much nor too little information".¹⁵ In his interpretation, what constitutes a possible answer is determined completely by the semantic content of the interrogative. For ordinary interrogatives, a unique answer is the result.¹⁶ Clearly, Belnap's notion of an answer does not coincide with the intuitive one. It seems natural to consider many things as possible, partial, complete answers to an interrogative. What Belnap calls an answer, is what we will call a standard semantic answer.¹⁷ If we interpret Belnap's thesis with this in mind, it seems a fair and natural requirement on an analysis of interrogatives. There is little to be gained by an account of questions that remains silent

about answers. An interesting analysis is one which assigns interrogatives a meaning from which the standard semantic answers can be obtained.

In our opinion, the requirement that the answerhood thesis makes is to be supplemented by another one, viz. that the notion of standard semantic answer that a theory characterizes, should be such that it forms a suitable basis for a theory of answerhood in general. There are many more kinds of answers than just the standard semantic ones, and all these are related to each other in systematic ways. The notion of standard semantic answer that a theory provides through the semantic object it assigns to interrogatives, should be such as to allow an account of this to be based upon it.

Belnap contrasts his interpretation of the answerhood thesis with the (hypothetical) position that what constitutes an answer cannot be characterized systematically, i.e. that no systematic theory about the question-answer relationship is possible. Like Belnap, we do not agree: the question-answer relationship is an important fact that needs to be accounted for. But we disagree as to the role the semantic interpretation of interrogatives can and should play in this. Whereas Belnap seems to think that the semantic analysis of interrogatives should say all there is to say about possible answerhood, we merely require it to play an essential role as part of an overall theory.¹⁸ For, we feel that there is far more systematics outside the realm of the purely semantical than, apparently, is dreamt of in Belnap's philosophy. His conception of the question-answer relationship fits those theories which assume that questions can be answered in some (one) ways, but not in all. Contrary to this, we would like to uphold that, in principle, any question can be answered in any way. Of course, not all propositions will answer all questions all of the time, but any proposition may answer any question some of the time. And it is the task of the theory of questions and answers to tell which propositions answer which questions when.

The answerhood thesis seems to be connected with the general

constraint that entailment be accounted for in a general way. This can be argued for as follows. Entailment is essentially inclusion of meaning. If we apply this view to interrogatives, it seems natural to consider one interrogative entailing another as every proposition giving an answer to the first also giving an answer to the second. And this squares with the answerhood thesis, which requires that the semantic interpretation of an interrogative determine what its standard semantic answers are.

3. Some empirical issues in the theory of questions and answers

In this section, we will give a brief sketch of several empirical issues, against the background of the general principles discussed above. Our main purpose in doing so, is to show in what way such theoretical considerations, implicitly or explicitly, guide us in focussing on some phenomena rather than on others. At the background these principles help to determine the relative importance of issues, their interrelations, and so on. Also, they indicate in which direction a proper analysis of the phenomena is to be looked for.

The issues raised here are the main subjects of the papers to follow, and also play an important role in the works of others in the formal semantics tradition on questions and answers, on which these papers build and by which they are inspired. This is not to say that these authors will always view these matters in the same way as we will present them. But, by and large, they are concerned with the same topics.

Two caveats should be added. First of all, the phenomena we will discuss are those which are relevant from the point of view of a formal semantics, and, to some extent, a formal pragmatics of questions and answers. Outside this field, there are certainly lots of interesting and important phenomena pertaining to questions and answers as well. And the ultimate theory should deal with these too. However, throughout we will just be concerned with questions of formal semantics, and will restrict ourselves to the kind of answers that are given in this framework.

Secondly, empirical issues are only mentioned in this

section, they are not discussed in detail. For such discussions, the reader should turn to the papers to follow, and to the literature that is referred to there. One exception to this rule is the discussion of interrogatives and presuppositions in section 3.3. Since hardly anything is said about this topic in the other papers, we discuss it in some detail here.

3.1. The semantics of interrogatives and wh-complements

In view of the independent meaning thesis, a central task for a semantic theory of interrogatives and wh-complements, is to decide upon the kind of semantic object that is an adequate formal representation of the meaning of such expressions.

Generally, two aspects of this problem can be distinguished. First of all, it should be decided of what type, or types, these objects should be. Such decisions are made within the context of a specific semantic framework which determines a range of available types. Secondly, given some type, or types, of objects that are suitable representations of meanings, a further problem is to determine which particular objects within that type qualify. One has to find out which specific properties these objects are to have.

The usual heuristics is to consider structural semantical relations. For these, in general, give important clues concerning the type of semantic object one is after. The structural relations one may take into consideration, may either be relations between expressions of the kind that is being studied, or they may be relations between such expressions and others. Especially, if the semantic type of these other expressions is (supposed to be) known, this provides valuable information.

Important structural semantic relationships concern e.g. entailment, coordination and functional application. In the light of the framework principle that throughout all categ-

ories, these should be dealt with in a uniform way, a way that is determined by the framework in which the analysis takes place, the existence and non-existence of these relations gives direct indications of the type of semantic object that is involved.

In the analysis of interrogatives and wh-complements, it seems attractive to start looking at relationships which involve indicative sentences, of which the semantic properties are most familiar. More concretely, the existence of systematic entailment relations involving indicative sentences with wh-complements, and sentences with sentential complements, gives important clues concerning the type of semantic object that is to be associated with wh-complements, and hence, in view of the equivalence thesis, with interrogatives.

Such entailment relations can be taken as a starting point. Two simple examples are the following valid arguments:

- (1) John knows whether Mary walks in the garden
 Mary doesn't walk in the garden

 John knows that Mary doesn't walk in the garden
- (2) John knows who walks in the garden
 Mary walks in the garden

 John knows that Mary walks in the garden

The existence of entailments such as these indicate that there is an intimate relation between the type of semantic object that is associated with sentential complements and that of wh-complements.

This point is underscored by the observation that the two types of complements can occur in coordinate structures, as e.g. in (3):

- (3) John knows that Peter left for Paris, and also
 whether Mary went with him, and when he will be back

A consideration having to do with functional application, and hence with compositionality, makes the same point. As (1) and (2) show, both sentential complements and wh-complements can occur as argument of the same function, the verb know. Of course, this does not hold in general, as is shown by the existence of verbs such as inquire, which take only wh-complements, and verbs such as believe, which only take sentential ones. Though this is primarily a matter of lexical semantics, it also indicates that the semantic objects associated with sentential complements and wh-complements have different properties.

So, structural semantic relations suggest a close association between the type of semantic object that corresponds to wh-complements, and given the equivalence thesis, to that of interrogatives, and the type of semantic object that corresponds to sentential complements.

Such an association squares with the answerhood thesis. For it tells us that the semantic interpretation of an interrogative should characterize a notion of semantic answerhood. As such, it also points into the direction of the existence of a relation between the semantic interpretation of interrogatives, and that of indicative sentences. The semantic content of an answer, the information it gives, is the semantic content of an indicative sentence, i.e. a proposition, or whatever is the equivalent of that in the semantic framework that is used.

The examples given above, also show that structural semantic relations may give certain indications concerning specific properties of semantic objects that are to serve as interpretation of interrogatives and wh-complements. For example, compare (1) with (4):

- (4) John knows whether Mary walks in the garden
 Mary walks in the garden
-

John knows that Mary walks in the garden

The contrast between (1) and (4) shows that situation-dependency is an important property of wh-complements. Depending on what is actually the case in a given situation, the wh-complement entails a different that-complement. Again, this squares with the answerhood thesis, since what constitutes a true answer to an interrogative will depend on the situation as well.

Other hints concerning specific properties of interrogatives and complements are given by relations of interrogatives to one another. Consider (5):

(5) Who walks?

Does John walk?

The first interrogative in (5) entails the second. Given the answerhood thesis, entailment of interrogatives can be described in terms of answerhood. One interrogative entails another if every complete answer to the first, also gives a complete answer to the second. So, in view of the validity of such examples as (5), a complete answer to a who-interrogative, must give us an answer to every corresponding yes/no-interrogative. This means that a complete answer to such an interrogative must give an exhaustive specification of the individuals that have the property the extension of which the interrogative asks for. In other words, interrogatives are requests for such exhaustive specifications.

Again, the analogous phenomenon can be observed with wh-complements. (6) is a valid argument:

(6) John believes that only Bill walks in the garden

Bill and Mary walk in the garden

John doesn't know who walk in the garden

An indication of the exact extent to which the specification that an interrogative asks for, should be exhaustive, is given by the fact that, unlike (5), (7) is not valid:

(7) Which men walk in the garden?

Which men do not walk in the garden?

Neither one of the interrogatives entails the other, for a complete answer to the one gives a complete answer to the other, only for someone who knows who the men are. So, what is a valid argument, is (8):

(8) Which men walk in the garden?

Who are the men?

Which men do not walk in the garden?

And again, there is an analogue in terms of complements. Consider (9):

(9) John knows which men walk in the garden

John knows which men do not walk in the garden

This argument is not valid, and becomes so only if we add the following premiss:

(10) John knows who the men are

These examples indicate another important property of semantic objects to be associated with interrogatives and *wh*-complements. They show that to know the answer to a certain question, may involve a certain amount of *de dicto* knowledge. In order to know which men walk in the garden, one needs to know of every man that walks in the garden, that it is a man and that he walks in the garden. An exhaustive specification of this *de dicto* nature, is what an answer should express, and hence what an interrogative asks for.

The few examples illustrate how observations concerning structural semantic relations, most prominent among them being the entailment relation, can guide us in our attempts to formulate a proper semantic analysis of interrogatives

and wh-complements. They give strong indications concerning the type of semantic object that will be an adequate representation of the meaning of these expressions, suggesting that this type is of a propositional nature. Also, they indicate that there is a uniform semantic type for all interrogatives and complements. Further, such observations as made above, also give us valuable clues concerning the more specific properties of the relevant semantic objects. Prominent among these, we consider to be the situation dependency of interrogatives and wh-complements, and their *de dicto* and exhaustive nature.

And this is what makes these issues into important empirical issues, that any semantic theory should account for. Precisely because these phenomena tell us what type of object to look for, and what specific properties it should have, they are of central importance. It should be borne in mind that it are the general framework principles that tell us, beforehand, what kind of phenomena we should direct our attention to. In this sense, their importance should not be underestimated.

It is again a framework principle, viz. that of compositionality, that suggests that it is important to look out for ambiguities. Coming up with the right semantic object, is only one half of what a proper semantic theory should do. The other half is to show how the proper objects can be associated with expressions in a systematic fashion. In the formal semantics framework, adherence to compositionality means that one should show how the right semantic interpretation can be derived compositionally from the interpretations of the parts. Then, ambiguities become an important phenomenon. For, every structural, i.e. non-lexical, ambiguity, is to correspond to a different derivational structure. And that means that ambiguities can give good indications as to how expressions are to be derived, and how meanings are to be composed.

For this reason, discussions of ambiguities, and how to account for them, are a prominent subject in many papers

in formal semantics of natural language, and papers on the semantics of questions, including the ones to follow, are no exception to this rule.

Of course, the ambiguities that count, are those that are specific for interrogatives and *wh*-complements, i.e. those that do not occur also in analogous indicative constructions. A simple example is provided by the following sentence:

(11) Which student did every professor recommend?

This interrogative is threefold ambiguous. As is generally the case with interrogatives, the ambiguity shows in the different ways in which (11) can be answered:

(12) John.

(13) Professor Jones, John; professor Williams, William;
professor Peters, Peter

(14) His best one.

The difference between the first two readings, evidently is one of scope. Which reading results, which type of answer is called for, depends on the relative scope of the *wh*-phrase and the term.

That the third reading is really a distinct one, and cannot be identified with an arrangement of scopes, is shown by the fact that (15) can be answered by (16), and not by (17):

(15) Which student did no professor recommend?

(15) *Professor Jones, John; professor Williams, William;
professor Peters, Peter

(16) His worst one.

Two other examples of ambiguous interrogatives, which by being ambiguous tell us a lot about how interrogatives should be derived and what their proper semantic interpretation is, are (17) and (18):

- (17) What did two of John's friends give him for Christmas?
 (18) Where do they have all books written by Nootboom in stock?

The first, perhaps less likely, reading of (17) inquires after the nature of some present that John got twice. The more likely reading is the one which asks to specify for two of John's friends what each of them gave John for Christmas. Notice, that on this reading, the interrogative leaves the addressee a choice. She may pick any two friends of John's, and answer for each of them the question what he or she gave him. The particular importance of this type of reading, is that it shows that interrogatives may have more than one complete semantic answer.

Interrogative (18) illustrates a similar point. Depending on the context, it may be given an interpretation on which it asks for an exhaustive listing of all decent bookshops, or it may be taken to ask to mention some bookshop where I can buy Nootboom's oeuvre.

These few examples may serve to show that an account of ambiguities is an important empirical issue in the theory of questions, not because they are always that interesting per se, but because they reveal important properties of the semantic objects to be associated with interrogatives, and of the way in which these are to be composed.

3.2. Questions and answers

The phenomena indicated in the previous section all concern the semantic interpretation of interrogatives and *wh*-complements as distinct kinds of linguistic expressions. As such, they are, of course, of central importance, but clearly, they do not constitute the whole story. Interrogatives express questions, and where there are questions, there are, fortunately, also answers. And a satisfactory theory of interrogatives will have to deal with them as well.

This is what the answerhood thesis says. This principle states that the semantic interpretation of interrogatives should tell us what the answers are that can be given to the questions expressed by these interrogatives. In our discussion of the answerhood thesis in section 2.2.3, we expressed our opinion that it should be taken in a broad sense. It is not sufficient that the semantic object associated with an interrogative determines some notion of answer, it should be a notion on which a systematic theory of answerhood can be founded.

This opinion is based on our conviction that, although it is possible and meaningful to study the semantics of interrogatives in isolation, the ultimate test is whether the results that are obtained that way, can be extended into a wider theory, one that takes into account the ways and purposes for which interrogatives are used. If one takes a closer look at that, one sees that pragmatics is involved in an essential way. Questions signal gaps in one's information, and are used to get these gaps filled. And answers are attempts to fill in such gaps. The relationship between questions and answers cannot be viewed properly without taking this informational perspective into account.

If one considers in some more detail various phenomena concerning the relations between questions and answers, one observes on the one hand a great variety, and on the other hand a clear system. In this, the notion of available information plays an essential role. Hence, a purely semantically defined notion of answerhood, whatever it covers, cannot be adequate. Either it is too restricted, excluding all kinds of normal cases, or it will be too liberal, accounting for the variety, but not for the systematic relationships. For that reason, we do not interpret the answerhood thesis as a requirement to construe the semantic interpretation of interrogatives in such a way that it tells us all about answers. This it will never be able to do. Our interpretation is that the semantics should give us a good fundament to base a pragmatics on.

As a simple example of the variety of answers that can be given, consider the following:

- (19) Whom did John kiss at the party last night?
- (20) Mary.
- (21) The girl from next door.
- (22) A redhead.

The three answers (20), (21), and (22) have clearly different semantic characteristics, yet they may all serve as answers to the same interrogative (19).

The first answer, (20), in a certain sense is a model one. It indicates who the person that John kissed last night was by giving a name, i.e. by using a rigid identification, one that is tied uniquely to one and only one person. It is a standard answer, one that is supposed to work in all cases for all questioners.

The second answer is typically not of that chosen semantic kind. Descriptions are not uniquely tied to one and the same referent all of the time, as names are. Yet, it is easy to think of a situation in which it is a good, complete answer to (19). And it is also easy to see what aspect of that situation is responsible for that: available information. If I know who the girl from next door is, (21) answers my question completely. But if I don't, it doesn't.

These are two simple, but important facts that a theory of questions and answers should account for. First of all, there exists a kind of answer that is standard, that uses designations that are semantically rigid, and that hence does not depend on available information, or at least is not supposed to depend on that. Secondly, non-standard answers may be as good as standard ones, given a suitable information structure. So, there are at least two major classes of answers, semantic ones and pragmatic ones.

Another opposition within the totality of answers is illustrated by the third answer to (19), (22). This answer differs from the former two in that it is indefinite. Whereas (20)

and (21) each in their own way are definite identifications of one individual, this does not hold for (22). Without any specific assumptions about available information, (22) will not be a complete answer to (19), but only a partial one. It gives some information, e.g. that John didn't kiss Suzy, who is a brunette, but it does not identify the one that John kissed. Unless of course some, in this case rather specific, information is available, such as that only one redhead attended the party, viz. Jane. In that case (22) is a complete answer.

This simple example illustrates another major opposition in the totality of answers, that between partial answers and complete answers. It also illustrates that what answer results, depends in general on two factors: the semantic characteristics of the linguistic expressions involved, and the information that is available.

A general theory of answerhood hence has to build on two notions: semantic interpretation on the one hand, and information of speech participants on the other. The role of the semantic interpretation of the interrogative in this then seems to be to characterize the information-independent notion of a standard semantic answer. Starting from that, the theory will develop other notions of answerhood such as hinted at above, give an account of their systematic interrelations, and show how semantic characteristics of linguistic expressions are related to various notions of answerhood.

Answers form an important empirical issue also in another way. The relationship between interrogatives and linguistic answers has some particular problems to offer, the solution of which in its turn bears on the syntactic and semantic derivation of both.

The first phenomenon that a theory of interrogatives and linguistic answers should come to grips with, is that linguistic answers typically come in two varieties. They may have the form of a constituent, or they may consist of a full sentence. There has been some debate in the literature

about the relation between the two. Some hold that constituent answers are primary, others that sentential ones are, and others again do not care. To us, the relevant empirical issue seems to be that both exist, and are systematically related. The most striking aspects of the relation between interrogatives and linguistic answers, apply to both varieties.

The most important phenomenon to be observed, is that the interpretation of a linguistic answer depends on the context of an interrogative. Consider the following examples:

- (23) Who walk in the garden?
- (24) Which men walk in the garden?
- (25) John and Bill.
- (26) John and Bill walk in the garden.

The interpretation of both the constituent answer (25) and the sentential answer (26) depends on the context of the interrogative. As answers to (23), (25) and (26) convey that John and Bill are the ones that walk in the garden. As answers to (24), they express that John and Bill are the men that walk in the garden. As answers to (23), they would not be true and complete if Mary walks there too, as answers to (24) this would not affect their being true and complete.

This has two consequences. It indicates that the derivation and interpretation of linguistic answers needs the syntactic and semantic structure of the interrogative. And it tells us something about the semantic analysis of interrogatives as well: at some level, it should contain a syntactic and semantic unit that can be used in the syntactic and semantic derivation of linguistic answers.

This concludes our discussion of the second area in the empirical domain, centered around the question-answer relation. By the answerhood thesis, it is firmly linked to the first area, concerning the semantics of interrogatives and *wh*-complements. In characterizing a notion of a standard semantic answer, semantics provides the basis for an overall theory of answerhood, which has to take into account the pragmatic function of question-answering.

3.3. Interrogatives and presuppositions

Several proposals for the semantic analysis of interrogatives take presuppositional phenomena to be an integral part of their empirical domain.¹⁹ Others have argued that one need not do so.²⁰ In our own proposal, as it is developed in the papers to follow, the phenomenon of presuppositions is largely ignored. Not because we think it to have no significance at all, but because we believe it to lie outside the realm of semantics proper. The present section is meant to provide some arguments for this position.

In discussing interrogatives and presuppositions, we are not concerned with presuppositional phenomena that interrogatives share with indicative expressions. Consider e.g. (27) and (28):

(27) When did John stop smoking?

(28) John stopped smoking

The interrogative (27) and the indicative sentence (28) share the presupposition that John has smoked. It may safely be assumed that any correct analysis of this presupposition of (28), can be made to work for (27) as well.

What we are interested in here, is whether there are presuppositional phenomena which are specific for the use of certain wh-terms, or for certain interrogative constructions, and if so, what their nature is. Two relevant examples are (29) and (30):

(29) To whom is John married?

(30) Do you want coffee or do you want tea?

It is often assumed that the interrogative (29), c.q. the one who uses it, presupposes that John is married to someone.

This existential presupposition is then associated with the lexical meaning of the wh-term who. The interrogative (30) is sometimes associated with two presuppositions: that the addressee wants coffee or tea, and that he does not want both. The alternative interrogative construction is taken to presuppose that exactly one of the alternatives will prove to be the case. So, besides an 'existential' presupposition, a uniqueness presupposition is observed.

Singular forms of wh-terms, such as who or which book, are also often assumed to carry a uniqueness presupposition, besides an existential one. So, (31) would presuppose that only one person, and (32) that only one book, is involved:

(31) Who has made this mess?

(32) Which book did you bring back to the library?

Uniqueness is considered to be more strongly involved with wh-terms containing the wh-determiner which, than with such wh-terms as who. This even in case the latter occurs as the subject of a verb in the singular form, as is the case in (31).

The controversy about the nature of presuppositional phenomena, and hence about the proper way to account for them, has not yet been settled. The various positions that have been taken in the past, all still have defenders today. This is not to say that no progress has been made. The strongpoints and weaknesses of the different approaches are much clearer than they were in the past, more empirical material is brought under attention, and the various proposals have been worked out more explicitly.²¹

This is more true for presuppositions of indicatives, then for those of interrogatives. But, in case of the latter, the two main views on the nature of presuppositions, the semantic and the pragmatic view, have their proponents too.

From the semantic point of view, presupposition failure in case of an interrogative, results in its failing to have a (true or false) answer. In case an interrogative has a

certain presupposition, and is used in a situation in which this presupposition is false, the interrogative cannot be answered, but has to be rejected. An appropriate response to the question in such a situation, would not be an answer, but a mere reply. This corresponds to an indicative sentence lacking a truth value, in case one of its presuppositions is not fulfilled. And this parallel is a rather direct consequence of the answerhood thesis, which tells us that where semantics states truth conditions for indicatives, it states answerhood conditions for interrogatives. A semantic analysis of presuppositions, characterizes them as a kind of pre-conditions in both cases.

On the pragmatic view, presuppositions of interrogatives are reflections of certain expectations the questioner has about the answer. On this view, failure of presupposition does not imply failure of answerability, it just means that the answer will contravene expectations on part of the questioner.

Perhaps it is useful to point out that one need not choose between these two views, in the sense that one has to regard all presuppositional phenomena to belong to one and the same class. It is not a priori impossible that some presuppositions are semantical, and others are pragmatical. What would distinguish between the two in case of an interrogative, would be that failure of the former would result in unanswerability, whereas failure of the latter would not.

A main problem is, that this distinction presupposes a clear observational difference between answers and mere replies. Though there certainly are cases on which there is general agreement, the notions of answer and reply are too theory dependent for a systematic classification of presuppositional phenomena to be based upon them. As the literature shows, presuppositions of interrogatives, as such, seem to belong to the large class of phenomena, the status of which is debatable. We, for our part, tend to believe that only those presuppositions which interrogatives share with indicatives, constitute clear cases in which failure results in

unanswerability. A typical example is the presupposition of the interrogative (27), discussed above. It seems that (33) can be characterized indisputably as a rejection of the question:

(33) John never smoked in the first place

The other cases of presuppositions, those which are connected with the use of certain wh-terms and certain interrogative constructions, are far less clear. The existential and uniqueness presuppositions can often, at least partly, be related to the meaning of other components of the interrogative, or to certain aspects of the context. Many examples of interrogatives that do carry a presupposition can be contrasted with similar ones that do not. Consider the following three interrogatives:

(34) Who is that?

(35) To whom is John married?

(36) Who is coming with me?

Clearly, (34) has an existential presupposition, in particular if that is used demonstratively. But it seems that in this case, the presupposition is triggered by the use of the demonstrative, rather than by the wh-term. For, consider (35). In this case, it is not clear why the answer To nobody, could not be regarded as a satisfactory answer to the question, rather than as a mere reply that rejects the question. This is even more clear in case of (36), in which Nobody seems perfectly allright as an ordinary answer. The existential presupposition, as an expression of the expectation of the questioner, is stronger in case of (35) than in case of (36).

As for the uniqueness presuppositions, it appears that they too, should be regarded as a suggestion, an expectation, on part of the speaker. Their occurrence cannot be tied to specific aspects of the grammatical form of an interrogative,

viz. to it having a singular, c.q. a plural form. Other factors, grammatical and non-grammatical, seem to be involved. The following pair of examples illustrates this:

- (37) (a) Who is in favour of the proposal?
 (b) Who are in favour of the proposal?

In our opinion, (37) (a) and (b) are both neutral with respect to uniqueness: neither one carries a suggestion to the effect that there is only one, c.q. that there is more than person in favour of the proposal. This holds most clearly in a situation in which (37) (a) or (b) is used by a chairman, as part of a voting procedure. Notice, by the way, that in this case the existential presupposition is absent as well. Since chairmen are supposed not to give expression to their personal expectations in conducting formal procedures, and since both interrogatives seem to be quite appropriate phrases to be used by them in performing such procedures, the conclusion seems warranted that these interrogatives do not carry a (non-) uniqueness or existential presupposition. For, if they would, it would be inappropriate for the chairman to use them. One could say that it is the context of a person acting in such an official capacity, that cancels such suggestions, if any there are.

As can be observed by comparing (37) (a) and (b) with the pair (38) (a) and (b), the facts are slightly different for interrogatives with such wh-terms as which member(s):

- (38) (a) Which member is in favour of the proposal?
 (b) Which members are in favour of the proposal?

It seems that, whereas the plural form of (38) (b) is neutral with respect to (non-) uniqueness, the singular form (38) (a) does carry a uniqueness suggestion. This is reflected by the observation that a chairman will tend to use (38) (b) in a voting procedure, and not (38) (a).

That in these cases as well, non-grammatical, contextual

factors play a role, becomes clear if one compares the following two pairs of interrogatives:

- (39) (a) Which member of the cabinet voted against the proposal?
 (b) Which members of the cabinet voted against the proposal?
- (40) (a) Which member of the cabinet leaked the information to the press?
 (b) Which members of the cabinet leaked the information to the press?

It seems that, whereas of (39) (a) and (b), the plural form (b) is the neutral one, in that it carries no suggestion as to the actual number of people involved, the reverse holds for (40) (a) and (b). Of the latter two, the singular form (a) seems to be neutral, and the plural form (b) marked.

Perhaps, this can be explained along the following lines. In some sense, the 'normal' situation that calls for voting, is one that involves two 'pluralities': those who are in favour, and those who are against. Only one person holding a position that is opposed to that of all the others is a marked case, though certainly not excluded. This suggests that if the number of people who voted in a certain way is not known, the question as to their identity (or after their number, as in 'How many ...?'), should be phrased in the plural form. Only if it is (supposed to be) known that only one such person is involved, the singular form is appropriate.

On the other hand, leaking a certain piece of information, typically seems to be an individual activity, though certainly, several people could be involved in it as well. Therefore, it seems that the 'normal', the neutral and unmarked situation, calls for the singular form. The plural form seems to be appropriate only if it is suspected that more than one person is involved.

These considerations once more seem to warrant the conclus-

ion that there is no clear grammatical relation between singular and plural forms of wh-phrases on the one hand, and existential and uniqueness presuppositions on the other. Rather, it seems that these presuppositions arise from the interplay of the way in which properties of certain types of activities are conceptualized, and certain expectations about the actual situation.

The discussion of these examples also makes clear that in all these cases, the relevant presuppositions are 'speaker presuppositions': they concern certain expectations that the questioner has. If such expectations fail to come out true, the result is not that the question cannot be answered, that is has no (true) answer. The one who responds to the question in such a situation, does not reject the question, but answers to it. Though he may explicitly indicate, that his answer goes against the expectations of the questioner. In this respect, there is a fundamental difference between the responses (33) to (27), and (42) to (41):

- (27) When did John stop smoking?
- (33) John never smoked in the first place
- (41) Which member of the cabinet voted against the proposal?
- (42) (actually there were two,) Brinkman and de Ruyter

Clearly, (33) is a rejection of the question posed by (27), it cannot be continued with 'last month' consistently. On the other hand, (42), with or without the qualification, does present an answer to (41). That the 'presuppositions' of (27) and (41) have a different status, can also be seen from the fact that whereas (33) cannot be continued in a way that would count as an answer, the qualification in (42), directed against the uniqueness expectation expressed by (41), has to be continued, either in a way that answers the question, or by saying that one is unable to provide an answer ('Actually, there were two, but I don't know which ones').

From this discussion, it is safe to conclude that presuppositions particular to interrogatives, are an interesting phenomenon, revealing dazzling subtleties of language and its use. We also hope to have shown that, despite their intrinsic interest, presuppositions in this area are, by and large, a non-grammatical matter, and that one is justified in ignoring them in a semantic analysis for the time being. However, it goes without saying, that in the end, they deserve proper attention of their own.

3.4. Conclusion

It was our aim in this section, to sketch some elements in the empirical domain of the theory of questions and answers. We explicitly did so from the perspective of formal semantics. An empirical domain of a certain theory is not something that is just there, but its contents and structure are at least partially determined by one's theoretical framework.

We tried to motivate a particular choice from the chaotic totality of potentially relevant phenomena, by linking them to principles underlying logical semantics in general, and the semantic analysis of interrogatives and answers in particular. In doing so, we hope to have shown that it is not a matter of pure accident that these are empirical issues that most studies in the semantics of questions and the semantics and pragmatics of answers, carried out within the tradition of logical grammar, are directed towards.

4. Three approaches to the theory of questions and answers

4.1. A general characterization

Now that we have sketched the contours of the empirical domain of the theory of interrogatives and the question-answer relation, and have formulated a few general theoretical constraints which such a theory should meet, we will turn to a short discussion of the three main approaches that can be distinguished in this field. As we do throughout, we thereby restrict ourselves to those theories and analyses which are developed within the wider framework of formal semantics. This restriction is met by quite a number of interesting descriptive and theoretical studies, more than can actually be discussed in any detail in this context.²² But fortunately, not all theories constitute radically different approaches to the syntactic, semantic and pragmatic analysis of interrogatives and of the question-answer relation. It seems that we can distinguish, overall, three main approaches, three main views on what the basic characteristics of interrogatives and answers in natural language are.

Rather than discussing any particular details of any particular theory, we will give a general characterization of these three approaches, i.e. of what particular theories within one approach have in common. It will turn out that each of these three approaches, explicitly or implicitly, concentrates on a specific part of the domain of empirical issues which we outlined in the previous section. And, as is to be expected, in the area that it treats lie its strongpoints, and often what it does not deal with contains its weaknesses. The general constraints which we discussed in section 2, in

effect connect various subfields of the empirical domain, as we saw above. They allow us to extrapolate beyond the boundaries of what a theory explicitly treats, and thus give a view of what a theory would say about phenomena it does not deal with explicitly. So, together, the empirical domain and the theoretical constraints will be of much help to us in getting a clear picture of what are the merits and what are the flaws of the three main views on interrogatives and answers that we will discuss.

A note of warning must be issued at this point. The discussion of empirical issues presented above was not entirely free of theoretical and other biases, such discussions never are, and never can be. So any conclusions that will be reached on the basis of them will be biased to a certain extent as well. This certainly holds for what we take for granted right from the start, viz. that the ways and means of formal semantics, and those of formal pragmatics for that matter too, can be and should be extended from their homeground to larger domains. Anyone who for philosophical or other reasons does not agree, will not agree with our discussion of the problems and prospects of such theories either.

The three main approaches to the theory of interrogatives and answers are often referred to as the categorial approach, the propositional approach and the imperative-epistemic approach.²³ Although, as their names indicate, these three approaches start from distinct underlying principles, these starting points are seldom discussed, and even more seldom argued for explicitly. Apparently, the excitement lies in developing and applying a certain view, in using it in description and explanation of empirical phenomena, and not in discussing its merits out of the blue. Yet, some remarks can be found that indicate a line of reasoning, and some rational reconstruction of motives is possible as well.

On the categorial view, the main semantic property of an interrogative is that it is in some sense an incomplete object, something that needs to be augmented, that something else needs to be added to. This 'something else' is, of course, an answer.

Different types of interrogatives, it is observed, call for different types of answers. And this means, so it is assumed, that different types of questions belong to different syntactic categories, and hence stand for semantic objects of different types as well. The support adduced for this point of view is mainly empiricial, and not theoretical. Observations are made, in this case primarily concerning the syntactic status of the linguistic expressions involved, and from these the conclusion is drawn.²⁴

On the propositional view the main point is that interrogatives and answers are to be analyzed in terms of propositions. This idea can be developed in various ways. The main implicit or explicit motivation for the propositional view seems to be twofold. First of all, it is observed, and this is really rather uncontroversial, that answers to interrogatives convey information, and that interrogatives may be used to express requests for information. This leads naturally to the notion of a proposition, the formal semanticist's main tool for dealing with the informational content of linguistic expressions. So one rather obvious reason for upholding the propositional view has to do with the content of interrogatives and answers. Another type of motivation for analyzing all interrogatives in terms of propositions that can be found in the literature, is of a formal rather than of a material nature. It has to do with the overall simplicity of the resulting semantic theory. Observations concerning embedding, coordination, and the like, are taken to show that, despite surface syntactical differences, interrogatives do form a uniform class. Assigning them to the same syntactic category and the same semantic type, to be defined in terms of the notion of a proposition, is assumed to lead to a simplified analysis.²⁵

Proponents of the imperative-epistemic view on interrogatives and the question-answer relation concentrate on yet another aspect, viz. the way in which interrogatives function, the purpose for which they are used. It is observed that, at least under normal circumstances, the utterance of an interrogative is meant as a request for information, as an exhortation

of the addressee to bring about a certain epistemic state in the one who asks the question. Hence, it is concluded, interrogatives ought to be analyzed as such imperatives. The semantic interpretation of interrogatives can be stated in terms of such imperative-epistemic paraphrases. It can be noticed that in this case too, the starting point of the entire approach is argued for not so much on theoretical grounds, but on the basis of empirical observations. Here a correct observation concerning the way in which interrogatives (normally) are used, is exalted to a principle on which the semantic content of interrogatives should be based.²⁶

From these rough characterizations it will already be clear that in a certain sense all three approaches can be said to deal with the analysis of interrogatives from the perspective of the question-answer relationship. But each seems to focus on a different aspect of it. For categorial theories the relation between interrogatives and answers as linguistic, syntactic expressions is of central importance. Propositional theories, on the other hand, argue more from the semantic content of answers. And in the imperative-epistemic approach the pragmatic viewpoint dominates.

So, theories within the different approaches not only have different starting points, they also tend to deal with different sets of phenomena, with different parts of the empirical domain. This will become even more clear in what follows, where we will take a closer look at the three approaches, and will confront them with some of the phenomena and constraints discussed earlier.

4.2. The categorial approach:

Under the general heading 'categorial', various theories may be grouped together which, despite obvious differences in details of implementation and even some differences in their respective aims, share a particular, distinct view on how interrogatives and answers should be analyzed. The main

proponents of this kind of theory are Hausser, Tichy and Scha, and their proposals are the ones that we will mainly draw upon in our characterization.²⁷

Common to categorial theories, as the phrase 'categorial' indicates, is the view that one should pay due attention to the categories of interrogatives and their answers. Straightforwardly opposing propositional theories, which aim at a uniform analysis, the proponents of categorial theories uphold that no uniform syntactic category of interrogatives, nor of answers, exists. Rather, they claim, a satisfactory account of interrogatives and answers requires that we respect their categorial diversity. For it is through relationships between their respective categories that relations between different kinds of interrogatives and their answers can be accounted for. In categorial theories, interrogatives and answers are first and foremost studied as linguistic objects, as specific kinds of syntactic and semantic constructions one finds in the language. They therefore tend to focus, at least at the outset, on structural, often surface syntactical, properties of interrogatives and answers. Investigation of these properties then leads to the idea that relations between interrogatives and answers are to be accounted for in terms of categorial links that hold between them.

On the basis of such observations regarding structural properties, all categorial theories subscribe to some version of the following general principle:

- (C) The syntactic category and the semantic type of an interrogative are determined by the category and type of its characteristic constituent answers

The various argumentations one can find in the literature in support of (C) all have in common that they exploit the differences that exist between two kinds of characteristic linguistic answers, viz. constituent answers and sentential answers.

Consider the following examples:

- (1) Whom did John kiss?
- (2) What happened in the kitchen last night?
- (3) Mary.
- (4) John kissed Mary.

There is a clear difference between the constituent answer (3) and the sentential answer (4). E.g. (3) can be used to answer (1), but it cannot be used to answer (2). Sentence (4) on the other hand can be used as an answer both to (1) and to (2). Evidently, constituent answers are closely tied to certain types of interrogatives, whereas the tie between sentential answers and interrogatives seems much looser.

It is remarkable that though this observation is made by several authors, they do not draw the same conclusions from it. On the contrary. Hausser, for example, claims that sentential answers, which he calls 'redundant' answers, are not interesting for a theory of interrogatives and answers since unlike constituent answers of which the interpretation depends essentially on the context provided by the interrogative, they have an interpretation of their own.²⁸ Scha, on the other hand, bases his preference for constituent answers precisely on the fact that sentential answers do need the context of an interrogative to be assigned their correct interpretation. He observes that (4) as an answer to (1) means something different from what it means in isolation, or from what it means as an answer to (2), viz. (5) and (6) respectively:²⁹

- (5) Mary is the one whom John kissed.
- (6) What happened in the kitchen yesterday is that John kissed Mary.

In fact, it seems that Scha is right. Especially if one takes the phenomenon of exhaustiveness into account, it is quite obvious that the interpretation of a sentential answer depends as much on the context provided by the interrogative as constituent answers do.³⁰

Tichy argues against what he calls the 'full-statement

theory of answerhood' on somewhat similar grounds. But his conclusions are more radical. Observing that on the full-statement theory (7) answers both (8) and (9), he concludes that the theory is simply false:

- (7) Jimmy Carter is the president of the U.S.
- (8) Who is the president of the U.S.?
- (9) What is Jimmy Carter the president of?

For, he says: "It would plainly be absurd to say that (8) and (9) have the same right answer".³¹ This is certainly true, but rather misses the point. The only thing such examples show against a propositional theory is that, in assigning an interpretation to sentential answers, it must take into account the context of an interrogative.

Although the reasons for doing so are not always the same, all proponents of categorial theories focus on the relationship between interrogatives and constituent answers. The existence and non-existence of a categorial match between interrogatives and constituent answers, is taken to determine the syntactic category and the semantic type of interrogatives. The categorial definition of an interrogative is chosen in such a way that in combination with the category of the constituents it allows as answers, the category of sentences results. Thus, (10), (11), (12) and (13) are all assigned different syntactic categories:

- (10) Who walks in the garden?
- (11) Which man loves which woman?
- (12) Where did John and Mary meet for the first time?
- (13) Does John love Mary?

Each of these interrogatives has its own particular kind of constituent answers, e.g. those in (14), (15), (16) and (17) respectively:

- (14) John.
 (15) The tall one, the redhead; and the small one, Mary.
 (16) In Paris.
 (17) No.

Clearly, each of these answers matches only one of the interrogatives. Hence, from the category of the constituent, the category of the interrogative is deduced. Consequently, (10) is regarded as denoting a property of individuals, (11) as denoting a relation between individuals, and so on.

The categorial match between interrogative and answer can be construed in various ways. Tichy and Scha construe it in terms of identity of extension, Hausser in terms of functional application. In the latter case there are two options: one could let the interrogative be the function of the answer, or vice versa.³²

Which of all these possible ways of implementing the categorial view is taken depends on various factors, such as the kind of phenomena one is primarily interested in, what kind of constituent answers one wants to allow for, independent motivations for assigning a certain interpretation to interrogatives, and so on.³³

From these basic characteristics of the categorial approach, it will be clear that categorial theories are mainly concerned with interrogatives and characteristic constituent answers. And, disregarding all kinds of criticisms of detail, it can be said that they are pretty successful in this specific area.³⁴ They all account for the fact that constituent answers depend for their interpretation on the context provided by the interrogative. Moreover, their approach is flexible enough to take into account constituent answers of a wide variety of types. They are not restricted to just rigid, definite answers, but can account also for indefinite and non-rigid answers.

However, even in this area, some serious criticisms can be raised against the categorial approach. Since categorial theories concentrate on interrogatives and answers as linguistic expressions, and impose categorial fit as

virtually the only condition on their relation, the account of the question-answer relation that results is rather superficial. Apart from the fact that concentrating on categorially matching interrogative-answer pairs, they disregard other types of linguistic answers, the main problem is that the account that categorial theories offer does not lead to a proper theory of the question-answer relation. What one wants is first of all a systematic theory about different notions of answerhood. There are complete answers, partial answers, semantic answers and pragmatic answers, and so on, and these are all systematically related. And secondly, one would like to give an account of the systematic relationships that exist between semantic and pragmatic properties of constituent answers and such notions of answerhood. The categorial approach accounts e.g. for the fact that answers need not be rigid, but it does not tell us under what circumstances non-rigid answers can be equally good as rigid ones.

As a theory about interrogatives and answers as linguistic expressions, the categorial approach has certainly led to insights that should be incorporated in an overall theory of the question-answer relationship, but it does not in itself constitute such a theory. Nor can it be expected that the categorial approach can be extended to such a theory without a major modification of its starting point. For, a general theory of questions and answers will have to be based upon a general characterization of the notion of answerhood and the notion of a question. And that will be forthcoming only if one interprets interrogatives and answers in a uniform way, something that is quite alien to the spirit of the categorial approach.

This lack of a uniform interpretation of interrogatives within the categorial approach has serious drawbacks in other areas in the theory of interrogatives as well. As we saw in section 3.1, there are entailments between interrogatives, not only between interrogatives within the same category, such as e.g. in (18), but also between interrogatives that are assigned different categories within this

approach, such as the ones in (19):

- (18) Which men walk?
 Which men talk?

 Which men walk and talk?
- (19) Who walks in the park?
 Does John walk in the park?

The notion of entailment between interrogatives, like that of entailment between expressions of any other category, should be an instance of a general definition that applies to all semantic objects one's framework acknowledges. Basically, this general definition defines entailment between any two objects of a certain type as inclusion of one in the other.³⁵

It is easy to see that any categorial theory will account at most for entailments that hold between interrogatives that are associated with the same type of semantic object. Hence, such theories can account for an example like (18). But all cross-categorial entailments are left unexplained, such as the quite basic entailment relation exemplified in (19).

The same problem reappears if we look at coordination of interrogatives. Consider (20) and (21):

- (20) Who went out for a walk? And who stayed home?
 (21) Who went out for a walk? And did they take the dog
 along?

Like entailment, coordination of interrogatives should be an instance of a general rule that predicts what, for any category, coordination of elements in that category amounts to. Classifying constituent interrogatives and yes/no-interrogatives as belonging to different categories, as lies at the heart of the categorial approach, makes it impossible to account for such coordinated interrogatives as (21) in a standard way. So, a uniform semantic interpretation of interrogatives seems to be called for, not only for developing a

systematic theory of answerhood, but also for an adequate account of entailment and coordination.

This need for one type of semantic object that all interrogatives share, is underscored by another weakness of categorial theories, viz. the lack of a decent analysis of wh-complements. Most categorial theories do not even seriously attempt to develop a theory of wh-complements, and if they do, the result is generally poor.³⁶ Assuming something like the equivalence thesis, it will be obvious that the categorial approach faces serious difficulties. Not only does the proliferation of categories of interrogatives lead to a similar proliferation of categories of wh-complements, and hence of complement embedding verbs, the systematic relationships that hold between wh-complements and sentential complements show once more that a satisfactory account of interrogatives that meets the equivalence thesis has to be based on a uniform semantic analysis.

From these considerations, we can draw the following conclusion. The view that the categorial approach takes, leads to a reasonably adequate account of the relation between interrogatives and constituent answers. In this area lie its main contributions to the theory of interrogatives as a whole. As for other parts of the empirical domain, among which are some which are quite essential to a formal semantic approach, the starting point seems to be too narrow, and does not lead to adequate results which are in agreement with theoretical constraints one would like to impose on semantic theories in general, and on analyses of interrogatives and the question-answer relation in particular.

4.3. The propositional approach

Common to all theories in the propositional approach is that they associate with interrogatives a semantic object that is defined in terms of the notion of a proposition. As was the case in the categorial approach, the theories within this

one differ in details of implementation, and sometimes even in the interpretation of what their main objective is. But, it seems that they all share three considerations regarding the way in which interrogatives should be analyzed. First of all, it is taken for granted that answers are essentially of a propositional nature. Answers convey information, and information is coded in propositions. Secondly, it is assumed that the notion of an answer should play a role in the characterization of the semantic object to be associated with interrogatives. And finally, there is a tendency to treat all interrogatives uniformly, i.e. to associate them all with one and the same kind of semantic object.

So, it seems that the gist of the propositional approach can be formulated in the following general principle:

- (P) The semantic interpretation of an interrogative should give its answerhood conditions, i.e. it should determine which propositions count as its semantic answers

It should be noted that neither this principle, nor the considerations that lead to it are always explicitly stated or argued for at the outset. But the principle does characterize the main examples of propositional theories, those of Hamblin, Karttunen, and Bennett and Belnap. And in each of them, some of these considerations can be found, be it sometimes only implicitly.

If we compare the principle (P) with the competing principle (C) underlying categorial theories, the difference in the initial perspective becomes clear. Categorial theories tend to start from considerations concerning surface syntactic properties, whereas propositional ones proceed from observations of a logical semantical nature. Consequently, they focus on different aspects, and, as we shall see, with regard to their strong and weak points they are mirror images.

The oldest, the best known, and the least understood propositional approaches are those of Hamblin, Karttunen and, Bennett and Belnap respectively.³⁷ All three assign the same

type of semantic object to interrogatives, viz. a set of propositions. The interpretation they give of this object, however, differs. For Hamblin this set consists of the possible answers to the interrogative. Karttunen, on the other hand, takes the set of propositions denoted by an interrogative to consist of the true answers to it. As a matter of fact, the difference between Hamblin's interpretation and Karttunen's is marginal from a material point of view. This is obscured by the fact that the respective analyses are worked out in different frameworks. Karttunen's approach has some formal advantages however, that is why we will mainly use his interpretation.³⁸

The difference between Karttunen on the one hand, and Bennett and Belnap on the other, is very real. According to the latter, each proposition in the set denoted by an interrogative constitutes in itself a complete and true answer. Their concern is the existence of interrogatives which have more than one complete and true answer, interrogatives of the kind discussed in section 3.1. The propositions in the set Karttunen associates with an interrogative are partial true semantic answers. Only jointly, they constitute a complete and true semantic answer. Unlike Bennett and Belnap's scheme, Karttunen's analysis is only attuned to interrogatives which have a unique true and complete semantic answer at each index.³⁹

Since propositional theories assign a uniform semantic type to all interrogatives, it seems reasonable to expect that they do better where categorial theories fail, viz. in accounting for answerhood, and for entailment and coordination of interrogatives. This is true, but only to a certain extent. Consider answerhood first. To begin with, it should be noted that although the notion of a semantic answer figures prominently in the descriptions various theories give of the semantic interpretation of interrogatives, neither one of them provides a theory of answerhood that is worked out in any detail.⁴⁰ But from their interpretation of interrogatives a relation of answerhood can readily be deduced.

In Karttunen's framework a sentence is a complete and true semantic answer to an interrogative if the proposition that the former expresses equals the conjunction of the propositions in the set denoted by the latter. For Bennett and Belnap a sentence is a complete and true semantic answer to an interrogative if the proposition it expresses is an element of the set denoted by the interrogative.

It might look as if for interrogatives which have a unique complete and true semantic answer, the results Karttunen and Bennett and Belnap get are the same, but this is not the case. There are some not unimportant differences, which, of course, are due to differences in the way in which interrogatives are derived. Let us illustrate this with an example:

(22) Which man walks in the garden?

In Karttunen's scheme, (22) denotes all true propositions which of an actual man say that that individual walks in the garden. So, if John, Bill, and Hilary are the men that walk in the garden, (22) denotes a set consisting of three propositions: that John walks in the garden, that Bill walks in the garden, and that Hilary walks in the garden. Notice that these propositions do not state of the individuals that they are men. They are *de re* characterizations, so to speak, of the men that walk in the garden. At this point there is a difference between Hamblin and Karttunen. If we take the true ones from Hamblin's possible answers, we would get, in this case the following three propositions: that John is a man and walks in the garden, that Bill is a man and walks in the garden, and that Hilary is a man and walks in the garden. So, Hamblin's propositions give *de dicto* characterizations. In view of the observations made in section 3.1. concerning (non-)entailment of interrogatives, and those concerning the *dicto/de re* ambiguity of *wh*-complements, which in view of the equivalence thesis are the same facts, it seems that one's framework should at least contain the possibility of *de dicto* characterizations.

Bennett and Belnap do get de dicto characterizations. They also differ from Karttunen in that they analyse (22) as having a uniqueness presupposition, so in the situation under discussion, (22) would not have a complete and true answer, it would denote the empty set. If we change the example to (23):

(23) Which men walk in the garden?

The result will be a singleton set of propositions, containing the proposition that the men that walk in the garden are John, Bill and Hilary. So it seems that, unlike Karttunen, to a certain extent, Bennett and Belnap build in exhaustiveness. (See section 3.1.)

From these remarks, it can be concluded that the account that propositional theories give of the answerhood relation, as far as this account can be deduced from the interpretation they assign to interrogatives, is a rather restricted one. Only answers that give rigid and definite characterizations are counted as semantic answers. Indefinite answers, non-rigid answers, partial answers, fall outside its scope, and so do pragmatic notions of answerhood. The only notion of answerhood they reckon with is that of, what we have called in section 3.2. a standard semantic answer. As such, this is not something to blame them for. Not only is the notion of a standard answer one that one would a theory of answerhood to characterize, also there seem to be no real obstacles for extending a propositional account to a full theory of answerhood.

More fundamental problems arise if we look at what happens with entailment and coordination in these propositional theories. The kind of semantic objects they assign to interrogatives is for all of these the same, and, moreover, is one that in principle makes it possible to apply the general definitions of entailment and coordination. However, if we apply these general definitions we find that even quite basic entailment-relations are not accounted for, and that simple coordinations come out wrong as well.

Since entailment is defined as inclusion, interpreting interrogatives as denoting sets of propositions implies that one interrogative entails another iff the denotation of the first is always included in the denotation of the other.⁴¹

Consider Karttunen's theory first. It is easy to see that such a basic entailment as holds between (24) and (25) is not predicted:

- (24) Who walks in the garden?
 (25) Does John walk in the garden?

Clearly, it does not hold that in all situations the set of propositions denoted by (24) is a subset of the set of propositions denoted by (25). A yes/no interrogative, such as (25), always denotes a singleton set, containing either the positive or the negative answer. And a who-interrogative like (24) will contain a proposition for every individual that satisfies the predicate. So, except for some marginal cases, no entailments between such constituent interrogatives and the corresponding yes/no-interrogatives are predicted.⁴²

Similarly, a simple coordination such as (26) is assigned a wrong interpretation if we apply the standard definition of conjunction, which comes down to intersection:

- (26) Whom does John love? And whom does Mary love?

Since the two sets denoted by the conjuncts of (26) are disjoint (or both empty), Karttunen's analysis predicts that (26) has no answers at all.

These considerations clearly indicate that the Karttunen framework simply assigns the wrong type of semantic object to interrogatives. In a sense, there is something inconsistent in describing an interrogative as determining at each index what its complete and true semantic answer is, and at the other hand letting its denotation be a set of propositions. The complete answer is the conjunction of these propositions. So, one would rather expect the type of interrogative

denotations to be that of propositions, instead of sets of propositions. And indeed, this would give better results. In Karttunen's case, the problem with conjunction would disappear.

However, the basic entailments of the kinds discussed above, would then still be left unaccounted for. And this suggests that even if we rephrase Karttunen's analysis so as to give the right type of semantic object, it still would give the wrong objects of that type.⁴³ And this, in its turn, implies that there is something basically wrong also with Karttunen's account of answerhood, even if we restrict ourselves to the basic notion of standard semantic answers. Especially within the propositional approach, of which the starting point is that the semantic interpretation of an interrogative should give its answerhood conditions, entailment and answerhood are but two sides of the same coin. Entailment is inclusion of denotation, denotation determines answerhood, hence, one interrogative entailing another comes down to every proposition giving an answer to the first, also giving an answer to the second. Intuitively, (24) entails (25). And, indeed, this intuition seems to be no other than the one that in every situation in which we get a complete answer to (24), we also get a complete answer to (25). So, Karttunen's failure to account for entailments such as these, means that the interpretations he assigns to interrogatives do not, as the basic principle of the propositional approach requires, give their proper answerhood conditions.

Although the interpretation of the set of propositions that Bennett and Belnap assign to interrogatives as their denotation differs from that of Karttunen, the problems with entailment and coordination are structurally the same. For just consider interrogatives which do have a unique complete and true semantic answer, such as the examples discussed above: any two different such interrogatives will denote disjoint (unit) sets. This predicts that no two such interrogatives are related by entailment, which is obviously wrong, and that the conjunction of any two such interrogatives will

denote the empty set, i.e. has no answer, which is not right either. So, the same conclusions can be drawn as in Karttunen's case: the Bennett and Belnap theory assigns the wrong type of semantic object to interrogatives. Since they want to account for interrogatives which have more than one complete answer, it will not do in their case to simply form a simple propositional object from the sets they define. In this case, we have to look for a solution in another direction.⁴⁴

As for the treatment of wh-complements, propositional theories do fare better than categorial ones, first and foremost in that they assign them a uniform semantic type, thus avoiding the proliferation of types the categorial approach leads to. Further it can be remarked that, in view of the equivalence thesis, the same problems that occur with interrogatives will reappear with wh-complements. Notice that here too there is evidence that the type assigned is the wrong one. If in Karttunen's case we would proceed from sets of propositions to single propositions, we would gain a uniform analysis of both wh-complements and that-complements, which leads to a considerable simplification, at least.⁴⁵

One of the main weaknesses of the propositional approach is that its theories generally provide a poor basis for dealing with linguistic answers. As we saw in section 3.2. both sentential answers and constituent answers essentially need the context provided by the interrogative for their proper interpretation. Consider the simple example (27):

(27) Whom does John love? Mary.

In a propositional theory anyway, the constituent answer Mary. in (27) should express a proposition. The natural way to achieve this is to combine the term phrase interpretation with a property. At the characteristic level of propositional theories, viz. that of (sets of) propositions, this property is not available.⁴⁶ In the propositional theories discussed here, there is a level of analysis, however, at which we can isolate a property. Both in Karttunen's and in Bennett and

Belnap's framework, the derivation of interrogatives starts from open sentences. These are turned into a kind of yes/no-interrogatives, which are further transformed into constituent interrogatives by introducing wh-terms. The open sentences define properties, but not in all cases this is the property which is needed to get the right interpretation of the linguistic answers. Compare (27) with (28):

(28) Which nurse does John love? Mary.

In the theories under discussion, both interrogatives are derived from one and the same open sentence (29):

(29) John loves x

But the answers in (27) and (28) express different propositions. In (27) the answer expresses the proposition that Mary is the one whom John loves, whereas in (28) it expresses that Mary is the nurse that John loves.

These considerations show that the propositional theories of Karttunen, and Bennett and Belnap do not lead to a proper account of linguistic answers, but not of course that no propositional theory could. It seems reasonable to conclude that in order for a propositional theory to deal with the interpretation of linguistic answers adequately, it will have to 'look like' a categorial theory in important respects, at least at some level of analysis. This suggests that a more encompassing theory of interrogatives should combine the forces of both the categorial and the propositional approach. From the latter it should incorporate the propositional view on answerhood and the consequent uniform definition of the semantics of interrogatives in terms of answerhood conditions. From the former it should take over the categorial analysis as an underlying level from which linguistic answers can be derived, thus accounting for the fact that their interpretation depends on the interrogative. In that way, more kinds of answers than just the rigid and definite ones that

propositional theories allow for, can be brought within the scope of such a theory. Of this enriched domain of answers one wants a systematic theory that predicts and explains under what kind of circumstances what kind of linguistic answers correspond to which notions of answerhood. There, another point of view becomes important, which is that of the third main approach to interrogatives, the imperative-epistemic one.

4.4. The imperative-epistemic approach

The last main approach to the theory of interrogatives that can be discerned in the formal semantics tradition, is the imperative-epistemic one. It should be noted right at the outset that this approach differs from the categorial and the propositional view considerably. It does not just take another perspective, it also has a rather different aim. Whereas all the theories we have discussed so far are descriptive in this sense that they aim at a description and an explanation of how interrogatives function in natural language, the theories within the present approach are directed rather differently. This certainly holds for the original work of Aqvist, whose primary interest is in a logical theory of interrogatives.⁴⁷ In developing such a logical theory the relation with natural language is a subject of relatively minor importance. The work of the other main proponent of the imperative-epistemic approach, that of Hintikka, is more explicitly oriented towards natural language.⁴⁸ But his analysis does not aim at developing a systematic theory of interrogative expressions in natural language, at least not in the way that the other theories do. Since, however, the relationship with natural language in Hintikka's work has a more prominent place than in Aqvist's, we will draw mainly on the former in our characterization of the aims and methods of the imperative-epistemic approach.

What guides the analysis of interrogatives in this approach

is the way in which they function in ordinary communication. In normal circumstances, the utterance of an interrogative is meant as a means to acquire information. It functions as an exhortation to provide the questioner with certain information, characterized by the content of the interrogative. The semantic content of an interrogative then is identified with such a request. In other words, theories in this approach subscribe to something like the following principle:⁴⁹

- (IE) The semantic interpretation of an interrogative is a request for information (knowledge)

Generally, the semantic interpretation of an interrogative contains two elements, an imperative one and an epistemic one. These appear explicitly in the paraphrase that according to principle (IE) can be given of an interrogative. Consider the following two examples:

- (30) Does John walk in the garden?
 (31) Bring it about that I know whether John walks in the garden
 (32) Who walks in the garden?
 (33) Bring it about that I know who walks in the garden

These examples illustrate a rather particular feature of this approach. Interrogatives are analyzed by embedding them under a sequence of two logical operators. This means that if we are to understand (31) and (33), for example, as representing the meaning of (30) and (32) respectively, as principle (IE) tells us to do, we should already know what the meaning of the embedded interrogatives is. But the latter are not assigned a meaning independent of their direct counterparts. And, given the equivalence thesis, they could not be. But then it follows, so it seems, that an imperative-epistemic paraphrase does not provide us with a proper semantic interpretation of the interrogative at all.⁵⁰ Rather, it must be viewed as a theory of pragmatics of interrogatives, as a theory of pragmatic answer-

hood relations. It is a theory not of what an interrogative means, but of how an interrogative with a certain meaning can be used. So, in fact, it presupposes a semantics rather than providing one.

This interpretation of the contribution of the imperative-epistemic approach to the theory of interrogatives and the relation of answerhood in general, can be further illustrated by considering in slightly more detail how Hintikka goes about analyzing interrogatives like (30) and (32).

As far as the content of interrogatives is concerned, the most important part of the paraphrase consists of the epistemic operator and its argument. Together they form, what Hintikka calls, the desideratum expressed by the interrogative. I.e. they give a description of the epistemic state that the addressee is asked to bring about. The desiderata of (30) and (32) can be written as (34) and (35) respectively:

(34) $K_I(\text{John walks in the garden}) \vee K_I \neg(\text{John walks in the garden})$

(35) $\exists x[K_I(x \text{ walks in the garden})]$

A few remarks are in order. First of all, the formulas (34) and (35) are not mere paraphrases, but expressions of an interpreted language, that of Hintikka's epistemic logic.⁵¹ The value of this analysis of interrogatives hence derives from the value Hintikka's epistemic logic has. But that will not concern us here.

The arguments of the epistemic operator K_I are, of course, sentential complements. As (34) shows, knowing whether ϕ is analyzed as knowing that ϕ or knowing that not- ϕ , and knowing who has a certain property, is analyzed in (35) as knowing of someone that he or she has that property. Of course, as paraphrases of the entire expressions 'knowing whether' and 'knowing who' this is correct. But, and this is important, these analyses do not assign an independent meaning to the respective wh-complements. And this exactly what the independent meaning thesis, and the compositionality constraint require. So, though

the analysis may be useful in other respects, it cannot be viewed as a semantic theory of *wh*-complements and interrogatives, at least not as one that meets the general constraints we formulated earlier. And it is hard to see how the analysis could be reformulated so as to meet these requirements after all. For it is restricted to extensional cases, essentially. 'Knowing whether' can indeed be analyzed as 'knowing that or knowing that not', but such a paraphrase is impossible for intensional constructions, such as 'wondering whether'.⁵² In fact, the existence of both extensional and intensional complement embedding verbs once more emphasizes the need for an independent semantic object that can function as the interpretation of a *wh*-complement, and of the corresponding interrogatives.

Another remark needs to be made here. As Hintikka recognizes, (35) is not the only desideratum that can be associated with the interrogative (32). It corresponds roughly with the so-called *mention-some* interpretation of the interrogative. And besides that, there is also the so-called *mention-all* interpretation, the desideratum of which Hintikka formulates as in (36):⁵³

(36) $\forall x[x \text{ walks in the garden} \rightarrow K_I(x \text{ walks in the garden})]$

Notice that this *mention-all* interpretation does not imply exhaustiveness as we discussed it in section 3.2. Consequently, it is not accounted for that on its *mention-all* interpretation, (32) entails (30).⁵⁴ An answer to (32) on its reading (36) implies positive answers to such *yes/no*-interrogatives as (30), but not their negative ones.

This brings us to the last remark, which concerns answerhood. For this we need another notion besides that of the desideratum of an interrogative, that of its matrix. The matrix is the argument of the epistemic operator in the desideratum. So, it is a formula with a free variable. An answer is a (are all) true instance(s). In this sense, the analysis indicates how linguistic answers come about.

An answer is a complete answer if its incorporation into the information (knowledge) of the questioner makes the desideratum true. Hence, it is essentially a pragmatic notion. Whether something constitutes an answer depends on the information already available. Consider (37) as an answer to (32) on the reading on which its desideratum is (35):

(37) Peter walks in the garden.

Incorporating (37) leads to (38):

(38) $K_I(\text{Peter walks in the garden})$

Whether (37) is a complete answer depends on whether the questioner knows who Peter is, i.e. whether (39) holds:

(39) $\exists x K_I(x = \text{Peter})$

For only in combination with (39) does (38) amount to (35), the desideratum of (32).

In a similar manner, complete answers to other readings of interrogatives, and partial answers, can be defined.

These considerations indicate that the major contribution of the imperative-epistemic approach lies in the pragmatics of interrogatives and of question-answering. It emphasizes that question-answering takes place in a pragmatic context, and hence, that pragmatic notions of answerhood are important. What it does not provide, however, is a systematic semantic theory of interrogatives. 'Logical forms' are assigned to natural language expressions on a rather ad hoc basis. No systematic relationship between the syntactic derivation of interrogatives and these forms is provided.⁵⁵ Moreover, as we already argued above, the analyses that are given cannot be interpreted as giving the semantic content of interrogatives. This holds not only for the epistemic element in the analysis, but also for the imperative element. This part depends essentially on the use to which the inter-

rogative is put. It may be that the normal use is a request to bring about a certain epistemic state, but interrogatives can be put to other uses as well. An example that readily comes to mind is an exam situation. In that case, Hintikka says, the analysis of (32) is not (33), but (40):⁵⁶

(40) Show me that you know who ...

Rather than making the notion of logical form, i.e. of semantic content, depend on the circumstances of use, one would prefer an analysis that allows one to show how, given some independently provided semantic analysis, different uses in different circumstances come about. And that presupposes that semantic content and pragmatic aspects are distinguished systematically.

So, it seems that the imperative-epistemic approach can most fruitfully be viewed, not as a rival to the categorial and propositional approach, but rather as a companion. Supposing that some fusion of the latter two can be designed to give a systematic account of the semantic content of interrogatives, and of the semantics of linguistic answers, including the characterization of the notion of a standard semantic answer, it seems feasible to supplement it with the insights of the imperative-epistemic approach in order to gain a satisfactory account of the essentially pragmatic nature of the question-answer relationship.

4.5. Conclusion

Our discussion of the problems and prospects of the three major approaches in the theory of interrogatives has been a general one. As such it does not do justice to the many interesting analyses of particular phenomena that the various theories within these approaches provide. For such details the reader is referred to the works cited, and to the discussion of particular proposals in the papers to

follow. Our aim here has been a modest one: to indicate the main lines of thinking each approach embodies. Given a general characterization of such a starting point, it is possible to distinguish, independently of the details of any particular analysis, its strong and its weak sides.

We hope to have shown that the various approaches are in a sense complementary. The categorial approach and the propositional approach both constitute theories about the (syntax and) semantics of interrogatives, but, since they focus on different empirical aspects, it seems that their insights do not contradict each other, but rather can be expected to be fruitfully combined. The categorial approach focusses on the relationship between interrogatives and answers as linguistic expressions. Propositional theories concentrate on the development of a uniform semantic analysis in terms of semantic answerhood. An overall theory should account for both, and it seems that, ideology set aside, such a theory can profit from both approaches. The imperative-epistemic approach, in our view, has to be considered to constitute a theory about the pragmatics of interrogatives and question-answering. Although the viewpoint of information exchange is, of course, essential to a really comprehensive account of question-answering, it has been largely ignored by theories in the first two approaches. In this case too, the results, though not the interpretation that people working in this approach give of them, seem to be incorporable in an overall theory. And they should be, for an adequate theory of interrogatives, answers, and the question-answer-relation that does not account for these pragmatic aspects, is essentially incomplete.

We hope that from the detailed analyses of various kinds of phenomena that are given in the papers to follow, the contours of such a more encompassing theory will emerge. The theory that can be distilled from these papers is like a propositional one in that it defines a uniform semantic object for all interrogatives and wh-complements, avoiding some of the problems with entailment and coordination that other theories run into. It deals with linguistic answers in a way

that is akin in spirit to the categorial approach, accounting for the fact that the interpretation of both sentential and constituent answers depend on the interpretation of the interrogatives they are used to answer. Further, it develops a systematic theory of the question-answer relationship, defining various notions of semantic and pragmatic answerhood in such a way that the relationships between these are reckoned with. This theory is not developed explicitly in what follows, since these papers are primarily analyses of various semantic and pragmatic phenomena pertaining to interrogatives and answers. But we trust that given the overview of the problems and prospects in this paper, the connections between what is said and done in the various separate papers is sufficiently clear.

Notes

- * We would like to thank Theo Janssen for his critical remarks on an earlier version, which, we hope, have led to substantial improvements, and Johan van Benthem for encouragement.
1. Implicitly at least, such a position seems to be held by many who feel sympathetic towards the opinion, most clearly and convincingly advocated by Wittgenstein, that there is no internal, logical system underlying all of language, that its various parts are related only indirectly and in diverse ways, and that hence there is no reason whatsoever to suppose that what constitutes an illuminating analysis of one part can be extended to others fruitfully as well. A famous passage of the Philosophische Untersuchungen brings this home forcefully (Wittgenstein, 1953, par. 65):

"Hier stossen wir auf die grosse Frage, die hinter allen diesen Betrachtungen steht. -Denn man könnte mir nun einwenden: "Du machst dir's leicht! Du redest von allen möglichen Sprachspielen, hast aber nirgends gesagt, was denn das Wesentliche des Sprachspiels, und also der Sprache ist. Was allen diesen Vorgängen gemeinsam ist und sie zur Sprache, oder zu Teilen der Sprache macht. [...]"
Und das ist wahr. -Statt etwas anzugeben, was allem, was wir Sprache nennen, gemeinsam ist, sage ich, es ist diesen Erscheinungen garnicht Eines gemeinsam, weswegen wir für alle das gleiche Wort verwenden, -sondern sie sind mit einander in vielen verschiedenen Weisen verwandt. Und dieser Verwandtschaft, oder dieser Verwandtschaften wegen nennen wir sie alle "Sprachen"."

This expresses an opinion which, we feel, is quite alien to the tradition in which language is studied with formal means and methods. Unless the contrary has been proven (but what would a proof to that effect look like?), it is assumed that 'language' denotes a set of phenomena that do have a common core, be it perhaps one that can be described only rather abstractly. One of the aspects of the enterprise is to find out what this common core is, and this is done by constructing one and scrutinizing it, to find out to what extent it fits the phenomena, and to what extent it gives an insightful, explanatory account of them. It is, of course, one of Wittgenstein's claims that, though abstractly such a common basis for all of our language can be constructed, it is bound to lack any explanatory power (cf. par. 13 and the surrounding sections of the Untersuchungen). Such a claim can be refuted only by actually constructing a common basis, by actually

developing a general theory of language which indeed does connect and elucidate and explain various parts of language.

The working hypothesis of the formal tradition that this is possible, that it can give an interesting account of some fundamental principles of language in general, should not be taken for another one, viz. that a formal approach is the way, i.e. the only way, to study language. Other perspectives, other approaches, may contribute each in their own way to our knowledge of and insight in this one of the most fundamental of human capacities. And it may be that it are these various approaches that are related only by means of family resemblances. Perhaps we will never be able to come up with a unique ultimate theory that encompasses all these perspectives. But that is an entirely different matter.

2. The analysis of modal verbs and of conditional sentences constitute two examples (See G&S 1975, Veltman 1976, 1981).
3. See G&S 1982b, and in particular Landman 1984b.
4. See Landman 1984a, 1984b.
5. See G&S 1981, section 2.2, where this idea is used in a formal statement of Gricean conversational maxims as correctness conditions.
6. The standard work on compositionality is Janssen 1983. See also G&S 1982c for a discussion of compositionality and logical form.
7. Unlike the compositionality principle, which has been studied in depth, and of which the content and the consequences are well-known (see Janssen 1983), this principle lacks a formal theory. One thing that can be noticed is that it is independent of the compositionality principle. A compositional analysis may very well violate this principle. So, it seems to be another constraint on derivations, over and above the requirement of compositionality. How exactly it should be formalized and implemented depends on various aspects of the organization of a grammar. Since it concerns the relationship between syntax and semantics, it is a constraint on both syntactic and semantic rules. An example of a framework that seems to comply with it, is the very restricted framework proposed by Landman & Moerdijk (see Landman & Moerdijk 1983).
8. As an 'explanation' of the human capacity to deal with a potential infinite number of linguistic constructions it is adduced by various people, from Frege to the pre-Fregean Katz. (see Frege 1923, Katz 1966).

A field that is often claimed to be outside the scope of compositional semantics is that of lexical semantics (see e.g. Baker & Hacker 1980, which contains various other kinds of criticisms on formal semantics, of a Wittgensteinian nature as well). But recent work of Moortgat (see Moortgat 1984) and others shows remarkable progress in this area as

well. Of course, there are bound to be exceptions to the compositional rule, but that is besides the point. What is important is that taking compositionality as a lead, results in clear and well-organized analyses that cover important areas.

9. For a defense of this view see G&S 1978. A similar position is taken e.g. in Gazdar 1979.

It may be helpful to say something about terminology here. The term semantics is used to refer to that part of an overall theory of meaning that deals with truth-conditional aspects. Another part of such a theory deals with those aspects of meaning that cannot be described in terms of truth-conditions, reference, and so on, but that are of a conversational nature. For this part the term pragmatics is reserved. So, at least most of the time, 'pragmatics' refers to a specific part of the overall study of language use, viz. that part that is concerned with Gricean conversational maxims, with correctness conditions, and especially the informational elements that play a role there.

10. Grice's original purpose was to show that a classical, truth-conditional analysis of the meaning of connectives is basically correct, once it is supplemented with a conversational analysis that explains various other aspects of their meaning (see Grice 1967).

Grice's intentions may explain why his theory has attracted many people working in the formal tradition, even though Grice himself is supposed to be a 'non-formalist'.

11. For a formal statement, see G&S 1984c, section 3.1.
12. See Partee & Rooth 1982a, 1982b, and G&S 1984c, section 3.1.
13. See Belnap 1981. He uses the three theses that are discussed below, as means to classify and evaluate different theories of interrogatives.
14. Belnap 1981, page 16,17.
15. Belnap 1981, page 17.
16. For some examples of interrogatives which have more than one complete answer, see section 3.1. A formal treatment of such interrogatives is given in G&S 1984c. See also the references cited there.
17. See G&S 1984b, section 4 and appendix 2, for definitions and a discussion of the role that standard semantic answers play in language use.
18. In connection with this it is interesting to observe that virtually all theories that Belnap discusses in Belnap 1981 meet the requirement of the answerhood thesis as he interprets it. But only few come near to meeting our extended interpretation of it.

19. See e.g. Keenan & Hull (1973), Hintikka (1976), Belnap & Steel (1976), Bennett (1977,1979), Belnap (1982).
20. See e.g. Karttunen (1977), Karttunen & Karttunen (1976), Karttunen & Peters (1979), Grewendorf (1983).
21. A good overview of recent developments can be gotten from Soames (1979,1982).
22. A glimpse of the wealth of material available can be gotten by consulting the bibliography compiled by Egli & Schleichert, which appeared as an appendix in Belnap & Steel (1976). And much more has appeared since then.
23. The same classification is used in Kiefer (1983a).

24. Thus Hull, for example, in Hull (1975), starts out with the remark that "an answer ... is linguistically a noun-phrase", and without any further consideration goes on to develop a categorial theory.

Another example is Hausser, who notes that certain structural correlations exist between interrogatives and non-sentential answers, which do not exist between interrogatives and full, sentential answers. The former exhibit a certain categorial match, whereas the latter combine freely. Hausser concludes from this observation that non-sentential answers therefore are primary, and that interrogatives are to be considered syntactically as functions from non-sentential answers to full sentences. This has immediate repercussions for the semantics: the semantic interpretation of an interrogative is a set of denotations of the type corresponding to its 'characteristic' non-sentential answers. See Hausser 1976, 1983, Hausser & Zaefferer 1978.

In these cases, empirical considerations, concerning surface syntactical phenomena, rather than theoretical ones decide upon the way in which the analysis proceeds.

25. For example, Karttunen, in Karttunen (1977), takes a propositional view on single constituent interrogatives, and then argues against assigning multiple constituent interrogatives to a different, more complex category, as was proposed by Wachowicz, in Wachowicz (1974), as follows. He observes that there are hardly any distributional differences between single and multiple constituent interrogatives, and concludes that they ought to be assigned to the same syntactic category, and hence, to the same semantic type. For that keeps the overall grammar simpler. This is a formal, and not a material line of argumentation. No arguments are adduced that multiple constituent interrogatives ought to be analyzed in terms of propositions that relate to the semantics of these expressions themselves directly.

A similar type of argumentation can be found in G&S 1982a. There, a specific type of propositional view, viz. that wh-complements denote propositions, is argued for by the observation that they interact systematically with sentential

complements, and that hence overall simplicity is served by assigning both to the same syntactic category and the same semantic type.

26. Clear examples of this line of reasoning can be found in the works of the two main proponents of the imperative-epistemic view, Aqvist and Hintikka. See for example Aqvist, 1975, section 2. Hintikka, 1974, section 2, expresses it as follows:

"In spite of this somewhat gloomy view of the current scene, I believe that the key to the logic of questions is fairly straightforward. In a way, nothing could be simpler. If there is anything here that virtually all parties agree on, it is the idea that a question is a request for information. The questioner asks his listener to supply a certain item of information, to make him know a certain thing. Thus all that there is to the logic of questions is a combination of the logic of knowledge with the logic of requests (optatives, imperatives)."

And that is about all the theoretical motivation that is given. As for the aim of the analyses of Aqvist and Hintikka, see section 4.3.

27. See Hausser (1976), (1983), Hausser & Zaefferer (1978), Tichy (1978), Scha (1983).

Extensive discussion of some of the details of these categorial analyses, especially of those of Tichy and Scha, can be found in G&S 1984b.

28. For example, in Hausser & Zaefferer we find the following:

"This shows that redundant answers are not very interesting from a semantical point of view since their semantic representation is identical to that of ordinary declarative sentences."

Hausser & Zaefferer, 1978, page 342.

It should be noted that once intonation patterns are taken into consideration, and are considered to be an integral part of the 'form' of expressions, it seems that sentential answers and constituent answers do have the same distributional properties.

29. See Scha, 1983, chapter 2, section 3.

30. See also G&S 1984b, section 2.2. Notice that if, as was suggested in note 28, we consider intonation to be an aspect of form too, sentential answers depend not just for their interpretation, but also for their form on the context of an interrogative.

31. See Tichy, 1978, page 279.

32. In fact, Hausser constructs constituent answers as sentential expressions, by introducing a special kind of expression, called a 'context-variable', which ranges over the type of sets of denotations of the type of the constituent. The

interrogative is taken as the value of the context-variable.

This hidden sentential character of constituent answers, we take it, is Hausser's way to account for the fact that answers convey information, i.e. express propositions.

The function-argument relation between interrogative and constituent answer is constructed differently in Hausser 1976, and Hausser 1983, relevant factors being, among others, scope phenomena.

33. Such independent motives can be found especially in Tichy's paper. They are discussed in G&S 1984b, section 1.
34. For a further evaluation, see G&S 1984b. In that paper there is extensive discussion of the matter of how to build in exhaustiveness. The paper also contains critical remarks on analyses related to the categorial approach, such as that of Bäuerle 1979.
35. See G&S 1984c, section 3.1 for formal definitions of general rules of entailment, and coordination.
36. In Hausser 1976, we find the following (page 21):

"Furthermore, I fail to see in what intuitive sense (i) [= Bill knows who arrived] should have anything to do with a question."

See Belnap 1981, page 7, for some critical remarks.

In Hausser (1983) an analysis of wh-complements is developed, which, however, runs into several problems that we will not go into here.

37. See Hamblin 1976, Karttunen 1977, Bennett 1977, 1979, and Belnap 1982.
- A more extensive discussion of Karttunen, and of Bennett & Belnap, can be found in G&S 1984c, section 3. G&S 1982a also contains some discussion of Karttunen's analysis.

38. As a matter of historical curiosity, we will go into the relation between Hamblin's and Karttunen's analysis in some detail.

Karttunen phrases the difference between Hamblin's analysis and his own as follows (Karttunen 1977, page 9,10):

"Hamblin's idea was to let every [interrogative] denote a set of propositions, namely the set of propositions expressed by possible answers to it.[...] I choose to make [interrogatives] denote the set of propositions expressed by their true answers instead of the set of propositions expressed by their possible answers."

This formulation suggests a basic difference, but this is mere appearance, caused by a terminological confusion. Hamblin's analysis is carried out in the framework of Montague's 'English as a Formal Language' (EFL), and that of Karttunen in the PTQ-framework. What is called 'denotation' in EFL, is called 'sense' in PTQ. If we use PTQ-terminology to describe both Hamblin and Karttunen, we get the following. For Hamblin, the sense of an interrogative is a set of

propositions, being its possible answers. For Karttunen, the sense of an interrogative is a function, having as its domain the set of indices and as its range the set of all sets of propositions that are possible answers. At an index, this function yields as its value that set which consists of the true answers. That is the denotation of an interrogative. Hamblin's notion of the sense of an interrogative does not give rise to a corresponding notion of denotation in the standard way. It is not a function having the set of indices as its domain. But, of course, if we ask ourselves what the denotation could be in Hamblin's case at a certain index, one can think of nothing else but taking the true answers at that index from the set of possible answers that constitutes the sense. And then we are back at Karttunen. In other words, apart from some differences of detail which are not relevant and which we leave out of consideration here, there is no material difference between the two. The only, but not unimportant difference is that Karttunen's analysis allows for a standard characterization of, and relation between, sense and denotation, whereas Hamblin's approach calls for non-standard notions of sense and denotation.

39. For extensive discussion of such interrogatives, and of Bennett & Belnap's way of accounting for them, see G&S 1984c.

That Karttunen should be interpreted as is done in the text, can be substantiated by the following quotation (Karttunen, 1977, page 10):

"[...] questions denote sets of propositions that jointly constitute a true and complete answer to the questions [...]"

See also Belnap 1982, section 2.2.

40. Karttunen does not speak about the matter at all, and Hamblin only vaguely. Belnap (1982) contains some remarks, but no real theory.
41. The criticism to follow are worked out in formal detail in G&S 1984c, section 3.
42. For a detailed diagnosis, see G&S 1984c, sections 3.2.1 and 3.2.2, and note 26. As is argued there, exhaustiveness plays an important role in these matters.
43. See note 42.
44. See G&S 1984c, section 4.
45. See G&S 1982a, section 1.8.
46. This holds for all the frameworks in which existing propositional theories are formulated. A possible solution might be to use a framework with structured propositions. For our solution of this problem, see G&S 1984b.

47. See Aqvist 1965.
48. See Hintikka 1974, 1976, 1978, 1983. As for the descriptive aims of Hintikka's analyses, they are evident, for example, from the introduction in Hintikka 1976. Hence, one should not be misled by the word 'logic' as it occurs in the quotation given in note 26. We think one can safely read 'logic' there as 'logical semantics'.
49. Analyses that propose a performative paraphrase for interrogatives, such as that of Lewis 1972, are left out of consideration here. The justification for doing so lies partly in the fact that some of the criticisms that are raised against epistemic-imperative paraphrase theories can be raised against such theories too, partly because the entire performative analysis enterprise can be argued to be fundamentally wrongly directed. See e.g. the criticisms made in Gazdar 1979.
50. Similar criticisms are raised throughout the work of Belnap.
51. See Hintikka 1962, 1983.
52. See Karttunen 1977, section 1.4, and G&S 1982a, section 1.8.
53. Besides these two, Hintikka distinguishes several others (see Hintikka 1983, section 7). The problem is that Hintikka's analysis does not give a general characterization of these different desiderata. They have to be stated separately, and ad-hoc.
For some remarks concerning the status of the mention-all/mention-some contrast, see G&S 1984c, section 5.
54. See note 42.
55. In other words, the analysis does not conform to the compositionality principle. Hintikka, by the way, has his doubts about the possibility of providing a compositional semantics for natural language.
56. See Hintikka 1978.

References

- Aqvist, L., A new approach to the logical theory of questions, Philosophical Studies, Uppsala, 1965 (new edition: Narr, Tübingen, 1975)
- Bäuerle, R., 'Questions and answers', in: R. Bäuerle, U. Egli & A. von Stechow (eds.), Semantics from different points of view, Springer, Berlin, 1979
- Baker, G. & P. Hacker, Meaning and understanding, Blackwell, Oxford, 1980
- Belnap, N., 'Approaches to the semantics of questions in natural language. Part I.', ms., Pittsburgh, 1981
- Idem, 'Questions and answers in Montague grammar', in: S. Peters & E. Saarinen (eds.), Processes, beliefs and questions, Reidel, Dordrecht, 1982
- Belnap, N. & T. Steel, The logic of questions and answers, Yale University Press, New Haven, 1976
- Bennett, M., 'A response to Karttunen on questions', Linguistics and Philosophy, 1, 1977
- Idem, Questions in Montague grammar, Indiana University Linguistics Club, Bloomington, 1979
- Frege, G., 'Logische Untersuchungen. Dritter Teil: Gedanken-gefüge', in: Beiträge zur Philosophie des Deutschen Idealismus, 3, 1923. (also in: G. Frege, Logische Untersuchungen, herausgeber G. Patzig, Vandenhoeck & Ruprecht, Göttingen, 1976)
- Gazdar, G., Pragmatics, Academic Press, New York, 1979
- Grewendorf, G., 'What answers can be given?', in: Kiefer (1983a)
- Grice, H., Logic and conversation, William James Lectures, ms., Harvard University, 1967
- Groenendijk, J. & M. Stokhof, 'Modality and conversational information', Theoretical Linguistics, 2, 1975
- Idem, 'Semantics, pragmatics and the theory of meaning', Journal of Pragmatics, 2, 1978
- Idem, 'A pragmatic analysis of specificity', in: F. Heny (ed.), Ambiguities in intensional contexts, Reidel, Dordrecht, 1981
- Idem, 'Semantic analysis of wh-complements', Linguistics and Philosophy, 5, 1982a

- Idem, 'Formal and acquainted objects in the theory of information', ms., Amsterdam, 1982b
- Idem, 'Over logische vorm', Tijdschrift voor Tekst- en Taalwetenschap, 2, 1982c
- Idem, 'On the semantics of questions and the pragmatics of answers', in: F. Landman & F. Veltman (eds.), Varieties of Formal Semantics, Foris, Dordrecht, 1984a
- Idem, 'Questions and linguistic answers', ms., Amsterdam, 1984b
- Idem, 'Coordinating interrogatives', ms., Amsterdam, 1984c
- Hamblin, C., 'Questions in Montague English', in: B. Partee (ed.), Montague grammar, Academic Press, New York, 1976 (originally in Foundations of Language, 10, 1973)
- Hausser, R., 'The logic of questions and answers', ms., München, 1976
- Idem, 'The syntax and semantics of English mood', in: Kiefer (1983a)
- Hausser, R. & D. Zaefferer, 'Questions and answers in a context-dependent Montague grammar', in: F. Günthner & S. Schmidt (eds.), Formal semantics and pragmatics for natural languages, Reidel, Dordrecht, 1978
- Hintikka, J., Knowledge and belief, Cornell University Press, Ithaca, 1962
- Idem, 'Questions about questions', in: M. Munitz & P. Unger (eds.), Semantics and philosophy, New York University Press, New York, 1974
- Idem, The semantics of questions and the questions of semantics, Acta Philosophica Fennica, 28 (4), 1976
- Idem, 'Answers to questions', in: H. Hiz (ed.), Questions, Reidel, Dordrecht, 1978
- Idem, 'New foundations for a theory of questions and answers', in: Kiefer (1983a)
- Hull, R., 'A semantics for superficial and embedded questions in natural language', in: E. Keenan (ed.), Formal semantics of natural language, Cambridge University Press, Cambridge, 1975
- Janssen, T., Foundations and applications of Montague grammar, diss., Amsterdam, 1983
- Karttunen, L., 'Syntax and semantics of questions', Linguistics and Philosophy, 1, 1977
- Karttunen, L. & F. Karttunen, 'Even questions', ms., Austin, 1976
- Karttunen, L. & S. Peters, 'Conventional implicature', in: C-K. Oh & D. Dinneen (eds.), Presupposition, Academic Press, New York, 1979

- Katz, J., The philosophy of language, Harper & Row, New York, 1966
- Keenan, E. & R. Hull, 'The logical presuppositions of questions and answers', in: D. Franck & J. Petöfi (eds.), Präsuppositionen in Philosophie und Linguistik, Athenäum, Frankfurt, 1973
- Kiefer, F. (ed.), Questions and answers, Reidel, Dordrecht, 1983a
- Idem, 'Introduction', in: Kiefer (1983a)
- Landman, F., 'Representation of information and information growth. Part I: elimination and the Conway-paradox', ms., Amsterdam, 1984a
- Idem, 'Representation of information and information growth. Part II: domain theory', ms., 1984b
- Landman, F. & I. Moerdijk, 'Compositionality and the analysis of anaphora', Linguistics and Philosophy, 6, 1983
- Lewis, D., 'General Semantics', in: D. Davidson & G. Harman (eds.), Semantics of natural language, Reidel, Dordrecht, 1972
- Moortgat, M., 'Word formation and Frege's principle', ms., Leiden, 1984
- Partee, B. & M. Rooth, 'Generalized conjunction and type ambiguity', ms., Amherst, 1982a
- Idem, 'Conjunction, type ambiguity, and wide scope "or"', ms., Amherst, 1982b
- Scha, R., Logical foundations for question answering, diss., Groningen, 1983
- Soames, S., 'A projection problem for speaker presupposition', Linguistic Inquiry, 10, 1979
- Idem, 'How presuppositions are inherited: a solution to the projection problem', Linguistic Inquiry, 13, 1982
- Tichy, P., 'Questions, answers and logic', American Philosophical Quarterly, 15, 1978
- Veltman, F., 'Prejudices, presuppositions and the theory of conditionals', in: Groenendijk, J. & M. Stokhof (eds.), Amsterdam papers in formal grammar, Vol. 1, Amsterdam, 1976
- Idem, 'Data semantics', in: J. Groenendijk, T. Janssen & M. Stokhof (eds.), Formal methods in the study of language, Mathematical Centre, Amsterdam, 1981 (reprinted in: Groenendijk, Janssen & Stokhof (eds.), Truth, interpretation, information, Foris, Dordrecht, 1984)
- Wachowicz, K., 'Multiple questions', Linguistica Silesiana, 1, 1974
- Wittgenstein, L., Philosophische Untersuchungen/Philosophical Investigations, Blackwell, Oxford, 1953

II

SEMANTIC ANALYSIS
OF WH-COMPLEMENTS

reprinted from:

Linguistics and Philosophy, 5, 1982

CONTENTS

0. Introduction	97
1. Semantic properties of wh-complements	81
1.1. Whether-complements and that-complements	81
1.2. Index dependency	83
1.3. Extensional and intensional complement embedding verbs	83
1.4. Constituent complements	84
1.5. Exhaustiveness	85
1.6. A de dicto/de re ambiguity of constituent complements	89
1.7. Implicatures versus presuppositions	91
1.8. Towards a uniform treatment of complements	93
2. Ty2 and the semantic analysis of wh-complements	95
2.1. Ty2, the language of two-sorted type theory	95
2.2. Translating into Ty2	96
2.3. That-complements and whether-complements in Ty2	98
2.4. Constituent complements in Ty2	99
2.5. Methodological remarks on the use of Ty2	100
3. Wh-complements in a Montague grammar	102
3.1. Whether-complements and that-complements	102
3.2. Extensional and intensional complement embedding verbs	105
3.3. Single constituent complements with <u>who</u>	107
3.4. Exhaustiveness	109
3.5. Single constituent complements with <u>which</u>	111
3.6. De re readings of constituent complements	113
3.7. Multiple constituent complements	115
3.8. Why abstracts are necessary	119
4. Details of a possible syntax for wh-complements	122
4.1. Background assumptions	122
4.2. 'Wh-preposing' and 'preposable occurrences'	123
4.3. Wh-reconstruction	129
4.4. Wh-substitution and substitutable occurrences	132
4.5. Relative clauses	135
5. Coordination of complements	137
5.1. The need for complement-level terms	137
5.2. Analyzing complements as complement-level terms	141
5.3. Complement coordination	143
6. Two loose ends and one speculative remark	147
6.1. A scope ambiguity in wh-complements	147
6.2. Wh-complements in an extension of IL	151
6.3. Remark on the semantic of direct questions	153
Notes	157
References	162

0. Introduction

This paper presents an analysis of wh-complements in Montague Grammar. We will be concerned primarily with semantics, though some remarks on syntax are made in section 4. Questions and wh-complements in Montague Grammar have been studied in Hamblin (1976), Bennett (1979), Karttunen (1977) and Hausser (1978) among others. These proposals will not be discussed explicitly, but some differences with Karttunen's analysis will be pointed out along the way.

Apart from being interesting in its own right, it may be hoped that a semantic analysis of wh-complements will shed some light on what a proper analysis of direct questions will look like. One reason for such an indirect approach to direct questions is the general lack of intuitions about the kind of semantic object that is to be associated with them. A survey of the literature reveals that direct questions have been analyzed in terms of propositions, sets of propositions, sets of possible answers, sets of true answers, the true answer, properties, and many other things besides. As far as wh-complements as such are concerned, we do not seem to fare much better, but there is this clear advantage: we do have some intuitions about the semantics of declarative sentences in which they occur embedded under such verbs as know, tell, wonder. What kind of semantic object we may choose to associate with wh-complements is restrained by various facts about the semantics of these sentences.

This paper is organized as follows. In section 1 we discuss a number of semantic facts concerning declarative sentences containing wh-complements, leading to certain conclusions regarding the kind of semantic object that is to be associated with wh-complements. In section 2 we show that Ty2, the

language of two-sorted type theory, gives suitable means to represent the semantics of wh-complements, and that Ty2 can take the place of IL in PTQ as a translation medium. In section 3 we indicate how the analysis proposed can be implemented in a Montague Grammar and how the semantic facts discussed in section 1 are accounted for. In section 4 a possible syntax for wh-complements which suits our semantics is outlined in some detail. Section 5 deals with the coordination of complements, whilst in section 6 we tie up some loose ends and make a speculative remark on the semantics of direct questions.

1. Semantic properties of wh-complements

In this section a number of semantic properties of wh-complements will be traced by considering the validity of arguments in which sentences containing them occur. The conclusion of our considerations will be that there are good reasons to assume wh-complements to denote the same kind of semantic object as that-complements: propositions. The differences between the two kinds of complements will be explained in terms of differences in sense.

1.1. Whether-complements and that-complements

Consider the following valid argument, of which one of the premisses contains a whether-complement and the conclusion a that-complement.

- (I) John knows whether Mary walks
 Mary walks
 John knows that Mary walks

The validity of this type of argument reflects an important fact of sentences containing whether-complements and, by implication, of whether-complements themselves. As (I) indicates, there is a relation between the semantic object denoted by whether Mary walks and the proposition denoted by that Mary walks. Similarly, the validity of (II) is based on a relation between the semantic object denoted by whether Mary walks and the proposition denoted by that Mary doesn't walk.

- (II) John knows whether Mary walks
 Mary doesn't walk

 John knows that Mary doesn't walk

Together, (I) and (II) indicate that the actual truth value of Mary walks determines whether the relation holds between whether Mary walks and that Mary walks, or between whether Mary walks and that Mary doesn't walk.

The following examples show that the validity of (I) and (II) does not depend on the factivity of the verb know:

- (III) John tells whether Mary walks
 Mary walks

 John tells that Mary walks

- (IV) John tells whether Mary walks
 Mary doesn't walk

 John tells that Mary doesn't walk

Since x tells that ϕ does not imply that ϕ is true, the validity of (III) and (IV) cannot be accounted for in terms of factivity, and neither should the validity of (I) and (II) if, as we do, one assumes that it has to be explained in a similar way.

The overall suggestion made by (I)-(IV) is that there is a relationship between sentences in which a whether-complement occurs embedded under verbs as know or tell and similar sentences containing a that-complement. The most simple account of this relationship would be to claim that whether ϕ and that (not) ϕ denote the same kind of semantic object. Taking that (not) ϕ to denote a proposition, this amounts to claiming that whether ϕ denotes a proposition too.

1.2. Index dependency

Although on this account both that- and whether-complements denote propositions, they do this in different ways. The contrast between (I) and (III) on the one hand, and (II) and (IV) on the other, shows that which proposition whether ϕ denotes depends on the actual truth value of ϕ . This marks an important difference in meaning between that- and whether-complements. The denotation of that-complements is index independent: at every index that ϕ denotes the same proposition. The denotation of a whether-complement may vary from index to index, it is index dependent. At an index at which ϕ is true it denotes the proposition that ϕ ; at an index at which ϕ is false it denotes the proposition that not ϕ .¹ In other words, whereas the propositional concept which is the sense of a that-complement is a constant function from indices to propositions, the propositional concept which is the sense of a whether-complement (in general) is not. So, although, at a given index, a whether-complement and a that-complement may have the same denotation, their sense will in general be different.

1.3. Extensional and intensional complement embedding verbs

The difference in sense between that-complements and whether-complements plays an important role in the explanation of the semantic properties of sentences in which they are embedded. Embedding a complement under a verb semantically corresponds to applying the interpretation of the verb to the sense of the complement, i.e. to a propositional concept. This is the usual procedure for functional application, motivated by the assumption that no context can, a priori, be trusted to be extensional. We speak of an extensional context if a function always operates on the denotation of its arguments, and not on their sense.

As a matter of fact, such verbs as know and tell are extensional in this sense,² and moreover, the validity of the

arguments (I)-(IV) is based upon this fact. Verbs such as know and tell operate on the denotations of their complements, i.e. on propositions, and not on their sense, i.e. propositional concepts. The extensionality of these verbs will be accounted for by a meaning postulate which reduces intensional relations between individual concepts and propositional concepts to corresponding extensional relations between individuals and propositions.

However, there are also complement embedding verbs which do create truly intensional contexts. In terms of Karttunen's classification, inquisitive verbs (ask, wonder), verbs of conjecture (guess, estimate), opinion verbs (be certain about), verbs of relevance (matter, care) and verbs of dependency (depend on) count as such. The assumption that no extensional relation corresponds to the intensional one denoted by these verbs explains why arguments such as (I)-(IV) do not hold for them. That some of these verbs (e.g. guess, estimate, matter, care) can be combined with that-complements, while others (ask, wonder, depend on) cannot (at least not without a drastic change in meaning, cf. note 9), is an independent fact that needs to be accounted for as well.

1.4. Constituent complements

Consider the following arguments, of which one of the premisses contains a wh-complement with one or more occurrences of wh-terms such as who, what, which girl.

- (V) John knows who walks
Bill walks
 John knows that Bill walks
- (VI) John knows which man walks
Bill walks
 John knows that Bill walks

- (VII) John knows which man which girl loves
 Suzy loves Peter and Mary loves Bill

 John knows that Suzy loves Peter and that Mary
 loves Bill

Given the usual semantics, these arguments are valid.³ Again, this can be explained in a very direct way if we take constituent complements to denote propositions. The validity of (V)-(VII) no more depends on the factivity of know than does the validity of (I) and (II). This will be clear if one substitutes the non-factive tell for know in (V)-(VII). The validity of all these arguments does depend on the extensionality of know and tell. As was the case with whether-complements, which proposition a constituent complement denotes depends on what is in fact the case. For example, which proposition is denoted by who walks depends on the actual denotation of walk. If Bill walks, the proposition denoted by who walks should entail that Bill walks; if Peter walks, it should entail that Peter walks. This index dependent character can more generally be described as follows. At an index *i*, who walks denotes that proposition *p*, which holds true at an index *k* iff the denotation of walk at *k* is the same as its denotation at *i*.

1.5. Exhaustiveness

This more general description of the proposition denoted by who walks not only implies, as is supported by argument (V), that for John to know who walks he should know - de re - of everyone who walks that he does, but also implies that of someone who doesn't walk, he should not erroneously believe that she does. That this is right appears from the validity of the following argument:

- (VIII) John believes that Bill and Suzy walk
 Only Bill walks

 John doesn't know who walks

If only Bill walks and John is to know who walks, he should know that only Bill walks and he should not believe that someone else walks as well. We will call this property of propositions denoted by constituent complements their *exhaustiveness*.

Another way to make the same point is as follows. For a sentence John knows ρ , where ρ is a wh-complement, to be true, it should hold that if one asks John the direct question corresponding to ρ , one gets exactly the correct answer. So, if only Bill walks and John knows who walks is to be true, John should answer: 'Bill' when asked the question: 'Who walks?', and not for example: 'Bill and Suzy do'. A similar kind of exhaustiveness is exhibited by whether-complements of the form whether ϕ or ψ .⁴ Consider the following argument:

- (IX) John knows whether Mary walks or Bill sleeps
Mary doesn't walk and Bill sleeps
 John knows that Mary doesn't walk and that
 Bill sleeps

The validity of this argument illustrates that the proposition denoted by an alternative whether-complement is exhaustive too. At an index i , whether ϕ or ψ denotes that proposition p that holds at an index k iff the truthvalues of both ϕ and ψ at k are the same as at i .

In fact, one can distinguish different degrees of exhaustiveness of complements. Exhaustiveness to the lowest degree implies that for John to know who walks, he should know of everyone who walks that he/she does (and not merely of someone). This is the interpretation of exhaustiveness Karttunen defends (against Hintikka). Exhaustiveness to a stronger degree is used above. Not only do we require that John knows of everyone who walks that he/she does, but also that of no one who doesn't walk, John erroneously believes that he/she does. Exhaustiveness to at least this degree is required to explain the validity of arguments like (VIII). Since Karttunen only incorporates exhaustiveness to the lowest

degree he is unable to account for the validity of (VIII) and (IX). Whether he does consider these arguments to be valid is unclear to us. His analysis forces him to neglect stronger forms of exhaustiveness for a reason not related to this, which will be discussed in the next section.

We feel that an even stronger notion of exhaustiveness is called for. Suppose that John knows of everyone who walks that he/she does; that of no one who doesn't walk, he believes that he/she does; but that of some individual that actually does not walk, he doubts whether he/she walks or not. In such a situation, John would not say of himself that he knows who walks. We see no reason to override his judgment and to claim that in this situation, John does know who walks. This seems to suggest that for John to know who walks, he should not only know of everyone who walks that he/she does, but also of everyone who doesn't that he/she doesn't. This would mean that (X) (and its inverse) is a valid argument:

(X) John knows who walks
 John knows who doesn't walk

In view of the plausible arguments for exhaustiveness given above, there seems to be only one type of situation in which knowing who walks may not turn out to be the same as knowing who doesn't, i.e. which gives rise to counterexamples against (X). This is the type of situation in which the subject of the propositional attitude is not fully informed as to which set of individuals constitutes the domain of discourse. More in particular, only if a certain individual which in fact belongs to the domain of discourse and which in fact does not walk, does not belong to what John considers to be the domain of discourse, the situation can arise that John knows the positive extension of the predicate walk without also knowing its negative extension. Such a situation would be a counterexample against (X). (Of course, similar counterexamples can be constructed against the inverse of (X).)

In our formal analysis, we will not deal with cases like these, and consequently, we will accept the validity of (X), for the following reason. Incorporating into the framework of possible world semantics the type of situation in which individuals are not fully informed about what constitutes the domain of discourse is possible, for example by allowing the domain of discourse to vary with possible worlds, but at a cost. It creates a number of well-known problems, for which no definitive solution is yet available. We refrain from incorporating this aspect because of the problems it raises, and we feel free to do so because it is not inherent to an analysis of wh-complements.⁵

Another observation that somewhat weakens the significance of (X), is the following. That one must know the negative extension of a predicate as well as its positive extension, in order to know who satisfies it, appears less dramatic if one realizes that wh-terms, like all other quantifiers, are usually restricted to some, contextually or otherwise specified, subset of the entire domain of all entities. If someone asks who walks?, then he/she does not, or at least not usually, want a specification of all walkers on this earth, but rather a specification which exhausts the walkers in some restricted domain. Such restrictions are usually left implicit, but are there nonetheless. In fact, a contextual restriction functions as a 'hidden' common noun in the wh-term. In the next section, we will see that arguments similar to (X) which contain wh-terms of the form which δ instead of who, unlike (X) are not always valid. Again, the phenomenon of contextual restriction is not specific for wh-complements, but occurs with every kind of quantification in natural language. We therefore feel free to ignore it in our formal analysis.

1.6. A de dicto/de re ambiguity of constituent complements

Sentences in which constituent complements containing wh-terms of the form which δ occur exhibit a certain kind of ambiguity, which resembles the familiar de dicto/de re ambiguity, and which will henceforth be referred to as such. For example, whether the following argument is valid or not depends on how the conclusion is read.

- (XI) John knows who walks
 John knows which girl walks

That (XI) is *valid* could be argued for as follows. Since the set of girls is a subset of the set of individuals, and since if one knows of a set which of its elements have a certain property, one also knows this of every subset of that set, it cannot fail to hold that John knows which girl walks if he knows who walks. Here the conclusion is taken de re.

On the other hand, one might point out that (XI) is *not valid* by presenting the following situation. Suppose that just one individual walks. Suppose further that it is a girl. If John knows of this individual that she is the one that walks, but fails to believe that she is a girl, then the premiss of (XI) is true, but its conclusion is false. In this line of reasoning the conclusion is taken de dicto. It takes for granted that the conclusion should be read in such a way that if John is to know which girl walks, he should believe of every individual which is in fact a girl and walks, not only that she walks, but also that she is a girl. Within the first line of reasoning, this assumption is not made. So, whether (XI) is valid or not depends on how the conclusion is read. If we assign it a de re reading (XI) is valid, under a de dicto reading it is not. The de re reading of the conclusion of (XI) can be paraphrased as Of each girl, John knows whether she walks.

This de dicto/de re ambiguity also plays a role in an argument like (XII), which is analogous to argument (X) discussed in the previous section.

(XII) John knows which man walks

John knows which man doesn't walk

Even if we assume the domain of discourse to be the same for every possible world, i.e. if we exclude the kind of counterexample discussed with respect to (X), this argument, unlike its counterpart (X), is not valid as such. It is valid iff both the premiss and the conclusion are read de re, its inverse is then valid as well. Under all other possible combinations of readings (XII) is not valid. Consider e.g. the de dicto/de re combination. Suppose the premiss is true. This is compatible with there being an individual of which John erroneously believes that it is a man, but rightly believes that it does not walk. However, in such a situation, if the conclusion is read de dicto, it is false. Similar examples can be constructed to show that (XII) is also invalid on the two other combinations of readings. This shows, by the way, that the de dicto and de re readings involved are logically independent.

Once we take into account the type of situation, described in the previous section, in which individuals are not fully informed as to which set of individuals constitutes the domain of discourse, arguments like (XII) are no longer valid, even if premiss and conclusion are read de re. For then, the same kind of counterexample as we outlined against (X) can be constructed. The same holds if we incorporate contextual restrictions on quantification in our semantic framework. Then again, arguments like (X), and (XII) read de re are no longer valid in view of the possibility that the subject of the propositional attitude may be mistaken as to which subset of the domain of discourse is determined by the contextual restriction. As we said above, such a contextual restriction functions as a 'hidden' common noun

in the wh-term, thus allowing for de dicto readings with respect to it. The type of situation in which individuals are not fully informed about what constitutes the domain of discourse can be viewed in this way too (e.g. as misinformation about the denotation of the predicate *entity*). So, there are striking similarities between the three cases, which is also evident from the fact that the counterexamples that can be constructed in each case, are structurally the same. However, only the de dicto/de re ambiguity of constituent complements is particular to an analysis of wh-complements, the other phenomena being of a more general nature.

The possibility of distinguishing de dicto and de re readings of constituent complements marks an important difference between Karttunen's analysis and ours. Karttunen can account only for de re readings. As a result, arguments like (XI) come out valid in his analysis. Nevertheless, (XII) is not a valid argument in Karttunen's theory. This is caused by the fact that he incorporates exhaustiveness only in its weakest form. He explicitly rejects stronger forms of exhaustiveness because, combined with the fact that his analysis accounts only for de re readings, this would make arguments like (X) and (XII) valid.⁶ Rejecting strong exhaustiveness, Karttunen is able to regard (XII) as invalid but for the wrong reason, as can be seen from the fact that (XI) still is valid in his analysis. Worse, he thereby deprives himself of the means to account for the validity of arguments like (VIII) and (IX). We believe that an analysis which can both account for exhaustiveness and for the fact that the validity or invalidity of (XI) and (XII) depends on how the conclusion is read, is to be preferred.

1.7. Implicatures versus presuppositions

From the previous discussion, in particular from sections 1.4. and 1.5., it will be clear that we consider the following arguments to be valid ones:

- (XIII) John knows who walks
 Nobody walks

 John knows that nobody walks
- (XIV) John knows who walks
 Peter and Mary walk

 John knows that Peter and Mary walk
- (XV) John knows whether Peter walks or Mary walks
 Neither Peter nor Mary walks

 John knows that neither Peter nor Mary walks
- (XVI) John knows whether Peter walks or Mary walks
 Both Peter and Mary walk

 John knows that both Peter and Mary walk

One might object to the validity of these arguments by pointing out that John knows who walks presupposes that at least/exactly one individual walks, and that John knows whether Peter walks or Mary walks presupposes that at least/exactly one of the alternatives is the case. Therefore, one might continue, the first premiss of these arguments is semantically deviant in some sense, say lacks a truth value, if the second premiss happens to be true.

We adhere to the view, also advocated by Karttunen, that it is better to regard these phenomena as (pragmatic) *implicatures* and not as presuppositions in the strict semantic sense. More generally, we believe that many of the arguments put forward in Kempson (1975), Wilson (1975) and Gazdar (1979) showing that presupposition is a pragmatic notion should hold for presuppositions of *wh*-complements as well. (See also the discussion in section 5.)

In Karttunen's analysis, (XIII)-(XVI) are valid as well. The validity of (XIII) and (XV), however, has to be secured by a special clause in a meaning postulate relating know + wh to know that. The need for this special clause explains it-

self by the fact that the validity of (XIII) and (XV) is at odds with not incorporating exhaustiveness. One would expect that in an analysis in which (VIII) and (IX) of section 1.5 are not valid, (XIII) and (XV) would not be valid either.

1.8. Towards a uniform treatment of complements

A distinctive feature of our analysis is that wh-complements are taken to be proposition denoting expressions. This is an important difference between our approach and that of others. To mention only two, in Karttunen's they denote sets of propositions, and in Hausser's they are of all sorts of different categories. From this difference other differences follow, e.g. the possibility of a uniform treatment of complements. For, besides the fact that it provides a simple and direct account of the validity of the various arguments discussed above, the hypothesis that that- and wh-complements denote the same kind of semantic object makes it possible to assign them to the same syntactic category,⁷ This seems especially attractive in view of the fact that it is possible to conjoin wh- and that-complements:

- (1) John knows that Peter has left for Paris, and also whether Mary has followed him
- (2) Alex told Susan that someone was waiting for her, but not who it was

Further, if both kinds of complements can belong to the same syntactic category, we are no longer forced to assume there to be two complement taking verbs know, of different syntactic categories, and of different semantic types: one which takes that- and one which takes wh-complements. We need not acknowledge two different relations of knowing which are only linked indirectly, i.e. by a meaning postulate.⁸ This happens for example in Karttunen's analysis. There wh-complements denote sets of propositions, and that-complements denote propositions. Consequently, there are two

relations of knowing. Karttunen reduces the relation to sets of propositions to the relation to propositions by postulating that x stands in the first relation to a set of propositions iff x stands in the second relation to all the elements of this set. (Actually, his postulate is slightly more complex, but that is irrelevant here.) Not only is this a rather cumbersome way of accounting for our intuition that there is one verb know, it is also not at all clear whether a strategy like this is applicable in all cases. A case in point are truly intensional verbs which take both wh-complements and that-complements, such as guess and matter. If we categorize wh-complements and that-complements differently, the problem arises how to account for the obvious semantic relation (identity) between the two verbs guess (or matter, etc.) we are then forced to assume. In these cases one cannot reduce the one to the other, for obvious reasons. For example, John guesses who comes to dinner does not mean the same as for all x , if x comes to dinner, then John guesses that x comes to dinner.⁹ In what other way the interpretation of the two verbs could be related adequately, is quite unclear. In the analysis proposed in this paper, there is no problem at all. Since wh-complements and that-complements are of the same syntactic category, no verbs need to be duplicated in the syntax. The extensionality of verbs such as know and tell can be accounted for by means of a meaning postulate. As for truly intensional verbs such as guess and matter, they express the same relation to a propositional concept, be they combined with a wh-complement or with a that-complement. The semantic differences between the two constructions are accounted for by the different properties of the propositional concepts expressed by wh-complements and that-complements respectively.

Of course, there are also verbs such as wonder, which take only wh-complements, and verbs such as believe, which take only that-complements. The relevant facts can easily be accounted for by means of syntactic subcategorization or, preferably, in lexical semantics, by means of meaning postulates.

2. Ty2 and the semantic analysis of wh-complements

In section 1 we have sketched informally the outlines of a semantics for wh-complements. In particular, we argued that wh-complements denote propositions and do this in an index dependent way. The description of this index dependent character involves comparison of what is the case at different indices. This leads to the choice of a logical language in which reference can be made to indices and in which relations between indices can be expressed directly. The language of two-sorted type theory, Gallin's Ty2, is such a language. In this section we will show that it serves our purpose to express the semantics of wh-complements quite well.

Ty2 is a simple language. Rather than by stating the explicit definitions, we will discuss its syntax and semantics by comparing it with IL, the language of intensional logic of PTQ, thereby indicating how Ty2 can be put to the same use as IL in the PTQ system. We will also make some methodological remarks on the use of Ty2. For a formal exposition and extensive discussion of Ty2, the reader is referred to Gallin (1975).

2.1. Ty2, the language of two-sorted type theory

The basic difference between IL and Ty2 is that s is not introduced only in constructing more complex, intensional types, but that it is a basic type, just like e and t . Complex types can be constructed with s in exactly the same way as with e and t . As is to be expected, the set of possible denotations of type s is the set of indices. Since

it is a type like any other now, we will also employ constants and variables of type s . This means that it is possible to quantify and abstract over indices, making the necessity operator \square and the cap operator $\hat{}$ superfluous.

A *model* for Ty2 is a triple $\langle A, I, F \rangle$, A and I are disjoint non-empty sets, A is to be the set of individuals, I the set of indices. F is an interpretation function which assigns to every constant a member of the set of possible denotations of its type. Notice the difference with the interpretation function F of IL-models, which assigns senses and not denotations to constants. The interpretation of a meaningful expression α of Ty2, written as $\llbracket \alpha \rrbracket_{M,g}$, is determined with respect to a model M and an assignment g only. (As usual, g assigns to every variable a member of the set of possible denotations of its type.)

The important difference with interpretations in IL, is that the latter also need an index to determine the interpretation of an expression. This role of indices as a parameter in the interpretation is taken over in Ty2 by the assignment functions. The effect of interpreting in IL an expression with respect to an index i is obtained in Ty2 by interpreting expressions with respect to an assignment which assigns to a free index variable occurring in the expression the index i . To an index dependent expression of IL (an expression of which the denotation varies from index to index) there corresponds an expression in Ty2 which contains a free index variable. The result is an expression the interpretation of which varies from assignment to assignment. A formula ϕ is true with respect to M and g iff $\llbracket \phi \rrbracket_{M,g} = 1$; ϕ is valid in M iff for all g , ϕ is true with respect to M and G ; ϕ is valid iff for all M , ϕ is valid in M .

2.2. Translating into Ty2

To illustrate the difference between IL and Ty2, consider first how the English verb walk translates into Ty2. Instead of simply translating it into a constant of type $f(IV)$, it is

translated into the expression $\text{walk}(v_{0,s})$, in which walk is a constant of type $\langle s, f(IV) \rangle$, and $v_{0,s}$ is a variable of type s , so the full translation of the verb is an expression of type $f(IV)$.

All translations of basic expressions will contain the same free index variable. For this purpose we use $v_{0,s}$, the first variable of type s , which from now on we will write as a . Therefore, the translation of a complex expression will be interpreted with respect to the index assigned to a by the assignment function.

The rules for translating PTQ English into Ty2 can be obtained by using the fact that $\lambda\alpha\alpha$ expresses the same function in Ty2 as $\hat{\alpha}$ in IL, $\sim\alpha$ is the same as $\alpha(a)$; and \circ corresponds to $\forall a$. Consider the following examples of Ty2 analogues of (parts of) some PTQ translation rules, in which \sim abbreviates 'translates into'.

(T:1) (a) If α is in the domain of g , then $\alpha \sim g(\alpha)(a)$

With the usual exceptions, g associates a basic expression of category A with a Ty2 constant α' of type $\langle s, f(A) \rangle$, giving its sense. The full translation of $\alpha, \alpha'(a)$, gives as usual its denotation.

(T:1) (b) $\text{be} \sim \lambda P \lambda x [P(a)(\lambda a \lambda y [x(a) = y(a)])]$

(c) $\text{necessarily} \sim \lambda p \forall a [p(a)]$

(d) $\text{John} \sim \lambda P [P(a)(\lambda a j)]$

(e) $\text{he}_n \sim \lambda P [P(a)(x_n)]$

(T:2) If $\delta \in P_{CN}$, and $\delta \sim \delta'$, then

$\text{every} \delta \sim \lambda P \forall x [\delta'(x) \rightarrow P(a)(x)]$

(T:4) If $\alpha \in P_T$, $\delta \in P_{IV}$, $\alpha \sim \alpha'$, and $\delta \sim \delta'$, then

$F_4(\alpha, \delta) \sim \alpha'(\lambda a \delta')$

Of course, the meaning postulates of PTQ can be translated into Ty2 as well. (Notice that the rigid designator view of proper names like John is already implemented in its

In section 1.1 we circumscribed the denotation of whether Mary walks as follows: at an index at which it is true that Mary walks it denotes the proposition that Mary walks, and at an index at which it is false that Mary walks it denotes the proposition that Mary doesn't walk. Another way of saying this is that at an index i whether Mary walks denotes that proposition p such that for every index k , p holds true at k iff the truth value of Mary walks at k is the same as at i . In Ty2 this can be expressed by the index dependent proposition denoting expression (4), the interpretation of which is given in (4').

$$(4) \quad \lambda i[\text{walk}_*(a)(m) = \text{walk}_*(i)(m)]$$

$$(4') \quad \llbracket \lambda i[\text{walk}_*(a)(m) = \text{walk}_*(i)(m)] \rrbracket_{M,g} \text{ is that proposition } p \in \{0,1\}^I \text{ such that for every index } k \in I: p(k) = 1 \text{ iff } \llbracket \text{walk}_*(a)(m) = \text{walk}_*(i)(m) \rrbracket_{M,g[k/i]} = 1 \text{ iff } \llbracket \text{walk}_*(a)(m) \rrbracket_{M,g[k/i]} = \llbracket \text{walk}_*(i)(m) \rrbracket_{M,g[k/i]} \text{ iff } \llbracket \text{walk}_*(a)(m) \rrbracket_{M,g} = \llbracket \text{walk}_*(i)(m) \rrbracket_{M,g[k/i]}.$$

So, at the index $g(a)$, the expression (4) denotes the characteristic function of the set of indices at which the truth value of Mary walks is the same as at the index $g(a)$. The index dependent character of whether-complements discussed in 1.1 and 1.2 is reflected by the fact that a free index variable occurs in their translation. The expression $\lambda a \lambda i[\text{walk}_*(a)(m) = \text{walk}_*(i)(m)]$, denoting the propositional concept which is the sense of whether Mary walks, does not denote a constant function. For different indices its value may be a different proposition.

2.4. Constituent complements in Ty2

The kind of expressions which denote propositions in the required index dependent way can be constructed not only from formulas, such as $\text{walk}_*(a)(m)$ in (4), but from expressions of

arbitrary type. Let $\alpha/a/$ and $\alpha/i/$ be two expressions such that where the first has free occurrences of a , the second has free occurrences of i , and vice versa. Then the expression (5) denotes a proposition in an index dependent way, as its interpretation given in (5') shows.¹⁰

$$(5) \quad \lambda i[\alpha/a/ = \alpha/i/]$$

$$(5') \quad \llbracket \lambda i[\alpha/a/ = \alpha/i/] \rrbracket_{M,g} \text{ is that proposition } p \in \{0,1\}^I \text{ such that for every index } k \in I, p(k) = 1 \text{ iff} \\ \llbracket \alpha/a/ \rrbracket_{M,g} = \llbracket \alpha/i/ \rrbracket_{M,g[k/i]}.$$

Expressions serving as translations of wh-complements will always be of this form. The translation of a whether-complement has been given in (4). There $\alpha/a/$ is the formula $\text{walk}_*(a)(m)$. An example of an expression which will serve as the translation of a constituent complement is:

$$(6) \quad \lambda i[\lambda u[\text{walk}_*(a)(u)] = \lambda u[\text{walk}_*(i)(u)]].$$

In this case, $\alpha/a/$ is $\lambda u[\text{walk}_*(a)(u)]$, an expression of type $\langle e, t \rangle$. At an index $g(a)$, (6) denotes that proposition which holds at an index k iff $\llbracket \lambda u[\text{walk}_*(a)(u)] \rrbracket_{M,g}$ is the same set as $\llbracket \lambda u[\text{walk}_*(i)(u)] \rrbracket_{M,g[k/i]}$. I.e. at an index $g(a)$, (6) denotes that proposition which holds true at an index k iff the denotation of walk_* at that index k is the same as at the index $g(a)$. And this is precisely the index dependent proposition which, in section 1.4, we required to be the denotation of the constituent complement who walks.

2.5. Methodological remarks on the use of Ty2

In this section we will defend our use of Ty2 against some objections that are likely to be raised against it.

A first objection might be that translations in Ty2 are (even) less 'natural' than those in IL. In view of the fact that within a compositional semantic theory the level of translation, be it in Ty2 or in IL, is in principle

dispensable, we do not see that there is empirical motivation for this kind of objection.

A second objection that is often raised against the use of a logical language which allows for reference to and quantification over indices, is that it involves stronger ontological commitments than a language in which the relevant phenomena are dealt with by means of intensional operators. We do not think that this objection holds. It is not the object language in isolation, but the object language together with the meta-language in which its semantics is described that determines ontological commitments. Since the statement of the semantics of intensional operators involves reference to and quantification over indices as well, the commitments are the same. The dispensability of the translation level even strengthens this point.

A more serious reason for preferring an operator approach to a quantificational approach might be that for some purposes one does not need the full expressive power of a quantificational language and therefore prefers a language with operators which has exactly the, restricted, expressive power one needs. In fact, in section 6.2 we will point out that by the introduction of a new intensional operator to IL, one can get a long way in the semantic analysis of wh-complements. However, phenomena remain which escape treatment in this intensional language, an example is discussed in 6.1.

Taking the semantic analysis of tense into consideration as well, we think a lot can be said in favour of a logical language in which reference to and quantification over indices is possible. It appears that analyses set up in the Priorean fashion tend to become stronger and stronger, up to a point where if there is still a difference in expressive power with quantificational logic at all, this advantage is annihilated by the unintuitiveness and complexity of the language used. For an illuminating discussion of these points, see Van Benthem (1978). In fact, we think that Ty2 provides a suitable framework for the incorporation of a semantic analysis of tense in the vein of Needham (1975) into a Montague Grammar as well.

3. Wh-complements in a Montague Grammar

In this section we will outline how the semantic representations of complements in Ty2, given in section 2, can systematically be incorporated in the framework of a Montague Grammar. We will not present the syntactic part of our proposal in detail. In particular, the definitions of the various syntactic functions occurring in the syntactic rules will not be stated until section 4. We will concentrate on the explanation of the semantic facts discussed in section 1.

3.1. Whether-complements and that-complements

Complements are expressions which denote propositions. Therefore, they should translate into expressions of type $\langle s, t \rangle$. In PTQ there is no syntactic category which is mapped onto this type¹¹, therefore we add the following clauses to the definitions of the set of categories and the function f mapping categories into types;

If $A \in \text{CAT}$, then $\bar{A} \in \text{CAT}$; $f(\bar{A}) = \langle s, f(A) \rangle$

So, \bar{t} will be the category of complements. Complement embedding verbs, such as know, tell, wonder and believe will be of category IV/\bar{t} . As we remarked in section 1.8, the categories \bar{t} and IV/\bar{t} will have to be subcategorized, since not all of these verbs take all kinds of complements. This can be done in an obvious way, with which we will not be concerned here.

In (7) an analysis tree of a sentence containing a that-complement is given together with its translation. Here and

elsewhere, notation conventions and meaning postulates familiar from PTQ are applied whenever possible.

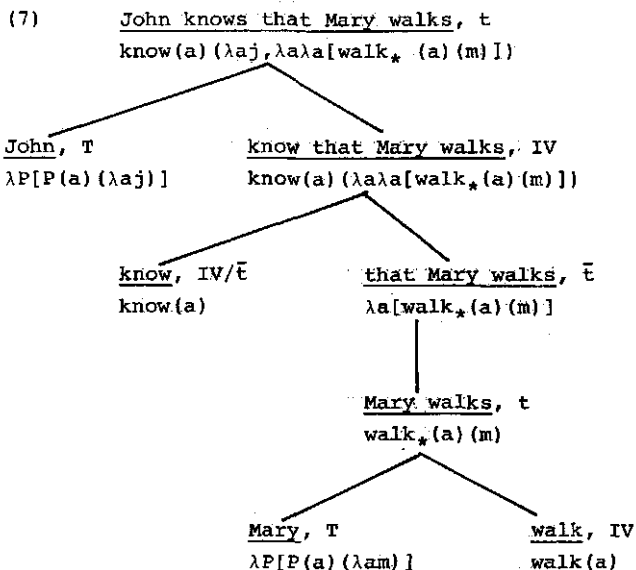

The syntactic rule deriving a that-complement and the corresponding translation rule are:

- (S:THC) If $\phi \in P_t$, then that $\phi \in P_{\bar{t}}$
 (T:THC) If $\phi \sim \phi'$, then that $\phi \sim \lambda a \phi'$

The rule which embeds the complement under a verb is a simple rule of functional application. The corresponding rule of translation follows the usual pattern:

- (S:IV/ \bar{t}) If $\delta \in P_{IV/\bar{t}}$ and $\rho \in P_{\bar{t}}$, then $F_{IV/\bar{t}}(\delta, \rho) \in P_{IV}$
 (T:IV/ \bar{t}) If $\delta \sim \delta'$ and $\rho \sim \rho'$, then
 $F_{IV/\bar{t}}(\gamma, \rho) \sim \delta'(\lambda a \rho')$

Sentence (7) expresses that an intensional relation of knowing exists between the individual concept denoted by $\lambda a j$

and the propositional concept denoted by $\lambda a \lambda i [\text{walk}_*(a)(i)(m)]$. By means of a meaning postulate, to be given below, this intensional relation will be reduced to an extensional one.

In (8) an analysis tree and its translation of a sentence containing a whether-complement are given:

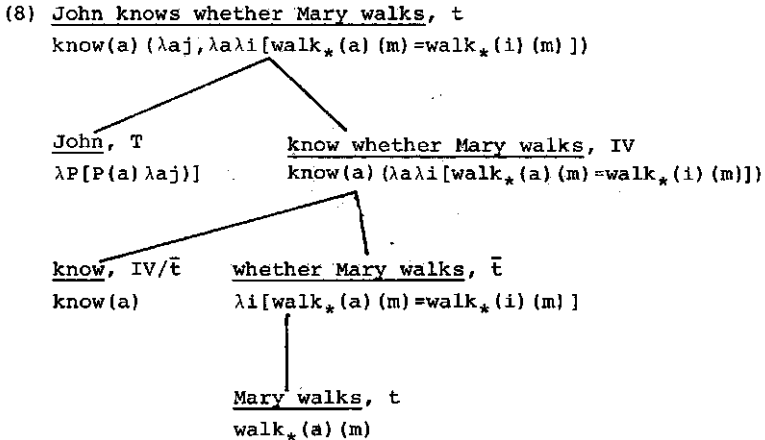

The rule which forms a whether-complement from a sentence, and the corresponding translation rule are as follows. (An asterisk indicates that a rule will later be revised.)

(S:WHC*) If $\phi \in P_t$, then whether $\phi \in P_{\bar{t}}$

(T:WHC*) If $\phi \sim \phi'$, then whether $\phi \sim \lambda i [\phi' = \lambda a \phi'](i)$

Whether-complements can be generated by a more general rule¹²:

(S:WHC) If $\phi_1, \dots, \phi_n \in P_t$,
 then whether ϕ_1 or ... or $\phi_n \in P_{\bar{t}}$

(T:WHC) If $\phi_1 \sim \phi'_1, \dots, \phi_n \sim \phi'_n$,
 then whether ϕ_1 or ... or $\phi_n \sim$
 $\lambda i [\phi'_1 = [\lambda a \phi'_1](i) \wedge \dots \wedge \phi'_n = [\lambda a \phi'_n](i)]$

Obviously, (S:WHC*) and (T:WHC*) are special cases of (S:WHC) and (T:WHC).

In general, whether-complements of the form whether ϕ_1 or ... or ϕ_n are ambiguous between an alternative and a yes/no reading. The following two trees and their translations illustrate this ambiguity.

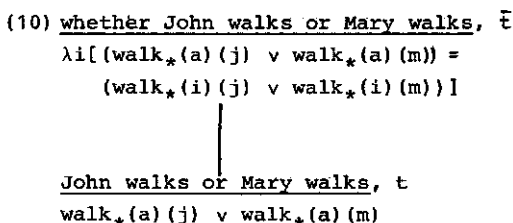
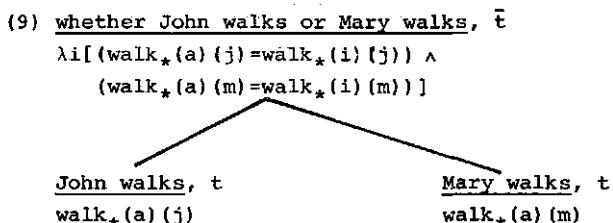

3.2. Extensional and intensional complement embedding verbs

In section 1.3 we stated that verbs such as know and tell are extensional. The meaning postulate guaranteeing this reads as follows:

(MP:IV/ \bar{t}) $\exists M \forall x \forall r \forall i [\delta(i)(x, r) = M(i)(x(i), r(i))]$
 M is a variable of type $\langle s, \langle \langle s, t \rangle, \langle e, t \rangle \rangle \rangle$; x of type $\langle s, e \rangle$; r of type $\langle s, \langle s, t \rangle \rangle$; i of type s;
 and δ is the translation of know, tell, etc.

Requiring this formula to hold in all models guarantees that to certain intensional relations between individual concepts

and propositional concepts, extensional relations between individuals and propositions correspond. We extend the sub-star notation convention of PTQ as follows:

$$(SNC) \delta_* = \lambda a \lambda p \lambda u [\delta(a) (\lambda a p) (\lambda a u)]$$

p is a variable of type $\langle s, t \rangle$, u of type e

Combining (MP:IV/ \bar{t}) with (SNC) we can prove that (11) is valid:¹³

$$(11) \quad \forall i [\delta(i)(x, r) = \delta_*(i)(x(i), r(i))]$$

If we apply (11) to the translations of (7) John knows that Mary walks and (8) John knows whether Mary walks, we get the following results:

$$(7') \quad \text{know}_*(j, \lambda a [\text{walk}_*(a)(m)])$$

$$(8') \quad \text{know}_*(j, \lambda i [\text{walk}_*(a)(m) = \text{walk}_*(i)(m)])$$

Formula (7') expresses that the individual John knows the proposition that Mary walks. In (8') it is expressed that John knows the proposition denoted by $\lambda i [\text{walk}_*(a)(m) = \text{walk}_*(i)(m)]$. As has been indicated in section 2.2, which proposition is denoted by this expression at $g(a)$ depends on the truth value of $\text{walk}_*(a)(m)$ at $g(a)$. More generally, we can prove that the following holds:¹⁴

$$(12) \quad \llbracket \lambda i [\phi/a = \phi/i] \rrbracket_{M, g} = \begin{cases} \llbracket \lambda i [\phi/i] \rrbracket_{M, g} & \text{if} \\ \llbracket \phi/a \rrbracket_{M, g} = 1 \\ \llbracket \lambda i [\neg \phi/i] \rrbracket_{M, g} & \text{if} \\ \llbracket \phi/a \rrbracket_{M, g} = 0 \end{cases}$$

Given (12), it is obvious that the arguments (I) and (II) of section 1.1 are valid. Their translations are:

$$(I') \quad \text{know}_*(a)(j, \lambda i [\text{walk}_*(a)(m) = \text{walk}_*(i)(m)])$$

$$\text{know}_*(a)(j, \lambda a [\text{walk}_*(a)(m)])$$

$$\frac{\text{(II')} \text{ know}_*(a) (j, \lambda i [\text{walk}_*(a) (m) = \text{walk}_*(i) (m)])}{\text{know}_*(a) (j, \lambda a [\neg \text{walk}_*(a) (m)])}$$

Since (MP:IV/ \bar{t}) also holds for tell, the arguments (III) and (IV) are rendered valid in exactly the same way. And precisely because (MP:IV/ \bar{t}) does not hold for intensional verbs, arguments like (I)-(IV) cannot be constructed for them. The relations expressed by these verbs are not extensional in object position, their second argument is irreducibly a propositional concept.

Argument (IX), concerning the exhaustiveness of alternative whether-complements, is discussed in section 3.4. The arguments (XV) and (XVI) of section 1.7 are left to the reader.

3.3. Single constituent complements with who

First we consider constituent complements which contain just one occurrence of the wh-term who. An example of an analysis tree of a sentence containing such a complement, together with its translation is:

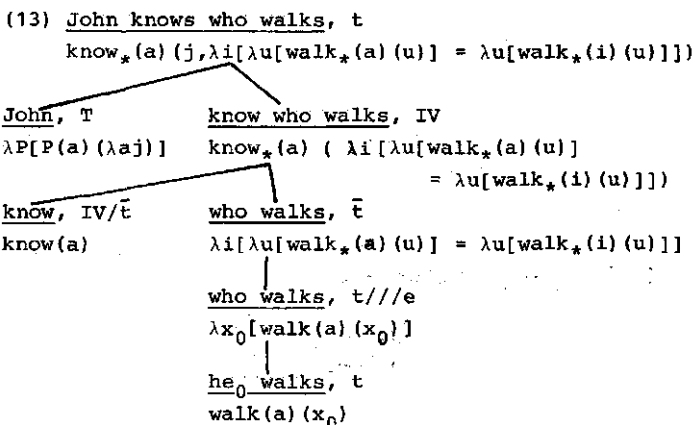

Constituent complements are formed from sentences containing a syntactic variable, but in an indirect way. First a so-called *abstract* is formed, an expression of category $t//e$. The wh-term who(m) is placed at the front of the sentence, certain occurrences of the variable are deleted, others are replaced by suitable pro-forms. For details see section 4. In fact, our use of the phrase 'wh-term' is rather misleading. Unlike the wh-terms in Karttunen's analysis for example, they do not belong to a fixed syntactic category. In this they are like their logical language counterpart, the λ -abstraction sign. Why this is necessary is explained in section 3.8. This rule of abstract formation and its translation are:

- (S:AB1) If $\phi \in P_t$, then $F_{AB1,n}(\phi) \in P_{t//e}$
 (T:AB1) If $\phi \sim \phi'$, then $F_{AB1,n}(\phi) \sim \lambda x_n(\phi')$

The translation of an abstract is a predicate denoting expression. From these abstracts constituent complements are formed. The syntactic rule that does this is a category changing rule. The corresponding translation rule turns predicate denoting expressions into proposition denoting expressions in the way indicated in (5) in section 2.4.

- (S:CCF*) If $\chi \in P_{t//e}$, then $F_{CCF}(\chi) \in P_{\bar{t}}$
 (T:CCF*) If $\chi \sim \chi'$, then $F_{CCF}(\chi) \sim \lambda i[\chi' = [\lambda x'](i)]$

The intermediate level of abstracts is not strictly needed for single constituent complements, but, as shall be argued in section 3.8, it is essential for a correct analysis of constituent complements that contain more than one occurrence of a wh-term. (Moreover, an attractive feature of our analysis is that another kind of wh-construction, relative clauses, can both syntactically and semantically be treated as abstracts as well, see section 4.5.)

We are now able to show that argument (V) of section 1.4 is valid. Its translation is:

$$\frac{(V') \text{ know}_*(a)(j, \lambda i[\lambda u[\text{walk}_*(a)(u)] = \lambda u[\text{walk}_*(i)(u)]])}{\text{walk}_*(a)(b)} \dots \dots \dots$$

$$\text{know}_*(a)(j, \lambda a[\text{walk}_*(a)(b)])$$

From $\llbracket \text{walk}_*(a)(b) \rrbracket_{M,g} = 1$, it follows that $\llbracket \lambda u[\text{walk}_*(a)(u)] \rrbracket_{M,g} (\llbracket b \rrbracket_{M,g}) = 1$. So, at every index k such that $\llbracket \lambda i[\lambda u \text{walk}_*(a)(u)] = \lambda u[\text{walk}_*(i)(u)] \rrbracket_{M,g}(k) = 1$, it also holds that $\llbracket \lambda u[\text{walk}_*(i)(u)] \rrbracket_{M,g}[k/i] (\llbracket b \rrbracket_{M,g}[k/i]) = 1$. I.e. at every such index k : $\llbracket \lambda a[\text{walk}_*(a)(b)] \rrbracket_{M,g}(k) = 1$. Under the not unproblematic, but at the same time quite usual assumption that to know a proposition is to know its entailments, this means that (V') is valid. The assumption in question can be laid down in a meaning postulate in a straightforward way.

3.4. Exhaustiveness

It is easy to see that argument (VIII) of section 1.5, illustrating the exhaustiveness of the proposition denoted by a constituent complement is valid too. Its translation is:

$$\frac{(VIII') \text{ believe}_*(a)(j, \lambda a[\text{walk}_*(a)(b) \wedge \text{walk}_*(a)(s)])}{\forall u[b = u \leftrightarrow \text{walk}_*(a)(u)]}$$

$$\neg \text{know}_*(a)(j, \lambda i[\lambda u[\text{walk}_*(a)(u)] = \lambda u[\text{walk}_*(i)(u)]])$$

Suppose the conclusion is false and the second premiss is true. Then $\llbracket \lambda u \text{walk}_*(a)(u) \rrbracket_{M,g}$ is (the characteristic function of) the unit set consisting of $\llbracket b \rrbracket_{M,g}$. From this it follows that $\llbracket \text{know}_*(a)(j, \lambda a[\forall u[b = u \leftrightarrow \text{walk}_*(a)(u)]]) \rrbracket_{M,g} = 1$. Under the assumption that knowing implies believing, also to be laid down in a meaning postulate, it follows that the first premiss is false. So, (VIII') is valid. We leave it to the reader to verify that the similar arguments (XIII) and (XIV) of section 1.7 are valid too.

Argument (IX), showing the exhaustiveness of whether-complements, translates as follows:

$$\begin{array}{l}
 \text{(IX')} \quad \text{know}_*(a)(j, \lambda i [(\text{walk}_*(a)(m) = \text{walk}_*(i)(m)) \wedge \\
 \qquad \qquad \qquad (\text{sleep}_*(a)(b) = \text{sleep}_*(i)(b))]) \\
 \hline
 \neg \text{walk}_*(a)(m) \wedge \text{sleep}_*(a)(b) \\
 \hline
 \text{know}_*(a)(j, \lambda a [\neg \text{walk}_*(a)(m) \wedge \text{sleep}_*(a)(b)])
 \end{array}$$

From the truth of the second premiss it follows that for every index k such that $\llbracket \lambda i [(\text{walk}_*(a)(m) = \text{walk}_*(i)(m)) \wedge (\text{sleep}_*(a)(b) = \text{sleep}_*(i)(b))] \rrbracket_{M,g}(k) = 1$ it holds that $\llbracket \neg \text{walk}_*(a)(m) \wedge \text{sleep}_*(a)(b) \rrbracket_{M,g}[k/a] = 1$ and thus that for every such index k it holds that $\llbracket \lambda a [\neg \text{walk}_*(a)(m) \wedge \text{sleep}_*(a)(b)] \rrbracket_{M,g}(k) = 1$.

As we already indicated in our discussion of exhaustiveness in section 1.5, argument (X), which translates as (X'), comes out valid in our formal analysis.

$$\begin{array}{l}
 \text{(X')} \quad \text{know}_*(a)(j, \lambda i [\lambda u [\text{walk}_*(a)(u)] = \lambda u [\text{walk}_*(i)(u)]]) \\
 \hline
 \text{know}_*(a)(j, \lambda i [\lambda u [\neg \text{walk}_*(a)(u)] = \lambda u [\neg \text{walk}_*(i)(u)]])
 \end{array}$$

As we argued in section 1.5, the fact that (X') is valid is not due to the incorporation of exhaustiveness, but is a consequence of the fact that the only type of situation which can give rise to counterexamples to (X'), the situations in which the subject of the propositional attitude is not fully informed as to what constitutes the domain of discourse, is not dealt with in the semantic framework used here.

Situations of misinformation about what subset of the domain is determined by a contextual restriction on the range of who, can be regarded as a subtype of this kind of situation. Once either one of these two aspects, which being of a general nature need to be built into the semantic framework anyway, is incorporated, counterexamples to (X') can be constructed, which are structurally the same as those discussed in the next section with regard to argument (XII).

3.5. Single constituent complements with which

The analysis of constituent complements in which one occurrence of a wh-term of the form which δ occurs is illustrated in the following example:

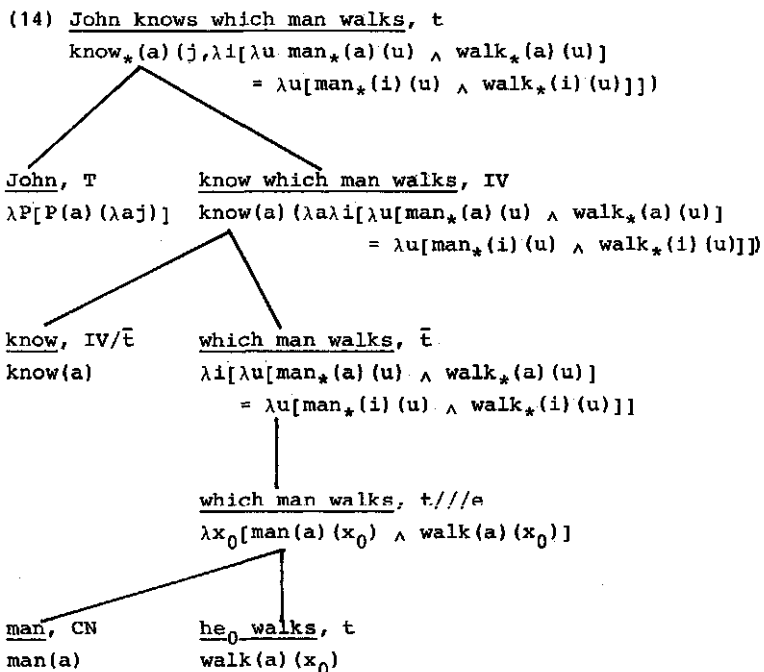

Again, the complement is formed in two steps. First, from a sentence containing a syntactic variable, and a common noun phrase an abstract is formed. The syntactic function which does this is quite similar to the one forming abstracts with who. The syntactic rule and the translation rule are:

(S:AB2) If $\phi \in P_t$ and $\delta \in P_{CN}$, then $F_{AB2,n}(\delta, \phi) \in P_{t//e}$

(T:AB2) If $\phi \sim \phi'$ and $\delta \sim \delta'$,
then $F_{AB2,n}(\delta, \phi) \sim \lambda x_n(\delta'(x_n) \wedge \phi')$

The translation is a complex predicate denoting expression. It denotes the conjunction of the predicate denoted by the common noun phrase and the predicate that can be formed from the sentence.

The second step is to apply the category changing rule (S:CCF*) which turns abstracts into complements. This way of constructing complements like which man walks gives rise to the de dicto reading discussed in section 1.6. The proposition $[[\lambda i[\lambda u[\text{man}_*(a)(u) \wedge \text{walk}_*(a)(u)] = \lambda u[\text{man}_*(i)(u) \wedge \text{walk}_*(i)(u)]]]_{M,g}$ holds at an index k iff the intersection of the set of men and the set of walkers at k is the same as at $g(a)$. If John knows this proposition, it is implied that if a certain individual is a walking man, John knows both that it is a man and that it walks. In view of this, (XII'), the translation of (XII) with both the premiss and the conclusion in the de dicto reading is not valid:

$$\begin{aligned} \text{(XII')} \quad & \text{know}_*(a)(j, \lambda i[\lambda u[\text{man}_*(a)(u) \wedge \text{walk}_*(a)(u)] \\ & \quad = \lambda u[\text{man}_*(i)(u) \wedge \text{walk}_*(i)(u)]] \\ \hline & \text{know}_*(a)(j, \lambda i[\lambda u[\text{man}_*(a)(u) \wedge \neg \text{walk}_*(a)(u)] \\ & \quad = \lambda u[\text{man}_*(i)(u) \wedge \neg \text{walk}_*(i)(u)]] \end{aligned}$$

A counterexample can be constructed as follows. Suppose that for some assignment g and for some individual d it holds that:

$[[\text{walk}_*(a)]_{M,g}(d) = [[\text{man}_*(i)]_{M,g}(d) = [[\text{walk}_*(i)]_{M,g}(d) = 0$, and $[[\text{man}_*(a)]_{M,g}(d) = 1$. Then we can construct a model in which the proposition which is the argument in the premiss holds at $g(i)$, whereas the proposition which is the argument in the conclusion does not. So, the proposition in the premiss does not entail the proposition in the conclusion, which, given the usual semantics of know would be the only way in which the premiss could imply the conclusion. By a similar argument it can be shown that the inverse of (XII') is not valid either.

3.6. De re readings of constituent complements

In section 1.6 we argued that (XII) is valid iff both its premiss and its conclusion are read de re (excluding situations in which individuals may not be fully informed about the domain of discourse). This means that a second way to derive sentences containing constituent complements should be added to the syntax. In this derivation process common noun phrases are quantified into sentences containing a common noun variable $\underline{one}_0, \underline{one}_1, \dots$, which translate into o_0, o_1, \dots of type $\langle\langle s, e \rangle, t \rangle$. The rule of common noun quantification and the corresponding translation rule are as follows:

(S:CNQ) If $\phi \in P_t$ and $\delta \in P_{CN}$, then $F_{CNQ,n}(\delta, \phi) \in P_t$

(T:CNQ) If $\phi \sim \phi'$ and $\delta \sim \delta'$, then

$$F_{CNQ,n}(\delta, \phi) \sim \lambda o_n \phi'(\delta')$$

The sentence John knows which man walks can now also be derived as follows:

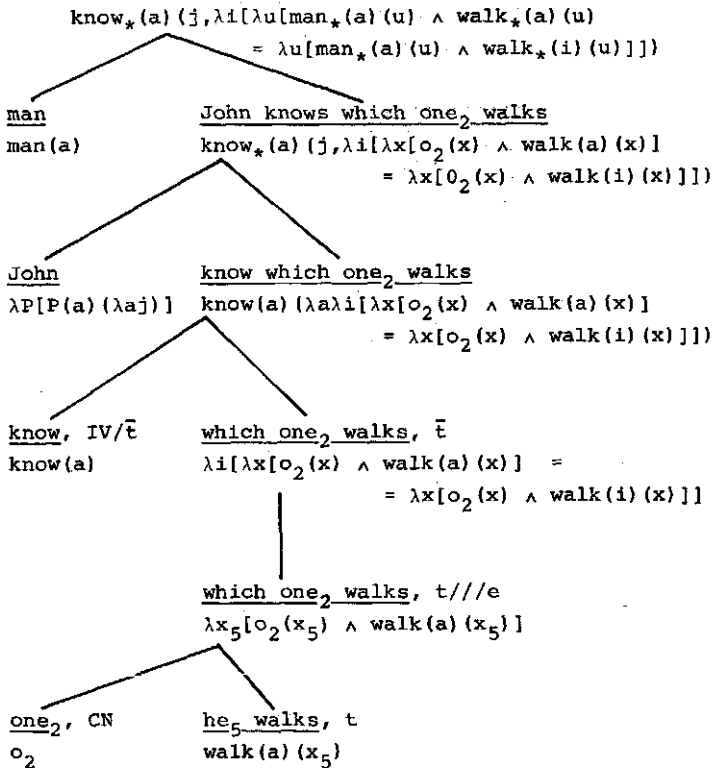
(15) John knows which man walks

The translation of (XII) with both premiss and conclusion read de re is now:

$$\begin{array}{l}
 \text{(XII'')} \text{ know}_*(a) (j, \lambda i [\lambda u [\text{man}_*(a) (u) \wedge \text{walk}_*(a) (u)]]) \\
 \quad = \lambda u [\text{man}_*(a) (u) \wedge \text{walk}_*(i) (u)]] \\
 \hline
 \text{know}_*(a) (j, \lambda i [\lambda u [\text{man}_*(a) (u) \wedge \neg \text{walk}_*(a) (u)]]) \\
 \quad = \lambda u [\text{man}_*(a) (u) \wedge \neg \text{walk}_*(i) (u)]]
 \end{array}$$

The proposition denoted by the complement in the premiss at $g(a)$ is the same as the one denoted by the complement of the conclusion at $g(a)$. The first proposition holds true at an index k iff the intersection of the set of men at $g(a)$ and the set of walkers at $g(a)$ is the same as the intersection

of the set of men at $g(a)$ and the set of walkers at k . Clearly, this is the case iff the intersection of the set of men at $g(a)$ and the set of non-walkers at $g(a)$ is the same as the intersection of the set of men at $g(a)$ and the set of non-walkers at k , i.e. iff the second proposition holds true at k . So, both (XII") and its inverse are valid arguments.

We leave it to the reader to satisfy her/himself that (XI) with its conclusion read *de dicto* is not valid, whereas with the conclusion read *de re* it is.

3.7. Multiple constituent complements

In this section we will outline our treatment of constituent complements in which more than one *wh*-term occurs. The construction of multiple constituent complements starts out with a sentence containing more than one syntactic variable. By using one of the abstract formation rules given above, an abstract is obtained from such a sentence. From this abstract, a 'higher level' abstract is formed. This process can be repeated as long as there are variables left, each time resulting in an abstract of one level higher. This means that there is not just one category of abstracts, but a whole set of abstract categories. The definition of this set and of the corresponding set of abstract types are as follows:

- (a) AB is the smallest subset of CAT such that
 - (i) $t//e \in AB$
 - (ii) if $A \in AB$, then $A/e \in AB$
- (b) AB' is the smallest subset of TYPE such that
 - if $A \in AB$, then $f(A) \in AB'$

To the two rules which formed abstracts from sentences, one for who and one for which δ , there correspond two rules, or better rule schemata, which from an abstract form an abstract of one level higher:

$$(S:AB3) \text{ If } \chi \in P_A, A \in AB, \text{ then } F_{AB3,n}(\chi) \in P_{A/e}$$

(S:AB4) If $\chi \in P_A$, $A \in AB$, and $\delta \in P_{CN}$,
 then $F_{AB4,n}(\delta, \chi) \in P_{A/e}$

The two syntactic functions of this pair of rules differ from those of the former pair. In particular, the *wh*-term is not placed in front of the abstract, but is substituted for a certain occurrence of the syntactic variable. As a matter of fact, this is the main reason for distinguishing the two pairs of rules; the new translation rules follow the same pattern as the old ones. This is most obvious in the case of who:

(T:AB3) If $\chi \sim \chi'$, then $F_{AB3,n}(\chi) \sim \lambda x_n \chi'$

Like the syntactic rule, the translation rule is a rule schema, making use of the fact that the syntactic rule of the logical language forming λ -abstracts is a rule schema as well: abstracts $\lambda x \alpha$ can be formed from a variable x and an expression α of arbitrary type.

For which δ the situation is slightly more complicated. The old translation:

$$\lambda x_n [\delta' (x_n) \wedge \phi']$$

cannot be used as such in case ϕ is not a sentence, but an abstract. The conjunction sign \wedge does not have the variable character that the λ -abductor has.

We therefore extend our logical language with a new kind of expressions which do have this flexible character. These expressions are called restricted λ -abstracts and are of the form $\lambda x[\alpha]\beta$. The abstraction is restricted to those entities which satisfy the predicate denoted by α . We will use these new expressions in the translation rule (T:AB4) as follows:

(T:AB4) If $\delta \sim \delta'$ and $\chi \sim \chi'$,
 then $F_{AB4,n}(\delta, \chi) \sim \lambda x_n [\delta'] \chi'$

So, the translation is a restricted λ -abstract, where the abstraction is restricted to the individual concepts which

satisfy the translation of the common noun phrase δ in which δ .

The new clause in the definition of the logical language and its interpretation are as follows:

- (R λ) If $x \in \text{VAR}_a$, $\alpha \in \text{ME}_{\langle a, t \rangle}$ and $\beta \in \text{ME}_b$, $b \in \text{AB}'$, then $\lambda x[\alpha]\beta \in \text{ME}_{\langle a, b \rangle}$
 $[[\lambda x[\alpha]\beta]]_{M, g}$ is that function $h \in D_{M, \langle a, b \rangle}$ such that for all $d \in D_{M, a}$
 $h(d) = [[\beta]]_{M, g}[x/d]$ if $[[\alpha]]_{M, g}(d) = 1$,
 $= \text{zero}_b$ if $[[\alpha]]_{M, g}(d) = 0$,
 where $\text{zero}_t = 0$; $\text{zero}_{\langle a, b \rangle}$ is the constant function from $D_{M, a}$ to zero_b

The expressions β are restricted to expressions of abstract types, i.e. they are n -place predicate expressions ($n \geq 1$). A more general definition of restricted λ -abstraction for arbitrary types is possible, if we are prepared to have zero elements of type e and type s as well. The expression $\lambda x[\alpha]\beta$ is an abstract of one level higher than β , i.e. an $n + 1$ place predicate expression. When applied to an argument d of which the one-place predicate denoted by α is true,

$[[\lambda x[\alpha]\beta]]_{M, g}(d)$ denotes the same n -place predicate as the unrestricted abstract $[[\lambda x\beta]]_{M, g}$ applied to d . When α is false of d , $[[\lambda x[\alpha]\beta]]_{M, g}(d)$ denotes a zero n -place predicate: a predicate which invariably gives the value 0, no matter to which arguments it is applied.

The category changing rule (S:CCF*) which formed constituent complements from expressions of abstract category $t//e$, can now be generalized to a constituent complement formation rule scheme (S:CCF) which applies to expressions of arbitrary abstract category. The corresponding translation rule (T:CCF) remains essentially the same as the old one:

- (S:CCF) If $\chi \in P_A$, $A \in \text{AB}$, then $F_{\text{CCF}}(\chi) \in P_{\bar{e}}$
 (T:CCF) If $\chi \sim \chi'$, then $F_{\text{CCF}}(\chi) \sim \lambda i[\chi' = [\lambda a\chi'](i)]$

The following analysis trees are examples of the derivation of sentences containing multiple constituent complements with who and which:

- (16) who loves whom, \bar{t}
 $\lambda i[\lambda u\lambda v[\text{love}_*(a)(u,v)] = \lambda u\lambda v[\text{love}_*(i)(u,v)]]$
- |
- who loves whom, (t//e)/e
 $\lambda x_1\lambda x_0[\text{love}(a)(x_0,x_1)]$
- |
- who loves him, t//e
 $\lambda x_0[\text{love}(a)(x_0,x_1)]$
- |
- he₀ loves him₁, t
 $\text{love}(a)(x_0,x_1)$
-
- (17) which man which girl loves, \bar{t}
 $\lambda i[\lambda u[\text{girl}_*(a)]\lambda v[\text{man}_*(a)(v) \wedge \text{love}_*(a)(u,v)]]$
 $= \lambda u[\text{girl}_*(i)]\lambda v[\text{man}_*(i)(v) \wedge \text{love}_*(i)(u,v)]]$
- |
- which man which girl loves, (t//e)/e
 $\lambda x_0[\text{girl}(a)]\lambda x_1[\text{man}(a)(x_1) \wedge \text{love}(a)(x_0,x_1)]$
- / \
- girl, CN which man he₀ loves, t//e
 $\text{girl}(a)$ $\lambda x_1[\text{man}(a)(x_1) \wedge \text{love}(a)(x_0,x_1)]$
- / \
- man, CN he₀ loves him₁, t
 $\text{man}(a)$ $\text{love}(a)(x_0,x_1)$

It can in general be proved that if β is an n -place predicate expression, taking arguments of type a_1, \dots, a_n , and x_1, \dots, x_n are variables of type a_1, \dots, a_n respectively, then $\lambda x[\alpha]\beta$ is equivalent to $\lambda x\lambda x_1, \dots, \lambda x_n[\alpha(x) \wedge \beta(x_1, \dots, x_n)]$. This means that the translation of the second line of (17) is

equivalent to: $\lambda x_0 \lambda x_1 [girl(a)(x_0) \wedge man(a)(x_1) \wedge love(a)(x_0, x_1)]$.
So the top line of (17) is equivalent to:

$$(17') \lambda i [\lambda u \lambda v [girl_*(a)(u) \wedge man_*(a)(v) \wedge love_*(a)(u, v)] \\ = \lambda u \lambda v [girl_*(i)(u) \wedge man_*(i)(v) \wedge love_*(i)(u, v)]]$$

This means that it is possible to reformulate (T:AB2) in terms of restricted λ -abstraction. (The same holds for (T:AB1) and (T:AB3) if that turns out to be necessary, cf. the remarks on argument (X) in sections 3.4 and 1.5.) We leave it to the reader to verify that the arguments (VI) and (VII) of section 1.4 are valid. The proof of their validity runs parallel to that of (V'), given in section 3.3.

The analysis of constituent complements presented here can easily be extended to cover complements with expressions like why, where, when, etc. as well. What is needed are syntactic variables that range over the proper kinds of entities. Further the set of abstract categories has to be extended, to cover abstraction over these variables. The syntactic and the corresponding translation rules have the same form as the rules discussed above.

3.8. Why abstracts are necessary

As we already stated in section 3.3, the level of abstracts is not strictly needed for the analysis of single constituent complements, they could be formed directly from sentences. However, abstracts (or some similar distinct level of analysis) seem to be essential for a correct analysis of multiple constituent complements. The reasons behind this can be outlined as follows.

Without the intermediary level of abstracts, one would need a syntactic rule which forms (multiple) constituent complements by introducing a (new) wh-term into a complement. On the semantic level such a rule would have to transform an expression of the form (a) into one of the form (b):

- (a) $\lambda i[\alpha/a/ = \alpha/i/]$
 (b) $\lambda i[\lambda x[(\dots\alpha\dots)/a/] = \lambda x[(\dots\alpha\dots)/i/]]$

The problem is to make this transition in a compositional way. A possibility that might suggest itself is to treat wh-terms not as a kind of abstractors, but as a kind of terms that can only be introduced by means of a quantification rule. We might translate who as in (c), and formulate a quantification rule which, when applied to a wh-term β and a complement ρ , translates as (d):

- (c) $\lambda PVx[P(a)(x)]$
 (d) $\lambda j[\beta(\lambda \lambda x_n[\rho(j)])]$, where β translates a wh-term and ρ a complement and x_n is the variable quantified over

If we apply (d) to the term (c) and a complement of the form (a), the result is (e), which is equivalent to (f). The expression (f) is of the form (b), so in this case we have succeeded in making a transition from an expression of the form (a) to an expression of the form (b) in a compositional way.

- (e) $\lambda j\forall x[\lambda x_n[\alpha/a/ = \alpha/j/](x)]$
 (f) $\lambda i[\lambda x_n\alpha/a/ = \lambda x_n\alpha/i/]$

However, this approach is only possible as long as we do not take wh-terms of the form which δ into consideration. A term of the form which δ would translate as (g). Applying (d) to a term of the form (g) and a complement of the form (a) results in (h):

- (g) $\lambda PVx[\delta(x) \rightarrow P(a)(x)]$
 (h) $\lambda j[\forall x[\delta(x) \rightarrow (\lambda x_n[\alpha/a/ = \alpha/j/])(x)]]$

The expression (h) is equivalent to (i):

- (i) $\lambda i[\lambda x_n[\delta(x_n) \wedge \alpha/a/] = \lambda x_n[\delta(x_n) \wedge \alpha/i/]]$

But, since both occurrences of δ in (i) contain a free occurrence of a , this results only in de re readings of complements, not in de dicto ones. Result (i) is not of the required form (b). The de dicto reading would be expressed by (j):

$$(j) \lambda i[\forall x[[\delta(x) \wedge (\lambda x_n \alpha)(x)]/a/ = [\delta(x) \wedge (\lambda x_n \alpha)(x)]/i/]]$$

This formula (j) is equivalent to one of the form (b), but it seems impossible to obtain (j) from (a) and (g) in a compositional way. Although we lack a formal proof, we are convinced that there is no way to proceed from (a) and (g) to an expression which gives de dicto readings. Consequently, we feel that the level of abstracts is indeed necessary, it is necessary to account for de dicto readings of multiple constituent complements.¹⁵

In a nutshell, this is the reason why Karttunen's approach, being a quantificational one, can only account for the de re readings. The fact that Karttunen uses existential rather than universal quantification is not essential. It has to do with the fact that in his analysis complements denote sets of propositions instead of single propositions and with the fact that he does not take into account the exhaustiveness of wh-complements.

This is also the reason why it is impossible to treat wh-terms as terms, i.e. as expressions of (a subcategory of) the category T. In a quantificational approach like Karttunen's, wh-terms can be treated as 'normal' terms. From a syntactic point of view, this may be an advantage. However, as we hope to have shown, the quantificational approach has important semantic shortcomings. And it seems that semantic considerations lead us to the abstractor view of wh-terms. This means that wh-terms have to be treated as syncategorematic expressions (or, alternatively, as expressions belonging to the whole range of categories $(t//e)/t$, $((t//e)/e)/(t//e)$, etc.).

4. Details of a possible syntax for wh-complements

4.1. Background assumptions

In section 3 we explained how the semantic analysis of wh-complements proposed in this paper can be incorporated systematically in the framework of Montague grammar. There we did not bother about the syntactic details. In this section we will try to be a little bit more explicit. We will sketch one possible syntax of wh-constructions which is suitable for our semantics. The syntax presented here is in the line of the modifications of Montague's original syntax as proposed by Partee (see Partee, 1976, 1979a and 1979b) and others. Some of its aspects will remind the reader of work done in transformational grammar. Of course, we do not claim that the analysis of wh-complements presented here is new. Moreover, we do not attempt to solve all of the notoriously difficult syntactic problems in this area. We merely wish to show in this section that our semantic analysis of wh-complements can be combined with a feasible syntactic analysis.

In what follows the following assumptions concerning the syntax are made. The syntax produces not plain strings, but labelled bracketings (or, equivalently, phrase structure trees). The labeled bracketings account for the intuitions about the constituent structure of expressions and contain all the information which is needed for syntactic purposes. The constituent structure of an expression is, in general, not enough to determine its semantic interpretation. The semantic interpretation of an expression is determined by its derivation, which is encoded in its analysis tree.

Further it is assumed that the facts concerning pro-nominalization, reflexivization and 'wh-movement' are to be accounted for in terms of structural properties, i.e. properties of labelled bracketings, such as Reinhart's notion of c-command (see Reinhart, 1976). For an analysis of pro-nominalization and reflexivization in terms of structural properties in the Montague framework the reader is referred to Landman and Moerdijk (1981). Their paper also contains an analysis of some wh-constructions which, like the one presented here, uses structural properties, but differs from our analysis in several other respects.

4.2. 'Wh-preposing' and 'preposable occurrences'

We will concentrate on the rules which build abstracts. There are four of them, two 'preposing' rules, (S:AB1) and (S:AB2), and two 'substitution' rules (S:AB3) and (S:AB4). We start with (S:AB1), the rule which produces abstracts with preposed who(m). We want this rule to produce structures such as (18b)-(21b) from structures such as (18a)-(21a):

- (18) (a) $t_{[T[he_0]_{IV}[walks]]}$
 (b) $AB_{[WHT[who]_{t_{[WHT[]_{IV}[walks]]}]}$
- (19) (a) $t_{[T[John]_{IV}[TV[loves]_T[him_0]]]}$
 (b) $AB_{[WHT[whom]_{t_{[T[John]_{IV}[TV[loves]_{WHT[]]}]}}]}$
- (20) (a) $t_{[t_{[T[he_0]_{IV}[walks]]}]}$ and $t_{[T[he_0]_{IV}[talks]]]}$
 (b) $AB_{[WHT[who]_{t_{[WHT[]_{IV}[walks]]}]}$ and $t_{[T[]_{IV}[talks]]]}$
- (21) (a) $t_{[T[he_0]_{IV}[IV/\bar{t}[says]_{\bar{t}[that]_{t_{[T[John]_{IV}/\bar{t}[knows]_{\bar{t}[WHT[who]_{\bar{t}[WHT[]_{IV}[walks]]}]}}]}}]}]}]}$
 (b) $AB_{[WHT[who]_{t_{[WHT[]_{IV}[IV/\bar{t}[says]_{\bar{t}[that]_{t_{[T[John]_{IV}[IV/\bar{t}[knows]_{\bar{t}[WHT[who]_{\bar{t}[WHT[]_{IV}[walks]]}]}}]}}]}]}]}]}]}$

(S:AB1) operates on sentential structures containing one or more occurrences of a syntactic variable he_n . It creates a structure labelled AB by 'preposing' the wh-term who(m),

substituting a trace (i.e. empty node) for some, 'preposable', occurrences of \underline{he}_n and anaphorizing the others. The occurrences of \underline{he}_n which are replaced by a trace share certain structural properties. They are called the wh-p-antecedent occurrences of \underline{he}_n . One of these occurrences is replaced by a WHT-trace, the others by T-traces. Traces are left because in order for pronominalization, reflexivization and abstract formation to work properly, the structural properties of certain expressions in the original structure have to be recoverable. In effect, leaving traces is nothing but building into the structure those aspects of derivational history which continue to have syntactic relevance.

We add two general remarks. First, notice that labels like AB and WHT are not category labels. AB acts as a variable over category labels, WHT labels expressions which are introduced syncategorematically. The use of such labels does not present semantic problems since it is the derivational history, and not the structure, of an expression that determines its meaning. Second, as structures (21) show, the output of a category changing rule no longer contains the original category label: the complement of know is of the form $\bar{t}_{\text{WHT}}[\text{who}]\dots$ and not of the form $\bar{t}_{\text{AB}}[\text{WHT}[\text{who}]\dots]$. This is based on the assumption that information about the old category is no longer syntactically relevant. Nothing in our analysis, however, depends on this assumption.

The notion of wh-p-antecedent occurrence is not only needed to distinguish those occurrences of \underline{he}_n which are to be replaced by a trace, it will also be used to determine whether a given structure is a proper input for (S:AB1). Before giving a definition, let us point out what will be understood by an occurrence. Formally, an occurrence of an expression α in a structure β is an ordered pair $\langle n, \bar{x}[\alpha(-)] \rangle$, where n defines a position in β , \bar{x} is the label of α and $(-)$ is the set of features that determines the morphological form. In what follows we will not use the term 'occurrence' so strictly. For example we will write \bar{t}_{Him_0}

instead of $\tau[he_0(\text{acc})]$, etc. The notion of wh-p-antecedent occurrence is defined as follows:

- (WH-P) The wh-p-antecedent occurrences of he_n in ϕ are those occurrences α of he_n in ϕ such that:
- (i) α is not c-commanded by another occurrence of he_0 in ϕ ;
 - (ii) α is not dominated by a node t such that that node is directly dominated by a node A : $A \neq t$;
 - (iii) if α occurs in a coordinate structure in ϕ then for every coordinate ψ there is a wh-p-antecedent occurrence of he_n in ψ

We will give a few examples to illustrate this. In these examples only the relevant aspects of the structures are represented. First consider (22):

- (22) he_0 loves him_0 self
 α β

α is a wh-p-antecedent occurrence of he_0 , but β isn't, since β is c-commanded by α . So, (22) will give rise to (22a) but not to (22b):

- (22) (a) $AB[who_t[_{WHT}[]loves\ himself]]$
 (22) (b) $*AB[who[_T[]loves_{WHT}[]]]$

Next consider (23):

- (23) he_0 says \bar{t} [that $_t$ [Mary loves him_0]]
 α β

Again α is a wh-p-antecedent occurrence, and β is not. Not only because β is c-commanded by α , but also because β is dominated by a t which is directly dominated by a \bar{t} . So, (23) will lead to (23a), but not to (23b):

- (23) (a) $AB[who_t[{}_{WHT}[]]says\ that\ Mary\ loves\ him[]]$
 (23) (b) $*AB[whom_t[{}_{T}[]]says\ that\ Mary\ loves\ {}_{WHT}[]]]$

Another example illustrating condition (ii) is (24):

- (24) John says $\bar{t}[that_t[he_0\ loves\ Mary]]$
 α

α is not a wh-p-antecedent occurrence, because it is dominated by a t which is directly dominated by \bar{t} . Thus (24a) will not be derivable from (24):

- (24) (a) $*AB[who_t[John\ says_{\bar{t}}[that_t[{}_{WHT}[]]loves\ Mary]]]]$

Notice that condition (ii) excludes any occurrence of a syntactic variable in an embedded clause. As (25a) indicates, this is too strong:

- (25) (a) $AB[whom_t[John\ says_{\bar{t}}[that_t[Mary\ loves\ {}_{WHT}[]]]]]]$

This would have to be derived from the structure (25):

- (25) John says $\bar{t}[that_t[Mary\ loves\ him_0]]$
 α

If we weaken condition (ii) by adding:

... unless the case of $\alpha \neq$ nominative and
 $A = \bar{t}$ -that

then α in (25) counts as a wh-p-antecedent of he_0 . Notice that β in (23) is still excluded by condition (i). By \bar{t} -that, of course, we mean to label the subcategory of that-complements. That the above weakening should be restricted to that-complements is made clear by (26):

Notice that in case we weaken condition (ii) as indicated above, there is a wh-p-antecedent occurrence of \underline{he}_0 in (30), but not in (31) according to (iii):

- (30) John says \bar{t} [that_t[_t[Peter loves him₀] and
_t[Mary kisses him₀]]]
- (31) John says \bar{t} [that_t[_t[Peter loves him₀] and
_t[Mary kisses Bill]]]

Notice further that (32) does not contain a wh-p-antecedent occurrence of \underline{he}_0 since, although α and β are dominated by a node t which is directly dominated by another node t , they also occur in a t (i.e. the entire coordinate structure) which is directly dominated by \bar{t} :

- (32) John says \bar{t} [that_t[_t[\underline{he}_0 walks] and _t[\underline{he}_0 talks]]]
 α β

All those occurrences of \underline{he}_n in ϕ which are not wh-p-antecedent occurrences according to (WH-P) we call wh-p-anaphor occurrences of \underline{he}_n in ϕ . The formulation of the syntactic rule (S:AB1) now runs as follows:

- (S:AB1) If $\phi \in P_t$, then $F_{AB1,n}(\phi) \in P_{t//e}$
 Condition: ϕ contains one or more wh-p-antecedent occurrences of \underline{he}_n , all of which have the same case c .
 $F_{AB1,n}(\phi) = AB[\text{WHT}[\text{who}(c)]_t[\phi']]$, where ϕ' comes from ϕ by performing the following operations:
- (i) if $c = \text{nominative}$ then replace the first, else replace the last, wh-p-antecedent occurrence of \underline{he}_n in ϕ by $\text{WHT}[\]$;
 - (ii) delete all other wh-p-antecedent occurrences of \underline{he}_n in ϕ , i.e. replace them by $\bar{t}[\]$;
 - (iii) anaphorize all wh-p-anaphor occurrences of \underline{he}_n in ϕ

The examples (18)-(32) illustrate the working of this rule. The condition which restricts the application of (S:AB1) deals with the familiar cases of case-conflict. It would become superfluous once a theory of features, e.g. in the line of Landman and Moerdijk (1981), is incorporated. Clause (i) is stated in terms of case, we do not want to exclude the possibility to formulate it in terms of structural properties. The anaphorization operation in (iii) here comes to simply removing indices.

The second 'wh-preposing' rule, which preposes wh-terms of the form which δ , is a minor variation of the one just given. It reads as follows:

- (S:AB2) If $\phi \in P_t$ and $\delta \in P_{CN}$, then
 $F_{AB2,n}(\delta, \phi) \in P_t // e$
 Condition: as in (S:AB1).
 $F_{AB2,n}(\delta, \phi) = AB[WHT[\text{which } \delta(c)]_t[\phi']]$, where ϕ'
 comes from ϕ by performing the following
 operations:
 (i) and (ii) as in (S:AB1)
 (iii) as in (S:AB1), taking into account the
 (number and) gender of δ .

Examples similar to the ones already given for (S:AB1) can easily be constructed.

4.3. Wh-reconstruction

Interesting cases of application of (S:AB2) are those in which the common noun δ is not lexical, but itself complex and contains an occurrence of a syntactic variable, e.g.:

- (33) $AB[\text{which poem of him}_0 \text{ }_t[\text{he}_0 \text{ likes best } WHT[\]]]$
 $\alpha \quad \beta$
- (34) $AB[\text{which man who loves him}_0 \text{ }_t[\text{he}_0 \text{ likes best } WHT[\]]]$
 $\alpha \quad \beta$

Notice that in both structures α and β do not c-command each other. If it were the case that β c-commanded α , then this could be used to explain why (35a) and (36a) are acceptable, whereas (35b) and (36b) are not (on coreferential readings, of course):

- (35) (a) $_{AB}$ [which poem of him $_{t}$ [every poet likes best $_{WHT}$ []]]
 (35) (b) * $_{AB}$ [which poem of every poet $_{t}$ [he likes best $_{WHT}$ []]]
 (36) (a) $_{AB}$ [which man who loves her $_{t}$ [every girl likes best $_{WHT}$ []]]
 (36) (b) * $_{AB}$ [which man who loves every girl $_{t}$ [she likes best $_{WHT}$ []]]

A natural condition (see Reinhart, 1976, 1979) on antecedent-anaphor relations is that an anaphor does not c-command its antecedent. Notice that although β does not c-command α , it does c-command the trace of the wh-term in which α occurs. It seems that in the process of deriving (35a) from (33) structural relations such as c-command are not determined on (33) as such, but on what is called the wh-reconstruction of (33).^{17,18} This notion is defined as follows:

- (WH-R) The wh-reconstruction of a structure ϕ is that structure ϕ' which is the result of replacing, bottom up, each substructure of the form $[_{WHT}[\gamma]_{t}[\psi]]$ by $[_{t}[\psi']]$, which is the result of substituting the wh-term γ for its trace in ψ

Notice that the existence of a unique trace for each occurrence of a wh-term is guaranteed by the direction of the reconstruction process (bottom up) and the nature of the proposing rules (S:AB1) and (S:AB2).

For every structural property P we define a corresponding structural property P' as follows:

(RSP) α has the structural property P' in the structure ϕ iff α has the structural property P in the wh-reconstruction of ϕ

From now on we will refer to structural properties P' as P, e.g. from now on c-command stands for c-command'.¹⁹

At this point a remark on the nature of WHT-traces is in order. In fact a WHT-trace is nothing but a T-trace in a special structural position. So, WHT-traces are marked T-traces. However, whether or not a T-trace is in this special structural position, can always be determined, so the special marking is not essential.

We could do without WHT-traces and only use T-traces. The wh-reconstruction is then defined as follows:

(WH-R') The wh-reconstruction of a structure ϕ is that structure ϕ' which is the result of replacing, bottom up, each substructure of the form $[_{WHT}[\gamma]_t[\psi]]$ by $[_t[\psi']]$, which is the result of substituting γ for the first T-trace in ψ if γ has nominative case, and for the last T-trace in ψ otherwise

Of course, if one extends the present analysis to the more difficult cases involving pied-piping etc., the definition of wh-reconstruction might become more complicated. However, we feel that a reconstruction in terms of structural positions of T-traces will always be possible. In fact it has to be since this seems to be the only explanation for the fact that language users are able to interpret wh-constructions at all. A language user is capable of recognizing a hole in a structure (i.e. a trace), he will be capable of determining its category and its structural properties, but it seems unlikely that he is able to distinguish between subcategories of holes, if the subcategory information in question represents structural information which is not also present in the structure itself.

4.4. Wh-substitution and substitutable occurrences

Other cases where we need wh-reconstruction than the ones discussed above, involve the other two abstract formation rules, the wh-substitution rules. These rules form abstracts from abstracts by substituting who(m), which δ , for an occurrence of a syntactic variable. They are highly parallel to the previous two. However, they operate on a type of occurrences of syntactic variables which is a bit less constrained than wh-p-antecedent occurrences. The difference is that the substitution rules are allowed to operate on occurrences which are inside a complement. Consider three examples:

- (37) (a) AB[who_t[_{WHT}[]knows_t[who_t[_{WHT}[]loves him₀]]]]
 (37) (b) AB[who_t[_{WHT}[]knows_t[who_t[_{WHT}[]loves which girl]]]]
 (38) (a) AB[who_t[_{WHT}[]knows_t[whether_t[he₀ walks]]]]
 (38) (b) AB[who_t[_{WHT}[]knows_t[whether_t[which girl walks]]]]
 (39) (a) AB[who_t[_{WHT}[]knows_t[that_t[he₀ walks]]]]
 (39) (b) AB[who_t[_{WHT}[]knows_t[that_t[which girl walks]]]]

The multiple constituent complement in the (b)-sentences can be constructed from the single constituent complements in the (a)-sentences. To see that the substitution rules are more liberal than the preposing rules, compare (38) with (26) and (39) with (24). This leads to the following notion of wh-s-antecedent occurrence:

- (WH-S) The wh-s-antecedent occurrences of he_n in ϕ are those occurrences α of he_n in ϕ such that:
- (i) α is not c-commanded by another occurrence of he_n in ϕ ;
 - (ii) α is not dominated by a node t such that that node is directly dominated by a node A : $A \neq t, \bar{t}$;
 - (iii) if α occurs in a coordinate structure in

ϕ then for every coördinate ψ there is a wh-s-antecedent occurrence of \underline{he}_n in ψ

(WH-S) only differs from (WH-P) in that in clause (ii) A may be either t or \bar{t} . So occurrences within subordinate clauses other than complements are still out of bounds. As an example consider (40):

(40) AB [which man_{RC}[who_t[_{WHT}[]loves
him₀]]_t[_{WHT}[]walks]]
 α

According to (WH-S) α is not a wh-s-antecedent occurrence of \underline{he}_0 , since $RC \neq t, \bar{t}$. (In section 4.5 we will identify RC as a subcategory of $t//e$.) The wh-s-anaphor occurrences of \underline{he}_n in ϕ are those which are not wh-s-antecedent occurrences of \underline{he}_n in ϕ . The two wh-substitution rules can now be formulated as follows:

(S:AB3) If $\chi \in P_A$, $A \in AB$, then $F_{AB3,n}(\chi) \in P_{A/e}$
Condition: χ contains one or more wh-s-antecedent occurrences of \underline{he}_n , all of which have the same case c.

$F_{AB3,n}(\chi) = \chi'$ where χ' comes from χ by performing the following operations:

- (i) if $c = \text{nominative}$ then replace the first, else the last, wh-s-antecedent occurrence of \underline{he}_n in χ by $_{WHT}[\text{who}(c)]$;
- (ii) delete all other wh-s-antecedent occurrences of \underline{he}_n in χ , i.e. replace them by $_{T}[\]$;
- (iii) anaphorize all wh-s-anaphor occurrences of \underline{he}_n in χ

(S:AB4) If $\chi \in P_A$, $A \in AB$, and $\delta \in P_{CN}$, then

$F_{AB4,n}(\delta, \chi) \in P_{A/e}$

Condition: as in (S:AB3).

$F_{AB4,n}(\delta, \chi) = \chi'$, where χ' comes from χ by

performing the following operations:

- (i) if c = nominative, then replace the first, else replace the last, wh-s-antecedent occurrence of \underline{he}_n in χ by $_{WHT}$ [which $\delta(c)$];
- (ii) as in (S:AB3);
- (iii) as in (S:AB3), taking into account the (number and) gender of δ

Given these rules (37b)-(39b) can be derived from the corresponding (a)-structures. Two other examples are:²⁰

- (41) (a) $_{AB}$ [who $_t$ [$_t$ [$_{WHT}$ []loves him $_0$]and
 $_t$ [$_T$ []kisses him $_0$]]]
- (41) (b) $_{AB}$ [who $_t$ [$_t$ [$_{WHT}$ []loves $_T$ []]and
 $_t$ [$_T$ []kisses whom]]]
- (42) (a) $_{AB}$ [which girl $_t$ [$_t$ [he $_0$ loves $_T$ []]and
 $_t$ [he $_0$ kisses $_{WHT}$ []]]]
- (42) (b) $_{AB}$ [which girl $_t$ [$_t$ [which man loves $_T$ []]
and $_t$ [$_T$ []kisses $_{WHT}$ []]]]

The notion of wh-reconstruction plays an essential role in determining the wh-s-antecedent occurrences of a syntactic variable and thereby in the way in which (S:AB3) and (S:AB4) function. Consider again (33):

- (33) $_{AB}$ [which poem of him $_0$ $_t$ [he $_0$ likes best $_{WHT}$ []]]
 α β

If the structural notions like c-command were not redefined as in (RSP), then both α and β would count as wh-s-antecedent occurrences. Together with the 'same-case'-condition this means that we could not derive (43):

- (43) $_{AB}$ [which poem of him $_t$ [which poet
likes best $_{WHT}$ []]]

However, given the fact that the *c*-command notion used in (WH-S) is redefined as in (RSP), in fact only β counts as a *wh-s*-antecedent occurrence in (33), since β *c*-commands (in the old sense) α in the *wh*-reconstruction of (33). This means that (43) can be derived from (33).

4.5. Relative clauses

We will end section 4 by indicating how another type of *wh*-constructions, that of relative clauses, can be treated in this framework. Observe that the kind of expressions formed by (S:AB1) can not only be used to form complements from, but can also be used as relative clauses. Relative clauses are constructed in exactly the same way and are subject to exactly the same constraints (in English at least). So all the relevant examples given above apply here too.

Semantically we can regard relative clauses as abstracts, i.e. predicate denoting expressions, too. So, relative clauses are taken to be constructed from sentences containing a *wh-p*-antecedent occurrence of a syntactic variable by the first abstract formation rule (S:AB1). This means that the category *t//e*, the category of expressions produced by the two preposing abstract formation rules (S:AB1) and (S:AB2), has to be split into two subcategories, (*t//e*)₁, which contains the results of (S:AB1), and (*t//e*)₂, which contains the results of (S:AB2). Expressions of the first subcategory can then be used as input in two rules which combine them with a common noun or a term. These rules can be formulated as follows:

- (S:RRC) If $\delta \in P_{CN}$, $\chi \in P_{(t//e)_1}$
 then $F_{RRC}(\delta, \chi) \in P_{CN}$, where $F_{RRC}(\delta, \chi) = \delta\chi$
- (T:RRC) If $\delta \sim \delta'$, $\chi \sim \chi'$,
 then $F_{RRC}(\delta, \chi) \sim \lambda x[\delta'(x) \wedge \chi'(x)]$
- (S:NRC) If $\alpha \in P_T$, $\chi \in P_{(t//e)_1}$, then $F_{NRC}(\alpha, \chi) \in P_T$,
 where $F_{NRC}(\alpha, \chi) = \alpha\chi$

(T:NRC) If $\alpha \sim \alpha'$, $\chi \sim \chi'$, then

$$F_{\text{NRC}}(\alpha, \chi) \sim \lambda P[\alpha' \langle \lambda a \lambda x [P(a)(x) \wedge \chi'(x)] \rangle]$$

Rule (S:RRC) produces restrictive relative clause constructions, (S:NRC) non-restrictive relative clause constructions. Both rules do not, as they stand, account for the necessary agreement in number and gender. This could be handled either by a theory of features as proposed by Landman and Moerdijk (1981) or by a mechanism of sub-categorization as proposed by Janssen (1980b).

The two translation rules are straightforward. In fact, the analysis of restrictive relative clause constructions can be regarded as an analysis of the CN-S type, with this difference that (S:RRC) does not take a sentence as such, but an abstract formed from a sentence (see Janssen, 1981, for extensive discussion of the various types of analyses of restrictive relative clause constructions). The semantic part of the analysis of non-restrictive relative clause constructions is in essence the one given by Rodman (1976).

The fact that both types of wh-constructions, viz. relative clause constructions and constituent complements, at a certain level of analysis can be regarded as constructions of the same category, in our opinion supports the existence of the level of abstracts as a separate level of analysis.

5. Coordination of complements

5.1. The need for complement-level terms

In section 1.8 we argued that the fact that *wh*-complements and *that*-complements can be coordinated is an argument in favour of treating them as belonging to the same syntactic category. We have not yet shown how the coordination of complements is to be carried out. The reason for this is that a proper account involves complications which might have obscured the basic principles of our analysis of the semantics of *wh*-complements. In order to give a proper account of the coordination of complements, one needs to analyze them as a kind of terms, as expressions denoting not propositions as such, but sets of properties of propositional concepts. This 'higher level' analysis is needed to ensure that the following three types of complements come out as they should:

- | | |
|---------------------------------------|------------------------------|
| (a) whether (ϕ and ψ) | 'conjunctive complement' |
| (b) whether ϕ and whether ψ | 'conjunction of complements' |
| (c) whether ϕ or ψ | 'alternative complement' |

The relation between alternative complements and disjunctive complements, i.e. complements of type whether (ϕ or ψ), has already been discussed in section 3.1, examples (9) and (10). A fifth type of complement is disjunction of complements, i.e. complements of type whether ϕ or whether ψ . They will not be discussed since they are analogous to conjunctions of complements.

The difference between conjunctive complements and

conjunctions of complements is clear from the difference in meaning between sentences of the form (44) and (45):

(44) Bill wonders whether (ϕ and ψ)

(45) Bill wonders whether ϕ and whether ψ

Whereas (45) implies that Bill wonders whether ϕ , (44) does not. In other words, (45), but not (44), is equivalent to (46):

(46) Bill wonders whether ϕ and Bill wonders whether ψ

This means that conjunctions of complements should be analyzed in such a way that complement taking verbs distribute over the complements which are their conjuncts.

The difference between conjunctions of complements and alternative complements may be a little harder to grasp. At first they may seem equivalent, but we will argue that they are not. Consider the following sentence forms:

(47) Bill wants to know whether ϕ or ψ

(48) Bill wants to know whether ϕ and whether ψ

(49) Bill knows whether ϕ

Obviously, (48) is false if (49) is true. It may seem that this holds for (47) too. However, in our opinion this is not the case without further qualification. The truth of (49) as such does not imply the falsity of (47). That it seems to do so is caused by the implicature carried by alternative complements that (according to the subject) exactly one of the alternatives holds. If (Bill assumes that) either ϕ or ψ is true, but not both, then it would indeed follow from (49) that (47) is false. As we already argued in section 1.7, however, we are dealing here with an implicature, and not with an implication. That it is an implicature is also clear from the fact that it can be cancelled, as is illustrated in the following example:

complements are equivalent to alternative complements. In case one deals with a finite (sub)domain and d_1, \dots, d_n name all the elements, the alternative complement corresponding to a constituent complement can be written down, as the following pair of sentences illustrates:

(54) Bill investigated who did it

(55) Bill investigated whether d_1 did it, or ..., or d_n did it

Clearly, (54) and (55) are equivalent. Now, again, (56) is not a contradiction:

(56) Already having established that Peter didn't do it, Bill investigated who did it

Given the equivalences of (54) and (55), this means that (57) isn't a contradiction either:

(57) Already having established that Peter didn't do it, Bill investigated whether Mary did it, ..., or Peter did it, or ...

Like (52), (57), though not necessarily false, may violate the Gricean maxims. Notice that (56) is much less likely to be in conflict with these maxims than (57). On the other hand, (58) is contradictory:

(58) Already having established that Peter didn't do it, Bill investigated whether Mary did it and whether Harry did it ... and whether Peter did it ...

And this leads to the same conclusion as above: despite their seeming similarity, which can be explained in terms of implicatures, alternative complements and conjunctions of complements express different propositional concepts.

5.2. Analyzing complements as complement-level terms

The facts discussed in section 5.1, in particular the fact that complement taking verbs distribute over the complements which make up a conjunction of complements, point towards a 'higher level' analysis of complements. For different reasons, such a higher level analysis of that-complements is proposed in Delacruz (1976). He argues that that-complements are to be analyzed in terms of sets of properties of propositions. In our analysis this comes to considering complements to be expressions which denote sets of properties of propositional concepts. It should be noted that kicking complements upstairs in this way does not change anything fundamental in our semantic analysis. The rule which transforms complements 'old style' into complement terms, i.e. expressions of category $t/(t/\bar{t}) = CT$, is as follows:

- (S:CTF) If $\rho \in P_{\bar{t}}$, then $F_{CTF}(\rho) \in P_{CT}$
 (T:CTF) If $\rho \sim \rho'$, then $F_{CTF}(\rho) \sim \lambda R[R(a)(\lambda a \rho)']$
 where R is a variable of type $\langle s, \langle \langle s, \langle s, t \rangle \rangle, t \rangle \rangle$

The reason to keep the intermediary stage of expressions of category \bar{t} , is that they are needed as input for a rule which quantifies terms into complements (see section 4.3).

The syntactic rule is a category changing rule. The translation rule shows that the complement term formed from a complement ρ denotes the set of properties of the propositional concept expressed by ρ . Complement-embedding verbs are now of a higher level too, of course. They are expressions of category IV/CT. The complement-embedding rule remains a simple rule of functional application. Sentence (8) of section 3.1 is now analyzed as follows:

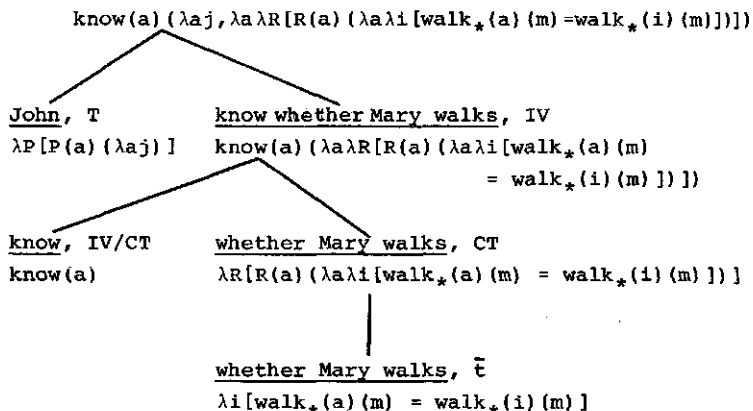
(59) John knows whether Mary walks, t

(59) expresses that an intensional relation of knowing holds between an individual concept and the intension of a set of properties of a propositional concept. The following meaning postulate reduces this high-level intensional relation into a low-level extensional one, i.e. to a relation between an individual and a proposition.

(MP:IV/CT-E) $\exists M \forall x \forall R \forall i [\delta(i) (x, R)$
 $= \{R(i) (\lambda i \lambda r [M(i) (x(i), r(i))]) \}],$
 M is a variable of type $\langle s, \langle \langle s, t \rangle, \langle e, t \rangle \rangle \rangle$;
 x of type $\langle s, e \rangle$; R of type
 $\langle s, \langle \langle s, \langle \langle s, \langle s, t \rangle \rangle, t \rangle \rangle, t \rangle \rangle$; i type s; r of
 type $\langle s, \langle s, t \rangle \rangle$ and δ is the translation
 of know, tell, etc.

The substar notation convention is now extended as follows:

(SNC) $\delta_* = \lambda i \lambda p \lambda u [\delta(i) (\lambda i u, \lambda i \lambda R [R(i) (\lambda i p)])],$
 p is a variable of type $\langle s, t \rangle$; u of type e; R of
 type $\langle s, \langle \langle s, \langle s, t \rangle \rangle, t \rangle \rangle$; p of type $\langle s, t \rangle$

Combining (MP:IV/CT-E) with (SNC) one can prove that (60) is valid:

$$(60) \forall i[\delta(i)(x, R) = (R(i)(\lambda i \lambda r[\delta_*(i)(x(i), r(i))]))]$$

Applying (60), we get the following reduced translation of (59):

$$(59') \text{ know}_*(a)(j, \lambda i[\text{walk}_*(a)(m) = \text{walk}_*(i)(m)])$$

This is exactly the same result as we obtained in our low-level analysis. For those verbs, such as wonder, which are extensional in subject position, but intensional in object position, we propose the following meaning postulate which reduces the high-level intensional relation expressed by these verbs to a low-level intensional one.

$$\begin{aligned} (\text{MP:IV/CT-I}) \exists N \forall x \forall R \forall i[\delta(i)(x, R) = \\ R(i)(\lambda i \lambda r[N(i)(x(i), r)])], \\ N \text{ is a variable of type } \langle s, \langle \langle s, \langle s, t \rangle \rangle, \langle e, t \rangle \rangle \end{aligned}$$

Further, we introduce the following notation convention:

$$(\text{CNC}) \delta_+ = \lambda i \lambda r \lambda u[\delta(i)(\lambda i u, \lambda i \lambda R[R(i)(r)])]$$

Combining (MP:IV/CT-I) with (CNC) one can prove that (61) is valid:

$$(61) \forall i[\delta(i)(x, R) = R(i)(\lambda i \lambda r[\delta_+(i)(x(i), r)])]$$

Given (61) the following is the reduced translation of Bill wonders whether Mary walks:

$$(62) \text{ wonder}_+(a)(b, \lambda a \lambda i[\text{walk}_*(a)(m) = \text{walk}_*(i)(m)])$$

5.3. Complement coordination

Let us now turn to complement coordination, which necessitates this move to the complement term level (we

restrict ourselves to conjunction, the rule for disjunction is completely analogous):

(S:CTCO) If $\Sigma, \Theta \in P_{CT}$, then Σ and $\Theta \in P_{CT}$

(T:CTCO) If $\Sigma, \Theta \sim \Sigma', \Theta'$, then Σ and $\Theta \sim \lambda R[\Sigma'(R) \wedge \Theta'(R)]$

These rules can be illustrated by considering the derivation of the three types of complements (a), (b) and (c):

(a') whether (ϕ and ψ), CT

$\lambda R[R(a) (\lambda \lambda i[(\phi/a/ \wedge \psi/a/) = (\phi/i/ \wedge \psi/i/)])]$

whether (ϕ and ψ), \bar{t}

$\lambda i[(\phi/a/ \wedge \psi/a/) = (\phi/i/ \wedge \psi/i/)]$

(b') whether ϕ and whether ψ , CT

$\lambda R[R(a) (\lambda \lambda i[\phi/a/ = \phi/i/]) \wedge R(a) (\lambda \lambda i[\psi/a/ = \psi/i/])]$

whether ϕ , CT

$\lambda R[R(a) (\lambda \lambda i[\phi/a/ = \phi/i/])]$

whether ϕ , \bar{t}

$\lambda i[\phi/a/ = \phi/i/]$

whether ψ , CT

$\lambda R[R(a) (\lambda \lambda i[\psi/a/ = \psi/i/])]$

whether ψ , \bar{t}

$\lambda i[\psi/a/ = \psi/i/]$

(c') whether ϕ or ψ , CT

$\lambda R[R(a) (\lambda \lambda i[(\phi/a/ = \phi/i/) \wedge (\psi/a/ = \psi/i/)])]$

whether ϕ or ψ , \bar{t}

$\lambda i[(\phi/a/ = \phi/i/) \wedge (\psi/a/ = \psi/i/)]$

It can be proved that the complement terms (a'), (b') and (c') denote different sets of properties of propositional

concepts. Sentences of the form (44) and (45) are now translated as follows:

- (44') Bill wonders whether (ϕ and ψ), t
 $wonder(a) (\lambda ab, \lambda a \lambda R [R(a) (\lambda a \lambda i [(\phi/a/ \wedge \psi/a/) =$
 $(\phi/i/ \wedge \psi/i/)])])$
- (45') Bill wonders whether ϕ and whether ψ , t
 $wonder(a) (\lambda ab, \lambda a \lambda R [R(a) (\lambda a \lambda i [\phi/a/ = \phi/i/])$
 $\wedge R(a) (\lambda a \lambda i [\psi/a/ = \psi/i/])])$

If we apply (MP:IV/CT-I) to these translations, we get the following results:

- (44'') $wonder_+(a) (b, \lambda a \lambda i [(\phi/a/ \wedge \psi/a/) = (\phi/i/ \wedge \psi/i/)])$
 (45'') $wonder_+(a) (b, \lambda a \lambda i [\phi/a/ = \phi/i/])$
 $\wedge wonder_+(a) (b, \lambda a \lambda i [\psi/a/ = \psi/i/])$

Of course, (45'') is also the translation of (46):

- (46) Bill wonders whether ϕ and Bill wonders whether ψ

This illustrates that complement-embedding verbs distribute over a conjunction of complements, but the fact that (44'') does not imply (45'') shows that they do not distribute over a conjunctive complement.

The difference between (44'') and (45'') can also be illustrated using the following meaning postulate:

- (MP:INQ) $\forall x \forall y \forall i [\delta(i)(x, r) \rightarrow \neg know_+(i)(x, r(i))]$
 where δ is $wonder_+$, $investigate_+$, ask_+ , etc.

Given (MP:INQ), which captures a central part of the meaning of inquisitive verbs, (44'') and (45'') imply (63) and (64) respectively:

- (63) $\neg know_+(a) (b, \lambda i [(\phi/a/ \wedge \psi/a/) = (\phi/i/ \wedge \psi/i/)])$
 (64) $\neg know_+(a) (b, \lambda i [\phi/a/ = \phi/i/]) \wedge$
 $\neg know_+(a) (b, \lambda i [\psi/a/ = \psi/i/])$

Using the same meaning postulate we can also illustrate the difference between (47) and (48). Using (MP:INQ), (47) implies (65), whereas (48) implies (64):

$$(65) \neg \text{know}_*(a)(b, \lambda i[(\phi/a/ = \phi/i/) \wedge (\psi/a/ = \psi/i/)])$$

One might think that not just (65), but also the stronger (64) follows from (47). This is, however, again a matter involving implicatures. Although (64) is not an implication of (47), it is an implication of (48). And, as we have seen above, (48) in its turn follows from (47) on the assumption of the truth of the implicature that exactly one of the alternatives holds. But that means that (64) follows from (47) too, if this implicature is true.

To sum up, treating complement coordination like we do enables us to account for the difference in meaning between (a), (b) and (c). The facts discussed above show that (45) implies (47) which in its turn implies (44). An interesting fact to note is that in this respect too there is a difference between intensional and extensional complement embedding verbs. Consider (66)-(68):

(66) Bill wonders whether John walks and Mary walks

(67) Bill knows whether John walks and whether Mary walks

(68) Bill knows whether John walks or Mary walks

It turns out that (67) and (68) are equivalent and that both imply (66). The equivalence of (67) and (68) may at first sight seem counterintuitive since there are clearly differences between them. However, as we argued above, in section 1.7, these differences do not concern truth conditional aspects of meaning, but are of a pragmatic nature.

6. Two loose ends and one speculative remark

6.1. A scope ambiguity in wh-complements

In this section we will show how a certain type of scope ambiguity can be accounted for in our analysis. A prime example is the ambiguity of sentence (69), extensively discussed in Karttunen and Peters (1980):

(69) Bill wonders which professor recommends each candidate

In order to facilitate the exposition we will discuss a simpler sentence, (70), and return to (69) at the end of this section:

(70) Bill wonders whom everyone loves

Following Karttunen and Peters we claim that (70) has three different readings. Two of them, (70a) and (70b), can be obtained in a straightforward way with the rules already available:

(70a) $wonder_+(a)(b, \lambda a \lambda i [\lambda v [\forall u [\text{love}_*(a)(u, v)]]]$
 $= \lambda v [\forall u [\text{love}_*(i)(u, v)]]]$
'Bill wonders who is loved by everyone'

(70b) $\forall u [wonder_+(a)(b, \lambda a \lambda i [\lambda v [\text{love}_*(a)(u, v)]]]$
 $= \lambda v [\text{love}_*(i)(u, v)]]]$
'For each person Bill wonders who is loved by that person'

Universal quantification semantically amounts to a (possibly infinite) conjunction. Suppose we are dealing with finite cases so that we can write these conjunctions down. (This is of course not an essential restriction.) Then (70) (a) (b) (c) are equivalent to the conjunctions (70) (a') (b') (c') (in which d_1, \dots, d_n name all the individuals):

- (70a') $wonder_+(a)(b, \lambda a \lambda i [\lambda v [\text{love}_*(a)(d_1, v)$
 $\wedge \dots \wedge \text{love}_*(a)(d_n, v)]$
 $= \lambda v [\text{love}_*(i)(d_1, v) \wedge \dots \wedge \text{love}_*(i)(d_n, v)]]$
- (70b') $wonder_+(a)(b, \lambda a \lambda i [\lambda v [\text{love}_*(a)(d_1, v)$
 $= \lambda v [\text{love}_*(i)(d_1, v)]]$
 $\wedge \dots \wedge wonder_+(a)(b, \lambda a \lambda i [\lambda v [\text{love}_*(a)(d_n, v)$
 $= \lambda v [\text{love}_*(i)(d_n, v)]])]$
- (70c') $wonder_+(a)(b, \lambda a \lambda i [(\lambda v [\text{love}_*(a)(d_1, v)]$
 $= \lambda v [\text{love}_*(i)(d_1, v)]]$
 $\wedge \dots \wedge (\lambda v [\text{love}_*(a)(d_n, v)]$
 $= \lambda v [\text{love}_*(i)(d_n, v)]])]$

It can be proved that (70a'), (70b') and (70c') express different propositions. In connection with this, it may be useful to point at the correspondence between (70a') and conjunctive complements, between (70b') and conjunction of complements, and between (70c') and alternative complements.

The implications resulting from application of (MP:INQ) to (70) (a) (b) (c) reflect the intuitions about the differences between the three readings of (70):

- (70a'') $\neg \text{know}_*(a)(b, \lambda i [\lambda v [\forall u [\text{love}_*(a)(u, v)]$
 $= \lambda v [\forall u [\text{love}_*(i)(u, v)]]]$
- (70b'') $\forall u [\neg \text{know}_*(a)(b, \lambda i [\lambda v [\text{love}_*(a)(u, v)]]$
 $= \lambda v [\text{love}_*(i)(u, v)]]]$
- (70c'') $\neg \text{know}_*(a)(b, \lambda i [\forall u [\lambda v [\text{love}_*(a)(u, v)]$
 $= \lambda v [\text{love}_*(i)(u, v)]]])]$

It is interesting to note that, like in section 5.3 and of course for the same reasons, there is a difference between

extensional and intensional complement embedding verbs. If the matrix verb is extensional the (c)-reading collapses into the (b)-reading. This result is in accordance with the fact that (71), in contrast with sentence (70) has only two readings:

(71) Bill knows whom everyone loves

The results of quantifying into the sentence and the complement respectively are:

(71b) $\forall u[\text{know}_*(a)(b, \lambda i[\lambda v[\text{love}_*(a)(u, v)]]$
 $= \lambda v[\text{love}_*(i)(u, v)]]]$

(71c) $\text{know}_*(a)(b, \lambda i[\forall u[\lambda v[\text{love}_*(a)(u, v)]]$
 $= \lambda v[\text{love}_*(i)(u, v)]]])]$

We leave it to the reader to verify that (71b) and (71c) are indeed equivalent, stressing the fact that this equivalence is essentially due to the fact that (71b) and (71c) concern relations between individuals and propositions, and not, as (70b) and (70c) do, relations between individuals and propositional concepts.

This difference between extensional and intensional complement embedding verbs also accounts for the fact that (72) is equivalent with (73) and with (74) on the reading where everyone has widest scope (but see the remarks in sections 1.5 and 3.4), whereas (75) is not equivalent with (76) (nor with (77) on the reading with everyone having widest scope):

(72) Bill knows who walks

(73) Of everyone, Bill knows whether he/she walks

(74) Bill knows whether everyone walks

(75) Bill wonders who walks

(76) Of everyone, Bill wonders whether he/she walks

(77) Bill wonders whether everyone walks

Notice that despite the equivalence of (72) and (73), (78) and (79) need not be equivalent:

- (78) Bill knows which man walks
- (79) Of every man, Bill knows whether he walks

(78) and (79) are equivalent only if (78) is read de re. Analogously, (70), on its reading (70c), is equivalent to (80), but (82) is equivalent to (81), on its third reading, only if (82) is read de re:

- (70) Bill wonders whom everyone loves
- (80) Bill wonders whom who loves
- (81) Bill wonders whom every man loves
- (82) Bill wonders whom which man loves

This means that quantifying a term into a complement always results in a de re reading of the common noun contained in the term (if any). So our approach predicts that (69) is equivalent to one reading of (83), viz. the one in which which candidate is read de re:

- (69) Bill wonders which professor recommends each candidate
- (83) Bill wonders which professor recommends which candidate

Whether this is a completely satisfactory result is, to be honest, beyond the scope of our intuitions.

6.2. Wh-complements in an extension of IL

In section 2.5 we said that one can get a long way in the analysis of complements by adding a new intensional operator to IL. As a matter of fact, one could come quite as far as the end of section 5, since the phenomena that resist an

adequate treatment in such an intensional language are phenomena like those discussed in the previous section 6.1.

The new operator, called Δ , can be introduced in IL as follows:

- (i) If $\alpha \in ME_a$, then $\Delta\alpha \in ME_{\langle s, t \rangle}$
 $[[\Delta\alpha]_{M, k, g}]$ is that $p \in \{0, 1\}^I$ such that for every $i \in I$: $p(i) = 1$ iff $[[\alpha]_{M, k, g}] = [[\alpha]_{M, i, g}]$

With the aid of Δ , the translations of the complement formation rules discussed in section 3 can be formulated as follows:

- (T:THC') If $\phi \sim \phi'$, then that $\phi \sim \hat{\phi}'$
 (T:WHC') If $\phi \sim \phi'$, then whether $\phi \sim \Delta\phi'$
 (T:WHC') If $\phi_1, \dots, \phi_n \sim \phi'_1, \dots, \phi'_n$, then whether ϕ_1 , or \dots , or $\phi_n \sim \Delta\lambda p [p \wedge [p = \hat{\phi}'_1 \vee \dots \vee p = \hat{\phi}'_n]]$
 (T:CCF') If $\chi \sim \chi'$, then $F_{CCF}(\chi) \sim \Delta\chi'$

The phenomena that cause this approach to fail have in common that their treatment requires the possibility to quantify terms into complements. An example of such a phenomenon is the 'third reading' of sentence (20), mentioned in section 6.1. Another example is the reading of (84):

- (84) John will tell whether every president walks

in which the term every president has narrow scope with respect to the tense, but wide scope with respect to the complement. On this reading (84) is true if at some time in the future John tells of every individual which at that time is a president whether he or she walks or not.

In order to obtain these readings, we need to be able to quantify terms into complements. This rule of quantification (S:QC) and its translation rule (T:QC) were stated in

section 6.1:

(R:QC) If $\alpha \in P_{\mathbb{T}}$, and $\rho \in P_{\mathbb{I}}$, then $F_{QC,n}(\alpha, \rho) \in P_{\mathbb{I}}$

(T:QC) If $\alpha, \rho \sim \alpha', \rho'$, then

$$F_{QC,n}(\alpha, \rho) \sim \lambda i[\alpha'(\lambda \alpha \lambda_n[\rho'(i)])]$$

The difficulty in formulating a translation rule in $IL + \Delta$ is that we cannot express the equivalent of $\rho'(i)$. We can only express the equivalent of $\rho'(a)$, namely $\forall \rho'$. (Notice that $\forall \Delta \alpha$ expresses the proposition that is true at every index.) In $IL + \Delta$ we could only arrive at the translation rule:

(T:QC') If $\alpha, \rho \sim \alpha', \rho'$, then $F_{QC,n}(\alpha, \rho) \sim \wedge[\alpha'(\wedge \lambda \alpha_n[\forall \rho'])]$

If ψ' is of the form $\Delta \alpha$, the resulting expression denotes a proposition that holds true at every index, instead of denoting a proposition in the required index dependent way.

6.3. Remark on the semantics of direct questions

At the beginning of this paper, we expressed the hope that an adequate semantics of wh-complements might give a clue to the semantics of direct questions as well. At first sight, it seems that little or nothing speaks against simply associating direct questions with the same semantic objects we associated wh-complements with. An objection that might come to mind is this. Suppose ϕ is true. Then the direct questions Does John know whether ϕ ? and Does John know that ϕ ? denote the same proposition. Wouldn't this mean that asking the first question comes to the same thing as asking the second one? No, no more than that asserting a declarative sentence ϕ comes to the same thing as asserting a declarative sentence ψ in case ϕ and ψ happen to have the same truth value. Although the denotations of the two questions are the same, their senses still are different.

Another interesting issue is to what extent we could consider the proposition denoted by a question to be the proposition expressed by an answer to it. At first sight, it seems to make a good deal of sense to say that the proposition denoted by a question at a given index, is the proposition expressed by a true answer to that question at that index, and that hence the sense of a question could be described as a function from indices to true answers. However, things are more complicated. Compare the following sentences:

- (85) Who won the Tour de France in 1980?
- (86) Joop Zoetemelk won the Tour de France in 1980
- (87) The one who ended second in 1979 won the Tour de France in 1980

Of course, (86) is a true answer to (85). However, in many cases (87) counts as a true answer as well. But it cannot be the case that both (86) and (87) express the proposition denoted by (85), since (86) and (87) clearly express different propositions. In our analysis, (86) expresses the proposition denoted by (85). In order to grant (87) the status of answerhood as well, one would need some property, in between 'denoting the same truth value' and 'expressing the same proposition', which (86) and (87) share. Such a property requires something in between truth values and possible worlds. It could very well be that the notion of possible fact, in the sense of Veltman (1981), is what is needed. One might then take a declarative sentence to be an answer to a question iff the possible fact expressed by the sentence is in some way related to the proposition denoted by the question. Then (86) and (87) would both qualify as answers to (85), since although they do not express the same proposition they do presumably express the same possible fact. It should be noted that this would not involve a change in the semantics of questions, it would be a refinement of the semantics needed for a satisfactory account of the

property of answerhood (and probably of many other things besides).

So, we conclude that it is misleading to interpret the proposition denoted by a question as the unique true answer to it.²¹ Both (86) and (87) should count as answers to (85). In fact, we believe that (86) should not even be granted a special status, even though it expresses the same proposition as (85) actually denotes. For there are situations in which (87) is a better answer to (85), for example by being more informative, than (86) is. In our opinion, this holds quite generally. Within the semantic limits set by the denotation of a question, what counts as a good answer is determined by pragmatic factors. These concern, among other things, the information available to the hearer, the information of the speaker about the information of the hearer, etc.²²

Pragmatic considerations again are all important in the following example:

- (88) Where can one buy Italian newspapers?
- (89) At the Centraal Station (one can buy Italian newspapers)
- (90) At the Atheneum Newscentre (one can buy Italian newspapers)

Clearly, there are situations in which each of (89) and (90) on its own constitutes a proper answer to (88). But the propositions expressed by (89) and (90) are only part of (entailments of) the proposition denoted by (88). Some have taken this to show that questions are ambiguous between an existential (exemplificatory) and a universal (exhaustive) reading. This runs counter to the exhaustiveness, even to the lowest degree, which we ascribe to wh-complements. Like Karttunen, we feel that again this is a pragmatic rather than a semantic phenomenon. Whether a question asks for a complete answer or for an incomplete one, depends on the needs of the one asking it. For example,

(88) when asked by an Italian tourist is properly answered, at least in most cases, by indicating one place where Italian newspapers are sold: what the tourist wants is a newspaper. (This does not mean that (89) and (90) in every such situation are equally good; other pragmatic factors, such as the acquaintance of the questioner with the various locations, etc. may be involved.) But when (88) is asked by someone who is interested in setting up a distribution network in Amsterdam for foreign newspapers, clearly an exhaustive answer to (88) is called for. So again, what counts as an answer is determined by pragmatic factors within the limits set by the semantics of the question.

Of course, these are just a few, rather speculative remarks, and a lot more has been (and still should be) said on these matters. But they seem to lead us to the conclusion that no semantic theory on its own can be expected to provide a satisfactory account of question-answer relations. Evidently, a pragmatic theory is called for. However, such a theory should be based on an adequate semantic theory. It is our hope that the semantic theory of *wh*-complements developed in this paper contributes to the survey of the semantic space within which pragmatic factors determine the question-answer relationship.

Notes

- * Part of the material presented in this paper appeared as G & S 1981. We would like to thank Renate Bartsch, Elisabeth Engdahl, Roland Hausser, Fred Landman, Alice ter Meulen, Ieke Moerdijk, Zeno Swijtink, Henk Verkuyl, and in particular Johan van Benthem, Theo Janssen, Lauri Karttunen and the anonymous referees of Linguistics and Philosophy for their comments and criticisms on earlier versions, which have led to many improvements.
1. We are told by one of the referees that David Lewis has developed a similar idea concerning whether-complements in an unpublished paper. We have not seen the paper, therefore we are unable to draw a comparison.
[Added in proof: In the meantime we have obtained a copy of a recent version of Lewis' 1974 note, which under the title 'Whether' report is to appear in a Festschrift of which the publication data are not known to us. In this paper, Lewis discusses the index dependent character of whether-complements and proposes an analysis in terms of double indexing. We cannot argue for it here, but we feel that Lewis' analysis, in which whether-complements are taken to be expressions of sentence type, is less natural and less general than ours, in which they are considered to denote propositions. In particular, by taking the sense of complements to be propositional concepts, our analysis solves the problems with intensional (see section 1.3) complement embedding verbs which Lewis' proposal runs into.]
 2. In order to avoid terminological confusion, let us point out that the way we use the terms 'extensional' and 'intensional' here, is a generalization of the terminology used in PTQ which does not fully conform to the traditional use. So, know is extensional in our sense of the term since it operates on the denotation of the complement that is its argument. But it is intensional in the traditional sense since the denotation of a complement is an intensional entity, viz. a proposition.
 3. If their conclusions are read de re, these arguments are valid. If their conclusions are read de dicto, however, they are not. It turns out that the combination of treating proper names as rigid designators and verbs such as know as relations between individuals and propositions does not make it possible to distinguish a de dicto reading of the conclusions of these arguments. This is not correct, it

should be possible to distinguish a de dicto reading of these sentences, while maintaining a rigid designator view of the proper names at the same time.

4. Complements of this form are ambiguous between an alternative and a yes/no reading. The latter might be indicated as whether (ϕ or ψ). In section 3.1 we show how this ambiguity is accounted for. In (IX) the alternative reading is meant.
5. That this is so, can be seen from the fact that the same phenomenon can be observed with other types of sentences. For example, it is not unreasonable to distinguish between a de dicto and a de re reading of the sentence John believes that everyone walks. Its de re reading would be true iff John believes of every individual that is in the domain of discourse that he/she walks, whereas its de dicto reading would be true iff John believes of every individual that according to him is in the domain of discourse that he/she walks. Yet within a possible world semantics, this distinction can be made only if one allows for varying domains in some sense. Since we are dealing here with a general problem of the semantics of propositional attitudes within an intensional framework, and not with a problem that is specific to finding a correct semantics for wh-complements, and since this paper is about the latter and not about the former, we will not try to solve it here.
6. Karttunen discusses argument (X). His reasons for not accepting (X) as valid accord with our remarks in the previous section on the type of situations that can give rise to counterexamples against (X). However, unlike Karttunen, we do not interpret the possibility of counterexamples as an argument against strong exhaustiveness.
7. For a proposal which makes it possible to consider infinitival complements to be proposition denoting expressions as well, see G & S 1979.
8. There still remains the verb know which takes NP's as in John knows Mary. An argument in favour of regarding this verb to be different from the one taking complements might be that in such languages as German and Dutch the difference is lexicalized. On the other hand, in a sentence like John knows Mary's phone number, the verb know seems to be quite like the complement taking know in many respects. (See also note 10.)
9. As a matter of fact, Karttunen argues against Hintikka's analysis (in Hintikka, 1976) by pointing out that John wonders who came cannot be paraphrased, as Hintikka would have it, as Any person is such that if he came then John wonders that he came. Unlike such verbs as guess and matter, wonder seems to be a truly ambiguous lexical item (in other languages, e.g. in Dutch, the difference in meaning is lexicalized). What arguments like the one used in the text and the one used by Karttunen in our opinion really show is that there is an essential difference between extensional and intensional complement embedding verbs, and that

Hintikka's analysis fails for the intensional ones.

10. The possibility of constructing these proposition denoting expressions from expressions α of arbitrary type is quite interesting also in view of sentences like John knows Mary's phone number, mentioned in note 8. If we simply apply procedure (5) with the translation of the term Mary's phone number substituted for $\alpha/a/$ we seem to obtain exactly the proposition John needs to know if he is to know Mary's phone number. The point was brought to our attention by Barbara Partee.
11. Notice that in PTQ complements are in fact taken to be of category t . When embedded under complement taking verbs, we semantically apply the interpretation of the verb to the sense of the complement. This makes that proposition denoting expressions do occur in PTQ translations. Because of this, one might think that the new category t is superfluous. But it is not, since we want complements to denote propositions and to have propositional concepts as their sense.
12. For those who find it unbearable, c.q. unnatural, that the translation of whether ϕ or ψ does not contain a disjunction, we present the following equivalent alternative:

$$(T:WHC') \lambda i[\lambda p[p(a) \wedge [p = \lambda a\phi_1^i \vee \dots \vee p = \lambda a\phi_n^i]] \\ = \lambda p[p(i) \wedge [p = \lambda a\phi_1^i \vee \dots \vee p = \lambda a\phi_n^i]]]$$
13. For those complement embedding verbs for which (MP:IV/ \bar{t}) is not defined (i.e. the intensional ones), (11) holds trivially in case they are combined with a that-complement, since the sense of a that-complement is a constant propositional concept.
14. As (12) shows, whether-complements resemble if then else statements of certain programming languages. In Janssen (1980a) the latter are used as counterexamples to the validity of cap-cup elimination in IL. It seems that wh-complements are natural language counterexamples. If ρ translates a wh-complement, then $\lambda a(\rho(a)) \neq \rho$, i.e. $\sim^* \rho \neq \rho$.
15. Engdahl in Engdahl (1980) presents a modification of Karttunen's framework in which a kind of de dicto readings can be obtained by means of a special storage mechanism. However, it turns out that, in order to obtain correct results, restrictions on the order of quantification of ordinary terms and wh-terms are necessary. But this means that in her framework too, a special level of analysis in between sentences and complements has to be distinguished.
16. Notice that condition (ii) allows the derivation of (i)(a) from (i), though it blocks (i)(b):

- (i) The man_{RC}[who_t[_{WHT}[]loves him₀]]kisses him₀
- (i) (a) ??[whom_t the man_{RC}[who
t[{WHT}[]loves him]]]kisses_{WHT}[]]
- (i) (b) *_{AB}[whom_t[the man_{RC}[who
t[{WHT}[]loves_T[]]]]kisses_{WHT}[]]

Structures like (i) (a) are not generally considered to be well formed. These are problematic cases having to do with cross-over phenomena, which are not dealt with here and which, to our knowledge, present a problem to any account of wh-constructions.

17. Of course, there is more to the antecedent-anaphor relation than c-command (see Landman and Moerdijk (1981) for an extensive discussion within the Montague framework). In the case discussed here, a consequence of using c-command and wh-reconstruction is that (i):

- (i) Which picture that John saw, he likes best

cannot be obtained with coreferentiality of John and he. How these and related problems are to be solved, is quite unclear.

18. It is sometimes claimed, e.g. in Engdahl (1980), that a structure like (35a) has to be ambiguous, since the related direct question allows for two different kinds of answers: functional ones like his last, and pair-list ones like: Gorter, 'Mei'; Kouwenaar, 'Elba'; Gerhardt, 'In tekenen'. For a long time we have thought, following Benett (1979), that functional readings could be regarded as a kind of shorthand for pair-list ones, and that only the latter would have to be accounted for in the semantics. However, in view of Engdahl's arguments and in view of such expressions as (i) and (ii):

- (i) which woman no man loves
 (ii) which woman few men love

which do not have a pair-list reading, but only a functional one (beside the direct reading), we are convinced now that functional readings are independent of pair-list ones. Moreover, they do not only occur with structures like (35a), but as (i) and (ii) show, are a quite general phenomenon. In G & S 1983 we propose to analyze functional readings by means of Skolem-functions. Abstract (35a) for example is then translated as (35a') and (i) as (i'):

- (35) (a') $\lambda f[\forall u[\text{poem-of}_*(a)(u, f(u))$
 $\wedge \forall u[\text{poet}_*(a)(u) \rightarrow \text{like-best}_*(a)(u, f(u))]]$
- (i') $\lambda f[\forall u[\text{woman}_*(a)(f(u))$
 $\wedge \forall u[\text{man}_*(a)(u) \rightarrow \neg \text{love}_*(a)(u, f(u))]]]$

In these formulas f is a variable ranging over functions from individuals to individuals. Complements are formed from these expressions in the usual way.

19. Our notion of wh-reconstruction thus serves syntactical purposes only. In this respect it seems to differ from related notions, e.g. the one proposed in Van Riemsdijk and Williams (1980), where it plays a role in establishing the logical form of wh-constructions.
20. Actually clause (i) in (S:AB3,4) may be a bit too strict, since who loves whom and kisses him is well-formed, but cannot be derived here.
21. Belnap calls this 'the unique answer fallacy' (see Belnap, 1982). We agree with him that it is a mistake to think that every question has in every situation a unique true answer. But we have a different diagnosis as to how and where this has to be accounted for. We cannot do justice here to the many interesting arguments Belnap puts forward, but as will become clear from what follows, we feel that there is far more pragmatics between questions and answers than is accounted for in Belnap's theory.
22. A framework in which this kind of information of language users can be formally represented can be found in G & S (1980) and Van Emde Boas et al. (1981).

References

- Belnap, N., 'Questions and Answers in Montague Grammar', in S. Peters and E. Saarinen (Eds.), Processes, Beliefs and Questions (Reidel, Dordrecht, 1982).
- Bennett, M., 'Questions in Montague Grammar' (Indiana University Linguistics Club, Bloomington, Indiana, 1979).
- Benthem, J. van, 'Tense Logic and Standard Logic', in Logique et Analyse (1978).
- Delacruz, E., 'Factives and Proposition Level Constructions in Montague Grammar', in B. Partee (ed.), Montague Grammar (Academic Press, New York, 1976).
- Emde Boas, P. van, J. Groenendijk, and M. Stokhof, 'The Conway Paradox: Its Solution in an Epistemic Framework', in J. Groenendijk, T. Janssen and M. Stokhof (eds.), Formal Methods in the Study of Language (Mathematical Centre, Amsterdam, 1981).
- Engdahl, E., The Syntax and Semantics of Questions in Swedish (doctoral dissertation, Amherst, 1980).
- Gallin, D., Intensional and Higher-Order Modal Logic (North-Holland, Amsterdam, 1975).
- Gazdar, G., Pragmatics (Academic Press, New York, 1979).
- Groenendijk, J. and M. Stokhof, 'Infinitives and Context in Montague Grammar', in S. Davis and M. Mithun (eds.), Linguistics, Philosophy and Montague Grammar (University of Texas Press, Austin, 1979).
- Groenendijk, J. and M. Stokhof, 'A Pragmatic Analysis of Specificity', in F. Heny (ed.), Ambiguities in Contextual Contexts (Reidel, Dordrecht, 1980).
- Groenendijk, J. and M. Stokhof, 'Semantics of Wh-Complements', in J. Groenendijk, T. Janssen, and M. Stokhof (eds.), Formal Methods in the Study of Language (Mathematical Centre, Amsterdam, 1981).
- Groenendijk, J. and M. Stokhof, 'Interrogative Quantifiers and Skolem-functions', in H. van Riemsdijk and K. Ehlich (eds.), Connectedness in Sentence, Discourse and Text (Tilburg, 1983).
- Hamblin, C., 'Questions in Montague English', in B. Partee (ed.), Montague Grammar (Academic Press, New York, 1976).

- Hausser, R., 'Surface Compositionality and the Semantics of Mood', in J. Groenendijk and M. Stokhof (eds.), Amsterdam Papers in Formal Grammar Vol. II (Centrale Interfaculteit, University of Amsterdam, Amsterdam, 1978).
- Hintikka, J., The Semantics of Questions and The Questions of Semantics (North-Holland, Amsterdam, 1976).
- Janssen, T., 'Logical Investigations on PTQ Arising from Programming Requirements', in Synthese 44 (1980a).
- Janssen, T., 'On Problems Concerning the Quantification Rules in Montague Grammar', in C. Rohrer (ed.), Time, Tense and Quantifiers (Niemeyer, Tübingen, 1980b).
- Janssen, T., 'Relative Clause Constructions in Montague Grammar and Compositional Semantics', in J. Groenendijk, T. Janssen, and M. Stokhof (eds.), Formal Methods in the Study of Language (Mathematical Centre, Amsterdam, 1981).
- Karttunen, L., 'Syntax and Semantics of Questions', in Linguistics and Philosophy 1, (1977), 3-44.
- Karttunen, L. and S. Peters, 'Interrogative Quantifiers', in C. Rohrer (ed.), Time, Tense and Quantifiers (Niemeyer, Tübingen, 1980).
- Kempson, R., Presuppositions and the Delimitation of Semantics (Cambridge University Press, Cambridge, 1975).
- Landman, F. and I. Moerdijk, Morphological Features and Conditions on Rules in Montague Grammar (Amsterdam Papers in Formal Grammar III, Centrale Interfaculteit, University of Amsterdam, Amsterdam, 1981).
- Needham, P., Temporal Perspective (Philosophical Studies, Uppsala, 1975).
- Partee, B., 'Some Transformational Extensions of Montague Grammar', in B. Partee (ed.), Montague Grammar (Academic Press, New York, 1976).
- Partee, B., 'Constraining Montague Grammar', in S. Davis and M. Mithun (eds.), Linguistics, Philosophy and Montague Grammar (University of Texas Press, Austin, 1979).
- Partee, B., 'Montague Grammar and the Wellformedness Constraint', in F. Heny and H. Schnelle (eds.), Syntax and Semantics X: Selections from the Third Groningen Round Table (Academic Press, New York, 1979b).
- Reinhart, T., The Syntactic Domain of Anaphora (doctoral dissertation, MIT, 1976).
- Reinhart, T., 'Syntactic Domains for Semantic Rules', in F. Guenther and S. Schmidt (eds.), Formal Semantics and Pragmatics for Natural Languages (Reidel, Dordrecht, 1979).
- Riemsdijk, H. van, and E. Williams, NP-Structure (unpublished paper, 1980).

- Rodman, R., 'Scope Phenomena, "Movement Transformations", and Relative Clauses', in B. Partee (ed.), Montague Grammar (Academic Press, New York, 1976).
- Veltman, F., 'Data Semantics', in J. Groenendijk, T. Janssen, and M. Stokhof (eds.), Formal Methods in the Study of Language (Mathematical Centre, Amsterdam, 1981).
- Wilson, D., Presupposition and Non-Truthconditional Semantics (Academic Press, New York, 1975).

III

INTERROGATIVE QUANTIFIERS
AND SKOLEM-FUNCTIONS

reprinted from:

K. Ehlich & H. van Riemsdijk (eds.),
Connectedness in sentence, discourse and text
Tilburg, 1983

CONTENTS

0. Introduction	167
1. Scope-ambiguities in questions	169
2. Functional readings of questions	176
3. Functional readings and Skolem-functions	183
4. Functional readings of other constructions	196
5. Conclusion	201
Notes	203
References	207

0. Introduction

This paper discusses a particular problem in the analysis of questions: the proper account of what we will call the 'functional' reading of questions. The analysis we will propose is a further refinement of an analysis of questions in the framework of Montague Grammar which we have presented elsewhere (see G & S 1981b, 1982). Although we will make use of that analysis at some points, the contents of this paper will pretty much stand on their own.

Our interest in the problem of functional readings of questions was raised by Elisabet Engdahl's discussion of it in her dissertation (Engdahl 1980). To our knowledge, she was the first to discuss this phenomenon in any detail.

The notion of connectedness, though not treated explicitly, comes in at several points. The connectedness of questions and answers is used as a heuristic means in the analysis of questions. This in its turn may eventually contribute to an account of the question-answer relationship itself, which can be regarded as one of the fundamental types of connected discourse. Furthermore, some of the constructions which we will discuss exhibit an interesting kind of binding pattern, being a form of connectedness at sentence level. Lastly, the phenomenon of functional readings is, we will argue, also to be observed with certain kinds of indicative sentences, as appears from the various ways in which such sentences can be continued in a larger discourse. Here connectedness at discourse level comes in again.

The particular problem we want to discuss in this paper concerns questions like (1) and (2) in connection with answers of type (a), (b) and (c):

- (1) Which woman does every man love?
- (a) Mary (individual answer)
 - (b) John loves Mary, Bill loves Suzy, ... (pair-list answer)
 - (c) His mother (functional answer)
- (2) Which of his relatives does every man love?
- (a) *Mary
 - (b) John loves (his wife) Mary, Bill loves (his sister) Suzy, ...
 - (c) His mother

With respect to these examples, two facts call our attention. First of all, a question like (1) allows for three different types of answers. The first type is an answer like (a), which specifies a particular individual that is the woman that is universally loved by the men. This we call an individual answer¹. The second type of answer is exemplified by (b): it gives a list of all pairs of men and women such that the man loves the woman. This we call a pair-list answer. Answers of the third type (c), finally, specify a function, in this case one which for every man x , when applied to x gives the woman x loves as value. Answers such as (c) are the ones we are interested in here. We will refer to them as functional answers. The main points to be discussed are whether functional answers are a separate type of answers, and if so how this can be accounted for in the analysis of questions.

The second fact concerning the examples given above that we want to point out is that a question like (2) allows for only two types of answers: pair-list answers such as (b) and functional ones such as (c). An individual answer like (a) is excluded². Question (2) differs from (1) in that the wh-term which of his relatives contains a pronoun, his, that seems to be bound by the term every man. Not in all cases, however, this binding relation is of the usual sort, as we shall see below.

Before turning to the main topic of this paper, an account of functional answers, we will first say a few words

about the difference between individual answers and pair-list answers.

1. Scope-ambiguities in questions

An obvious way to deal with the difference between individual answers and pair-list answers is to relate them to different readings of a question like (1). These readings can be accounted for in terms of a scope-ambiguity. The reading corresponding to the individual answer is the one in which the wh-term which woman has wide scope with respect to the quantified term every man. The reading corresponding to the pair-list answer is the one where every man has wide scope over which woman. These two readings of (1) can be paraphrased as (1a) and (1b) respectively:

(1a) Which woman is such that every man loves her?

(1b) For every man, which woman does he love?

If an account along these lines is to work, two conditions have to be fulfilled. First, wh-terms have to be treated as scope-bearing elements, just as normal quantified terms. Second, questions have to be derivable in (at least) two different ways.

In the analysis developed in G & S 1981b, 1982, these two conditions are fulfilled as far as wh-complements, i.e. indirect questions, are concerned. In the present paper we will assume that at least as far as the problems we want to discuss here are concerned, the semantics of indirect and direct questions is the same. Therefore, we feel free to analyse direct questions via their indirect counterparts. Our analysis is carried out within the framework of a modified Montague grammar. Syntactically the grammar is enriched with an account of constituent structure, more or less along the lines pointed out by Partee (see Partee 1973, 1979). As for the semantics, the usual logical language of intensional type theory is replaced by a language of two-

sorted type theory. In this language explicit reference to and quantification over indices is allowed. What necessitates this change of translation medium is explained in G & S 1982, section 6.2.

The main features of our syntactic analysis of constituent questions are the following. We start with a sentence with one or more free term variables PRO_n , PRO_k , ... Choosing one of these variables, say PRO_n , the sentence is transformed into a so-called *abstract* by 'preposing' a wh-term and replacing certain occurrences of PRO_n by a trace, and others, if any, by suitable anaphoric pronouns. What happens with an occurrence of PRO_n depends on its structural position in the original sentence. Next other wh-terms may be introduced, choosing other variables, by a similar process. After that, the abstract is transformed into a wh-complement by a category changing rule.

Semantically, we regard questions as proposition denoting expressions. Of particular importance is the index dependent character we ascribe to the denotation of questions. Which proposition a question denotes at an index depends on what is the case at that index. Loosely speaking, the proposition denoted by a question at some index is the true exhaustive answer to that question at that index.

Let us illustrate these general remarks by considering a concrete analysis tree plus translation of (the wh-complement corresponding to) question (1):⁴

(3)

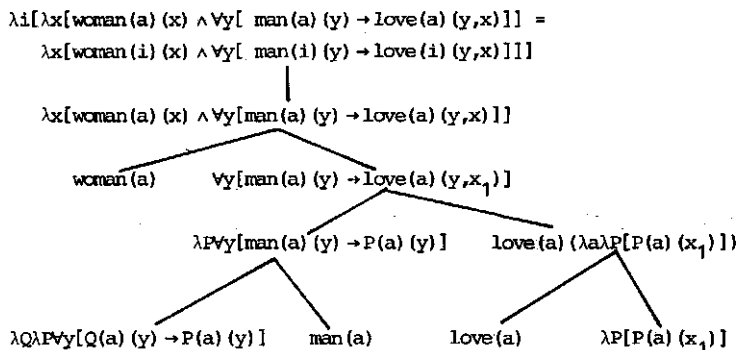
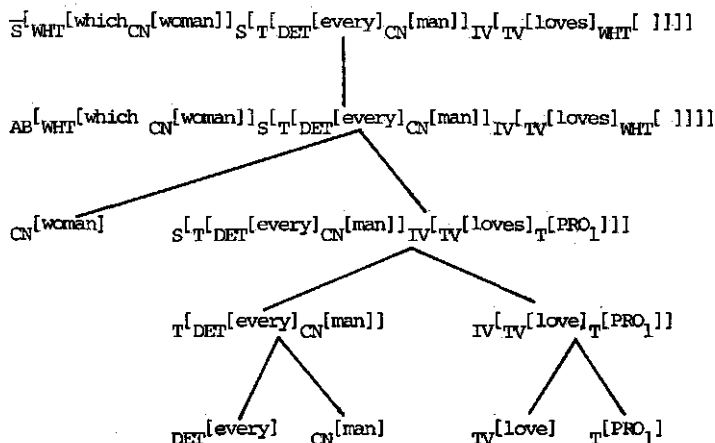

The abstract which woman every man loves is constructed from the common noun woman and the sentential structure every man loves PRO₁. In this process the wh-term which woman is formed and 'preposed'. The occurrence of PRO₁ is replaced by a wh-trace, i.e. an empty node labelled WHT. What semantically corresponds to this process of abstract formation is λ -abstraction over the free variable which occurs in the translation of the syntactic variable PRO₁. This makes

wh-terms scope-bearing elements. In the structure given above, the scope of which woman includes the universal quantifier in the translation of every man. The translation of the entire abstract denotes at an index i the set of women x such that for every man y at i , y loves x at i . The abstract is transformed into a proposition denoting complement. The distinction between abstracts and complements is not needed for syntactic purposes, but is semantically motivated. Since the distinction is not essential to the problems discussed in this paper, we will not motivate it here, but refer the reader to G & S 1982. The complement which woman every man loves denotes at an index a the proposition which holds at precisely those indices i in which the set of women who are loved by every man is the same as at a . If at an index a Mary is the only woman whom is universally loved by the men, then the complement denotes at a the proposition that Mary, and only Mary, is loved by every man. In that situation, the answer Mary would be the 'true, complete answer' to question (1). On this reading the question can be answered by what we have called an individual answer. We therefore call this reading of question (1) its *individual reading*.

So, the first condition for questions to exhibit a scope ambiguity, i.e. that wh-terms have scope, is fulfilled. The second condition was that there be two ways to construct questions, that there be two derivations for them. This requirement is an immediate consequence of the central methodological principle of Montague grammar (and logical grammar in general): the principle of semantic compositionality. This principle says that the meaning of an expression is a function of the meanings of its parts and the way in which these parts are put together. In other words, the meaning of an expression is a function of the meaning of its parts and the way in which it is derived. Save for cases of lexical ambiguity, the principle of semantic compositionality therefore requires: different meanings, different derivations. If an expression is ambiguous between n readings, there have to be (at least) n different ways to derive it.

As we have indicated above, the derivation of question (1) given in (3) is the one which gives the reading that corresponds to individual type answers. It is the reading we paraphrased as (1a):

(1a) Which woman is such that every man loves her?

The proposition denoted by (1) on this derivation specifies women who are universally loved by the men. It remains to be shown that we can create another way to derive questions which gives the type of reading that corresponds to the pair-list type answers. As we have already remarked above, the obvious way to do this is to allow wh-terms and other terms to have different scope with respect to one another.

The usual way to create a scope ambiguity in Montague grammar is illustrated by the two derivations plus translations of the sentence every man loves a woman given in (4) and (5):⁵

(4) $S_T[\text{every man}]_{IV}[\text{TV}[\text{loves}]_T[\text{a woman}]]$

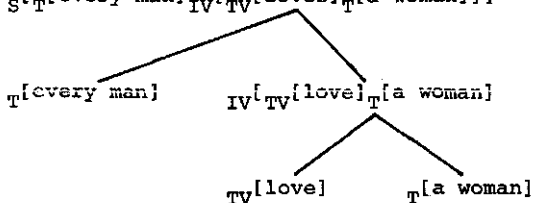

$\forall x[\text{man}(a)(x) \rightarrow \exists y[\text{woman}(a)(y) \wedge \text{love}(a)(x,y)]]$

$\lambda P \forall x[\text{man}(a)(x) \rightarrow P(a)(x)]$

$\text{love}(a)[\lambda a \lambda P \exists y[\text{woman}(a)(y) \wedge P(a)(y)]]$

$\text{love}(a)$

$\lambda P \exists y[\text{woman}(a)(y) \wedge P(a)(y)]$

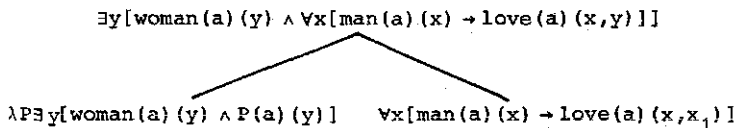
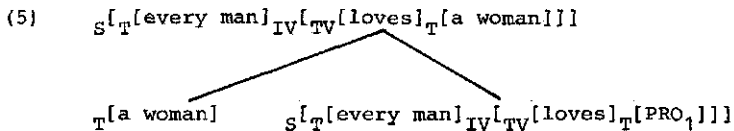

The derivation in (4) results in the so-called 'direct' reading, in which every man has wide scope over a woman. The 'indirect' reading, in which a woman has widest scope, is obtained by quantifying in the term a woman into the sentence every man loves PRO_1 . This derivation is given in (5). Notice by the way that both derivations assign one and the same constituent structure to the sentence in question. Derivational ambiguities do not necessarily result in structural ambiguities, i.e. in different constituent structures.

The same kind of procedure can be followed in the case of questions. In (6) a second way to derive question (1) is given, in which the term every man is quantified into the complement which woman PRO_1 loves:⁶

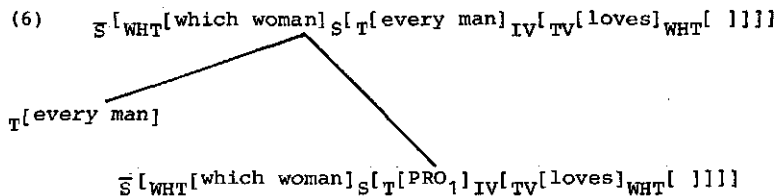

$$\lambda i[\forall y[man(a)(y) \rightarrow [\lambda x[woman(a)(x) \wedge love(a)(y,x)] = \lambda x[woman(i)(x) \wedge love(i)(y,x)]]]]$$

$$\lambda P \forall y[man(a)(y) \rightarrow P(a)(y)] \cdot \lambda i[\lambda x[woman(a)(x) \wedge love(a)(x_1,x)] = \lambda x[woman(i)(x) \wedge love(i)(x_1,x)]]$$

As is evident from the corresponding translation, the derivation process exemplified in (6) results in a reading of question (1) in which the term every man has wide scope over the wh-term which woman. The proposition denoted at an index a by the complement thus constructed, is the set of indices i such that for every man y at a it holds that the set of women that y loves at i is the same as the set of women y loves at a . Clearly, on this derivation, question (1) receives the reading paraphrased as (1b) above:

(1b) For every man, which woman does he love?

Such a question is answered by specifying for every man the woman (or women) he loves, i.e. by giving a list of pairs of men and women such that the man loves the woman. So, on this second reading question (1) is answered by what we have called a pair-list answer, hence this reading is called the *pair-list reading*.

Summing up our results, we conclude that individual answers and pair-list answers correspond to different readings of questions. These different readings stem from a scope ambiguity: wh-terms and normal quantified terms may stand in different scope relations to one another. Within the framework of Montague grammar it is possible to account for this ambiguity since wh-terms can be treated semantically as scope-bearing elements and since the usual 'quantifying in' device for handling scope ambiguities can be extended to questions.

Finally let us point out that the account just given of the ambiguity of questions between an individual and a pair-list reading enables one to explain why there is no individual reading for question (2):⁷

(2) Which of his relatives does every man love?

This question cannot be answered by specifying an individual, as in the individual answer Mary, thus (2) lacks what we have

called the individual reading. The reason for this is the following. In Montague grammar the standard way to deal with anaphoric pronouns is also by means of quantification rules. Sentence (7), for example, is derived by quantifying in the term every man in the sentence PRO₁ loves PRO₁'s mother:

(7) Every man loves his mother

In the quantification process one of the occurrences of the syntactic variable which is quantified is replaced by the term which is quantified in, while any other occurrences become suitable anaphoric pronouns. Semantically, they turn up as bound variables. If the grammar is enriched with an account of constituent structure, various structural conditions may be formulated which govern this process (for a theory along these lines, see Landman & Moerdijk 1981, 1983).

As for question (2), it seems that in order to get an anaphoric pronoun his in the wh-term which of his relatives, the term every man should have wide scope. I.e. it has to be quantified in into the question which of PRO₁'s relatives PRO₁ loves. But, as we have seen with regard to question (1), this would result in a pair-list reading. So, there is no way to derive (2) with his bound by every man which assigns it an individual reading. And this accounts for the impossibility of individual answers such as Mary to questions such as (2).

2. Functional readings of questions

We now turn to the third type of answers to questions which we distinguished: functional answers. With many others, we believed for a long time that answers like his mother to questions like (1) and (2) are just a kind of abbreviation, a more economic way of expressing pair-list answers.⁸ For suppose that things are as in the situation depicted in figure 1:

son mother

John → Mary

Bill → Suzy

Peter → Jane

(fig. 1)

The arrow represents the love-relation. In this situation, the question Which woman does every man love? or Which of his relatives does every man love? can be answered by means of a pair-list answer as well as by means of a functional answer. The pair-list answer would be (8), the functional answer would be (9):

- (8) John loves Mary, Bill loves Suzy and Peter loves Jane
 (9) Every man loves his mother

Both answers cover the situation in question. This is not surprising, of course, for extensionally a function is just a list of pairs. So, if one answers the question by (9) instead of by (8), this seems to be merely for reasons of convenience. If the list of pairs gets longer, abbreviating the list by means of a function becomes more attractive. But that would be a fact of language use, not one of semantics. Both a pair-list answer and a functional answer would express the same complete true answer. And as far as the semantics of questions is concerned, there would be no reason to distinguish between the two.

But can functional answers and pair-list ones really always be equated? There seem to be several reasons to doubt this.

First of all, someone may know the answer His mother to the question Which woman does every man love? without being

In this new situation, the complete pair-list answer to the question Which woman does every man love? has to be extended with the pair <Bill, Mary>:

- (10) John loves Mary, Bill loves Mary and Suzy, and
Peter loves Jane

Since Mary is not Bill's mother (Suzy is), the extension of the function his mother is no longer identical with the list of pairs that constitutes a complete pair-list answer. Still it seems that if someone asks the question Which woman does every man love?, the functional answer His mother, in this situation too, may constitute a fully satisfactory and complete answer. If this is true (as we think it is) it means that the question can be understood in different ways. Sometimes we use it to ask for a functional answer, and sometimes it serves to elicit a pair-list answer. If we use it in the first way in the situation described by figure 2, the functional answer His mother is the true complete answer. If we use it in the second way, the pair-list answer (10) is the true complete answer. Since the two are not equivalent, it follows that the question should have two non-equivalent readings corresponding to these two different kinds of answers. The functional answer cannot be regarded systematically as a mere abbreviation of the pair-list answer.¹⁰

If a question at an index a denotes the proposition to be expressed by what at a is a complete and true answer to it, and if there are two non-equivalent but equally satisfactory complete and true answers, then the conclusion must be that the question is ambiguous.

Perhaps the strongest arguments for distinguishing a separate functional reading of questions stem from examples such as (11)-(16):

- (11) Which woman does no man love?
(a) Mary
(b) *John loves Mary, Bill loves Suzy, ...
(c) His mother

- (12) Which of his relatives does no man love?
 (a) *Mary
 (b) *John loves Mary, Bill loves Suzy, ...
 (c) His mother
- (13) Which woman do few men love?
 (a) Mary
 (b) *John loves Mary, Bill loves Suzy, ...
 (c) Their mother
- (14) Which woman do many men love?
 (a) Mary
 (b) *John loves Mary, Bill loves Suzy, ...
 (c) Their mother
- (15) Which of their relatives do few men love?
 (a) *Mary
 (b) *John loves Mary, Bill loves Suzy, ...
 (c) Their mother
- (16) Which of their relatives do many men love?
 (a) *Mary
 (b) *John loves Mary, Bill loves Suzy, ...
 (c) Their mother

These questions differ from questions (1) and (2) in that they do not allow pair-list answers, where (1) and (2) do. Pair-list answers to these questions simply do not make sense.¹¹ This does not only hold for terms with the determiners no, few or many as in the examples above, it holds for many others besides. They are listed in the second column in figure 3:¹²

<i>universal terms</i>	<i>non-universal terms</i>
every man	no man
all men	any man
the man	few men
the men	many men
the two men	two men
both men	neither man
each man	a man
John	some man
John and Peter	some men
	most men
	at least one man
	at most one man
	exactly one man

(fig. 3)

If functional answers would be just alternative, more concise ways of expressing pair-list answers, it would be hard to explain why questions such as (11)-(16) can be answered in a functional way, but do not permit a pair-list answer. To prevent pair-list answers to them, we have to exclude their pair-list reading. But then, no reading is available to which the functional answers would correspond if the two were identified. This shows that we need to distinguish functional from pair-list answers, and hence to postulate a separate functional reading for questions.

Why is it impossible to answer these questions by giving a list? Intuitively, the reason seems to be the following. If we are to be able to give a list, the term in question has to be associated with a definite set, otherwise we would not know what to make a list of. If we are asked to give a list of pairs of men and women such that the man loves the woman, we are only able to do this if we can pick the men from a definite set. With a question like Which woman does every man love? it is clear what we should do, the definite set is the set of every man. And the same holds for e.g. Which woman

do the two men love? In this case the set consists of the two men, identified or specified either by the non-linguistic context or by previous discourse. Things are completely different with a question like Which woman do few men love? There isn't any definite set of few men from which we can construct our list. And hence it is impossible to answer such a question by means of a pair-list answer.

In our analysis, the fact that questions with non-universal subject terms do not have a pair-list reading is mirrored by the fact that quantification of non-universal terms into questions is ruled out.¹³ In order to derive questions with pair-list readings we need to quantify terms into questions. If we would apply this procedure in case of non-universal terms, we would wind up with completely wrong results. For example, quantifying in no man into which woman PRO₁ loves would result in the following translation, which does not represent a meaning of the question which woman no man loves:

$$(17) \lambda i[\forall y[\text{man}(a)(y) \rightarrow \neg[\lambda x[\text{woman}(a)(x) \wedge \text{love}(a)(y,x)] = \lambda x[\text{woman}(i)(x) \wedge \text{love}(i)(y,x)]]]]]$$

At an index *a* this expression denotes the set indices *i* such that for no man *x* at *a* the set of women whom he loves at *i* is the same as the set of women he loves at *a*. For no man this proposition entails the proposition which identifies the woman (or women) he loves.

The explanation given above of why pair-list answers are not possible with questions like (11)-(16) seems reasonable enough. Since functional answers are possible, however, this constitutes a conclusive argument against the equation of functional answers with pair-list answers.

Where does all this leave us? We seem to be forced to distinguish, quite generally, three different readings for questions. In some cases some readings are excluded, for reasons which we have indicated. The individual reading of questions, i.e. the reading which gives rise to the individual type answers, corresponds to direct construction,

exemplified in (3) above. The pair-list reading is the result of quantifying in. This construction is exemplified in (6). It is restricted to universal terms. At first sight the functional reading appeared to be a simple variant of the pair-list reading, but as we have argued above, it is not. This means that the functional reading cannot be derived by the quantifying-in process. On the other hand, though akin to it in some respect, the functional reading obviously is not equivalent to the individual reading either. Following the methodological principle of compositionality, we postulate a third way to derive questions.

At this point an interesting phenomenon can be observed. As we said, the functional reading cannot be obtained by quantifying in since the *wh*-term has to have wide scope over the subject term, so, semantically the subject term cannot bind anything inside the *wh*-term. Syntactically, however, in such questions as (2), (12), (15) and (16), the subject term, in some way or other, has to bind the pronoun in the *wh*-term. Here semantic and syntactic binding are not parallel in the way they usually are, a fact that hitherto seems to have escaped attention.

3. Functional readings and Skolem-functions

In this section we will sketch our solution to the problem of functional readings of questions. In section 4 we will indicate some further uses of the apparatus in similar problematic cases.

Questions like (2) and (12) are discussed extensively by Elisabet Engdahl (Engdahl 1980). She does not discuss functional readings of questions such as (1), (11), (13)-(16). Her proposal for the analysis of the functional readings of (2) and (12) is not fully satisfactory, and moreover is not general enough to deal with the other cases.¹⁴

As for our own solution, since our framework is one in which we want to give an explicit model-theoretic semantics

for natural language, there are two things which we will have to do. First of all, we will have to indicate what the interpretation of questions on their functional reading is. Secondly, if we have succeeded in this, we will have to provide explicit syntactic and semantic rules which, building up the interpretation of the whole from the interpretation of the parts, give us the required results.

Our proposal is to use so-called *Skolem-functions* in the analysis of functional readings of questions. Let us consider the simple question (18) in connection with the functional answer (c):

- (18) Whom does every man love?
 (c) His mother

The answer His mother specifies a function from individuals to individuals. When applied to an individual, say John, it gives the mother of that individual, say Mary, as its value. What answer (c) expresses is that this function, call it f , is such that for every man x when f is applied to x it gives as value an individual that x loves. So, on its functional reading question (18) asks which function f is such that for every man x , x loves $f(x)$.

This suggests the following translation (19) for (18) on its functional reading. For comparison we add the translation (20) of the individual reading of (18):¹⁵

- (19) $\lambda f[\forall x[\text{man}(a)(x) \rightarrow \text{love}(a)(x, f(x))]]$
 (20) $\lambda y[\forall x[\text{man}(a)(x) \rightarrow \text{love}(a)(x, y)]]$

Functions from individuals to individuals like f used above, are called Skolem-functions. They can be used to change the order of quantifiers in a formula like $\forall x\exists y\phi(x, y)$ in order to obtain an equivalent formula $\exists f\forall x\phi(x, f(x))$. In order to illustrate this, look at the picture in figure 4:¹⁶

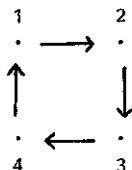

(fig. 4)

In the situation depicted in figure 4 it holds that $\forall x \exists y x \rightarrow y$ and also that $\exists f \forall x x \rightarrow f(x)$, viz. the following function :

$$(21) \quad g(1) = 2, \quad g(2) = 3, \quad g(3) = 4, \quad g(4) = 1$$

Of course, there may be more such functions as in the situation depicted in figure 5:

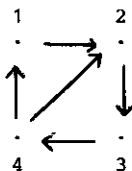

(fig. 5)

In this situation there are two functions that make $\exists f \forall x x \rightarrow f(x)$ true, viz. g and h :

$$(22) \quad h(1) = 2, \quad h(2) = 3, \quad h(3) = 4, \quad h(4) = 2$$

Question (1) on its functional reading asks not for any function such that for every man x , x loves $f(x)$, but for a function which always yields a woman as its value:

(1) Which woman does every man love?

- (c) His mother
- (c') *His father

Whereas question (18) can be answered functionally with His father, this answer is not possible for question (1), since the father-function is not a function into the set of women. So, a question like (1) restricts the set of possible functions that may constitute an answer to it on its functional reading. In the case of (1) this restriction on admissible functions f can be formulated as: $\forall x \text{ woman}(a)(f(x))$. As a whole, (1) may be translated into (23). For comparison we give again the translation of (1) on its individual reading as (24).

(23) $\lambda f[\forall x \text{ woman}(a)(f(x)) \wedge \forall x[\text{man}(a)(x) \rightarrow \text{love}(a)(x, f(x))]]$

(24) $\lambda y[\text{woman}(a)(y) \wedge \forall x[\text{man}(a)(x) \rightarrow \text{love}(a)(x, y)]]$

The most interesting case is a question like (2):

(2) Which of his relatives does every man love?

(c) His mother

(c') *His first grade teacher

This question too formulates a restriction on the functions that can be specified as answers to it. Here the restriction can be formulated as: $\forall x \text{ relative-of}(a)(f(x), x)$. The functional reading of (2) can then be represented as (25):

(25) $\lambda f[\forall x \text{ relative-of}(a)(f(x), x) \wedge \forall x[\text{man}(a)(x) \rightarrow \text{love}(a)(x, f(x))]]$

It is clear that thus interpreted (c) constitutes an acceptable answer to (2), but (c') does not. Notice that the variable x in $\text{relative-of}(a)(f(x), x)$, which corresponds to the pronoun his in the wh-term which of his relatives is not bound by the universal quantifier in the translation of every man. Rather, it is bound by the universal quantifier in the restriction on the function. Still, the effect is as if it is bound by every man since for every choice of a man x , $f(x)$ is a relative of x . This is the result of restricting f in such a way that when applied to an individual it gives a

relative of that individual as its value. So, although we can say that the pronoun his in the wh-term is 'bound' in a certain sense by the term every man, it is not connected with it in the usual direct way of being translated as a variable which is bound by the quantifier in the translation of the term. Rather, the pronoun depends on the term indirectly, via the dependency of the Skolem-function and the way in which it is restricted. In constructions like these, the pronoun is neither a variable bound by a term, nor is it a pronoun of laziness or a discourse anaphor. Rather it signals a separate kind of dependency, a functional dependency. This is a rather unusual kind of semantic binding which allows us to account for a semantic relation between two terms which, in a sense, is the reverse of their syntactic relation.

As a last example, consider question (12), a question with a non-universal subject term. Such questions do not allow pair-list answers but they do have a functional reading. In (26) the functional reading of (12) is represented:

(12) Which of his relatives does no man love?

(26) $\lambda f[\forall x \text{ relative-of}(a)(f(x),x) \wedge$
 $\forall x[\text{man}(a)(x) \rightarrow \neg \text{love}(a)(x,f(x))]]$

The expression in (26) denotes the set of functions f such that for every x , $f(x)$ is a relative of x , and for no man x it holds that x loves $f(x)$. Answering (12) on this reading by a functional answer like His mother is specifying one of those functions, and expresses that no man loves his mother. For other questions with non-universal subject terms, the functional reading can be represented in a similar fashion.

What we have ended up with now are formulas that correctly represent the interpretations of questions on their functional readings. But as we said earlier, this constitutes only half of the job. Writing down a formula that represents the meaning of a sentence is one thing, finding a compositional translation procedure which results in this formula, or in one that is equivalent to it, is quite another. (For example, it is no problem to write down

formulas which represent the meaning of Bach-Peters sentences or donkey-sentences. What is difficult is to construct a compositional procedure that produces them.)

We cannot deal here with the syntax of wh-constructions in detail. For our analysis the reader is referred to G & S 1982, section 4. We will restrict ourselves to giving an informal indication of the contents of the relevant syntactic rules, by discussing some examples. What is important is that to these syntactic rules compositional translation rules correspond, thus providing a compositional semantics for the expressions produced.

Consider to begin with the derivation tree (27), which gives the functional reading of question (1), and compare it with (3), the derivation tree which resulted in the individual reading of (1):

(27) AB^{[WHT[which woman]]}S^{[T[every man]]}IV^{[TV[loves]]}WHT^[]]

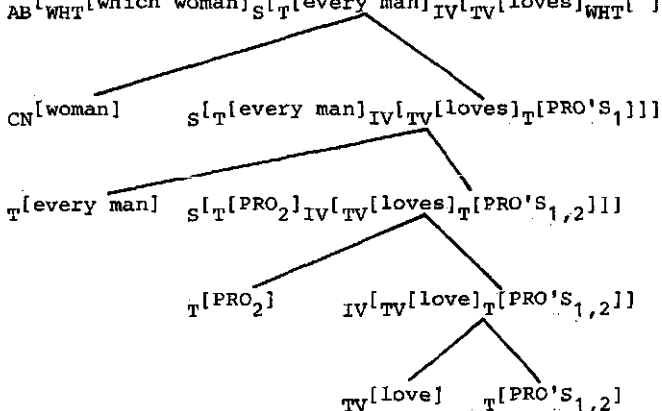

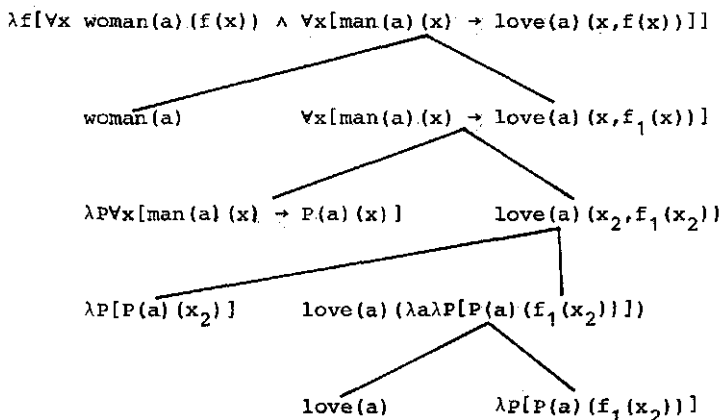

In order to obtain the functional reading, a new kind of syntactic variable of category T is introduced.¹⁷ It is a double-indexed variable of the form $\text{PRO}'S_{m,n}$. The two indices m and n of these syntactic variables correspond to the indices of the two free variables f_m and x_n in their translation, which is given in (28):

$$(28) \text{PRO}'S_{m,n} \sim \lambda P[P(a)(f_m(x_n))]$$

Here ' \sim ' is to be read as 'translates into'. P is a variable of type $\langle s, \langle e, t \rangle \rangle$, w of type s , f_m of type $\langle e, e \rangle$ and x_n of type e . The translation $\lambda P[P(a)(f_m(x_n))]$ denotes at a the set of properties P which the individual $f_m(x_n)$, the value of f_m for x_n , has at a .

The new syntactic variables behave like all other expressions of category T. So we can form the sentence (29):

$$(29) S_T[\text{PRO}'_2]_{\text{IV}}[\text{TV}[\text{loves}]_T[\text{PRO}'S_{1,2}]]$$

in the usual way. Into this sentence we can quantify every man for variables carrying index 2. The existing quantification rule has to be adapted slightly in view of the possible occurrences of this new kind of syntactic variable. What is important is that features for number and

gender of the term that is quantified in are taken over by all those occurrences of variables with the relevant index that are not replaced by the term itself. Thus, quantifying in every man into (29) for PRO_2 results in (30):

$$(30) S^I_T[\text{every man}]_{IV}^I_{TV}[\text{loves}]_T[PRO'S_1]]$$

in which $PRO'S_1$ carries the features male, singular, third person, because it is bound by the male, singular, third person term every man. The translation rule corresponding to the modified quantification rule remains unaltered. Syntactically, quantifying in removes the second index on a variable $PRO'S_{m,n}$, semantically it binds the variable x_n , ranging over individuals, by the translation of the term which is quantified in.

From sentence (30) and the common noun woman an abstract is formed. If we compare this stage of the derivation of the functional reading with the corresponding stage of the derivation of the individual reading, we notice that syntactically the difference is minimal. Where the former has an occurrence of a syntactic variable $PRO'S_k$ in its input sentence, the latter has an occurrence of PRO_k . The resulting abstracts are in both derivations the same:

$$(31) AB^I_{WHT}[\text{which woman}]_S^I_T[\text{every man}]_{IV}^I_{TV}[\text{loves}]_{WHT}^I \text{ III}$$

They are formed by the same syntactic process. Informally, the relevant syntactic rules read as follows.

On the individual reading the abstract is derived by means of (S:AB2):

(S:AB2) If δ is a CN and ϕ is an S containing one or more occurrences of PRO_n which satisfy certain structural constraints, then $F_{AB2,n}(\delta, \phi)$ is an AB of the form $AB^I_{WHT}[\text{which } \delta] \phi'$, where ϕ' comes from ϕ by replacing certain of the occurrences of PRO_n by traces and all the others

by anaphoric pronouns which take over the features for gender and number from the CN δ

The translation rule corresponding to (S:AB2) is (T:AB2):

(T:AB2) If $\delta \sim \delta'$ and $\phi \sim \phi'$, then
 $F_{AB2,n}(\delta, \phi) \sim \lambda x_n [\delta'(x_n) \wedge \phi']$

On the functional reading the abstract is derived by means of a quite similar syntactic rule (S:AB2/f):

(S:AB2/f) If δ is a CN and ϕ is an S containing one or more occurrences of $PRO'S_n$ which satisfy certain structural constraints, then $F_{AB2/f,n}(\delta, \phi)$ is an AB of the form $AB^{[WHT]}$ [which δ] ϕ' , where ϕ' comes from ϕ by replacing certain of the occurrences of $PRO'S_n$ by traces and all others by anaphoric pronouns which take over the features for gender and number from the CN δ

The corresponding translation rule is (T:AB2/f):

(T:AB2/f) If $\delta \sim \delta'$ and $\phi \sim \phi'$, then
 $F_{AB2/f,n}(\delta, \phi) \sim \lambda f_n [\forall x \delta(f_n(x)) \wedge \phi']$

On its individual reading the abstract underlying which woman every man loves denotes the set of individuals y such that y is a woman and for every man x it holds that x loves y . On its functional reading the abstract denotes the set of functions f from individuals to individuals such that f is a function into the set of women and for every man x it holds that x loves $f(x)$. So, on the individual reading the common noun woman in the wh-term which woman functions as a restriction on individuals, on the functional reading it acts as a restriction on Skolem-functions.

As a second example, consider the derivation tree plus

translation of the functional reading of question (2), which of his relatives does every man love?:¹⁸

(32)

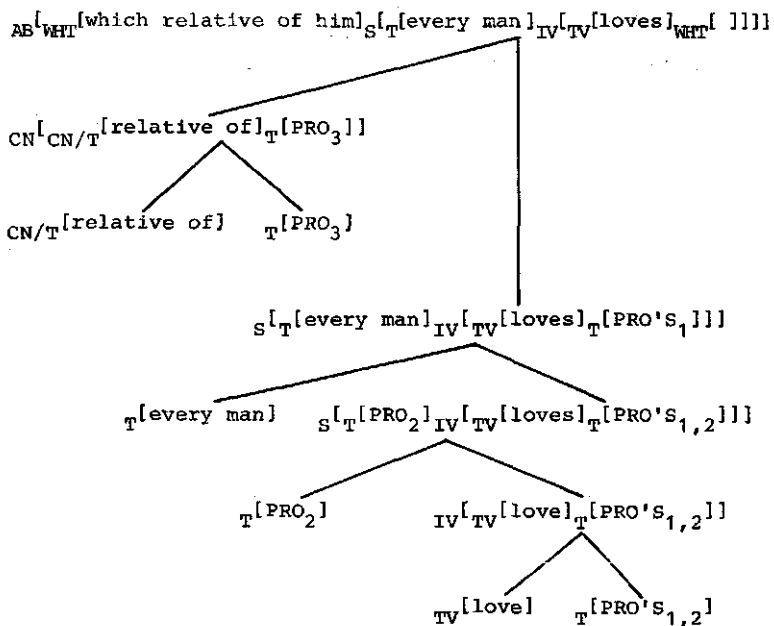

$$\lambda f[\forall x \text{ relative-of}(a)(f(x), x) \wedge \forall x[\text{man}(a)(x) \rightarrow \text{love}(a)(x, f(x))]]$$

$$\text{relative-of}(a)(\lambda a \lambda P[P(a)(x_2)])$$

$$\text{relative-of}(a) \quad \lambda P[P(a)(x_2)]$$

$$\forall x[\text{man}(a)(x) \rightarrow \text{love}(a)(x, f_1(x))]$$

$$\lambda P \forall x[\text{man}(a)(x) \rightarrow P(a)(x)] \quad \text{love}(a)(x_2, f_1(x_2))$$

$$\lambda P[P(a)(x_2)] \quad \text{love}(a)(\lambda a \lambda P[P(a)(f_1(x_2))])$$

$$\text{love}(a) \quad \lambda P[P(a)(f_1(x_2))]$$

The new element in this derivation is that in forming the abstract from the sentence a common noun is used which itself contains a free syntactic variable which gets bound in the process of abstract formation. In deriving the abstract which relative of him every man loves from the common noun relative of PRO₃ and the sentence every man loves PRO'S₁, two variables get bound: the functional variable in PRO'S₁ in the S and the individual variable in PRO₃ in the CN. The syntactic rule which does this can informally be stated as follows:

- (S:AB5) If δ is a CN with one or more occurrences of PRO_n and ϕ is an S with one or more occurrences of PRO'S_m which satisfy certain structural constraints, then $F_{AB5, n, m}(\delta, \phi)$ is an AB of the form $AB^{[WHT]}$ [which δ'] ϕ'], where δ' comes from δ by replacing the occurrences of PRO_n by

anaphoric pronouns which take over the features for gender and number from $PRO'S_m$, and where ϕ' comes from ϕ as in (S:AB2/f)

The syntactic process codified in this rule is quite like that described in the previous two rules of abstract formation (S:AB2) and (S:AB2/f). The only difference lies in the fact that in addition the syntactic variable PRO_n in the CN is bound and takes over the features for number and gender from the variable $PRO'S_m$ in the S, and thereby indirectly from the term by which the latter variable in its turn is partly bound. This syntactic binding process is not paralleled by the normal semantic binding process. Although syntactically every man binds him in which relative of him, semantically the variable in the translation of him is not inside the scope of the quantifier in the translation of every man.¹⁹ Rather it is bound in the translation of the restriction which the wh-term places on the functions. This is expressed in the translation rule corresponding to (S:AB5):

(T:AB5) If $\delta \sim \delta'$ and $\phi \sim \phi'$, then
 $F_{AB5,n,m}(\delta, \phi) \sim \lambda f_m [\forall x_n \delta'(f_m(x_n)) \wedge \phi']$

Of course this description of the derivation process of functional readings of questions gives a mere indication of what a detailed syntactic analysis would look like. This is true in particular for the remarks on how morphological features function in this process. However, we are confident that such a detailed analysis can be carried out, on the basis of the syntax of wh-constructions defined in G & S 1982 and a theory of morphology as proposed in Landman & Moerdijk 1981, 1984.

More important in the context of the present paper is that our remarks have shown (and not merely indicated) that it is indeed possible to give a compositional semantics for questions which accounts for individual, pair-list and functional readings. This is shown by the compositional

translation rules defined above. In fact it is the methodological principle of semantic compositionality that more or less directly leads to an analysis like the one just outlined. If one accepts compositionality as a requirement on one's grammar, one is bound to associate a derivational ambiguity with every non-lexical semantic ambiguity.

At this point it may be useful to stress again the difference between derivation and constituent structure. Constituent structure is what we have intuitions about, intuitions which may take the form of well-formedness judgements and which can be elicited by means of various kinds of tests. Constituent structure embodies our intuitions about what the parts of an expression are, how they combine into larger parts, how they depend on one and another, etc. But as to how these constituent structures are derived, we do not have any intuitions at all. The derivational process is not directly linked with syntactic intuitions. The analysis of questions given in this paper illustrates this. The various types of derivations which we distinguished, for example the three derivations (3), (6) and (27) of question (1), are of course primarily semantically motivated. This is also evident from the fact that all of them assign the same constituent structure to the question. Quite generally, one may say that within the framework of Montague grammar the theory of syntactic structure is embodied, not in the derivations, but in the constituent structures which the grammar assigns to the expressions it produces.

One may perhaps object against the semantically motivated level of derivations in the syntax, feeling that syntax should deal with syntactic properties of expressions only. But then one has to give up the compositionality requirement. For given the fact that constituent structure as such does not determine semantic interpretation, any grammar that is set up to give a compositional semantics for the expressions it produces, will have to contain some level of analysis which is primarily semantically motivated, a level which contains in addition to the information which the constituent structure of an expression provides all other

aspects which are needed to fix its semantic interpretation. One may very well argue about the precise contents of the level of analysis and its exact place in the grammar. One may prefer storage mechanisms (cf. footnote 17) or interpretation strategies over derivations, but given the common goal of logical grammar, a compositional semantics for natural language, a level of analysis like that of derivations has to be incorporated in the grammar, some way, somewhere.²⁰

4. Functional readings of other constructions

In this section we will point out briefly other types of constructions than questions where functional readings seem to play a role.

Consider sentence (33):

(33) Every man loves a woman

A sentence such as (33) can be continued in a larger discourse in (at least) three different ways. These continuations are remarkably like the three ways in which the question Which woman does every man love? can be understood:

- (33) (a) Mary
 (b) John loves Mary, Bill loves Suzy, ...
 (c) His mother

We call them the *individual continuation*, the *pair-list continuation* and the *functional continuation* accordingly. Sentence (33) is generally assumed to have two readings. The individual continuation would match the reading of (33) which is the result of constructing it indirectly, i.e. by quantifying in a woman (see (5)), which consequently gets wide scope:

(34) $\exists y[\text{woman}(a)(y) \wedge \forall x[\text{man}(a)(x) \rightarrow \text{love}(a)(x,y)]]$

So, the individual continuation (33) (a), Mary, is to be regarded as a specification of an individual that is loved by every man, that is said to exist by (33) on its reading (34). The other reading of (33) is of course the one which results from the direct construction (see(4)):

(35) $\forall x[\text{man}(a)(x) \rightarrow \exists y[\text{woman}(a)(y) \wedge \text{love}(a)(x,y)]]$

At first sight nothing speaks against taking both the pair-list continuation (33) (b) and the functional continuation (33) (c) as matching this reading of (33). In (35) it is expressed that for all men there is a woman whom he loves. This fact may well be specified either by giving a list of pairs, as in (33) (b), or by giving a function, as in (33) (c). On this view the functional continuation would be a convenient abbreviation of a pair-list continuation.

But now consider sentence (36):

(36) There is a woman whom every man loves

This sentence can be continued in two ways only, individually and functionally:

(36) (a) Mary

(b) *John loves Mary, Bill loves Suzy, ...

(c) His mother

A pair-list continuation does not result in a well-formed, interpretable discourse. Two facts call our attention. First of all, with respect to (33) the suggestion was to take the functional continuation as a mere abbreviation of a pair-list continuation. This strategy will not work, however, in case of (36), since in this case the pair-list continuation is not possible while the functional continuation is. Secondly, a sentence such as (36) is often regarded (and offered) as a disambiguation of a sentence like (33). (36) is considered to have only one reading, being the indirect reading (34) of

(33), in which a woman has wide scope over every man. This is in accordance with the fact that an individual continuation is possible for (36). But it conflicts with the previously mentioned suggestion that the functional continuation of (33) corresponds to its direct reading (35). For this leaves us at a loss as to how to account for the functional continuation of (36).

A possible solution is to assign to (36) a second, 'functional' reading of which (36)(c) is the functional continuation. This reading may be represented as follows:

$$(37) \exists f[\forall x \text{ woman}(a)(f(x)) \wedge \forall x[\text{man}(a)(x) \rightarrow \text{love}(a)(x,f(x))]]$$

So, (36) can also be read as asserting that there is a function f into the set of women such that for every man x it holds that x loves $f(x)$. The functional continuation (36)(c) specifies this function as the mother-function, much in the same way as the individual continuation (36)(a) specifies the woman that is universally loved among the men, that is asserted to exist by (36) on its reading (34), as the individual Mary.

But here a problem presents itself, for (37) is equivalent to (35). And (35) intuitively does not represent a reading of (36), an intuition which is supported by the fact that it is (35) that makes the pair-list continuation possible for (33), a type of continuation which does not exist in connection with (36). So, postulating reading (37) for (36) in order to account for the possible functional continuation (36)(c), seems to allow the impossible pair-list continuation (36)(b) as well.

A formally correct and intuitively appealing solution to this problem is to restrict the domain of the quantifier $\exists f$ in (37) to some subset of the totality of all Skolem-functions. If we do this, (37) is no longer equivalent to (35) and we have a representation of (36) which accounts for the functional continuation without allowing the pair-list one. This seems a quite reasonable move to make, for if one asks for the specification of a function (with a question on its

functional reading), or asserts the existence of a function and gives a specification of it, one obviously is not satisfied with any old specification of any old weird functional relationship between individuals. If someone asserts that there is some function f such that for all x , x loves $f(x)$, and on our demand to specify this function, starts listing all pairs $\langle x, y \rangle$ such that x loves y , this simply will not do. Somehow quantification over functions is restricted. It would seem that functions that are allowed, must be either conventional in some sense (such as the mother-function, the wife-function, etc.) and thus in some sense computable, or they must be made computable by the context. Compositions of such acceptable functions will in most cases result in acceptable functions. The exact principle, or principles, underlying this restriction are not entirely clear to us, but that something like this is going on seems quite likely.

Assuming that quantification over Skolem-functions is indeed restricted, we can not only explain that (36) has a functional reading but not a pair-list reading, it also becomes reasonable to consider (33) to be 3-ways ambiguous. The third reading of (33) will be the same as the second, functional reading of (36), reformulated as (37'):

$$(37') \exists f [R(f) \wedge \forall x \text{ woman } (a) (f(x)) \wedge \forall x [\text{man } (a) (x) \rightarrow \text{love}(a) (f(x))]]$$

Here R is to be filled by some predicate over Skolem-functions which expresses the restriction to 'conventional', 'computable' functions.

Another sentence that illustrates the usefulness of distinguishing functional readings from pair-list readings is (38):

(38) There is a woman whom no man loves

Like (36) this sentence has a functional continuation, but no pair-list continuation. The functional reading of (38) is represented by (39):²¹

(39) $\exists f[R(f) \wedge \forall x \text{ woman}(a)(f(x)) \wedge \forall x[\text{man}(a)(x) \rightarrow \neg \text{Love}(a)(x, f(x))]]$

Finally, it may be noted that the special binding properties we found in questions like:

(2) Which of his relatives does every man love?

occur also in certain indicative sentences. An example is (40):

(40) Every man loves one of his relatives

This sentence does not have a reading in which the term one of his relatives is quantified in, for then the pronoun his could not be bound by every man. This appears also from the fact that (40) does not allow an individual continuation, it cannot be continued by specifying an individual. The sentence has a pair-list continuation which corresponds to the reading which results from quantifying in every man in PRO₁ loves one of PRO₁'s relatives. It also allows a functional continuation which matches the reading which results from quantifying in one of PRO₁'s relatives in the sentence every man loves PRO'S₁, by means of a process which is completely analogous to that by means of which the functional reading of a question like (2) is derived and which was described above in rule (S:AB5). In this case too, the syntactic binding of his in one of his relatives by every man is not paralleled by the usual semantic binding: the variable in the translation of his is not bound by the quantifier in the translation of every man. This is shown by the following representation of the functional reading of (40):

(41) $\exists f[R(f) \wedge \forall x \text{ relative-of}(a)(f(x), x) \wedge \forall x[\text{man}(a)(x) \rightarrow \text{love}(a)(x, f(x))]]$

The pronoun his gets bound semantically in the restriction on the range of the Skolem-function f . The effect is the

same as in the case of the corresponding question: for every man x , $f(x)$ denotes one of x 's relatives. Notice that since (41) expresses restricted quantification over Skolem-functions, it is not equivalent to (42), which represents the pair-list reading of (40):

$$(42) \forall x[\text{man}(a)(x) \rightarrow \exists y[\text{relative-of}(a)(y,x) \wedge \text{love}(a)(x,y)]]$$

So, we assign to (40) two distinct readings, the functional one and the pair-list one.

Formula (41) also represents the only reading of sentence (43):

(43) There is one of his relatives that every man loves

This sentence allows neither an individual continuation nor a pair-list one. It can only be continued with a specification of a function. In this case the need to distinguish functional readings is quite evident, the functional reading being the only one (43) has.

The reason why (43), (38) and (36) do not have a pair-list reading is that in order to obtain this reading the term every man, c.q. no man would have to be quantified into a relative clause, which is not allowed: the scope of any term inside a relative clause is restricted to that relative clause.²² The reason why (43), unlike (38) and (36), also does not have an individual reading is the same as why this reading does not occur with (40): it would leave the pronoun his in one of his relatives unbound.

5. Conclusion

What we have tried to show in this paper were two things: first of all, that questions have functional readings and that these readings are independent from other readings, and secondly, that an account of functional readings can be given within the framework of Montague grammar.

As for the first objective, we think that the arguments given in this paper are convincing. The phenomenon of functional readings is a real one, which even extends to other types of constructions, as we have indicated in the previous section.

Concerning the account of functional readings which we sketched above, we are less satisfied. We do believe that the rules which we have proposed give a compositional analysis of functional readings. However, we cannot reason away some doubts as to the plausibility (let alone elegance) of the syntactic part of our analysis. We would prefer one which would involve less complications in the syntax. Such an analysis would require a major modification of the framework of Montague grammar. And of the available alternatives, none strikes us as definitely superior in this respect. And it may be relevant to stress again that whatever kind of analysis one may come up with, functional readings should be represented as distinct readings of questions (and other constructions), and thus require some level of representation on which these constructions are disambiguated.

Notes

- * We would like to thank Elisabet Engdahl for some stimulating discussions and Renate Bartsch and Johan van Benthem for their comments on some preparatory notes.
1. An individual answer may, of course, specify more individuals. So, if both Mary and Suzy are loved by every man, (a') is an individual answer too:

(a') Mary and Suzy

Something similar holds for pair-list answers and functional answers: (b') is also a pair-list answer to question (1), and (c') a functional answer:

(b') John loves Mary, John loves Suzy, Bill loves Suzy, ...

(c') His mother and his grandmother

For simplicity's sake, we stick in what follows to the most simple case.

2. There are situations in which it does seem to be possible to give an individual answer to a question like (2). Suppose we quantify over the set of men in our family. These men have the same (blood-)relatives. Then the following is possible:

(2') Which of his (blood-)relatives does every man (in our family) love?

(a) Aunt Mary

However, it is quite clear that in this situation the answer (2')(a) is to be regarded as a special case of a functional answer. It specifies a constant function, in this case a function which for every argument gives aunt Mary as value.

Individual answers to (2) are also possible if the pronoun his is a free (deictic) pronoun:

(3") Which of his (= John's) relatives does every man love?

(a) (John's) aunt Mary

Unlike (2')(a), which looks like an individual answer, but is a functional one, (3")(a) is an individual answer. A last remark concerns what apparently are mixed answers:

- (1) Which woman does every man love?
 (d) Mary and his mother

This answer (d) seems to be a combination of an individual and a functional answer, but is, we think, better regarded as a functional answer. The answer gives (the composition of) two functions, the constant function to Mary and the mother-function.

3. 'Loosely speaking', for, as we argued in G & S 1982, section 6.3, the link between the semantic interpretation of questions and the question-answer relationship is not as direct as the formulation in the text suggests. More in particular, pragmatic factors seem to play a predominant role when it comes to characterizing what constitutes a correct answer to a question in a given situation. But for our present purposes, these aspects may be ignored.
4. Throughout we will not bother about certain details, such as mentioning rule numbers, distinguishing between verbs and their extensional counterparts by means of substars, etc. The formulas in the translation trees will be the reduced forms at each step.
5. From now on, we will leave out irrelevant syntactic and semantic information in the analysis trees and translation trees.
6. We will not give the actual rule, it can be found in G & S 1982, section 6.1, where a more extensive motivation for the existence of this rule can be found.
7. See also footnote 2.
8. See e.g. Bennett (1977), who says that a pair-list answer: "might be given in a very compressed way" in the form of a functional answer, and adds that: "Obviously, for epistemic reasons, someone is more likely to give an answer like the second one than like the first."
9. We disregard for the moment the individual reading which the indirect question, and consequently the sentence as a whole, also has.
10. This is not to deny that sometimes a list of pairs may, for the sake of convenience or for some other reason, be abbreviated by a function. The point is that this is not always the case, that functional answers do have a status of their own and that hence questions have a functional reading.

11. Notice that the following list of pairs:

(b') John doesn't love Mary, Bill doesn't love Suzy, ...
does not constitute an answer to a question like (11).

12. The distinction between universal and non-universal terms originates from a discussion of the specific/non-specific contrast in the use of terms, where it proved to be useful too (see G & S 1981). Using some terminology from recent studies on generalized quantifiers (see e.g. Barwise & Cooper 1981, Zwarts 1981) we can define a universal term as one for which it holds that the set on which it lives is a subset of every set in the set of sets denoted by it. Formally:

A term $D(A)$ is universal iff $\forall X: X \in \llbracket D(A) \rrbracket \Rightarrow A \subseteq X$

The distinction between universal and non-universal terms also seems to play a role when it comes to determining when quantifying in is allowed, though there things are not as straightforward as one might wish. However, the following seems to hold at least: a non-universal term may not be quantified over another non-universal term.

13. This restriction on quantification into questions was not stated in G & S 1982.
14. We cannot discuss the relevant arguments here, since that would take us too far afield, they are given in G & S 1981c. Recently, Engdahl has come up with another proposal for the analysis of functional readings which in some respects is quite like the analysis proposed in the present paper.
15. Notice that (19) is an abstract, not a complement. From now on, we can restrict our attention to the level of abstracts since nothing changes in the way abstracts are turned into complements, i.e. proposition denoting expressions. So, the proposition denoted by a question can be 'read off' the translation of the abstract underlying it. E.g. the abstract (19) is turned into the following complement:

$$(19') \lambda i[\lambda f[\forall x[\text{man}(a)(x) \rightarrow \text{love}(a)(x, f(x))]]] = \lambda f[\forall x[\text{man}(i)(x) \rightarrow \text{love}(i)(x, f(x))]]]$$

16. Skolem-functions first made their appearance on the linguistic and philosophical stage in a play called 'What is a branching quantifier and why?', which ran for a short but stormy period in the seventies. For some reviews, see Hintikka (1974), Günthner & Hoepelman (1975) and Barwise (1979).
17. We extend the PTQ-mechanism of quantification rules and syntactic variables to account for scope ambiguities and binding phenomena. It is fairly easy to transpose our

entire analysis into a framework which uses Cooper-stores as an alternative (see e.g. Cooper (1975), Engdahl (1980)). However, the use of storage mechanisms is not without problems. E.g. it is not quite clear that the use that is made of Cooper-stores in the literature always obeys the compositionality requirement. See Landman & Moerdijk (1983) for a thorough analysis of Partee & Bach's (1981) extension of the storage approach.

18. Instead of analyzing (2) we take (2'):

(2') Which relative of him does every man love?

which is simpler in that we do not have to take into account the analysis of possessive constructions. Of course, for the problems under discussion in this paper it makes no essential difference.

19. On the pair-list reading of this abstract, syntactic and semantic binding are parallel in the usual way. There every man has which relative of him syntactically as well as semantically inside its scope. For this we need the notion of wh-reconstruction defined in G & S 1982, section 4.3.
20. From this, by the way, one may conclude that the controversy between those who require their grammar to give an explicit compositional semantics and those who restrict semantics in the grammar to those aspects determined by pure, autonomous syntax, is not an empirical dispute, but a methodological one.
21. Notice that in this case having recourse to the mechanism of functional readings is essential. Of course, the functional reading of (38) which (39) represents can also be expressed without quantification over Skolem-functions:

$$(39') \forall x[\text{man}(a)(x) \rightarrow \exists y[\text{woman}(a)(y) \wedge \neg \text{love}(a)(x,y)]]$$

But it is impossible to obtain (39') in a compositional way, using the straightforward translation of no man as $\lambda P \forall x[\text{man}(a)(x) \rightarrow \neg P(a)(x)]$.

22. For an extensive discussion, see Rodman (1976). The constraint in question is incorporated in the syntax of relative clauses given in G & S 1982, section 4.5.

References

- Barwise, J., 'On branching quantifiers in English',
Journal of Philosophical Logic, 8, 1979
- Barwise, J. & R. Cooper, 'Generalized quantifiers and natural
language', Linguistics and Philosophy, 4, 1981
- Bennett, M., 'Questions in Montague Grammar', IULC, 1979
- Cooper, R., Montague's semantic theory and transformational
syntax, dissertation, Amherst, 1975
- Engdahl, E., The syntax and semantics of questions in Swedish,
dissertation, Amherst, 1980
- Groenendijk J. & M. Stokhof, 'A pragmatic analysis of
specificity', in: F. Heny (ed.), Ambiguities in intensional
contexts, Dordrecht, 1981a
- Idem, 'Semantics of wh-complements', in: J. Groenendijk,
T. Janssen & M. Stokhof (eds.), Formal methods in the study
of language, Amsterdam, 1981b
- Idem, 'Interrogative quantifiers and Skolem-functions.
Preparatory notes', manuscript, Amsterdam, 1981c
- Idem, 'Semantic analysis of wh-complements', Linguistics and
Philosophy 5, 1982.
- Günthner, F. & J. Hoepelman, 'A note on the representation of
branching quantifiers', Theoretical Linguistics 2, 1975
- Hintikka, J., 'Quantifiers vs. quantification theory',
Linguistic Inquiry 5, 1974.
- Landman F. & I. Moerdijk, 'Morphological features and
conditions on rules in Montague Grammar', Amsterdam Papers
in Formal Grammar III, 1981
- Idem, 'Compositionality and the analysis of anaphora',
Linguistics and Philosophy 6, 1983
- Idem, 'Compositional semantics and morphological features',
Theoretical Linguistics, 10, 1983

- Partee, B., 'Some transformational extensions of Montague Grammar', Journal of Philosophical Logic 2, 1973
- Idem, 'Constraining transformational Montague Grammar: a framework and a fragment', in: S. Davis & M. Mithun (eds.), Linguistics, philosophy and Montague Grammar, Austin, 1977
- Partee, B. & E. Bach, 'Quantification, pronouns and VP-anaphora', in: J. Groenendijk, T. Janssen & M. Stokhof (eds.), Formal methods in the study of language, Amsterdam, 1981
- Rodman, R., 'Scope phenomena, "movement transformations" and relative clauses', in: B. Partee (ed.), Montague Grammar, New York, 1976
- Zwarts, F., 'Negatief polaire uitdrukkingen I', GLOT 4, 1981

IV

ON THE SEMANTICS OF QUESTIONS
AND THE PRAGMATICS OF ANSWERS

reprinted from:

F. Landman & F. Veltman (eds.),
Varieties of formal semantics,
Foris, Dordrecht, 1984

CONTENTS

0. Introduction	211
1. Questions and partitions	213
2. Questions, answers and information	216
3. Some formal properties of questions	218
4. To have a (true) answer and to know an answer	224
5. Pragmatic answers	226
6. Partial answers	233
7. Indirect answers	237
8. Answers compared	242
9. Correctness of question-answering	246
Notes	249
References	250

0. Introduction

There is a vast, and rapidly growing, literature on questions and question-answering. The subject has had the longstanding and almost continuous attention in many areas of study, including linguistics, logic, philosophy of language, computer science, and certainly others besides. Many proposals for the analysis of questions and answers at different levels and in different fields and frameworks exist. The aim of this paper is no other than to add another proposal to this long list. We will not discuss the work of others, or point at the relative merits of our own. This is an ill-practice which we hope to make good for at some time in the future.

The analysis of questions and answers we will propose, is a fairly simple and straightforward one. Our most basic assumption, which perhaps strikes the uninitiated as rather trivial, is that there is no hope for an adequate theory of question-answering that does not take absolutely seriously the fact that a correct question signalizes a gap in the information of the questioner, and that a correct answer is an attempt to fill in this gap as well as one can by providing new information. So, information should be a crucial notion in any acceptable theory of question-answering. Whether a piece of information, a proposition, provides an answer to a question of a certain questioner, depends on the information it conveys and on the information the questioner already has. This makes the notion of answerhood essentially a pragmatic one. But no pragmatics without semantics. It is not information as such, but only information together with the semantics of a question, that determines whether a proposition counts as a suitable answer.

Although it can be read quite independently of it, this paper is a follow-up of our paper on the semantic analysis of indirect questions (G & S 1982). In the final section of that paper, we expressed the hope that our analysis of indirect questions would shed some light on what a proper analysis of direct questions looks like. We share the opinion that a fully adequate theory of questions should deal with direct and indirect questions in a uniform way. The semantics of direct and indirect questions should be intimately related. The aim of this paper is to argue that our semantics for indirect questions, which enabled us to explain a number of semantic facts about sentences in which questions occur embedded under such verbs as know and wonder, can also be made to work in an analysis of the question-answer relation, thus satisfying a requirement Belnap has formulated for semantical theories of (indirect) questions (see Belnap 1981).

In this paper we explore one possible account of the question-answer relation. This analysis stays within the possible worlds framework, within which we also developed our analysis of indirect questions. This framework has its inherent shortcomings and the analysis developed here is bound to inherit them. But it seems clear to us that our analysis, when suitably rephrased, can be incorporated in a different, more sophisticated, epistemic pragmatic theory.

Although this paper is clearly related to our earlier work on indirect questions, it differs from it in perspective to a considerable extent. Whereas our former paper primarily dealt with the syntax and semantics of certain linguistic constructions, this paper hardly refers to language or linguistics at all. When we talk about questions or (propositions giving) answers here, we do not mean interrogative or indicative sentences, i.e. linguistic objects, but the objects that serve as their interpretation, i.e. semantic, modeltheoretic objects.

Still, in the end, it is language that matters. We would not be satisfied if the semantic objects we discuss could

not be linked in a systematic way to linguistic expressions. However, we are confident that, in principle, this will constitute no major problem. We feel that our confidence is justified by the fact that there is a well-defined syntactic relationship between direct and indirect questions. Since we have already given a compositional syntax and semantics for indirect questions and since the semantics of indirect and direct questions is the same, we feel that a compositional analysis of direct questions will be possible.

We share the basic view of questions and answers expressed here with many others. One of them, whom we should mention, is Hintikka. To our knowledge, he was the first to develop a theory of questions and answers (see Hintikka 1974, 1976, 1978) in which the notion of an answer "does not depend only on the logical and semantical status of the question and its putative answer, [...] but also on the state of knowledge of the questioner at the time he asks the question" (Hintikka 1978, p. 290).

1. Questions as partitions

In G & S (1982) questions were analyzed as proposition denoting expressions. At an index, a question denotes a proposition, which we will call the true semantic answer at that index. So, the sense (meaning) of a question is a propositional concept, a function from indices to propositions, which at every index yields as its value the proposition that is the true semantic answer to that question at that index.

Let us immediately remark two things about this notion of semantic answerhood. Calling these answers 'semantic' indicates first of all that the resulting notion of answerhood is a limited one, indeed a limiting case of the true notion of an answer, which, in our opinion, is essentially a pragmatic notion. Secondly, it signalizes that when we are talking about questions and answers in this paper, we do not

talk about linguistic entities, but refer to semantic objects. (But for reasons of readability, we italicize expressions referring to these objects.)

In this paper we will view questions as partitions of the set of indices, a perspective which is different from, though equivalent with, the propositional concepts view taken in G & S (1982). A partition of a set A is a set of non-empty subsets of A such that the union of those subsets equals A and no two of these subsets overlap.

Formally:

(1) A is a partition of A iff

$$\forall X \in A: X \neq \emptyset, \bigcup_{X \in A} X = A, \forall X, Y \in A: X \cap Y = \emptyset \vee X = Y$$

If we view a question as a partition of the set of indices I , each element of that partition, a set of indices, represents a proposition, a possible semantic answer to that question. Consider the question whether ϕ . This question has two possible semantic answers: that ϕ , and that not ϕ . The two sets of indices corresponding to these two propositions divide the total set of indices in two non-overlapping parts. So, a single whether-question (a yes/no question) makes a bipartition on the set of indices (except for the tautological question, see section 3). Figure 1 below gives a pictorial representation.

Constituent questions can be viewed as partitions as well. The possible semantic answers to the question who G 's, are propositions that express that the objects a_1, \dots, a_n are the ones that G . Such propositions exhaustively and rigidly specify which objects have the property G at an index.¹ The sets of indices that represent the possible semantic answers form a partition of I . They do not overlap (the various propositions each exhaustively specify a certain set of individuals), and their union equals I (the property G is a total function). Partitions made by constituent questions can also be represented pictorially (in finite cases, at least), see figure 2.

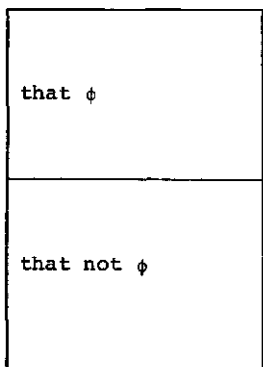
whether ϕ 

I

(figure 1)

who G's

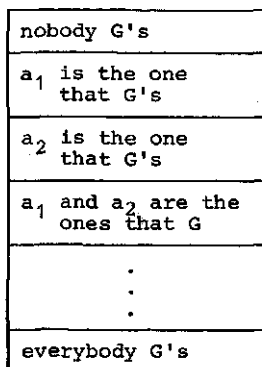

I

(figure 2)

So, generally, a constituent question can be regarded as an n -fold partition of I , where n is the number of possible denotations of the (complex or simple) predicate involved in the question.

That the propositional concept view of questions and the partition view are equivalent is easy to see. In G & S (1982) questions were represented by expressions of the following form:

$$(2) \lambda j[\alpha/i/ = \alpha/j/]$$

Here i and j are variables of type s , ranging over indices, and $\alpha/i/$ and $\alpha/j/$ are two expressions which differ only in that where the one has free occurrences of i the other has free occurrences of j . The sense of a question,

$\llbracket \lambda i \lambda j [\alpha/i/ = \alpha/j/] \rrbracket_{M,g}$ is a semantic object of type $\langle s, \langle s, t \rangle \rangle$, i.e. a relation between indices. This relation holds between two indices if and only if the denotation of α is the same at both. It is easy to check that this relation is reflexive, symmetric and transitive, i.e. that it is an equivalence relation. To every equivalence relation R on

on a set A corresponds a partition of A, the elements being the equivalence classes of A under R. So, the semantic object expressed by a question Q can be regarded as a partition of the set of indices I:

$$(3) I/Q =_{\text{def}} \{[i]_Q \mid i \in I\}$$

where $[i]_Q$, the set $\{j \in I \mid Q(i)(j)\}$, is the answer to Q at i. This means that the partition I/Q is the set of possible semantic answers to Q.

2. Questions, answers and information

Above we have characterized the proposition denoted by a question at a certain index as the true, semantic answer to that question at that index. As we noted in G & S (1982), this semantic notion of answerhood can hardly do as a satisfactory explication of the intuitive notion of answerhood. E.g. the proposition that is a semantic answer to the question who G's, gives a rigid specification of the objects that have the property G. If the objects are individuals, such a specification might be given using the individual's proper names, assuming the latter to be rigid designators. There are many problems with the consequent rigid notion of answerhood. For one thing, in an actual speech situation, it may very well be the case that, for one reason or other, no such names are available to the speech participants. Further, there are situations in which identification of objects by means of descriptions could serve just as well, and sometimes even better. However, a proposition in which an object that has a certain property is identified by means of a proper name, is not equivalent to, and in general even logically independent of, a proposition in which this identification is carried out by means of a description. Yet, in many cases, the latter provide excellent answers to questions. There is no purely

semantic way to relate these answers 'by description' to the semantic answers 'by naming'. And, of course, this is not to be expected. The relationship between questions and answers cannot be isolated from the purpose of posing questions and of answering them: to fill in a gap in the information of the questioner. And consequently, whether two semantically unrelated propositions can serve equally well as an answer to a question, cannot be decided without taking this information into account. So, the question-answer relation is essentially of a pragmatic nature.

Within the limits of possible world semantics, the information of a speech participant can simple-mindedly be represented as a non-empty subset of the set of indices. Each index in such an information set represents a state of affairs that is compatible with the information in question. Evidently, the amount of information is inversely proportional to the extension of the corresponding set. Information is maximal if the information set is a singleton, and minimal if it equals I.

Considerations like those presented above, lead us to a relativization of questions and answers to information sets. Notice that although from a semantic point of view, i.e. if we take the full set of indices into account, a description will, in general, not be a rigid specification of an object, it may very well be that it is such a rigid specification if we limit ourselves to a subset of I. In fact, if a speech participant has the information to which object a description refers, such a description will function pragmatically as a rigid designation of that object. So, although descriptions and proper names in general will not be semantically equivalent, they may very well happen to be pragmatically equivalent.

3. Some formal properties of questions

The cardinality of a question I/Q equals the number of possible semantic answers to it. The lowest possible cardinality of I/Q is 1 (since we do not allow $I = \emptyset$, in that case it would hold for all Q : $I/Q = \emptyset$). In this case $I/Q = \{I\}$. We call this the tautological question in I . Its only answer is the tautology. E.g. if ϕ is a tautology or contradiction, then the single whether question whether ϕ is the tautological question. The questions wether (ϕ or not- ϕ) and whether (ϕ and not- ϕ) have the equivalent answers yes, ϕ or not- ϕ , and no, not(ϕ and not- ϕ), respectively. Tautological constituent questions are e.g. who G's or does not G, and, which F is not an F. One could very well say that the tautological question does never arise. A question that has only one possible answer is not a proper question at all.

Some operations on questions (partitions) result in new questions (partitions), as do the 1-place operations that take the union of two elements of partition:

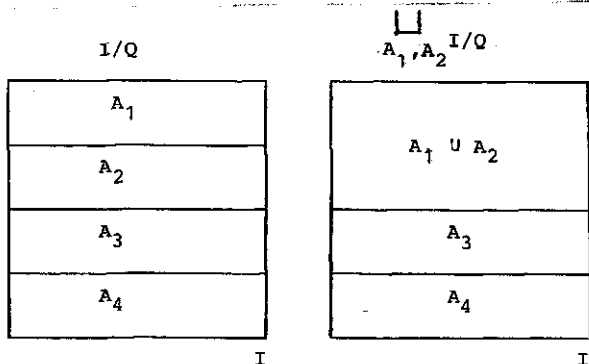

(Figure 3)

This operation can be defined as follows:

$$(4) \text{ For } X, Y \in I/Q: \bigsqcup_{X,Y} I/Q = \{Z \mid Z = XUY \vee (Z \neq X \ \& \ Z \neq Y \ \& \ Z \in I/Q)\}$$

(The 1-place operation that takes the complements of all the elements of a partition does not in general result in a partition again. It does so only when it operates on a bipartition, in which case it maps it onto itself, which reflects the equivalence of the questions whether ϕ and whether not- ϕ .)

A two-place operation on partitions that results in a new partition, is the one that takes the non-empty intersections of all the elements of the two partitions on which it operates:

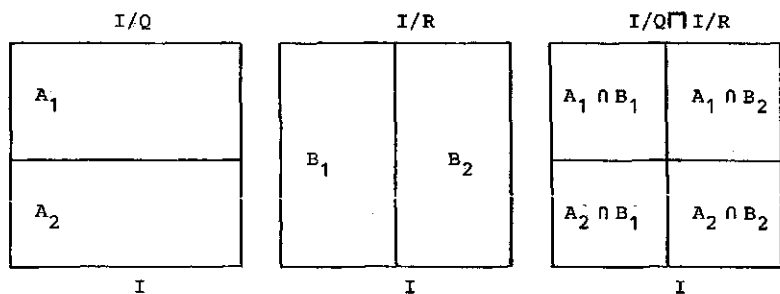

(figure 4)

This intersection operation can be defined as follows:

$$(5) I/Q \cap I/R = \{X \cap Y \mid X \in I/Q \ \& \ Y \in I/R \ \& \ X \cap Y \neq \emptyset\}$$

In the pictorial representation of the intersection of two partitions, the dividing lines of each of the two partitions return.

An alternative whether question whether ϕ or ψ can be constructed as the intersection of the two bipartitions whether ϕ , and whether ψ . In general, an alternative whether-

question with n terms can be constructed stepwise from n bipartitions, i.e. from n single whether-questions. In fact, any non-tautological question can be constructed by intersection from a number of bipartitions. E.g. the constituent question who G's can be constructed in this way from the questions whether a₁ G's, whether a₂ G's, etc.

The union operation on two partitions is defined as follows:

$$(6) \quad I/Q \sqcup I/R = \{Z \mid Z \neq \emptyset \ \& \ \exists X \subseteq I/Q, \exists Y \subseteq I/R: \\ Z = \bigcup_{x \in X} x = \bigcup_{y \in Y} y \ \& \ \exists Z' : Z' \neq \emptyset \ \& \ \exists X \subseteq I/Q, \\ \exists Y \subseteq I/R: Z' = \bigcup_{x \in X} x = \bigcup_{y \in Y} y \ \& \ Z' \subset Z\}$$

In a pictorial representation of the union of two partitions, only those dividing lines are retained that the two have in common, as is illustrated in figure 5.

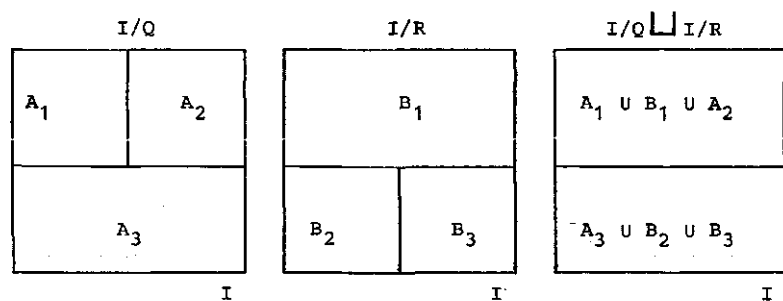

(figure 5)

The union operation will play no role in the remainder of this paper. It has no straightforward linguistic analogue.

More important in the present context is the following inclusion relation between partitions.

$$(7) \quad I/Q \sqsubseteq I/R \text{ iff } \forall x \in I/Q \quad \exists y \in I/R: x \subseteq y$$

The inclusion relation holds between two questions I/Q and I/R iff every semantic answer to Q implies a (unique) semantic

answer to R. It is a kind of implication relation between questions. $I/Q \sqsubseteq I/R$ means that I/Q is a refinement of I/R , i.e. that every dividing line in I/R is a dividing line in I/Q as well. See the example in figure 6.

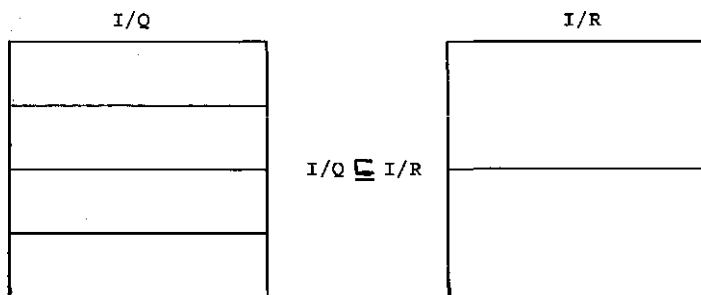

(figure 6)

The following facts can be seen to hold:

- (8) For all I/Q : $I/Q \sqsubseteq \{I\}$
- (9) For all I/Q : $\{\{i\} \mid i \in I\} \sqsubseteq I/Q$
- (10) $I/Q \sqcap I/R \sqsubseteq I/Q$
- (11) $I/Q \sqsubseteq I/R$ iff $I/Q \sqcap I/R = I/Q$
- (12) $I/Q \sqsubseteq I/Q \sqcup I/R$
- (13) $I/Q \sqsubseteq I/R$ iff $I/Q \sqcup I/R = I/R$

It can easily be checked that \sqsubseteq is a partial order on the set of all partitions of I . \sqsubseteq is a reflexive, antisymmetric and transitive relation. The operations \sqcap and \sqcup satisfy idempotency, commutativity, associativity and absorption.

The set of all questions in I , i.e. the set of all partitions of I , forms a complete lattice under \sqsubseteq . The tautological question $\{I\}$ is its maximal element (8). It is the least demanding question. Its counterpart $\{\{i\} \mid i \in I\}$ is the most demanding one. It asks everything that can be asked. It might be phrased as 'What is the world like?'. It is the minimal element of the lattice (9). The bipartitions

(single whether-questions) are the dual atoms. \sqcap and \sqcup are the meet and join.

We have seen in section 2 that in order to obtain a pragmatic notion of answerhood, we are interested in relativizing questions and answers to information sets, i.e. to non-empty subsets of I . Doing so, we get pictures such as the following:

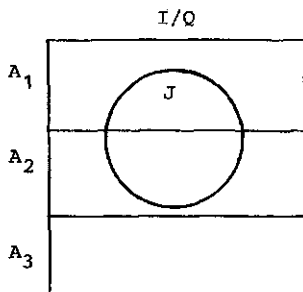

(figure 7)

In the situation depicted in figure 7, A_1 and $A_2 \in I/Q$ are the semantic answers to Q that are compatible with J . A_3 is not compatible with J , since $A_3 \cap J = \emptyset$. The set of semantic answers compatible with J , I/Q^J , can be defined as follows:

$$(14) I/Q^J = \{X \mid X \in I/Q \ \& \ X \cap J \neq \emptyset\}$$

Of course it will always hold that $I/Q^J \subseteq I/Q$.

A second notion that suggests itself is the partition that a question Q restricted to J makes on J . We will write this as J/Q , and will simply speak of the partition that Q makes on J . This notion can be defined as follows:

$$(15) J/Q = \{X \cap J \mid X \in I/Q \ \& \ X \cap J \neq \emptyset\}$$

The notions I/Q^J and J/Q are related as follows:

$$(16) X \in I/Q^J \text{ iff } \exists Y \in J/Q: Y \subseteq X$$

The inclusion relation between partitions can now be generalized as follows:

$$(17) J/Q \subseteq K/R \text{ iff } \forall X \in J/Q \exists Y \in K/R: X \subseteq Y$$

The following fact can be observed:

$$(18) J/Q \subseteq K/R \text{ iff } J \subseteq K \ \& \ J/Q \subseteq J/R$$

Notice that (18) implies (19):

$$(19) J/Q \subseteq I/Q$$

This expresses that the partition that Q makes on I is preserved when Q is restricted to J , in the sense that it may be compatible with less semantic answers, but that every answer in (element of) J/Q will be a subset of a semantic answer.

The limiting case is where J/Q contains just one element (provided that J is non-empty), i.e. where $J/Q = \{J\}$. In this case, Q could be called the tautological question in J . But we will preserve the notion of the tautological question as a purely semantic one, and will not use it when talking about information sets. Instead we define:

$$(20) J \text{ offers an answer for } Q \text{ iff } J/Q = \{J\}$$

If an information set offers an answer to a question, the question can be said to be decided by that information, the information provides a (unique) answer.

Fact (18) guarantees that when one's information increases then one remains at least as close to an answer to a question.

4. To have a (true) answer and to know an answer

An information set represents information of an individual x at an index i . We will add an individual parameter and an index parameter to informationsets. We can distinguish two kinds of information sets, doxastic sets and epistemic sets. We will call both kinds of sets information sets. A doxastic set $D_{x,i}$ is a non-empty set of indices, representing the consistent beliefs of x in i . An epistemic set $E_{x,i}$ represents the knowledge of x in i . Since what one knows should be true, i should be an element of $E_{x,i}$. The epistemic and the doxastic set of x in i are related, since what one knows, one also believes. So, we can formulate the following general constraints²:

$$(21) \quad \begin{aligned} E_{x,i} &\subseteq I, \quad i \in E_{x,i} \\ D_{x,i} &\subseteq E_{x,i}, \quad D_{x,i} \neq \emptyset \end{aligned}$$

Since we have $D_{x,i} \subseteq E_{x,i} \subseteq I$, we also have for any question Q :

$$(22) \quad D_{x,i}/Q \subseteq E_{x,i}/Q \subseteq I/Q$$

The notion of an information set offering an answer, defined in (20), applies to doxastic and epistemic sets. And (22) assures us that if $E_{x,i}$ offers an answer to Q , then $D_{x,i}$ offers an answer to Q as well.

We are also interested in the notion of an information set offering a true answer to a question. If an information set $J_{x,i}$ offers an answer, this need not be a true answer. In the situation in figure 8(b), $J_{x,i}$ offers an answer, but not a true one, whereas in 8(c) and 8(d), $J_{x,i}$ offers a true answer. (In 8(a) $J_{x,i}$ does not offer an answer at all, regardless of where i is situated.) But notice that since i has to be an element of $E_{x,i}$, the situations depicted in 8(b) and 8(c) cannot occur if $J_{x,i}$ is to be an epistemic set, but only if it is a doxastic set. A doxastic set need

not contain only true information about i . But still, as 8(c) illustrates, it may offer a true answer.

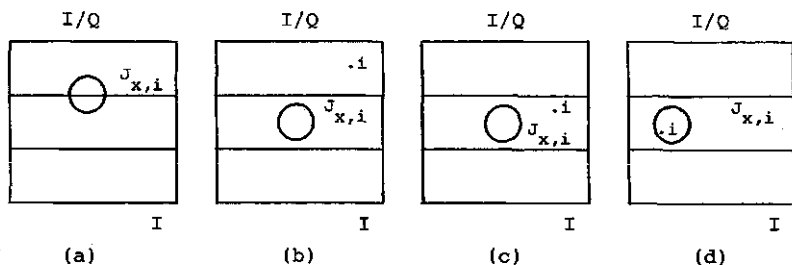

(figure 8)

We can define the notions of an information set offering an answer or a true answer to a question as follows:

- (23) $J_{x,i}$ offers an answer to a question Q
iff $J_{x,i}/Q = \{J_{x,i}\}$
 $J_{x,i}$ offers a true answer to Q iff $J_{x,i} \cup \{i\}$
offers an answer to Q

Since $E_{x,i} \cup \{i\} = E_{x,i}$, $E_{x,i}$ offers a true answer to Q iff $E_{x,i}$ offers an answer to Q . This does not hold for $D_{x,i}$. What does hold is that if $D_{x,i}$ offers a true answer to Q , then it offers an answer, but not necessarily the other way around.

So, (23) gives rise to the following three possibilities:

- (24) x has an answer to Q in i iff $D_{x,i}$ offers an answer to Q
 x has a true answer to Q in i iff $D_{x,i}$ offers a true answer to Q
 x knows an answer to Q in i iff $E_{x,i}$ offers an answer to Q

To know an answer implies to have a true answer, but not the other way around, since $D_{x,i} \cup \{i\}$ may be a proper subset of $E_{x,i}$. And to have a true answer implies to have an answer.

5. Pragmatic answers

We are now almost in the position to define the wider, pragmatic notion of answerhood that we are after, i.e. the notion of a proposition giving an answer with respect to an information set. A proposition gives an answer to a question in an information set, if the information set to which that proposition is added offers an answer. So, in order to calculate whether a proposition P gives an answer to a question Q in an information set $J_{x,i}$, we first update $J_{x,i}$ with P , which results in a new information set $J'_{x,i}$, and then check whether $J'_{x,i}$ offers an answer to Q .

There are several important facts to note about the update operation. The first is that it should turn an information set of a certain kind into an information set of the same kind. It should turn a doxastic set into a doxastic set and an epistemic set into an epistemic set. Since $E_{x,i}$ and $D_{x,i}$ are related, they should be updated simultaneously. Secondly, when information sets are updated, they, in general, change. $J'_{x,i}$ need not equal $J_{x,i}$. If a model is determined by the totality of doxastic and epistemic sets of each individual at each index, updating takes us from one model into another. We will not bother to state this in detailed definitions, but it is important to bear these things in mind.

Intuitively, there are two ways to update an information set $J_{x,i}$ with a proposition P , that seem to make sense. The first is to check whether P is consistent with $J_{x,i}$, and if so, to add it to it. The second is to check whether P is true (and consistent with $J_{x,i}$) and if so, to add it to it. In fact, if we apply the first method of updating to a

doxastic set $D_{x,i}$, and, at the same time, the second to the corresponding set $E_{x,i}$, with an extra proviso that keeps $D_{x,i}$ and $E_{x,i}$ related in the proper way, the resulting sets $D'_{x,i}$ and $E'_{x,i}$ will be proper information sets again.

We can define the update operation on information sets as follows:

$$(25) \text{ update } \langle P, \langle D_{x,i}, E_{x,i} \rangle \rangle = \langle D'_{x,i}, E'_{x,i} \rangle$$

$$\text{where } D'_{x,i} = D_{x,i} \cap P, \text{ if } D_{x,i} \cap P \neq \emptyset$$

$$= D_{x,i} \text{ otherwise}$$

$$E'_{x,i} = E_{x,i} \cap P, \text{ if } i \in P \text{ and } D_{x,i} \cap P \neq \emptyset$$

$$= E_{x,i} \text{ otherwise}$$

The reader can verify that $D'_{x,i}$ and $E'_{x,i}$ satisfy the constraints layed down in (21). We will say that update $\langle P, D_{x,i} \rangle = D'_{x,i}$, and update $\langle P, E_{x,i} \rangle = E'_{x,i}$ iff update $\langle P, \langle D_{x,i}, E_{x,i} \rangle \rangle = \langle D'_{x,i}, E'_{x,i} \rangle$.

It may be illuminating to notice that if we start with no information at all, i.e. with $E_{x,i} = D_{x,i} = I$, and continuously update these sets with propositions in accordance with (25), the pair of information sets that results, is, at each step, a pair consisting of a doxastic and an epistemic set, i.e. a pair of sets satisfying (21).

In order to be able to give a definition of a notion of pragmatic answerhood, we need one more auxiliary notion that introduces nothing but a new piece of terminology.

$$(26) Q \text{ is a question in } J_{x,i} \text{ iff } J_{x,i} \text{ does not offer an answer to } Q$$

Q is a question in $J_{x,i}$ iff there is more than one answer to Q that is compatible with J .

We can now give the definition of a proposition giving a (true) answer to a question in an information set as follows (assuming $J_{x,i}$ to be an information set of a certain kind, and update to be the corresponding update operation):

- (27) Let Q be a question in $J_{x,i}$, then (a proposition) P gives a (true) answer to Q in $J_{x,i}$ iff update $\langle P, J_{x,i} \rangle$ offers a (true) answer to Q

What this definition expresses is simply that a proposition answers a question in an information set iff when the information set is updated with the proposition, the question is no longer a question, but is (dis)solved.

Definition (23) of an information set offering a (true) answer, together with definition (25) of the update operation, guarantee that the following facts hold:

- (28) P gives a true answer to Q in $E_{x,i}$ iff P gives an answer to Q in $E_{x,i}$
 If P gives an answer to Q in $E_{x,i}$, then P gives a true answer to Q in $D_{x,i}$
 If P gives a true answer to Q in $D_{x,i}$, then P gives an answer to Q in $D_{x,i}$

In view of (28), we can say, analogously to (24):

- (29) P gives x an answer to Q in i iff P gives an answer to Q in $D_{x,i}$
 P gives x a true answer to Q in i iff P gives a true answer to Q in $D_{x,i}$
 P does let x know an answer to Q in i iff P gives an answer to Q in $E_{x,i}$

The following examples may serve to illustrate the notions of pragmatic answerhood. Consider the situation in figure 9(a):

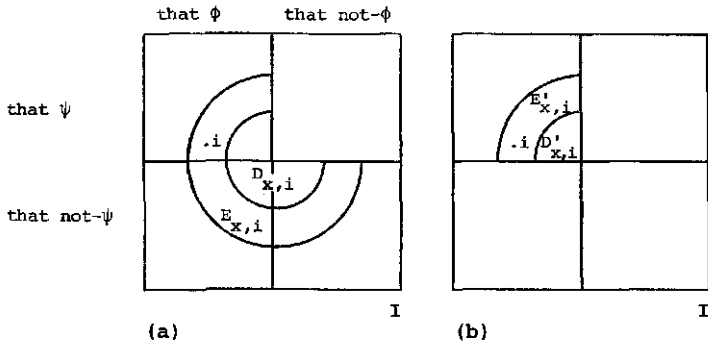

(figure 9)

The vertical division of I is the partition $I/\text{whether } \phi$, the horizontal one is $I/\text{whether } \psi$. Since $i \in \text{that } \phi$ and $i \in \text{that } \psi$, $\text{that } \phi$ and $\text{that } \psi$ are true in i . $D_{x,i}$ and $E_{x,i}$ contain the information that if ψ , then ϕ . Neither the question whether ϕ nor the question whether ψ is answered in $D_{x,i}$ or in $E_{x,i}$. In this situation, the true proposition that ψ gives a true answer to the question whether ϕ in $D_{x,i}$, the answer that ϕ . And it also gives that answer to that question in $E_{x,i}$. Figure 9(b) represents the situation that results after updating $D_{x,i}$ and $E_{x,i}$ with that ψ . Update $\langle \text{that } \psi, D_{x,i} \rangle = D'_{x,i} = D_{x,i} \cap \text{that } \psi$. And update $\langle \text{that } \psi, E_{x,i} \rangle = E'_{x,i} = E_{x,i} \cap \text{that } \psi$. Notice that the pragmatic answer that ψ is logically independent of the semantic answer that ϕ .

As a second example, consider the following situation:

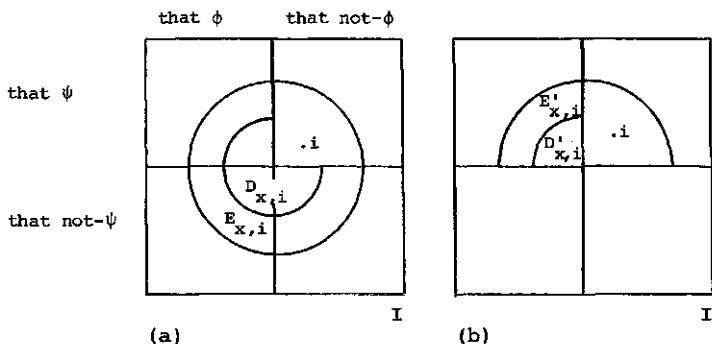

(figure 10)

That ϕ is now false in i , but that ψ is still true. $D_{x,i}$ still contains the (now false) information that if ψ , then ϕ . Since it is false, $E_{x,i}$ cannot contain this piece of information anymore. In this situation, the true proposition that ψ still gives x an answer to the question whether ϕ in i , but no longer a true answer. Then, of course, it cannot let x know an answer either. A true proposition, even if it gives an answer, need not give a true answer.

Next, consider the following situation:

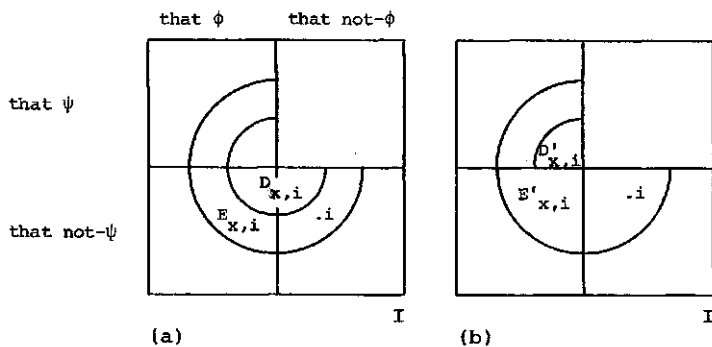

(figure 11)

Both that ϕ and that ψ are now false in i . As in the first example, both $D_{x,i}$ and $E_{x,i}$ contain the information that if ψ , then ϕ . Since $D_{x,i}$ is compatible with that ψ , update $\langle \text{that } \psi, D_{x,i} \rangle = D'_{x,i} = D_{x,i} \cap \text{that } \psi$. But since $i \notin \text{that } \psi$, update $\langle \text{that } \psi, E_{x,i} \rangle = E'_{x,i} = E_{x,i}$. The false proposition that ψ gives x the false answer that ϕ to the question whether ϕ , and does not let x know an answer.

As a last one in this series of examples, consider the following situation:

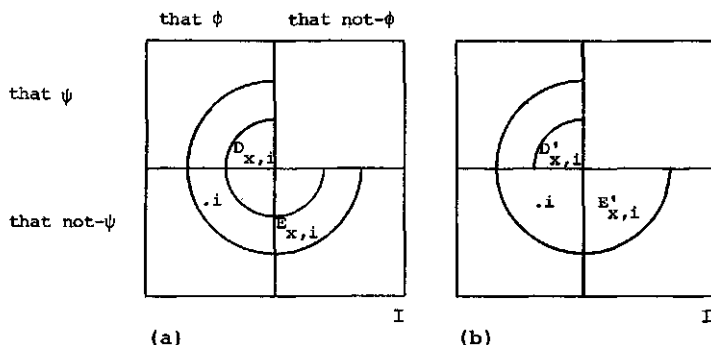

(figure 12)

That ϕ is now true in i , but that ψ is still false. The updates of $D_{x,i}$ and $E_{x,i}$ are similar to those in the previous situation. But this time the proposition that ψ does not only give x an answer, it even gives x the true answer that ϕ . But it cannot let x know an answer, since that ψ is false in i . So, a false proposition can give one a true answer, but it can never let one know an answer.

Whereas in the previous series of examples we concerned ourselves with single whether-questions, in the next example we consider a constituent question.

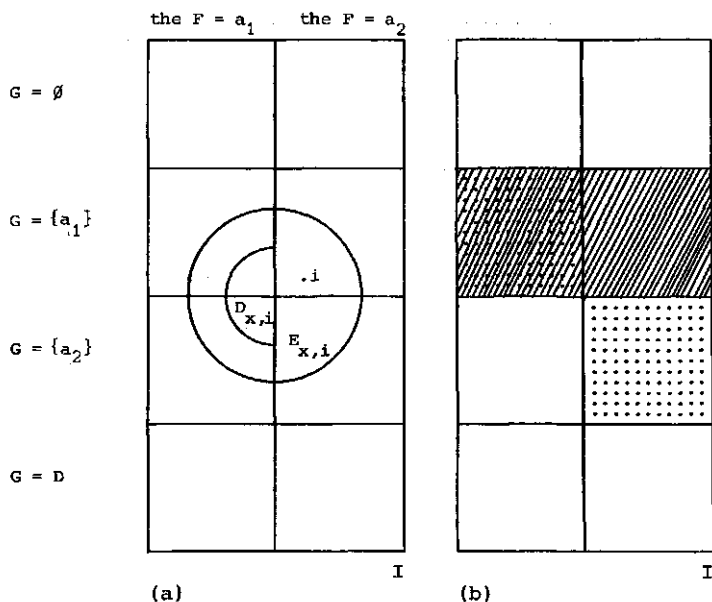

(figure 13)

In this situation, the domain of individuals $D = \{a_1, a_2\}$. F is a property that is true of exactly one individual. The vertical division of I is the partition $I/\text{who is the } F$, the horizontal one is $I/\text{who } G$'s. $D_{x,i}$ contains the (false) information that a_1 is the F , and the (true) information, also contained in $E_{x,i}$, that exactly one individual G 's. The question who G 's is not answered in $D_{x,i}$ and $E_{x,i}$. Both the proposition that a_1 is the one who G 's (the shaded area in figure 13 (b)) and the proposition that the F is the one who G 's (the dotted area) give an answer to the question who G 's in $D_{x,i}$. Notice that the former is a semantic answer, whereas the latter is a pragmatic answer, and that the two are logically independent in I , but pragmatically equivalent in $D_{x,i}$. Both propositions in fact give a true answer in $D_{x,i}$. But only the proposition that a_1 is the one who G 's does let x know an answer in i . Notice that even a much

weaker proposition like that if anyone G's then the F does, would already give x a true answer in i . And propositions like that nobody G's or that everybody G's, would not give an answer, since they are incompatible with x 's information.

6. Partial answers

Although the notion of a pragmatic answer is an essential step towards a satisfactory notion of answerhood, it still calls for further refinements. Pragmatic answers as defined in (27) are always complete answers. If a proposition gives an answer in an information set $J_{x,i}$, the question is always completely solved in that information set. However, in many cases the questioner will already be very happy if her question can be partially solved, i.e. if the set of answers compatible with her information is narrowed down. What we need is a notion of partial pragmatic answerhood.

If a proposition P narrows down an information set $J_{x,i}$ to a proper subset $J'_{x,i}$ such that the answers to Q compatible with $J'_{x,i}$ form a proper subset of the answers compatible with $J_{x,i}$, we will say that P gives a partial answer to Q in $J_{x,i}$. This is exemplified in figure 14(a):

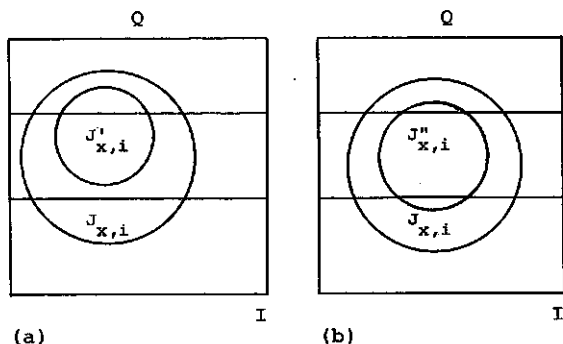

(figure 14)

As figure 14(b) illustrates, a proposition may be informative with respect to $J_{x,i}$, without giving a partial answer to a question Q in $J_{x,i}$.

We will say that $J'_{x,i}$ in figure 14(a) is closer to an answer to Q than $J_{x,i}$ (whereas in 14(b) $J''_{x,i}$ and $J_{x,i}$ are equally close to an answer to Q). The notion of being closer to an answer can be defined as follows:

- (30) Let $J_{x,i}$ be a subset of $K_{x,i}$, then $J_{x,i}$ is closer to an answer to Q than $K_{x,i}$
 iff $I/Q^{J_{x,i}} \subset I/Q^{K_{x,i}}$

If a proposition is to give a true partial answer in an information set $J_{x,i}$ to a question Q , the set of answers to Q compatible with $J_{x,i}$ updated with that proposition should be narrowed down in such a way that the true answer to Q remains accessible. The notion of an information set giving access to a true answer can be defined as follows:

- (31) $J_{x,i}$ gives access to a true answer to Q iff
 $[i]_Q \in I/Q^{J_{x,i}}$

A doxastic set need not give access to a true answer, but an epistemic set always will. The notion of an information set being closer to a true answer can now be defined as follows:

- (32) $J_{x,i}$ is closer to a true answer to Q than $K_{x,i}$ iff
 $J_{x,i}$ is closer to an answer to Q than $K_{x,i}$
 and $J_{x,i}$ gives access to a true answer to Q

For epistemic sets, the notions of being closer to an answer and being closer to a true answer coincide, but they do not for doxastic sets. Whereas a doxastic set will always be as least as close to an answer as an epistemic set, it need not be as least as close to a true answer.

We can now define the notion of a proposition giving a (true) partial answer in an information set as follows:

- (33) Let Q be a question in $J_{x,i}$, then P gives a (true) partial answer to Q in $J_{x,i}$ iff update $\langle P, J_{x,i} \rangle$ is closer to a (true) answer to Q than $J_{x,i}$

Of course, (true) pragmatic answers as defined in (27), which we might call complete pragmatic answers, form a subset of the set of (true) partial answers. The facts stated in (28) for complete pragmatic answers, hold for partial answers as well. And the three different notions of pragmatic answerhood that were distinguished in (29) apply also to partial answers.

An important fact to be noticed is that if $J_{x,i}/Q$ is a bipartition (i.e. if Q is, or comes down to, a single whether question in $J_{x,i}$), and P gives a partial answer to Q in $J_{x,i}$, then P gives a complete answer to Q in $J_{x,i}$. This fact is not very satisfactory. We will come back to it in the next section.

We will end this section by giving some examples of propositions giving partial answers in a doxastic set (the difference between a proposition giving a true answer and letting one know an answer, discussed in the previous section, applies to partial answers in much the same way, but will be left out of consideration here). Consider the situation depicted in figure 15.

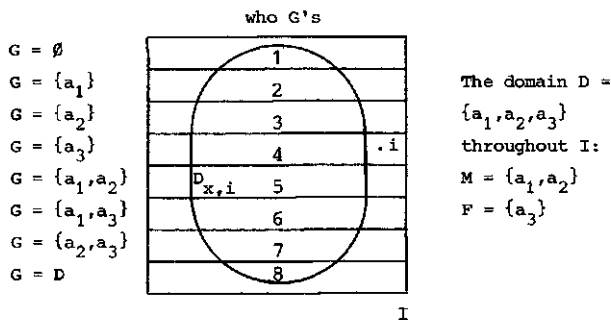

(figure 15)

The proposition that if a_1 G's then a_2 G's, gives a true partial answer in $D_{x,i}$. Updating $D_{x,i}$ with that proposition results in an information set $D'_{x,i}$ in which the areas 2 and 6 in $D_{x,i}$ have been cut out. So, the set of semantic answers compatible with $D'_{x,i}$ is smaller than the set of semantic answers compatible with $D_{x,i}$, and the true semantic answer that a_3 is the one who G's is still accessible in $D'_{x,i}$.

As a second example, consider the proposition that the one who G's is an M. This proposition gives a partial answer in $D_{x,i}$ as well, but this time not a true one. Updating $D_{x,i}$ with the proposition that the one who G's is an M brings $D_{x,i}$ down to the areas 2 and 3. The true answer that a_3 is the one who G's is no longer accessible from this information set. Notice that the proposition that the one who G's is an M would give a complete answer (but again not a true one) in $D'_{x,i}$, which resulted after updating $D_{x,i}$ with the proposition that if a_1 G's then a_2 G's.

The answer that the one who G's is an M might be called an exhaustive indefinite answer. It exhaustively lists the individuals that (are supposed to) walk, in this case only one, and characterizes them by means of an indefinite description. A non-exhaustive indefinite answer would then be the proposition that (at least) an M G's. It gives one individual that G's and specifies it in an indefinite way, but leaves open that there are other individuals that G as well. This proposition gives a partial (false) answer in $D_{x,i}$ as well. It cuts the areas 1 and 3 out of $D_{x,i}$.

Often, indefinite answers are partial ones, but they can very well be complete, the exhaustive indefinite answer that the one who G's is an F gives a complete true answer in $D_{x,i}$. And notice that an exhaustive definite answer like that the one who G's is the F, need not give a complete answer. It does so in the situation in figure 15, but it would not in an information set in which the question who is the F is not decided.

7. Indirect answers

We return now to the unsatisfactory fact noticed above, that questions which are bipartitions in an information set can be answered only completely. This implies e.g. that simple whether-questions cannot be answered partially. But it seems that in a sense, they can. Suppose that whether ϕ is a question in $J_{x,i}$. The proposition that if ψ , then ϕ , can be a good answer, even in case ψ is not contained in $J_{x,i}$. But it does not give a partial answer according to definition (33). Consider figure 16:

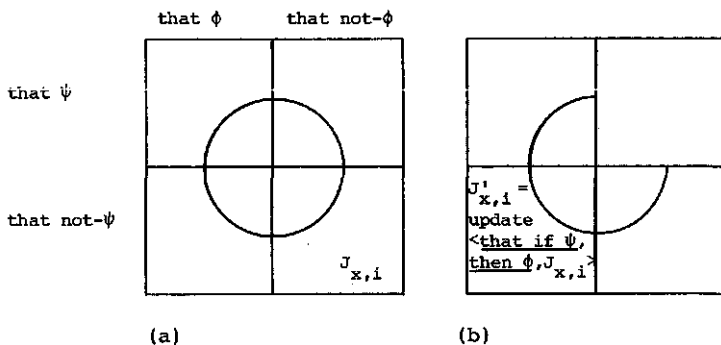

(figure 16)

What is going on here is the following. The situation in 16(b) is the one discussed above with respect to figure 9. There we saw that in this situation, that ψ will give an answer to the question whether ϕ in $J_{x,i}^1$. And notice that in the situation depicted in 16(a), that ψ does not yet give an

answer to whether ϕ in $J_{x,i}$. So it seems that, in a sense, x is getting closer to an answer. What the proposition that if ψ , then ϕ does to $J_{x,i}$ is that it provides a new way of getting an answer to the question whether ϕ . For x can turn to someone and ask whether ψ , and if he is lucky, he gets the answer that ψ , which solves his original question whether ϕ at the same time. His question whether ϕ is related to the question whether ψ . This may be very important, e.g. the question whether ψ may be easier to get answered. And not only informants who happen to have the information whether ϕ , but also informants who do not happen to have that information, but do happen to have the information that ψ can help him out. Notice that whether ϕ and whether ψ are not equivalent in the new information set: that not- ϕ does not give x an answer to whether ψ . In the new information set the proposition that if ϕ , then ψ also provides useful information, without qualifying as a (partial) answer. If x updates with this proposition then his original question whether ϕ gets even more intimately related to whether ψ : it now becomes equivalent to it, for now also that not- ψ tells x something about whether ϕ , viz. that not- ϕ .

Similar situations can occur with constituent questions. Suppose that who is the one who G's is a question in $J_{x,i}$. Suppose further, that x has no idea which individual has the property G , it may be any individual in the domain. If x also has no idea as to which individual is the F , the proposition that the F is the one who G's, will not give a partial answer to her question in $J_{x,i}$. Still, she may be quite satisfied with this answer, because now there is the possibility to turn to another informant and ask the question who is the F. A (partial) answer to that question will be a (partial) answer to her original question as well. And her informant may have an answer to the new question without having one to the old one.

In view of these examples, one would like to widen the notion of answerhood, so as to include this indirect kind of

answers. But doing so is a delicate matter. Informally, these indirect answers can be characterized as follows:

- (34) Let Q be a question in $J_{x,i}$, then P gives an indirect answer to Q in $J_{x,i}$ iff there is some question R in update $\langle P, J_{x,i} \rangle$ such that Q depends more on R in update $\langle P, J_{x,i} \rangle$ than in $J_{x,i}$ and R is not conversationally equivalent to Q in update $\langle P, J_{x,i} \rangle$

Dependence is a relation between questions. Intuitively, a question Q depends on a question R if an answer to R tells us something about an answer to Q . Relativizing dependence to information sets, we give the following definition:

- (35) Q depends on R in $J_{x,i}$ iff
 $\exists X \in I/R^{J_{x,i}} \quad \exists Y \in I/Q^{J_{x,i}} : X \cap Y \neq \emptyset$

According to (35) Q depends on R iff some answer to R compatible with $J_{x,i}$ gives a partial answer to Q in $J_{x,i}$. The comparative notion is then defined as follows:

- (36) Let Q be a question in $J_{x,i} \subset K_{x,i}$, then Q depends on R in $J_{x,i}$ more than in $K_{x,i}$ iff
 $\{X \mid X \in I/R^{K_{x,i}} \ \& \ \exists Y \in I/Q^{K_{x,i}} : X \cap K_{x,i} \cap Y \neq \emptyset\} \subset$
 $\{X \mid X \in I/R^{J_{x,i}} \ \& \ \exists Y \in I/Q^{J_{x,i}} : X \cap J_{x,i} \cap Y \neq \emptyset\}$

According to (36) Q depends more on R in update $\langle P, J_{x,i} \rangle$ than in $J_{x,i}$ iff there are more answers to R that are partial answers to Q in update $\langle P, J_{x,i} \rangle$ than there are in $J_{x,i}$. Thus, in update $\langle P, J_{x,i} \rangle$ the chances of getting an answer to Q through an answer to R are greater than in $J_{x,i}$. As the reader can easily verify, the situations discussed above are covered by this definition.

The notion of conversational equivalence is harder to get a grip on. Elusive though it may be, it is an essential

element in the definition of an indirect partial answer, since it prevents the notion from being totally void. For, without it any proposition that is informative with respect to $J_{x,i}$ would give an indirect answer to any question Q in $J_{x,i}$. This can be shown as follows. Consider a situation in which there are two fully independent (in any sense of the word) atomic propositions that ϕ and that ψ . In such a situation, it is out of the question that the proposition that ψ would be of any help at all for the question whether ϕ . So, that ψ should not come out as an indirect partial answer. However, if we add that ψ to $J_{x,i}$, the question whether ϕ can easily be seen to depend more on the question whether if ψ , then ϕ , than in the original $J_{x,i}$. So, all conditions of (34) are fulfilled, except for the last one.

The following informal reasoning may show how cases like these are cancelled by the requirement of conversational non-equivalence. Remember that the whole point of getting a question on which the original one depends more is that it provides the questioner with the opportunity to find an informant who is not able to answer the original question, but is able to answer the one on which it depends more, with a better chance that such an answer indirectly provides an answer to the original question. This is successful only if the two questions are not conversationally equivalent. Two questions are conversationally equivalent if the questioner has to assume that an informant will be able to answer the one question truthfully iff she is able to answer the other truthfully as well. So, if a proposition gives rise to a new question which is conversationally equivalent to the original one, the entire point of providing an indirect answer vanishes.

This can be captured in the following, more precise definition:

- (37) Q is conversationally equivalent to R for x in i iff $\forall y$ (x believes to know y to know a (partial) answer to Q iff x believes to know y to know a (partial) answer to R)

What remains to be shown is that in the kind of counter-examples discussed above, the new question is indeed conversationally equivalent to the original one. I.e. if we have to show that under the assumption that that ϕ and that ψ are totally unrelated, the question whether if ψ , then ϕ , to which adding that ψ to $J_{x,i}$ gives rise, is conversationally equivalent to the question whether ϕ . This can be done as follows.

Suppose our questioner x asks an informant y whether if ψ , then ϕ . Suppose y replies that, indeed, if ψ , then ϕ . The propositions that ψ and that ϕ are known to be totally unrelated. Thus, x cannot interpret the conditional as expressing some kind of internal relation between ϕ and ψ , for such an interpretation would be incompatible with his information. Consequently, the only interpretation available for x is that of a straightforward material implication. This means that x has to assume that either y believes that ψ is false, or that ϕ is true. If x is to incorporate the material implication in his information, he has to make sure that the latter is the case. For, given that his information contains that ψ that is the only situation in which x can assume that y knows the answer to whether if ψ , then ϕ . But, obviously, this means that in the given circumstances this question is conversationally equivalent to the original question whether ϕ .

As will be clear from this informal discussion, a formalization of the notion of conversational equivalence involves information of speech participants about each other's information in an essential way. This requires a richer framework, and a more restricted notion of an information set, than we are using here. But, informally at least, the matter seems clear, so, assuming a formalization can be given, (34) indeed defines the notion of indirect partial answerhood.

8. Answers compared

Not all propositions give equally good answers to a question in an information set. In what follows, we will formulate some conditions which can be used in comparing propositions in this respect. These conditions will be seen to be related to the notion of a correct answer to a question in a Gricean, conversational, sense of the word.

First of all, there is a condition pertaining to relevance. When relevance is defined as in (38), a condition of relation can be stated as in (39):

- (38) Let Q be a question in $J_{x,i}$, then P is relevant to Q in $J_{x,i}$ iff P gives a (partial) answer to Q in $J_{x,i}$
- (39) If P is a good answer to Q in $J_{x,i}$, then P is relevant to Q in $J_{x,i}$

Notice that indirect answers are excluded. Of course, this is not correct, but we prefer to leave them out of consideration until they are properly formalized.

Second, there is a condition of quality, i.e. a condition pertaining to truth:

- (40) Let Q be a question in $J_{x,i}$, then P is a good answer to Q in $J_{x,i}$ iff P gives a true (partial) answer to Q in $J_{x,i}$

Two things can be noticed. First, since giving a true (partial) answer implies giving a (partial) answer, relevance is subsumed under quality. Second, the condition of quality allows for a weaker and a stronger reading. The

stronger reading results if $J_{x,i}$ is required to be an epistemic set. (In that case relevance would collapse into quality.)

Besides these absolute conditions of relation and quality, there is a relative condition pertaining to the amount of information a proposition gives with respect to a question. Before giving this condition of quantity, we first define some auxiliary notions. Throughout, we assume that Q is a question in $J_{x,i}$ and that P_1, P_2 give (partial) answers to Q in $J_{x,i}$.

- (41) P_1 is more informative to Q in $J_{x,i}$ than P_2 iff
 $P_1 \cap J_{x,i}$ is closer to an answer to Q than $P_2 \cap J_{x,i}$
- (42) P_1 is less overinformative to Q in $J_{x,i}$ than P_2 iff
- (i) P_2 is not more informative to Q in $J_{x,i}$ than P_1 ; and
 - (ii) P_1 is weaker in $J_{x,i}$ than P_2 , i.e.
 $(P_2 \cap J) \subset (P_1 \cap J)$

In terms of (41) and (42) we can define the notion of a more standard answer as follows:

- (43) P_1 is a more standard answer to Q than P_2 iff either
- (i) P_1 is more informative to Q in I than P_2 ; or
 - (ii) P_1 is less overinformative to Q in I than P_2

From (43) it follows that:

- (44) If $P_1 \subset P_2$, then either
- (i) P_1 is more informative to Q in $J_{x,i}$ than P_2 ; or
 - (ii) P_2 is less overinformative to Q in $J_{x,i}$ than P_1 ; or
 - (iii) P_1 and P_2 are equivalent in $J_{x,i}$, and P_1 is a more standard answer to Q than P_2 , or P_2 is a more standard answer to Q than P_1

We are now ready to state the following condition of quantity:

- (45) P_1 is a better answer to Q in $J_{x,i}$ than P_2 iff either
- (i) P_1 is more informative to Q in $J_{x,i}$ than P_2 ; or
 - (ii) P_1 is less overinformative to Q in $J_{x,i}$ than P_2 ; or
 - (iii) P_1 and P_2 are equivalent in $J_{x,i}$ and P_1 is a more standard answer to Q than P_2

Clause (45)(i) correctly predicts that a proposition that gives a complete answer is a better answer than one that gives a properly partial one, if it is any good at all, i.e. if it gives a true answer. Complete answers are the most informative ones.³

Clause (45)(ii) requires a proposition not to give more information than the question asks. For example, suppose that $J_{x,i}$ contains no information about ϕ , or about ψ . Let the question be whether ϕ . Then (45) predicts that the proposition that ϕ is a better answer than the proposition that (ϕ and ψ). Both are complete answers, and therefore, that ϕ is not more informative than that (ϕ and ψ). But the former is weaker in $J_{x,i}$ than the latter, and therefore less overinformative. (Notice that that ϕ would be a better answer than the possible indirect answer that (ϕ or ψ), since it is more informative in this situation.)

However, if the proposition that ϕ is already contained in $J_{x,i}$, then that ϕ is no longer weaker, but equivalent with that (ϕ and ψ) in $J_{x,i}$. But clause (45)(ii) decides between the two, even in this situation. Both propositions are complete answers to whether ϕ in I , but that ϕ is weaker in I than that (ϕ and ψ), and hence a more standard answer, and therefore a better answer.

To give another example, suppose $J_{x,i}$ contains the information that not- ψ . Then, the proposition that ϕ and the

proposition that (ϕ or ψ) are equivalent in $J_{x,i}$, but that ϕ is a more standard answer to whether ϕ , since it is more informative in I to whether ϕ , and therefore a better answer to this question. Of course, this does not mean that the proposition that (ϕ or ψ) could never be a good answer in this situation. It would be for example, if the one who answers the question is simply not able to express the proposition that ϕ sincerely. The proposition that ϕ may simply not be available as a good answer.

A natural question that arises, is whether in a given set of available good answers, there always is a best one. It can be proved that in a sense this is the case. But only if we make two assumptions. The first is that if two propositions P_1 and P_2 are available, their conjunction $P_1 \cap P_2$ and their disjunction $P_1 \cup P_2$ are available as well. The second assumption is that $J_{x,i}$ is an epistemic set. Then we can prove the following:⁴

- (46) Let Q be a question in $J_{x,i}$, $J_{x,i}$ an epistemic set, and P_1, P_2 different (partial) answers to Q in $J_{x,i}$, then either
- (i) P_1 is a better answer to Q in $J_{x,i}$ than P_2 ; or
 - (ii) P_2 is a better answer to Q in $J_{x,i}$ than P_1 ; or
 - (iii) $P_1 \cap P_2$ is a good answer to Q in $J_{x,i}$ and a better answer to Q in $J_{x,i}$ than both P_1 and P_2 ; or
 - (iv) $P_1 \cup P_2$ is a good answer to Q in $J_{x,i}$ and a better answer to Q in $J_{x,i}$ than both P_1 and P_2

9. Correctness of question-answering

We have called the conditions given above conditions of relation, quality and quantity. This should remind one of the corresponding Gricean maxims. Conditions like these may be expected to form the core of an explication of the notion of a correct answer, of an answer in accordance with the Gricean maxims. Such a notion of correctness can be formulated informally as follows:

- (47) If x has a question Q , then y gives a correct answer to Q for x in expressing P iff y believes that P gives a good answer to Q for x and that there is no P' available such that P' gives a better answer to Q for x than P

Clearly, the notions of a good, and of a better answer, figure essentially in this definition. But it reflects the subjective, speaker-oriented, nature of the Gricean maxims. Therefore, it relates the notions of a good and of a better answer, which themselves are pragmatic in that they pertain to the information of the questioner, to the information of the one who is answering the question. Thus, a formalization of (47) essentially involves a representation of information about information. We will not attempt such an analysis of information here, the elaborations this would involve go beyond the scope of the present paper. But it may be noted that the subjective correctness notion is based upon the notion of a proposition giving a good answer to a question in an information set, and upon that of one proposition giving a better answer than another. And these notions are defined

by the conditions stated above.

A closer look at (47) should reveal further that it refers to expressible and available propositions, i.e. that it refers to language. Throughout this paper we have been talking about questions and answers not as linguistic, but as semantic, modeltheoretic objects. But if we come to consider effective question-answering in speech situations, language becomes all important again. A certain proposition may be a good answer, it may even be the best one there is, but this is of little use if we are not able to express it adequately. In determining what the best answer to a question is, we are always dealing with a certain subset of the totality of all true partial pragmatic answers. Roughly, this set contains those propositions which the one who answers the question is able to express linguistically in such a way that the questioner's interpretation of this linguistic expression is a proposition that gives her a true partial pragmatic answer.

The restriction to adequately expressible propositions is highly relevant. The notion of giving a better answer strongly favours semantic answers. This is due to condition (45)(iii). In fact, if we consider all true partial answers to a question, the true semantic answer will obviously be the best one. (And if it is too strong to be given vis à vis the quality maxim, disjunctions of semantic answers will come into play.) But if semantic answers are to be expressed, we need, among other things, semantically rigid designators. And as we noted quite at the outset in section 2, such rigid designators may not be available in the language. And even when they are, they may not be available to the speech participants in the sense that they may not be, or may not be expected to be, rigid in the information of questioner or questionee⁵. A semantically rigid designator may fail to pick out a unique denotation with respect to a certain information set, whereas at the same time a semantically non-rigid expression may do so, by being pragmatically rigid with respect to that set. Obviously, in such a situation the

latter kind of expression gives better means to express a pragmatic answer.

The restriction to adequately expressible propositions, which (47) makes, is very realistic in predicting that semantic answers are not always the best ones available. So, the theory of pragmatic answers developed in this paper loses none of whatever usefulness it may have, by the fact that ideally semantic answers tend to be the best ones. In fact, that under completely ideal circumstances, which include having a complete, perfect language, being a perfect language user, a perfect logician, and a walking encyclopedia, semantic answers are the best ones, may be viewed as a merit of the present theory. For it correctly links the existence and function of pragmatic answers to their proper source: the human condition.

Notes

- * We would like to thank Peter van Emde Boas for his stimulating criticism made during and after an oral presentation of the material of this paper, and Theo M.V. Janssen and Fred Landman for their valuable comments and criticism on an earlier, more elaborate version.
1. An analysis of the relation between linguistic answers and constituent interrogatives makes use of the property or relation in which the latter are based. See See G & S (1984) for details. There the theory developed in this paper is applied to linguistic interrogatives-answer pairs.
 2. These constraints are familiar from epistemic logic. More constraints would have to be added once we want to deal with information of one individual about information of another, and with consciousness of one's own information state.
 3. Notice that we will need the maxim of Manner to help decide between equivalent sentences, since in this framework they express the same proposition.
 4. For a proof see G & S (1984), appendix 2.
 5. This presupposes that accessibility relations play a role in defining rigid designation. In a model without them, semantic rigidity would imply pragmatic rigidity.

References

- Belnap. N., 'Approaches to the Semantics of Questions in Natural Language, part I', unpublished manuscript. University of Pittsburgh, 1981.
- Groenendijk, J. and M. Stokhof, 'Semantic Analysis of wh-complements', Linguistics and Philosophy, 5, 1982.
- Groenendijk, J. and M. Stokhof, 'Questions and Linguistic Answers', ms., Amsterdam, 1984.
- Hintikka, J., 'Questions about Questions', in M.K. Munitz & P. Unger (eds.), Semantics and Philosophy, New York, 1974.
- Hintikka, J., The Semantics of Questions and the Questions of Semantics, Amsterdam (= Acta Philosophica Fennica 28, 4), 1976.
- Hintikka, J., 'Answers to Questions', in H. Hiz (ed.), Questions, Dordrecht, 1978.

V

QUESTIONS AND LINGUISTIC ANSWERS

CONTENTS

0. Introduction	253
1. Questions and interrogatives	260
2. Linguistic answers	269
2.0 Introduction	269
2.1 Constituent answers	270
2.2 Sentential answers and exhaustiveness	273
2.3 Answers, questions and abstracts	278
2.4 Conclusion	283
3. Semantics of linguistic answers	287
3.0 Introduction	287
3.1 Single constituent interrogatives	289
3.1.1 The rule	289
3.1.2 Exhaustiveness	294
3.1.3 Exhaustiveness and plurality	301
3.1.4 An example	307
3.2 Multiple constituent interrogatives	310
3.2.1 Multiple terms	311
3.2.2 Exhaustiveness of multiple terms	315
3.2.3 The general rule	317
3.3 Sentential interrogatives	320
3.3.1 Zero-constituent interrogatives	320
3.3.2 Yes and No	321
3.3.3 Exhaustiveness, the limit	323
3.3.4 Qualified answers	328
3.3.5 Negative sentential interrogatives	331
4. Answers and answerhood	335
4.0 Introduction	335
4.1 Semantic notions of answerhood	336
4.2 Answers and semantic answerhood	341
4.3 Pragmatic notions of answerhood	350
4.4 Answers and pragmatic answerhood	357
4.5 Multiple and zero-constituent answers	363
5. Exhaustiveness and pragmatics	368
Appendix 1. Specificity revisited	373
Appendix 2. Answers compared, a topic in logical pragmatics	378
Notes	391
References	436

0. Introduction

Interrogative-answer pairs are of special interest to any theory which aims to model natural language interpretation. There are abundantly many reasons for this, most of which rather have the looks of a cliché, we are afraid. (But then, isn't a cliché a cliché because of its very truth?) Few would like to challenge that natural language is first and foremost a system of human communication. And hardly more controversial is the claim that language is a pretty successful means to exchange information. Even those who never get tired to stress the multitude of functions linguistic utterances can fulfill, will have to admit that the informative use is prominent among them.

The informative use of language is intimately linked to question answering. One might even go as far as to say that it is all there is to it. One might argue that there really is no separable assertoric use of language, that there is no way to get even close to understanding the way in which indicatives function if they are viewed in isolation. Whenever one tries to describe how something functions, one finds oneself looking for its goal or purpose. In this case we don't have to look very far. The main purpose of the assertoric use of sentences is to convey information. If an assertion succeeds in this, it answers a question. And this no matter whether or not such a question was actually posed, for example (for there might be other ways to do so) by the utterance of an interrogative sentence by the one to whom the assertion was addressed.¹

As a matter of fact, this perspective is what drove us to the study of questions. Our original interest was what we called 'epistemic pragmatics', an analysis of the role of

information in language use. The analysis aimed at was a logical one, and maybe for that reason tended to focus on the assertoric use of sentences.

Part of that project was the formulation of conditions for the correct use of indicatives, conditions pertaining to the information of the speaker, not only his information about the world, but also, and equally important, his information about the information of the addressee. This task comes down to trying to arrive at a precise formulation of the Gricean Maxims of Relation, Quality, Quantity, and, more peripherally, Manner. To shortcut a long history, it proved inevitable to refer to questions in the formulation of, first and foremost, the Maxim of Relation. And it turned out that the Maxim of Quantity has to seek a delicate balance between on the one hand requiring an utterance to be maximally informative, and on the other hand requiring it not to be unnecessarily overinformative, a balance which is almost impossible to find if we don't assume an assertion to take place against the background of a certain implicit or explicit question.²

This being so, a pragmatic analysis of assertions calls for an analysis of questions. And if the analysis aimed at is to be a logical one, we need a logic of questions, or, turning the medal, a semantics of interrogative sentences.

To those dedicated to logical semantics, interrogatives and answers are an outstanding challenge. It has often been put forward, not only by notorious adversaries of a logical approach to language, but also by such eminences grises in the field as Frege and the author of the *Tractatus*, that the variety of uses to which language can be put in principle lies outside the realm of logic.³ Logic is preoccupied with the notions of truth and truth conditions of sentences so deeply, so the argument seems to go, that it is hardly to be expected that it will have anything of interest to say about non-descriptive sentences, or the non-descriptive use of sentences.

This puts a heavy burden on the logical semanticists approach to natural language. To be sure, logical semantics

is bound to have its explanatory limits, that is nothing to get worried or excited about. There is more in between natural language and its interpretation than semantics will ever be able to reveal. But then, there isn't only semantics, there is syntax, pragmatics, and lexical semantics as well. (And you might go on adding your own favourites.) But it can not be denied that if logical semantics is to be a viable enterprise at all, it should be able to ascribe wellbehaved semantic objects not only to indicative sentences, but, for a start, to interrogatives as well. It just will not do to ignore questions. Semantics is to be a semantics of both interrogatives and indicatives, or else it is not to be.

For this and maybe other reasons as well, there has been a lively interest in the logic of questions throughout the years.⁴ But, if we may say so, with marginal success as far as natural language semantics is concerned. Perhaps under the influence of the success of modal logic and other intensional logics, most modern approaches try to deal with interrogatives by adding special operators, or by using imperative and/or epistemic operators that already have been added, to standard logical languages.⁵

This is not the place to describe the history of so-called 'erotetic logic'. It has certainly left us a load of interesting problems and results, but it never succeeded in arriving at a proposal for the analysis of interrogatives in natural language that could enjoy acceptance by a larger part of the logical semanticists communion. As we see it, this misfortune is largely due to the failure to come up with a single and simple type of semantic object that can serve to be associated with the syntactic category of interrogative sentences. Preferably, such an object should not be something completely new and never heard of, but should stay within the limits of the by now familiar, and successful, intensional type theory.⁶ And further, and equally important, it should be such that it opens our eyes to new meta-notions which are of logical interest. A new step in semantics should offer a new outlook on the field of logic if it is really worthwhile. For the semantics of interroga-

tives this seems to require that it give rise to simple and logically wellbehaved notions of entailment between questions, and of answerhood as a relation between questions and assertions. And the stronger these notions cling to the trustworthy notion of logical consequence, the better it is.

Tichy may be honoured as the one who perhaps has propagated this view in its most pure form.⁷ Tichy's message is that the ordinary logical apparatus provides all the tools we need to deal with the logic and the semantics of interrogatives. To be sure, he doesn't mean standard predicate logic, but (his version of) intensional logic. More specifically, he argues that we need nothing besides our good old basic semantic objects: entities, truth values and indices; and no new ways of constructing more complex objects from these basic ones than the ones we are already familiar with.

In our opinion, all this is very true. However, we feel that Tichy pushes things too far in this direction. In the end, he gives interrogatives no privacy at all. In Tichy's view, every interrogative shares its logical analysis with an 'indicative expression', yes/no-interrogatives with indicative sentences, constituent interrogatives with predicative expressions. This deprives them of the right to form a homogeneous category, to which intuitively they are entitled. And, equally important, it bereaves them of their own identity. It makes no sense to turn interrogative sentences into truth value expressions, as Tichy does with yes/no-interrogatives.⁸ One has heard it say too many times that interrogatives don't have truth values, to embrace a theory that tells us that after all they do. Maybe therefore the semanticists community is hesitant to accept Tichy's proposal, interesting though it may be, as its standard theory of the semantics of interrogatives and answers.

Tichy's analysis can also be used to illustrate a traditional feature of the logical approaches to questions we mentioned above. Not having made a semantic distinction between interrogatives and indicatives, there is no other way open to him than to keep them apart by seeking refuge in pragmatics (or, as in the old days, psychology). There is

no semantic difference between an indicative and the corresponding yes/no-interrogative. They both express a proposition and denote a truth value (they both contain a 'Gedanke', Frege said). The difference lies only in the concern or attitude the speaker has towards this proposition. These attitudes are of no concern to the logician or semanticist (they may be to the pragmaticist or psychologist), only their objects, propositions, are.⁹

A conservative mind may find this view on the matter attractive, it declares logic to be quite alright the way it is. To us it seems to rob logic and semantics of a subject to which it might have some interesting contributions to make. It is also quite likely to confirm the critics of logical semantics in their prejudice that logic will fall short to pay its debt to the study of non-assertoric uses of language.

Still, these are mainly objections of a more or less ideological nature. Fortunately, there is more to it. As an additional argument for his position, Tichy remarks that the difference between indicatives and interrogatives vanishes if they occur as complements embedded in sentences. Indeed, this were to be expected if the difference were merely one of psychological attitude. But the argument can easily be seen to be based upon a false premiss. If we are to take Tichy's word for it, to know whether something is the case is to be just the same as to know that it is the case. Well, if it actually is the case, yes, but if it is actually not the case, no. Then to know whether something is the case is to know that it is not the case.¹⁰

It is precisely when we look at wh-complements, indirect questions, that the semantic differences between indicatives and interrogatives come out in the open, at least, if we assume interrogatives and their accompanying complements to be intimates. Theories of interrogatives sharing Tichy's basic point of view (Hausser's work is a case in point) invariably lead to poor analyses of wh-complements.¹¹

We have tried to do better by working in the opposite direction. In G&S 1982 we investigated the semantics of

wh-complements. We hoped that starting out from questions as they occur embedded in indicatives, familiar ground for a semanticist, would lead us indirectly to a single uniform semantic object all kinds of interrogatives can be associated with. What we ended up with are propositional concepts.¹² Not any old propositional concept will do as a semantic object that can be expressed by an interrogative. Those that do can be shown to have special properties, and these we call questions. These properties assure that a question can be viewed as a partition of the set of indices.

In G&S 1984a we made ample use of this insight in defining notions of semantic and pragmatic answerhood. Being somewhat pretentious, that paper might be seen to typify the potential possibilities of a logical theory based on the notions of interrogative entailment and answerhood. Both kinds of notions can be seen to be intimately related to the standard logical notion of entailment between indicatives.

The main objective of this paper is to apply this semantic and pragmatic theory of questions and answerhood to natural language interrogatives and linguistic answers. The latter will be seen to have their own peculiarities. For the larger part, these reflect that answers essentially occur in the context of an interrogative. Characteristic answers, and among them we refuse to discriminate against either so-called 'short' or so-called 'long' answers, can be interpreted intelligibly only by relating them to the interpretation of the interrogative in the context of which they occur.

The present paper is organized as follows. In section 1 we give a quick sketch of how interrogatives can be derived and interpreted as expressing propositional concepts. The details of their analysis is left unargued for here. For the larger part this would have meant repeating what was already said in G&S 1982. Up to the point where wh-complements are treated as a kind of terms, what we have said there about the semantics of wh-complements applies to interrogatives in much the same way.

In section 2 we turn to the main topic. There we present a preliminary informal discussion of the nature of linguistic

answers. In section 3 we set ourselves to a more formal implementation of the outcome of this discussion. We first concentrate on answers to single constituent interrogatives, interrogatives with a single occurrence of a wh-term. Next we show that the treatment of multiple interrogatives and sentential (yes/no-) interrogatives is nothing but a straightforward generalization of the simple case. The notion of exhaustiveness, which also plays a predominant role in our analysis of wh-complements, and hence in that of interrogatives, will be seen to be of central importance in the analysis of linguistic answers just as well.

In section 4, we link our analysis of interrogative-answer pairs to the notions of semantic and pragmatic answerhood defined in G&S 1984a. It will be seen that there is a rather direct correspondence between these notions and semantic and pragmatic properties of linguistic answers.

In the final section 5, we deal with exhaustiveness again. The possibility is discussed of a pragmatic alternative for the semantic treatment of exhaustiveness of answers that is offered in section 3.

Two appendices have been added. Appendix 1 uses some notions defined in section 4 to give a pragmatic characterization of the distinction between specific and non-specific use of terms. Appendix 2 is also related to section 4, and deals with the topic of how to compare answers in quantitative respects.

It will be clear that this paper is closely linked to G&S 1982 and G&S 1984a. Though we tried to avoid repeating in great detail what was said there, we feel that the present paper can be read independently of those two others.

It was our strategy in writing this paper just to tell our own story in the main text and to use the notes to indicate where we follow or leave the steps of our predecessors. This has no other than stylistic reasons, and certainly is not to be taken to implicate that we underestimate their influence. On the contrary, we are well aware of how much we owe to the work of Hausser, Scha and Szabolcsi, to mention our main sources.

1. Questions and interrogatives

We use the term *question* to refer to modeltheoretic semantic objects. Syntactic objects that express questions are called *interrogative sentences*. This, much in the same way as the term *proposition* is used to refer to the kind of semantic objects that are expressed by *indicative sentences*. Questions are a special kind of propositional concepts. A proposition is an object of type $\langle s, t \rangle$, it is the characteristic function of a set of indices, a subset of the total set of indices I . A propositional concept is an object of type $\langle s, \langle s, t \rangle \rangle$, a function from indices to propositions, or equivalently, a relation between indices. As we shall see, it lies in the nature of questions that they always correspond to equivalence relations on I .

Since questions and propositions are different kinds of semantic objects, and since the former are expressed by interrogatives and the latter by indicatives, interrogative and indicative sentences belong to different syntactic categories. An indicative is an expression of category S , the corresponding semantic type $f(S) = t$, the type of truth values. Indicatives denote a truth value and express a proposition. An interrogative is an expression of category \bar{S} , the corresponding semantic type $f(\bar{S}) = \langle s, t \rangle$, the type of propositions. Interrogatives denote a proposition and express a propositional concept, a question.

The proposition denoted by an interrogative at an index is the proposition an indicative should express in order to be the true and complete semantic answer at that index to the question expressed by the interrogative. This is how interrogatives and indicatives, questions and propositions, are semantically related to each other. The sense or

meaning of an interrogative is the function which tells us for each index which proposition is the true and complete semantic answer at that index. Its answerhood conditions constitute the meaning of an interrogative.¹³

There are different kinds of interrogatives. There are sentential (yes/no-) interrogatives such as (1) and there are constituent interrogatives. Among the latter we distinguish between single constituent interrogatives such as (2), and multiple constituent interrogatives such as (3).

- (1) Does John love Mary?
- (2) Whom does John love?
- (3) Which man loves which woman?

We can speak more generally of n -constituent interrogatives, singles being 1-constituent interrogatives and multiples being n -constituent interrogatives for $n > 1$. In fact, it will prove to be quite handy to view sentential interrogatives as 0-constituent ones.

Though these are different kinds of interrogatives, they all belong to the same syntactic category \bar{S} , since they all express questions. Their syntactic derivation, however, differs in that they are derived from expressions belonging to different syntactic categories. A sentential interrogative such as (1) is derived from a sentence, an S -expression. A single constituent interrogative such as (2) is derived from an expression expressing a property, in this case the property of being loved by John. A multiple such as (3) is derived from an expression expressing a relation, in this case the relation of loving restricted to men for its first and to women for its second argument. In general, an n -constituent interrogative is derived from an expression expressing an n -place relation, since propositions can be viewed as 0-place relations between individuals.¹⁴

The syntactic categories of the expressions from which interrogatives are derived, we call the categories of *abstracts*, AB's. Abstracts form a family of categories. The members of the family are identified by their number of

places. There are n -place abstracts, AB^n 's, for $n \geq 0$, their categorial definition runs as follows:¹⁵

$$(AB) \quad AB^0 = S \\ AB^{n+1} = AB^n/e, \text{ for } n \geq 0$$

So, given the usual category-type assignment, an expression of category AB^n will express an n -place relation between individuals.¹⁶

Interrogatives are derived from abstracts, and these in their turn are derived stepwise. An n -place abstract is derived from an $(n-1)$ -place abstract, where the latter is to contain a syntactic variable PRO_k . The syntactic process is one of replacing the variable by a 'wh-term'. The corresponding semantic operation is that of binding a variable by λ -abstraction. (And this is precisely why abstracts are called abstracts.) So-called wh-terms are not really terms. They are best viewed as syncategorematic expressions, just as their logical counterparts, abstraction signs λx , are.¹⁷

From this general picture of the way in which interrogatives are derived, we can conclude that there are basically two rules involved. The first is an abstract formation rule, forming AB^{n+1} 's from AB^n 's. The second is an interrogative formation rule, forming \bar{S} 's from AB^n 's. Of course, each rule will consist of a syntactic and a semantic part. Since syntax is not our concern here, we will not take the trouble to specify syntactic operations. Our semantic theory is intended to be a general one. Where we use English phrases, one should be able to replace them by corresponding phrases from different languages without affecting what we say about semantics.¹⁸ The semantic rules are formulated as translation rules from the object language to the language of two-sorted type theory $Ty2$.¹⁹

The first rule, the rule of abstract formation, reads as follows:

(S:AB) If β is an AB^n , $n \geq 0$, and β contains one or more occurrences of PRO_k ; and if α is a wh-term who or which δ , where δ is a CN, then $F_{AB,k}(\alpha, \beta)$ is an AB^{n+1} .

(T:AB) If β translates as β' , and α as α' , then $F_{AB,k}(\alpha, \beta)$ translates as $\lambda x_k \beta'$ if α is who, and translates as $\lambda x_k [\delta'] \beta'$ if α is which δ and δ translates as δ' .

The task that the syntactic function $F_{AB,k}$ is to perform is to replace one of the occurrences of the syntactic variable PRO_k by a wh-term, and to anaphorize other occurrences. The syntactic operation of abstract formation need not be a uniform syntactic process in all cases, for all $n \geq 0$, in all languages. In G&S 1982 the rule was divided into four separate rules. In section 4 of that paper, we stated in some detail the content of the syntax of abstract formation in English. In that language, but not in all, there is a significant syntactic difference between the formation of AB^1 's and AB 's with more than one place. One of the wh-terms that is introduced is not simply substituted for an occurrence of the syntactic variable, but it is also preposed. By repeated application of (S:AB) to form abstracts with two or more places, other wh-terms that are introduced are simply substituted for one of the occurrences of a syntactic variable.²⁰

Besides this, there are all sorts of other syntactic phenomena that have to be taken care of, many of them being language specific. The motivation behind presenting abstract formation as a single rule here is that it corresponds to a single semantic operation in all cases. As the translation rule reveals, this semantic operation is that of binding a variable by λ -abstraction, where if the wh-term contains a

common noun phrase, abstraction is restricted to the set of individuals denoted by the noun. The semantic interpretation of restricted λ -abstracts $\lambda x[\alpha]\beta$ is defined in section 3.7 of G&S 1982.

Let us illustrate the rule of abstract formation by giving two examples. The AB^1 (5), underlying the single constituent interrogative (2), is derived from the open sentence (4), which is an AB^0 , since according to definition (AB) $AB^0 = S$.

- (4) John loves PRO_1
 (4') $\text{love}(a)(j, x_1)$
 (5) whom John loves
 (5') $\lambda x_1[\text{love}(a)(j, x_1)]$

The result of applying $F_{AB,1}$ to (4) and the wh-term who is that PRO_1 is replaced by the wh-term, inheriting its case, and is put in front position. The translation (5') of (5) expresses the property of being loved by John. It is obtained from the translation (4') of (4) by binding the free variable x_1 in (4') by λ -abstraction.

The AB^2 underlying the two-constituent interrogative (3) is derived in two steps from the open sentence (6), translating as (6'):

- (6) PRO_1 loves PRO_2
 (6') $\text{love}(a)(x_1, x_2)$

First we form the AB^1 (7) from (6) and the wh-term which woman, translating as the restricted λ -abstract (7'), which is equivalent to the more familiar looking (7''):

- (7) PRO_1 loves which woman
 (7') $\lambda x_2[\text{woman}(a)][\text{love}(a)(x_1, x_2)]$
 (7'') $\lambda x_2[\text{woman}(a)(x_2) \wedge \text{love}(a)(x_1, x_2)]$

According to its translation, the AB^1 (7) expresses the property of being a woman and being loved by the individual

assigned to the variable x_1 .

By a second application of the rule of abstract formation, we form the AB^2 (8) from the AB^1 (7), translating as (8'), which is again equivalent to (8''):

(8) which man loves which woman

(8') $\lambda x_1 [\text{man}(a)] [\lambda x_2 [\text{woman}(a)(x_2) \wedge \text{love}(a)(x_1, x_2)]]$

(8'') $\lambda x_1 \lambda x_2 [\text{man}(a)(x_1) \wedge \text{woman}(a)(x_2) \wedge \text{love}(a)(x_1, x_2)]$

From its translation, we can see that the two-place abstract (8) denotes the set of pairs of individuals $\langle x, y \rangle$ such that x is a man, y is a woman and x loves y . I.e. it expresses the relation of loving restricted to men for its first and to women for its second argument.

The second and last rule we need is the rule of interrogative formation, which reads as follows:

(S:I) If β is an AB^n , $n \geq 0$, then $F_I(\beta)$ is an \bar{S}

(T:I) If β translates as β' , then $F_I(\beta)$ translates as

$\lambda i [\beta' = (\lambda a \beta')(i)]$

In this case too, the syntactic function F_I may have to perform different syntactic operations for different cases in different languages. In particular, this may hold for $n=0$ on the one hand, in which case F_I produces sentential interrogatives from AB^0 's, i.e. S's, and for $n \geq 1$ on the other hand, in which case F_I produces constituent interrogatives. For English, the main thing F_I should accomplish is to give abstracts the characteristic word order of interrogative sentences. For other languages, other syntactic aspects may need to be taken care of.

The semantic operation that corresponds to the syntactic function F_I can be characterized as follows. When applied to an n -place relation, it yields a proposition, i.e. the characteristic function of a set of indices. This set contains all and only those indices at which the denotation of the input relation is the same as at the actual index, the

index assigned to the index variable a . In other words, such a proposition will give a rigid and exhaustive specification of the actual denotation of the relation, a specification that counts as the true and complete semantic answer to the question expressed by the output interrogative. Such a proposition is what an interrogative denotes at a certain index. Its sense or meaning determines such a proposition for each index. This kind of propositional concept is what an interrogative expresses. It is a relation between indices which holds between two indices iff the denotation of the input n -place relation between individuals is the same set of n -tuples of individuals at both of them. In case $n=0$, i.e. if we are dealing with sentential interrogatives, the input is a proposition. The interpretation then boils down to the following: the proposition denoted by a sentential interrogative is that set of indices where the truth value of the input sentence is the same as at the actual index. It is the proposition expressed by the input sentence if that sentence is actually true, it is the proposition expressed by its negation if it is actually false.²¹

Let us illustrate the rule of interrogative formation by considering the examples (1) - (3) given above. The sentential interrogative (1) is formed from the indicative (9). The translation rule turns the translation (9') of the indicative into the translation (1') of the interrogative:

- (9) John loves Mary.
 (9') $\text{love}(a)(j,m)$
 (1) Does John love Mary?
 (1') $\lambda i[\text{love}(a)(j,m) = \text{love}(i)(j,m)]$

The translation (1') is an expression of type $\langle s,t \rangle$. It denotes a proposition, the characteristic function of the set of indices at which John loves Mary iff he loves her at the actual index assigned to a . I.e. it is the proposition that John loves Mary in case he actually does love her, and it is the proposition that John doesn't love Mary in case he

actually does not love her. The intension or meaning of (1) is represented by (10):

$$(10) \lambda a \lambda i [\text{love}(a)(j,m) = \text{love}(i)(j,m)]$$

The expression (10) is of type $\langle s, \langle s, t \rangle \rangle$, it denotes a propositional concept. It is that function from indices to propositions which when applied to an index at which John loves Mary yields the proposition that he loves Mary, and when applied to an index at which he does not love Mary yields the proposition that he doesn't love her. So, indeed, the intension or meaning of (1) is the function which tells us for each index which proposition counts as a complete true answer to the question expressed by the interrogative.

The single constituent interrogative (2) is formed from the AB^1 (5), and is translated as (2'):

(2) Whom does John love?

$$(2') \lambda i [\lambda x_1 [\text{love}(a)(j, x_1) = \lambda x_1 [\text{love}(i)(j, x_1)]]]$$

According to its translation, the interrogative (2) denotes the characteristic function of the set of indices at which John loves the same individuals as at the actual index. I.e. it denotes the proposition that gives an exhaustive specification of the individuals that John loves. Such a proposition would indeed have to be expressed by a complete true answer to the question expressed by (1). The question is the function from indices to such specifications of the individuals John loves. I.e. it presents the answerhood conditions for the interrogative. It gives us for each index the proposition that is to be expressed by a complete true answer at that index.

The two-constituent interrogative (3) is formed from the AB^2 (8), and it translates as (3').

(3) Which man loves which woman?

$$(3') \lambda i [\lambda x_1 \lambda x_2 [\text{man}(a)(x_1) \wedge \text{woman}(a)(x_2) \wedge \text{love}(a)(x_1, x_2)] = \lambda x_1 \lambda x_2 [\text{man}(i)(x_1) \wedge \text{woman}(i)(x_2) \wedge \text{love}(i)(x_1, x_2)]]]$$

According to its translation, the interrogative (3) denotes the proposition that gives an exhaustive specification of the pairs of individuals $\langle x, y \rangle$ such that x is a man and y is a woman and x loves y . Its meaning, the question it expresses, determines such a proposition for each index.

From the general description of what interrogatives express according to our rules, it will be clear that they do indeed express a special kind of propositional concepts. An interrogative derived from an abstract expresses that relation between indices which holds between two of them iff the denotation of the abstract is the same at each of them. Such a relation is reflexive, symmetric and transitive, i.e. it is an equivalence relation on the set of indices. An equivalence relation on a set corresponds to a partition of that set. So, a question can also be viewed as a partition of the set of indices. This view of questions was extensively used in G&S 1984a in defining semantic and pragmatic notions of answerhood. It will be put to that same use again in section 4 of the present paper.

This much will have to do for an explanation of our analysis of interrogatives. There are many points at which it is in need of further discussion and elaboration. To mention only two, we have hardly paid any attention here to syntax at all, and we have restricted ourselves to a very limited class of interrogative sentences, containing only one particular kind of wh-words. (The kind of interrogatives dealt with here are quite as restricted in scope as the kind of indicatives that are dealt with in standard predicate logic.) We feel that in the context of the present paper, these limitations are justified. Here, our interest lies in semantics, and our main topic is to show how our analysis of interrogatives fits in with an analysis of linguistic answers. Further elaboration of our theory of interrogatives will only be worth its while once it has been established for relatively simple cases that it can be dovetailed with a theory of linguistic answers in an interesting way.

2. Linguistics answers

2.0. Introduction

Questions are modeltheoretic, semantic objects that can serve as the interpretation of interrogative sentences. The notion of answerhood is of a different nature. Unlike questions, answers cannot be isolated as just a special kind of semantic objects. Answerhood is essentially a relation. Semantically speaking, it is a relation between a question and a proposition. If we view propositions and questions as first order objects, answerhood is a second order notion, so to speak. It is a relation that may, or may not, hold between a particular proposition and a particular question. A proposition may be, or may fail to be, an answer to a particular question.

In the previous section we have seen that the notion of a question itself already characterizes a notion of answerhood: a proposition P is a semantic answer to a question Q iff for some index i , P is the extension of Q at i . This notion is a highly restrictive one.²² For every question, there is at an index only one proposition that counts as the true answer to that question at that index. This may seem to be at odds with the obvious fact that in actual speech situations there may be many different ways of providing the information a questioner asks for by uttering an interrogative. This might even be taken to expose a serious flaw in our treatment of the semantics of interrogatives.

Fortunately, this is not so. On the contrary, in G&S 1984a we have shown how pragmatic notions of answerhood can be defined that explain why in actual speech situations there

are, in principle, far more possibilities of answering a question than semantics suggests, if only one takes into account that question-answering relates to the information of the questioner. But no pragmatics without semantics! These pragmatic notions are strongly rooted in the semantic notion of answerhood that our interpretation of interrogatives inherently gives rise to. What will be said in section 4 of this paper about the relation between types of linguistic answers and the gamut of semantic and pragmatic notions of answerhood will highlight this important point.

In G&S 1984a we were concerned with defining notions of answerhood as relations between questions, propositions and information. There we dealt with questions and propositions only as modeltheoretic, semantic objects. Of course, these objects were intended to serve as the interpretation of linguistic, syntactic objects: interrogative sentences and linguistic answers. The process of interpretation itself was not focussed upon in G&S 1984a, but it is the main topic of this paper. What we are interested in here is finding an interpretation procedure that relates a pair consisting of an interrogative and a linguistic answer to a pair consisting of a question and a proposition. We intend the output of such a process of interpretation to serve as the input for our theory of semantic and pragmatic answerhood.

The interpretation of the first element of interrogative-answer pairs was already presented in the previous section. The interpretation of the second element of such pairs is a complicated matter. For a start, linguistic answers come in two kinds. There are so-called 'short' answers, which we propose to call constituent answers, and there are 'long' answers, which we will call sentential answers.

2.1. Constituent answers

For interrogative-constituent answer pairs such as (1)-(3), there is the immediate problem that, taken in isolation, the constituents surfacing in constituent answers do not

express propositions:

- (1) Who walk in the garden? John and Mary.
- (2) Whom did John kiss? A girl and two boys.
- (3) Which boy kissed which girl? The tall boy, Mary; and the small boy the two redheads.

We take it that one thing is beyond doubt: semantically speaking, and maybe even more clearly pragmatically speaking, a potential answer is to be something that has a propositional nature. It is rather a truism to state that for anything to be a possible answer to a question, be it a linguistic utterance, a gesture, or any other kind of act, it should convey information. And information is essentially of a propositional nature.²³

Taking this into account, it is clear that all linguistic answers, including constituent answers, should be taken to express propositions. Assuming syntactic categories of expressions to correspond uniformly with the type of semantic objects they are interpreted as, this implies that constituent answers should be taken to belong to the category S, the same syntactic category as is assigned to ordinary indicative sentences. A constituent surfacing in a constituent answer, not being an S-expression, cannot as such, in isolation, serve as an answer.

Any theory of questions and answers that we know of, including those that strongly favour constituent answers as the basic kind of answers, implicitly or explicitly agrees with this. All theories that deal with constituent answers transform them into propositions in one way or other during the process of interpretation. And, as is to be expected, such a transformation is usually carried out by relating the interpretation of the constituent surfacing in the answer to the interpretation of the interrogative.²⁴ In principle, there is quite a variety of ways in which this process may be executed. We concentrate on the one which from a semanticists point of view is the most pure and direct one. It is schematically indicated in figure 1.

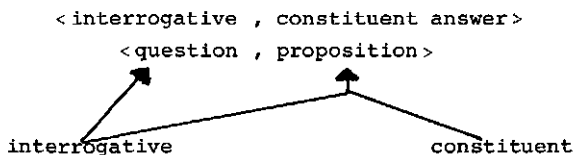

(fig.1)

According to the schema in figure 1, an interrogative-constituent answer pair is to be derived from an interrogative and a constituent. Its interpretation is a question-proposition pair. The question is the interpretation of the interrogative, the proposition expressed by the constituent answer is obtained by relating the interpretation of the input interrogative and the input constituent. What this brings to light is that the interpretation of a constituent answer is essentially context-dependent, it expresses a proposition in the context of a certain interrogative.

To distinguish constituent answers from the constituents surfacing in them, we write the former as a constituent with a full stop. This is to indicate that they are considered to belong to the same syntactic category as indicative sentences. Whereas the constituent John and Mary, a term conjunction, is of category T, the constituent answer John and Mary. is of category S, the category of syntactic objects expressing a proposition.

It need not be quite clear at the outset how the schema in figure 1 applies to multiple constituent interrogatives and their answers, such as example (3) above. On the face of it, it seems to say that the tall boy, Mary; and the small boy, the two redheads is the constituent on which the corresponding constituent answer is based. We will see that things can indeed be taken to be quite this way. The analysis of multiple constituent interrogatives and their answers will turn out to be a straightforward generalization of the simple case of single constituent interrogatives and answers.

2.2. Sentential answers and exhaustiveness

It might be believed -as those who take sentential answers to be the basic kind of answers tend to do- that things are much easier for constituent interrogative-sentential answer pairs. Sentential answers are full sentences, so they do express a proposition when taken in isolation. This being so, the interpretation schema presented in figure 2 would seem quite sufficient for sentential answers.

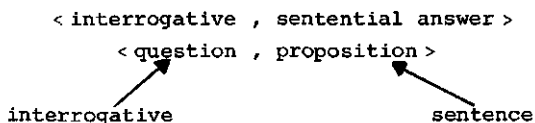

(fig.2)

We believe this simple picture to be an illusion, and in this we side with the constituent answer fans, without however wanting to join either of these two competing sides in their preference of one particular kind of answer to the other.²⁵ Even in interpreting sentential answers we need, in many cases, the context provided by the interrogative to be able to arrive at a proper interpretation. This is true, not only in the quite general sense in which almost any sentence in any discourse depends on the context for (part of) its interpretation, but also in a sense which is more or less specific for characteristic interrogative-sentential answer pairs. In some cases the simple schema of figure 2 may suffice, but for the most characteristic cases it does not.

To get to the point, the interpretation strategy of figure 2 will suffice if the sentential answer is explicitly exhaustive, as those in (4)-(6) are.

- (4) Who walk in the garden? Only John and Mary walk in the garden.
- (5) Whom did John kiss? John kissed a girl and two boys and no-one else.

- (6) Which boy kissed which girl? The tall boy kissed just Mary, and the small boy kissed only the two redheads, and no other boy kissed a girl.

It will not suffice, however, if the sentential answer is not explicitly exhaustive, as those in (7)-(9) are.

- (7) Who walk in the garden? John and Mary walk in the garden.
 (8) Whom did John kiss? John kissed a girl and two boys.
 (9) Which boy kissed which girl? The tall boy kissed Mary, and the small boy the two redheads.

However, we really can't prevent ourselves from believing that, though the answers in (4)-(6) are perfectly in order, the corresponding ones in (7)-(9) are much more characteristic. And, what may be more significant, in the context of the respective interrogatives the latter characteristically express the same proposition as the former. But, of course, interpreted in isolation the corresponding pairs of sentences are not equivalent at all. Those in (4)-(6) do imply those in (7)-(9) respectively, but not the other way around. Taken in isolation the interpretation of the indicative sentence in (7) is such that its truth is compatible with other people than John and Mary walking in the garden as well. But if someone who has to answer the question expressed by the interrogative in (7), wants to express that, as far as his information goes, there may be others that walk in the garden besides John and Mary, he cannot do so by using the indicative sentence in (7) as a linguistic answer. (Neither, by the way, can he use the constituent answer in (1).) He has to indicate explicitly the non-exhaustiveness of his answer. This he can do e.g. by using (10), (11), or (12).

- (10) John and Mary, for example, walk in the garden.
 (11) (I don't know, but) at least John and Mary walk in the garden.

- (12) John and Mary are among the ones that walk in the garden.

And, confusingly enough, (10)-(12) are logically equivalent to the indicative in (7) when the latter is interpreted in isolation. But in the context of the interrogative they are not. In that context the indicative in (7) is equivalent with the indicative in (4), or with the equivalent sentence (13).

- (13) John and Mary are the ones that walk in the garden.

The same point can be illustrated further by the fact that sentence (14) will receive a different interpretation if it is interpreted as a sentential answer to each of the questions expressed by the interrogatives (15)-(18).^{26,27}

- (14) John kissed Mary.
 (15) Who kissed Mary?
 (16) Whom did John kiss?
 (17) Who kissed whom?
 (18) What did John do?

The implicit exhaustiveness of (14) as an answer to each of (15)-(18) concerns different items in each case. More explicit paraphrases of the propositions expressed by (14) as an answer to (15)-(18) are (19)-(20) respectively.

- (19) John is the one who kissed Mary.
 (20) Mary is the one that John kissed.
 (21) The only one who kissed was John and the only one he kissed was Mary.
 (22) The thing that John did was kiss Mary.

No two of the sentence (19)-(22) are logically equivalent. For example, the truth of (19) is quite compatible with other girls being kissed by John, whereas (20) is not. And

the truth of (20) is quite compatible with Mary being kissed by other boys as well, but (19) contradicts this. And (21) implies both (19) and (20), but is not implied by either one of them. Sentence (21) illustrates clearly that the question expressed by (17) asks for an exhaustive specification of a certain relation. It also illustrates that explicit indication of exhaustiveness of the answer can become quite cumbersome and unnatural.

In fact, sentence (14) as an answer to (15)-(18) will carry a different intonation pattern in each case, that 'disambiguates' it. Using capitalization to indicate which element receives contrastive stress, these 'readings' can be represented as follows:

- (23) JOHN kissed Mary.
- (24) John kissed MARY.
- (25) JOHN kissed MARY.
- (26) John KISSED MARY.

The consequences of this are rather far-reaching. Up to this point one might still try to uphold that the interpretation schema in figure 2 is basically correct. One might try to argue that characteristic sentential answers can be interpreted in isolation if one treats focus as a semantic phenomenon.²⁸ Sentences in isolation may carry focus on one or more of their constituents, and focus semantically results in an exhaustive interpretation of the focussed constituent(s). A suitable characteristic interrogative-sentential answer pair would be one in which the focus of the answer matches the exhaustiveness the interrogative asks for. On this view there would be no need after all to use the interpretation of the interrogative in the interpretation of the sentential answer.

First, it should be noted that viewed in this way, focus cannot in all cases be located at individual constituents in the sentence. Sentence (25) as an answer to the question expressed by (17) illustrates this clearly. As an answer to (17), (25) expresses that John and Mary are the only pair of

individuals that stand in the kissing-relation. Sentence (25) does not mean that John is the only individual who kissed only Mary (where others might also have kissed others). So, as a suitable answer to (17) it are not the individual terms John and Mary that each carry focus, but it is the pair of these two expressions that carries focus as a single unit.

Second, and more important, this plea cannot help all sentential answers to escape from contextual interpretation. Consider the following example:

(27) Which man walks in the garden?

(28) John walks in the garden.

The point of this example is that if we assume that the term John carries focus in (28), the proposition that results if we follow the kind of semantic treatment of focus sketched above, is too exhaustive for the interrogative (27). What (27) asks for is an exhaustive listing of men that walk in the garden.²⁹ And the proposition expressed by (28) in the context of (27) has to be that John is the only man that walks in the garden. But assuming the term John to carry focus, and assuming focus to trigger exhaustiveness, would assign (28) the interpretation that only John walks in the garden, that John is the only person that walks there, if we don't mind the context the interrogative (27) provides.

This example does not provide an argument against a semantic treatment of focus, resulting in an exhaustive interpretation of focussed constituents. But it does provide a conclusive argument against the possibility to interpret characteristic sentential answers without relating them to the interrogative. One really needs the interpretation of the interrogative in order to arrive at the proper interpretation of sentential answers. And to be sure, this interpretation is an exhaustive one.

Exhaustiveness of answers was brought to the fore in discussing characteristic sentential answers. It was used to argue that not only constituent answers, but sentential answers as well, should receive their interpretation in the

context of the interrogative they serve to answer. But just as the latter fact applies to both kinds of answers, so does exhaustiveness. The interrogative-constituent answer pairs (1)-(3) in section 2.1 are fully equivalent to the corresponding interrogative-sentential answer pairs (7)-(9). We repeat one example of each:

- (1) Who walk in the garden? John and Mary.
 (7) Who walk in the garden? John and Mary walk in the garden.

Both in (1) and in (7) the answer expresses that John and Mary are the ones that walk in the garden. Both answers are implicitly exhaustive. All answers are taken to be exhaustive, unless they are explicitly marked as being non-exhaustive, or, and that is another possibility, if the non-linguistic context makes it perfectly obvious that the question itself is meant to be interpreted non-exhaustively. To repeat an example from G&S 1982,³⁰ if you're walking down the road in your home-town and an Italian tourist addresses you, asking:

- (29) Where can I buy an Italian newspaper?

you won't bore her citing a complete list of bookstalls and other places where Italian newspapers are sold. You just mention some place where she is likely to find one. And if you are a nice person you mention one that is not too far away and easy to find, and you won't try to be funny and answer "In Rome."

2.3. Answers, questions and abstracts

In section 2.1 we stated that constituent answers express propositions. And which propositions they express, depends on the interrogative in the context of which they appear. Further we saw in the previous section that something

similar holds for sentential answers, and we observed that both kinds of answers are in general implicitly exhaustive. Concentrating on constituent answers, and forgetting about exhaustiveness for the moment, the proposition they express should be obtained by relating the interpretation of the constituent surfacing in them, and the interpretation of the interrogative.

In this section we will show that in order to get this to work, it will not do to relate the interpretation of constituents to the final stage of development of interrogatives as expressing questions. We can't use the butterfly, we need the caterpillar, the intermediary stage of interrogatives as abstracts. As such they were seen, in section 1, to express properties or relations.

Suppose our domain of discourse consists of the five individuals John, Peter, Bill, Mary and Suzy. Suppose further that at the actual index John and Mary walk, whereas the other three do not. If the actual index is assigned to the index variable a by the assignment function g , this would mean that (30), the interpretation of the translation of the abstract (31), would be the characteristic function of the set {John, Mary}:

(30) $[\lambda x[\text{walk}(a)(x)]]_{M,g}$

(31) who walks

Analogously, (32), the interpretation of the translation of the abstract (33), would be the characteristic function of the set {Peter, Bill, Suzy}:

(32) $[\lambda x[\neg \text{walk}(a)(x)]]_{M,g}$

(33) who doesn't walk

At the \bar{S} -level the two interrogatives (34) and (35) translate as the expressions (36) and (37) respectively.

(34) Who walks?

(35) Who doesn't walk?

(36) $\lambda i[\lambda x[\text{walk}(a)(x)] = \lambda x[\text{walk}(i)(x)]]$

(37) $\lambda i[\lambda x[\neg \text{walk}(a)(x)] = \lambda x[\neg \text{walk}(i)(x)]]$

The interpretation of (36) is (the characteristic function of) the set of indices where the same individuals walk as at the actual index, i.e. in our example the indices where John and Mary are the ones that walk. The interpretation of (37) is (the characteristic function of) the set of indices where the same individuals do not walk as do not walk at the actual index, in our example the indices where Peter, Bill and Suzy are the ones that do not walk. If our domain remains constant at different indices, these two sets of indices, these two propositions, coincide. This means that the positive interrogative (34) and the negative interrogative (35) have the same denotation at the actual index. In fact, they have the same denotation no matter which index we care to choose as the actual one. Both interrogatives (34) and (35) will have the same denotation at each index, i.e. they express the same question.

But then, no matter how we try to transform constituent answers into propositions, if we do this in the context of either one of these two interrogatives interpreted as questions, one and the same constituent answer cannot but be transformed into one and the same proposition. But this is certainly wrong. In the context of (34), the constituent answer (38):

(38) John and Mary.

expresses the proposition that John and Mary are the ones that walk, whereas in the context of (35) the same answer expresses the quite different proposition that John and Mary are the ones that do not walk.

The source of this problem is that in the transition from abstract to interrogative, i.e. in the transition from relation to question, information is lost. Abstracts that express different relations, for example complementary ones as in our example, are sometimes turned into

interrogatives that express the same question.³¹

Other examples that do not concern complementary relations can be used to illustrate the same point. Any two interrogatives that are formed from abstracts which express rigid properties or relations, express the same question, viz. the constant function from indices to the tautology, i.e. the tautological question. Examples are (39) and (40).

(39) What is the sum of 5 and 7?

(40) What is the product of 5 and 7?

This is correct insofar as the true answers to any two such questions will always be logically equivalent (and logically valid). But true constituent answers may have to indicate different objects, in the examples the numbers 12 and 35 respectively.

And to give yet another example, suppose our set of indices is restricted to indices where the time difference between Amsterdam and Moscow is exactly as it is at our actual index. Then the two interrogatives (41) and (42) would express the same question.

(41) What time is it now in Amsterdam?

(42) What time is it now in Moscow?

But if the constituent answer (43)

(43) 5 p.m.

is a true answer to the first, it should be false as an answer to the second.³²

The conclusion must be that the correct input for the derivation of interrogative-constituent answer pairs, should not consist of an interrogative and a constituent, as the schema in figure 1 has it, but should consist of an abstract and a constituent. Only from the interpretations of these two expressions will it be possible to obtain the proposition expressed by a constituent answer.

At this point we want to stress that the argumentation presented above shows only that in order to assign the proper interpretation to answers we should relate the interpretation of the constituent surfacing in the answer to the interpretation of the abstract underlying the interrogative and not to the interpretation of the interrogative as such. The argumentation can not be used against interpreting interrogatives as questions.

Taking up the last example again, it is true that, given the assumption that the set of indices is restricted to those where the time difference between Amsterdam and Moscow is as it actually is, the two interrogatives (41) and (42) express the same question. Is that not counterintuitive? For the sentence (44) seems to answer the first of these interrogatives, but not the second.

(44) It is now 5 p.m. in Amsterdam

It would only answer the second interrogative as well if one knows that it is two hours later in Moscow than in Amsterdam. A simple calculation would then show that it is 7 p.m. now in Moscow. But, of course, this is precisely what our assumption takes care of! It implies that at every index the time difference between the two cities is two hours. And if this holds at every index, it holds a fortiori at every index that is compatible with what one knows. In a model satisfying our assumption, the sentences (44) and (45) are equivalent.

(45) It is now 7 p.m. in Moscow

But then one cannot fail to know the one if one knows the other. And this means that either one of these two sentences can serve equally well to answer either one of the two interrogatives.

So, rather than corrupting the interpretation of interrogatives as questions, this argumentation on the contrary supports it. If under our assumption the two answers (44)

and (45) are equivalent, the interrogatives better be equivalent as well.

Of course, there remains this itchy feeling. But it is caused by a disease possible world semantics suffers from. Possible world semantics makes it impossible to distinguish between there existing a necessary relation between the time in Amsterdam and the time in Moscow on the one hand, and the information one may have about the existence and content of this relationship on the other hand. And this disease is contagious. If possible world semantics has it this way, a semantic analysis of interrogatives carried out within that framework cannot fail to have it as well. Within the present context we need not worry about it. Once possible world semantics has been cured from this ailment, our semantics of interrogatives will be cured as well. Many doctors have already devoted themselves to finding a remedy for this ailment, and many medicines have been prescribed. Most of them do the patient a lot of good. But it is our feeling that only a major operation will bring final relief. But that is not the task we have set ourselves here.³³

2.4. Conclusion

A constituent answer such as (48), and the corresponding characteristic sentential answer (49), express the same proposition in the context of the interrogative (46), and they express the same proposition in the context of (47).

- (46) Who walks in the garden?
- (47) Which boy walks in the garden?
- (48) John.
- (49) John walks in the garden.

But the proposition expressed by (48) and (49) as answers to the question expressed by (46) is not the same as the one they express in the context of (47). The proposition expressed by an answer is to give an exhaustive specification

of the denotation of the abstract from which the interrogative is derived. As answers to (46), (48) and (49) say the same as (50). And as answers to (47), they say the same as (51).

(50) The one who walks in the garden is John.

(51) The boy who walks in the garden is John.

We need the interpretation of the abstract underlying an interrogative to obtain the proposition expressed by both kinds of answers in the context of that interrogative.

In a compositional semantic framework this means that abstracts have to take part in the derivation of answers. And by its side, the constituent surfacing in the constituent or sentential answer will feature in it as well. Together they can be seen to contain the syntactic material that is required to build both kinds of answers. And their interpretation was seen to be necessary to obtain the proposition these should express. Necessary, but not yet sufficient, since we also have to take care of exhaustiveness of characteristic answers. We cannot simply relate the interpretation of the abstract and the constituent. In the process of combining them, we have to apply a semantic operation that 'exhaustifies' the interpretation of the constituent.³⁴

Returning to our example, we have to apply a semantic operation of 'exhaustivization' to the interpretation of the term John, minimizing it, so to speak, to only John. If we relate the resulting exhaustive term interpretation to the property expressed by the abstract who walks in the garden (or which boy walks in the garden) we will indeed obtain the proposition that gives an exhaustive specification of the ones (or the boys) that walk in the garden.

Since the abstract also suffices to derive the interrogative, the abstract and the constituent together suffice as input for the derivation of interrogative-answer pairs.³⁵ This leads us to the general interpretation schema of interrogative-answer pairs in figure 3.³⁶

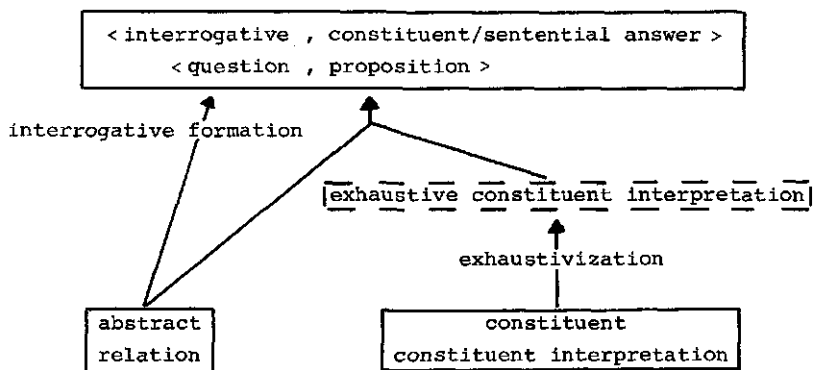

(fig.3)

The input is formed by an abstract, expressing a relation, and a constituent. The output is an interrogative-answer pair, where the answer is either a constituent one or a sentential one. Its interpretation is a question-proposition pair. The interrogative and its interpretation are obtained from the abstract and its interpretation by the process of interrogative formation presented in section 1. The answer and the proposition it expresses, are obtained by combining the abstract and its interpretation with the constituent, the interpretation of which has been subjected to a semantic process of exhaustivization.

Constituent answers and sentential answers are treated as variants of each other. They may differ in surface form, but they are derived and interpreted in much the same way. As was our purpose, the outcome of this process, a question and a proposition, are apt to serve as the input of our theory of semantic and pragmatic answerhood.

It is important to bear in mind that what are produced this way are a quite particular kind of interrogative-answer pairs, which we referred to most of the time as characteristic interrogative answer pairs. They certainly do not exhaust all possibilities. In principle any sentential expression

can serve as an answer. But it are these characteristic cases that deserve, and need, special attention.

3. Semantics of linguistic answers

3.0. Introduction

In this section, we discuss in more detail the derivation and interpretation of interrogative-answer pairs as it was schematically indicated in figure 3 in the previous section.

It is our aim to implement this schema in the grammar by transforming it into grammatical rules. We will end up with a single pair of rules, a syntactic rule that forms interrogative-answer pairs, and a corresponding semantic rule which translates such pairs of natural language expressions into pairs of expressions of a logical language. The latter are interpreted as a question and a proposition respectively, and thereby the former are indirectly interpreted as such as well.

We hasten to add that as far as syntax is concerned, the rule will be hardly less schematic than the schema we already presented. It is, first and foremost, semantics that we are interested in here. We will indicate to some extent what is involved in the syntactic process, but we will not explicate the syntactic functions we introduce for a particular natural language. Of course, since we embrace semantic compositionality as a methodological principle, our semantics will constrain syntax in certain ways. It imposes a certain kind of derivational structure on interrogatives and answers, but it also leaves open a great many syntactic details that can be treated in several different ways. Which way to choose may be decided upon for autonomous syntactic reasons. What we do have to stand for as natural language semanticists is that an intelligible syntax that meets the constraints set up by our semantics is feasible.³⁷

The single pair of rules we will propose is of a general nature. It applies to sentential and to single and multiple constituent interrogatives and deals with both constituent and sentential answers. It might well be that the syntactic functions involved differ widely for different instances, and that it would be more elegant to split up the one syntactic rule into several different (sub-) rules. But since in all cases a single and general semantic process is involved, there is no reason for such a division from a purely semantic point of view.

For expository reasons, however, we start out in section 3.1 with single constituent interrogatives and their answers. For the larger part, we will be concerned with giving content to the semantic operation of exhaustivization. For single constituent answers and their sentential comrades, this task is much the same as that of specifying the semantics of the term-modifier only. In section 3.1.2, we will discuss the impact exhaustivization has on different kinds of terms. In section 4, these will be seen to correspond nicely with different types of notions of answerhood. Making use of the generalized quantifier view on terms, we define a uniform semantic process of exhaustivization that is argued to give correct results in all cases, for all kinds of terms. It will come out in section 3.1.3, however, that the general applicability of this semantic process does require a theory of terms that really takes the semantic plurality of certain terms seriously, and does not neglect it, as those working on the theory of generalized quantifiers tend to do.

After having presented our analysis of single constituent interrogatives and their answers, we show in section 3.2 how it can be generalized straightforwardly to cover multiple constituent ones as well.

Although we originally developed our analysis for constituent interrogatives and their answers, it will turn out in section 3.3 that it fits short and long answers to sentential (yes/no-) interrogatives equally well. Their semantics is neatly covered by the same rule that applies to constituent interrogatives. Exhaustiveness plays a distinctive role

in this case as well. On the side, we get a quite natural explanation for the fact that natural language conditionals and disjunctions in many cases tend to get interpreted as biconditionals and exclusive disjunctions.

3.1. Single constituent interrogatives

3.1.1. The rule

Following the schema in figure 3, a single constituent interrogative-answer pair is to be derived syntactically from an abstract, in this case an AB^1 (one-place abstract), and a constituent, in this case a T (term). The derivation is to result in a pair of expressions: an interrogative, an \bar{S} ; and an answer, either a constituent or a sentential one, but in both cases an expression of category S. This is what can be said off-hand about the input and output categories of the expressions involved.

One half of the derivation, that of forming an interrogative from an abstract, was already presented in section 1. Concerning the other half, it can be noticed that the semantic types corresponding to the categories of the input expressions are such that we could use standard functional application as a way of combining their interpretations. The category AB^1 , defined as S/e , corresponds to the semantic type $\langle e, t \rangle$; the category T, defined as $S/(S/e)$, corresponds to the type $\langle \langle s, \langle e, t \rangle \rangle, t \rangle$.³⁸ If we apply a term translation to the intension of an AB^1 translation, the result is a truth value expression of type t. This is indeed the type that corresponds to the category S of indicatives, the category assigned to answers.

In this way, it could be accounted for quite directly that the interpretation of the answer depends on the interpretation of the abstract that forms the basis of the interpretation of the interrogative. But what is not yet accounted for is the exhaustiveness of the answer. If, again, we follow the schema in figure 3, this should be obtained by

first applying a semantic operation to the input term that has the semantic effect of exhaustivization, and after that using functional application to combine the interpretation of the abstract and the thus modified interpretation of the term to obtain a truth value expression.

This leads to the following pair of rules for the derivation and interpretation of single constituent interrogative-answer pairs.

(S:IA1) If β is an AB^1 , and α a T, then $\langle F_I(\beta), F_{CA1}(\alpha, \beta) \rangle$
and $\langle F_I(\beta), F_{SA1}(\alpha, \beta) \rangle$ is an $\langle \bar{S}, S \rangle$

(T:IA1) If β translates as β' , and α as α' , then both
 $\langle F_I(\beta), F_{CA1}(\alpha, \beta) \rangle$ and $\langle F_I(\beta), F_{SA1}(\alpha, \beta) \rangle$ translate
as $\langle \lambda i[\beta' = (\lambda a\beta')(i)], \text{exh}(\lambda a\alpha')(\lambda a\beta') \rangle$

From an abstract and a term, the syntactic rule (S:IA1) forms pairs of expressions consisting of an interrogative, an \bar{S} , followed by an answer, an S. The new category $\langle \bar{S}, S \rangle$ is introduced as an ad hoc notation for the syntactic category of such pairs. The rule forms both constituent answers and sentential ones as second elements of such pairs. The syntactic function F_{CA1} is to take care of the former and F_{SA1} of the latter. The function F_I was already introduced in section 1, it turns abstracts into interrogatives.

Constituent and sentential answers are treated as two syntactic options that receive the same semantic interpretation. Both $F_{CA1}(\alpha, \beta)$ and $F_{SA1}(\alpha, \beta)$ are translated as $\text{exh}(\lambda a\alpha')(\lambda a\beta')$. The translation of interrogative formation $F_I(\beta)$ was already explained in section 1. The logical expression exh is a logical constant of type $\langle \langle s, f(T) \rangle, f(T) \rangle$, i.e. when applied to the intension of a term translation, it delivers a term translation. Its interpretation is to take care of the exhaustivization of the term on which it operates. So, the type of the expression $\text{exh}(\lambda a\alpha')$ is $f(T)$, i.e. $\langle \langle s, \langle e, t \rangle \rangle, t \rangle$. Since $f(AB^1) = \langle e, t \rangle$, the type of $\lambda a\beta'$ will be $\langle s, \langle e, t \rangle \rangle$. So, the type of an answer translation $\text{exh}(\lambda a\alpha')(\lambda a\beta')$ is t. Both

kinds of answers express a proposition. Since the interrogative expresses a question, as we saw in section 1, the result of the translation procedure as a whole is a pair of logical formulas of which the first expresses a question and the second a proposition. And this is what we are after. These are the kinds of semantic objects that the notions of semantic and pragmatic answerhood defined in G&S 1984a apply to.

We will not state the workings of the syntactic functions introduced by the rule. We keep our promise and say very little about syntax here. What we have to say about F_I , the function forming interrogatives, we already said in section 1. So, we can confine ourselves to the answer functions F_{CA1} and F_{SA1} . Both take an abstract and a term as input. For the former, the syntactic role of the abstract is a limited one. Only the term will surface in a constituent answer. But, as we have argued for extensively in section 2, we really do need the abstract for its semantic interpretation as an answer. Still, even in this case, the abstract has some syntactic influence as well. E.g. the term surfacing in the answer is to be assigned case. And its case should be the same as that of the wh-term in the abstract. Similarly, in some cases prepositions (or pre-, in-, and affixes in certain languages) have to be added to the term to form the proper constituent answer. Compare:

- (1) Whom does Mary love? Him that always sends her flowers.
- (2) To whom did John give the book? To Mary.

The abstract can give the required syntactic material or information to be able to give a constituent answer its correct form.³⁹

But, of course, the abstract plays a far more important role in helping to form sentential answers. And it will indeed be far more complicated to state the content of the syntactic function F_{SA1} that is to achieve this. But at least, it seems that the term and abstract together contain (or can be made to contain) all the required syntactic

material and structural information to form the sentential answer. Largely oversimplifying matters, what F_{SA1} is to do is to replace the wh-term in the abstract by the input term. For a language such as English, where a wh-term is preposed, this means disconnecting the wh-term and filling in the input term in the empty position left by the preposed wh-term in the original sentential structure. And surely, all kinds of other details will further have to be taken care of, such as word order, case assignment and agreement with other elements in the resulting sentential structure.

A few global remarks about the nature of the syntactic and semantic objects that are defined by the rules (S:IA1) and (T:IA1) may be in order here. We described the output of the syntactic rule as interrogative-answer pairs, and their semantic interpretation as question-proposition pairs. In a sense, these objects are of a highly artificial nature. They cannot be viewed, at least not in a straightforward way, as the kind of objects one normally takes a grammar to produce.

A sentence grammar produces sentences. Among these there may be interrogative sentences and indicative sentences that superficially resemble the elements of the objects produced by our rule, but as pairs they are not produced by a sentence grammar. The important point is that a sentence grammar may be regarded as a model, in some sense of that word, of the way in which speech production or speech interpretation proceeds. And it are sentences, indicative, interrogative and otherwise, that are produced and interpreted. No-one will utter, or interpret, interrogative-answer pairs.

Proceeding from individual sentences to larger units, texts, does not change this in an essential way. Text-grammars model the production or interpretation of larger pieces of coherent discourse, such as occur in spoken or written language. Again, these may contain interrogatives and declaratives, but interrogative-answer pairs are not to be found among them.⁴⁰

What then are these objects, and what kind of grammar is the one that produces them? In order to shed some light on this question, let us review the reasons adduced above for

going about the matter in the way we do. Our objectives in this paper are two. First of all, we want to make clear that the theory of answerhood developed in G&S 1984a in an abstract and language independent way, can be applied to concrete linguistic expressions. And secondly, we want to show how an analysis of interrogatives based on the theory of wh-complements developed in G&S 1982, which is a propositional theory and which lays a heavy stress on the phenomenon of exhaustivity, can deal with non-sentential answers. In both cases, we need to consider interrogatives and answers, questions and propositions, in relation to each other. For the various notions of answerhood defined in G&S 1984a are all relational, and as we argued in section 2, non-sentential answers (and sentential ones too, for that matter) cannot be interpreted properly but in the context of an interrogative.

These facts are accounted for by letting our rules produce and interpret interrogatives and answer in relation, i.e. in pairs. The rules are satisfactory as far as the tasks we set ourselves are concerned, as the remainder of this paper is intended to show.

In view of these considerations, it seems that we must interpret interrogative-answer pairs in a rather abstract way, i.e. not as objects that may actually, as such, be found in speech production or interpretation, but rather as abstract objects that reflect certain properties of objects that do occur in everyday speech. Obviously, the normal situation is one in which a question is raised by one speaker and is answered by another. Neither of these two speech participants actually produces or interprets an interrogative-answer pair. But each one of them does something that is reflected in the way in which interrogative-answer pairs are handled by our rules. For obvious reasons, the production of an interrogative is not influenced by the answer that is going to be given to it, and neither is its interpretation. This is reflected in the rules by the fact that neither in the syntactic nor in the semantic rule the first element of the pair produced is affected in any way by the second. The production of an answer by another speaker, however, is

heavily influenced by his interpretation of the interrogative. And, in its turn, the interpretation of this answer by the questioner essentially depends on the meaning of his original interrogative as well. The fact that in our rules, an answer, be it a constituent or a sentential one, both syntactically and semantically depends on the form and interpretation of the interrogative reflects this.

Thus, our rules can be interpreted as embodying in one object two aspects of what goes on in a question-answer dialogue in two different speech participants. The one who answers uses the interrogative in producing his answer. And the one who asks the question uses it in interpreting the answer that he is offered.

In a sense, then, the rules that define interrogative-answer pairs may be said to be 'discourse grammar' rules, i.e. rules that could be part of a system that accounts for the structural syntactic and semantic properties of interactive discourses. To be sure, our rules deal with only a few aspects of only one elementary type of discourse. They govern more or less standard, strictly informative, question-answer dialogues between two speech participants. The 'discourses' they produce are of a highly artificial nature. Actual speech proceeds in far more intricate and delicate ways. But, nonetheless, we claim that they do reflect certain important properties of question answering, in particular the exhaustiveness of answers. Our rules permit us to investigate the consequences precisely, and it is thus, we believe, that studying rather abstract miniature dialogues of this kind will prove valuable once we proceed to tackle more natural and complicated ones.

3.1.2. Exhaustiveness

In this section, we turn to the interpretation of the semantic process of exhaustivization of the interpretation of terms. We will specify the semantic content of the logical expression exh that figures in rule (T:IA1) in the translation of

constituent and sentential answers.

To keep the exposition simple, we choose as our example the rather artificial, but simple interrogative sentence (3):

(3) Who walk(s)?

First of all, it can be observed that all kinds of terms can surface in constituent answers to the question expressed by (3), and the same holds, of course, for the corresponding sentential answers. In many cases, a proper name, or a conjunction of such names may be available that serves our purposes perfectly well. We then get answers like the following:

(4) (a) John.

(b) John walks.

(5) (a) John and Mary.

(b) John and Mary walk.

As we have seen, in the context of the interrogative (3), such answers purport to give an exhaustive specification of the individuals that actually walk. So, if the answer that (4) (a) and (b) provide is true, the set of walkers consists of exactly one individual, the individual John. And similarly, if (5) (a) and (b) provide a true answer, the set of walkers consists of exactly two individuals, the individuals John and Mary. (So, although taken in isolation, the truth of (5) (b) implies the truth of (4) (b), as answers to (3), they contradict each other.) In the context of (3), (4) (a) and (b), and (5) (a) and (b) express virtually the same as (4) (c) and (5) (c) respectively.⁴¹

(4) (c) Only John walks.

(5) (c) Only John and Mary walk.

In other words, the semantic content of exh can be verbalized as the term-modifier only in cases like these.

Using standard predicate logic for the moment, we can re-

present the answers in (4) and (5) in the context of (3) by the formulas (4)(d) and (5)(d) respectively:

(4)(d) $\forall x[\text{walk}(x) \leftrightarrow x = j]$

(5)(d) $\forall x[\text{walk}(x) \leftrightarrow [x = j \vee x = m]]$

But proper names do certainly not exhaust our linguistic means to answer questions. It might be quite appropriate to use a universally quantified term such as in (6):

(6)(a) Every boy.

(b) Every boy walks.

Such answers would convey the information that the set of walkers consists of all and only boys, that the set of walkers equals the set of boys. Again, this is not the same as (6)(b) expresses in isolation. The predicate logical formula representing the answers in (6) in the context of (3) is (6)(d), which again might be verbalized by using only as in (6)(c):⁴²

(6)(c) Only every boy walks.

(d) $\forall x[\text{walk}(x) \leftrightarrow \text{boy}(x)]$

It should be remarked that though (4), (5) and (6) are equally good answers from a purely syntactic point of view, and share the property of being characteristically interpreted exhaustively, they need not be equally good from a semantic or pragmatic perspective, i.e. as carriers of the information the question asks for. If (6) is a true answer, so would be a conjunction of all proper names of the boys in the domain of discourse.⁴³ If we consider rigidity to be a semantic property of proper names, such a conjunction of names would provide a semantically rigid answer, whereas the answers in (6) would not.⁴⁴

Such difference in potential semantic and pragmatic value between syntactically equally good linguistic answers is even more clear if we compare (4) - (6) with the answers in

the examples (7) and (8):

- (7) (a) John or Mary.
 (b) John or Mary walks.
- (8) (a) A girl.
 (b) A girl walks.

In general, if our question (3) is answered by (7) or (8), our question will still not be answered completely, but in many cases we will have come closer to an answer, our question will then be answered at least partially. From a syntactic point of view, such indefinite answers are quite in order. And, interestingly enough, they share the property of being characteristically interpreted exhaustively. In the context of the interrogative (3), the answers in (7) convey the information that precisely one individual walks, and that this individual is either John or Mary. This is what is expressed by the formula (7)(d), and what can be verbalized explicitly by means of (7)(c):

- (7)(c) Only John or Mary walks.
 (d) $\forall x[(\text{walk}(x) \leftrightarrow x = j) \vee (\text{walk}(x) \leftrightarrow x = m)]$

Notice that only can be distributed over the elements of a disjunction, but not over the elements of a conjunction. Sentence (7)(c) is equivalent with (9) and (10), but (5)(c) is not equivalent with (11):

- (9) Only John or only Mary walks.
 (10) Only John walks or only Mary walks.
 (11) Only John walks and only Mary walks.

In fact, sentence (11) is a contradiction.

Similarly, the answers in (8) say that exactly one individual walks and that this individual is a girl. The corresponding formula is (8)(d), it also represents the meaning of (8)(c):

(8)(c) Only a girl walks.

(d) $\exists x[\text{girl}(x) \wedge \forall y[\text{walk}(y) \leftrightarrow x=y]]$

Let us stick to these five examples for the moment, and try to use these sufficiently different cases to arrive at a proper interpretation of the process of exhaustivization. Though in the end we use an intensional logical framework, we still continue to use extensional logical representations for the moment. There is no harm in this, since intensionality is not essentially involved in the process of exhaustivization as such.

If one takes a quick superficial look at the formulas (4)(d) - (8)(d), it will seem hard to find a general compositional way to arrive at them. Using the examples given above, our task can be described as follows. If we apply the logical expression exh to the extensional term translations given in (12)(a) - (16)(a), the interpretation of the resulting expressions (12)(b) - (16)(b) should warrant that they are equivalent with (12)(c) - (16)(c):

(12)(a) John $\sim \lambda P P(j)$

(b) exh($\lambda P P(j)$)

(c) $\lambda P \forall x [P(x) \leftrightarrow x=j]$

(13)(a) John and Mary $\sim \lambda P [P(j) \wedge P(m)]$

(b) exh($\lambda P [P(j) \wedge P(m)]$)

(c) $\lambda P \forall x [P(x) \leftrightarrow [x=j \vee x=m]]$

(14)(a) every boy $\sim \lambda P \forall x [\text{boy}(x) \rightarrow P(x)]$

(b) exh($\lambda P \forall x [\text{boy}(x) \rightarrow P(x)]$)

(c) $\lambda P \forall x [\text{boy}(x) \leftrightarrow P(x)]$

(15)(a) John or Mary $\sim \lambda P [P(j) \vee P(m)]$

(b) exh($\lambda P [P(j) \vee P(m)]$)

(c) $\lambda P \forall x [(P(x) \leftrightarrow x=j) \vee (P(x) \leftrightarrow x=m)]$

(16)(a) a girl $\sim \lambda P \exists x [\text{girl}(x) \wedge P(x)]$

(b) exh($\lambda P \exists x [\text{girl}(x) \wedge P(x)]$)

(c) $\lambda P \exists x [\text{girl}(x) \wedge \forall y [P(y) \leftrightarrow x=y]]$

If we apply the formulas (12)(c) - (16)(c) to the abstract $\lambda x \text{ walk}(x)$, the extensional translation of the abstract underlying interrogative (3), we get, using λ -conversion, the formulas (4)(d) - (8)(d). Since this is what the translation rule tells us to do in order to arrive at the translation of the answers (4) - (8) in the context of the interrogative (3), we get the proper results if we can specify the content of exh in such a way that the equivalences between (12)(b) - (16)(b) and (12)(c) - (16)(c) hold.

In the extensional formulas in (12) - (16), the predicate variable P will be assigned a subset of the domain of individuals D . So, all expressions in (12) - (16) denote a set of subsets of D . The translation of John in (12)(a) denotes those subsets of D of which the individual John is an element. I.e. it contains the unit set $\{\text{John}\}$ and all sets $X \subseteq D$ such that $\{\text{John}\} \subseteq X$. In view of the equivalence aimed at between (12)(b) and (c), the expression exh $(\lambda P P(j))$ is to denote the set containing those subsets X of D such that all elements of X equal John. I.e. it should denote the set $\{\{\text{John}\}\}$. This suggests that exh works as a kind of filter on the set of sets denoted by a term. It filters out those sets X in the denotation of the term for which there is no other set Y in its denotation such that $Y \subset X$. So, it seems that exh can be defined as the following semantic operation:

$$(17) \text{ exh} = \lambda P \lambda P' [P(P) \wedge \neg P'[P(P')] \wedge P \neq P' \wedge \forall x [P'(x) \rightarrow P(x)]]$$

If we use this definition to write out (12)(b), the exhaustivization of John, we get the following result:

$$(12)(d) \lambda P [P(j) \wedge \neg P'[P'(j) \wedge P \neq P' \wedge \forall x [P'(x) \rightarrow P(x)]]]$$

The expression (12)(d) is indeed equivalent to (12)(c), which means that when applied to proper names, exh as defined in (17) gives correct results.

Let us check definition (17) by considering our other examples. Writing out (13)(b), the exhaustivization of John and Mary, by means of definition (17), we arrive at:

$$(13) (d) \lambda P[P(j) \wedge P(m) \wedge \exists P'[P'(j) \wedge P'(m) \wedge P \neq P' \wedge \forall x[P'(x) \rightarrow P(x)]]]$$

This is correct, (13) (d) is equivalent to (13) (c). In semantic terms, the denotation of John and Mary contains those $X \subseteq D$ such that $\{\{John, Mary\}\} \subseteq X$. From this set $\{X \mid \{\{John, Mary\}\} \subseteq X\}$, exh filters out the smallest sets, resulting in $\{\{John, Mary\}\}$.

Using definition (17) to write out (14) (b), the exhaustivization of every man, we get the following result:

$$(14) (d) \lambda P[\forall x[man(x) \rightarrow P(x)] \wedge \exists P'[\forall x[man(x) \rightarrow P'(x)] \wedge P \neq P' \wedge \forall y[P'(y) \rightarrow P(y)]]]$$

Again, the result is correct. Formula (14) (d) is equivalent with (14) (c).

Let us now look at example (15). The denotation of the term John or Mary is the result of taking the union of the denotations of the terms John and Mary: $\{X \mid \{John\} \subseteq X\} \cup \{X \mid \{Mary\} \subseteq X\} = \{X \mid \{John\} \subseteq X \vee \{Mary\} \subseteq X\}$. This latter set of sets contains two smallest elements, the sets $\{John\}$ and $\{Mary\}$. So, the result of applying exhaustivization is the set $\{\{John\}, \{Mary\}\}$. And this is the denotation of (15) (d), which is the result we get if we use definition (17) in writing out the expression (15) (b):

$$(15) (d) \lambda P[(P(j) \vee P(m)) \wedge \exists P'[(P'(j) \vee P'(m)) \wedge P \neq P' \wedge \forall x[P'(x) \rightarrow P(x)]]]$$

In this case too, the resulting formula (15) (d) is equivalent with the intuitive predicate logical translation (15) (c).

Using definition (17) in writing out our last example, (16) (b), the exhaustivization of a girl, the resulting expression will again denote a set of unit sets. This is so because the term a girl denotes a set of sets of which the smallest elements are singletons consisting of a single girl. Exhaustivization filters out these singletons:

$$(16) (d) \lambda P[\exists x[\text{girl}(x) \wedge P(x)] \wedge \\ \neg \exists P'[\exists x[\text{girl}(x) \wedge P'(x)] \wedge P \neq P' \wedge \forall y[P'(y) \rightarrow P(y)]]]$$

In this last case too, the result is satisfactory, (16) (d) is equivalent with the intuitive translation (16) (c).⁴⁵

To sum up, we have seen that a simple and conceptually clear definition of the semantic operation of exhaustivization can be given that gives correct results when applied to proper names, simple conjunctions and disjunctions thereof, and simple universally and existentially quantified terms. It operates on a set of sets and filters out its smallest elements.⁴⁶

Still, logical clarity is no guarantee for truth. We have sofar only looked at few simple examples of terms. There, our definition of exhaustivization was confirmed, and this may give us hope, but it does not give us proof that it will work for all cases it has to work for, i.e. that it gives correct results when applied to any term that allows for an exhaustive interpretation.⁴⁷ We will not attempt to arrive at such a proof in this paper, though we will discuss some apparent counterexamples in the next sub-section and will indicate how to deal with them.

3.1.3 Exhaustiveness and plurality

There are many terms besides those discussed above for which definition (17) of exhaustivization works perfectly, such as those in (18), but there are also others for which it prima facie does not give correct results, such as those listed in (19):

- (18) John and Mary or Suzy; John or Mary and Suzy, every man and Mary; a man and a woman; a man or a woman; two men; Mary and a man; Mary or two men
- (19) John or Mary or both (John and Mary); at most two girls; at least one girl; John or every man; at most John

What goes wrong, and what causes it to go wrong, can be made clear by considering the first example in (19).

The term John denotes the set $\{X \mid \{\text{John}\} \subseteq X\}$; Mary denotes the set $\{X \mid \{\text{Mary}\} \subseteq X\}$. If we take their conjunction (both John and Mary) to denote the intersection of these two sets, we get $\{X \mid \{\text{John, Mary}\} \subseteq X\}$. The latter set is clearly a subset of each of the former two. This means that the union of all three of them, which is the denotation of John or Mary or both (John and Mary), will be the same as the union of the first two of them, the denotation of John or Mary.

This will come as no surprise. The standard logical treatment of John or Mary is such that it means John or Mary or both of them. And this, we believe, is quite correct. But, of course, this implies that any definition of exh, or of any other term-modifier, will give the same result when it is applied to John or Mary or to John or Mary or both. As we have seen in the previous section, the result of applying exh to the former, and then combining the resulting exhausted term with e.g. the predicate walk, is a formula that expresses that exactly one individual walks, and that this individual is either John or Mary. And if John or Mary and John or Mary or both denote the same set of sets, we would get precisely the same result if we apply exh to the latter. And this in turn would mean that the answers (7) and (20) to the interrogative (3) would express the same proposition:

- (3) Who walk(s)?
- (7) John or Mary.
- (20) John or Mary or both (John and Mary).

But clearly, as answers to the question expressed by (3), (7) and (20) have a different meaning. The answer (7) means indeed that precisely one individual walks and that it is John or Mary, but (20) means that either precisely one individual walks and that it is John or Mary, or that precisely two individuals walk, both the individuals John and Mary. Whereas in the context of (3), (7) is equivalent with (21), (20) is

equivalent with (22):

- (21) Only John or only Mary.
 (22) Only John or only Mary or only both (John and Mary).

What seems to cause the problem at hand is that semantic plurality has not been taken into account the way it should be. The third disjunct of John or Mary or both (John and Mary) is semantically plural. The standard treatment of John and Mary used above does not take this into account properly. It simply takes the intersection of the denotations of John and Mary, resulting in the set $\{X \mid \{John, Mary\} \subseteq X\}$.

This 'analysis' of plural terms is alright for many contexts, but it is also known to be wrong in general as an analysis of such terms.⁴⁸ In many contexts we have to consider John and Mary not as denoting a set of properties of individuals, those properties that both the individual John has and the individual Mary has, but as denoting a set of properties of 'groups', those properties that the group consisting of John and Mary has.⁴⁹

There are various ways to account for this, and consequently there are various theories of semantic plurality around.⁵⁰ Here, we do not want to make a particular choice among them, since the problem we discuss here, and the way in which we want to solve it, should not essentially depend on any particular feature of any particular theory. As long as the theory makes a neat distinction between individuals and groups it is alright with us. So, let us just represent the group consisting of John and Mary as $[John, Mary]$, without committing ourselves to a particular view on the nature of the semantic object it represents. The denotation of the semantically plural term John and Mary will then be the set of properties of groups and/or individuals $\{X \mid \{[John, Mary]\} \subseteq X\}$.

Once this much has been acknowledged, our difficulties disappear. The denotation of the term (23) now becomes (24), and applying the semantic operation of exhaustivization to this set of sets results in (25):

- (23) John or Mary or both (John and Mary)
 (24) $\{X \mid \{\text{John}\} \subseteq X \vee \{\text{Mary}\} \subseteq X \vee \{\{\text{John}, \text{Mary}\}\} \subseteq X\}$
 (25) $\{\{\text{John}\}, \{\text{Mary}\}, \{\{\text{John}, \text{Mary}\}\}\}$

This is exactly what one wants to get. For if (24) is the denotation of the term (23), in the context of the interrogative (3), the constituent answer (20) will indeed express what we intuitively considered it to express, viz. that either John is the one who walks, or Mary is the one who walks, or John and Mary are the ones that walk.⁵¹

So, by taking semantic plurality into account, we do get the fully satisfactory result that the two terms John or Mary and John or Mary or both do not have precisely the same denotation, but are interpreted in such a way that, though interchangeable in certain contexts, they have a different meaning in others, e.g. when they are interpreted exhaustively, as they must when they are taken as answers.

It should be noted that these results are obtained by combining the intuitive and simple interpretation of exhaustiveness defined in (17) with the view that semantic plurality has to be taken seriously, a view that has been motivated also on entirely independent grounds.

Plurality is also involved in the difference between a girl and at least one girl, or more generally, in the difference between n girls and at least n girls. Again, the standard logical treatment of these terms does not differentiate between them, but rather treats them as equivalent. And in this case too, though this may be correct for some contexts, it is not so for all. It does not lead to an appropriate interpretation of the answer (26), which clearly differs from the answer (8):

- (3) Who walk(s)?
 (8) A girl.
 (26) At least one girl.

The proposition that (8) expresses in the context of (3), we

described as follows: exactly one individual walks, and this individual is a girl. The proposition that (26) expresses in the context of (3) is that at least one individual walks, and that the individual(s) that walk(s) are girls. Or, in 'plural' terms, it says that the group of walkers is a group of girls with at least one member. And generally, an answer of the form At least n girls, in the context of the interrogative Who walk(s)? expresses that the group of walkers is a group of girls with at least n members.⁵²

That this is a correct paraphrase of the meaning of this answer follows from the perfectly reasonable assumption that a group walks iff its members do. This is a feature of the property of walking (and many others besides) and has nothing to do with the meaning of the term as such. This becomes clear if one contrasts the pair (3) - (26) with the pair (27) - (28):

- (27) Who gather?
 (28) At least six girls.

In the context of (27), the answer (28) expresses that one group gathers, a group of girls having at least six members.

So, we have come to the conclusion that a term of the form at least n girls denotes the following set of sets:

- (29) $\{X \mid \{G\} \subseteq X, \text{ where } G \text{ is a group of girls having at least } n \text{ members}\}$

Contrast this with n girls, which denotes the set of sets:

- (30) $\{X \mid \{G\} \subseteq X, \text{ where } G \text{ is a group of } n \text{ girls}\}$

If we apply exhaustivization to (29), we arrive at (31), if we apply it to (30), we get (32):

- (31) $\{\{G\} \mid G \text{ a group of girls having at least } n \text{ members}\}$

(32) $\{\{G\} \mid G \text{ a group of } n \text{ girls}\}$

For $n=1$, this gives us the results we wanted to get for the answers (8) and (26) in the context of the interrogative (3).

In a completely similar way, one can deal with terms such as at most two girls. The standard non-plural treatment of it characterizes it as monotone decreasing over the domain of individuals D . Under such a treatment, the empty set is the unique smallest element in the set of sets denoted by it. Since exh selects the smallest elements from a set of sets, this means that only at most two girls would come out equivalent with no-one, predicting quite falsely, that the answers (32) and (33) express the same proposition in the context of the interrogative (3):

(3) Who walk(s)?

(32) At most two girls.

(33) No-one.

In the context of (3), the answer (32) expresses the proposition that at most two individuals walk, and that the individuals that walk (if any) are girls. In 'plural' terms, it says that exactly one group walks, that it is a group of girls, and that it has at most two members. If we treat terms of the form at most n girls as semantically plural terms, we do get better results, at least as far as exhaustivization is concerned. If their denotation would be something like (34), exhaustivization would lead to (35):^{53,54}

(34) $\{X \mid \{G\} \subseteq X, \text{ where } G \text{ is a group of girls having at most } n \text{ members}\}$

(35) $\{\{G\} \mid G \text{ a group of girls having at most } n \text{ members}\}$

The set of sets (34) will, in general, have many smallest elements, and hence (35) will, in general, have many elements as well. E.g. if $n=2$, it contains all unit sets having as its sole element a group of zero, one or two girls.

The other problematic examples listed in (19) can be handled in an analogous fashion.⁵⁵ So, we can draw the following conclusions. First of all, the semantic operation of exhaustivization defined in (17) is basically correct. Secondly, apparent counterexamples can be countered effectively by taking semantic plurality seriously. An overall proper treatment of exhaustiveness really presupposes a proper treatment of plurality.

Since that is an independent topic, and one which we are not concerned with here, we feel free to neglect plurality in the remainder, and to choose our examples in such a way that cases where plurality essentially comes in are avoided. We feel that for the moment it suffices to have shown that once a proper treatment of plurality is adopted, proper results can be obtained in all cases.

3.1.4. An example

Sofar, we used an extensional formulation of the semantic operation of exhaustivization. This is justified since it really is an extensional operation. But terms are generally treated intensionally, i.e. as sets of properties rather than as sets of sets (and this for good reasons). Since exhaustivization is to apply to terms on their intensional interpretation, we replace definition (17) by the following one (in which P now ranges over properties, and P over second order properties, and not over sets and sets of sets anymore):⁵⁶

$$(36) \text{ exh } = \lambda P \lambda P' [P(a) \wedge \neg \exists P' [P(a) \wedge P' \wedge P(a) \neq P'(a) \wedge \forall x [P'(a)(x) \rightarrow P(a)(x)]]]$$

It will be clear from the discussion above that if this definition of exh is used in connection with the translation rule (T:IA1) stated in section 3.1.1, the rule assigns the correct interpretation to both constituent and sentential answers in the context of a single constituent interrogative.

We will illustrate this by giving one further, somewhat more complicated example. Consider the interrogative-answer pairs (37) - (38) and (37) - (39):

- (37) Which guests does John kiss?
 (38) John kisses Bill or Peter, and two girls.
 (39) Bill or Peter, and two girls.

These pairs result of the syntactic rule (S:IA1) is applied to the abstract (40), translating as (40'), and the term (41), translating as (41'):

- (40) which guests John kisses
 (40') $\lambda x[\text{guest}(a)(x) \wedge \text{kiss}(a)(j,x)]$
 (41) Bill or Peter, and two girls
 (41') $\lambda P[[P(a)(b) \vee P(a)(p)] \wedge \exists x\exists y[x \neq y \wedge \text{girl}(a)(x) \wedge P(a)(x) \wedge \text{girl}(a)(y) \wedge P(a)(y)]]$

For both interrogative-answer pairs (37) - (38) and (37) - (39), the translation rule (T:IA1) results in the pair of formulas $\langle (37'), (38') \rangle$, where (37') and (38') read as follows:

- (37') $\lambda i[\lambda x[\text{guest}(a)(x) \wedge \text{kiss}(a)(j,x)] = \lambda x[\text{guest}(i)(x) \wedge \text{kiss}(i)(j,x)]]$
 (38') $\text{exh}(\lambda a(41'))(\lambda a(40'))$

The expression $\text{exh}(\lambda a(41'))$ occurring in (38'), can be written out as (42):

- (42) $\lambda P[[P(a)(b) \vee P(a)(p)] \wedge \exists x\exists y[x \neq y \wedge \text{girl}(a)(x) \wedge P(a)(x) \wedge \text{girl}(a)(y) \wedge P(a)(y)] \wedge \neg \exists P'[[P'(a)(b) \vee P'(a)(p)] \wedge \exists x\exists y[x \neq y \wedge \text{girl}(a)(x) \wedge P'(x) \wedge \text{girl}(a)(y) \wedge P'(y)] \wedge P(a) \neq P'(a) \wedge \forall z[P'(a)(z) \rightarrow P(a)(z)]]]$

Formula (42) can be reduced to (42'):

$$(42') \quad \lambda P[\exists x\exists y[x \neq y \wedge \text{girl}(a)(x) \wedge \text{girl}(a)(y) \wedge \\ \forall z[[P(a)(z) \leftrightarrow [z = x \vee z = y \vee z = b]]] \vee \\ [P(a)(z) \leftrightarrow [z = x \vee z = y \vee z = p]]]]]$$

If we apply (42'), the reduced translation of the exhaustivization of the term (41) Bill or Peter, and two girls, to the intension of (41'), the translation of the abstract (40) which guests John kisses, we arrive at formula (38''), the interpretation of the answers (38) and (39) in the context of the interrogative (37):

$$(38'') \quad \exists x\exists y[x \neq y \wedge \text{girl}(a)(x) \wedge \text{girl}(a)(y) \wedge \\ \forall z[[[\text{guest}(a)(z) \wedge \text{kiss}(a)(j,z)] \leftrightarrow \\ [z = x \vee z = y \vee z = b]]] \vee \\ [[\text{guest}(a)(z) \wedge \text{kiss}(a)(j,z)] \leftrightarrow \\ [z = x \vee z = y \vee z = p]]]]$$

Formula (38'') expresses that the guests that John kisses are three, that two of them are girls, and that the third one is either John or Bill. And this is precisely what (38) and (39) mean as answers to the question expressed by (37).

This ends our discussion of single constituent interrogative answer pairs. We formulated a syntactic and semantic rule forming and interpreting such pairs in section 3.1.1. The remainder of section 3.1 was devoted to giving content to the semantic operation of exhaustivization, resulting in definition (36) in section 3.1.2. The example just given shows that the results which are obtained, are indeed the ones one wants, even in rather complicated cases. What remains to be done is to generalize our rules, so as to cover also multiple constituent interrogative-answer pairs (section 3.2), and sentential interrogative-answer pairs (section 3.3).

3.2. Multiple constituent interrogatives

Up to now, we have only discussed single constituent interrogatives and their answers. We now turn to multiple constituent ones. The syntactic and semantic rule for their derivation and interpretation will be seen to be a straightforward generalization of the pair of rules (S:IA1) and (T:IA1).

Interpreted at the level of abstracts, an n-constituent interrogative expresses an n-place relation, as we saw in section 1. In simple cases, a constituent answer to such an interrogative surfaces as an n-place sequence of terms. E.g. the two-constituent interrogative (43) might receive the constituent answer (44) (a) or the corresponding sentential answer (44) (b):

(43) Which man loves which woman?

(44) (a) John, Suzy.

(44) (b) John loves Suzy.

The abstract underlying the interrogative (43) translates as (43'):

(43') $\lambda x \lambda y [\text{man}(a)(x) \wedge \text{woman}(a)(y) \wedge \text{love}(a)(x,y)]$

Formula (43') expresses the relation of loving restricted to men for its first and to women for its second argument. Its denotation corresponds to a set of pairs $\langle a,b \rangle$ such that a is a man, b is a woman and a loves b. The answers (44) (a) and (b) express the proposition that the pair $\langle \text{John}, \text{Mary} \rangle$ is the only such element in the set of pairs denoted by (43')

We can obtain this result by taking the following steps:

- (i) We derive both (44) (a) and (b) from the abstract underlying (43) and the sequence of terms John, Mary.
- (ii) We interpret this sequence of two terms as denoting a set of two-place relations, i.e. as a set of relations

between two individuals, extensionally speaking a set of sets of pairs of individuals. Each element in this set of relations is a relation in which the individual John stands to the individual Suzy. I.e. the extension of each relation in the set denoted by the sequence John, Suzy, contains at least the pair $\langle \text{John}, \text{Suzy} \rangle$.

We could then apply functional application of the thus interpreted sequence John, Mary to the interpretation of the AB^2 which man loves which woman. But this would result in a proposition that says that the pair $\langle \text{John}, \text{Mary} \rangle$ is an element of the set of pairs denoted by the abstract. So, we need a further step that guarantees the exhaustiveness of such answers.

- (iii) This step consists in applying an operation of exhaustivization to the set of two-place relations denoted by the sequence John, Suzy. Extensionally speaking, this operation filters out the smallest set of pairs in the denotation of that sequence. In this case, it filters the set $\{\langle \text{John}, \text{Mary} \rangle\}$ out of the set $\{X \mid \{\langle \text{John}, \text{Mary} \rangle\} \subseteq X\}$.
- (iv) The last step is then functional application of the exhausted interpretation of the sequence John, Suzy to the interpretation of the abstract which man loves which woman.

From this informal sketch, it will already be quite clear that the whole procedure is a simple generalization of the case of single constituent interrogative-answer pairs. In what follows, we will state the formal details of the steps we have just distinguished.

3.2.1. Multiple terms

A first thing to notice is that not only simple n-place sequences, but also conjunctions and disjunctions thereof can be transformed into an answer. Our interrogative (43) could also be answered by (45) or (46):

- (43) Which man loves which woman?
- (45) (a) John loves Suzy, and Bill (loves) Mary.
 (45) (b) John, Suzy; and Bill, Mary.
- (46) (a) John loves Suzy, or Bill (loves) Mary.
 (46) (b) John, Suzy; or Bill, Mary.

The answers (45) (a) and (b) should be derived from the conjunction of the two-place sequences of terms John, Suzy and Bill, Mary, the answers (46) (a) and (b) from their disjunction. We will call both simple sequences of n terms and conjunctions and disjunctions thereof ' n -place terms'. Just as n -place abstracts form a family of categories AB^n for $n \geq 0$, so do n -place terms. The latter family of categories can be defined in terms of the first as follows:

$$(T) T^n = S/AB^n, \text{ for } n \geq 0$$

Ordinary terms belong to the category $T^1 = S/AB^1 = S/(S/e)$. The corresponding type $f(T^1) = \langle \langle s, \langle e, t \rangle \rangle, t \rangle$, i.e. they denote a set of properties. A two-place term belongs to the category $T^2 = S/AB^2 = S/((S/e)/e)$. The corresponding type $f(T^2) = \langle \langle s, \langle e, \langle e, t \rangle \rangle \rangle, t \rangle$, i.e. they denote a set of two-place relations. In general, a T^n denotes a set of n -place relations.⁵⁷ Definition (T) defines T^0 's, zero-place terms, as expressions of category S/S , i.e. the category of sentence adverbs. We will make use of this in section 3.3, where we discuss sentential interrogatives and their answers.

We now state the syntactic rule that derives n -place terms and the corresponding translation rule that serves to interpret them:⁵⁸

- (S: T^n) If $\alpha_1, \dots, \alpha_n$ are T^1 's, then $F_{T^n}(\alpha_1, \dots, \alpha_n)$ is a T^n
- (T: T^n) If α_1 translates as α_1' , ..., α_n as α_n' , then
 $F_{T^n}(\alpha_1, \dots, \alpha_n)$ translates as
 $\lambda R^n[\alpha_1' (\lambda a \lambda x_1 [\dots \alpha_n' (\lambda a \lambda x_n [R^n(a)(x_1, \dots, x_n)]) \dots])]$

A variable R^n is of type $\langle s, f(AB^n) \rangle$, i.e. it ranges over n -place relations. From this it will be clear that if a T^n and an AB^n are combined by means of functional application, the result is a sentential expression. Our examples concern T^2 's only. We will write R instead of R^2 .

As a first simple example, the T^2 John, Mary is the result of $F_{T^2}(\text{John, Mary})$. Its translation is given in (47), which can be reduced to (47'):

$$(47) \quad \lambda R[\lambda P P(a)(j)(\lambda \lambda x_1[\lambda P P(a)(m)(\lambda \lambda x_2[R(a)(x_1, x_2)])]])]$$

$$(47') \quad \lambda R R(a)(j, m)$$

The rule does not only apply to proper names, but to all sorts of terms. Two examples illustrating this are (48) and (49):

$$(48) \quad \text{every man, a girl}$$

$$(48') \quad \lambda R \forall x[\text{man}(a)(x) \rightarrow \exists y[\text{girl}(a)(y) \wedge R(a)(x, y)]]$$

$$(49) \quad \text{John and Bill, Mary or Suzy}$$

$$(49') \quad \lambda R[[R(a)(j, m) \wedge R(a)(b, m)] \vee [R(a)(j, s) \wedge R(a)(b, s)]]$$

In order to be able to deal with answers such as (45) and (46), we further need to generalize term conjunction and disjunction to conjunction and disjunction of T^n 's. The following two rules accomplish this:

$$(S:CT^n) \quad \text{If } \alpha \text{ and } \beta \text{ are } T^n\text{'s, then } \alpha \text{ and } \beta \text{ is a } T^n$$

$$(T:CT^n) \quad \text{If } \alpha \text{ translates as } \alpha' \text{ and } \beta \text{ as } \beta', \text{ then } \alpha \text{ and } \beta \\ \text{ translates as } \lambda R^n[\alpha'(R^n) \wedge \beta'(R^n)]$$

$$(S:DT^n) \quad \text{If } \alpha \text{ and } \beta \text{ are } T^n\text{'s, then } \alpha \text{ or } \beta \text{ is a } T^n$$

$$(T:DT^n) \quad \text{If } \alpha \text{ translates as } \alpha' \text{ and } \beta \text{ as } \beta', \text{ then } \alpha \text{ or } \beta \\ \text{ translates as } \lambda R^n[\alpha'(R^n) \vee \beta'(R^n)]$$

We will give three examples to illustrate these rules. The conjunction of the two T^2 's John, Mary and Bill, Suzy results in the T^2 (50), translating as (50'), their disjunction results in the T^2 (51), translating as (51'):

(50) John Mary; and Bill Suzy

(50') $\lambda R[R(a)(j,m) \wedge R(a)(b,s)]$

(51) John, Mary; or Bill Suzy

(51') $\lambda R[R(a)(j,m) \vee R(a)(b,s)]$

A more complex example is the T^2 (52), which translates as (52'):

(52) John and Bill, Mary or Suzy; and Peter or Fred a
redhead

(52') $\lambda R[[R(a)(j,m) \wedge R(a)(b,m)] \vee [R(a)(j,s) \wedge R(a)(b,s)]] \wedge$
 $\exists x[\text{readhead}(a)(x) \wedge [R(a)(p,x) \vee R(a)(f,x)]]$]

The way in which (52) is derived is presented in the derivation tree (52''):

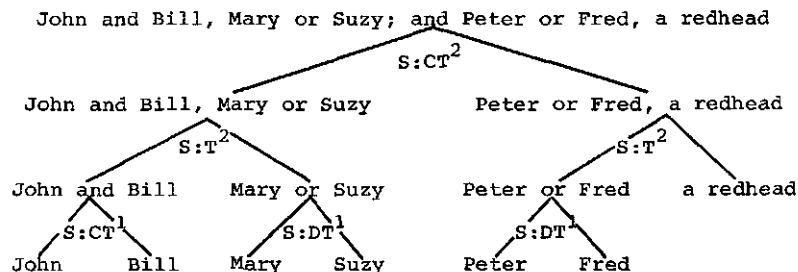

(52'')

This concludes what should be said about the second step in the analysis of multiple constituent interrogatives and their answers that we distinguished in the preceding section, the construction and interpretation of n-place terms.

3.2.2. Exhaustiveness of multiple terms

The next step we have to take consists in providing a generalization of the semantic operation of exhaustivization in such a way that it not only applies to ordinary terms, T^1 's, but to T^n 's in general. It is not so much the operation of exhaustivization as such that is in need of generalization, since it already corresponds to a quite general concept: that of taking the smallest elements out of a set of sets. T^n 's are associated with sets of sets in much the same way as T^1 's are. Whereas the latter extensionally correspond to a set of sets of individuals, the former more generally correspond to a set of sets of n-tuples of individuals. The concept of exhaustivization applies equally well to both of them.

The only thing that is in need of generalization is our definition of the logical expression exh as it was stated in (36). Instead of a single expression exh of type $\langle\langle s, f(T) \rangle, f(T) \rangle$, we need a whole family of expressions exhⁿ, for $n \geq 0$, of types $\langle\langle s, f(T^n) \rangle, f(T^n) \rangle$. The general definition that specifies their semantic content reads as follows:

$$(53) \text{ exh}^n = \lambda R^n \lambda R^n [R^n(a) (R^n) \wedge \neg \exists R'^n [R'^n(a) (R'^n) \wedge \\ R^n(a) \neq R'^n(a) \wedge \\ \forall x_1 \dots x_n [R'^n(a) (x_1, \dots, x_n) \rightarrow R^n(a) (x_1, \dots, x_n)]]]$$

A variable R^n is of type $\langle s, f(T^n) \rangle$, a variable R^n of type $\langle s, f(AB^n) \rangle$. For $n=2$, we will suppress the superscripts in our examples. Definition (36) of exh is the definition of exh¹ which is a special instance of (53).

If we apply exh² to the simple T^2 John, Mary, the reduced result is (54):

$$(54) \lambda R \forall x \forall y [R(a) (x, y) \leftrightarrow [x = j \wedge y = m]]$$

The expression (54) denotes the set of relations which hold between the pair of individuals <John, Mary> and no others. This is indeed the interpretation we need, to obtain correct results for the interpretation of the corresponding two-constituent answer John, Mary. in the context of two-constituent interrogatives.

By way of further illustration, we give the reduced results of applying exh² to the examples of T^2 's given in the previous section.

(50) John, Mary; and Bill, Suzy

(50e) $\lambda R \forall x \forall y [R(a)(x, y) \leftrightarrow ([x = j \wedge y = m] \vee [x = b \wedge y = s])]$

(51) John, Mary; or Bill, Suzy

(51e) $\lambda R \forall x \forall y [[R(a)(x, y) \leftrightarrow [x = j \wedge y = m]] \vee [R(a)(x, y) \leftrightarrow [x = b \wedge y = s]]]$

(48) every man, a girl

(48e) $\lambda R \forall x [\text{man}(a)(x) \leftrightarrow \exists y [\text{girl}(a)(y) \wedge \forall z [R(a)(x, z) \leftrightarrow z = y]]]$

(49) John and Bill, Mary or Suzy

(49e) $\lambda R \exists z [[z = m \vee z = s] \wedge \forall x \forall y [R(a)(x, y) \leftrightarrow ([x = j \vee x = b] \wedge y = z)]]$

(52) John and Bill, Mary or Suzy; and Peter or Fred, a redhead

(52e) $\lambda R \exists z_1 \exists z_2 \exists z_3 [[z_1 = m \vee z_1 = s] \wedge [z_2 = p \vee z_2 = f] \wedge \text{redhead}(a)(z_3) \wedge \forall x \forall y [R(a)(x, y) \leftrightarrow ([[x = j \vee x = b] \wedge y = z_1 \vee [x = z_2 \wedge y = z_3])]]]$

These examples may suffice to show that our definition of exhaustivization gives correct results, also when applied to more complex cases.

Of course, we have to make the same proviso concerning terms, in this case T^n 's, that essentially involve plurality. For example, if semantic plurality is not taken seriously, exhaustivization of (55) and (57) will come out equivalent the exhaustivization of (56) and (58) respectively:

- (55) John, Mary; or Bill, Mary; or both John, Mary; and Bill, Mary
 (56) John, Mary; or Bill, Mary
 (57) John or Bill or both (John and Bill), Mary
 (58) John or Bill, Mary

In fact, all four of them come out equivalent if we don't take plurality into account. Though (55) and (57) would constitute equivalent short answers to a two-constituent interrogative, and (56) and (58) as well, the latter two give different answers than the former two.

Again, this can be remedied by taking semantic plurality seriously. A conjunction of T^n 's, for example, should then be taken to correspond to a set of relations between groups of individuals, rather than to a set of relations between individuals simpliciter. We will not discuss this matter further here, since what could be said without going into technical details, would be a simple variation of the theme sung in section 3.1.3 above.

3.2.3. The general rule

Now that we have introduced simple and complex n -place terms, and have indicated how the semantic process of exhaustivization applies to them, all the ingredients are available to state the general rules that derive and interpret n -constituent interrogative-answer pairs:

(S:IA) If β is an AB^n , and α a T^n , then $\langle F_I(\beta), F_{CA}^n(\alpha, \beta) \rangle$
 and $\langle F_I(\beta), F_{SA}^n(\alpha, \beta) \rangle$ is an $\langle \bar{S}, S \rangle$

(T:IA) If β translates as β' , and α as α' , then both
 $\langle F_I(\beta), F_{CA}^n(\alpha, \beta) \rangle$ and $\langle F_I(\beta), F_{SA}^n(\alpha, \beta) \rangle$ translate
 as $\langle \lambda i [\beta' = (\lambda a \beta')(i)] , \text{exh}^n(\lambda a \alpha')(\lambda a \beta') \rangle$

Clearly, the rules (S:IA1) and (T:IA1), presented in section 3.1.1 are simply a special instance of these general rule schemata. The remarks we made there, e.g. about the grammatical status of the rule, remain in force, and need not be repeated here. The syntactic rule produces pairs of expressions, the first element of which is an interrogative, and the second element of which is a constituent or sentential answer. The interrogative, formed from an n-place abstract is translated into a logical expression that denotes a proposition and expresses a question. That part of the rule was already explained in section 1. The constituent and the corresponding sentential answer are formed from the n-place abstract and an n-place term. In both cases the result is a sentential expression. Their interpretation is obtained by first applying the semantic operation of exhaustivization to the n-place term, and next applying it to the intension of the n-place abstract.

We will give one simple example to illustrate the rules. Consider the interrogative-constituent answer pair $\langle (59), (60) \rangle$:

(59) Which man loves which woman?

(60) John, Mary; and Bill Suzy.

The pair of them are derived from the abstract (61), translating as (61'), and the two-place term (62), translating as (62'):

(61) which man loves which woman

(61') $\lambda x \lambda y [\text{man}(a)(x) \wedge \text{woman}(a)(y) \wedge \text{love}(a)(x,y)]$

(62) John, Mary; and Bill, Suzy

(62') $\lambda R [\text{R}(a)(j,m) \wedge \text{R}(a)(b,s)]$

According to the rules, the pair $\langle (59), (60) \rangle$ is then translated as the pair of logical expressions $\langle (59'), (60') \rangle$:

(59') $\lambda i [\lambda x \lambda y [\text{man}(a)(x) \wedge \text{woman}(a)(y) \wedge \text{love}(a)(x,y)] =$
 $\lambda x \lambda y [\text{man}(i)(x) \wedge \text{woman}(i)(y) \wedge \text{love}(i)(x,y)]]$

$$(60') \text{ \underline{exh}}^2 (\lambda a R[R(a)(j,m) \wedge R(a)(b,s)])(\\ \lambda a \lambda x \lambda y [\text{man}(a)(x) \wedge \text{woman}(a)(y) \wedge \text{love}(a)(x,y)])$$

Formula (60') can be reduced to (60''):

$$(60'') \forall x \forall y [[\text{man}(a)(x) \wedge \text{woman}(a)(y) \wedge \text{love}(a)(x,y)] \leftrightarrow \\ [[x = j \wedge y = m] \vee [x = b \wedge y = s]]]$$

The expression (59'), translating the interrogative, expresses the question or propositional concept, which has as its extension at an index k the proposition that gives a rigid and exhaustive specification of the pairs of individuals $\langle x, y \rangle$ such that x is a man and y is a woman at k , and x loves y at k . The formula (60'') expresses the proposition that the pairs of individuals $\langle \text{John}, \text{Mary} \rangle$ and $\langle \text{Bill}, \text{Suzy} \rangle$ are the only pairs of individuals consisting of a man and a woman such that the first loves the second.

So, in this case, the proposition expressed by the answer gives the kind of specification the question expressed by the interrogative asks for. If (60) further happens to be true at the actual index, the index assigned to the variable a , then (60) is not only an answer, but also a true answer to (59).

Further examples can easily be constructed by applying the rules to the two-place terms discussed in the previous two sections.⁵⁹

To conclude this section, it can be observed that the rules (S:IA) and (T:IA) give a general implementation of the interpretation schema presented in figure 3 of section 2.4, which was the outcome of our informal discussion of the interpretation of interrogative-answer pairs. This means that we have accomplished one of the main tasks we set ourselves in this paper: to define syntactic and semantic rules which analyze interrogative sentences and linguistic answers in such a way, that the semantic and pragmatic theory of answerhood developed in G&S 1984 applies to them. Section 4 is devoted to a discussion of this matter.

But first, there is one more topic we want to address ourselves to, a topic that was largely neglected in this paper so far: sentential (yes/no-) interrogatives and their answers.

3.3. Sentential interrogatives

In previous sections, we have concentrated almost exclusively on constituent interrogatives. We have presented a uniform analysis of sentential ('long') and constituent ('short') answers to single and multiple constituent interrogatives. We argued that in order to give a correct account of the interpretation of constituent-answer pairs, the level of abstracts should be taken as a starting point. In this section we discuss the generalization of this approach to sentential interrogatives.

3.3.1. Zero-constituent interrogatives

Sentential interrogatives such as (63) can receive both sentential answers such as (64) (a) and (65) (a), and short answers such as those in (64) (b) and (65) (b):

(63) Will John visit the party?

(64) (a) (Yes,) John will visit the party.

(64) (b) Yes.

(65) (a) (No,) John will not visit the party.

(65) (b) No.

The short answers in (64) (b) and (65) (b) have the syntactic form of a sentence adverb. A sentence adverb is an expression of category S/S, such an adverb takes a sentence to form a new sentence. So, on the hypothesis that the derivation of sentential interrogative-answer pairs runs parallel to that of constituent ones, the input to the IA-rule forming

these pairs will have to be an S and an S/S. In fact, the IA-rule is already attuned to this. The base of the definition (AB) of the family of categories AB^n (given in section 1) is $AB^0 = S$. And the definition (T) of the family of categories T^n reads $T^n = S/AB^n$, which means that $T^0 = S/S$. Sentence adverbs are zero-place terms, and the abstracts underlying sentential interrogatives are full sentences.

This means that the IA-rule can be used to form sentential interrogative-answer pairs in exactly the same way as it forms constituent ones. A single rule of interrogative-answer pair formation suffices in all cases. Again, it may very well be that the syntactic operations involved are different for the sentential interrogatives and the constituent interrogative cases, which would warrant to split up the rule into several (sub) rules. But the important fact is that on the semantic side, a single interpretation schema suffices.⁶⁰

3.3.2 Yes and no

Let us illustrate these remarks by giving some examples. Let the expressions yes and no of category S/S be translated as indicated in (66):

- (66) yes $\sim \lambda p p(a)$
no $\sim \lambda p \neg p(a)$

If we apply the syntactic function F_{CA}^0 of rule (S:IA) to the S ($= AB^0$) John walks and the S/S ($= T^0$) yes, the resulting pair of expressions are those in (67). And if we apply F_{SA}^0 to them, the result is the pair of expressions in (68). And, similarly, if we apply the same functions to the same sentence and no, we end up with (69) and (70):

- (67) Does John walk? Yes.
(68) Does John walk? Yes, John walks.

- (69) Does John walk? No.
 (70) Does John walk? No, John doesn't walk.

According to the translation rule (T:IA), (71) is the translation of both (67) and (68), and (72) is the translation of both (69) and (70):

$$(71) \lambda i[\text{walk}(a)(j) = \text{walk}(i)(j)] , \\ \text{exh}^0(\lambda a \lambda p p(a))(\lambda a \text{walk}(a)(j))$$

$$(72) \lambda i[\text{walk}(a)(j) = \text{walk}(i)(j)] , \\ \text{exh}^0(\lambda a \lambda p \neg p(a))(\lambda a \text{walk}(a)(j))$$

Although this may not be quite evident at first sight, (71) and (72) do indeed express what we want them to express intuitively, and what is more transparently expressed by (71') and (72'), since the former two can be reduced to the latter two:

$$(71') \lambda i[\text{walk}(a)(j) = \text{walk}(i)(j)] , \text{walk}(a)(j)$$

$$(72') \lambda i[\text{walk}(a)(j) = \text{walk}(i)(j)] , \neg \text{walk}(a)(j)$$

The first expression in the pairs (71') and (72') express the question whether John walks. The second expression in (71') expresses the proposition that John walks, and that in (72') the proposition that John doesn't walk.

The equivalence of (71) and (71') hinges on the equivalence of $\text{exh}^0(\lambda a \lambda p p(a))(\lambda a \text{walk}(a)(j))$ and $\text{walk}(a)(j)$. Using definition (53) of exh^n , the former expression can be written out as:

$$(73) \text{walk}(a)(j) \wedge \neg \exists p[p(a) \wedge p(a) \neq \text{walk}(a)(j) \wedge \\ [p(a) \rightarrow \text{walk}(a)(j)]] \quad \text{€}$$

That (73) is equivalent with $\text{walk}(a)(j)$ can be seen as follows. Suppose $\text{walk}(a)(j)$ is true. Then the first conjunct of (73) is true, of course, and the second conjunct is true as well:

There is indeed no proposition that is both true and has a different truth value from that of $walk(a)(j)$, i.e. is false at the same time. And suppose that $walk(a)(j)$ is false. then the first conjunct of (73) is false. So, (73) is false. In a quite similar way, it follows that the second elements in (72) and (72') express the same proposition.

From this, we may conclude that our rules (S:IA) and (T:IA) give the required results, not only when they are applied to obtain single and multiple constituent interrogatives and their answers, but also if they are used to derive and interpret sentential interrogatives and their positive and negative answers. But at the same time, it can be noticed that for the answers Yes. and No. exhaustivization, which is built in in (T:IA), does not play a role. The final results (71') and (72') can be obtained equally well if the interpretation of the T^0 's yes and no is immediately applied to the intension of the AB^0 John walks, without first applying the semantic operation of exhaustivization to the interpretation of these zero-place terms. Applying exhaustivization does no harm either, it simply has no effect.

3.3.3. Exhaustiveness, the limit

It is not difficult to understand why exhaustivization makes no difference to yes and no. In general, exhaustivization will make no difference if it is applied to a term that already is exhaustive. This is the case if the set of sets to which the term corresponds has no two elements such that the one is smaller than the other. (This is also why repeated application of exhaustivization will never have any effect.)

What are the sets of sets to which yes and no, or T^0 's in general, correspond? A T^1 corresponds to a set of $\langle e, t \rangle$'s, a set of sets of individuals. A T^2 corresponds to a set of $\langle e, \langle e, t \rangle \rangle$'s, a set of sets of pairs of individuals. Quite similarly, a T^0 corresponds to a set of t 's, i.e. a set of truth values. As it happens, yes corresponds to $\{1\}$, and no to $\{0\}$. If we define $0 = \emptyset$ and $1 = \{\emptyset\}$, yes corresponds to

$\{\{\emptyset\}\}$, and no to $\{\emptyset\}$. And, indeed, if we take the set of smallest elements out of either one of them, in both cases the input will be identical to the output.

This is a peculiarity of the T^0 's yes and no that is not shared by all of them. A T^0 might just as well correspond to the set of truth values $\{0,1\}$, i.e. the set of sets $\{\emptyset,\{\emptyset\}\}$. If we then apply exhaustivization, the output is $\{\emptyset\}$, and is not identical to the input. So, in principle, exhaustivization can play a role for certain T^0 's. And, in fact, it does. There are cases where the interpretation of an answer to a sentential interrogative is essentially exhaustive.

The short answer (75)(a) and the corresponding sentential answer (75)(b) to the question expressed by (74) form a typical example:

(74) Does John walk?

(75)(a) If Mary walks.

(75)(b) John walks if Mary walks.

The phrase if Mary walks can be regarded as a sentential adverb, i.e. as an S/S. It translates as indicated in (76):

(76) $\lambda p[\text{walk}(a)(m) \rightarrow p(a)]$

If one applies the S/S if Mary walks to the S John walks, the result is the conditional sentence (77), translating as (77'):

(77) John walks if Mary walks

(77') $\text{walk}(a)(m) \rightarrow \text{walk}(a)(j)$

However, it can be observed, that in the context of the interrogative (74), the answers (75)(a) and (b) do not express the proposition expressed by (77'), the translation of the indicative sentence (77) in isolation, but rather the proposition expressed by (78'), the translation of the biconditional sentence (78):

- (78) John walks if and only if Mary walks
 (78') $\text{walk}(a)(m) \leftrightarrow \text{walk}(a)(j)$

So, in the context of a sentential interrogative, an answer derived from the T^0 if Mary walks, really means only if Mary walks. And this is indeed the exhaustive interpretation our interrogative-answer rule assigns to it.

The AB^0 underlying the interrogative (74) is the sentence John walks, translating as $\text{walk}(a)(j)$. If we apply (T:IA) to this abstract and the translation of if Mary walks given in (76), the resulting translation of the answers (75) (a) and (b) is (75'), which using the definition of exh^0 can be written out as (75''), which is equivalent to (78'):

- (75') $\text{exh}^0(\lambda a \lambda p [\text{walk}(a)(m) \rightarrow p(a)])(\lambda a \text{walk}(a)(j))$
 (75'') $[\text{walk}(a)(m) \rightarrow (\text{walk}(a)(j))] \wedge \neg \exists p [[\text{walk}(a)(m) \rightarrow p(a)] \wedge$
 $[p(a) \neq \text{walk}(a)(j)] \wedge$
 $[p(a) \rightarrow \text{walk}(a)(j)]]$

That (75'') and (78') are equivalent can be seen as follows:

- Suppose Mary and John both walk. Then the biconditional (78') is true. The first conjunct of (75'') is then also true, and so is the second conjunct. No proposition satisfies $[\text{walk}(a)(m) \wedge p(a)]$ and $[p(a) \neq \text{walk}(a)(j)]$. To satisfy the first, such a proposition would have to be true, since it is supposed that Mary walks. To satisfy the second, it would have to be false, since it is supposed that John walks. And no proposition can be true and false at the same time.
- Suppose Mary walks and John does not. Then (78') is false. And so is (75''), since then its first conjunct is false.
- Suppose John walks and Mary does not. Then (78') is false. And so is (75''), Though its first conjunct is true, its second conjunct is false. Any false proposition p satisfies $[\text{walk}(a)(m) \rightarrow p(a)] \wedge [p(a) \neq \text{walk}(a)(j)] \wedge [p(a) \rightarrow \text{walk}(a)(j)]$, since it is supposed that John walks and Mary does not.
- Suppose Mary and John both do not walk. Then (78') is true. And so is (75''). Its first conjunct is true, and so is its

second. No proposition can satisfy both $[p(a) \neq \text{walk}(a)(j)]$ and $[p(a) \rightarrow \text{walk}(a)(j)]$. To satisfy the first, it would have to be true, since it is assumed that John doesn't walk. To satisfy the second it would have to be false.

So, although they don't look like it, both (75) (a) and (b) as answers to (74) express that John walks if and only if Mary walks. And this is precisely what these answers intuitively express in that context. And this result is obtained by virtue of the fact that the translation rule exhaustifies the T^0 if Mary walks.

The way in which exhaustivization works in this case, can be explained as follows. At an index at which Mary walks, the set of sets corresponding to if Mary walks is the set $\{\{\emptyset\}\}$, i.e. the set $\{1\}$. At an index at which she doesn't walk, it is the set $\{\emptyset, \{\emptyset\}\}$, i.e. $\{0, 1\}$. In the first case, exhaustivization has no effect, but in the latter case, it gives as output $\{\emptyset\}$. So, exhaustivization has an overall effect when applied to such T^0 's.

Notice, by the way, that which set of truth values corresponds to if Mary walks (and to its exhaustivization only if Mary walks) is index dependent. It depends on the truth value of Mary walks at that index. In this respect there is an important difference between T^0 's such as if Mary walks and yes and no. The latter two at each index correspond to the same set, the sets $\{1\}$ and $\{0\}$ respectively. At any index, the set of propositions denoted by yes are the true propositions at that index, and the set of propositions denoted by no are the false propositions at that index. But if Mary walks at an index, only if Mary walks denotes the set of true propositions at that index, and if she doesn't walk at an index it denotes the set of false propositions at that index. In section 4.5, this special semantic property of yes and no is related to their special status as standard answers.

Notice further, that a conditional sentential answer is not always interpreted as a biconditional. Consider the following example:

(79) Is it true that John walks if Mary walks?

(80) (Yes,) John walks if Mary walks.

In this case, the conditional (80) is a straightforward positive answer to the question expressed by (79), which asks whether a conditional sentence is true or not.

This may explain why conditional sentences in some situations are most naturally interpreted as biconditionals, whereas in other situations they are not. What our analysis of interrogative-answer pairs predicts is that conditionals receive their standard logical interpretation if they are put forward as answers to an (implicit or explicit) question asking for the truth value of the conditional as such. And that they are interpreted as biconditionals if they are put forward as answers to an (implicit or explicit) question asking for the truth value of their consequens.

Quite similar phenomena can be observed with respect to disjunctions. Consider the following example:

(81) Are there cookies in the box?

(82) (a) (Yes,) or chocolates.

(82) (b) (Yes,) there are cookies in the box, or chocolates.

In the context of the interrogative (81), the answers (82) (a) and (b) express an exclusive disjunction. In the context of the interrogative (83), on the other hand, (84) expresses an inclusive disjunction:

(83) Are there cookies or chocolates in the box?

(84) (Yes,) there are cookies or chocolates in the box.

These results too are predicted by our interrogative-answer rule.⁶¹

To conclude this section, we have seen that exhaustivization also plays a distinctive role in the interpretation of certain answers to sentential interrogatives. In section 0, we speculated that the indicative use and interrogative use of language are mutually dependent. More specifically,

we suggested that indicatives can profitably be viewed as being used against the background of an implicitly or explicitly raised question. On that view (most) indicative use of language in fact is: providing a (partial) answer to some question. In the light of this, the results noticed above seem to provide a quite natural explanation of the fact that simple conditionals are often interpreted as biconditionals, and inclusive disjunctions as exclusive ones.

3.3.4. Qualified answers

The examples discussed in the previous sections all concern extensional sentence adverbs, i.e. adverbs that operate on the extension (truth value) of the proposition they are applied to. And exhaustivization is also an extensional semantic operation. In view of this, it is not to be expected that the results for truly intensional adverbs, such as necessarily, possibly and probably will be satisfactory as well, at least not without qualification.

As it happens, the results for necessarily and possibly are quite reasonable, if they are interpreted as purely (onto-)logical modalities, i.e. if we translate these sentence adverbs as indicated in (85):

- (85) necessarily $\sim \lambda p \forall a p(a)$
 possibly $\sim \lambda p \exists a p(a)$

If we form the interrogative answer pair $\langle \phi?, \text{Necessarily.} \rangle$ from the sentence ϕ and the S/S necessarily by (S:IA), the translation rule (T:IA) predicts that the answer simply means that it is necessarily the case that ϕ . If we form the interrogative answer pair $\langle \phi?, \text{Possibly.} \rangle$ from ϕ and possibly the translation rule predicts that the answer expresses that it is only possible that ϕ , i.e. that it is not the case that ϕ , but that ϕ is possible.

Of course, in particular in the context of an interrogative, an (onto-)logical interpretation of these sentence

adverbs used as short answers is not very plausible. In such a context, the more likely interpretation is that of a doxastic or epistemic modality.

There is a fundamental difference in the way a logical modality functions as an answer, and the way in which a doxastic or epistemic modality does. The former were considered to be part of the answer, whereas the latter are not part of the answer, but qualifications of an answer. The following examples illustrate this:

- (86) Who walks?
- (87) John, I believe.
- (88) Does John walk?
- (89) (Yes,) I believe so.
- (90) (No,) I believe not.

Clearly, the answer (87) to (86) expresses the proposition that the speaker believes that John is the one who walks. I.e. the phrase I believe qualifies the exhaustive answer John., and is not itself part of the exhaustive answer. The way to form the answer (87) is first to construct the answer John. from the abstract who walks and the term John. and next to apply the qualifier I believe to this sentential expression. Clearly, if we proceed in this way, the answer (87) will be assigned the meaning it intuitively has.

Quite the same holds for the answers (89) and (90) in the context of (88). The answer (89) expresses the proposition that the speaker believes it to be true that John walks, and (90) expresses the proposition that the speaker believes that John does not walk. In these cases too, I believe qualifies the positive or negative answer, and is not really part of it. This is perhaps even more clearly indicated in the following example:

- (91) Does John walk?
- (92) If Mary walks, I believe.

The answer (92) expresses that the speaker believes that John walks if and only if Mary walks. Hence, I believe qualifies the short and exhaustive answer If Mary walks.

What is said here about doxastic qualifications of short answers applies equally well to sentential ones. Compare (86), (87) with (93), (94) and (91), (92) with (95), (96):

(93) Who walks?

(94) John walks, I believe.

(95) Does John walk?

(96) John walks if Mary walks, I believe.

If the sentence adverbs possibly, necessarily, maybe and the like are used as doxastic or epistemic modalities, they also have to be interpreted as qualifications of exhaustive answers rather than as being part of exhaustive answers. Consider the following examples:

(97) Who walks?

John, obviously.

John, maybe.

John, of course.

(98) Does John walk?

Possibly, yes.

May be so.

Certainly not.

Of course, these are rather sketchy remarks, which deserve further scrutiny. Still, we believe that our conjecture that doxastic or epistemic modalities, in a wide sense of the word, should be viewed as qualifications of answers is borne out by the observations we made above. And hence, these kinds of answers in no way conflict with the exhaustive interpretation we assign to answers, as one might *prima facie* believe.

3.3.5. Negative sentential interrogatives

A last remark we want to make about sentential interrogative-answer pairs concerns 'negative' interrogatives. Consider the following example:

(99) Doesn't John walk?

(100) No.

If we would apply the interrogative-answer rule to the AB⁰ John doesn't walk and the S/S no to produce the pair consisting of (99) and (100), the semantic result would be that the answer No. expresses the proposition that it is not the case that John doesn't walk, i.e. that John walks. This, obviously, is incorrect. All theories treating yes and no basically as sentence modifiers run into this problem.⁶²

One way of talking oneself out of this spot is the following. A negative interrogative such as (99) should not be constructed from the negative sentence John doesn't walk, but from the same AB⁰ as its positive counterpart, i.e. the sentence John walks. Then, the answer No. expresses that, indeed, John doesn't walk. The negation that surfaces in the interrogative has no role in determining the semantic content of the interrogative, but only serves to indicate a doxastic attitude of the questioner. Roughly speaking, it indicates that the questioner expects a negative answer to the question whether John walks.

Let us point at three facts that may help to convince the reader that this is not an altogether implausible view on the matter.

First of all, it can be noticed that a negative interrogative cannot be replied to by a simple Yes.. A positive answer to a negative interrogative has to be marked in one way or another, e.g. by emphatic stress and/or do-support:

(99) Doesn't John walk?

(101) But yès, he dōes!

Such a marking, and less exhuberant ones than that in (101) could suffice as well, seems to be needed to overrule the attitude the questioner gives expression to by using a negative interrogative.

Notice that the interrogative Does John walk? itself is unmarked for doxastic attitudes on part of the questioner, and that it is also possible to ask the same question using an interrogative with a positive marking, indicating that the questioner would have expected the answer to be a positive one. In that case, a negative answer needs to be marked:⁶³

(102) John does walk, doesn't he?

(103) Yes.

(104) But nō, he doesn't.

A second point we think supports our view is that besides positive and negative marking, all sorts of other markers of doxastic or other kinds of attitudes are possible in interrogatives, which are not part of the question that is being asked, but merely serve as qualifications on behalf of the questioner. Consider the following examples:

(105) Does John come, perhaps?

(106) Do you have a pen, by any chance?

Clearly, the simple positive answer Yes. just means that John comes, and that one has a pen. So, obviously, the expressions perhaps and by any chance are not part of the semantic content of these interrogatives, i.e. do not help to determine which questions they express. They mark an attitude, i.e. they qualify the interrogatives in much the same way as negation in a negative interrogative does.

A third phenomenon that agrees with our view is the difference between such interrogatives as (107) and (108):

(107) Are you not happy?

(108) Are you unhappy?

If we are right, (107) is an interrogative that asks whether you are happy in which the questioner has marked her expectation that a negative answer will be given. So, No. as an answer to (107) means that one is not happy, and a positive answer should be marked, as in But yes, I am., and expresses that one is happy. This seems to be in agreement with intuitions. On the other hand, positive and negative answers to (108) need not be marked at all, and can be expressed by a simple Yes. or No., where these express quite the opposite from what they (when suitably marked) express as answers to (107). If the negation in (107) would be a matter of content of the interrogative, and not, as we think it is, a matter of form, this clear distinction between (107) and (108) would be an absolute mystery.

That a negative interrogative such as (99) Doesn't John walk? should be formed from a positive AS⁰ John walks, does not mean that it would be impossible to form interrogatives from negative sentences such as John doesn't walk. It seems, however, that the resulting interrogative should then not have the form of (99), but rather should have the form of something like (109):

(109) Is it so/true/the case that John doesn't walk?

The answer Yes. means that John doesn't walk, the answer No. that he does.

The phenomenon of marking by negation that a negative answer is expected can be observed in this case as well. Compare (109) with (110):

(110) Isn't it so/true/the case that John doesn't walk?

Notwithstanding the fact that (110) contains one more negation than (109), both the positive answer Yes, and the negative answer No, mean quite the same in both cases. Though a positive answer to (110) needs to be marked as indicated in (111) to overrule the expectation for a negative answer that is conveyed by the outermost negation in (110):

(111) But yès, it is true.

One last remark on this issue concerns the following. It is important to notice that on our view of the semantics of interrogatives, it is not surprising at all that negation in interrogatives can be used the way it is. What makes this possible is the fact that strictly semantically speaking, there is no difference whatsoever between the question expressed by an interrogative formed from the AB⁰ John walks, and the interrogative formed from John doesn't walk. Though these abstracts have different meanings, the interrogatives formed from them express exactly the same question. In other words, in the semantics of interrogatives, negation has no role of its own to play. And precisely this opens the possibility to put negation in interrogatives to the use it is put to.⁶⁴

This concludes what we have to say here about the interpretation of sentential interrogative-answer pairs. It will be clear by now, that the interpretation schema in figure 3 in section 2.4 gives a completely general picture of the way in which interrogative-answer pairs can be derived and interpreted. The rules (S:IA) and (T:IA), stated in section 3.2.3, which implement this schema, have been seen to apply quite generally to single constituent interrogatives, multiple constituent interrogatives and sentential interrogatives, and their constituent and sentential answers.

This means that we have completed the first of the two tasks we set ourselves in this paper, viz. to present a semantics of characteristic interrogative-answer pairs. In the next section, we will turn to the second task, viz. to show how the theory of answerhood of G&S 1984 applies to them.

4. Answers and answerhood

4.0. Introduction

In this section we will link the theory of answerhood developed in G&S 1984a, with the rules that generate and interpret interrogative-answer pairs, presented in section 3. The answerhood relations defined in G&S 1984a are relations between semantic objects, modeltheoretic entities. It is our objective to apply this theory to linguistic objects, to interrogative-answer pairs. Thus, we will define answerhood relations between interrogatives and linguistic answers. A relation of answerhood is not considered to be a syntactic relation, but a semantic one, one that applies to interpreted interrogative-answer pairs. Pragmatic considerations come in once we also take the information of the questioner into account.⁶⁵

At this point, it is important to notice that the interrogative-answer pairs that form the subject matter of this paper are of a particular kind. The constituent and sentential answers the IA-rule delivers account for the most standard ways in which questions are linguistically answered. It should be borne in mind, though, that this kind of answers has no exclusive rights. In principle, any means of expressing a proposition, more in particular any sentence, can serve to answer any question for a certain questioner in a certain situation, provided it fits her information in the proper way. For this to be the case, there need not be an inherent relation, a relation of a general semantic nature, between an interrogative and a sentence that is offered as an answer.

On the other hand, the answers in the interrogative-

answer pairs that are derived by means of the IA-rule do have such an inherent relation to the question expressed by the interrogative in the pair. The rule was designed to have this effect. Therefore, it may be expected that in this particular case, there is a non-arbitrary relationship between semantic properties of linguistic answers on the one hand, and relations of answerhood on the other. The proposition expressed by a linguistic answer is determined by the interpretation of the constituent on which it is based and on that of the abstract underlying the interrogative in the context of which it is derived.

In view of this, it may be hypothesized that certain semantic properties of the constituent are directly linked to the kind of answerhood relation that obtains between the question and the proposition. In what follows, we will see that, to a large extent, this is indeed the case. And the existence of such inherent links may be viewed as a (partial) explanation of the fact that these answers form a natural linguistic class.

The remainder of this section is organized as follows. In 4.1. we introduce various semantic notions of answerhood, which in 4.2. are related to semantic properties of constituents. In 4.3. corresponding pragmatic answerhood relations will be defined, which are again linked to corresponding pragmatic characteristics of constituents in 4.4. Throughout these sections we restrict ourselves to single constituent interrogatives, but in section 4.5. we generalize to multiple constituent interrogatives and yes/no-interrogatives.

4.1. Semantic notions of answerhood

We briefly introduce various notions of semantic answerhood in the vein of G&S 1984a.⁶⁶ In that paper we viewed questions as partitions of the set of indices and propositions as subsets of the set of indices. In what follows we will use that settheoretical terminology again, since it facilitates exposition.

We saw in section 1 that a question is an equivalence relation on the set of indices I . To every equivalence relation on a set A , there corresponds a partition of that set, a set of non-empty, non-overlapping subsets of A , the union of which equals A . The partition of the set of indices I made by a question Q , we denote by I/Q . In some cases these partitions can be represented pictorially. Two examples of such representations are given below in figure 1. A yes/no-question corresponds to a bipartition of I .⁶⁷ Constituent questions generally correspond to partitions with (many) more elements.

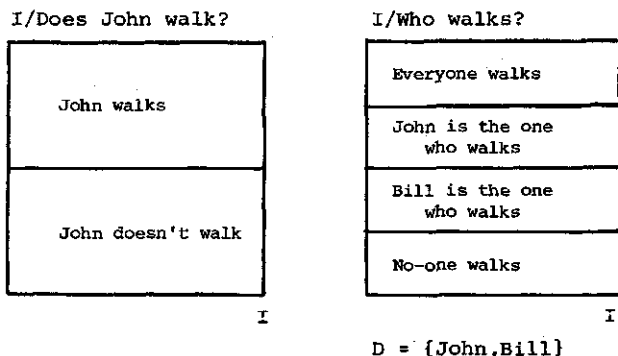

(fig.1)

The elements of a partition are sets of indices, i.e. propositions. The propositions in the partition are the possible semantic answers to the question. This leads us to the most fundamental notion of semantic answerhood, that of a proposition being a (complete) semantic answer to a question.⁶⁸

- (1) A proposition P is a semantic answer to a question Q
 iff $P \in I/Q$

A (complete) semantic answer is, of course, a limit of a

more general notion, that of a partial answer:

- (2) P is a partial semantic answer to Q iff
 $P \neq \emptyset$ & $\exists X \subset I/Q: P = \bigcup_{x \in X} x$

A partial semantic answer is the union of, a disjunction of, at least one, but not all semantic answers. I.e. such an answer excludes at least one, but not all semantic answers. As is to be expected, a (complete) semantic answer is also a partial one.⁶⁹

A more liberal notion of answerhood is one that covers propositions which imply an answer. Parallel to (1) and (2), two cases can be distinguished:

- (3) P gives a semantic answer to Q iff
 $P \neq \emptyset$ & $\exists P' \in I/Q: P \subseteq P'$
- (4) P gives a partial semantic answer to Q iff
 $P \neq \emptyset$ & $\exists X \subset I/Q: P \subseteq \bigcup_{x \in X} x$

So, a proposition gives a (partial) answer iff it is non-contradictory and implies a (partial) semantic answer. Of course, if a proposition is a (partial) semantic answer, it gives a partial semantic answer as well. These four notions are illustrated in figure 2.

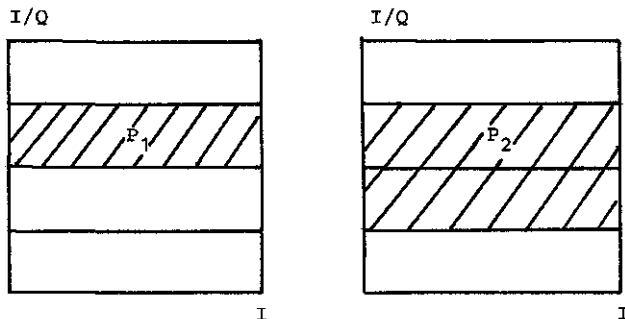

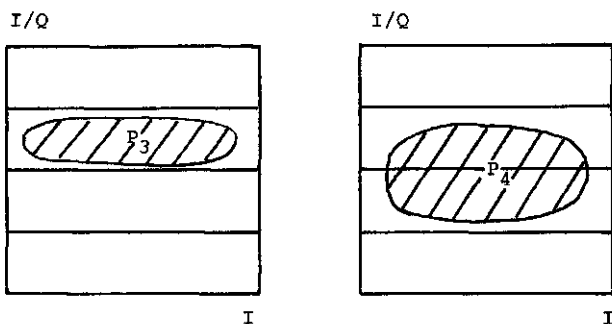

semantic	complete	partial
is	P_1	P_2
gives	P_3	P_4

(fig.2)

There is, in general not just one partial answer given by P to Q . (E.g. if $I/Q = \{A, B, C, D\}$, then if $P \subseteq A \cup B$, also $P \subseteq A \cup B \cup C$.) There is, however, always a smallest partial answer given by P , so we can speak of the unique partial answer given by P , meaning this smallest one. If P gives a partial semantic answer, there will be at least one semantic answer P' with which it is compatible (i.e. for which holds $P \cap P' \neq \emptyset$), precisely one if P gives a complete semantic answer. (And there will also be at least one semantic answer it is not compatible with.) If P gives an answer, then the unique smallest partial answer it gives is the union of, the disjunction of, the semantic answers it is compatible with:⁷⁰

(5) Let P give a partial semantic answer to Q .

The partial semantic answer to Q that P gives =
 $U\{P' \mid P' \in I/Q \ \& \ P' \cap P \neq \emptyset\}$

Clearly, if P is a (partial) semantic answer, then the

answer that P gives is P itself. So, if we look again at figure 2, the partial answers given by P_1 and P_2 , are P_1 and P_2 themselves. If a proposition merely gives an answer, things are different. The answer P_3 gives is P_1 , and the answer P_4 gives is P_2 .

Of course, we also want to define the notion of a true semantic answer at a given index. Parallel to (1)-(4), four cases can be distinguished, captured by the one following definition:

- (6) P *is/gives a true (partial) semantic answer to* Q at an index i iff
- (a) P *is/gives a (partial) semantic answer to* Q;
 - (b) the partial semantic answer to Q that P gives is true at i

Notice that if P is a true (partial) semantic answer, then P itself must be true. But if P merely gives such an answer, this need not be so. The actual index may lie inside the answer P gives, but outside P itself. (Notice that for the analogous case of being/giving a false answer, the falsity of P follows in both cases.)⁷¹

These definitions concern relations between semantic objects, between questions and propositions. We tie them to linguistic objects, to interrogatives and linguistic answers, as follows:

- (7) Let ϕ be an S-expression, and ψ an \bar{S} -expression. Then ϕ *is/gives a (true) (partial) semantic answer to* ψ (at i) iff
- [[$\lambda a \phi'$]] *is/gives a (true) (partial) semantic answer to* [[$\lambda a \psi'$]] (at i)

Nothing could be more straightforward. A sentential expression constitutes a certain type of answer to an interrogative iff the proposition expressed by the former stands in the corresponding answerhood relation to the question expressed by the

latter. Since constituent answers derived by means of the IA-rule, like sentential answers, are sentential expressions, the definition applies equally well to both kinds of answers. And notice that it applies even more generally to any pair of expressions of the appropriate categories, not just to those interrogative-answer pairs derived by the IA-rule. Any expression that is interpreted as a proposition, may constitute a certain type of answer to an interrogative. An S-expression in an interrogative-answer pair obtained by the IA-rule, however, expresses a particular kind of proposition, since it is derived in a particular way from a constituent and the abstract underlying an interrogative. These answers are characteristic linguistic answers, they form a kind of standard way of formulating an answer. This raises the question whether, due to their special status, they also are connected with a particular kind of answerhood relation. This question is to be answered in the next section.

4.2. Answers and semantic answerhood

In principle, two factors can play a role in determining connections between properties of answers and answerhood relations: the particular kind of construction embodied in the IA-rule, and independent semantic properties of the input constituent. It is particular to the IA-rule that it delivers exhaustive propositions.

Restricting ourselves to single constituent interrogatives, a proposition expressed by an answer should be an exhaustive specification of the extension of a property, the property expressed by the abstract underlying the interrogative. So, Who walks? asks for an exhaustive specification of the individuals that walk. The construction of answers embodied in the IA-rule, more in particular the operation of exhaustivization that is part of it, explicitly takes care of the aspect of exhaustiveness.

As such, however, this does not guarantee that a linguistic

answer expresses a proposition that bears some semantic answerhood relation to the question expressed by the interrogative. An example illustrating this is where the interrogative is Who walks? and the input term is the walkers. The resulting proposition that the walkers are the ones that walk, is a tautology, and hence fits no semantic relation of answerhood to the contingent question expressed by the interrogative.

Specifying the extension of the property of walking requires that the individuals belonging to this extension are (individually or collectively) semantically identified. This implies that a term from which the answer is built up, is semantically rigid.

However, even rigidity combined with exhaustiveness is not enough. The answer John or Bill, is semantically rigid (assuming that proper names are treated as rigid designators), and it is exhaustified when derived by means of the IA-rule. But the proposition it expresses in the context of Who walks? is not a complete semantic answer. It says that either John is the one who walks, or Bill is the one who walks. I.e. it is a disjunction of (two) complete semantic answers, i.e. it is a partial semantic answer. (If the fourfold partition in figure 2 is the partition corresponding to Who walks? as it was represented in figure 1, then the proposition P_2 in figure 2 is the proposition expressed by the short answer John or Bill, as it is derived by the IA-rule.) What this answer, though rigid and exhaustive, fails to do is to definitely identify the extension of the property of walking. So, definiteness is another semantic characteristic of terms that is relevant here.

These three notions of exhaustiveness, rigidity and definiteness of terms we found to be relevant here, are defined as follows:

(8) A term α is *exhaustive* iff

$$\forall \alpha X [\alpha' (\lambda \alpha X) \rightarrow \exists Y [\alpha' (\lambda \alpha Y) \wedge X \neq Y \wedge \forall z [Y(z) \rightarrow X(z)]]]$$

- (9) A term α is *rigid* iff

$$\forall a \forall i \forall X [\alpha'(\lambda a X) = ((\lambda a \alpha') (i)) (\lambda a X)]$$
- (10) A term α is *definite* iff

$$\forall a \exists X [\alpha'(\lambda a X) \wedge \forall Y [\alpha'(\lambda a Y) \rightarrow \forall z [X(z) \rightarrow Y(z)]]]$$

As will be obvious from definition (8), the property of exhaustiveness is guaranteed by the semantic operation exh (see definition (36) in section 3.1.4.).

According to definition (9), a term is rigid iff it characterizes the same set of sets of individuals at each index, i.e. iff $\lambda a \lambda X \exists P [\alpha'(P) \wedge P(a) = X]$ denotes a constant function. Examples of rigid terms are proper names, given their standard Kripkean treatment; such terms as everyone, someone, no-one, when these are taken to express unrestricted quantification over one fixed domain; and all terms expressing restricted quantification, but where the property expressed by the common noun phrase in the term is a rigid property. Further, all extensional constructions of terms from rigid terms preserve rigidity. This holds e.g. for conjunction, disjunction, negation, and -important in this context- for exhaustivization.

The definition (10) of definiteness requires a term to characterize at each index a set of sets with a unique smallest element. Examples of definite terms are proper names; terms expressing universal quantification; and definite descriptions. Conjunction and exhaustivization again preserve definiteness, but disjunction and negation do not always. Examples of indefinite terms are disjunctions of different proper names, and terms expressing existential quantification (if it is not restricted to a property which necessarily belongs to precisely one individual).⁷²

Notice that definitions (8)-(10) apply to ordinary terms, i.e. T^1 's, only. They can be generalized to cover T^n 's uniformly in a straightforward way. In fact, for T^0 's (sentence adverbs such as yes, no and if Mary walks) the results are surprisingly pleasing, as we shall see in section 4.5. below. For the moment we keep restricting ourselves to single

constituent interrogatives, and hence to answers formed from T^1 's, i.e. from ordinary terms.

The definitions (8)-(10) of the semantic characteristics of exhaustiveness, rigidity and definiteness of terms, now allow us to state some general facts about connections between these semantic properties of terms and some of the semantic notions of answerhood defined in section 4.1. If a term has certain semantic properties, and is used together with an abstract to form an interrogative-answer pair, then it is guaranteed that the question expressed by the interrogative, and the proposition expressed by the answer, stand in a certain relation of answerhood.

The first of the facts that hold here, is the following:

- (11) Let β be an AB^1 , and α a T^1 , and let $\langle \beta?, \alpha \rangle$ be an interrogative-answer pair constructed from β and α by rule (S:IA). Then the following holds:
 If α is rigid and definite, and α does not express a contradiction, then α is a (complete) semantic answer to $\beta?$

In fact, something more general holds:

- (12) Let β and α be as above.
 If α is exhaustive, rigid and definite, and $\alpha'(\lambda a \beta')$ is not a contradiction, then $[\lambda a[\alpha'(\lambda a \beta')]]$ is a (complete) semantic answer to $[\lambda a \lambda i[\beta' = (\lambda a \beta')(i)]]$

That (11) is a special case of (12) rests on the fact that the translation rule (T:IA) exhaustifies the input term α .

That (12) holds is shown by the following informal reasoning. Let a term α be rigid, definite and exhaustive. Then α characterizes at each index the same set of sets (rigidity), containing exactly one element (definiteness and exhaustiveness). Call this set of individuals A . At each index, the formula $\alpha'(\lambda a \beta')$ is true iff the denotation of

the abstract β' equals A. Given that $\alpha'(\lambda a \beta')$ is true at at least one index (non-contradictoriness), the proposition $\llbracket \lambda a [\alpha'(\lambda a \beta')] \rrbracket$ is an element of the partition on I that corresponds to the question $\llbracket \lambda a \lambda i [\beta' = (\lambda a \beta')(i)] \rrbracket$. For, each element in this partition characterizes a set of indices at which the denotation of the abstract β' is the same.

The converse of (12) (and of (11)) does not hold in general. Consider the following formal counterexample.

- Let β be an AB^1 , translating as $\lambda x G(a)(x)$ ("Who G's?").
 Let α be a T^1 , translating as $\lambda P \exists y [F(a)(y) \wedge P(a)(y)]$ ("an F").
 Then $\alpha'(\lambda a \beta') = \exists y [F(a)(y) \wedge G(a)(y)]$ ("An F G's.").
 Let us further make the following assumptions:
- (a) $\forall i: [G](i) = \{a\} \vee [G](i) = \{b\}$
 - (b) $\neg \exists i: b \in [F](i)$
 - (c) $\exists i \exists x: x \in [G](i) \ \& \ x \in [F](i)$
 - (d) $\exists i \exists j: [F](i) \neq [F](j)$
 - (e) $\exists i \exists x \exists y: x \neq y \ \& \ x \in [F](i) \ \& \ y \in [F](i)$

Assumption (c) guarantees that an F G's is non-contradictory. Assumption (d) says that an F is non-rigid, and assumption (e) implies that it is also neither definite, nor exhaustive. Given the nature of the abstract assumed in (a), and the relation between the predicates G and F assumed in (b), it holds in every model M satisfying (a)-(e) that An F G's is a complete semantic answer to Who G's?, even though an F is neither rigid, nor definite, nor exhaustive.

More concretely, suppose that M is as specified below:

- $D = \{a, b, c\}; I = \{i, j\}$
 $[F](i) = \{a\}; [F](j) = \{a, c\}$
 $[G](i) = \{a\}; [G](j) = \{b\}$

In this model, $\llbracket \lambda a \lambda i [G(a) = G(i)] \rrbracket = \{\{i\}, \{j\}\}$, and $\llbracket \lambda a \exists y [F(a)(y) \wedge G(a)(y)] \rrbracket = \{i\}$. So, indeed, the latter is a complete semantic answer to the former.

A less dramatic, but more natural counterexample to the

converse of (12) is the following interrogative-answer pair:

(13) Which prime number did John write on the blackboard?

(14) An even number.

Assuming the common noun number to express a rigid property, the term an even number, is rigid, but neither definite, nor exhaustive. Even if by applying the IA-rule to obtain the answer (14), the term is exhaustified, it still remains indefinite. But nevertheless, (14) is a complete semantic answer to (13).

Notice that (11) and (12) imply that if a term α is rigid, definite and exhaustive, it cannot give rise to a proposition which merely gives a semantic answer. Suppose α would give a semantic answer without being one. Then it would contain more information than a semantic answer does. This extra information would have to be contained already in the term α . So, α' would have to be equivalent with some expression $\lambda P[\gamma'(P) \wedge \phi']$, where γ' is the translation of some rigid, definite and exhaustive term, and ϕ' expresses the extra information. Disregarding exhaustiveness, a natural language example is the term John, who lives in Boston, where γ is the term John, and ϕ expresses the information contained in the non-restrictive relative clause. It can be shown, however, that such a term, even if it is subjected to exhaustivization, will never be both rigid, definite and exhaustive. Notice that for $\lambda P[\gamma'(P) \wedge \phi']$ to give an answer, ϕ' should be non-contradictory. If it is merely to give an answer, ϕ' should be non-tautologous as well. So, ϕ' should be contingent. At an index at which ϕ' is true, $\lambda P[\gamma'(P) \wedge \phi']$ denotes the same set of properties as α' . And at an index at which ϕ' is false, the term denotes the empty set. Hence, this term cannot be definite. And since α' does not denote the empty set at each index (since by hypothesis it gives rise to an answer), it is not rigid either.

However, such terms do have semantic characteristics which are related to those of rigidity and definiteness, and which guarantee that terms that have them give a semantic answer.

These properties are called 'semi-rigidness' and 'semi-definiteness', and they are defined as follows:⁷³

(15) a term α is *semi-rigid* iff

$$\forall a[\forall i\forall X[\alpha'(\lambda aX) = ((\lambda a\alpha')(i))(\lambda aX)] \vee \neg\exists X: \alpha'(\lambda aX)]$$

(16) a term α is *semi-definite* iff

$$\forall a[\forall X[\alpha'(\lambda aX) \rightarrow \forall Y[\alpha'(\lambda aY) \rightarrow \forall z[X(z) \rightarrow Y(z)]]] \vee \neg\exists X: \alpha'(\lambda aX)]$$

A term is semi-rigid iff at each index it characterizes the same set of sets, or the empty set. The latter will happen if the additional information contained in a term is false at an index. In other words, a term is semi-rigid iff at every index at which the additional information is true, it characterizes the same set of set of individuals.

Similarly, a term is semi-definite if at every index at which the additional information is true, it characterizes a set of sets with a unique smallest element. Notice that if a term is rigid, it is semi-rigid as well, and if it is definite, it is semi-definite too.

We can now state a second general fact concerning a connection between certain semantic properties of terms and a notion of answerhood.

(17) Let β be an AB^1 , and α a T^1 . Then the following holds:

If α is semi-rigid, semi-definite and exhaustive, and $\alpha'(\lambda a \beta')$ is not a contradiction, then $\llbracket \lambda a[\alpha'(\lambda a \beta')] \rrbracket$ gives a (complete) semantic answer to $\llbracket \lambda a\lambda i[\beta' = (\lambda a \beta')(i)] \rrbracket$

As we saw above, characteristic examples of terms with these properties are terms with non-restrictive relative clauses. Answers to interrogatives which are constructed from such terms by means of the IA-rule, indeed give a semantic answer. Consider the following example:

- (18) Who kissed Mary?
 (19) John, who really loves her.

According to the translation rule (T:IA), (19), in the context of (18), means the same as (20):

- (20) John is the one who kissed Mary, and John really loves Mary

And (20) indeed implies the semantic answer expressed by (21):

- (21) John is the one who kissed Mary

This example can also be used to illustrate the point made in section 4.1 that a proposition which merely gives an answer, can give a true answer without being true itself. In our example, (20) (being what (19) expresses in the context of (18)) might be false, but at the same time it might still give the true answer (21). This happens if in fact John is the one who kissed Mary, but does not really love her.

So far, we have only stated connections between properties of terms and semantic notions of complete answerhood. But such connections also exist between semantic properties of terms and semantic notions of partial answerhood. At the beginning of this section we saw that a term like John or Bill, if interpreted exhaustively, precisely lacks the power to be a complete semantic answer because it lacks the property of definiteness. But, of course, it is a prime example of a term that gives rise to a partial semantic answer. It is the property of definiteness that distinguishes between complete and partial semantic answers.

This leads us to the formulation of the last two facts concerning the connection between semantic properties of terms and semantic notions of answerhood that we want to discuss here.

- (22) Let β be an AB^1 , and α a T^1 . Then the following holds:
 If α is rigid and exhaustive, and $\alpha'(\lambda\alpha\beta')$ is a contingency, then $[\lambda\alpha[\alpha'(\lambda\alpha\beta')]]$ is a partial semantic answer to $[[\lambda\alpha\lambda i[\beta' = (\lambda\alpha\beta')(i)]]]$
- (23) Let β and α be as above. Then the following holds:
 If α is semi-rigid and exhaustive, and $\alpha'(\lambda\alpha\beta')$ is a contingency, then $[\lambda\alpha[\alpha'(\lambda\alpha\beta')]]$ gives a partial semantic answer to $[[\lambda\alpha\lambda i[\beta' = (\lambda\alpha\beta')(i)]]]$

Requiring $\alpha'(\lambda\alpha\beta')$ to be contingent, rather than merely non-contradictory, as in (12) and (17), is needed to ensure that the proposition indeed excludes at least one possible semantic answer, as the notions of partial semantic answerhood require. Otherwise, a term such as no-one or at least someone, which is indeed rigid, would qualify as being a partial answer to every interrogative of the form Who G's? But of course, it never is.

To summarize our findings in this section: we have seen that our four main notions of semantic answerhood are intimately related to semantic properties of terms.⁷⁴ The semantic property of exhaustiveness is involved in all four notions of answerhood. The weakest notion of giving a partial semantic answer further requires semi-rigidness. In giving a complete semantic answer the notion of semi-definiteness comes in as well. The difference between giving an answer and being an answer lies in the difference between semi-rigidness and semi-definiteness and full rigidness and full definiteness.

Semantic notions of answerhood are interesting in their own right, but question-answering is first and foremost a matter of pragmatics. The purpose of answering a question is to fill in a gap in the information of the questioner. We therefore turn in the next two sections to pragmatics.

4.3. Pragmatic notions of answerhood

In the previous section, we have seen that there are indeed strong connections between certain semantic properties of terms and various notions of semantic answerhood. Specific kinds of linguistic answers, being of a certain form and having a certain content, derived from terms which exhibit special semantic properties, are singled out as a kind of standard answers.

On the one hand, this is quite satisfactory, because such standard answers do have a special status in natural language communication. For example, in highly institutionalized situations of question-answering, such as interrogations in the Court Room, or in quizzes, standard answers, and more in particular semantically rigid answers, are called for. Often, if a non-standard answer has been given by the interrogated person, the official interrogator will try to elicit a standard answer containing rigid designations. And he will do this even in case, from an ordinary communicative point of view, the original non-standard answer was already perfectly in order, and the elicited answer does not add anything to its communicative content. It is quite literally a formality that in such situations standard rigid answers are required.⁷⁵ In fact, not only under such rather peculiar circumstances do standard answers have a special role, in ordinary communicative situations they are, other things being equal, preferred as well. They serve to express propositions that count as answers solely in virtue of their meaning. No other information besides linguistic knowledge is needed to get at what one is after, an answer.⁷⁶

On the other hand, though all this may be true, it takes little effort to observe that as often as not, answers based on semantically non-rigid terms, such as definite descriptions, are used quite successfully in question-answering. I.e. in

actual speech situations in which information is exchanged, answers based on semantically non-rigid terms can serve quite well to give the questioner a complete or a partial answer. They need not always have this effect, but they can, and, and this is important, whether they will depends on the information that is already available to the speech participants. Whether or not a certain linguistic answer serves its purpose in an actual speech situation, does not only depend on its meaning, i.e. is not only a matter of semantics, but depends also on the information already available to the questioner, i.e. is also a matter of pragmatics.

This introduces the notion of information as a pragmatic parameter in determining pragmatic notions of answerhood. If we are to lay down definitions which tell us (at least part of the story of) when a proposition is an answer to a question for a certain questioner, we are to do this relative to the information of the questioner. Such definitions of pragmatic notions of answerhood were given in G&S 1984a. We introduce quite similar notions here. These pragmatic notions are quite like their semantic counterparts, except for the fact that a new parameter is introduced, that of an information set. An information set is a non-empty set of indices, a subset of the total set of indices. It is to be thought of as a, quite simple-minded, representation of the information of the questioner.⁷⁷

Just as a question Q makes a partition I/Q on the total set of indices I , it also makes a partition J/Q on a non-empty subset J of I .⁷⁸ Figure 3 gives a pictorial representation of a simple example.

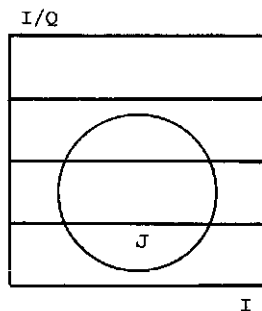

(fig.3)

In the situation depicted in figure 3, one of the possible semantic answers is already excluded by the information of the questioner. But Q is still the question in the information set J . Several answers are still possible as far as this information goes, J/Q has still several elements. So, we define:

- (24) Q is a question in an information set J iff
 $\exists X \exists Y: X, Y \in J/Q \ \& \ X \neq Y$

A question Q will be answered, i.e. is solved, in the information if no such alternatives exist any more, i.e. if J/Q has only one element, being J itself.

We are now ready to state the pragmatic counterparts of the semantic notions of a proposition being or giving a complete or a partial answer to a question. These pragmatic relations of answerhood, again, are relations between semantic, modeltheoretic entities, viz. propositions, questions and information sets. In terms of them we will again define the corresponding relations between linguistic entities, viz. interrogatives and linguistic answers. In section 4.4 we will examine whether in these cases too there are connections between properties of terms and these pragmatic notions

of answerhood.

First we define the notion of a (complete) pragmatic answer:

(25) Let Q be a question in J .

P is a pragmatic answer to Q in J iff $P \cap J \in J/Q$

The upshot of this definition is that P is a (complete) pragmatic answer to Q in J , if adding P to the information set J (i.e. taking the intersection of P and J) results in an information set in which the question Q is solved.⁷⁹

The notion of a partial pragmatic answer is defined as follows:

(26) Let Q be a question in J .

P is a partial pragmatic answer to Q in J iff

$P \cap J \neq \emptyset$ & $\exists X \subset J/Q: P \cap J = \bigcup_{x \in X} x$

According to this definition, P is a partial pragmatic answer if adding it to the information set J (provided that it is compatible with J in the first place) excludes at least one answer which hitherto was admitted.

The two corresponding notions of giving a complete or a partial answer are captured by (27) and (28):

(27) Let Q be a question in J .

P gives a pragmatic answer to Q in J iff

$P \cap J \neq \emptyset$ & $\exists P' \in J/Q: P \cap J \subseteq P'$

(28) Let Q be a question in J .

P gives a partial pragmatic answer to Q in J iff

$P \cap J \neq \emptyset$ & $\exists X \subset J/Q: P \cap J = \bigcup_{x \in X} x$

Analogous to the semantic counterparts, a proposition gives a complete or a partial pragmatic answer if it pragmatically implies (i.e. implies in conjunction with the information J) a complete or a partial pragmatic answer (all this, again, provided that the proposition is compatible with J to begin with).

Each of the four representations in figure 4 below illustrates one of the pragmatic notions of answerhood defined above:

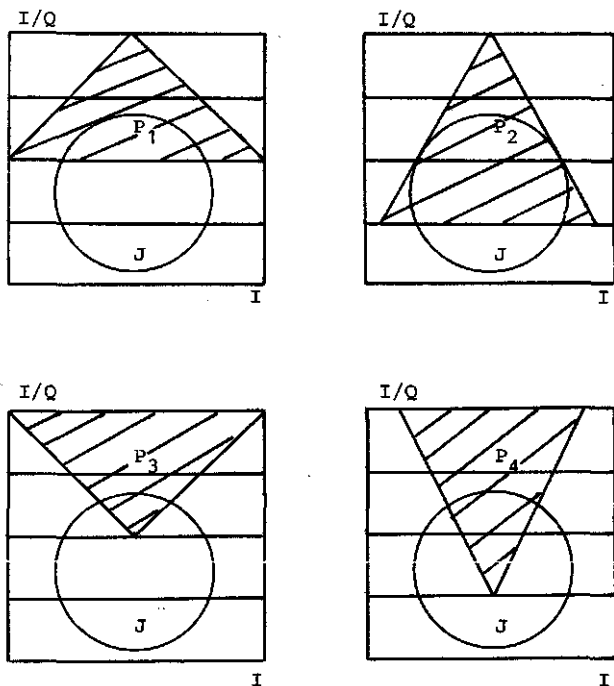

pragmatic	complete	partial
is	P_1	P_2
gives	P_3	P_4

(fig.4)

The four notions of being or giving a complete or a partial pragmatic answer not only run quite parallel to the corresponding semantic notions, the semantic notions are even a

limit of the pragmatic ones. For $J = I$, the two sets of definitions coincide.⁸⁰ An information set being equal to the total set of indices represents the situation in which one has no factual information at all. To such a tabula rasa, only standard semantic answers can answer questions.

The dependencies that were observed to hold between the different semantic notions of answerhood in section 4.1. hold equally well between their pragmatic counterparts. To be an answer implies to give one, and to be or to give a complete answer implies to be or to give a partial one. Further it holds that if $J' \subseteq J$ and P stands in a certain type of pragmatic answerhood relation to Q in J , than P stands in that same type of relation to Q in J' , provided that Q is a question in J' as well and that P is compatible with J . In view of the fact just noted, that semantic answerhood is a limit of pragmatic answerhood, this means that if P bears a certain semantic answerhood relation to Q , it bears the corresponding pragmatic answerhood relation to Q in any information set, under the same provisos as made above. If $J' \subseteq J$, and P stands in a certain answerhood relation to Q in J , it may stand in a 'stronger' relation to Q in J' . If P merely gives an answer in J , P may be an answer in J' . And if P is or gives a merely partial answer in J , it may be or may give a complete answer in J' .

As was the case for semantic answerhood, we are also interested in the notion of a true pragmatic answer. We saw in section 4.1. that a proposition can merely give a true semantic answer without being true itself, whereas it has to be true itself if it is to be a true semantic answer. But false propositions can not only merely give, but can also be true pragmatic answers. And further, and this is something to be quite happy about, if not all our information happens to be true, i.e. if J (being the conjunction of all our information) is false, this does not prevent us from getting true answers either.⁸¹

This being as it is, the notion of a true pragmatic answer needs to look over the borders of an information set.

If we have to decide whether P gives a true pragmatic answer in J, we have to see whether the (partial) semantic answer determined by P with respect to J, is true. So, we need the following pragmatic analogue of the notion defined in (5) in section 4.1. of the semantic answer given by a proposition:⁸²

- (29) Let P give a partial pragmatic answer to Q in J.
 The partial semantic answer to Q determined by P in J =
 $U \{P' \mid P' \in I/Q \ \& \ P' \cap J \neq \emptyset\}$

This notion can be illustrated by comparing figures 4 and 2. The (partial) semantic answers determined by the pragmatic answer P_1 - P_4 in figure 4, are P_1 - P_4 in figure 2 respectively.

This leads us to the following definition of true pragmatic answerhood:

- (30) P *is/gives a true (partial) pragmatic answer to Q in J at i* iff
- (a) P *is/gives a (partial) pragmatic answer to Q in J;*
 - (b) *the partial semantic answer to Q determined by P in J is true at i*

The pragmatic notions of answerhood defined in (25)-(28) and in (30) concern relations between modeltheoretic objects. In definition (31) they are applied in a definition of pragmatic answerhood as a relation between linguistic objects:

- (31) Let ϕ be an S-expression, and ψ an \bar{S} -expression.
 Then ϕ *is/gives a (true) (partial) pragmatic answer to ψ in J (at i)* iff $[\lambda a \phi']$ *is/gives a (true) (partial) pragmatic answer to $[\lambda a \psi']$ in J (at i)*

As was the case with the corresponding semantic definition (7), our pragmatic definition (31) applies to any pair consisting of an interrogative and a sentential expression. Our IA-rule forms a special subset of such interrogative-answer pairs. In the next section we will see that under

certain pragmatic conditions they guarantee that certain pragmatic relations of answerhood hold between interrogatives and answers that are derived by means of the rule.

4.4. Answers and pragmatic answerhood

We saw that the pragmatic notions of answerhood defined in the previous section run parallel to the corresponding semantic notions defined in 4.1. This suggests that we may find the same kind of connections between properties of terms and the various pragmatic notions of answerhood as we found in section 4.2 between such properties and semantic notions. Since our notions of pragmatic answerhood are pragmatic analogues of our semantic notions, the properties of terms involved can be expected to be pragmatic analogues of the semantic properties defined in section 4.2. Such notions of pragmatic exhaustiveness, pragmatic rigidity, and pragmatic definiteness are defined in (32)-(34). They differ from their semantic comrades defined in (8)-(10) only in that they are relativized to an information set J , i.e. that quantification over indices is restricted to indices in J .

- (32) A term α is *pragmatically exhaustive in J* iff
 $\forall a \in J \forall X [\alpha'(\lambda a X) \rightarrow \exists Y [\alpha'(\lambda a Y) \wedge X \neq Y \wedge \forall z [Y(z) \rightarrow X(z)]]]$
- (33) A term α is *pragmatically rigid in J* iff
 $\forall a \in J \forall i \in J \forall X [\alpha'(\lambda a X) = ((\lambda a \alpha') (i)) (\lambda a X)]$
- (34) A term α is *pragmatically definite in J* iff
 $\forall a \in J \exists X [\alpha'(\lambda a X) \wedge \forall Y [\alpha'(\lambda a Y) \rightarrow \forall z [X(z) \rightarrow Y(z)]]]$

Whether or not a term has one or more of these pragmatic properties depends not only on its semantic interpretation (which is assumed to be shared by all speech participants), but also on the information one has. Notice that, J being a subset of I , it is 'easier' for a term to have one of these pragmatic properties than it is for it to have the corres-

ponding semantic property. This explains why in actual speech situations, in which a lot of information is available, it is so much easier to provide efficient and adequate answers than semantics proper suggests. And this supports the view that an interesting theory of question-answering cannot do without a semantically based pragmatics.

Completely analogous to (12) and (22), which state connections between the semantic properties of exhaustiveness, rigidity and definiteness of terms and the notions of being a complete or a partial semantic answer, we can state the following two facts:

- (35) Let β be an AB^1 , α a T^1 , and J an information set. Then the following holds:
 If α is pragmatically exhaustive, pragmatically rigid and pragmatically definite in J , and
 $\llbracket \lambda \alpha[\alpha'(\lambda \beta')] \rrbracket \cap J \neq \emptyset$, then
 $\llbracket \lambda \alpha[\alpha'(\lambda \beta')] \rrbracket$ is a (complete) pragmatic answer to
 $\llbracket \lambda \lambda i[\beta' = (\lambda \beta')(i)] \rrbracket$ in J
- (36) Let β and α be as above. Then the following holds:
 If α is pragmatically exhaustive and pragmatically rigid in J , and $\llbracket \lambda \alpha[\alpha'(\lambda \beta')] \rrbracket \cap J \neq \emptyset$, and
 $\llbracket \lambda \alpha[\alpha'(\lambda \beta')] \rrbracket \cap J \subset J$, then
 $\llbracket \lambda \alpha[\alpha'(\lambda \beta')] \rrbracket$ is a partial pragmatic answer to
 $\llbracket \lambda \lambda i[\beta' = (\lambda \beta')(i)] \rrbracket$ in J

Analogous to (17) and (23), similar facts hold concerning connections between giving a (partial) pragmatic answer and pragmatic semi-rigidity and pragmatic semi-definiteness. We will leave out the definitions of these pragmatic properties of terms and of the corresponding connections with pragmatic answerhood, since they can be obtained from their semantic counterparts in a way completely similar to those stated in (31)-(36).⁸³

Let us briefly and informally illustrate (31)-(36) by considering some examples. A first example concerns pragmatic rigidity:

(37) Whom did you talk to?

Your father.

Intuitively, the answer in (37) can hardly fail to be a complete pragmatic answer to the question expressed by the interrogative. But notice that the term your father is not semantically rigid.⁸⁴ So, the term does not give rise to a complete semantic answer. But the term is pragmatically rigid in the information set of anyone who knows who his/her father is. In the information set of any such person, the answer in (37) will be a complete pragmatic answer to the question expressed by the interrogative. Pragmatic definiteness is already secured by the semantic interpretation of the term, it is semantically definite, and hence cannot fail to be pragmatically definite as well. Pragmatic exhaustiveness is secured by the way in which (37) is constructed by the IA-rule. This guarantees semantic exhaustiveness, and hence pragmatic exhaustiveness as well.

Our second example also concerns pragmatic rigidity:⁸⁵

(38) Who won the Tour de France in 1980?

The one who ended second in 1979.

In the information set of anyone who has the information that Joop Zoetemelk ended second in the Tour de France of 1979, the term on which the answer in (38) is based is pragmatically rigid, and hence the answer will be a complete pragmatic answer to the interrogative for such a person. (Pragmatic exhaustiveness and definiteness are secured in the same way as in our first example.)

We saw in section 4.2. that definite descriptions are not, in general, semantically rigid. They are so only in case the common noun phrase occurring in them is semantically rigid. Pragmatic rigidity requires this property to be rigid only with respect to the information set. What this amounts to is that a definite description is pragmatically rigid for someone who has the information who the referent of the

description is.

The example (38) may also serve to illustrate what was remarked above about the notion of a true pragmatic answer. Joop Zoetemelk did indeed end second in the Tour de France of 1979, so, anyone having this information does not only receive a complete answer, but even a true complete answer to his question. Suppose, however, that our questioner mistakenly believes that Eddy Merckx ended second in 1979. Then he still receives a complete pragmatic answer, but this time the false one that Eddy Merckx won the 1980 edition. The more intriguing case is the one in which a false proposition nevertheless gives a complete true answer. Such a thing happens, for example, if our questioner wrongly believes that Joop Zoetemelk was the winner in 1979 and his interrogative is (38) is answered by (39):

(39) The one who won in 1979.

The proposition expressed by (39) in the context of the interrogative in (38), viz. that the one who won the Tour de France in 1979, won again in 1980, is false. But to our misinformed questioner it carries over the true information that Joop Zoetemelk won the Tour de France in 1980. So, a false proposition can be a true complete pragmatic answer.

Our last example illustrates pragmatic definiteness:

(40) Who served you when you bought these boots?

An elderly lady wearing glasses.

The term on which the answer in (40) is based is neither semantically rigid, nor semantically definite. Still, within the information of the salesmanager who asks this question, it is quite likely that the answer is a complete pragmatic answer. If the property of being an elderly lady wearing glasses applies to a single member of the staff, the salesmanager's information will enable her to identify the person referred to in the answer of the client. I.e. in that case,

the semantically non-rigid and non-definite term an elderly lady wearing glasses will be pragmatically definite and rigid in the information set of the salesmanager.⁸⁷

The example (40) illustrates quite clearly under what kind of communicative circumstances indefinite, non-rigid terms constitute perfectly good answers. It is the kind of situation in which the speech participants have disharmonious information about a certain subject matter, but nevertheless are to achieve effective exchange of information. The salesmanager will be quite well acquainted with the members of her staff, but she probably has no idea as to who of them served the customer. The latter may at least be able to give a faint description of the person who served him. By performing the piece of question-answering recorded in (40) they achieve close informational harmony. Their linguistic cooperation leads them to coordination of information with little effort.

A last remark to be made in this section concerns the fact that the connections between pragmatic properties of terms and pragmatic relations of answerhood, like in the semantic case, run only in one direction. Such properties suffice to guarantee that such relations hold, but they are not necessary for that. For the semantic case this was shown in a rather formal way in section 4.2. But, in fact, the intuitive reason behind it is quite clear. Consider the following example:

(41) From which authors did the editors already receive their contribution to the proceedings?

I don't know, but at least they received it from Professor A.

The answer in (40) could also be formulated more shortly as in (42):

(42) At least from Prof. A.

Suppose our questioner knows that Prof. A. is bound to be the last one to send in his contribution. (The reader will have no difficulty to come up with his own natural example.) Then the explicitly non-exhaustive answer (42) will give our questioner the exhaustive, definite, and maybe even rigid answer that the editors have received the contribution of each author already. Nevertheless, the term on which (42) is based, as such, will keep lacking the relevant pragmatic properties. It is only in connection with the content of the abstract underlying the interrogative in (41), that an exhaustive answer results within the information set of our questioner. It are the particular habits of Prof. A. in sending in his contributions to proceedings that help him out in this case. For suppose, though this is unlikely, that Prof. A. is also always the first to accept an invitation to attend a conference, then the same answer (42) will be of little help to get a complete answer to the question posed by (43):

- (43) From whom did the organizers already receive a letter of acceptance to attend the conference?

Going back to the semantic examples in section 4.2, we see that there exactly the same phenomenon is at work. No matter what, the term an even number is as indefinite as a term can be. It is only in the context of being a prime number, a property referred to in the interrogative Which prime number did John write on the blackboard?, that this answer results in a proposition identifying a definite number.⁸⁸

So, to conclude this remark, the nature of a term on which an answer is based, may, as such, already guarantee that a certain relation of answerhood holds. But such a relation may obtain also on the basis of the interpretation of the term in the context of a certain interrogative.

These examples may suffice to show that the various pragmatic notions of answerhood do indeed give us the means to account for intuitive relations of answerhood which are

not covered by semantics. Intuitively, a definite description may be just as good an answer as, say, a proper name.⁸⁹ Moreover, in many cases only descriptions, definite or merely indefinite, may be available.⁹⁰ Our notions of pragmatic answerhood not only allow us to take into account such answers, they also explain under what kind of circumstances they count as answers.

At the same time, our pragmatics confirms, so to speak, our semantic analysis. For in effect, the pragmatic notions are firmly based on the semantic ones. The former are straightforward relativizations of the latter. This relativization may well be circumscribed as taking into account the fact that interrogatives are the linguistic means to get the gaps in one's information filled.

To close the circle opened at the beginning of section 4.3, one may say that the semantic notions are just special instances of the corresponding pragmatic notions. Semantic answers are the answers one is to address to a questioner who has no factual information at all.⁹¹ Since we know our information about the information of others to be imperfect, but do not always know where these imperfections are exactly located, the safest way to answer a question is to stay as close to semantic answers as one possibly can. This explains their role as standards of answering questions, which in certain highly institutionalized forms of question-answering are the kind of answers called for, even if from the perspective of ordinary daily communication other kinds of answers could do the job just as well.

4.5. Multiple and zero-constituent answers

In the preceding sections we have restricted ourselves to single constituent interrogatives and their answers. In this last section we will briefly indicate how what was said above can be generalized to sentential (zero-constituent) and multiple constituent interrogatives and their answers. As for

the latter, nothing really exciting can be added to what already has been said, but as to the former, we will note some rather interesting consequences.

The only point at which the restriction to single constituent interrogatives played a role in the preceding sections was in establishing connections between properties of terms and relations of answerhood. We defined the notions of semantic and pragmatic exhaustiveness, rigidness and definiteness for ordinary terms, T^1 's, only. Their generalizations to T^n 's are straightforward, we will only give them here for semantic exhaustiveness, rigidness and definiteness.

$$(44) \text{ A } T^n \alpha \text{ is exhaustive iff}$$

$$\forall \alpha \forall R^n [\alpha'(\lambda a R^n) \rightarrow \neg \exists S^n [\alpha'(\lambda a S^n) \wedge R^n \neq S^n \wedge \\ \forall x_1 \dots x_n [S^n(x_1 \dots x_n) \rightarrow R^n(x_1 \dots x_n)]]]$$

$$(45) \text{ A } T^n \alpha \text{ is rigid iff}$$

$$\forall \alpha \forall R^n [\alpha'(\lambda a R^n) = ((\lambda a \alpha')(i))(\lambda a R^n)]$$

$$(46) \text{ A } T^n \alpha \text{ is definite iff}$$

$$\forall \alpha \exists R^n [\alpha'(\lambda a R^n) \wedge \forall S^n [\alpha'(\lambda a S^n) \rightarrow \\ \forall x_1 \dots x_n [R^n(x_1 \dots x_n) \rightarrow S^n(x_1 \dots x_n)]]]$$

For $n > 1$, an explanation of these notions would add little to what already was said in section 4.2. with respect to (8)-(10), which deal with the special case in which $n = 1$. It may suffice to note that if a simple T^n is constructed from exhaustive, rigid or definite T^1 's, it has these respective properties itself as well. As far as conjunctions and disjunctions of T^n 's are concerned, exhaustiveness and rigidness are preserved under both conjunction and disjunction, definiteness is only preserved under conjunction.

Equipped with these generalized versions of the definitions of the semantic properties of exhaustiveness, rigidness and definiteness, and given the fact that the related notions of semi-rigidness and semi-definiteness, and the corresponding pragmatic notions, can be obtained in a similar way, the statements (12), (17), (22), (23), (35) and (36) concerning

the connections between such properties of terms and the various semantic and pragmatic notions of answerhood, apply quite generally to n-constituent interrogatives and their answers. It suffices to replace the precondition in these statements 'Let β be an AB^1 , and α a T^1 ', by the more general precondition 'Let β be an AB^n , and α a T^n '.

A final point that deserves some discussion, is what happens in the special case where $n = 0$, i.e. the case in which the general notions apply to sentential interrogatives and their answers.

First of all, notice that the T^0 's yes and no, as they were defined in (66) in section 3.3.2, are exhaustive, rigid and definite according to (44)-(46). To see this, notice that in case $n = 0$ the variables R^n and S^n quantified over in (44)-(46) are variables of type t , i.e. variables which range over $\{1,0\}$, i.e. over the True and the False. When applied to yes, (44) amounts to stating the tautology that there is only one True, and when applied to no, it says that there is only one False. What (45) expresses in these two cases is that the True is the True, and that the False is the False, respectively. And (46) comes down to the statement that the True and the False exist.

What this means is that when applied to yes and no and a sentential (yes/no-)interrogative, (12) states that the sentential answers Yes. and No. cannot fail to be complete semantic answer to the question expressed by that interrogative, which to us does not seem to be altogether unlikely.

Secondly, if one applies (44)-(46) to a T^0 of the form if ϕ , it can be observed that, no matter what sentence we fill in for ϕ , the phrase will be definite. But it will not always be rigid. It will be rigid iff ϕ is rigid, i.e. iff ϕ is a tautology or a contradiction. If ϕ is a contingency, it is not. Speaking in pragmatic terms, this means that if ϕ will be pragmatically rigid iff either the proposition that ϕ , or the proposition that not- ϕ belongs to the information set, i.e. iff ϕ is true throughout J , or false throughout J . The property of exhaustiveness will in any case be

taken care of by applying the IA-rule.

To see what all this means, consider the following examples:

(47) Will you come to the party?

(48) If $2 + 2 = 4$.

(49) If $2 + 2 = 5$.

(50) If Mary comes.

In view of the fact that if $2 + 2 = 4$ is exhaustive, rigid and definite, as we have just seen, our statement (12) predicts that (48) is a complete semantic answer to (47) (or to any other sentential interrogative). It simply means the same as Yes.. In view of the fact that if $2 + 2 = 5$ is rigid and definite, and will be exhaustified by the application of the IA-rule (the phrase in the previous example was already exhaustive in its own right), (12) predicts that (49) is a complete semantic answer as well, and simply means No.

Since Mary comes is a contingency, there is no guarantee that (50) will be a semantic answer. But it may very well be a complete pragmatic answer. It is so, both in case the questioner has the information that Mary comes, and in case he has the information that Mary does not come. In the first case, the phrase if Mary comes is pragmatically exhaustive, rigid and definite. In the second case it is pragmatically rigid and definite as well, and is exhaustified by means of the IA-rule. So, in both cases (50) will be a complete pragmatic answer, as (35) predicts. Thus, by the aid of the information one has about whether Mary comes or not, (50) may constitute a positive, or a negative complete pragmatic answer to the question raised by (47).⁹²

To us, it seems that these results are the ones one would like to get. The predictions seem to be in accordance with our semantic and pragmatic intuitions. These examples, by the way, also strongly support the correctness of incorporating exhaustivization in the IA-rule which produces and interprets

characteristic interrogative-answer pairs. There is no doubt, we think, that (49) means No. quite as clearly as (48) means Yes., and that, pragmatically speaking, (50) means No. for someone who has the information that Mary does not come, with quite the same force as it means Yes. for someone who has the opposite information that she does come. But only in the yes-cases are the answers exhaustive in their own right. In the no-cases, exhaustiveness really needs to be imparted on the answers from the outside, if we are to obtain these, we feel pleasing, results. And the IA-rule neatly takes care of this.

5. Exhaustiveness and pragmatics

There is one point which we carefully avoided mentioning up to now, a point which we suspect must have crossed the mind of many a reader. One may have granted us that constituent interrogatives ask for an exhaustive specification of the extension of a property or relation. Consequently, one may have agreed that characteristic linguistic answers should receive an exhaustive interpretation, an interpretation which as such, i.e. in isolation, they do not have. Suppose we have reached this much, in other words, suppose we have convinced the reader that the propositions which our analysis connects with characteristic answers, are indeed the propositions they convey. That would be wonderful. But even if so, one might have fundamental doubts about the way in which our analysis leads to these results. In this analysis, exhaustiveness is a semantic property of characteristic answers, exhaustivization comes in as a semantic operation on the constituent(s) from which a linguistic answer is derived. Why, one may ask, isn't exhaustiveness simply obtained as a conversational implicature? If anything is a good candidate for implicaturehood, exhaustiveness of answers is, or so it seems. We quite agree. If an interrogative asks for an exhaustive specification, anything put forward as an answer will quite naturally be interpreted as such, provided that it is not made quite explicit that this conclusion should not be drawn. Exhaustiveness of answers prima facie seems to be a prime example of a conversational implicature that should be explicitly cancelled to prevent it from being drawn as a justified pragmatic conclusion.⁹³

We are inclined to prefer such a pragmatic strategy over

the semantic one explored in this paper. Why then didn't we take this grand route over the summits of Gricean reasoning, where the air is thin, but the view so much clearer? The reason is that we do not see a pass that leads into this promised land. The informal Gricean reasoning sounds quite appealing. The problem is to make it work, i.e. to base it on an adequate and precise formulation of the Gricean Maxims.

If the exhaustiveness of an answer is a conversational implicature, it has to be a logical consequence of the assumption that it is a correct answer. To get this pragmatic strategy to work, what is called for is a formal statement of the requirements inherent in the Gricean Maxims. If on the basis of such a formulation exhaustiveness could be shown to be formally derivable as a pragmatic consequence, we would be quite content to barter our semantic approach for it.

In G&S 1984a we did propose a formulation of the Maxims of Relation, Quantity and Quality, which is applicable to questions and answers. As we will indicate below, this formulation of the maxims will not do for the purpose of characterizing exhaustiveness as an implicature. Of course, this does not prove much. Instead of interpreting this result as providing further support to the semantic account of exhaustiveness proposed in this paper, one might just as well take it to constitute conclusive evidence against our formulation of the maxims. To be sure, if one really insists, it will always be possible simply to write an exhaustiveness claim explicitly into a formulation of the maxims that applies specifically to answers. But that is not what one wants. If the game of pragmatics is played fair, such a phenomenon as the exhaustiveness of answers should follow from a general formulation of the maxims that applies to all assertions, and not just to the specific assertions that characteristic answers are. For therein lies the explanatory power of the Gricean framework, in that it embodies general principles underlying all co-operative linguistic behaviour.

Of course, judging whether the game of pragmatics is

played according to the unwritten rules, will always remain a delicate matter. The only legitimate move we can make at this moment is to show that indeed our formulation of the maxims does not enable one to give a pragmatic account of exhaustiveness, and to indicate why it is we think that it will be hard to improve upon it without foul play.

In G&S 1984a we formulated the Maxim of Relation more or less as follows. An answer α is relevant to a question β asked by a questioner with information J iff α at least gives a partial pragmatic answer to β in J . The Maxim of Quality simply requires α to determine a true semantic answer to β in i . Taken together, Relation and Quality require α to at least give a true partial pragmatic answer to β in J in i . Obviously, this requirement is too weak: it can easily be met by answers that are not exhaustive. The Maxim of Quantity is, of course, the obvious candidate to rule out non-exhaustive answers. What Quantity does is making a choice between the various answers that meet the requirements set by Relation and Quality. According to Quantity, complete true pragmatic answers are preferred over partial true pragmatic answers. Moreover, Quantity prefers being an answer over merely giving one. And, finally, it prefers semantic answers over pragmatic ones. If we consider two answers α and α' , where α' is the exhaustive variant of α , it will be clear that, if both meet the requirements of Relation and Quality, the exhaustive α' will be preferred by Quantity over the non-exhaustive α . So, we see that instead of providing non-exhaustive answers with an exhaustiveness implicature, Quantity rather does the opposite. It prefers exhaustive answers over non-exhaustive ones, and consequently a non-exhaustive answer will pragmatically imply the negation of exhaustiveness.⁹⁴

And it is difficult to see how the Maxim of Quantity, whatever precise formulation one might want to give of it, could not have this effect. For Quantity asks to give as much information as possible, within the bounds set by Relation and Quality. And given the semantic fact that questions

ask for an exhaustive specification, exhaustive answers clearly comply better than non-exhaustive ones. Quantity as such then merely allows one to infer that the answerer who gives a certain specification, does not positively believe of other individuals that they have the property in question too. But this is not the same as inferring that the specification given is meant to be exhaustive, i.e. as inferring that the answerer believes of all other individuals that they do not have the property.

Yet, characteristic answers are, under normal circumstances, interpreted exhaustively. Therefore, it seems that we must conclude that exhaustivity, perhaps contrary to our expectations, is a semantic property after all.

The existence of non-exhaustive answers prompts a final remark. First of all, notice that non-exhaustiveness is the marked case: a non-exhaustive answer should be explicitly marked as such (unless the context makes it quite clear that the answer is meant to be non-exhaustive, or that a non-exhaustive answer will suffice). This means, or so it seems, that we also need a rule which does not include the semantic operation of exhaustivization. This, in a sense, makes most answers ambiguous between an exhaustive and a non-exhaustive reading. Secondly, notice that not explicitly exhaustive answers are always interpreted exhaustively. This can be explained as a matter of pragmatics. And this explanation at the same time tells us why non-exhaustive answers should be marked as such. The explanation uses, among other things, the Maxim of Manner, and runs as follows. One might take Manner to state, among other things, that one may use an ambiguous expression only if one is willing to stand for all of its readings that are relevant in the situation in which one uses it. So, if one gives an answer to a question, one allows the questioner to interpret the answer in that reading which constitutes the best answer to her question. If an expression is ambiguous between an exhaustive and a non-exhaustive reading, this means that the questioner is allowed to take it on its exhaustive reading, unless of course

the answerer has explicitly marked his answer to indicate that it should not be taken as such (or the context does so).⁹⁵

Notice that such an explanation presupposes that exhaustiveness is a semantic property. Of course, the sketchy remarks made above do not prove that exhaustiveness is a semantic, rather than a pragmatic phenomenon. They do not exclude that one day someone comes up with a perfectly general and plausible explication of the Gricean Maxims that does allow one to derive exhaustiveness pragmatically. However, for reasons indicated above, we doubt that this is possible. And even if this were to happen, we believe that the analysis presented in this paper may be worth its while, since it gives what we think is an accurate account of the outcome of this process, though maybe not of the ways that lead to it.

Appendix 1. Specificity revisited

The notions of pragmatic rigidity and definiteness, defined in (32) and (33) in section 4.4, are closely connected with the pragmatic notion of specificity, as it was discussed in G&S 1981.⁹⁶ This notion of specificity applies to the use of terms. For example, a term like a picture can be used specifically or non-specifically by a speaker in uttering a sentence such as (1):

- (1) A picture is missing from the gallery

The speaker uses the term a picture specifically in using it in the context of sentence (1) if he thereby refers to a particular object, i.e. if his information determines a unique particular object that is both a picture and is missing. The speaker uses the term non-specifically in the context of sentence (1), if his information tells him no more than that there is some picture missing, without it being determined by his information which one it is. (Or if his information even allows for the possibility that more than one picture is missing.)

The main point of G&S 1981 was that the specific/non-specific distinction is a pragmatic one, and does not correspond to a semantic ambiguity. Semantically, it was argued, sentence (1) is simply an unambiguous existentially quantified sentence. In G&S 1981, the notion of specificity was defined in terms of a formal system called epistemic pragmatics. In the present framework, the notion can be defined as follows:

- (2) Let α be a term, β an intransitive verbphrase, and $\alpha\beta$ the sentence formed from them; and let J be an information set.

α is used specifically in the context of $\alpha\beta$ in J iff

- (i) $\llbracket \lambda a \alpha' (\lambda a \beta') \rrbracket \subseteq J$
 (ii) $\lambda P \exists Q [\alpha' (Q) \wedge P = \lambda a \lambda x [Q(a)(x) \wedge \beta'(x)]]$ is definite and rigid in J

Clause (i) requires that the sentence formed from α and β expresses a proposition that is entailed by (contained in) the information of the speaker. I.e. it is required that the speaker believes the sentence to be true, he is required to use the sentence sincerely. The second clause (ii) requires that the term a such that β is rigid and definite in the information of the speaker. Where such that β is the restrictive relative clause formed from β . If we apply definition (2) to our example (1) this means that a picture is used specific, if the speaker believes sentence (1) to be true, and if the term a picture such that it is missing is definite and rigid for the speaker. More formally, clause (i) requires (3), and clause (ii) requires (4) and (5):

- (3) $\forall a \in J: \llbracket \text{picture} \rrbracket (a) \cap \llbracket \text{missing} \rrbracket (a) \neq \emptyset$
 (4) $\forall a \forall i \in J: \llbracket \text{picture} \rrbracket (a) \cap \llbracket \text{missing} \rrbracket (a) = \llbracket \text{picture} \rrbracket (i) \cap \llbracket \text{missing} \rrbracket (i)$
 (5) $\forall a \in J: \llbracket \text{picture} \rrbracket (a) \cap \llbracket \text{missing} \rrbracket (a) = \emptyset$ or
 $\exists d \in D, \forall a \in J: \llbracket \text{picture} \rrbracket (a) \cap \llbracket \text{missing} \rrbracket (a) = \{d\}$

The requirements (3), (4) and (5) boil down to (6):

- (6) $\exists d \in D, \forall a \in J: \llbracket \text{picture} \rrbracket (a) \cap \llbracket \text{missing} \rrbracket (a) = \{d\}$

And (6) corresponds precisely to the informal characterization of the specific use of a picture in the context of sentence (1) that we started out with: according to the information J of the speaker, there is a unique object d such that d is a picture and d is missing. The speaker specifically refers to

the object *d* in using the term a picture in the context of sentence (1).

If definition (2) of specificity is applied to a term like every picture, still using is missing as our verbphrase, it is required that indeed every picture is missing according to the information of the speaker, and that the term every picture that is missing is definite and rigid in his information. Since this term is already semantically definite, it cannot fail to be definite in the information of the speaker. In fact, the two conditions (i) and (ii) together require that the term every picture itself is rigid in the information. Condition (i) in this case requires (7), and (ii) requires (8):

- (7) $\forall a \in J: [\text{picture}](a) \subseteq [\text{missing}](a)$
 (8) $\forall a \forall i \in J: [\text{picture}](a) \cap [\text{missing}](a) =$
 $[\text{picture}](i) \cap [\text{missing}](i)$

Because of (7), (8) can be reduced to (9):

- (9) $\forall a \forall i \in J: [\text{picture}](a) = [\text{picture}](i)$

What (9) requires is that the set of pictures form a definite set in the information of the speaker, i.e. that his information tells him what the pictures are.

In G&S 1981, we did not give a uniform definition of specificity that applies to all kinds of terms. We stated separate definitions for different kinds of terms. The definition we gave for universally quantified terms came down to what is required by (9). The uniform definition (2) presented above, corresponds to the notion of sincere specificity as it was defined in our earlier paper.

For definite descriptions, the distinction between specific and non-specific use corresponds, to a large extent, to Donellan's distinction between referential and attributive use of definite descriptions.⁹⁷ If we apply definition (2) to the term the picture in room A and the verbphrase is missing, specific use requires the speaker to have the information that there is (was) a unique picture in room A and that it is

missing. And further requires that the term the picture in room A that is missing is definite in his information, which it cannot fail to be since this term is already semantically definite, and that it is rigid in his information. More formally, clause (i) requires (10) to hold, and (ii) requires (11):

(10) $\forall a \in J, \exists d \in D: [\text{picture } r.A](a) = \{d\} \ \& \ d \in [\text{missing}](a)$

(11) $\exists d \in D, \forall a \in J: [\text{picture } r.A](a) \cap [\text{missing}](a) = \{d\}$ or
 $\forall a \in J: [\text{picture } r.A](a) \cap [\text{missing}](a) = \emptyset$

Because of (10), (11) can be reduced to (12):

(12) $\exists d \in D, \forall a \in J: [\text{picture } r.A](a) = \{d\}$

And (12) requires that the information of the speaker tells him what the referent of the description the picture in room A is. It is required that there be a specific object d which the speaker believes to be its referent. In this case too, (10) and (12) together correspond to sincere specific use as it was defined in G&S 1981, (12) on its own corresponds to specificity simpliciter as it was defined there. So, it proves to be the case that in order to obtain a uniform definition of specific use for all kinds of terms, one should focus on sincere specificity.

The single and uniform definition presented here, is much to be preferred over the whole bunch of separate definitions for different kinds of terms, we had to use in our earlier paper to cover the notion of specificity. The present definition links the pragmatic notion of specificity to the notions of pragmatic definiteness and rigidity of terms. And the fundamental difference between the circumstances in which definite terms and indefinite terms (called 'universal' and 'non-universal' in our earlier paper) are used specifically, gets a deeper explanation. The difference is that indefinite terms in general depend for their specific use on both the information of the speaker about the denotation of the noun-phrase in the term, and the information he has about the denotation of the verbphrase. It is precisely because of the

fact that they are semantically indefinite that they need, so to speak, the context of the sentence as a whole to become specific.

Appendix 2. Answers compared, a topic in logical pragmatics

In G&S 1984a, section 7, we discussed the possibility of comparing answers in quantitative respects. We claimed that, under certain conditions, of any two propositions that give an answer to a particular question in a (certain kind of) information set, the one will be quantitatively better than the other, or either their intersection ('conjunction') or their union ('disjunction') will be a better answer than both of them. In this appendix, we intend to prove a slightly more general version of this claim. We will make use of the definitions given in section 4 of the present paper.

In definition (5) in section 4 of the notion of the partial semantic answer given by a proposition P to a question Q , we used the auxiliary notion of the union of the possible semantic answers to Q compatible with P . Here, we introduce the following notation for that auxiliary notion:

$$(1) \{P, I/Q\} = \cup\{P' \mid P' \in I/Q \text{ \& } P' \cap P \neq \emptyset\}$$

In view of definition (4) in section 4 of the notion of giving a partial semantic answer, the following holds:

$$(2) P \text{ gives a partial semantic answer to } Q, \hat{A}(P, I/Q), \text{ iff} \\ \{P, I/Q\} \neq \emptyset \text{ \& } \{P, I/Q\} \neq I$$

The following four facts can also be seen to hold:

$$(3) \{P_1 \cap P_2, I/Q\} = \{P_1, I/Q\} \cap \{P_2, I/Q\}$$

$$(4) \{P_1 \cup P_2, I/Q\} = \{P_1, I/Q\} \cup \{P_2, I/Q\}$$

$$(5) P_1 \subset P_2 \Rightarrow \{P_1, I/Q\} \subseteq \{P_2, I/Q\}$$

$$(6) P \neq \emptyset \Rightarrow \{P, I/Q\} \neq \emptyset$$

From (6) it follows that if $P_1 \cap P_2 \neq \emptyset$, then $\int P_1 \cap P_2, I/Q \neq \emptyset$. And from $\int P_1, I/Q \neq I$ and (3), it follows that $\int P_1 \cap P_2, I/Q \neq I$. This means that (2) guarantees that:

(7) If $A(P_1, I/Q) \ \& \ P_1 \cap P_2 \neq \emptyset$, then $A(P_1 \cap P_2, I/Q)$

Further, from (4) it follows that if $\int P_1, I/Q = \int P_2, I/Q$, and $\int P_1, I/Q \neq I$, then $\emptyset \neq \int P_1 \cup P_2, I/Q \neq I$. By (2), this implies:

(8) If $A(P_1, I/Q) \ \& \ A(P_2, I/Q) \ \& \ \int P_1, I/Q = \int P_2, I/Q$, then $A(P_1 \cup P_2, I/Q)$

Quite similar facts hold for pragmatic answerhood. First we define:

(9) $\int P, J/Q = \cup \{P' \mid P' \in J/Q \ \& \ P' \cap P \neq \emptyset\}$

In view of definition (27) in section 4 of the notion of giving a partial pragmatic answer in J , it holds that:

(10) P gives a partial pragmatic answer to Q in J ,
 $PA(P, J/Q)$, iff $J \neq \int P, J/Q \neq \emptyset$

If we substitute J/Q for I/Q , and $P \cap J \neq \emptyset$ for $P \neq \emptyset$, and make some other obvious adjustments, facts similar to (3) - (8) hold for pragmatic answerhood as well.

Let us now define some notions of quantitative comparison of semantic answers. Quantitative comparison of two propositions makes sense only if both are qualitatively in order. In semantic terms this means that both have to be true. Pragmatically, quality requires that both are believed to be true. For this to be possible they should at least be compatible with each other. We therefore restrict quantitative comparison to mutually consistent propositions.

First we define the notion of being a more informative semantic answer:

(11) Let $A(P_1, I/Q)$, $A(P_2, I/Q)$ and $P_1 \cap P_2 \neq \emptyset$.

P_1 is a more informative semantic answer to Q than P_2 iff

$$\int P_1, I/Q \subseteq \int P_2, I/Q$$

P_1 and P_2 are equally informative semantic answers to Q iff

$$\int P_1, I/Q = \int P_2, I/Q$$

In words, one answer is more informative than another if it excludes more possible semantic answers. In view of (5), entailment is not sufficient for being more informative. It can further be noticed that propositions that give complete semantic answers are the most informative ones.

On top of (11), we define an additional comparative notion. We compare equally informative answers for their being more standard:

(12) Let $A(P_1, I/Q)$, $A(P_2, I/Q)$, $P_1 \cap P_2 \neq \emptyset$, and $\int P_1, I/Q = \int P_2, I/Q$.

P_1 is a more standard answer to Q than P_2 iff $P_1 \supset P_2$

Of two equally informative answers, the more standard one is the one that is weaker, which is the one that is closer to being a partial semantic answer, rather than merely giving one. Propositions that are partial semantic answers are the most standard ones. Whereas the notion of informativeness favours stronger propositions, up to the point where it makes no difference as to whether being stronger excludes another possible semantic answer, the notion of standardness favours weaker propositions among ones excluding the same possible semantic answers. If one proposition is less standard than another, it will contain more information that is irrelevant to the question. It is therefore considered to be quantitatively worse. It contains more than is called for. Of course, one proposition is quantitatively better than another as soon as it is more informative, i.e. if it excludes more possible semantic answers. So, both informativeness and standardness play a role in determining whether one proposition is quantitatively better than another. The way in which they cooperate in this is given in the following definition:

(13) Let $A(P_1, I/Q)$, $A(P_2, I/Q)$, and $P_1 \cap P_2 \neq \emptyset$.

P_1 is a quantitatively better semantic answer to Q than P_2 iff

either (i) P_1 is a more informative semantic answer to Q than P_2

or (ii) P_1 and P_2 are equally informative semantic answers to Q , and P_1 is a more standard answer to Q than P_2

Using $>_Q$ to abbreviate 'being a quantitatively better semantic answer to Q than', (13) can be formulated as follows:

(13') $P_1 >_Q P_2$ iff either (i) $\int P_1, I/Q \subset \int P_2, I/Q$
or (ii) $\int P_1, I/Q = \int P_2, I/Q$ & $P_1 \supset P_2$

Propositions that are complete semantic answers are, as is to be expected, the quantitatively best answers.

Not from any two different and compatible propositions can we choose one that is quantitatively better than the other. But in some cases we can:

(14) Let $A(P_1, I/Q)$, $A(P_2, I/Q)$, and $P_1 \cap P_2 \neq \emptyset$.

If $P_1 \subset P_2$, then either $P_1 >_Q P_2$, or $P_2 >_Q P_1$

The fact stated in (14) follows from (5), which says that if P_1 is stronger than P_2 , then P_1 will be at least as informative as P_2 . This leaves two possibilities:

- (i) $\int P_1, I/Q \subset \int P_2, I/Q$, in which case $P_1 >_Q P_2$;
(ii) $\int P_1, I/Q = \int P_2, I/Q$, in which case $P_2 >_Q P_1$, since $P_2 \supset P_1$.

If P_1 is merely compatible with P_2 , i.e. if the one does not entail the other, things are more complicated. This is the situation in which $P_1 \cap P_2 \subset P_1$ & $P_1 \cap P_2 \subset P_2$. From (5), again, we know the following:

- (15) (i) $P_1 \cap P_2 \subset P_1 \Rightarrow \int P_1 \cap P_2, I/Q \subseteq \int P_1, I/Q$
(ii) $P_1 \cap P_2 \subset P_2 \Rightarrow \int P_1 \cap P_2, I/Q \subseteq \int P_2, I/Q$

This leaves us four possibilities in case P_1 and P_2 have a real overlap:

(16) If $P_1 \cap P_2 \subset P_1$ & $P_1 \cap P_2 \subset P_2$, then either:

(i) $\int P_1 \cap P_2, I/Q \} = \int P_1, I/Q \}$ & $\int P_1 \cap P_2, I/Q \} = \int P_2, I/Q \}$
i.e. $\int P_1, I/Q \} \subset \int P_2, I/Q \}$; or

(ii) $\int P_1 \cap P_2, I/Q \} \subset \int P_1, I/Q \}$ & $\int P_1 \cap P_2, I/Q \} = \int P_2, I/Q \}$
i.e. $\int P_2, I/Q \} \subset \int P_1, I/Q \}$; or

(iii) $\int P_1 \cap P_2, I/Q \} \subset \int P_1, I/Q \}$ & $\int P_1 \cap P_2, I/Q \} \subset \int P_2, I/Q \}$; or

(iv) $\int P_1 \cap P_2, I/Q \} = \int P_1, I/Q \}$ & $\int P_1 \cap P_2, I/Q \} = \int P_2, I/Q \}$
i.e. $\int P_1, I/Q \} = \int P_2, I/Q \}$

Only in the first two cases can we choose the quantitatively better one among P_1 and P_2 . In case (i) it is P_1 , in case (ii) it is P_2 .

But notice that in case (iii), $P_1 \cap P_2$ tends to more informative than both P_1 and P_2 . On the assumption that $A(P_1, I/Q)$ and $A(P_2, I/Q)$, and that $P_1 \cap P_2 \neq \emptyset$, we know from (7) that $A(P_1 \cap P_2, I/Q)$. So, in case (iii), on these assumptions, $P_1 \cap P_2$ is a quantitatively better answer than both P_1 and P_2 .

And in case (iv), something similar holds. On the assumption that $A(P_1, I/Q)$ and $A(P_2, I/Q)$, we know from (8) that it follows from (iv) that $A(P_1 \cup P_2, I/Q)$. (iv) tells us that P_1 and P_2 are equally informative. From (4) it then follows that $P_1 \cup P_2$ is equally informative as well. By assumption we know that $P_1 \cup P_2 \supset P_1$ and $P_1 \cup P_2 \supset P_2$. Then definition (13) of being a quantitatively better answer tells us that $P_1 \cup P_2$ is a better answer than both P_1 and P_2 .

In effect, this means that we have proved the following:

(17) If $A(P_1, I/Q)$, $A(P_2, I/Q)$, $P_1 \cap P_2 \neq \emptyset$, and

$P_1 \cap P_2 \subset P_1$ & $P_1 \cap P_2 \subset P_2$, then either:

(i) $P_1 >_Q P_2$; or

(ii) $P_2 >_Q P_1$; or

(iii) $A(P_1 \cap P_2, I/Q)$ & $P_1 \cap P_2 >_Q P_1$ & $P_1 \cap P_2 >_Q P_2$; or

(iv) $A(P_1 \cup P_2, I/Q)$ & $P_1 \cup P_2 >_Q P_1$ & $P_1 \cup P_2 >_Q P_2$; or

If P_1 and P_2 are compatible with each other, i.e. $P_1 \cap P_2 \neq \emptyset$, there are three possibilities: the one may entail the other, they may have a real overlap, or they may be identical. (14) tells us that in the first case one will be quantitatively

better than the other. And (17) tells us that in the second case one will be quantitatively better than the other, or their intersection ('conjunction') or union ('disjunction') is. In the last case, the two are of course equally good from a quantitative perspective. This means that by combining (14) and (17), we arrive at the following more general fact:

(18) If $A(P_1, I/Q)$, $A(P_2, I/Q)$ and $P_1 \cap P_2 \neq \emptyset$, then either:

- (i) $P_1 >_Q P_2$; or
- (ii) $P_2 >_Q P_1$; or
- (iii) $A(P_1 \cap P_2, I/Q) \ \& \ P_1 \cap P_2 >_Q P_1 \ \& \ P_1 \cap P_2 >_Q P_2$; or
- (iv) $A(P_1 \cup P_2, I/Q) \ \& \ P_1 \cup P_2 >_Q P_1 \ \& \ P_1 \cup P_2 >_Q P_2$; or
- (v) $P_1 = P_2$

In words, of any two different mutually compatible propositions that give a partial semantic answer to a certain question, either the one is a quantitatively better semantic answer to the question than the other, or either their intersection ('conjunction'), or their union ('disjunction') is a partial semantic answer to the question as well, and is quantitatively better than either one of them.

But this is only one half of the story: the semantic half. Let us now turn to pragmatic answerhood. It will need no argumentation that the pragmatic analogue of the semantic notion of being a quantitatively better answer as it was defined in (13) will play an important role in evaluating pragmatic quantity of answers. First, we define the pragmatic analogues of the notions of being semantically more informative and being semantically more standard answers:

(19) Let $PA(P_1, J/Q)$, $PA(P_2, J/Q)$ and $P_1 \cap P_2 \neq \emptyset$.

P_1 is a more informative pragmatic answer to Q than P_2 iff

$$\int P_1, J/Q \subset \int P_2, J/Q$$

P_1 and P_2 are equally informative pragmatic answers to Q iff

$$\int P_1, J/Q = \int P_2, J/Q$$

- (20) Let $PA(P_1, J/Q)$, $PA(P_2, J/Q)$, $P_1 \cap P_2 \cap J \neq \emptyset$ and
 $\int P_1, J/Q \} = \int P_2, J/Q \}$
 P_1 is a more standard pragmatic answer to Q in J than P_2 iff
 $P_1 \cap J \supset P_2 \cap J$

Notice, that quantitative comparison of pragmatic answers is restricted to propositions that are not only compatible with each other and with the information set J , but are compatible within J . Again, this means that we only want to take propositions into consideration that are qualitatively alright. If this is to be the case, it has to be possible to update the information with both propositions.

The two notions of being a more informative and being a more standard pragmatic answer can be combined in the following definition of being a semi quantitatively better pragmatic answer:

- (21) Let $PA(P_1, J/Q)$, $PA(P_2, J/Q)$, and $P_1 \cap P_2 \cap J \neq \emptyset$.
 P_1 is a semi quantitatively better pragmatic answer to Q in J than P_2 iff either
- (i) P_1 is a more informative pragmatic answer to Q in J than P_2 ;
 - or (ii) P_1 and P_2 are equally informative pragmatic answers to Q in J , and P_1 is a more standard pragmatic answer to Q in J than P_2

Using $>_{Q, J}$ to abbreviate 'is a semi quantitatively better pragmatic answer to Q in J ', (21) can be formulated as follows:

- (21') $P_1 >_{Q, J} P_2$ iff either (i) $\int P_1, J/Q \} \subset \int P_2, J/Q \}$
 or (ii) $\int P_1, J/Q \} = \int P_2, J/Q \}$ and
 $P_1 \cap J \supset P_2 \cap J$

This pragmatic notion of comparison of answers completely restricts itself to a comparison within the information set J , and does not look outside it. This means that if two propositions are equivalent within J , i.e. if they are pragmatically

equivalent, they cannot fail to come out as being semi quantitatively equally good pragmatic answers in J . This may happen even if the two propositions are semantically radically different. In a notion of full quantitative pragmatic comparison a semantic comparison will be put on top of the pragmatic comparison provided by definition (21).

But first, it can be noticed that the following fact holds, the proof of which runs completely parallel to that of (18):

- (22) If $PA(P_1, J/Q)$, $PA(P_2, J/Q)$, and $P_1 \cap P_2 \cap J \neq \emptyset$, then either:
- (i) $P_1 >_{Q, J} P_2$; or
 - (ii) $P_2 >_{Q, J} P_1$; or
 - (iii) $PA(P_1 \cap P_2, J/Q) \ \& \ P_1 \cap P_2 >_{Q, J} P_1 \ \& \ P_1 \cap P_2 >_{Q, J} P_2$; or
 - (iv) $PA(P_1 \cup P_2, J/Q) \ \& \ P_1 \cup P_2 >_{Q, J} P_1 \ \& \ P_1 \cup P_2 >_{Q, J} P_2$; or
 - (v) $P_1 \cap J = P_2 \cap J$

In words, of any two pragmatically non-equivalent propositions which give a partial pragmatic answer to a question Q in an information set J , either the one is semi quantitatively better than the other, or either their intersection or their union gives a partial pragmatic answer, and is semi quantitatively better than each of them.

The pragmatic notion of being semi quantitatively better evaluates propositions in a smaller area than the notion of being a quantitatively better semantic answer. The effect of this is that the two comparative notions may give radically different outcomes when applied to the same two propositions, meeting the preconditions of both notions. Not only can it happen that two propositions come out as pragmatically equally good, whereas semantically the one is better than the other, it may also happen that from a semantic point of view P_1 is better than P_2 , whereas from a pragmatic answer P_2 is better than P_1 . This happens when P_1 and P_2 are pragmatically equally informative, but P_2 is pragmatically more standard than P_1 , but where P_1 is semantically more informative than P_2 .

What is quite naturally asked for from a logical pragmatic point of view is to combine the forces of the comparative notions of semantic quantity and semi pragmatic quantity into

the following full comparative notion of pragmatic quantity:

(23) Let $PA(P_1, J/Q)$, $PA(P_2, J/Q)$, and $P_1 \cap P_2 \cap J \neq \emptyset$.

P_1 is a quantitatively better pragmatic answer to Q in J than P_2 iff either:

(i) P_1 is a semi quantitatively better pragmatic answer to Q in J than P_2

or (ii) P_1 and P_2 are semi quantitatively equally good pragmatic answers to Q in J , and

P_1 is a quantitatively better semantic answer to Q in J than P_2

Abbreviating the notion defined in (23) as $\succ_{Q,J}$, (23) can also be formulated as follows:

(23') $P_1 \succ_{Q,J} P_2$ iff either:

(i) either $\{P_1, J/Q\} \subset \{P_2, J/Q\}$

or $\{P_1, J/Q\} = \{P_2, J/Q\}$ and $P_1 \cap J \supset P_2 \cap J$

or (ii) $P_1 \cap J = P_2 \cap J$ and

either $\{P_1, I/Q\} \subset \{P_2, I/Q\}$

or $\{P_1, I/Q\} = \{P_2, I/Q\}$ and $P_1 \supset P_2$

We believe this double, and in fact fourfold, evaluation of the quantity of answers not only to be formally quite appealing, we also believe it to be of empirical pragmatic import. In section 7 of G&S 1984a, we gave some still rather artificial examples to support this. It is our claim that in actual question-answering, the one who answers a question will first of all try to formulate her answer in such a way that it stands the best chance to fill in the gap in the information of the questioner indicated by the question. This first aspect in itself has two sides. First of all, the more possible answers still allowed for by the information of the questioner it excludes, the better it is. And second, if two answers are equally good in this respect, the answerer will choose the one that contains less superfluous information in view of what the question asks for. She will try not to provide more information than is relevant to the question. If two answers are equally

good in these two respects, then the second aspect comes into play. If two answers are equally adequate in filling in the gap in the information of the questioner indicated by his question, the answerer chooses the one that is better from a purely semantic point of view, i.e. that is a better answer in view of its conventional meaning, shared by all speech participants. This second aspect, again, has two sides. First, if an answer is more informative to the question on the basis of its conventional meaning, it is preferred. The importance of this step will be clear from the fact that if the answerer did not take it, she would have no reason at all to choose an answer P over an answer $P\cup\bar{J}$, i.e. the answer P in 'disjunction' with the 'negation' of the information the questioner already has. Finally, if two answers remain equally good in this respect as well, the answerer chooses the one that is most relevant to the question from a purely semantic point of view. The importance of this step can be seen as follows. If the answerer did not take this step, she would have no reason to choose an answer P over an answer $P\cap J$, i.e. P in 'conjunction' with all the information the questioner already has.

This illustrates why we believe the four-step evaluation of the quantity of answers not only to be attractive from a purely logical point of view, but also to be empirically relevant. We hasten to add that quantity is not all there is involved in evaluating answers. First of all, quality overrules quantity. It is no use to choose a quantitatively better answer if its quality is not guaranteed, i.e. if the answerer cannot stand for its truth. We cannot make our answers more informative than our own information allows for. And further, it should be remembered that if we talk about answers here, we talk about propositions, and not about linguistic objects, linguistic answers. A proposition that provides a quantitatively better answer is no good if we don't have the linguistic means to communicate it.

The aspect of quality and the possibility to phrase an answer in public language are a kind of preconditions. We only will start to evaluate answers in quantitative respects

if they meet these two conditions. Another factor, that comes in in a different way, is manner. Matters of manner can first of all help to choose between two linguistic answers that differ in form, but are semantically equivalent. E.g. if ϕ and ψ are equivalent, $\phi \wedge \psi$ and $\phi \vee \psi$ will be equivalent to both of them, and to each other, as well. Then, clearly, ϕ and ψ are better from the perspective of manner than their conjunction and disjunction. This illustrates that manner can help to choose between linguistic answers which are semantically equivalent, and hence are quantitatively equally good.

However, we tend to believe that manner may also come in in an earlier stage of evaluation. It is not unlikely that manner may interfere with quantity, i.e. that matters of manner may overrule matters of quantity. To be more specific, there are reasons to believe that in case two linguistic answers are pragmatically equivalent, and hence provide semi quantitatively equally good pragmatic answers, the one may be preferred over the other for reasons of manner, even though the other provides a quantitatively better semantic answer.

An example we have in mind is the following. Suppose the questioner asks for the identification of a certain individual. Suppose further that the answerer has two definite descriptions available that both rigidly identify one and the same individual in the information set of the questioner. These two descriptions are then pragmatically equivalent. But semantically they need not be equivalent at all. Suppose the two descriptions give rise to propositions that have a real overlap in I. Quantitative comparison by means of (23), will have as its outcome that identification by means of both descriptions at the same time, will provide a more informative and hence better semantic answer. In many cases, pragmatic manner, so to speak, will then overrule semantic quantity, and will tell us that it is overall more correct to simply use one of these description instead of turning the two into one more complex combination of both descriptions, precisely because this prolixity has no function in closing the gap in the information of the questioner indicated by his question.

These caveats are important in order to arrive at a realistic assessment of the empirical import of the measurement of quantity carried out by definition (23). It evaluates answers in quantitative respects under the assumption that other things are equal. But, as we have indicated, it need not be the case that other things are always equal. The following fact, which follows in a straightforward way from (22) and (18), should also be appraised bearing in mind the provisos just made:

- (24) If $PA(P_1, J/Q)$, $PA(P_2, J/Q)$, and $P_1 \cap P_2 \cap J \neq \emptyset$ then either:
- (i) $P_1 \succ_{Q, J} P_2$; or
 - (ii) $P_2 \succ_{Q, J} P_1$; or
 - (iii) $PA(P_1 \cap P_2, J/Q) \ \& \ P_1 \cap P_2 \succ_{Q, J} P_1 \ \& \ P_1 \cap P_2 \succ_{Q, J} P_2$; or
 - (iv) $PA(P_1 \cup P_2, J/Q) \ \& \ P_1 \cup P_2 \succ_{Q, J} P_1 \ \& \ P_1 \cup P_2 \succ_{Q, J} P_2$; or
 - (v) $P_1 = P_2$

In words, of any two different propositions which are compatible with each other within J and give partial pragmatic to Q in J , then either the one is a quantitatively better pragmatic answer, or the other is, or their intersection ('conjunction'), or their union ('disjunction') gives a partial pragmatic answer and is quantitatively better than both of them.

If we take a look at the different notions of answerhood defined in section 4, it can be observed that a proposition that gives a complete pragmatic answer will always be preferred over one that merely gives one. And further, a proposition that is a partial pragmatic answer is always preferred over one that merely gives one.

All we have said sofar, applies equally well to notions of true answerhood. One further fact can be noticed. If we restrict ourselves to information sets that are knowledge sets, i.e. information sets J for which it holds that the actual index $a \in J$, and if we deal with the notion of giving a true pragmatic answer in such a set, then the precondition $P_1 \cap P_2 \cap J \neq \emptyset$, occurring in several definitions and statements can be dropped. It is already guaranteed by the fact that in

such cases $a \in P_1$, $a \in P_2$, and $a \in J$.⁹⁸

One final remark concerns the fact that most of the time we will be rather in doubt about what exactly the information of the person who asks us a question is. One could say that, in general there will be quite a number of information sets such that as far as our own information goes, each of them could be the information set of our questioner. In answering, we need to take all these possibilities into account. Roughly speaking, this means that we better take the union of all these possible information sets in order to decide what will be the best way to phrase our answer. Quite the same holds, if we are to answer a question for many different persons at the same time. In cases like these, the set of indices J with respect to which we answer a question tends to grow more equal to the total set of indices I . The effect of this will be that better answers will tend to be standard semantic answers. This explains in a natural way, why in highly institutionalized and formal question-answering situations, such as those obtaining in the Court of Law, rigid standard semantic answers are called for. In such situations, questions are posed on behalf of the social community, and the answers, which are to be recorded, should be answers to the community as a whole, and therefore to a great variety of information sets, and not only with respect to the information of the person who is actually carrying out the interrogation.

It is our hope that the scanty remarks in this appendix may have convinced some reader that not only matters of semantics, but also matters of pragmatics, can stand formalization, and indeed, may gain from it. There is not only room for a logical semantics, but also for a logical pragmatics. Pragmatics is as much in need of the attention of logicians as semantics (was).

Notes

* We would like to thank Renate Bartsch and Johan van Benthem for their comments and critical remarks on an earlier version. As always, we are also grateful to Theo Janssen and Fred Landman, this time especially for helping us out of a technical spot.

1. The essential mutual dependence between the interrogative use of language and the assertoric use is used in Bartsch (to appear) to describe the coherence and correctness of texts.
2. The connection between the notion of relevance, and the Maxim of Relation, and the notion of a question was made in G&S 1981. There we suggested that part of the content of the notion of relevance might be covered using the concept of a 'topic of conversation', speculating that such a topic, at least in informative conversations, can be regarded as an (implicitly or explicitly raised) question, the answer to which is what the conversation is all about, so to speak. In G&S 1984a, section 8, a more formal elaboration of what the Gricean Maxims amount to for informative question-answer dialogues is given, in which this idea is used as well.
3. For a slightly more elaborate discussion, see G&S 1984c, section 1.
4. For an extensive bibliography which runs up to 1975, see Egli & Schleichert (1976). Influential systems of erotetic logic are for example Harrah (1963), Belnap & Steel (1976), and Aqvist and Hintikka (Aqvist (1965), Hintikka (1976)). It should be noted that not all erotetic logicians have pretensions concerning natural language, their goal being "unabashedly normative", to quote Belnap describing Belnap & Steel (see Belnap (1982,165)). For a discussion of the approach of Aqvist and Hintikka, see G&S 1984c, section 4.4.
5. As for example is done in the system developed by Aqvist and Hintikka referred to in note 4.
6. A similar sentiment is expressed in Hamblin's pioneering paper on the analysis of question in Montague grammar, where he writes (Hamblin 1976,253):

"The study of questions leans out to pragmatics in the sense that someone who thinks the exclusive purpose of language is to state

truths may be led by it to think again. But it is remarkable that it is possible to produce a semantics (or model theory) of questions, and that it dovetails surprisingly neatly with Montague's own semantics of statements."

7. See Tichy (1978). He starts his paper with an unequivocal statement that runs as follows:

"It seems to be generally taken for granted that in order to be able to deal with questions, ordinary "alethic" logic has to be supplemented with a distinctive "erotetic" logic. The purpose of the present article is to challenge this assumption. Its thesis is that an adequate logical account of the assertoric mode of speech is bound to be directly applicable to questions and equally adequate. The need for a special logic of questions, it will be argued, is no greater than the need for a special logic of beliefs, for a special logic of conjectures, of wishes, prayers, prejudices, promises, or insults."

8. A similar objection could be raised against the approach of Hoepelman (see Hoepelman (1981)) in which a many-valued logic is used to 'equate' declaratives and interrogatives, though this is not to say that his analysis does not capture some interesting phenomena.

9. Thus Tichy, for example, writes (Tichy 1978,276):

"The declarative/interrogative distinction is thus not one of logic. [...] The difference [...] lies entirely in the pragmatic attitude of the speaker."

This holds, according to Tichy, not only for declaratives and the corresponding yes/no-interrogatives, but quite generally, also for example for properties and the corresponding constituent interrogatives, as may be clear from the following quotation (Tichy 1978,277):

"These diverse attitudes have a common object: walkerhood. To say that Tom fears walkers and to say that Tom asks who the walkers are, is to report two different relations as holding between the same two relata."

As far as yes/no-interrogatives are concerned anyway, Tichy's position bears a striking resemblance to that taken by Frege in 'Der Gedanke', where he writes (Frege 1918,62):

"Fragesatz und Behauptungssatz enthalten denselben Gedanken; aber der Behauptungssatz enthält noch etwas mehr, nämlich eben die Behauptung. Auch der Fragesatz enthält etwas mehr, nämlich eine Aufforderung."

In analyses within the framework of speech act theory, too, a position akin to that of Tichy can be discerned. For example, Searle analyzes yes/no-interrogatives as having the form ?(p), and constituent interrogatives as having the form

?p(x)). Here, ? stands for the illocutionary force indicating device that corresponds to questions, p is a 'complete proposition', and p(x) a propositional function. (For details see Searle (1969,31-32,66-67).) Though the respective frameworks are radically different, Searle's way of representing interrogatives clearly resembles Tichy's analysis: the semantic content of an interrogative is an 'ordinary' semantic object (a proposition, a predicate, a relation), and the difference between declaratives and interrogatives is one of illocutionary force, i.e. it is one of use, not of content. Hence the difference is not semantic, but pragmatic.

As we hope to make clear in the main text, we think that it is a mistake to think that no semantic differences exist between indicatives and interrogatives, although we certainly do not want to suggest that the semantic differences are all there is to it. There are, no doubt, all kinds of phenomena concerning indicatives and interrogatives which can not be explained in semantic terms, but which essentially depend on the differences between the characteristic use to which they are put. However, a proper semantic analysis is a prerequisite for an account of such pragmatic differences.

10. As we saw in the previous note, there is no semantic difference, according to Tichy, between (a) and (b):

- (a) Bill walks
- (b) Does Bill walk?

The syntactic difference between the two is an indication of a different "concern", of a different attitude of the speaker towards what in both cases is the same "topic", the same semantic content, viz. the proposition that Bill walks. The semantic identity of (a) and (b) holds also for the corresponding embedded constructions, i.e. for the corresponding that-complement and whether-complement. Consider (c) and (d):

- (c) Tom asserts that Bill walks
- (d) Tom asks whether Bill walks

According to Tichy there is no syntactic difference (no inversion, no question mark) since there is no need to indicate the attitude, which is here explicitly mentioned. That he considers the two complements in (c) and (d) as semantically identical, is borne out by the following quotation (Tichy, 1978,276):

"[a], [b], and the subclauses of [c] and [d] are logically indistinguishable: they have the same referent and the same logical form. The difference between [a] and [b] lies entirely in the pragmatic attitude of the speaker. And the difference between [c] and [d] boils down to the difference in meaning between the verbs "asserts" and "asks"."

That, pace Tichy, there is a semantic difference, can be argued for by means of such pairs of examples as (e) and (f), and (g) and (h):

- (e) Tom tells that Bill walks
- (f) Tom tells whether Bill walks
- (g) Tom knows that Bill walks
- (h) Tom knows whether Bill walks

Assuming that tell and know have the same meaning in (e) and (f) and (g) and (h) respectively, Tichy's thesis that the complements have the same semantic interpretation predicts that (e) and (f) and (g) and (h) respectively, also have the same interpretation. But that is simply not the case. If Bill does not walk, and Tom tells that Bill does not walk, (f) is true, but (e) is false. And if Bill does not walk, and Tom knows that Bill does not walk, (h) is true, and (g) is false.

So, it seems that there are purely semantic differences between indicatives and interrogatives, after all. (For an extensive discussion and argumentation concerning the semantics of various types of complements, see G&S 1982, section 1.) However, disagreement with Tichy's specific thesis concerning the semantics of interrogatives does not imply disagreement with his main methodological point. Although contrary to Tichy we think there are important, systematic semantic differences between indicatives and interrogatives, we do agree with him that there is no need for a special logic, or a special semantics for interrogatives. Our semantic theory should be able to cope with both.

For a general discussion of the kind of approach Tichy favours, see G&S 1984c, section 4.2.

11. See Hausser (1976,1983). In section 4.2. of G&S 1984c Hausser's proposals are discussed as an instance of what is often referred to as the 'categorical' approach.
12. Abusing Frege's terminology, and at the same time more or less contradicting his view on the matter, one might say that questions are not complete thoughts in this sense that interrogatives do not as such contain one specific thought. The completion of a thought in the sense of the selection of one among various possible ones, is what they ask for. See also note 9, and G&S 1982.
13. As the formulation we use, reveals, the interrogatives we are dealing with here express a question that has a unique true semantic answer at an index. Not all interrogatives are of this sort, some allow for more than one true semantic answer at an index. Such interrogatives are discussed in G&S 1984b, where it is shown that they can be dealt with elegantly within our framework without affecting the semantic notion of a question as it is characterized here. Basically, we analyze such interrogatives as being connected with a set of questions. A complete answer to one of the questions in the set is considered to be a complete answer to the interrogative. With such interrogatives, the addressee may choose, so to speak, which question in the set expressed by the interrogative, he will answer. We leave these 'choice-interrogatives'

(and 'mention-some interrogatives') out of consideration in this paper. The interrogatives which are treated here are often called 'mention-all interrogatives'. We consider these mention-all interrogatives, or exhaustive interrogatives, to be the most simple and basic kind of interrogative. The basic, exhaustive nature of interrogatives is not explicitly argued for in this paper. We refer the reader to the discussion of exhaustiveness in G&S 1982, in particular sections 1.5 and 3.4.

Further it should be noted that the fact that a question has a unique true semantic answer in no way implies that there is always only one way to actually answer the question posed by an interrogative. In actual speech situations there may be many different, and sometimes equally adequate ways to answer a question. This, however, is largely a matter of pragmatics. In G&S 1984a we discussed and defined such pragmatic notions of answerhood. The semantics on which this pragmatics is based is precisely the semantics of interrogatives presented here. The pragmatic notions of answerhood will be put to use again in section 4 of this paper in characterizing different kinds of linguistic answers.

14. This two-step derivation of interrogatives distinguishes our approach from others, in particular from constituent answer based theories such as those of Tichy (Tichy 1978), Hausser (Hausser 1976, 1983) and Scha (Scha 1983). Roughly speaking the latter theories remain in their analysis at the level of abstracts.

As far as interrogatives, in distinction from wh-complements, are concerned, we would not want to claim that taking the second step, the step from abstracts to S-expressions, is absolutely essential. Still, we think it is an advantage of our approach that all interrogatives are assigned one and the same syntactic category, and hence one and the same kind of semantic object. Notice that as abstracts they belong to a whole family of different categories, and are assigned all kinds of different semantic objects.

A second attractive feature, besides uniformity, is that interrogatives are assigned a category of their own, and consequently have their own kind of semantic object. As abstracts they express properties or relations, i.e. kinds of semantic objects they have to share with verbal and nominal phrases.

These aspects of our analysis become more important, if not essential, when one deals with wh-complements. (See G&S 1982, section 1.8.) Constituent answer based theories tend to provide poor analyses of wh-complements, if they try to do so seriously at all.

On the other hand, it proves to be the case that a proper analysis of linguistic answers essentially is in need of the level of abstracts underlying interrogatives, as is argued in section 2.3. This holds for constituent answers and for sentential answers. This is true, even though a theory of semantic and pragmatic relations of answerhood can be

adequately and elegantly formulated in terms of a relation between questions, the kind of objects expressed by interrogatives on our analysis, and propositions, the kind of objects expressed by indicative sentences. For details see G&S 1984a and section 4 of this paper. It should be noted though that that theory can be reformulated in terms of relations between properties/relations and propositions.

In short, though the two-step derivation of interrogatives via abstracts may not be really necessary (the second step might be interpreted as the step that takes us from interrogatives to wh-complements), it does result in an over-all elegant approach of interrogatives, wh-complements and the relation of answerhood.

Let us, to conclude with, just note that there may be various, perhaps even rather strong arguments in favour of treating interrogatives uniformly as questions. In G&S 1982 we argued that wh-complements should be analyzed as such, noting, among other things, that wh-complements and that-complements can be co-ordinated, a fact that suggests strongly that they belong to the same category. In fact, co-ordination also occurs freely among interrogatives, without discrimination between sentential interrogatives and constituent interrogatives of various kinds (with various numbers of places). So, for interrogatives too, co-ordination provides an argument in favour of a uniform analysis. (See G&S 1984b for a statement of such co-ordination rules for interrogatives.)

Other arguments for a uniform analysis that, moreover, is systematically related to the analysis of indicative sentences, can be taken from the existence of sentences in which interrogative sentences and indicative sentences are treated on a par. One example is provided by 'conditional interrogatives' such as:

(a) If you saw John, did you talk to him?

which can be argued to consist of an indicative and an interrogative (and not of a conditional as an interrogative). Other examples are sentences like

(b) Hübner is a great chess-player all right, but can he stand the stress of the tournament?

in which an indicative is conjoined with an interrogative. For an analysis of the latter kind of construction, see Hoepelman (1981), from which this example is taken.

15. In G&S 1982 we defined abstract categories in a slightly different fashion. There, the label AB referred to the set of categories:

(a) $\bigcup_{n \geq 1} AB^n$

AB^0 's are not included in the set AB defined in (a). The definition used in this paper will prove to be somewhat more convenient, and moreover will lead more readily to certain generalizations.

It should be noted that, contrary to what is suggested in the text, an AB^n is a relation between individual concepts. It is solely for the sake of simplicity that here we will ignore them, and treat AB^n 's as relations between individuals.

16. In this paper we only deal with constituent interrogatives which express questions that ask for a specification of objects (things, mostly persons) of type e. Our examples will almost exclusively contain the wh-terms who and which CN. But we do claim that interrogatives containing other kinds of wh-terms, asking for specifications of objects of different types, can be handled in a similar way. As abstracts, such interrogatives simply express relations between other kinds of objects.

But, as it happens, even interrogatives containing only who or which CN as wh-terms may sometimes ask for specifications of other kinds of objects than just individuals or things. For example, in G&S 1983 it is argued that some interrogatives also have a reading in which they express a request to specify a certain Skolem-function.

A second case in point are de dicto readings of such interrogatives as:

- (a) What does John seek?
- (b) Whom does John worship?

The answer:

- (c) A unicorn.

to (a) might be taken to express the same proposition as the answer (d) to (a), interpreted de dicto:

- (d) John seeks a unicorn.

The analysis presented here does not account for such de dicto readings of interrogatives and answers. One way of doing so, a way which stays as close as possible to the way de dicto readings of indicatives are handled in Montague grammar, is to use abstraction over sets of properties of individuals besides (or instead of) abstraction over individuals. These kinds of examples are also left out of consideration in the remainder of this paper. Incorporating them, it seems, would be a basic exercise in Montague grammar, and would not affect the fundamental features of the proposal made here.

Although we do not have any definite opinions on the matter yet, we are inclined to believe that abstraction over sets of properties can also shed some light on the intricate problems surrounding the meaning of 'Who is...?'-interrogatives. Of course, we can construct such interrogatives as (e)

and (f):

- (e) Who is John?
- (f) Who is the president?

from abstracts over individuals, or individual concepts. For (e) this makes sense only if proper names are not considered to be rigid designators epistemically, otherwise the tautolo-

gical question results. (See also note 89.) On that analysis, (e) and (f) ask for the identification of an individual, the one bearing the name 'John', and the one that has the property of being the president, respectively. What in that case counts as an adequate answer depends largely on the context and on the information of the questioner. If the questioner can see the man in the corner, a satisfactory answer could be (g):

(g) The man standing over there in the corner.

Or, if he can remember the man we met yesterday during lunch, a good answer could be (h):

(h) The man we met yesterday during lunch.

But, as several authors have pointed out, we need not always be interested in this particular type of answer. We may not be interested in getting acquainted in this way with a certain individual, or it may be quite impossible to get acquainted with this individual in this way. Perhaps what we are interested in is to know what role John plays in a certain social context, or we might be interested in knowing some salient properties of the president. Requests for that kind of information can be made too by using the interrogatives (e) and (f), but then we need a different kind of reading for such interrogatives than the one we get abstracting over individuals. It seems not unreasonable to suppose that such a reading might be obtained by basing the interrogative on an abstract in which abstraction runs over sets of properties of individuals.

But this is certainly not the whole story. As soon as we start quantifying or abstracting over properties, functions, or sets of such entities, we run into the problem that there simply are far too many around. We met this problem e.g. in discussing functional readings of interrogatives, in G&S 1983. Szabolcsi (1984) also pays attention to it, for she meets the same problem when she applies her theory of semantic focus to other syntactic elements than terms. What seems to be needed is a formulation of some kind of semantic or pragmatic restriction on the functions, properties, etc. that are relevant in the domain of discourse. The problem of how to get such a restriction to work is a difficult one, and one that is relevant in other contexts besides question-answering as well.

The issue of 'Who is...?'-interrogatives is discussed at length in Boër & Lycan (1975) in the context of the problem what 'knowing who' amounts to. (An illuminating discussion of the theory of Boër & Lycan, and of the proposals of Aqvist, Hintikka and Kaplan can be found in Grewendorf (1983).) Boër & Lycan approach the matter by calling to help the notion of 'teleological relativity'. What knowing who amounts to, they argue, depends on the purpose of such knowledge. In terms of questions, it depends on what purpose they are to serve, what kind of specification or characterization the questioner is after, what exactly a 'Who is...?'-interrogative asks for. We share this observation (which by the way

certainly applies to other kinds of interrogatives in much the same way), but we do think the way in which Boër & Lycan try to incorporate teleological relativity in a logical framework poses a fundamental problem. Their general strategy is to build it into semantics proper. They want to assign different truth conditions to sentences of the form 'John knows who...is' relative to certain epistemic purposes. It is our feeling that in this way a largely pragmatic phenomenon is unduly brought into semantics.

But we hasten to add that certainly teleological relativity is one of those intriguing phenomena where it is hard to draw the line between semantics and pragmatics, between conventional truth-conditional aspects of meaning and interpretation and those which are conversational and non-truth-conditional. Mention some interpretations of interrogatives are another case in point. We discuss them in G&S 1984b, also paying attention to the question where to draw the line between semantics and pragmatics. Some remarks pertaining the different interpretations of 'Who is...?'-interrogatives can be found in G&S 1982b.

17. Wh-terms, like their logical counterparts, the λ -abstractors, are best viewed as syncategorematic expressions, but they need not be viewed this way. We might also take each wh-term to belong to a whole family of categories, viz. to each member of the family of categories AB^{n+1}/AB^n . See also G&S 1982, section 3.8., where it is explained why abstractors are necessary, and what goes wrong if wh-terms are treated as ordinary terms, as they are for example in Karttunen's analysis (see Karttunen 1977).
18. In this respect the theory outlined in this paper and others is intended to be more than a descriptively adequate theory of interrogatives and wh-complements in English. In fact, we would like to claim that some fundamental elements of the theory are 'universals' of natural language semantics. For example, we would like to claim that all natural language interrogatives can be fruitfully interpreted as partitions of the set of indices. Also, the analysis of the various relations of answerhood developed in G&S 1984a, and the systematic relationships between semantic and pragmatic properties of term phrases and such answerhood relations, we think will hold for any natural language. Other aspects of our analysis may be more language dependent. E.g. the way in which certain ambiguities manifest themselves will vary from language to language. But we would be surprised to find languages that do not have the means to express the readings in question.
19. See G&S 1982 section 2 for a concise sketch of Ty2 and a comparison with IL, the language of intensional type theory. A formal exposition and an extensive discussion of Ty2 can be found in Gallin (1975). See also Janssen (1983, chapter III). Ty2-models and IL-models contain basically the same ingredients. The important difference between the two languages is

that in Ty2, s is a basic type. Unlike IL, Ty2 has constants, variables and complex expressions of type s . Only variables of type s are being used here. The variables a , i and j are used as variables of type s , where a is a designated variable which we assume to be assigned the actual index. The modal operators of IL correspond to universal and existential quantification over indices, the intension operator corresponds to λ -abstraction, and the application of the extension operator to functional application to a . Ty2 has more expressive power than IL. In section 6.2 of G&S 1982 it was claimed that this excess power is really needed to state a correct translation rule for the process of quantifying terms into wh-complements. This claim was refuted in Zimmermann (1984).

20. In the syntax of wh-complements of Karttunen (1977) and that of G&S (1982), it is the first wh-term that is introduced, that is preposed. Bennett (1977) preposes the last wh-term that is introduced. He presents some syntactic and semantic arguments. We think that there are also arguments for the first position. As far as we can judge, the matter is still open, and needs further investigation. In the present paper, more in particular in the examples we will present, we adopt Bennett's position, for reasons of convenience. It makes it possible to state the semantic import of various rules in a more straightforward and natural way.
21. Questions are concepts, functions from indices to propositions, i.e. relations between indices. This means that they are essentially intensional objects. This is an important point. We firmly believe that it is beyond the resources of extensional logic to offer an interesting theory of questions and answerhood. If one tries to give an informal characterization of the notion of a question, one finds oneself using intensional notions. A question marks uncertainty. A question exists if several alternatives, several possibilities lie open. For someone asking a question, there are several possible answers. This multitude of possibilities is precisely what triggers a question. The purpose of posing a question is to take away this multitude of possibilities. It is to take away uncertainty by eliciting an answer from our addressee, who is to point out one of the possibilities as the actuality. And this is precisely what our technical notion of a question is aimed to model. And it is precisely for this reason that it is an intensional object, a function which for different possibilities, different indices yields different answers, different propositions.

This holds in much the same way if we look at interrogatives at the level of abstracts. At that level too we have to consider them as intensional objects, as properties or relations, i.e. as functions from indices to extensions. What we want to be informed about is an extension. And we request our addressee to specify the actual extension within a multitude of different possible extensions.

From this perspective it is no coincidence that within extensional frameworks, such as standard predicate logic, an

interesting logical theory of questions and answers never got off the ground. Viewing interrogatives as open formulas, or predicates does no justice to the essentially intensional character of their meaning.

The lack of success of extensional logic in getting to grips with questions has been taken to reveal that interrogative sentences, and thereby an important part of natural language, lies outside the realm of logic altogether. Consequently, questions were declared by some to be of no logical interest whatsoever, they were declined as purely a matter of psychology, or, more fashionably, of pragmatics. And this has led some linguists and some philosophers with an interest in natural language to declare logic to be of little or no interest for the study of natural language. The domain of logic, it was held, consists of the true and the false, logic deals exclusively with the assertoric, descriptive use of language.

This ill fate of questions bears some resemblance to that of the logical modalities. And it will be clear that it is our opinion that the development of intensional logic not only has brought the study of the logical modalities back to where it belongs, but also has brought within reach the construction of an adequate theory of questions and answers. And that will lend strong support to the view that logical, modeltheoretic semantics may be developed into a general theory of meaning for natural language.

Just as it was no coincidence that extensional logic never came up with a good theory of questions, it is no coincidence either that several theories of questions have been developed after possible world semantics came into existence. It is not our intention to claim that possible world semantics answers all our questions. It does not. Our main point is simply that a theory of questions and answers needs some notion of intension. Perhaps not the technical notion of intension we know from, say, intensional type theory, but some notion. We are convinced that a purely extensional, or a purely realist semantics will never be able to deal adequately with linguistic phenomena that pertain to information and information exchange. It is a well-known fact that the standard theory of possible world semantics in this domain fails in some respects too. It can be argued to be still too much of a realist theory. Yet, we think it is beyond doubt that at the present moment the framework of possible world semantics, with all its varieties, is by far the best overall framework to deal with intensional phenomena. Both in broadness and in depth, it has no real competitors yet.

22. It is the notion of a complete semantic answer. Beside this notion, other notions of answerhood are important as well, such as that of a pragmatic answer, and that of a partial answer. See also note 13, and section 4.
23. In this respect the analysis of the notion of answerhood outlined in G&S 1984a is a general one. Since it deals with questions and answer as semantic objects, its application is

not restricted to linguistic answers. In principle it applies to all kinds of information carriers, linguistic and otherwise. As for linguistic answers, sometimes an answer may carry information that has little or nothing to do with its conventional meaning, as the following example may illustrate:

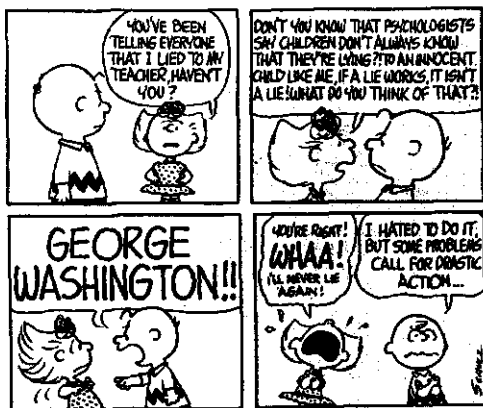

24. Not all theories conclude from this that constituent answers belong to the same syntactic category as indicatives, the category S. In Tichy (1978) and Scha (1983) the category of constituent answers seems to be identified with the category of the constituent. In Hausser (1976, 1983) they are assigned to the category S, but in a way that differs from the one that is used here. Hausser turns constituents into full sentences by adding so-called 'context-variables'. The category of the context variable corresponds to the category of what in our analysis is the abstract underlying the interrogative. The contextual interpretation of constituent answers is then carried out by assigning the interpretation of this expression to the context-variable.
25. Scha (1983), Tichy (1978) and Hausser (1976, 1983) all regard constituent answers as basic. Hamblin (1976) and Karttunen (1977) apparently consider sentential answers to be such. Sometimes the preference for one kind of answer over the other is reflected in the terminology that is used. Hausser for example uses the terms 'non-redundant answer' and 'redundant answer'. Belnap (1982) is neutral, noticing we need both kinds anyway.
26. This is a well-known phenomenon. Basing himself on Prior & Prior (1955), Scha (1983) traces its observation all the way back to Whately (1826). Hausser (1977) makes use of it to argue for his giving priority to constituent answers. What

seems to be original to our discussion of the phenomenon is that we explicitly relate it to the phenomenon of exhaustiveness.

The message is that questions may serve to disambiguate indicatives. For both theoretical and practical reasons it may be important to study in detail to which extent this is a fruitful idea. Logical semantics has it that almost any sentence is multiply ambiguous. This is often regarded as a serious defect. For one thing, it seems to contradict our intuitions. By this we do not mean that logical semantics generally assigns readings to sentences which intuitively they do not have. What we mean is that if almost all sentences are as ambiguous as is predicted, one would not expect language to be the effective means of communication it is. It would seem to predict that whenever a sentence is uttered it would take a lot of time and effort to decide which reading of the sentences one has to choose. As everyone agrees, the context is of great help in deciding between alternative readings. But building an explicit, full-blown theory of context and its functions is something that has not been achieved so far.

Our suggestion is that part of such a theory might consist in working out the idea that assertive utterances are generally implicitly or explicitly related to a question the addressee of the assertion has. Interpreting an assertion as a purported answer to a question may be of great help in resolving ambiguities.

It are scope ambiguities that we are thinking of here in the first place. In connection with this, it may be useful to notice that the way in which we view the derivation of answers to take place, viz. by combining an abstract and a constituent to form a sentential expression that expresses a proposition, is quite similar to the way in which the rules of quantification, which take care of scope ambiguities, operate in Montague grammar. On this view, a quantified-in expression would correspond to a questioned element.

A general theory of ambiguity resolution along these lines, if it could be made to work, would be useful too in the application of logical semantics in 'natural language engineering'.

27. An important difference between the treatment of constituent answers in Scha (1983) and those in Tichy (1978) and Hausser (1977,1983) is that Scha, basing himself on G&S 1982, does account for the exhaustiveness of answers, whereas Tichy and Hausser do not. The resulting exhaustive interpretations of answers generated in Scha's approach and in ours are much alike. But we feel that our way of achieving these results is more effective and theoretically more satisfactory. We hope to make this clear in notes 45, 55, and 59.
28. A semantic treatment of certain focus phenomena can be found in Szabolcsi (1981,1984). Interestingly enough, in her analysis of sentences with a focussed constituent (she only takes sentences with one focussed element into consideration)

she derives them from constituent interrogatives (analyzed more or less like our abstracts). Her analysis of sentences with a focussed constituent is quite like our analysis of answers. A focussed constituent receives an exhaustive interpretation. In her 1981 paper, Szabolcsi explicitly makes the connection between the interpretation of sentences with focussed constituents and the interpretation of answers.

29. We assume that the semantic interpretation of syntactically singular and syntactically plural interrogatives is basically the same. Thus, according to us, both the singular (27) and its plural counterpart (a):

(a) Which men walk in the garden?

ask for an exhaustive listing of men that walk in the garden. As for (27), one might feel that this interrogative presupposes that only one man walks in the garden, whereas (a) leaves this open (or presupposes that there is more than one). In G&S 1984c section 3.3 we have argued that, first of all, such presuppositions are not semantic presuppositions, but pragmatic presuppositions, which pertain to the expectations the questioner who phrases the question has regarding the answer. And secondly, we argued that the occurrence of existence- and uniqueness-presuppositions is not determined by the syntactic form of the interrogative, but is triggered by far more intricate, and highly context-dependent factors.

In view of this, we will ignore all matters concerning uniqueness- and existence-presuppositions throughout this paper. The reader who is not convinced by the argumentation and examples in G&S 1984c, is requested to substitute plural for singular interrogatives, and vice versa, wherever he or she feels this is needed to maintain consistency. If all is well, nothing that is argued for in this paper will hinge on this.

30. See section 6.3. of G&S 1982. As we did there, we suggest a pragmatic approach to the phenomenon of 'mention-some' interpretations of interrogatives. In G&S 1984b, the matter is discussed more extensively, and it is shown to what extent a semantic approach is possible within our framework. In this paper we deal exclusively with mention-all, or exhaustive answers, which we believe to be semantically more basic.
31. This fact was also observed in Zimmermann (1984), a paper which contains many interesting remarks concerning G&S 1982 besides, e.g. a detailed comparison with the theory put forward by Boër (Boër 1978).
32. We owe this example to Peter van Emde Boas, who brought it forward as an objection against the analysis of answerhood presented in G&S 1984a. We will argue in the text that it does not affect the analysis of answerhood as a semantic relation between questions and propositions. However, exam-

ples such as these do make clear that the abstracts underlying interrogatives have to play an essential role in determining the interpretation of linguistic answers. As a matter of fact, the present paper originated as a reaction to the criticisms made by van Emde Boas.

33. We will not attempt to give an exhaustive survey of all the attempts that have been made to cure standard possible world semantics from such disorders as the ascription of logical omniscience, the failure to deal with inconsistent beliefs, etc. Within possible world semantics, one might say, some of these problems have been handled adequately by some theories, but no theory has as yet dealt with them all in such a way as to gain universal acclaim. This holds for the approach that involves 'impossible worlds' (Hintikka), the one that takes propositions and the like as primitive entities (Thomason), for approaches that use structured meanings (Lewis, Cresswell), and others. Outside possible world semantics alternative approaches are beginning to emerge, of which we should mention the theory of situation semantics (Barwise & Perry) and that of datasemantics (Veltman, Landman). As we already stated earlier, we think that at present none of these alternatives, promising and exciting though they may be, has yet reached the status of a serious rival of possible world semantics and its varieties as a theory in which to study natural language semantics. (So no qualification is meant here regarding these frameworks as rival logical or philosophical theories.) In fact, we think that the resources of possible world semantics are far from exhausted and may fruitfully be explored further. Even though the fundamental limitations of a framework appear to be clear, it may be reasonable, even advisable in some cases, to develop it further. Not only may one use a tool successfully in one area, which fails in another, also doing so one may gain a clearer conception of what exactly it is that is wrong, and thereby a better view of what a more satisfactory framework should be like. To give an example that relates to the subject at hand, it is known that possible world semantics as a theory of information and of the way in which information grows and alters has its limitations (see e.g. Landman (1984)). Yet, for relatively simple cases it is a clear, well-defined and adequate tool, and applying it, as we did e.g. in developing some notions of pragmatic answerhood, one may even be surprised at how far it will take one. Let us not be misunderstood, we do not argue for rigid adherence to an established framework. But neither would we recommend setting aside a limited but useful tool in the absence of a definitely superior one. Linguistics, and certainly semantics, is not yet that much of a fullgrown branch of science, that we should not agree with Hugo Brandt Corstius who once remarked that "in linguistics too, one should let a thousand flowers bloom". (Though the use of just a little herbicide every now and then, may do no harm.)

34. At this point there is a difference between Scha (1983) on the one hand, and Szabolcsi (1981,1984) and our approach on the other. We want to apply the operation of exhaustivization to constituents on their usual interpretation. Scha creates a lexical ambiguity: constituents, terms, have two basic interpretations, the ordinary one, and an exhaustive interpretation. We prefer a compositional approach to exhaustivization in which the constituents as such are not considered to be lexically ambiguous, but receive an exhaustive interpretation as a result of the application of a single semantic operation of exhaustivization to ordinary constituent interpretations.
35. The derivation of such pairs is not really an essential feature of our approach. We could just as well derive interrogatives and answers separately. But what remains true even then, is that we need an abstract underlying an interrogative. The meaning of an answer is a function of the meaning of such an abstract and of the meaning of a constituent. In a compositional framework, such as that of Montague grammar, this requires that the abstract is a derivational part of the answer. If the context provided by an interrogative determines in part the interpretation of the answer, the framework requires it to be a derivational part of it. This holds just as well for sentential answers as it does for constituent ones. There is no way, or at least we see none, to derive sentential answers as if they were isolated sentences, expressing the propositions they express outside the context of an interrogative, and combine them with the interpretation of an interrogative or abstract to arrive at the required exhaustive interpretation. (This holds also if one works with structured propositions.) The only way to do it would be to decompose the sentence again in a part that corresponds to the abstract underlying the interrogative, and a part that is a constituent that fits the constituent interrogative. From these two parts the answer can be composed by exhaustifying the constituent part and putting it together again with the abstract part. See also section 5, in which the (im)possibility of a pragmatic approach to exhaustiveness is discussed.
36. In terms of the schema of figure 3 we can make a global comparison between our approach and others. A general difference between our approach and constituent answer based theories such as those put forward in Hausser (1977,1983), Tichy(1978) and Scha (1983) is that they all interpret the interrogative itself as an abstract. (This holds for the focus theory of Szabolcsi (1981,1984) just as well.) Like them we use the interpretation of the abstract as a property or a relation in order to arrive at a proper interpretation of answers, but the interrogative as such we treat as expressing a question (see also note 14). Tichy and Scha do not treat constituent answers as sentential expressions, Hausser does, making use of context-variables (see note 24). Tichy and Hausser do not account for exhaustiveness, they simply combine the interpretation of the constituent and that of the abstract,

without first exhaustifying the former. Scha does account for exhaustiveness, but not by means of a separate semantic operation that applies to ordinary constituent interpretations, but by making the constituents as such lexically ambiguous (see also note 34). In her theory of semantic focus, Szabolcsi accounts for exhaustiveness in much the same way as we do. Except for Scha's, constituent answer based theories all treat multiple constituent interrogatives poorly, if at all. Similarly, Szabolcsi only deals with sentences containing a single focussed constituent. Being strongly biased towards constituent answers, the theories of Scha, Hausser and Tichy pay little or no attention to sentential answers. According to our interpretation schema, both kinds of answers are to be treated on a par.

This comparison is rather global and streamlined, and leaves out many more or less important features of the theories discussed. In some notes still to come, we will discuss some details of Scha's and Szabolcsi's treatment of exhaustiveness, those two approaches being the ones that we consider to be closest to ours. A discussion of the theories of Hausser and Tichy can be found in G&S 1984c, section 4.2. and in notes 9 and 10.

37. But of course semantics may constrain syntax in certain ways if one operates in a compositional framework. A case in point regarding interrogatives and wh-complements, is the existence of the syntactic level of analysis of abstracts. Purely syntactic reasons for this do not seem to exist (if we disregard the fact that it provides a uniform level of analyses of interrogatives, wh-complements and another type of wh-constructions, viz. relative clauses, see G&S 1982, section 4.5.), but for semantic reasons its incorporation in the grammar is essential. In G&S 1982, section 3.8., we argued that without abstracts no correct semantics for multiple wh-complements could be given, a fact that has been proved by Zimmermann (see Zimmermann 1984).
38. Strictly speaking, an AB¹ corresponds to a set of individual concepts, and a T to a set of properties of individual concepts. Since we have no need for individual concepts here, we will ignore them, and speak of individuals, etc. See also note 15. Some have argued that individual concepts can be ignored altogether (see e.g. Dowty, Wall & Peters (1981)), whereas others see some use for them (see Gamut (1982) and Janssen (1984)). The latter paper contains a discussion of individual concepts and so-called 'concealed questions'.
39. There is one particular phenomenon that deserves special mention. The term surfacing in a constituent answer may contain what look like anaphoric pronouns that are bound by terms in the abstract. Consider the following examples:
- (a) Whom does John love?
 (i) Himself.
 (ii) John loves himself.

- (b) Whom does every man love?
 (i) His mother.
 (ii) Every man loves his mother.
- (c) Whom does no-one love?
 (i) His alter ego.
 (ii) No-one loves his alter ego.

At first sight these answers seem hard to account for given the way in which (S:IA1) and (T:IA1) are defined. According to these rules, the term on which an answer is based has wide scope with respect to terms occurring in the abstract underlying the interrogative. The standard way to construct the ordinary sentences that correspond to the sentential answers (a)(ii), (b)(ii) and (c)(ii) is to quantify the terms John, every man and no-one into the open sentences (d), (e) and (f) respectively:

- (d) PRO₁ loves PRO₁-self
 (e) PRO₁ loves PRO₁'s mother
 (f) PRO₁ loves PRO₁'s alter ego

If someone should want to account for (a) to (c) in a way which is analogous to this standard way of deriving these corresponding ordinary sentences, the rules (S:IA1) and (T:IA1) would stand in need of rather fundamental revision. Conversely, if we assume that the formulation is basically correct, we need a quite different way than the standard one to account for (a)(ii), (b)(ii) and (c)(ii).

We think that there are convincing reasons why one should take the latter approach. It is only superficially that the sentential answer (a)(ii)-(c)(ii) resemble their ordinary counterparts. In fact, it can be argued that the interrogatives (a), (b) and (c) on their reading in which (a)(i)-(ii), (b)(i)-(ii) and (c)(i)-(ii) are proper responses, are quite different from the interrogatives we discuss in this paper. And this difference is reflected in the interpretation of the constituent and sentential answers. In G&S 1983 we extensively discussed such interrogative-answer pairs as (b) and (c). There we argued that in such pairs the interrogatives can not be analysed as asking for a specification of individuals simpliciter, but rather have to be interpreted as asking for a specification of functions from individuals to individuals, i.e. for Skolem-functions. For example, the interrogative in the pair (c) asks to specify a function f such that for no individual x it holds that x loves $f(x)$, the individual the function associates with x .

We defended the view that this really is a separate reading of such interrogatives, distinct from the individual reading, on which (c) asks for a specification of one or more individuals whom no-one loves, and distinct too from the so-called pair-list reading, which in the case of (c) is not a possible reading at all.

On this view the terms himself, his mother and his alter ego, on which the answers in (a)-(c) are based, are not really terms, but specifications of such Skolem-functions. Thus, himself corresponds to a function f such that for all x ,

$f(x) = x$, and his mother to a function f such that for all x , $f(x) =$ the mother of x . (This means that these expressions are of category e/e . As we shall see shortly, there are good reasons to raise them to category T/T .)

What is important is that on this view these 'terms' do not have an anaphoric nature in the strict sense of the word. Their translation does not contain a free occurrence of a variable that is to be bound by a quantifier occurring in the translation of some other expression. They do get 'bound' by a term in the abstract, as the examples illustrate, but this is not binding in the ordinary sense. They are not bound variables, and that distinguishes them from most anaphors. This particular way of binding is discussed in some more detail in G&S 1983.

Although these remarks basically give an explanation of the way in which such interrogative-answer pairs as (a)-(c) can be dealt with without having to change the rules (S:IA1) and (T:IA1) in any fundamental way, something more is needed to make it really work. One has to provide a syntactic and semantic analysis of possessives and reflexives that allows one to operate along the lines sketched above. This is, of course, a subject on its own, and this is not the place to deal with it, so let us just indicate the outlines of such an analysis.

Possessives such as PRO's mother and the reflexive PRO-self are considered to be expressions of category T/T . Their translation would be something as indicated in (g) and (h):

- (g) $\lambda P \lambda P [P(a) (\lambda \lambda z \exists x [\forall y [(mother(a)(y) \wedge of(a)(y,z)] \leftrightarrow x=y] \wedge P(a)(x)])]$
 (h) $\lambda P [P]$

They can combine with terms as in John's mother, every man's mother, John himself (meaning the same as John), etc.

Using a form of category- and function-composition (see Geach 1972, Zwarts 1983, Moortgat 1984, for various applications of such techniques), these T/T -expressions can be combined with TV 's for example, resulting in such IV 's as (i) and (j):

- (i) love PRO's mother
 (j) love PRO-self

The translation of such IV 's is composed as follows:

- (k) If δ is a TV , σ a T/T , $\delta \sim \delta'$, $\sigma \sim \sigma'$, then the IV formed from δ and σ
 $\lambda x [\delta' (\lambda \sigma' (\lambda a \lambda P [P(a)(x)])) (x)]$

Reduced translations of (i) and (j) obtained using (k) are (l) and (m) respectively:

- (l) $\lambda z [\exists x [\forall y [(mother(a)(y) \wedge of(a)(y,z)] \leftrightarrow x=y] \wedge love(a)(z,x)]]$
 (m) $\lambda x [love(a)(x,x)]$

Combined with subject T's in the ordinary way, these expressions result in the proper translations for the resulting sentences.

To construct such interrogatives as in (a)-(c) we proceed in a similar way, using syntactic variables of category T/T. In the same way as (i) and (j) are derived, we form an IV from the TV *love* and such a syntactic variable of category T/T. This IV is combined in the usual way with a subject T (John, every man, no-one). The resulting S is used to form an abstract from, by abstracting over the variable of category T/T. Syntactically the same thing happens as when we abstract over individuals: the wh-term who(m) is introduced and, in this case, preposed. From these abstracts interrogatives are formed in the usual way. The abstracts are of the proper category to combine with the constituent answers in (a)-(c) to form proper sentential expressions, the sentential answers in (a)-(c).

Two remarks to finish with. First of all, notice that the rules (S:IA1) and (T:IA1) remain essentially the same. The only possible difference could be in the order of functional application, but that is not peculiar for these constructions. We observed the same phenomenon with 'de dicto'-readings of answers in note 16. Secondly, it should be noted that the syntax sketched above differs from the one proposed in G&S 1983. There doubly-indexed variables were used. In that paper we expressed our doubts concerning the elegance of the syntax, and we much prefer the rather graceful approach indicated here. The underlying motivations and ideas, and the semantic results obtained, however, do not differ.

40. It should be noted that we construe the notion of a text rather strictly here. There are of course texts which report an event of question-answering, or texts in which a rhetorical question is raised which is immediately followed by the answer. Such occurrences of interrogative-answer pairs too we consider to belong to the domain of what we called 'discourse grammar', and we believe them to be subject to the same conditions and constraints as ordinary interrogative-answer pairs. This will certainly hold for the first kind of textual occurrences, which are nothing but instances of direct speech.
41. There may be the slight difference, which we consider to be of a more or less pragmatic nature, that the (c)-sentences carry the (conventional) implicature that one might have expected more people to be walking, an expectation which is not expressed by the answers as such. Such aspects of meaning will not concern us here. Notice though that nothing in our analysis hinges on the semantic operation of exhaustivization co-inciding with the meaning of only.
42. Sentence (4)(c) can also be interpreted differently, viz. as expressing that of the set of boys all members walk, whereas of other sets, say the set of girls, or the set of all male individuals including adults, not all, but at most some

members walk. This is an instance of a general fact. A term of the form only + determiner + noun may have different interpretations depending on what exactly the scope of only, which is an expression that can be combined with expressions from all kinds of categories, is. Throughout this paper we will use only only as a term-modifier, i.e. the scope of only is always the entire term, and not just some part of it. All other readings will be ignored.

A second remark concerning (4)(c) is that some find terms of the form only every + noun unacceptable. Probably, the same people would prefer constituent answers such as the men, or all men, to an interrogative such as Who walk(s)? to the answer every man. The latter is also taken by some to be excluded from focus-position, topicalization, and the like. (Szabolcsi (1981) claims that the corresponding phrases in Hungarian cannot be subject to semantic focus.) One might think that the uneasiness felt with only every CN has something to do with pragmatic expectations (see note 41). Only is taken to indicate that there are less than expected, but how can one expect more than every? The answer is that one can. If one expects every boy and at least three girls to walk, the answer that it are only all the boys (but not one of the girls) indeed goes contrary to what is expected. The explanation, we think, has to be sought in another direction which has to do with the distinction between singular and plural. See note 47 for some speculations.

According to our intuitions the use of every CN as a constituent answer is beyond reproach. As for its being modified by only, the least we can say is that we've grown accustomed to it. But, as was remarked above in note 41, nothing hinges on exhaustivization being expressible by means of only or not.

43. It should be borne in mind that quantification, and hence exhaustivization, nearly always runs over a (very) limited part of the total domain. The existence of such contextual restrictions is important in judging the effects of quantification and the like. See also the discussion in G&S 1982, section 1.5 and 3.4.
44. See section 4, especially note 49.
45. As far as examples (12)-(16) are concerned, Scha (in Scha 1983) ends up with results which are equivalent to ours. But there is an important difference between our approach and the way in which Scha achieves these results. A proper name such as John (our example (12)) is considered to be ambiguous by Scha. Apart from its standard translation (given in (12)(a)), it is also given a special translation as a constituent answer, a translation which is equivalent with our (10)(c). So the result is the same. As a constituent answer John is interpreted exhaustively. But this is not the result of applying a semantic operation of exhaustivization to the standard interpretation of John, but it is obtained directly, by making proper names ambiguous. They

have their standard interpretation, and a special interpretation as constituent answers.

If only proper names were involved, this difference would not be that important. But, for a start, disjunctions and conjunctions of proper names can occur as constituent answers as well. For a disjunction, such as John or Mary (our example (15)), nothing spectacular is going on. Its interpretation can simply be taken to be the standard disjunction of Scha's constituent answer translations of John and Mary. For a conjunction of proper names occurring as a constituent answer, such as John and Mary (our example (13)), things are fundamentally different, however. In this case it will not do to take the standard conjunction of Scha's constituent answer translations of John and Mary. For the resulting translation would be (a):

$$(a) \lambda P[\forall x[P(x) \leftrightarrow x = j] \wedge \forall x[P(x) \leftrightarrow x = m]]$$

And the set of sets denoted by (a) is the empty set. In fact, that things go wrong this way, was already indicated implicitly in the text, when we discussed the examples (9)-(11). It was indicated there that only α or only β is equivalent to only (α or β), but only α and only β is not equivalent to only (α and β). Of the latter two, the first is a contradictory term, and the second is the proper exhaustive interpretation of a conjunctive term α and β .

But since Scha lacks a general semantic operation of exhaustivization, he is forced to compose the constituent answer interpretation of John and Mary from the constituent answer interpretations of John and Mary respectively. This is possible, but at a price: the introduction of a special interpretation of and, i.e. of conjunction, when occurring in constituent answers. I.e. John and Mary as a constituent answer has to be derived from the constituent answers John and Mary by a special conjunction rule for constituent answers. If α and β are constituent answers translating as α' and β' respectively, then their conjunction α and β translates as (b):

$$(b) \lambda P[\exists X[\alpha'(X) \wedge \exists Y[\beta'(Y) \wedge P = \lambda x[X(x) \vee Y(x)]]]$$

In settheoretical terms, α and β denoting sets of sets, this conjunction corresponds to taking the pairwise union of the elements (and not, as ordinary conjunction, to taking the intersection of the sets as such). If we apply (b) to John and Mary on Scha's special constituent interpretation, the resulting translation is indeed equivalent to our (13)(b), where exhaustivization is applied to the standard conjunction of John and Mary on their standard interpretation.

But not only does Scha need special translations for proper names as constituent answers and for conjunction of constituent answers, he also needs special translations for determiners, such as every and a(n). (The special interpretation of a(n) must have the effect of normal disjunction of 'exhaustified' elements, and that of every must have the effect of the special constituent answer conjunction of such elements.)

And this is not the end. Many other expressions and rules which are involved in the composition of complex term phrases will need a special 'constituent answer' counterpart of their ordinary interpretation.

We believe that these facts speak for themselves. Provided that our approach gives equally good results, it is to be preferred to Scha's for being simpler and theoretically more sound.

46. This means that exh can be applied to anything that denotes a set of sets. Thus it has the same kind of variable character as such logical expressions as quantifiers, the λ -operator, etc. This will become clear also in sections 3.2 and 3.3 where exh will be used to exhaustify all kinds of other objects than the sets of sets of individuals it semantically operates on here.

47. We must distinguish between two kinds of cases here. First of all, there are terms which, in order for exhaustivization to arrive at the proper outcome, should be treated as essentially plural terms. These are discussed in the next section. Example are at least one girl, at most John, John or Mary or both. These terms can be used to form constituent answers from, i.e. answers which can be interpreted as exhaustive specifications of the extension of some property. (For further discussion, see the next section.)

But besides these plural terms, there are others, terms which seem not to allow for an exhaustive interpretation at all. Examples of such terms are no man, not John. Constituent answers in which these terms surface, cannot be interpreted, intuitively, as exhaustive specifications. On the contrary, they are inherently non-exhaustive, 'negative' specifications. This intuition is reflected formally in the fact that exhaustivization applied to these terms gives bad results. It reduces their denotation to the singleton containing the empty set. Hence they should be excluded from the interrogative-answer rules.

In order to formulate this restriction one would like to have a semantic characterization of this class. Although intuitively the terms in question form a homogeneous class, a formal definition is hard to come by. That their exhaustivization is $\{\emptyset\}$ is not a defining characteristic, this holds for at most John for example too. A term such as the latter, however, loses this characteristic as soon as we treat it as a plural term, as we, arguably, should do. So, the class of terms to be excluded seems to consist of those monotone decreasing terms for which a plural treatment, a 'group' interpretation, is not possible. That is as close to a characterization as we can get at this stage. A more precise one requires a full extension of the apparatus of generalized quantifier theory (see Barwise & Cooper 1981, Zwarts 1981) to plural terms. Some work in this area has been done (see the remarks in van Benthem 1983), but much is yet unclear.

The notion of an essentially singular term might also be used to explain some intuitions regarding the acceptability of such terms as every boy as constituent answers (see note 42).

48. Problems arise once one starts treating collective (non-distributive) predicates, such as gather, conspire and the like. Consider the following examples:

- (a) The boys gather
- (b) John and Bill conspire to gain control over the vakgroep
- (c) Peter and Fred carried the piano up the stairs

In (a) and (b) the property expressed by the predicate is ascribed to the boys and John and Bill respectively as a group, or as a whole, and not to each of them individually. In (c) this collective reading is the most plausible one, though perhaps not the only possible one.

49. It should be noted that the term 'group' as it is used here, is intended to be neutral. I.e. it is not to have any connotations regarding some form of spatio-temporal, or social homogeneity.
50. For some early discussions see Bennett (1975), Bartsch (1973) and Hausser (1974). Of recently formulated theories we mention Link (1983), and especially Scha (1981). In these works one can also find many more examples than the few given in note 48, which show the necessity of a semantic theory of plural.
51. We assume that walk is a distributive predicate, i.e. one that holds of a group iff it holds of its members. See also the discussion of the examples (26) and (28) below.
52. This paraphrase of the meaning of At least n girls, as an answer to the interrogative Who walk(s)? is correct only if the answer is interpreted exhaustively. Superficially, it looks as if the same phrase can also be used to give an explicitly non-exhaustive answer. But notice that in that case it carries a distinctively different intonation pattern. (For an interesting theory about intonation as a linguistic phenomenon with semantic import, see Koene (1984).) Then it means that n girls are ones that walk and that maybe others, girls or boys or what have you, walk as well. As an explicit non-exhaustiveness marker at least is a term-modifier (like only). If at least n girls is to be interpreted exhaustively, at least n is to be taken as a determiner, or quantifier. As a non-exhaustiveness marker at least can also be applied to a proper name for example, as in at least John. If we take this term as a constituent answer, it is explicitly non-exhaustive, and means that John walks and that, as far as the speaker knows, others may be walking as well. See also note 54 in which a similar difference between at most and at most n is discussed.
53. Johan van Benthem helped us to realize that this cannot be the whole story. The interpretation (34) of the plural term at most n girls is, at best, one of the meanings this phrase has. To see this, observe that according to (34), sentence (a) can also be true in a situation in which, besides some group of at most six girls, also a group of, say, seven

girls gather:

(a) At most six girls gather

For collective predicates, or collectively interpreted predicates, this seems not to be implausible. If one observes, opening the door of room 26 and piercing through the heavy smoke, that a group of girls is gathering there, and that they are at most six; and one further observes, opening the door of room 27 in which the air is of crystalline purity, that there seven girls are having a meeting, it seems one can truthfully say that at most six girls gather and seven girls gather. To account for this, we need to assign to the phrase at most n girls (also) an interpretation which involves existential quantification over groups. Under this interpretation, which is meant to be captured by (34), at most n girls means 'some group of at most n girls'. (In fact, perhaps this more elaborate phrase is more natural to use in reporting such observations as described above.)

An interpretation like this one is also needed to account for the intuitive judgement that sentence (a) is false, or at least not true, in case no girls gather. To gather is a property of groups with at least two members. The empty group cannot be in the set of groups denoted by gather. Suppose only John and Bill gather, then gather denotes the set containing just the group consisting of John and Bill. But this set cannot be one of the elements of the set of sets of groups denoted by at most n girls, if it is interpreted as in (34). Each set of groups in the latter has to contain some group of girls with less than $n+1$ members, e.g. the empty group.

This seems to be sufficient reason to adopt an interpretation like (34) as one of the interpretations (by some called the 'referential' interpretation) such phrases have. It is needed for collective predicates, and collectively interpreted predicates, and also to obtain the proper exhaustive interpretation of such phrases when they occur as linguistic answers.

The interpretation (34) of at most n girls runs parallel to the interpretations (29) and (30) of at least n girls and n girls respectively. They, too, contain existential quantification over groups. The relevant interpretations (34), (29) and (30) of these three kinds of terms can be obtained by composing them as follows. Assuming numerals to be intersubjective adjectives, we can give them the Fregean interpretation (b):

(b) $\{G \mid |G| = n\}$, where G ranges over groups

At least and at most can then be understood as modifiers of such adjectives, being interpreted as (c) and (d) respectively, where N is the interpretation of a numeral:

(c) $\{G \mid \exists G' \in N: G' \subseteq G\}$

(d) $\{G \mid \exists G' \in N: G \subseteq G'\}$

The entire termphrases n girls, at least n girls, and at most n girls, are then formed as follows. From the relevant (modified) numeral a determiner is formed by combining it with a morphologically empty determiner, which is interpreted as existential quantification (over groups). This complex determiner, which, using lambdas, can be written down as in (e), is then combined with the plural noun girls, which is interpreted as denoting the set of all groups of girls, including the empty group:

- (e) $\lambda X \lambda Y \exists G [G \in M(N) \ \& \ G \subseteq X \ \& \ G \subseteq Y]$, where $M(N)$ is the modified numeral, and X, Y range over sets of groups

The resulting interpretations of the termphrases are those given in (30), (29) and (34).

Besides these interpretations, which are needed for collective predicates and collectively interpreted predicates, these termphrases also need another interpretation. This is most clear in the case of at most n girls. Consider sentence (f):

- (f) At most six girls walk in the garden

Interpreting to walk in the garden as a really distributive predicate, it seems that (f) should come out false in case there actually happen to be seven girls who are walking in the garden. Analogously, given the distributive interpretation of the predicate, (f) should come out true in case no girls walk in the garden. So, it seems that for at most n girls we also need an interpretation like (g):

- (g) $\{x \mid \forall G: G \subseteq X \Rightarrow |\bigcup G| \leq n\}$, where girl is the group of all girls

This interpretation gives the same results as the standard singular interpretation of this term, which shows that, as for as distributive predicates are concerned, the term need not be interpreted as semantically plural.

But, as we have seen in the text, the singular interpretation, and hence also this plural interpretation (g), give wrong results when submitted to exhaustivization. (Both the singular interpretation and the 'distributive' plural interpretation (g) are monotone decreasing and have the empty set as their smallest element. The other, 'collective', plural interpretation (34), being in essence an existentially quantified term, is not monotone decreasing.)

What this points at, is that if the term at most n girls surfaces in an answer, this forces a collective interpretation, even if the predicate in question is distributive. I.e., Who walk(s)? is answered by such a phrase as if it asks for a specification of the group (or groups) of which the members walk. This is also suggested by the following observation (which we owe to Johan van Benthem). Suppose we do take the plural walk in Who walk? distributively. Then it denotes the set of all subgroups of the group of all walkers. The exhaustive interpretation of the plural three girls is a set of singletons

each consisting of some group of three girls. It does not contain any subgroups, however. Now suppose that the ones that walk are three girls. Then the distributive interpretation of walk is not contained in the exhaustive interpretation of three girls, which is wrong.

Again, this may be taken to show that even such outright distributive predicates as walk in the garden should be interpreted collectively in certain interrogative-answer pairs. If we interpret Who walk in the garden? as indicated above, viz. as asking for a specification of the group of all people that walk in the garden (allowing this specification to consist of a specification of groups that together form the group of all walkers), things work out alright.

Of course, there is also another way out. One could also extend the analysis as follows. For singular terms and arbitrary predicates, and for plural terms and collective, or collectively interpreted, predicates, the schema of applying the exhaustive term interpretation to the predicate suffices. For the case of plural terms and distributively interpreted predicates, one could add, after exhaustivization, an operation of 'decollectivization'. First, we exhaustivize the plural term, interpreted collectively, which results in a set of sets of groups. Decollectivizing consist of adding to each set of groups the group which is their union with all subgroups of that union. Applying this result to the distributive predicate also gives correct results.

Just like all other remarks made in the text and in other notes about the analysis of plurality, these, too, should be interpreted as speculations. The entire area of the semantics of plurality is one with so many pitfalls, mysteries, and exciting and depressing surprises, that it would be foolish to claim to have said anything definitive. The point we want to make here in connection with linguistic answers, more in particular their exhaustive interpretation, is just that some terms have to be given a 'collective' plural interpretation too. That much can be argued for also on independent grounds, and hence is, we take, uncontroversial. Our further aim has been to indicate, roughly, what this interpretation would have to look like, in order for exhaustivization to work properly.

54. In fact, this exhaustive interpretation of at most n girls is also a possible interpretation of superficially the same term in isolation, i.e. without applying the operation of exhaustivization to it. In that case the term has a different intonation pattern. The, we have to consider at most as a term modifier, modifying n girls, and should not consider the term to be constructed from the determiner, or quantifier, at most n and the noun girls. (Cf. what was said in note 52 about a similar ambiguity of at least n girls.) As a term modifier, at most can also be applied to proper names for example, to form a term such as at most John, meaning John or no-one at all. The meaning of at most as a term modifier is related to the semantic operation of exhaustivization (and hence to the meaning of only) in an interesting way. Whereas John exhaustively interpreted (i.e. interpreted as only John) corresponds to the set $\{\{\text{John}\}\}$, at most John corresponds to the set $\{\emptyset, \{\text{John}\}\}$. Roughly speaking, and

not paying attention to plurality yet, what the interpretation of at most does to the set of sets corresponding to a term to which it is applied, is, first, to exhaustify it, which results in a subset of the original set of sets, and, next, expanding this new set by adding all the subsets of the elements of this new set to it. Thus we can define:

$$(a) \text{ at-most}(\alpha) = \lambda X[\exists Y[\text{exh}(\alpha)(Y) \wedge \forall x[X(x) \rightarrow Y(x)]]]$$

Like exhaustivization and only, the term modifier at most requires that the terms to which it is applied are viewed as semantically plural (even when they are syntactically singular). At most John, for example, should not simply be interpreted as the set of sets of individuals $\{\emptyset, \{\text{John}\}\}$. Rather, it should be viewed as denoting the set of sets of groups $\{\{\emptyset\}, \{\{\text{John}\}\}\}$ (where \emptyset stands for the empty group). This can be argued for as follows. If we were to apply the semantic operation of exhaustivization (or the semantic interpretation of only) to the first, the result would be $\{\emptyset\}$. But if we were to apply it to the second, the result would be the same set $\{\{\emptyset\}, \{\{\text{John}\}\}\}$ again. The latter is clearly correct, and the former even more clearly not. The phrase only at most John might be a funny phrase to use, but this is because the addition of only to at most John really is redundant, and not because it would mean the same as no-one. (Because exhaustivization is part of the interpretation of at most, see (a), only is redundant as well in at most only John. Both only at most John and at most only John simply mean the same as at most John.)

Notice that there are many more term modifiers that behave in the same way as at most. Examples are everyone except and no-one except as they occur in terms such as everyone except John and no-one except John.

55. This note is a continuation of note 45 in which we discussed the analysis of exhaustiveness of constituent answers given in Scha (1983). There we concluded that our approach is to be preferred, provided it gives equally good results as Scha's. We had some reason to make this provision. The theory of Scha has no difficulty in accounting for the correct interpretation of the constituent answer John or Mary of both (John and Mary). Scha can construct this disjunctive answer from the constituent answer John, Mary and John and Mary. The latter are already interpreted exhaustively, via the lexical ambiguity of proper names and the special conjunction rule. Ordinary disjunction is then enough to obtain the correct result.

However, this is only one example of a constituent answer where Scha comes round without, and where we need, taking plurality into account. As a matter of fact, at least n girls and at most n girls need not pose a problem for Scha either. He can take recourse to his by now familiar strategy and create a lexical ambiguity for these determiners too. The required exhaustive interpretation could just be added to the standard one. And it looks like that, with some ingenuity, any example can be dealt with provided one allows oneself to create lexically ambiguous terms and all kinds of ambiguous term phrase forming expressions and operations at will.

On our approach, however, no such multiplication of interpretations is needed (and could therefore be excluded, thus

strengthening the predictions the theory makes). We do need to assume that plurality is to be accounted for in the semantic interpretation of terms. But that can be argued for too on completely independent grounds, and therefore constitutes no ad-hoc move.

Another relevant observation is the following. We have noticed that the term modifier only is intimately connected with the semantic process of exhaustivization. Exhaustivization of constituent answers might perhaps be dealt with by doing it in Scha's way, but that most certainly will not do as an interpretation of only. The interpretation of only is to be given in such a way that it gives correct results when it is applied to simple and complex terms on their standard interpretation. Scha's account of exhaustiveness cannot be used to deal with the interpretation of only in an intelligible way. Ours can, as soon as plurality is taken into account. (So, the semantics of only gives yet another reason for taking plurality seriously.)

And one might add, finally, that only is not the only case in point. The term modifier at most poses precisely the same problems, as was argued in note 54.

56. In previous notes, we have already indicated that our approach to exhaustivization is basically the same as that of Szabolcsi (1981, 1984). From Szabolcsi (1984) we can extract the following alternative definition of exh:

$$(a) \text{ exh} = \lambda P \lambda P' [\lambda x [P(a)(x) \wedge P'(a)(\lambda a P)] = \lambda x [VP' [P(a)(\lambda a \lambda y [P(a)(y) \wedge P'(a)(y)]) \rightarrow P'(a)(y)]]]$$

In fact, this definition is equivalent to definition (36). The difference is one of form, not one of content. But because of (a)'s form, we did not succeed in getting a clear picture of its content. (We suspect that Szabolcsi did not succeed in this either, since she does not give an informal characterization of the content of (a), and seems rather embarrassed by its complexity.) We tried to get such a picture by applying (a) to different examples. In doing so, we came to understand why the different clauses in the definition are needed, but still did not arrive at a general picture. It appears as if Szabolcsi started out with a much simpler definition, something like (b) (which happens to be equivalent to the translation of only we gave in G&S 1976):

$$(b) \text{ exh} = \lambda P \lambda P' [\lambda x [P(a)(x)] = \lambda x [VP' [P(a)(P) \rightarrow P'(a)(x)]]]$$

Definition (b) is simpler than (a), but it is not correct. It gives intelligible results only when applied to certain kinds of terms, such as proper names, conjunctions thereof, and universally quantified terms. For disjunctive terms and existentially quantified ones, e.g., the results are not correct. It seems as if Szabolcsi noticed these counterexamples to (b), and arrived at (a) by adding clauses that avoid them. As we noted, the result is effective, but not really beautiful.

In checking Szabolcsi's definition (a) by examples, we also met the problems with plurality discussed in section 3.1.3. We then decided to put aside Szabolcsi's definition

and to take a new start altogether. We took up the issue by starting from the semantic side, and first tried to get a clear picture of the semantic content of exhaustivization, only to give it form in a definition afterwards. The results are reported in the main text. We then had to find out that the problems with plurality remain, but this time we were in a better position to locate them and evaluate them. And that led us to the conclusion that plurality is involved in an essential way, and should be dealt with as such.

A last step, then, was to conclude that the new definition we had come up with, and Szabolcsi's, which we had first rejected, are equivalent.

57. This terminology may easily cause some confusion. Normally, if something is referred to as being n -place, what is meant is that it has n open places to be filled by n arguments. For an n -place term this is different. For all n , including 0, an n -place term takes only one argument, this argument being an n -place relation. One could say that being n -place for terms means that it has the capacity to fill in n -places (of its one argument) at once.
- Notice that, according to (T) an ordinary term phrase, i.e. an expression of category T^1 , is defined as S/AB^1 , and not as S/IV , as is usual. But since $IV = S/E = AB^1$ (cf. definition (AB) in section 1), the proper category is assigned after all.
- Notice also that, according to (T), a T^0 is of category S/S , the category to which also sentence adverbs belong. T^0 's are discussed in detail in section 3.3.
58. In note 20 we said that we assumed the last wh-term that is introduced, to be preposed, and that we made this assumption for reasons of convenience. The formulation of the rule (T: T^0) is one of them. If we would choose the first wh-term to be preposed, the order of abstraction in an abstract is reversed. Then a 2-place sequence such as John, Bill would have to denote the set of 2-place relations in which Bill stands to John. We have chosen here for the order which sounds more natural, but, of course, there is no problem at all, if, for some reason, one wants the reversed order. So, no stand is taken here in the issue as to what the adequate syntactic analysis of multiple wh-complements in English actually is. Both options can be accommodated.
59. Here we continue our comments on Scha (1983). His analysis of constituent answers to single constituent interrogatives can be extended quite easily to multiple constituent interrogatives. His rule for forming n -place terms can be exactly the same as ours. But, evidently, it cannot be applied to terms on their standard interpretation, but has to work on terms on their special constituent answer interpretation. n -place constituent answers are formed from simple constituent answers. Our rule of disjunction and Scha's analogue can be the same, though, again, on Scha's approach a proper new n -place constituent answer results only if n -place constituent answers are taken as input. As was also the case with conjunction of

single constituent answers, Scha needs a different, special rule of conjunction for conjunctions of n-place constituent answers. It will be parallel to the special conjunction rule given in note 45 in exactly the same way as our rule for conjoining n-place sequences (S:CTⁿ)/(T:CTR) runs parallel to the ordinary rule for conjoining ordinary terms.

Further it can be noted that what was said in 45 and 55 about Scha's analysis of single constituent answers applies in much the same way to his analysis of multiple constituent answers.

60. In categorial, constituent answer based approaches to interrogatives, such as Hausser's (see Hausser 1977, 1983), there is also a tendency to view constituent answers to sentential interrogatives as (being based on) sentence adverbs. But there is a difference. Since categorial analyses of interrogatives remain at the level of abstracts, so to speak, their proponents are hesitant to take truth value expressions, i.e. our AB⁰'s, as what corresponds to sentential interrogatives. Hausser, for example, treats them as a kind of constituent interrogatives. The constituent in such cases is a sentence adverb. Thus viewed, sentential interrogatives, like constituent interrogatives, are based on 'real' abstracts, in this case abstracts in which abstraction takes place over the kind of semantic object that sentence adverbs stand for, i.e. over functions from propositions to truth values. Thus, in Hausser's analysis, the sentential interrogative (a) is translated into something that in Ty2 looks like (b) (S is a variable of type $f(S/S)$):

(a) Does John walk?

(b) $\lambda S[S(\lambda a \text{ walk}(a)(j)) \wedge [S = \lambda p p(a) \vee S = \lambda p \neg p(a)]]$

So, the interrogative (a) corresponds to abstraction over what are called 'sentence modi', the possible values of the latter being restricted to the interpretations of yes and no respectively (see section 3.3.2).

Bäuerle, who discusses several approaches to sentential interrogatives in Bäuerle (1979), characterizes Hausser's approach as an alternative interrogative approach to sentential interrogatives. Hausser's translation restricts the alternatives to the complete positive answer and the complete negative answer. This restriction is much too harsh, since, as we shall see in section 3.3.3, the interrogative (a) might just as well be answered by the constituent answer If Mary walks., which is also based on a sentence adverb (or perhaps more accurately, on an expression that is of the same category as sentence adverbs), but one that literally does not fit in Hausser's schema. This could be remedied by taking (c) instead of (b) as translation of (a):

(c) $\lambda S[S(\lambda a \text{ walk}(a)(j))]$

But we feel rather sympathetic towards translation (b) since it tries to capture the unmistakable fact that the propositions that John walks and that John does not walk, have a special status as answer to (a). They are the two standard

complete semantic answers. On our approach, however, this is accounted for more effectively by analyzing (a) as an expression of category \bar{S} , expressing a question which is a bipartition, i.e. which has two possible semantic answers. At the same time, we account for the equally unmistakable fact that (a) has more constituent answers than just yes, and no, by treating it as being based on a 'degenerate' abstract, an AB^0 . That such an AB^0 is a truth value expression need not bother us, since on our approach the level of abstracts is only an intermediate stage in the derivation of the full-blooded, question expressing interrogative.

On Hausser's approach to (a), in which it is treated as a kind of alternative interrogative, it seems to be natural to view (d) as a simple variant of (a):

(d) Does John walk or not?

But, as Bäuerle observes, (a) and (d) are answered in a completely different fashion. The interrogative (d) can not be answered by a simple yes, or a simple no. It requires full sentences as answers.

A different, though related, phenomenon is observed by Bäuerle with respect to other types of alternative interrogatives, such as (e):

(e) Does John walk, or Mary?

Though it looks in several respects like a sentential interrogative, the characteristic answers of (e) are those of a single constituent interrogative:

(f) John.
Mary.
Both,
Neither one of them.

Bäuerle compares (e) with (g):

(g) Who walks, John or Mary?

The single constituent interrogative (g) allows for all four answers in (f) too, i.e. it allows for precisely the same answers as (e). Bäuerle praises Hausser's approach for analyzing (e) as (h):

(h) $\lambda P[P(\lambda a \text{ walk}(a)) \wedge [P = \lambda P P(a)(j) \vee P = \lambda P P(a)(m)]]$

But Bäuerle does not seem to notice that it are only the first two answers in (f) that are allowed for by (h).

We would consider (e) and (g) to be a special kind of single constituent interrogatives, variants of each other, which are both derived from an abstract translating as (i):

(i) $\lambda x[[x = j \vee x = m] \wedge \text{walk}(a)(x)]$

Such interrogatives could be characterized as 'single constituent alternative interrogatives'. The sentential alternative interrogative (d) could be analyzed in a similar fashion. One might derive (d) from an abstract that translates as (j):

(j) $\lambda p[[p = \lambda a \text{ walk}(a)(j) \vee p = \lambda a \neg \text{walk}(a)(j)] \wedge p(a)]$

If the abstract translating as (j) is transformed into an interrogative by our standard means, it will express precisely the same question as the simple yes/no-interrogative (a). The fact that it is derived from a different type of abstract accounts for the fact that it calls for different kinds of answers: full sentences, expressing propositions, rather than the simple constituent answers Yes. and No. In this way we can make a clearcut distinction between simple sentential interrogatives, such as (a), and alternative sentential interrogatives, such as (d), in terms of the syntactic form their answers may take, and at the same time account for the fact that they express the same question. (Interestingly enough, (j) is the translation of the final stage of analysis of both (a) and (d) in Karttunen's approach (see Karttunen (1975)). Like Hausser, Karttunen treats (a) and (d) as simple syntactic variants having the same derivation, and thus also fails to account for the difference in kind of answers they allow.)

Bäuerle, who discusses these kind of phenomena in an interesting and illuminating way, proposes a kind of solution to these puzzles which differs from the one outlined above. The kind of approach he advocates might be characterized as an 'extreme categorial approach'. From such examples as we discussed above, Bäuerle concludes that so called yes/no-interrogatives are really a kind of constituent interrogatives. In his view, an interrogative such as (a) is a constituent interrogative, more precisely an alternative constituent interrogative that offers only one alternative. He seems to suggest that, in fact, (a) is much like (k):

(k) Who walks, John?

which he considers to be similar to (g), the difference being that (k) offers only one alternative, whereas (g) offers two. In our terms, Bäuerle's proposal means that where (g) derives from an abstract that translates as (i), (k) derives from an AB^1 that translates as (l):

(l) $\lambda x[\text{walk}(a)(x) \wedge x = j]$

We don't think this view can be considered to be overall correct. In our opinion, the interrogative (k) corresponds to something like (m):

(m) Who walks? Is John the one who walks?

We believe that our view that (a) and (k) are different interrogatives, express different questions, is supported by the following observations. It is true that both (a) and (k) can be answered positively simply by Yes. or by (n):

(n) Yes, John.

This would seem to support the supposed equivalence of (a) and (k). But things are different for negative answers. A simple No. will not do as an answer to (k), although it is perfectly allright as an answer to (a). Rather, for a negative answer to (k) something like (o) seems to be required:

(o) No, Peter.

Or some answer like (p):

(p) No, nobody.

If (k) indeed corresponds to (m), as we conjectured, and not to (a), as Bäuerle would have it, this difference could be explained easily and naturally. If it is answered by a simple Yes., the second of the two questions posed by (m) is answered. And a positive answer to the second question, in this case provides the answer to the first one at the same time. In the negative case this is different. If the second question raised by (m) is answered negatively, the first question remains unanswered. That is why in that case a simple No. is not sufficient, and answers like (o) and (p) are called for. For these answers not only answer the second question negatively, they also contain an answer to the first one.

In some situations, the interrogative (a) is used in such a way that it calls for an answer such as (o) or (p) too (should the answer be negative). This happens if John in (a) carries emphatic stress, as indicated in (q):

(q) Does JOHN walk?

For (q) too, a simple Yes. will suffice, but a simple No. will not, at least not as a complete answer, or so it seems. In our opinion, (q) is best viewed as a simple yes/no-interrogative, and the emphatic stress is to be interpreted as an indication that at the background, so to speak, i.e. behind the question that is actually, or literally, posed, there is another question at stake, being the (constituent) question who is the one that walks. A negative answer to (q) answers the question it poses literally, completely, but it does not provide an answer to this background question, which, it seems, is ultimately the question one wants an answer to, if one uses (q). This is why a simple No. strikes us as insufficient, and why a further answer seems to be called for.

61. In Gazdar (1979) a purely pragmatic explanation is offered for the fact that natural language disjunctions, which are semantically inclusive, are interpreted exclusively. However in order to obtain this result Gazdar has to call to aid a much too strong version of the Maxim of Quantity. Gazdar deals with Quantity by means of two independent mechanisms. One gives rise to so-called 'scalar implicatures'. A scalar implicature of a disjunction $\phi \vee \psi$ is that the speaker knows that it is not the case that $\phi \wedge \psi$. And a second implicature that can be obtained, is that the speaker does not know whether ϕ and does not know whether ψ . Together, these two implicatures have the effect of turning an ordinary disjunction in an exclusive one. Though Gazdar obtains the two by means of two mechanisms, the effects they have are related. It holds that $\phi \wedge \psi$, ϕ , and ψ are all logically stronger than $\phi \vee \psi$. Other things being equal, Quantity implies that logically stronger sentences are to be preferred. The correct formulation of Quantity would have to state this in a general way. It is easy to see that such a formulation would give rise, in the case of $\phi \vee \psi$, to the implicatures $\neg K_S(\phi \wedge \psi)$,

$\neg K_S(\phi)$, and $\neg K_S(\psi)$. Since at the same time Quality requires $K_S(\phi \vee \psi)$, both $\neg K_S(\neg\phi)$ and $\neg K_S(\neg\psi)$ can be derived as well.

The funny thing is that Gazdar's two mechanisms, which are both related to Quantity, have different effects. Gazdar's scalar implicature reads $K_S\neg(\phi \wedge \psi)$, rather than $\neg K_S(\phi \wedge \psi)$. He offers no motivation whatsoever for the curious fact that one part of his formulation of quantity implicatures has a much stronger effect than another. And in fact, it is easy to see that the strong scalar implicatures lead to absurd consequences. For example, it will be implicatures of the sentence Someone walks that $K_S\neg$ John walks, $K_S\neg$ Bill walks, and so on for all the individuals in the domain of discourse. But that means that it will be a scalar implicature of Someone walks that the speaker knows that no-one does.

Unless one is prepared to accept this kind of absurdity, it seems that no formulation of the Maxim of Quantity is possible that will give rise to an exclusiveness implicature for disjunctions. On the contrary, a correct formulation of Quantity will give rise to the implicature that $\neg K_S(\phi \vee \psi)$, using \vee to stand for exclusive disjunction. And this for the simple reason that $\phi \vee \psi$ is logically stronger than $\phi \vee \psi$. Our 'interrogative' approach to the matter, which hinges on exhaustiveness, and relates the exclusive interpretation to a particular kind of use of disjunction in a particular kind of context, offers a far better explanation for the phenomenon in question, than Gazdar's ad-hoc pragmatic approach.

62. This fact is pretty obvious, and can hardly escape attention, or so one would think. It is rather surprising to notice, therefore, that often the problem is not even mentioned. And if it is paid due attention to, as for example in Hoepelman (1981) and Bäuerle (1979), the problem is simply put aside by refusing to give yes and no the semantic interpretation they are entitled to. It may sound interesting to hear it be declared that "I agree with Bäuerle (1979, p.68-69) that "yes" and "no" are not to be taken as answers, but as "discourse elements that relate the answer to the question in some way or other". (Hoepelman, 1981, 224), but this is mere rhetoric, and does not solve anything if it does not come along with a clearcut analysis of such 'discourse elements'. Intuitively, yes and no are answers, and it is quite clear what their meaning is. (For if they are not, what then exactly are they supposed to relate when they are offered as responses 'on their own'?) To be sure, the semantic analysis of yes and no has its problems, but a solution of them cannot be had by simply throwing away what seems to be at least part of the truth, and replacing it by vacuous promises.
63. In various languages different lexical elements are available to do the job, such as the Dutch ja and jawel, the German ja and doch, the French oui and si, and the old English yea and yes. See also Hoepelman (1981) and Bäuerle (1979) and the references cited in the latter.

64. In Hoepelman (1981) an extensive discussion of negative interrogatives and other puzzles can be found. Although his informal description of the difference between positive and negative interrogatives and their answers seems to be akin to ours, his way of dealing with the phenomenon is quite different. Whereas we say that a positive and a negative interrogative express the same question, Hoepelman considers them to express different questions, i.e. he treats them as being semantically different.

According to Hoepelman, interrogatives denote truth-values. Of these he has four, and he uses a four-valued logic based on them to analyze interrogatives. The system Hoepelman ends up with allows one to do some interesting calculations. Yet his approach does not appeal to us at all. It lacks an intuitive basis and it mixes up semantics and pragmatics in an intolerable way. Hoepelman considers an interrogative ?p to be 'true' iff the truth value of p is indeterminate. So, according to Hoepelman, ?p is to mean something like 'p is the question', or 'it is the question whether p'. Obviously then, 'truth values' are not really truth values, but rather some kind of epistemic values. As we said, Hoepelman distinguishes four of these. The maximum value seems to mean something like having the information that p is the case, and the minimum value something like having the the information that p is not the case. Instead of one middle value, meaning something like p being indeterminate as far as the information goes, Hoepelman distinguishes two. In both cases the epistemic value is indeterminate. They are distinguished in that the middle value which is closest to the maximum value indicates that one expects the answer to be a positive one, whereas the other middle value, which is closes to the minimum, indicates that one has negative expectations.

The latter distinction is meant to explain the difference between positive and negative interrogatives. A positive interrogative is 'true' if one does not know the answer, but expects it to be positive. And the negative interrogative is 'true' if one does not know the answer, but expects it to be negative. In all other cases, interrogatives are 'false', i.e. they are assigned the minimum value.

One question that, of course, immediately comes to mind is whether four values is enough. It seems perfectly possible to have a question without having any expectations as to whether the answer to it will be positive or negative. But such a situation is not allowed for by Hoepelman's system. As we argued in the text, we believe that the straightforward interrogative, the positive, 'unmarked' case, corresponds to this situation. If one has positive or negative expectations, these need to be marked, in the interrogative, or otherwise.

It is clear that Hoepelman's system mixes up semantics and pragmatics. Truth and falsity of interrogatives is really nothing but correctness and incorrectness of (a certain form of) questioning. But correctness is purely a pragmatic notion and nothing seems to be gained by blurring the distinction between semantics and pragmatics.

In support of his view Hoepelman notes that many languages

have two different versions of 'yes' and 'no'. (see also note 63). Since $2 + 2 = 4$, this matches nicely with the four values in his system. (But since $2 + 2 \neq 5$, it does not match nicely with the five situations one should distinguish, once one starts distinguishing the way Hoepelman does.) Both versions of 'yes' bring the questioner from the indeterminate state into the maximally positive one. One version is reserved for the case in which the questioner has positive expectations and the other for the case in which his expectations are negative (except in languages like Icelandic in which one can say "Yes, we have no bananas.") The two versions of 'no' are distinguished analogously.

We believe that the same phenomena can be captured in our approach quite as easily. We think it is an advantage that we do not have to take recourse to a formal system that mixes up purely semantic objects and semantic notions (truth, truth conditions, entailment) with purely pragmatic ones (information of language users, their expectations, correctness conditions). The semantic interpretation we assign to interrogatives is more standard, can be linked up with the standard semantics of indicatives without effort, and deals with notions like entailment between interrogatives, and other logical relations between interrogatives and indicatives in an adequate and intuitively satisfying way (see G&S 1984a). Linking this semantic theory with a pragmatic one meets with little problems, be it that such niceties as expectations of language users are not yet dealt with formally. But we think this line of thought is promising, and is to be preferred to Hoepelman's approach which, though formal, lacks an intuitive basis.

65. Pragmatic considerations come in once we view question-answering as a process of information exchange. Exchanging information is a game played by at least two persons. A full description of the game, its rules and its strategies should take into account not only the information of the questioner, but also that of the addressee. And equally important is the information they have about each other's information. The addressee will give an answer based on what he believes to know. In communicating this information he has to put it into words. In doing this, he has to anticipate on the interpretation the questioner may give to his words. He will try to formulate his answer in such a way that as far as his information about the information of the questioner goes, he stands the best chance to fill in the gap in the information of the questioner which is indicated by her question. Part of what is involved in this was discussed in sections 8 and 9 of G&S 1984a. See also the remarks in G&S 1984c, section 2.2.3.
66. The notions of answerhood defined here are not exactly the same as those introduced in G&S 1984a, and they are not always defined in precisely the same way. In the earlier paper the emphasis lies on pragmatic notions of answerhood. Here we start from semantic notions. For each pragmatic notion in

G&S 1984a, we here introduce its semantic counterpart. But nothing really new is introduced that way. Semantic notions of answerhood are just the limits of the corresponding pragmatic notions. The latter are defined with respect to an information set, a subset of the set of indices. In case the information set equals the set of indices, i.e. in case it contains no information at all, the pragmatic notions collapse into the semantic ones.

In this paper we will not repeat the explanations given in our earlier paper in any detail. Though we use slightly different notions and formulations here at some points, we trust the reader will have no difficulty in tracing back their counterparts and accompanying explanations and examples in G&S 1984a.

67. The only exception is the tautologous question, expressed by both the interrogative Is it true that it rains or does not rain? and Is it true that it rains and does not rain? Such interrogatives do not have two, but only one semantic answer. The linguistic answer Yes. to the first, and the answer No. to the second, both express the tautology. The partition corresponding to the tautologous question has only one element, the tautology. So, the partition the tautologous question makes on I is {I}.
68. This definition, and other to follow, have to be stated relative to a frame, or to a model. We will not bother about this, since in the present context it would be a mere formality to do so.
69. There is one exception to this rule. The complete answer to the tautologous question is not a partial one as well. Since a tautologous question has only one possible semantic answer, it cannot be answered partially. It takes at least two possible semantic answer if a proposition is to exclude one possible semantic answer and be compatible with at least one. It can further be noticed that though in general not every partial answer is a complete one at the same time, this does hold for partial answers to yes/no-questions, since these have only two possible semantic answers. Though yes/no-questions are thus not open to really partial answers, they do allow for another kind of non-complete answers, referred to in G&S 1984a section 7 as 'indirect' answers.
70. This notion of the partial answer to a question given by a proposition which gives a partial answer to it, was lacking in G&S 1984a. It proves to be quite handy in a definition of notions of true answers, as Theo Janssen predicted.
71. This remarkable fact was given due attention in G&S 1984a section 5. See also section 4.2. below, especially the pair of examples (18) and (19).
72. Problematic cases are terms such as no man, at most n men, John or (John and Mary). On their standard treatment, which

does not take plurality into account, these terms come out as definite terms under definition (10). This is wrong, but does not mark a defect of the definition, but is due to the shortcomings of the standard way of treating terms. This is borne out by the fact that, once semantic plurality is taken into account, these terms indeed do come out as being indefinite. As we saw in section 3.1.3., a term such as John or (John and Mary) will then no longer correspond to a set of sets of individuals, having the set {John, Mary} as its unique smallest element (as the standard treatment has it), but rather will be treated as a set of sets of groups, having two smallest elements, the set {[John]} and the set {[John, Mary]}.

73. There is no need for a similar notion of semi-exhaustiveness. According to definition (8) of exhaustiveness, if a term is exhaustive, it remains so if it is extended with a non-restrictive relative clause.
74. It need not be a surprise that exhaustiveness is involved in all four notions of answerhood which are dealt with here. In this paper we only discuss mention-all questions and their answers, which are inherently exhaustive. We feel justified in restricting ourselves this way, since we believe exhaustive questions to be basic and mention-some questions largely to be a pragmatic phenomenon. (This latter view we defend with a little more doubt. See G&S 1984b for an extensive discussion of the matter.) It can be noticed, however, that if one drops the property of exhaustiveness in our statements (12), (17), (22) and (23), we do arrive at precisely the corresponding facts concerning connections between properties of terms and mention-some notions of answerhood. To give just one example, a rigid and definite term will give rise to a semantic mention-some answer to a question. Taking both mention-all and mention-some answers into account shows most clearly that the essential property of terms that is involved in guaranteeing semantic answerhood is that of rigidity. It is the one and only property that pops up in any connection between properties of terms and notions of answerhood.
75. Thus in a Court Room examination the interrogator and the witness share a lot of information, information which is often sufficient to guarantee the communicative success of what are semantically indefinite answers. So, if the D.A. asks "And who agreed to buy the jewellery you were to steal?", an answer such as "Well, you know, the guy we talked about last time", or "The same man who always fences for me", will not do, even though the D.A. may know perfectly well who the individual that is meant, is, and thus indeed has his question answered. Instead, he will proceed to elicit a semantic identification, saying e.g. "You mean mr. So-and-so?". This is perfectly understandable if we realize what is going on in this particular type of question-answering. The D.A. is not asking questions as a private person, with all

the information he has as a private person, but he is asking them on behalf of, as if he were, the entire community. (A criminal trial, in many countries, is a case of the State, or the Crown, or the People versus the accused.) So the answers are directed to the community, and not to the D.A. personally. This means that they should be satisfactory for the members of the community, and hence that they may assume only as much information as being available as every member of the community is assumed to have. Clearly, semantically rigid answers fulfill this requirement best. (Of course, what is semantically rigid, or what is assumed to be for ideological reasons, may differ from society to society, or from one social context to another, What is said here, should, therefore, be taken as a description of a general mechanism, not an actual situation.)

Quiz-situations, too, provide excellent examples of situations in which a semantically rigid answer is called for, even in case the respondent is able to come up with an answer that is complete and true, given the information available, but that is not semantically rigid. Thus, a true description will never be accepted as an answer to a 'Who won the such-and-such then-and-then'-question. Only a name will do. The explanation for this is not the same as for the Court Room case. Here, it seems that quiz-questions do not ask for information at all (they do not really test the knowledge of the candidate). If one candidate is able to come up with the right name, although he evidently has absolutely no idea as to who the referent of the name is, and another candidate knows just about everything there is to know, except the one thing that is needed in that situation, the name, then still the answer the first candidate gives will be accepted as the 'right' answer, and the answer of the second will not (though sometimes the quiz-master will be sympathetic and count it as if it were a good answer). See also G&S 1982b for some other remarks.

76. The special role of standard answers in ordinary communicative situations, or rather the comparative notion of one answer being more standard than another, is discussed in some more detail in sections 8 and 9 of G&S 1984a, and in appendix 2 of the present paper.
77. An information set $J_{x,i} \subseteq I$, represents the information of a speech participant x at an index i . In the text the subscripts x and i are suppressed. The indices $j \in J$ are the indices compatible with the information x has at i . Each $j \in J$ could be the actual index as far as the information of x goes. So, the more information x has, the smaller J will be. The requirement that J be non-empty is the requirement that the information of x be consistent. It is the only requirement that is being imposed on information sets here (since it is the only one we need for our present purposes). Many more could, and should be made to obtain a notion that is overall satisfactory. Also, it should be noted that we do not require that i be an element of $J_{x,i}$. This would require the information to

be completely true. So, if we talk about information, we talk about belief, and not about knowledge. In G&S 1984 both belief sets (doxastic sets) and knowledge sets (epistemic sets) are taken into consideration.

We only consider information x has about/at the actual index, and we only consider factual information, i.e. information about the world as such, and not information about the information of other speech participants. For our present purposes incorporating such aspects would only complicate matters unnecessarily. Linguistic information, i.e. information about the meanings of expressions of the language is assumed to be fully incorporated in any information set. A speech participant may be in doubt about the facts, but not about the meanings. Within the present framework it is a consequence of this assumption that if an intension is a constant function, i.e. in case we are dealing with a rigid designator, a speech participant cannot fail to know the denotation of such an expression. This unfortunate property of the framework can be dealt with (see note 33, and some of the notes yet to follow), but we will not do so here, since it would only introduce unnecessary complications. For other relevant issues, see G&S 1981, and Landman (1984).

78. Clearly, I/Q and J/Q are related to each other. In particular, the partition Q makes on I is preserved in J :
 $\forall X \in J/Q \exists Y \in I/Q: X \subseteq Y$. See also G&A 1984a, section 3.
79. This is not a straightforward paraphrase of definition (25), but it is completely in accordance with it. The paraphrase is stated in terms of adding a proposition to an information set, i.e. in terms of updating J with new information. This is, of course, a quite natural way of looking at what happens when a proposition is offered as an answer. In G&S 1984a the various pragmatic notions of answerhood are defined using this notion. For our present purposes it is more economic to define answerhood without introducing the notion of update.
- Notice that we do not need to require that $P \cap J \neq \emptyset$, since $P \cap J \in J/Q$ guarantees this. Since $J \neq \emptyset$, $\emptyset \notin J/Q$.
80. There is one exception to this. According to the semantic definitions, a proposition can be or give an answer to the tautologous question. If we take J equal to I , the pragmatic definitions do not cover this exceptional case, since all these definitions have as precondition that Q be a question in J . For no set $J \subseteq I$ will the tautologous question be a question in J .
81. This peculiar fact is given due attention in G&S 1984a, section 5. We will meet an example in section 4.4 below, example (38).

82. In appendix 2 we will also meet the more direct pragmatic analogue of the notion of the semantic answer to Q given by P. This notion is that of the pragmatic answer to Q given by P in J, defined as $\cup\{P' \mid P' \in J/Q \ \& \ P' \cap P \cap J \neq \emptyset\}$. This notion will prove to be convenient in making a comparative evaluation of pragmatic answers.
83. In appendix 1 we will show that the notions of pragmatic rigidity and pragmatic definiteness can also be used to define the pragmatic distinction between the specific and the non-specific use of terms, as it was discussed in G&S 1981.
84. The fact that your father contains an indexical does not really matter in this example.
85. This example was discussed in section 6.3. of G&S 1982. At the time we thought that in order to be able to cope with answers such as the one in (38), one would need a refinement of one's semantics. We found such examples of answers to be problematic cases for a semantics of interrogatives based on the semantics of wh-complements we had developed in that paper. The mistake we made there, was to think that answerhood is an overall semantic notion. The example poses no problem at all as soon it is acknowledged that answerhood is first and foremost a pragmatic notion.
86. The notion of pragmatic rigidity of definite description is related to what is referred to as their referential (in distinction of their attributive) use. See appendix 1.
87. This is true only if there is just one elderly lady wearing glasses among the staff. But even in case there are more than one, the answer in (40) could be a complete answer. This would happen in case there is only one such lady in the shoe-department, even though there are others in other departments to which the description the customer uses applies as well. In this case the fact that a complete answer results, not only depends on the pragmatic interpretation of the term as such, but also on the pragmatic interpretation of the interrogative. It asks for an identification of a person who served the customer when he bought boots, so only persons who are working in the shoe-department are possible candidates. (Cf. with what is said in appendix 1 about the specific use of indefinite descriptions. There too both pragmatic properties of the term and the context of the sentence in which it occurs, are relevant.)
88. This fact is intimately related to what is said in appendix 1 about the specific use of terms.
89. A definite description might even give rise to a better answer than a proper name. This will happen in case the questioner does know who the referent of the description is, but not who

the referent of the proper name is. However, since we assume here that proper names are rigid designators such a situation cannot occur in the framework we use. If a name is a rigid designator it belongs to the linguistic knowledge of all speech participants to know its referent.

Even within possible world semantics there are various ways to do things better, without giving up completely the rigid designator view of proper names, which, after all, seems quite firmly established. One way to do this, which uses rather orthodox means, is to add a non-universal accessibility relation to the model. One can then introduce a more restricted notion of being a rigid designator, e.g. defining α to be rigid iff for i and j that are related by this relation it holds that the denotation of α in i is the same as in j . Without further changes it then becomes possible not to know who the referent of a rigid designator is, even when one does know (does have the linguistic knowledge) that it is a rigid designator. (See also G&S 1982b for a more extensive discussion and a different kind of perspective on this issue.)

90. Contrary to what is suggested in Scha (1983, page 15, referring to G&S 1982), our theory of answerhood in no way depends on the availability of semantically rigid answers at all. If a language lacks rigid designators, or if they are lacking for particular domains of discourse (which is more than likely, see also G&S 1982b), this only means that it is more difficult, in some cases perhaps impossible, to formulate an answer linguistically, in words, that gives a semantic answer (but there are other means too, of course). This in no way denies that semantic answerhood exists as a semantic relation, i.e. as a relation between model theoretic entities. Our pragmatic theory explains why even for such a language, or for such domains of discourse, effective question-answering is possible. Semantic answers function as a kind of 'norm', so to speak, as an ideal one strives for in answering situations, but nothing dramatically happens if this ideal can't be reached. More in particular, it does not mean that effective and complete communication cannot be achieved. (See also sections 8 and 9 of G&S 1984a, and appendix 2 of this paper, for a further explanation of the normative role of standard semantic answers.)
91. Our formulation here, and elsewhere in this section, might suggest that we believe that there is a sharp dividing line between factual and linguistic information. This we certainly do not believe. Although we do not make this explicit in the text, we use the notion 'factual information' in a kind of technical sense, and the same holds for its counterpart 'linguistic information'. As technical notions, they only make sense relative to some model, or some class of models. By linguistic knowledge we mean all information that is build into the model, or is expressed in restrictions that are laid down in meaning postulates and the like. What is true throughout the model, or class of models, will be true

in any information set, given the way we construct them here. Such truths constitute the linguistic knowledge, in the technical sense, with respect to that (class of) model(s). All truths in an information set over and above these analytical truths, constitute factual information, again in the technical sense.

So, within a certain model, or class of models, there is a sharp division between linguistic truth and factual truth, but it should be borne in mind that there are only few a priori reasons which force a decision as to what kind of information one should build into the model and what not. In that sense, we believe, there is no sharp division between linguistic and factual information. (This line of thinking seems to agree with that of Johnson-Laird (1982) and Partee (1982).)

92. Partial pragmatic answers to yes/no-questions are not possible according to our definitions (see also note 69). In case the questioner has neither the information that Mary comes, nor the information that she does not come, and at the same time does not consider it impossible that my coming to the party depends on Mary's coming, the answer constitutes what we call an 'indirect' answer. Such an answer does not give a definite yes or a definite no, but it helps the questioner in this sense that it gives him a 'new' way of getting answers via the answer to another question. Given the answer If Mary comes, in the situation just sketched, he may get an answer to his original question through an answer to the question whether Mary is coming. For further discussion of indirect answers, see G&S 1984a, section 7.
93. This holds for the exhaustiveness of answers to constituent interrogatives more clearly than it does for the exhaustiveness of answers to sentential interrogatives. As for the latter, they do not, at least not in any intuitive sense of the word, ask for a specification of, a list of, items. Still, as we have seen in section 3.3.3 and section 4.5, exhaustiveness is all important in the latter case as well. This casts some doubt on the reliability of the intuition that exhaustiveness is a pragmatic phenomenon.
94. See also the discussion in note 61 about the impossibility of giving a purely pragmatic account of the fact the natural language disjunctions are sometimes interpreted as exclusive disjunctions.
95. In Grice (1975) the Maxim of Manner contains the submaxim "Avoid ambiguity". This should not, of course, be taken to say that one may only use sentences which are completely semantically unambiguous. For such sentences hardly exist, and those that do, are almost always very complicated and prolific structures. Rather, we think we must take this submaxim to require something less stringent, and the observation made in the text may help to explain why this requirement may

be less stringent than it looks at first sight. Also it may be of some help to account for existence-presuppositions of negative sentences containing definite descriptions.

96. The pragmatic distinction between specific and non-specific use, as it is discussed and defined in G&S 1981, is intimately related to the distinction between speaker's reference and semantic reference, as it is drawn by Kripke in Kripke (1979).
97. See Donnellan (1966), and the discussion in Kripke (1979).
98. In G&S 1984a a less general fact was stated, viz. (24) restricted to epistemic sets. As we see here, this restriction is not necessary. The only restriction that is made is that P_1 and P_2 are compatible in J .

References

- Aqvist, L., A new approach to the logical theory of questions, Philosophical Studies, Uppsala, 1965 (new edition: Narr, Tübingen, 1975)
- Bartsch, R., 'The semantics and syntax of number and numbers', in: J. Kimball (ed.), Syntax and semantics, Vol. 2, Academic Press, New York, 1973
- Idem, 'Correctness and norms of language', to appear
- Barwise, J. & R. Cooper, 'Generalized quantifiers and natural language', Linguistics and Philosophy, 4, 1981
- Bäuerle, R., 'Questions and answers', in: R. Bäuerle, U. Egli & A. von Stechow (eds), Semantics from different points of view, Springer, Berlin, 1979
- Belnap, N., 'Questions and answers in Montague grammar', in: Saarinen & Peters (1982)
- Belnap, N. & T. Steel, The logic of questions and answers, Yale University Press, New Haven, 1976
- Bennett, M., Some extensions of a Montague fragment of English, University Microfilms, Ann Arbor, 1975
- Bentham, J. van, 'Determiners and logic', Linguistics and Philosophy, 6, 1983
- Boër, S., 'Toward a theory of indirect question clauses', Linguistics and Philosophy, 2, 1978
- Boër, S. & W. Lycan, 'Knowing who', Philosophical studies, 28, 1975
- Donellan, K., 'Reference and definite descriptions', The Philosophical Review, 75, 1966
- Dowty, D., R. Wall & S. Peters, Introduction to Montague semantics, Reidel, Dordrecht, 1981
- Egli, U. & H. Schleichert, 'Bibliography of the theory of questions and answers', in: Belnap & Steel (1976)
- Frege, G., 'Der Gedanke', Beiträge zur Philosophie des Deutschen Idealismus, 2, 1918/1919 (also in: G. Frege, Logische Untersuchungen, hrg. G. Patzig, Vandenhoeck & Ruprecht, Göttingen, 1976)
- Gallin, D., Intensional and higher order modal logic, North Holland, Amsterdam, 1975

- Gamut, L.T.F., Logica, taal en betekenis 2, Intensionele logica en logische grammatica, Het Spectrum, Utrecht, 1982
- Gazdar, G., Pragmatics, Academic Press, New York, 1979
- Geach, P., 'A program for syntax', in: D. Davidson & G. Harman (eds.), Semantics of natural language, Reidel, Dordrecht, 1972
- Grewendorf, G., 'What answers can be given?', in: Kiefer (1983)
- Grice, H.P., 'Logic and conversation', in: P. Cole & J. Morgan (eds.), Syntax and semantics, Vol. 3, Academic Press, New York, 1975
- Groenendijk, J. & M. Stokhof, 'Some notes on personal pronouns, reflexives and sloppy identity in a Montague grammar', in: K. Braunmüller & W. Kürschner (eds.), Grammatik, Niemeyer, Tübingen, 1976
- Idem, 'A pragmatic analysis of specificity', in: F. Heny (ed.), Ambiguities in intensional contexts, Reidel, Dordrecht, 1981
- Idem, 'Semantic analysis of wh-complements', Linguistics and Philosophy, 5, 1982
- Idem, 'Formal and acquainted objects in the theory of information', ms., Amsterdam, 1982b
- Idem, 'Interrogative quantifiers and Skolem-functions', in: K. Ehlich & H. van Riemsdijk (eds.), Connectedness in sentence, discourse and text, Tilburg, 1983
- Idem, 'On the semantics of questions and the pragmatics of answers', in: Landman & Veltman (1984)
- Idem, 'Coordinating interrogatives', ms., Amsterdam, 1984b
- Idem, 'Problems and prospects in the theory of questions' ms., Amsterdam, 1984c
- Groenendijk, J., T.M.V. Janssen & M. Stokhof (eds.), Formal methods in the study of language, Mathematical Centre, Amsterdam, 1981
- Hamblin, C.L., 'Questions in Montague English', in: B. Partee (ed.), Montague grammar, Academic Press, New York, 1976 (originally in Foundations of Language, 10, 1973)
- Harrah, D., Communication: a logical model, MIT Press, Cambridge, Mass., 1963
- Hausser, R., Quantification in an extended Montague grammar, dissertation, University of Texas at Austin, 1974
- Idem, 'The logic of questions and answers', ms., München, 1976
- Idem, 'The syntax and semantics of English mood', in: Kiefer (1983)
- Hintikka, J., The semantics of questions and the questions of semantics, Acta Philosophica Fennica, 28 (4), 1976
- Hoepelman, J., 'On questions', in Groenendijk et. al. (1981) (also in Kiefer (1983))

- Janssen, T.M.V., Foundations and applications of Montague Grammar, dissertation, University of Amsterdam, 1983
- Idem, 'Individual concepts are usefull', in: Landman & Veltman 1984
- Johnson-Laird, P.M., 'Formal semantics and the psychology of meaning', in: Saarinen & Peters (1982)
- Karttunen, L., 'Syntax and semantics of questions', Linguistics and Philosophy, 1, 1977
- Kiefer, F. (ed.), Questions and answers, Reidel, Dordrecht, 1983
- Koene, N., De eigen semantische systematiek van de natuurlijke taal, dissertation, University of Amsterdam, 1984
- Kripke, S., 'Speaker's reference and semantic reference', in: French, P., Th. Uehling & H. Wettstein (eds.), Contemporary perspectives in the philosophy of language, University of Minnesota Press, Minneapolis, 1979
- Landman, F., 'Representation of information and information growth I', ms., Amsterdam, 1984
- Landman, F. & F. Veltman (eds), Varieties of formal semantics, Foris, Dordrecht, 1984
- Link, G., 'Logical analysis of plural and mass terms', in: Bäuerle, R., C. Schwarze & A. von Stechow (eds.), Meaning, use, and interpretation of language, de Gruyter, Berlin, 1983
- Moortgat, M., 'Word formation and Frege's principle', ms., Leiden, 1984
- Partee, B., 'Belief-sentences and the limits of semantics', in: Saarinen & Peters (1982)
- Prior, A. & M. Prior, 'Erotetic logic', The Philosophical Review, 64, 1955
- Saarinen, E. & S. Peters, Processes, beliefs and questions, Reidel, Dordrecht, 1982
- Scha, R., 'Distributive, collective and cumulative quantification', in: Groenendijk et. al. (1981)
- Idem, Logical foundations for question answering, dissertation, University of Groningen, 1983
- Searle, J., Speech acts, Cambridge University Press, Cambridge, 1969
- Szabolcsi, A., 'The semantics of topic-focus articulation', in: Groenendijk et. al. (1981)
- Idem, 'Focussing properties in Montague Grammar', ms., Budapest, 1984.
- Tichy, P., 'Questions, answers, and logic', Americal Philosophical Quarterly, 15, 1978
- Whately, R., Elements of Logic, London, 1826

- Zimmermann, T., 'Remarks on Groenendijk and Stokhof's theory of indirect questions', ms., Konstanz, 1984
- Zwarts, F., 'Negatief polaire uitdrukkingen I', *GLOT*, 4, 1981
- Idem, 'Categoriale grammatica - Uhlenbeck revisited', ms., Groningen, 1983

VI

COORDINATING INTERROGATIVES

CONTENTS

1. Introduction	443
2. Some phenomena	446
2.1. Pair-list readings of interrogatives	446
2.2. Choice readings of interrogatives	450
2.3. Mention-some interpretations of interrogatives	457
2.4. Conclusion	462
3. Interrogatives, coordination and quantification	464
3.1. General rules of coordination and quantification	464
3.2. Coordination and quantification in some propositional theories	468
3.2.1. Karttunen	470
3.2.2. Towards the core theory	476
3.2.3. The core theory	485
3.2.4. Bennett and Belnap	490
4. Pair-list readings and choice readings in an extension of the core theory	495
4.1. Introduction	495
4.2. The lifted core theory	497
4.2.1. Disjunction in the core theory	497
4.2.2. Lifting interrogatives	498
4.2.3. Answerhood and entailment	503
4.2.4. Linguistic answers	506
4.3. Pair-list readings and choice readings	508
4.3.1. Pair-list readings	508
4.3.2. Choice readings	512
4.3.3. Pair-list readings and choice readings of complements	523
4.4. Conclusion	526
5. A semantic treatment of mention-some interpretations	528
5.1. Introduction	528
5.2. Problems for a pragmatic approach	530
5.3. A semantic approach	534
5.4. Problems for a semantic approach	543
6. A flexible approach to Montague grammar	547
Notes	554
References	565

1. Introduction

In the literature there has been some discussion of certain types of interrogative sentences which (seem to) allow for more than one complete and true semantic answer. This paper will be concerned mainly with the issue whether such interrogatives can be accommodated in keeping with the principles underlying the theory of interrogatives and answers we developed in earlier papers.¹

The main features of our approach such as are relevant to the contents of this paper, can be summarized as follows. An interrogative sentence denotes a proposition, and its denotation at a certain index is the proposition that an indicative sentence should express if it is to constitute a complete and true semantic answer to that interrogative at that index.

The denotation of an interrogative being a proposition, its sense (meaning) is a propositional concept, a relation between indices. The relation expressed by an interrogative is an equivalence relation, and is called a question.

Syntactically, interrogatives are derived from n -place abstracts, which express n -place relations. The corresponding semantic operation turns such a relation into a proposition, being the equivalence class of indices at which the extension of this relation is the same as at the actual index.

An n -place abstract is derived from an $(n-1)$ -place one by introducing a *wh*-phrase. Semantically, this operation is restricted λ -abstraction.

All characteristic linguistic answers, both constituent (short) and sentential (long) ones, express propositions. Syntactically, they are derived from the abstract underlying the interrogative and a constituent. The corresponding semantic

operation consists in giving the constituent an exhaustive interpretation and then forming a proposition from it and the relation expressed by the abstract.

Semantic notions of answerhood are defined as relations between propositions, expressed by answers, and questions, expressed by interrogatives. Analogous pragmatic notions are obtained by relativizing to information sets.

In principle, *wh*-complements are given the same semantic interpretation as the corresponding interrogatives. Being proposition denoting expressions, they are taken to belong to the same major syntactic category as other types of complements.

Complement embedding verbs are distinguished in extensional ones, such as know, which operate on the proposition denoted by a complement, and intensional ones, such as wonder, which take the sense of a complement as argument.

To the theory of interrogatives and answers characterized by these features, we will refer as the core theory. The central concept in this theory is that of a question. As we saw above, a question is a function that assigns to every index a unique proposition, which is the complete and true semantic answer at that index. In view of this characteristic, one might wonder whether the core theory is able to deal with interrogatives which allow for more than one such answer.

As the term 'core theory' indicates, it is our opinion that this theory can be extended in a natural and elegant way to cope with these interrogatives, without giving up any of its basic features. More in particular, the notion of a question will be seen to be the central important notion for the analysis of such interrogatives as well.

In section 2, we will discuss, rather extensively but informally, the various phenomena to be accounted for. We distinguish three kinds of readings, pair-list readings, choice readings, and mention-some interpretations. It is argued that the first two are two sides of one coin, and hence are to be accounted for uniformly. Mention-some interpretations are a different phenomenon, the status of which, semantic or pragmatic, remains a

matter of dispute. It is also argued that pair-list readings and choice readings of interrogatives are closely connected with conjunction and disjunction of interrogatives.

Section 3, therefore, starts out with discussing general rules of coordination, and of quantification and entailment. In terms of these, various propositional theories of interrogatives, among these the theory of Karttunen, the core theory, and the theory of Bennett and Belnap, are confronted with the data. The conclusion of this discussion is that neither of these theories accounts for all the facts observed in section 2, and that those of Karttunen, and of Bennett and Belnap do not allow for standard rules of coordination, entailment and quantification.

The core theory does, and it is argued in section 4 that a simple extension of it will account for the phenomena under discussion in an elegant way. The extension that is needed, which involves lifting interrogatives to a higher level of analysis, is just another instance of a general strategy employed in Montague grammar for dealing with coordination.

Section 5 is devoted to a discussion of mention-some interrogatives. The pros and cons of a semantic and of a pragmatic approach are discussed, and the semantic treatment within the extended version of the core theory is worked out in detail.

The final section is devoted to a short outline of the principles underlying a more flexible approach to Montague grammar. The extended core theory which is developed in this paper within standard Montague grammar, fits in neatly with this more flexible approach as it is currently being discussed.

2. Some phenomena

2.1. Pair-list readings of interrogatives

Among the three kinds of phenomena we will discuss in this paper, so-called 'pair-list' readings of interrogatives are perhaps the ones which are best understood.² A standard example of an interrogative which has such a reading is (1):

- (1) Which student was recommended by each professor?

Interrogative (1) is generally acknowledged to be ambiguous. It can express (at least) two different questions, which moreover are of a different kind. On one reading (1) asks for an answer such as (2), on the other for an answer such as (3):³

- (2) (a) John.
(b) John was recommended by each professor.
- (3) (a) Professor Jones, Bill; professor Williams, Mary; and professor Peters, John.
(b) Professor Jones recommended Bill, professor Williams recommended Mary, and professor Peters recommended John.

The difference between these two readings of (1) will need no further clarification. Intuitively, the source of the ambiguity is the relative scope of the wh-phrase which student and the term each professor. On the first reading, the one which calls for such answers as (2), the wh-phrase has wider scope, whereas on the second reading, on which answers of the type of (3) are elicited, it is the term each professor which

has widest scope.

It is important to observe that on its second reading, judged from the way in which it is answered, the interrogative (1) seems to behave like a two-constituent interrogative, even though it contains only one wh-phrase. Answers like (3) give a list of pairs of individuals. They specify the extension of a relation, rather than the extension of a property (as do answers such as (2)). So, it seems that the interrogative (1) on its second reading is equivalent to the explicitly two-constituent interrogative (4):

(4) Which professor recommended which student?

This ambiguity of interrogatives such as (1) is also exhibited by sentences in which the corresponding wh-complements occur embedded under verbs such as know or wonder. Consider (5) and (6):

(5) John knows which student was recommended by each professor

(6) John wonders which student was recommended by each professor

In fact, whereas the interrogative (1) is two ways ambiguous, sentences (5) and (6) have three distinct readings.

The first reading of (5) is the one on which John knows an answer like (2) to the question expressed by the corresponding, first reading of (1). In other words, on this reading, (5) says that John knows which student is such that he or she was recommended by each and every professor. I.e. John knows what the extension of the property of having been recommended by every professor is.

Similarly, (6) on its first reading means that John wants to know an answer like (2) to the question expressed by (1) on its first reading, implying that John doesn't know that answer yet. I.e. (6) on its first reading implies the negation of (5) on its first reading.

The second reading of (5) is the one on which it expresses that John knows an answer like (3) to (1) on its second, i.e. its pair-list reading. Or, equivalently, that John knows the answer to the two-constituent interrogative (4). And (6) on its second reading means that John wants to know an answer to the question expressed by (1) on its second, its pair-list reading. Again, (6) on its second reading implies the negation of (5) on its second reading.

Besides these two readings, which stem from the ambiguity of (1), (5) and (6) have a third reading.⁴ Let us start with (6) this time. On its third reading it says that for each professor it holds that John wants to know which student was recommended by him or her. On this reading, (6) implies (7), whereas on its second reading it implies (8):

- (7) For no professor, John knows which student he or she recommended.
- (8) Not for all professors, John knows which student he or she recommended.

The difference is again one of scope. In sentence (6) there are three scope bearing elements: the wh-phrase which student, the term each professor, and the intensional verb wonder. On the first two readings of (6), the wh-phrase and the term are both inside the scope of wonder. These two readings are analogous to the two readings of the corresponding interrogative (1). On the third reading, the term each professor has wide scope over both the wh-phrase and the verb wonder.

Let us now consider sentence (5). For this sentence, too, three different readings can be distinguished. However, in this case, the facts that can be observed are slightly different. On its third reading, (5) states that for every individual which in fact is a professor, John knows which student was recommended by that individual. As such, this is not sufficient to guarantee that John knows the answer to (1) on its pair-list reading, which is required for (5) to be true on its second reading. To know the answer to (1) on its pair-list reading

is the same as knowing the answer to (4). It is to know the extension of the recommend-relation restricted to professors and students respectively. So, (5) on this reading is equivalent to (9):

(9) John knows which professor recommended which student

As we have argued elsewhere, this involves a certain amount of de dicto knowledge.⁵ Of the professors involved, (9), and hence (5) on its pair-list reading, requires that John is aware of them being professors. The third reading of (5) differs from the pair-list one exactly in this respect. In this case the restriction to professors is made from outside so to speak. On this reading, the term every professor has wide scope over know, and in this case (5) is true iff John knows of every individual that actually is a professor which student that individual recommended. Unlike in the previous reading, there is no implication concerning any de dicto knowledge regarding who the professors are.

So, both (5) and (6) have three different readings, definable in terms of the relative scope of the term every professor. There is a difference however, which has to do with lexical semantic aspects of meaning of the verbs know and wonder. It can be observed that if we replace the term every professor in (5) by a rigid term, such as John and Mary, or everyone (assuming the latter to range over all of one, fixed domain), the third reading and the second one coincide. In (6), however, the difference remains, we still have two different implications, viz. (10) and (11):

(10) For no-one, John knows which student he or she recommended

(11) Not of everyone, John knows which student he or she recommended

The difference between the second and the third reading of (5) depends essentially on the fact that knowledge of who

the professors are, is a contingent matter. For rigid terms this is different. Assuming the classical semantics of propositional attitudes, their extension is known to everyone.⁶

2.2. Choice-readings of interrogatives

Let us now turn to the second kind of phenomenon we want to discuss. The core theory described in section 1 seems to face a potential problem. It seems to commit what Belnap has called 'The Unique Answer Fallacy'.⁷ The theory appears to presuppose that any interrogative has a unique complete and true semantic answer at a given index. As is convincingly argued for by Bennett and Belnap, some interrogatives have a reading on which they do allow for more than one complete and true semantic answer.⁸ A simple example of such an interrogative is (12):

(12) Whom does John or Mary love?

The interrogative (12) is ambiguous. First of all, it has a reading on which it asks for a specification of the individuals loved by either John, or Mary, or both. The question which is expressed by (12) on this reading has a unique true and complete semantic answer. At an index at which the individual that John loves is Suzy, and the individuals that Mary loves are Suzy and Bill, this unique answer is expressed by (13):

(13)(a) Suzy and Bill.

(b) Suzy and Bill (are the ones that) are loved by
John or Mary.

On its second reading (12) asks either to specify the individuals loved by John, or to specify the individuals loved by Mary. On this reading (12) allows for (at least) two different complete and true semantic answers. In the situation just

described, each of the answers (14) and (15) will count as a complete and true semantic answer to (12) on this reading:

- (14) (a) John, Suzy.
 (b) John loves Suzy.
 (15) (a) Mary, Suzy and Bill.
 (b) Mary loves Suzy and Bill.

The expressions in (14) answer the question whom John loves, those in (15) the question whom Mary loves. It seems that on this reading (12) does not correspond to a single question, but rather poses more than one question at the same time, and leaves the addressee the choice which one he wants to answer. One might say that on this reading (12) can be re-phrased as the disjunction of interrogatives (16):

- (16) Whom does John love? Or, whom does Mary love?

Such a disjunction is answered by answering (at least) one of its disjuncts. This reading of (12) we call its 'choice-reading'. On a choice-reading, an interrogative does not express a single question, but is associated with several different questions. Hence, it would be more appropriate to say of a theory that does not account for these facts that it commits 'the unique question fallacy', rather than The Unique Answer Fallacy, as Belnap does. Both terminologies express a view on the matter in which the existence of interrogatives with more than one complete and true semantic answer is taken into consideration. But, as will become more clear later on, the two views are by no means mere terminological variants.

Choice-readings of interrogatives are intimately related to pair-list readings, which were discussed in the previous section. Compare (12) with (17):

- (17) Whom do John and Mary love?

Like (12), and like (1) in section 2.1, (17) is ambiguous.

First of all, it may be taken as asking for a specification of the individuals which John and Mary both love. In the situation described above, in which John loves Suzy, and Mary loves Suzy and Bill, the unique true and complete answer to (17) on this first reading is (18):

(18) (a) Suzy.

(b) Suzy is (the one who is) loved by John and Mary.

On its second reading, (17) asks both to specify the individuals that John loves, and to specify the individuals that Mary loves. So, in our sample situation, (17) on this reading has (19) as its unique true and complete semantic answer:

(19) (a) John, Suzy; and Mary, Suzy and Bill.

(b) John loves Suzy, and Mary loves Suzy and Bill.

One might say that (17) corresponds to the conjunction of interrogatives (20):

(20) Whom does John love? And, whom does Mary love?

Such a conjunction is to be answered, of course, by answering both conjuncts.

It will be clear that on the last reading, (17) is yet another example of an interrogative on a pair-list reading. As was the case with the standard example (1), the two readings of (17) are the result of the interaction of the scopes of a *wh*-phrase, in this case whom, and a term, in this case John and Mary. And, notice also that, as was the case with (1) on its pair-list reading, (17) on this reading is characteristically answered by specifying the extension of a relation, and not that of a property. The answers in (19) give a list of pairs, and doing so they specify the extension of the love-relation restricted for its first argument to John and Mary. So, interrogatives like (17), on the reading under discussion, are like multiple constituent interrogatives, although they

contain just one wh-phrase. The same fact was observed above with respect to example (1).

Let us now return to the phenomenon of choice-readings. Although this reading of interrogatives has the distinctive feature of associating more than one question with an interrogative, it shares the two important characteristics of pair-list readings just mentioned. First of all, for a choice-reading too, it holds, at first sight, that it is the result of giving the term in the interrogative wide scope over the wh-phrase that occurs in it. So, the choice-reading of (12) results if we give the term John or Mary wide scope over whom, just as the pair-list reading of (17) is the result of giving the term John and Mary wide scope. And secondly, on its choice-reading, (12) behaves like a multiple (two-)constituent interrogative, judged from the way in which it is answered on that reading, viz. by answers such as (14) and (15). These answers too specify the extension of the love-relation, restricted in its first argument either to John or to Mary, by giving a list of pairs. And this holds for pair-list readings too, as we saw above.

The same observations can be made with regard to choice-readings of interrogatives which contain an existentially quantified term, rather than a disjunctive one. Consider (21):

(21) What did two of John's friends give him for Christmas?

Of course, (21) has the reading on which it can be answered by such answers as (22):

(22) A watch.

The answer (22) to (21) on this reading expresses that a watch was given to John by two of his friends, together, or by each one of them. This reading corresponds to the first reading of the other examples we discussed, and it is the one in which the wh-phrase has widest scope.⁹

The reading we are primarily interested in here, is the one

in which the term two of John's friends has widest scope. In that case we get the choice-reading, on which (21) asks to specify for two of John's friends what each of them gave him for Christmas. The hearer is left the choice for which two he wants to answer. So, answers like (23) are in order as answers to (21) on this reading:

- (23) (a) Bill, a watch and a ball; Peter, a book and a pen.
 (b) Bill gave him a watch and a ball, and Peter gave him a book and a pen.

And, if Fred is a friend of John's as well, answers similar to (23) but specifying the gifts of Bill and Fred, or those of Peter and Fred, count as complete answers too. Again, it seems rather clear that on its choice-reading (21) is like a two-constituent interrogative in that it asks for specifications of pairs of individuals.

From the discussion of these examples, and others can easily be found,¹⁰ it seems safe to conclude that the phenomenon of pair-list readings and that of choice-readings have one and the same source: a term having wide scope over a wh-phrase. Depending on the nature of the term then, its having wide scope results either in a pair-list reading, on which the interrogative can be taken to express just one question and consequently has a unique complete and true semantic answer, or in a choice-reading, in which case the interrogative is associated with more than one question and hence has more than one complete and true semantic answer.

Although some terms give rise to pair-list readings, and others to choice-readings, not all terms give rise to either one of these two. Consider the following examples:

- (24) Which student was recommended by no professor?
 (25) What did at most one of John's friends give him for Christmas?

These interrogatives do not allow for either a pair-list or

a choice-reading, since the terms no professor and at most one of John's friends cannot be interpreted as having wide scope over the respective wh-phrases. The intuitive reason for this is quite clear. If one were to take them to have wide scope, a reading would result on which the interrogative could be answered by saying nothing at all, i.e. by answering no question. The semantic characteristic of terms for which this holds is that they are monotone decreasing terms. Extensionally, such terms always contain the empty set as one of their elements. In fact, it seems that only monotone increasing terms can be interpreted as having wide scope over a wh-phrase in an interrogative. Within this class of terms, those which always have a unique, not necessarily empty, smallest element induce a pair-list reading which ranges over the elements of this unique element. And the terms which give rise to choice-readings are those which always have more than one, non-empty smallest element, the choice ranging over these smallest elements.

In view of the structural resemblances between pair-list readings and choice-readings, it is to be expected that the phenomena observed in the previous section with respect to embeddings of the corresponding wh-complements under various kinds of verbs, carry over. Consider sentence (26), in which the complement corresponding to (12) is embedded under the verb wonder:

(26) Bill wonders whom John or Mary loves

As was the case with (5), discussed in the previous section, (26) is three-fold ambiguous. First of all, there is the reading on which (26) claims that Bill wants to know the answer to the question which individuals are loved by John, or by Mary, or by both. The second reading expresses that Bill wants either for John to know whom he loves, or for Mary to know whom she loves, (or for both). So, on this reading (26) says that Bill wants an answer to at least one of the two questions whom John loves, and whom Mary loves.

Besides these two readings, there is a third one, which says that either for John, Bill wants to know whom he loves, or for Mary, Bill wants to know whom she loves. Assuming that to wonder implies to not know, these last two readings can be seen to differ in that the second implies (27), and the third implies (28):

- (27) Bill does not know whom John loves and Bill does not know whom Mary loves
 (28) Bill does not know whom John loves or Bill does not know whom Mary loves

Again, the differences appear to be a matter of scope. The first reading is the one in which the disjunctive term is inside the scope of the *wh*-phrase. The second one is the result of the term having wide scope over the *wh*-phrase. And the third reading occurs if the term has wide scope over the sentence as a whole.

The second and the third reading of (26) are parallel to the *de dicto* and the *de re* reading of a sentence like (29):

- (29) Bill seeks John or Mary

On its *de dicto* reading, (29) claims that Bill will stop searching both in case he has found John and in case he has found Mary. On its *de re* reading, (29) expresses doubt as to whom Bill actually seeks. It is either John, in which case finding Mary will not satisfy Bill, or it is Mary, and then finding John is of no help.¹¹ Assuming that seeking implies not yet having found, these two readings differ in that they imply (30) and (31) respectively:

- (30) Bill has not yet found John and Bill has not yet found Mary
 (31) Bill has not yet found John or Bill has not yet found Mary

The ambiguity of (29) disappears if we replace the intensional seek by the extensional find. And in fact, if we replace the intensional wonder by the extensional know in (26), the second and the third reading coincide as well, as (32) shows:

(32) Bill knows whom John or Mary loves.

But this happens only in virtue of the fact that John or Mary is a rigid term. If we replace it by the non-rigid term two girls, the two readings do not coincide. For its second, its choice-reading, John then has to know de dicto of two girls whom each of them loves. And for its wide scope reading, John needs to know this de re of two individuals which are girls.

Let us sum up our findings of this and the previous section. Pair-list readings and choice-readings exist as distinct readings. On its choice reading an interrogative is associated with more than one question, and, for that reason, has more than one complete and true semantic answer. Pair-list readings and choice-readings are related phenomena. Both are a matter of scope, and induce an n+1-constituent interpretation of what superficially is an n-constituent interrogative. Both readings are preserved under complement embedding verbs, but may coincide with wide scope readings, depending on the meaning of the verb and the term. And finally we have seen that whether a pair-list reading or a choice reading results when we assign a term wide scope with respect to a wh-phrase, depends on the semantic properties of the term.

2.3. Mention-some interpretations of interrogatives

Choice readings of interrogatives are not the only case of interpretations of interrogatives on which they have more than one semantic answer. The other case is what is often called the 'mention-some' interpretation of interrogatives.¹² Our stock example of this interpretation involves the interrogative (33):

(33) Where do they sell Italian newspapers in Amsterdam?

The mention-some interpretation of (33) is assigned to it for example when it is asked by an Italian tourist who wants to buy a paper because he is curious as to how things are going in his country. If he addresses someone on the streets of Amsterdam, and asks (33), he thereby invites the addressee to mention some place in Amsterdam where Italian newspapers are sold, preferably one that is not too far away, and not too difficult to find.

Though this is perhaps the interpretation of (33) that comes to mind first, it is by no means the only possible one. It is not too difficult to think of a context in which the intended interpretation of (33) is a mention-all interpretation. For example, one can imagine someone who is interested in setting up a distribution network for foreign newspapers in Amsterdam. First she has to explore the market. If in such a context (33) is used, the informant is invited to mention all places in Amsterdam where Italian newspapers are sold.

Other examples of interrogatives that naturally allow for a mention-some interpretation are (34) and (35):¹³

(34) Who has got a light?

(35) Where can I find a pen?

On their mention-some interpretation (33), (34) and (35) allow for several different semantic answers, whereas on their mention-all reading they have a unique complete and true semantic answer.

We deliberately avoid to speak of the mention-some reading of interrogatives, but prefer to use the more vague terminology of the mention-some interpretation. If we say of an expression that it has different readings, we mean by that that it is associated with different semantic objects (such as propositions in the case of indicative sentences, and questions in the case of interrogative sentences). If we speak without qualification of different interpretations, we mean

to leave open the possibility that what is involved is not a semantic ambiguity, but rather a purely pragmatic multi-interpretability.¹⁴

For similar reasons we avoided saying above that on its mention-some interpretation an interrogative has more than one complete and true semantic answer. It has more than one semantic answer, that is certain, but whether these all can be counted as complete and true answers, rather than merely partial ones, we want to leave as an open question for the moment. If they are to be counted as such, then the mention-some interpretation is indeed a semantic reading. But as we shall see, we believe that there are good reasons to doubt whether this is the case.

Be this as it may, the fact that both mention-some interpretations and choice-readings of interrogatives allow for more than one answer, should not lead one to believe that the two phenomena are basically the same. Even if the mention-some interpretation is a distinct semantic reading, it most certainly is not the same as the choice-reading. Various arguments show this quite clearly.¹⁵

First of all, it should be noted that (33) on its mention-some interpretation is answered in the same way as all one-constituent interrogatives are, viz. by such answers as in (36), which simply give the name of a place that has the property that Italian newspapers are sold there:

(36) (a) At the Central Railway Station.

(b) At the Central Railway Station they sell Italian newspapers.

In this respect, mention-some interpretations differ from choice-readings, which, as we saw above, are typically answered by the listing of a set of pairs, i.e. in the same way as multiple constituent interrogatives.

Secondly, though the examples (33)-(35) contain all existentially quantified terms, there are also interrogatives containing universally quantified terms and negative terms which

also have a mention-some interpretation. Examples are (37) and (38):

(37) Where do they have all books written by Nootboom in stock?

(38) On which route to Rotterdam is there likely to be no police-control?

Depending on the context, (37) may be given a mention-all interpretation, on which it asks for an exhaustive listing of all decent bookshops, or it may be given a mention-some interpretation, for example if I just want to buy all of Nootboom's books at the same time, in one bookstore. Likewise, (38) in some context may have a mention-all interpretation. Or, and this is perhaps the interpretation that comes most readily to mind, it may be assigned a mention-some interpretation, for example if I want to go home 'safely' after a delirious party. It should be noted that neither (37), nor (38) has a choice-reading, such a reading being excluded by the very semantic properties of the terms all books written by Nootboom and no police-control respectively. Giving the first term wide scope results at best, for this isn't a very likely reading of (37) at all, in a pair-list reading, but not in a choice-reading. And for no police-control, it holds that it cannot be taken to have wide scope at all.

Of course, if interrogatives can have distinct mention-some interpretations, then so can the corresponding wh-complements. In fact, this provides us with yet another argument for distinguishing mention-some interpretations from choice readings.

As we saw in the previous section, choice readings coincide with wide scope readings in case the embedding verb is know and the term is semantically rigid. This means that on its choice reading, (39) is equivalent with (40):

(39) John knows where Suzy or Mary is

(40) John knows where Suzy is or John knows where Mary is

If mention-some interpretations and choice readings were one and the same phenomenon, then (40) would have to be a correct paraphrase of the mention-some interpretation of (39) as well. But surely, this is not the case. If we take the complement in (39) on its mention-some interpretation, then the sentence means that John can indicate some place where either Suzy or Mary can be found, without this implying, however, that John knows which one of the two girls it is that can be found there. But the latter is implied by (40), which we have seen to be equivalent with (39) on its choice reading.

This and the other arguments given above, suffice to show that mention-some interpretations differ in important respects from choice-readings. Whereas the latter are the result of a term having wide scope over a wh-phrase, where the term is required to have certain specific semantic properties, the mention-some/mention-all dichotomy, whatever its nature may be, does not appear to be the result of a difference in relative scopes. Consider yet another example:

(41) John knows where a pen is

On its mention-all interpretation, (41) means that John knows of all and only the places where a pen is that there is a pen there. On its mention-some interpretation, (41) expresses that of some place where a pen is, John knows that there is a pen there. In both cases, the wh-phrase where appears to have wide scope with respect to the term a pen. It is the wh-complement as a whole, so to speak, that can get interpreted either universally or existentially.

From the paraphrases we just gave, it is also clear that (41) on its mention-all interpretation, implies (41) on its mention-some interpretation, but only under the assumption that there is at least one place (in the domain of discourse) where a pen can be found. If nowhere there is a pen to be found, and if John is aware of this deplorable fact, then (41) is true on its mention-all interpretation, but one would not call it true on its mention-some interpretation.

Connected with this fact is another one which concerns the nature of the answers that an interrogative on a mention-some interpretation allows. Consider (42):

(42) Where can I find a pen?

On its mention-some interpretation, (42) allows for different answers, but these must all be 'positive'. They all must identify a place where a pen is. Places where no pen can be found, do not count at all. All and only propositions which of a certain place where a pen is, say that there is a pen there, can count as answers. But for the mention-all interpretation places where no pen is, do count as well. The answer that nowhere a pen can be found, is a good answer to (42) on its mention-all interpretation.

For the moment that is all we want to say about mention-some interpretations of interrogatives. Going into further detail would mean going further into their actual analysis than is relevant at this stage. In particular, we will postpone the discussion as to whether they should be considered to constitute distinct semantic readings, or rather should be taken into account along pragmatic lines. At this point it suffices to have shown that mention-some interpretations are different from choice-readings, and that hence the latter can be dealt with separately.

2.4. Conclusion

From the characterization of the core theory of interrogatives given in section 1, it will be clear that it needs to be extended if it is to be able to cope with the phenomena discussed above. We will see that the extension of the theory that is needed, is a completely straightforward one, which uses general principles and strategies that are employed in other domains as well. Nothing essential in the core theory, in particular nothing essential about the semantic notion of a

question needs to be revised in any way. Essential to this notion of a question is that it has a unique complete and true semantic answer at an index. The key to the proper treatment of choice-readings and the like, is the distinction between an interrogative as a linguistic object, and a question as a semantic object. Loosely speaking, on a choice reading, an interrogative expresses more than one question, each of these having its own complete and true semantic answer. And in virtue of that, an interrogative may have more than one complete and true semantic answer.

3. Interrogatives, coordination and quantification

3.1. General rules of coordination and quantification

In discussing the phenomena of pair-list readings and choice-readings in the previous section, we noticed that they are connected to coordination of interrogatives, to conjunction and disjunction respectively. We also observed that pair-list and choice-readings result if a term in an interrogative is taken to have wide scope over a wh-phrase. A standard way to account for such scope phenomena (though certainly not the only possible way), is to assume that the term that has wide scope is quantified-in.¹⁶ In the cases under discussion, this would mean that the term is quantified into an interrogative.

In evaluating existing proposals for the analysis of these phenomena, and in formulating our own proposal, it will prove helpful to make use of insights into the nature of coordination and quantification as general processes. For that reason we start out in this section with some general remarks about the nature of these semantic processes. Thereby we base ourselves on other work in this area, especially on that of Barbara Partee and Mats Rooth.¹⁷

Coordination, more specifically conjunction and disjunction, is possible between expressions within many different categories. If two or more expressions of a category A are coordinated, the result is again an expression of category A. Though as a semantic operation, coordination applies to objects of many different types, all these have something in common. Basically, conjunction and disjunction apply to sentences, expressions denoting truth-values. If expressions can be coordinated at all, they belong to a type that is

related to the type of truth-values in a particular way. Such expressions denote objects of a 'conjoinable' type:¹⁸

- (CT) t is a conjoinable type;
 $\langle a, b \rangle$ is a conjoinable type iff b is a conjoinable type

All conjoinable types 'end' in t , so to speak. If we keep applying an expression of a functional conjoinable type to argument expressions of the appropriate types, we will eventually end up with an expression of type t .

The semantic result of the conjunction of two expressions of the same conjoinable type can be defined generally in terms of the application of one semantic operation \sqcap to the objects they denote:

- (CONJ) Let x and y be objects of a conjoinable type a . Then $x \sqcap y$ is recursively defined as follows:
 (i) if $a = t$, then $x \sqcap y = 1$ iff $x = y = 1$;
 and $x \sqcap y = 0$ otherwise
 (ii) if $a = \langle b, c \rangle$, then $x \sqcap y = \lambda z [x(z) \sqcap y(z)]$

Similarly, the semantic operation \sqcup associated with disjunction is defined as follows:

- (DISJ) Let x and y be as above. Then $x \sqcup y$ is defined as:
 (i) if $a = t$, then $x \sqcup y = 0$ iff $x = y = 0$;
 and $x \sqcup y = 1$ otherwise
 (ii) if $a = \langle b, c \rangle$, then $x \sqcup y = \lambda z [x(z) \sqcup y(z)]$

Not only conjunction and disjunction, but also (logical) entailment can be defined in this general fashion, in terms of the general relation \sqsubseteq of (logical) inclusion:

- (INCL) Let x_1, \dots, x_n, y be objects of a conjoinable type a .
 Then $x_1, \dots, x_n \sqsubset Y$ is defined as follows:
- (i) if $a = t$, then $x_1, \dots, x_n \sqsubset Y$ iff it is not the case that $x_1 \sqcap \dots \sqcap x_n = 1$ and $y = 0$
 - (ii) if $a = \langle b, c \rangle$, then $x_1, \dots, x_n \sqsubset Y$ iff

$$\forall z [x_1 \sqcap \dots \sqcap x_n](z) \sqsubset Y(z)$$

Entailment as a relation between expressions of a language can straightforwardly be defined as inclusion of their meanings, in a certain model, or in all models, respectively.¹⁹

The fact that such general definitions of the semantic interpretation of coordination and the semantic relation of entailment are possible, gives rise, in a natural way, to the following criteria of adequacy for a semantic theory.

Any syntactic operation of coordination by conjunction should be interpreted as the semantic operation \sqcap .²⁰

Any syntactic operation of coordination by disjunction should be interpreted as the semantic operation \sqcup .

Entailment relations between expressions should be accounted for by the general definition of entailment in terms of inclusion of their meanings.

Let us now turn to the general form of quantification rules. In most cases a quantification rule is intended as a means to give a term wide scope over other elements in a construction. Disregarding 'negative' terms for the moment, which as input of a quantifying-in process are problematic anyway, we can say that this giving the term wide scope is the result of distributing a property, constructed from the phrase that we quantify into, over the elements in the coordination embodied in the term.²¹

This leads us to the following description of what a proper quantification rule should look like. A quantification rule takes two arguments, a term and some other construction. A term is, extensionally speaking, a set of sets of elements in some domain, i.e. it is an expression of type $\langle \langle a, t \rangle, t \rangle$, a being the type of the domain the term quantifies over. So, terms are always of a conjoinable type. The type of the

construction that the term is quantified into, has to be such that it can be turned into an expression that denotes a property of objects of type a , i.e. an expression of type $\langle s, \langle a, t \rangle \rangle$. If quantification is to have any real effect, this property denoting expression should be constructed by abstraction over a free variable of type a . All this means that the expression that is quantified into, should be of a conjoinable type too, just as the term. The procedure is then as follows. From the expression that is quantified into, the required property denoting expression is obtained by first lowering its type to t , by applying it to suitable variables of the appropriate types, if such be necessary. By abstraction over the presumed free variable of type a , and by abstraction over the variable of type s , the property denoting expression is obtained. Functional application of the term to this expression, distributes the property over the elements of the coordinated structure which is semantically inherent in the term. Quantification should always result, in the end, in an expression that is of the same type as the original expression that is quantified into. This is obtained by abstracting over the variables introduced in lowering the type.

So, taking intensionality into account, the following general schema of quantification rules emerges:²²

- (QUANT) Let α be an expression of type $\langle \langle s, \langle a, t \rangle \rangle, t \rangle$, and β an expression of a conjoinable type b , containing a free variable x_a . Quantification of α into β for x_a has the following semantic effect: $Q(\alpha, x_a, \beta)$; where $Q(\gamma, y, \delta)$ is defined as follows:
- (i) if δ is of type t , then $Q(\gamma, y, \delta) = \gamma(\lambda a \lambda y \delta)$
 - (ii) if δ is of type $\langle a, b \rangle$, then

$$Q(\gamma, y, \delta) = \lambda x_a [Q(\gamma, y, \delta(x_a))]$$

According to QUANT, of which for example the quantification rules defined in Montague's PTQ are straightforward instances, the only operations which are allowed, are those of functional application and abstraction. No other operations on the input

of the rule, either the term or the phrase that is quantified into, are to enter into it. This restriction, which in fact excludes a number of proposed quantification rules, is motivated by the purpose of quantification. Giving one element wide scope over some other should not involve changing the meaning of either of these elements in any way. Moreover, imposing such restrictions on quantification rules, one gains predictive power. For terms ranging over any domain, and for expressions of any conjoinable type, the schema QUANT predicts what quantification precisely is. So, from QUANT another adequacy criterion for semantic theories naturally arises: rules of quantification should be instances of the general schema QUANT.

3.2. Coordination and quantification in some propositional theories

In this section we give a brief overview of how various propositional theories of interrogatives and/or wh-complements relate to the phenomena discussed in section 2. A discussion of the various pro's and con's of these approaches may shed some more light on the nature of the data, and may point the way towards their proper analysis.

Among the semantic analyses of interrogatives and wh-complements, one can distinguish two main types of approaches: propositional theories and categorial theories. Of the latter the best-known is probably Hausser's.²³ Categorial theories treat n-constituent interrogatives, interrogatives containing n wh-phrases, as expressing n-place relations. Their main advantage is that, under such an analysis, interrogatives can quite easily be linked with constituent ('short') answers. Their main disadvantage is that they end up with a great many different kinds of interrogatives. Yes/no-interrogatives, single constituent interrogatives, two-constituent interrogatives, interrogatives containing wh-phrases of different categories, each one of these belongs to its own syntactic

category, and hence, is assigned its own type of semantic object. This has some obvious drawbacks.

In section 3.1 we have seen that coordination is defined between expressions that belong to the same category. This means that, strictly speaking, a categorial approach cannot account for coordination of interrogatives in general. This deficiency can be remedied only either by introducing ad-hoc, non-standard coordination rules for interrogatives in different categories, or by applying some semantic operation to interrogatives which makes them expression of one and the same semantic type after all. The first escape route leads to a theory that does not meet the adequacy criteria, and the second one to a theory that is no longer a categorial theory.

Assuming interrogatives to be expressions of many different categories also forces one to introduce a non-standard notion of entailment between interrogatives. Obviously, the general definition of entailment cannot be used in a categorial theory, since it is defined only between expressions of the same (conjoinable) type.

Also, a categorial approach to interrogatives predicts, if we assume the equivalence thesis, which in its strong form requires that interrogatives and wh-complements be semantically equivalent, that wh-complements, and hence wh-complement embedding verbs, belong to many different syntactic categories as well.

Especially in view of the phenomena we discussed in section 2, these facts give ample reason to abandon the categorial approach. The theory of interrogatives that it leads to, does not meet general adequacy criteria, and cannot be expected to deal successfully with the phenomena that we are discussing here. An adequate theory has to be one that assigns interrogatives to one syntactic category and one semantic type. Propositional theories fulfill this requirement, and it is to a discussion of some of them that we now turn.

3.2.1. Karttunen

The best-known propositional approach is Karttunen's, which builds on the theory of Hamblin, which is the oldest propositional theory in the Montague framework.²⁴ In Hamblin's analysis, the sense of an interrogative is a set of propositions. Roughly speaking, the elements of such a set are the propositions expressed by possible semantic answers. As we have argued elsewhere, Karttunen's most fundamental improvement on Hamblin's theory is that he enriches it with the standard distinction between sense and denotation.²⁵ Karttunen considers the denotation of an interrogative to be a set of propositions, and hence, its sense to be a function from indices to propositions. Roughly speaking again, if we take the union of all such sets for all indices, we arrive at Hamblin's set of possible answers. The members of the set of propositions denoted by an interrogative at an index, jointly, i.e. in conjunction, are the proposition expressed by the complete and true semantic answer at that index. This characterizes Karttunen's theory as one which, as it stands, is restricted in its application to interrogatives which express a unique question, i.e. have a unique true and complete answer at an index.

The main advantage and disadvantage of Karttunen's propositional approach are complementary to those of Hausser's categorial approach. Karttunen's theory is badly attuned to constituent answers, but it does assign the same category to all kinds of interrogatives, and hence to all kinds of wh-complements. So, at least in principle, entailment relations between and coordinations of all kinds of interrogatives can be standardly accounted for. Also, a standard quantification rule can be formulated in this framework, since $\langle\langle s, t \rangle, t \rangle$, the type of sets of propositions, is a conjoinable type.

But, of course, whether a standard rule gives empirically adequate results depends on on what kind of semantic objects a certain theory has it operate. For example, if a theory assigns the proper semantic object to interrogatives, then

the standard coordination rules must give empirically correct results. This means that using the standard rules, an investigation of the results will inform us directly as to the theory's adequacy.

Karttunen's theory is a unique question/unique answer theory, as we observed above. This in itself is a sufficient reason to expect it to fail to account properly for disjunction of interrogatives, and for choice-readings of interrogatives. On the other hand, there is no a priori reason to think that it cannot cope with conjunction of interrogatives, and pair-list readings. A conjunction of two interrogatives which each have a unique answer, can be answered uniquely too, viz. by the conjunction of the answers to the conjuncts. And a similar story can be told for pair-list readings. However, it is easy to see that, despite this, Karttunen's theory also fails to give a proper account of, for a start, conjunction of interrogatives.

On Karttunen's analysis an interrogative denotes a semantic object of type $\langle\langle s, t \rangle, t \rangle$, a set of propositions. The general conjunction schema CONJ, defined in section 3.1, predicts that the semantic part of the rule which forms conjunctions in Karttunen's framework would have to be of the following form:

- (1) Let ϕ' and ψ' be the translations of two interrogatives ϕ and ψ . Then the conjunction of ϕ and ψ translates as $\lambda p[\phi'(p) \wedge \psi'(p)]$

Interrogatives denoting sets of propositions, conjunction comes down to intersection of these sets. However, since in Karttunen's approach the propositions in the set denoted by an interrogative jointly form the true and complete answer to that interrogative, this is evidently not the right result. Consider what happens if we conjoin (2) and (3), as in (4):

- (2) Whom does John love?
 (3) Whom does Mary love?
 (4) Whom does John love? And, whom does Mary love?

The translations of (2) and (3) are (5) and (6):

(5) $\lambda p[p(a) \wedge \exists x[p = \lambda a[\text{love}(a)(j,x)]]]$

(6) $\lambda p[p(a) \wedge \exists x[p = \lambda a[\text{love}(a)(m,x)]]]$

Application of the conjunction rule (1) gives (7) as the translation of (4):

(7) $\lambda p[p(a) \wedge \exists x[p = \lambda a[\text{love}(a)(j,x)]]] \wedge \exists x[p = \lambda a[\text{love}(a)(m,x)]]]$

If John and Mary are different individuals, (7) denotes the empty set. Thus, on Karttunen's analysis (4) would be an interrogative which does not have an answer.

In order to obtain correct results within Karttunen's framework, one would have to introduce an ad-hoc conjunction rule for interrogatives which has the semantic effect of disjunction:

(8) Let ϕ' and ψ' be as above. The conjunction of ϕ and ψ translates as $\lambda p[\phi'(p) \vee \psi'(p)]$

But with this conjunction rule the theory no longer meets one of the general adequacy criteria which we discussed above.

If coordination of expressions in a certain category goes wrong, i.e. cannot be handled in the standard way, but calls for an ad-hoc definition, this is a sure sign that the expressions in question are not assigned their proper semantic type. And if that is the case, entailments between such expressions are bound to go wrong somewhere too.

In fact, the examples (2)-(4) already may serve to illustrate this. Intuitively (4) implies (2) (and (3)): asking (4) is also asking (2). The question expressed by (4) contains the question expressed by (2). Or to put it differently but equivalently, any answer to (4) will be an answer to (2) as well. The general, standard definition of entailment in terms of meaning inclusion predicts the following definition of entailment between interrogatives in Karttunen's framework:

- (9) Let ϕ and ψ be two interrogatives translating as ϕ' and ψ' respectively.

Then ϕ entails ψ iff $\forall i \forall p [\phi'(p) \Rightarrow \psi'(p)]$

Using the non-standard definition of conjunction (8) to give (4) its proper meaning, it is easy to see that (2) implies (4), rather than conversely, as should be the case. So, an ad-hoc rule of entailment between interrogatives is called for as well in which the inclusion-relation is reversed, so to speak.

But it should be noted that, although such a rule would be correct as far as the entailment relations between a conjunction of interrogatives and its conjuncts are concerned, it still would give improper results with regard to other entailments. A simple example is the entailment of (11) by (10):

(10) Who walks?

(11) Does John walk?

In Karttunen's framework (10) and (11) translate as (12) and (13), respectively:

(12) $\lambda p [p(a) \wedge \exists x [p = \lambda a [\text{walk}(a)(x)]]]$

(13) $\lambda p [p(a) \wedge [p = \lambda a [\text{walk}(a)(j)] \vee p = \lambda a [\neg \text{walk}(a)(j)]]]$

At an index at which John walks, (13) is a subset of (12), but at an index at which he doesn't, this is not the case. So, even using an ad-hoc definition of entailment, instead of (9), will not allow one to account for the entailment relation between (10) and (11). And the standard definition (9) does not account for it either, of course.²⁶

If coordination goes wrong, it is to be expected that the standard rule of quantification will not give the required results either, since after all quantification involves coordination (at least in the interesting cases). According to the schema QUANT a rule that quantifies terms into interrogatives has the following form, if interrogatives are

analyzed as denoting sets of propositions:

- (14) Let α' be the translation of a term α , and ϕ' the translation of an interrogative ϕ , containing a free occurrence of a variable x_n . The semantic effect of quantifying-in α into ϕ for x_n is the following:
 $\lambda p[\alpha'(\lambda a \lambda x_n[\phi'(p)])]$

This rule is employed by Karttunen in deriving multiple constituent interrogatives, but not in deriving pair-list readings or choice-readings. Karttunen's theory being a unique question/unique answer one, we can foresee that (14) will not give adequate results, viz. choice-readings, if it is applied to such terms as typically give rise to choice-readings. If (14) works at all, it works for pair-list terms, i.e. monotone increasing terms with a unique smallest element, only.

Let us see what happens if we use (14) to quantify in a simple example of such a term, (15), into the interrogative (16):

- (15) John and Mary
 (16) Whom does he₀ love?

As is to be expected, the result is the same as that of applying the standard conjunction rule to the interrogatives (2) and (3), viz. (7). And as we already argued, this result is not correct.

The remedy that suggests itself is again to define a non-standard quantification rule that treats the conjunction in the term as if it were a disjunction. The semantic effect of such a rule is described by (17) (α' and ϕ' are as in (14)):

- (17) $\lambda p \neg[\alpha'(\lambda a \lambda x_n[\neg\phi'(p)])]$

This rule has in fact been proposed by Karttunen and Peters.²⁷ Adding such a rule to one's grammar solves the problem of

quantifying in terms which result in pair-list readings, but in a totally ad-hoc and non-standard way. The resulting theory no longer meets an important adequacy criterion: And, moreover, it does not deal with the phenomenon of choice-readings at all, let alone in a satisfactory way. Pair-list readings and choice-readings are, as we have seen above, structurally related phenomena. And an ad-hoc solution to one half is no proper solution at all.

One last remark concerning Karttunen's propositional approach concerns complement embedding verbs, such as know. Karttunen assigns all wh-complements to one and the same syntactic category, but he still needs to introduce two different translations for the verb know (and others), since this verb takes both wh-complements and that-complements as arguments, and these are of different categories in Karttunen's framework. Whereas the former denote sets of propositions, the latter do not (they are not even treated as proper constituents). Of course, both in (18) and in (19), it is the same relation of knowing that is at stake:

(18) John knows whether it is raining

(19) John knows that it is raining

And therefore Karttunen needs a special meaning postulate, of an unusual kind, to account for this. Roughly speaking this meaning postulate says that to know a set of propositions (the relation of knowing exemplified in (18)) is to know all its elements (the relation of knowing exemplified in (19)):

(20) $\forall i \forall q \forall x [\text{know}(i)(x, q) = \forall p [q(p) \rightarrow \text{know}_+(i)(x, p)]]$
 (q is a variable of type $\langle \langle s, t \rangle, t \rangle$)

Not only may one doubt whether this strategy can be made to work in all cases, it is also clear that for example coordination of wh-complements and that-complements cannot be accounted for in this way.²⁸

Taken together, all these observations convincingly show

that in Karttunen's theory interrogatives are not assigned their proper type of semantic object. They are treated uniformly, and, as we argued above in discussing the categorial approach, this is necessary. But the fact that coordination, entailment and quantification involving interrogatives have to be dealt with by means of ad-hoc rules, which operate only on interrogatives and which are not in accordance with the general schemata of coordination, entailment and quantification, leads to the inevitable conclusion that interrogatives have to be regarded as belonging to a different semantic type than Karttunen would have them belong to.

3.2.2. Towards the core theory

In this section we describe a possible propositional theory which lies in between Karttunen's theory and the core theory as it was characterized in section 1.²⁹ We will refer to it as 'the intermediary theory'. The intermediary theory avoids the problems we discussed in the previous section. However, it inherits some problematic characteristics of Karttunen's original theory we did not discuss yet, and which will later be seen to be relevant for the analysis of the phenomena which we discuss in this paper.

In view of the fact that in Karttunen's analysis an interrogative denotes a set of propositions which jointly constitute the true and complete semantic answer to it, it is a natural step beyond Karttunen to actually join these propositions and to let an interrogative denote the single proposition that results. In this way it becomes more transparent that Karttunen's theory is a unique question/unique answer theory. This is the basic idea underlying the core theory, and it is a characteristic of the intermediary theory as well.

So, in the intermediary theory an interrogative denotes a proposition and expresses a propositional concept, with the special properties which make it into an equivalence relation on the set of indices. For a yes/no-interrogative

such a propositional concept has two possible values: the proposition expressed by the positive answer, and the complementary proposition expressed by the negative answer. The true one among these two propositions is the one which is denoted by a yes/no-interrogative at a certain index. The semantic part of the rule that forms a yes/no-interrogative from an indicative sentence ϕ in the intermediary theory is the same as in the core theory:

$$(21) \lambda i[\phi' = (\lambda a\phi')(i)]$$

The intermediary theory is like Karttunen's in that constituent interrogatives are formed by quantifying-in a wh-phrase into a yes/no-interrogative containing a free variable.³⁰ Multiple constituent interrogatives are formed by repeated application of this quantifying-in process. However, whereas in Karttunen's theory a wh-phrase is treated as an existentially quantified term, the intermediary theory treats it as a universally quantified term. So, the translation of who is the same as that of everyone, and that of which CN is the same as that of every CN.

The quantification rule which is used, is the one which is predicted by the general schema QUANT for quantifying in a term α into an expression ϕ of type $\langle s, t \rangle$, being the type of expressions interrogatives now translate into, where ϕ' contains a free occurrence of a variable x_n . The semantic part of the rule can be described as follows:

$$(22) \lambda i[\alpha'(\lambda a\lambda x_n[\phi'(i)])]$$

As a matter of fact, this same standard rule of quantification can also be used to quantify terms which give rise to pair-list readings into interrogatives. In this way, the two-constituent interrogative (23), and the superficially one-constituent interrogative (24) on its pair-list reading, are treated on a par, and receive the same translation (25):

- (23) Whom does which man love?
 (24) Whom does each man love?
 (25) $\lambda i \forall x [\text{man}(a)(x) \rightarrow \forall y [\text{love}(a)(x,y) = \text{love}(i)(x,y)]]$

Not only quantification, but also conjunction of interrogatives can now be dealt with in a standard way. Interrogatives being expressions of type $\langle s,t \rangle$, the predicted semantic rule of conjunction of two interrogatives ϕ and ψ is (26):

- (26) $\lambda i [\phi'(i) \wedge \psi'(i)]$

So, since the interrogatives (27) and (29) now translate as (28) and (30) respectively, their conjunction (31) translates as (32):

- (27) Whom does John love?
 (28) $\lambda i \forall x [\text{love}(a)(j,x) = \text{love}(i)(j,x)]$
 (29) Whom does Mary love?
 (30) $\lambda i \forall x [\text{love}(a)(m,x) = \text{love}(i)(m,x)]$
 (31) Whom does John love? And, whom does Mary love?
 (32) $\lambda i [\forall x [\text{love}(a)(j,x) = \text{love}(i)(j,x)] \wedge \forall x [\text{love}(a)(m,x) = \text{love}(i)(m,x)]]$

As can be expected beforehand, (32) is also the translation of (35) on its pair-list reading, which is the result of quantifying in the term John and Mary in (33), which translates as (34):

- (33) Whom does he₀ love?
 (34) $\lambda i \forall y [\text{love}(a)(x_0,y) = \text{love}(i)(x_0,y)]$
 (35) Whom do John and Mary love?

The standard definition of entailment between two interrogatives ϕ and ψ which the general schema predicts for the intermediary theory is (36):

- (36) ϕ entails ψ iff $\forall a \forall i [\phi'(i) \Rightarrow \psi'(i)]$

This definition correctly predicts that (31), and (35) on its pair-list reading, entail (27) and (29). At the same time it also correctly predicts that (37) entails (38):

(37) Who walks?

(38) Does John walk?

All this is quite satisfactory, and it strongly supports the basic view underlying the intermediary theory and the core theory that interrogatives denote propositions and express propositional concepts of a particular kind.

Further support comes from the fact that the intermediary theory gives rise to an elegant theory of wh-complements. We can simply assume all complements to be proposition-denoting expressions. Complement-embedding verbs, such as know and wonder, are translated uniformly as expressions of type $\langle\langle s, s, t \rangle\rangle, \langle e, t \rangle\rangle$, i.e. as expressions denoting relations between individuals and propositional concepts. By means of a standard meaning postulate, extensional verbs, such as know, can be reduced to relations between individuals and propositions.

For sentence (39) we then get three different translations. On its reading on which every man has narrowest scope, it translates as (40). On its pair-list reading, on which every man has wider scope than whom, but lies inside the scope of wonder, its translation is (41). And (42) is the result if the term every man is quantified into the sentence as a whole in the standard fashion, thus receiving wide scope both over whom and over wonder.

(39) John wonders whom every man loves

(40) $\text{wonder}(a)(j, \lambda a \lambda i \forall y [\forall x [\text{man}(a)(x) \rightarrow \text{love}(a)(x, y)] = \forall x [\text{man}(i)(x) \rightarrow \text{love}(i)(x, y)]]]$

(41) $\text{wonder}(a)(j, \lambda a \lambda i \forall x [\text{man}(a)(x) \rightarrow \forall y [\text{love}(a)(x, y) = \text{love}(i)(x, y)]])$

(42) $\forall x [\text{man}(a)(x) \rightarrow \text{wonder}(a)(j, \lambda a \lambda i \forall y [\text{love}(a)(x, y) = \text{love}(i)(x, y)]])$

However, given the meaning postulate for extensional verbs such as know, indicated above, and assuming that to know two propositions is to know their conjunction as well, we get only two different translations for sentence (43). The reading on which every man has narrow scope translates as (44). And both the pair-list reading and the wide scope reading translate as (45):

(43) John knows whom every man loves

(44) $\text{know}_*(a)(j, \lambda i \forall y [\forall x [\text{man}(a)(x) \rightarrow \text{love}(a)(x, y)] = \forall x [\text{man}(i)(x) \rightarrow \text{love}(i)(x, y)]]]$

(45) $\forall x [\text{man}(a)(x) \rightarrow \text{know}_*(a)(j, \lambda i \forall y [\text{love}(a)(x, y) = \text{love}(i)(x, y)]]]$

This is not fully in accordance with our findings in section 2.1. There we noticed that with the verb to know, the wide scope and the pair-list reading coincide just in case the term in question is semantically rigid. And the term every man in (43) is not. This means that the way in which pair-list readings are obtained in the intermediary theory, they are interpreted de re, and not, as is required, de dicto.

In fact, as we saw above in discussing examples (22) and (23), pair-list readings are equivalent with explicitly two-constituent interrogatives. The fact that the two come out equivalent is a virtue of the theory. But at the same time it indicates that constituent interrogatives, too, are assigned de re readings, and not de dicto ones. We will return to this feature of the intermediary theory shortly.

First, we notice that assuming to wonder to imply to not know, the three readings of (39) imply the negation of (44), the negation of (45) and (46) respectively:

(46) $\forall x [\text{man}(a)(x) \rightarrow \neg \text{know}_*(a)(j, \lambda i \forall y [\text{love}(a)(x, y) = \text{love}(i)(x, y)]]]$

In other words, (39) on its first reading implies the negation of (43) on its first reading, which can be paraphrased as (47);

(39) on its pair-list reading implies the negation of (43) on its pair-list reading, which can be paraphrased as (48); and the implication (46) of (39) on its wide scope reading can be paraphrased as (49):

- (47) John does not know who is such that every man loves
him or her
- (48) Not for all men, John knows whom they love
- (49) For no man, John knows whom he loves

These results seem to be in accordance with the observations made in section 2.1. It should be noticed, though, that in case of the pair-list reading (41) of (39) too, we still get 'de re' readings to some extent. Though the term every man does not get wide scope over the intensional verb wonder as a whole, and therefore is not interpreted fully de re, we can see from the implication in terms of not knowing, that if we decompose to wonder in to want to know, the term does get wide scope with respect to the component to know. And in this sense, the term is not interpreted fully de dicto either. But it is a full de dicto reading that appears to be required for (39) on its pair-list reading.

All this shows that the intermediary theory is theoretical-ly satisfactory in that it meets the adequacy criteria pertaining to conjunction, quantification and entailment. And further, that it is empirically partially successful in that it accounts for a number of the facts we observed to hold for pair-list readings, but not for all of them. Finally, the intermediary theory being a unique question/unique answer theory, the phenomenon of choice-readings, and relatedly that of disjunction of interrogatives, remain out of its reach.

As we mentioned in passing, pair-list readings and constituent interrogatives are derived in an analogous way: by quantifying-in a term into an interrogative. From this it is to be expected, that the problems arising with pair-list readings, arise with equal force for all constituent interrogatives (and vice versa).

The analysis of constituent interrogatives provided by the intermediary theory, has three major deficiencies, which for the larger part, it shares with Karttunen's analysis. All three are essentially due to the fact that constituent interrogatives are derived by means of a quantifying-in process.

First of all, as we already saw in discussing pair-list readings, constituent interrogatives are assigned a *de re* interpretation. A simple example illustrating this feature is (50):

(50) Which men walk?

$$\lambda i \forall x [\text{man}(a)(x) \rightarrow [\text{walk}(a)(x) = \text{walk}(i)(x)]]$$

Of each of the individuals that actually are men, the proposition denoted by (50) says whether or not that individual walks. Its *de re* nature lies in the fact that of these individuals, it does not express that they are men. The proposition that would, is a quite different one.

As a consequence, if we embed (50) under a verb like *know*, the result would be that to know which men walk, no knowledge is really required as to which individuals are men. This means that under this analysis, there is no guarantee whatsoever that if one knows which men walk, one would come up with the correct answer when asked the question which men walk.

The same point can be illustrated in another way. Under its *de re* analysis, (50) is predicted to be entailed by (51):

(51) Who walks?

$$\lambda i \forall x [\text{walk}(a)(x) = \text{walk}(i)(x)]$$

We believe this to be wrong. The interrogative in (51) as such does not entail (50), it does so only in combination with (52):

(52) Who is a man?

A complete answer to (51) will not always be a complete answer to (50) as well. If we are told of each individual whether or

not that individual walks, i.e. if we are given a complete answer to (51), this will only give us an answer to (50) as well, if the question who the men are is completely settled. It is only when we take a de dicto view on (50), that it is accounted for that it is entailed by (51) only given the additional 'premis' (52).

A second failure of the intermediary theory might be called its 'over-exhaustiveness'. It makes (50) come out equivalent with (53):³¹

(53) Which men do not walk?

$$\lambda i \forall x [\text{man}(a)(x) \rightarrow [\neg \text{walk}(a)(x) = \neg \text{walk}(i)(x)]]$$

Under certain rather strict assumptions, this may be correct, but it is not so in general. If the set of men is a fixed set, it is reasonable to take it that a complete answer to (50) gives a complete answer to (53) as well, and vice versa. But if it is a contingent matter who the men are, which it presumably is, then (50) and (53) should not come out equivalent.

What causes this over-exhaustiveness of the analysis offered by the intermediary theory, is that (50) is analyzed as asking to say of every man whether or not he walks. The proposition denoted by (50) not only says of every individual that actually is a man and walks that he walks, but also says of every man that does not walk that he does not. For a proper analysis it is required that it characterize a complete answer to (50) as a proposition stating that ... and ... are the men that walk, which would only imply a similar characterization of the men that do not walk if it is completely settled who the men are.

The third and last deficiency of the intermediary theory that we want to draw attention to, is that it is quite unclear how it is to account for the interpretation of characteristic linguistic answers, more in particular for constituent ('short') answers. If (50) is answered by (54), the answer expresses that Bill and Peter are the men that walk:

(54) Bill and Peter.

In order to be able to account for this fact, we need to combine the interpretation of the term Bill and Peter surfacing in (54) with the interpretation of the interrogative at some level of its analysis. The only plausible candidate in the intermediary theory is the interpretation of the open sentence (55), which in this theory lies at the bottom of the derivation of (50):

(55) he_0 walks

From (55) we arrive at (50) by first turning it into the open yes/no-interrogative (56), by means of the rule of which the semantic part was stated in (21) above:

(56) Does he_0 walk?

Next, by means of the standard rule of quantification, the wh-phrase which men is introduced, which receives the same interpretation as the ordinary term every man. This results in (50).

If we combine the term Bill and Peter in (54) with the open sentence (55), the semantic result will be the proposition expressing that Bill and Peter are (the) individuals that walk. But it is certainly impossible that the result would be the proposition that they are the men that walk.³² And the latter is what the constituent answer (54) means as an answer to (50). Instead of (55), expressing the property of walking, we need an expression corresponding to the property of being a man that walks, to get the proper interpretation of the answer (54). Such an expression should play a role in the analysis of the interrogative (50).

Clearly, these three deficiencies of the intermediary theory are due to a central feature it has in common with Karttunen's theory. The source of the problems is that constituent interrogatives are derived by quantifying wh-phrases into yes/no inter-

rogatives. If they are derived that way, it is inevitable that they are assigned de re readings, that they become over-exhaustive, and form no basis to interpret characteristic linguistic answers correctly. It is precisely at this central point that the core-theory improves upon the intermediary theory, thereby retaining the theoretical advantages that the intermediary theory has over Karttunen's analysis.

3.2.3. The core theory

The core theory is a kind of fusion of a categorial approach and a propositional approach. It employs a categorial view, so to speak, at the first stage in the derivation of interrogatives. It derives n-constituent interrogatives from n-place abstracts which express n-place relations. (Yes/no-interrogatives can be viewed as zero-constituent interrogatives.)

So, the basis of the core theory is a rule which forms n+1-place abstracts from n-place abstracts. The corresponding semantic operation is that of restricted λ -abstraction. A wh-phrase which CN corresponds to a restricted λ -abductor $\lambda x[\text{CN}']$.³³ The semantic part of this rule reads as follows (where δ' is the translation of some CN, and β' that of some n-place abstract):

$$(AB) \lambda x[\delta']\beta'$$

The abstract which underlies an interrogative such as (57) is (58), which can be reduced to (59):

(57) Which men walk?

(58) $\lambda x[\text{man}(a)][\text{walk}(a)(x)]$

(59) $\lambda x[\text{man}(a)(x) \wedge \text{walk}(a)(x)]$

This abstract is the obvious candidate to be combined with the interpretation of the term which surfaces in the constitu-

ent answer (60) to form the proposition that (60) expresses in the context of (57), viz. that Bill and Peter are the men that walk:

(60) Bill and Peter.

The general procedure for interpreting linguistic answers to n-constituent interrogatives is to combine the interpretation of an n-place term, denoting a set of n-place relations, with the interpretation of the n-place abstract underlying the n-constituent interrogative. The semantic part of this rule reads as follows:

(IA) $\text{exh}(\lambda\alpha')(\lambda\alpha\beta')$

Here, exh stands for the semantic operation of exhaustivization. By means of this operation, the rule takes care of the fact that, in the context of (57), (60) means that Bill and Peter are the men that walk, rather than that Bill and Peter are (some) men that walk.³⁴

The core theory is a propositional theory. As was the case in the intermediary theory, all interrogatives are interpreted as denoting propositions and as expressing propositional concepts (of a particular kind). This is achieved by a rule which turns an n-place abstract into an interrogative. The corresponding semantic operation is that of transforming an n-place relation into a proposition:

(I) $\lambda i[\beta' = (\lambda\alpha\beta')(i)]$

This semantic operation is a straightforward generalization of the operation defined in (21) in the previous section, which formed yes/no-interrogatives from sentences in the intermediary theory.

These three rules characterize the core theory. Further, conjunction of interrogatives, quantification of terms into interrogatives, and entailment can be defined in the standard

way. Since the semantic objects that interrogatives denote in the core theory are of the same semantic type as those they denoted in the intermediary theory, the relevant definitions are those stated in the previous section, viz. (22), (26) and (36). Likewise, the way in which the core theory handles sentences containing wh-complements is completely analogous to the way in which they were handled in the intermediary theory.

But the core theory not only retains the good sides of the intermediary theory, it also improves on its weak sides. The three deficiencies of the intermediary theory which we noted at the end of the previous section, are overcome in the core theory. The problem of how to deal with linguistic answers we have already discussed above. The remaining two defects are repaired, too.

In the core theory, constituent interrogatives, and hence the corresponding complements too, get interpreted *de dicto* instead of *de re*, as the example (61) illustrates:

(61) Which men walk?

$$\lambda i[\lambda x[\text{man}(a)(x) \wedge \text{walk}(a)(x)] = \lambda x[\text{man}(i)(x) \wedge \text{walk}(i)(x)]]$$

As a result, (61) is no longer entailed by (62):

(62) Who walk?

$$\lambda i[\lambda x[\text{walk}(a)(x)] = \lambda x[\text{walk}(i)(x)]]$$

In order for (62) to entail (61), the property of being a man would have to be a rigid property, i.e. the question who the men are would have to be settled. In other words, the entailment relation we do have is (63):

(63) Who walk?

Who is a man?

Which men walk?

If both first two questions are answered, then the last one is.

But an answer to the first question only, does not guarantee that the last one is answered as well.

The de dicto nature of (61) also makes sure that for (64) to be true, John not only has to know of the individuals that are men and walk, that they walk, but also that they are men.

(64) John knows which men walk

Further, over-exhaustiveness is avoided as well. The proposition denoted by (61) is true precisely at those indices where the positive extension of the property of being a man that walks is the same as at the actual index. It need not be the case that at such indices, the negative extension is also the same as at the actual index. As a consequence, (61) is not necessarily equivalent with (65):

(65) Which men do not walk?

$$\lambda i[\lambda x[\text{man}(a)(x) \wedge \neg \text{walk}(a)(x)] = \lambda x[\text{man}(i)(x) \wedge \neg \text{walk}(i)(x)]]$$

This also means that (64) does not necessarily imply (66), nor vice versa:

(66) John knows which men do not walk

The who-interrogative (62) is necessarily equivalent with its 'negative counterpart', but only under the assumption that our model has one fixed domain. In a model with varying domains, the two are no longer equivalent.

As for pair-list readings, we could use the rule quantifying terms into interrogatives to derive them. But, of course, such an analysis would run into the same problems that the intermediary theory had to face. In particular, we would end up with de re interpretations for pair-list readings only, and we would not get the required de dicto interpretation.

Even apart from that, there is another important feature of pair-list readings that would not be accounted for in that way. As we observed in section 2.1, an interrogative like (67)

behaves like a two-constituent interrogative on its pair-list reading, judged from the way in which it is characteristically answered, viz. by answers such as (68):

(67) Whom do John and Mary love?

(68) John, Suzy; and Mary, Suzy and Bill.

If it did use the quantification rule to arrive at pair-list readings, the core theory could not account for this phenomenon (a fate it would share with Karttunen's and the intermediary theory). If (67) is to be characterized as a two-constituent interrogative, it has to be derived from a two-place abstract. Only given such an underlying structure, it is clear how to obtain the proposition expressed by a characteristic answer to an interrogative on a pair-list reading.

If we use a quantification rule, the abstract underlying (67), for example, is the one-place abstract (69):

(69) whom he_0 loves

This abstract is then turned into the open interrogative (70):

(70) Whom does he_0 love?

By quantifying the term John and Mary into (70), the result would be (67). However, the two-place abstract needed to account for answers such as (68), is nowhere to be found in this kind of derivation of (67).

For constituent interrogatives, the core theory avoids the problems the intermediary theory meets (which in its turn was seen to avoid important theoretical inadequacies of Karttunen's analysis). It does so precisely by giving up the idea that they are to be derived by means of a quantificational process. Since pair-list readings have so much in common with multiple constituent interrogatives, it makes no sense to keep dealing with them in the way that the intermediary theory does. What all facts observed point at, is that a proper analysis of pair-

list readings requires that they are obtained in a way that is essentially similar to the one in which constituent interrogatives are derived in the core theory. And, indeed, our final proposal for the analysis of pair-list readings, presented in section 4.3.1, follows this lead.

But first, we will turn to another issue. The core theory is as much a unique question/unique answer theory as that of Karttunen and the intermediary theory are. This means that, although pair-list readings can in principle be dealt with, the related phenomenon of choice-readings lies outside its scope. The core theory is in need of revision, or rather it needs to be extended, to cope with them. This is the main topic of section 4. But before we turn to that, one more propositional theory is discussed, one that is explicitly designed to deal with choice-readings: that of Bennett and Belnap.

3.2.4. Bennett and Belnap

Karttunen's theory, the intermediary theory, and the core theory are all restricted in their application to interrogatives that express a single question, and that consequently have a unique complete and true semantic answer at an index. For that reason, these theories can in principle deal with conjunction of interrogatives and with pair-list readings, but not with disjunctions and choice-readings.

One of the basic characteristics of the theory of Bennett and Belnap, the one we are interested in primarily here, is that it purports to allow for interrogatives which have more than one complete and true semantic answer at an index.³⁵ Bennett and Belnap's analysis can be regarded as a response to Karttunen's, one which tries to improve upon it at precisely this point. So, like the intermediary theory and the core theory, it can be looked upon as a revision of Karttunen's theory, but one that is motivated differently, and hence goes in a different direction.

The type of semantic object that is denoted by an interrogative in the theory of Bennett and Belnap is the same as in Karttunen's: an interrogative denotes a set of propositions. But there is an important difference. Whereas in Karttunen's analysis the elements of such a set jointly constitute the complete and true semantic answer, on Bennett and Belnap's approach each element as such is a complete and true semantic answer. Hence, all interrogatives that the previous theory could deal with, will denote a singleton set in this analysis. Only in case we are dealing with an interrogative which in fact allows for more than one complete and true semantic answer, will its denotation be a set of propositions with more than one element.

Without going into the details of the theory proposed by Bennett and Belnap, which is extremely complex and involves changes in the grammar as a whole at several points, it can be made clear that, whatever the details of the analysis, it is bound to fail to meet the adequacy criteria pertaining to conjunction, quantification and entailment we formulated in section 3.1.

Since the basic contents of the theory of Bennett and Belnap are primarily motivated by the existence of choice-readings, which we have seen to be intimately connected with disjunction of interrogatives, we start out by discussing disjunction. Since interrogatives are considered to be expressions of type $\langle\langle s, t \rangle, t \rangle$, the general schema of disjunction predicts the following semantic rule for the disjunction of two interrogatives ϕ and ψ translating as ϕ' and ψ' respectively:

$$(71) \lambda p[\phi'(p) \vee \psi'(p)]$$

So, disjunction comes down to taking the union of the sets of propositions denoted by the disjuncts. It will be clear that given the way in which the elements of the set of propositions are looked upon, this gives correct results for disjunctions of interrogatives. For example, (72) and (73)

will each denote a set containing a single proposition, the proposition specifying the individuals John loves and the one specifying those that Mary loves, respectively. According to (71), their disjunction (74) will contain each of these two propositions. And indeed, each of them is a complete and true semantic answer to (74):

(72) Whom does John love?

(73) Whom does Mary love?

(74) Whom does John love? Or, whom does Mary love?

Given the standard definition of entailment, it is also correctly predicted that a disjunction of interrogatives is entailed by its disjuncts.

However, although the theory of Bennett and Belnap meets the adequacy criterion of disjunction, it fails to meet that of conjunction. As in Karttunen's analysis, the predicted rule of conjunction is (75):

(75) $\lambda p[\phi'(p) \wedge \psi'(p)]$

Conjunction of interrogatives amounts to taking the intersection of the sets of propositions denoted by the conjuncts. It is easy to see that (75) predicts that the conjunction (76) denotes the empty set:

(76) Whom does John love? And, whom does Mary love?

As was the case in Karttunen's theory, we need to introduce an ad hoc rule for conjunction, in this case (77):

(77) $\lambda p \exists p' \exists p'' [\phi'(p') \wedge \psi'(p'') \wedge p = \lambda i [p'(i) \wedge p''(i)]]$

So, conjunction would amount to taking the pairwise intersection of the elements in the sets denoted by the conjuncts.

As we saw discussing Karttunen's theory, as soon as a standard rule of coordination fails to be applicable, some

problems will arise with entailments as well. The definition of entailment for the theory of Bennett and Belnap is the same as the one for that of Karttunen. It fails to account for the fact that a conjunction of interrogatives entails its conjuncts. Also, it does not account for the same basic entailment relations between unique answer interrogatives that Karttunen's theory did not account for.

Of course, one might introduce an ad hoc entailment relation, just for interrogatives, such as (78):

$$(78) \phi \text{ entails } \psi \text{ iff } \forall i \forall p[\phi'(p) \Rightarrow \exists p'[\psi'(p') \wedge \forall j[p(j) \rightarrow p'(j)]]]$$

But it seems more reasonable to interpret the failure to incorporate the standard definition of entailment for some category of expressions, as an indication that these expressions are not assigned their proper type of semantic object.

The remarks that can be made about quantification in the framework of Bennett and Belnap, follow straightforwardly from the discussion about disjunction and conjunction. The standard quantification rule for terms and interrogatives is the same as in Karttunen's framework. All can be expected to go reasonably well for terms which give rise to choice-readings. But for terms which give rise to pair-list readings the results will be empirically wrong. So, in the Bennett and Belnap framework too, a non-standard quantification rule is needed.

Because of the complexities it involves, it will not be very illuminating to give the rule actually stated by Bennett and Belnap.³⁶ Apart from not fitting into the general schema QUANT, it has other peculiar features as well. The input of the rule does not consist of a term and an interrogative, but a determiner, a noun phrase and an interrogative. This means that many terms fall outside its scope. For example, it does not apply to proper names, nor to coordinated terms in which proper names occur, such as John or some girl, nor to complex terms containing more than one determiner and noun

phrase, such as some girl and two boys, etc. Finally, it should be noticed that the complexities their rule calls for, affect the entire framework, yet seem to be needed only for this special purpose.

One last remark concerning the Bennett and Belnap approach concerns wh-complements. Verbs embedding wh-complements are treated as denoting relations between individuals and intensions of sets of propositions. Like Karttunen, Bennett and Belnap need a special and unusual meaning postulate to relate the wh-complement embedding know to its counterpart which operates on that-complements. In their framework this postulate reads as follows:

$$(79) \quad \forall x \forall i \forall q [\text{know}(i)(x, q) = \exists p [q(i)(p) \wedge \text{know}_+(i)(x, p)]]$$

(q is a variable of type <s, <<s, t>, t>>)

Having to introduce two different verbs know (and tell, and so on), only relatable through a meaning postulate such as (11), is not very attractive. Not only does this violate our intuition that in both constructions the same verb, with the same meaning, occurs, it is also doubtful whether all verbs which take both kinds of complements can be handled in the same way.³⁷ In this respect the intermediary theory and the core theory fare much better.

It seems to us that all this is reason enough to leave the theory of Bennett and Belnap. Our findings with respect to coordination, quantification and entailment show that it gives satisfactory results (to a certain extent) only for the phenomena that motivated it: disjunction of interrogatives and choice-readings. But for all interrogatives that fall within the domain of application of unique question/unique answer theories, it loses control. In all the simple cases, the standard rules fail to give correct results.

4. Pair-list readings and choice readings in an extension of the core-theory

4.1. Introduction

From the discussion in sections 2 and 3, the following picture emerges.

A natural, and intuitively appealing, view on the meaning of an interrogative is that it is something that determines for each index a unique complete and true semantic answer. This view underlies the theories of Karttunen and Hamblin, and also the core theory. In the latter it is implemented by letting an interrogative express a certain kind of propositional concept, a question, and denote a proposition. This leads to a correct and standard treatment of interrogatives which have a unique complete and true semantic answer.

Faced with interrogatives that have more than one such answer, Bennett and Belnap adopted a different view on the meaning of interrogatives. According to them it is something that determines, at each index, a set of complete and true semantic answers. As we saw above, this view cannot be correct. Although it leads to an adequate account of disjunction of interrogatives, and to a reasonably adequate one of choice-readings, it also forces a completely ad hoc, non-standard account of all interrogatives that do have a unique answer.

So it seems we must seek a solution in another direction. In our opinion we should not change our view on what the meaning of a 'simple' interrogative, one which has a unique answer, is, nor should we change the nature of the semantic object of a question. Rather, we should take a broader view on the relationship between interrogatives, as linguistic objects, in general and these semantic objects. Not all inter-

rogatives express a unique question, some express more than one. In this way the standard account of all interrogatives that do have a unique answer that the core theory provides, can be maintained.

Another conclusion that can be drawn is that, although pair-list readings and choice-readings are a scope phenomenon, they cannot be dealt with the way we usually handle scope phenomena, viz. by means of a quantification rule (or whatever may be the analogue of such rules in some grammar). Two characteristics of these readings show this quite clearly. First of all, the way in which they are answered shows that in that respect they behave like multiple constituent interrogatives. But quantifying-in leaves the category unchanged. Quantification of a term into a single constituent interrogative will result in a single constituent interrogative, and not in a multiple one. Secondly, it is clear that on pair-list and choice readings the noun phrase in the term is to be interpreted 'de dicto'. Again, no quantification process will be able to account for this. The entire term including the noun phrase in it, will be given wide scope, and hence de re readings will always be the result.

But if the process that delivers pair-list and choice readings, is not a quantificational one, what is it then? From our discussion of the theory of Karttunen and the core theory, we can get a clue. As we saw above, Karttunen derives multiple constituent interrogatives too by means of quantification. The results are de re readings. Also, no stage in the derivation is a suitable input for a theory of characteristic linguistic answers to such interrogatives. The core theory improves upon this. By deriving multiple interrogatives from abstracts by means of restricted λ -abstraction, they are assigned de dicto readings. And the abstracts form a suitable level of analysis to base a theory of answers on.

This suggests strongly that pair-list and choice readings of what superficially seem to be single constituent interrogatives, are very intimately related to multiple constituent interrogatives, and are to be derived in an analogous way.

This is, indeed, the approach that we shall work out in this section. Starting out from the core theory, we will extend it in two ways. We will introduce a level of analysis at which interrogatives can be associated with more than one question. That will give us the means to account for interrogatives which have more than one complete and true semantic answer. And we will generalize the procedure that derives multiple constituent interrogatives in such a way that it can also be used to give a correct account of pair-list and choice readings.

4.2. The lifted core theory

4.2.1. Disjunction in the core theory

As we saw in section 3.2.3, the core theory gives correct results for conjunctions of interrogatives. But if we apply the standard rule of disjunction to interrogatives, we get incorrect results.

The general schema DISJ gives the following rule for the semantic interpretation of a disjunction of two interrogatives ϕ and ψ :

$$(1) \lambda i[\phi'(i) \vee \psi'(i)]$$

According to (1), the disjunction (2) translates as (3):

(2) Whom does John love? Or, whom does Mary love?

$$(3) \lambda i[\lambda x[\text{love}(a)(j,x)] = \lambda x[\text{love}(i)(j,x)] \vee \\ \lambda x[\text{love}(a)(m,x)] = \lambda x[\text{love}(i)(m,x)] \quad]$$

If we take a closer look at (3), we see that it does not express a question at all. Consider its sense, denoted by (4):

$$(4) \lambda a \lambda i[\lambda x[\text{love}(a)(j,x)] = \lambda x[\text{love}(i)(j,x)] \vee \\ \lambda x[\text{love}(a)(m,x)] = \lambda x[\text{love}(i)(m,x)] \quad]$$

(4) denotes a propositional concept, i.e. a relation between indices, but not one that is a question, i.e. an equivalence relation on I. The relation that is denoted by (4) is reflexive and symmetric, but it is not transitive. Suppose John, but not Mary, loves the same individuals at k and l. And suppose Mary, but not John, loves at l the same individuals she loves at j. Then k and l, and l and j, but not k and j stand in the relation denoted by (4). Hence, (4) does not denote a question, and consequently (3) does not express one. But that means that it is predicted that the disjunction (2) does not express a question. No doubt an incorrect result.

The discrepancy between conjunction and disjunction of interrogatives in the core theory, should not come as a surprise. From the very nature of coordination it follows that, if two expressions which denote a proposition are coordinated, the resulting expression will again denote a single proposition. That for conjunction all goes well, might even be regarded as a kind of coincidence. For conjunctions of interrogatives too, it makes sense to say that they express more than one question. The difference with disjunctions is that to answer a conjunction, both conjuncts have to be answered, whereas to answer a disjunction means to answer (at least) one disjunct. All goes well with conjunction in the core theory because it is always possible to conjoin the answers to the conjuncts in one single proposition, which answers both conjuncts. For disjunction this makes no sense. In that case, applying the same strategy we end up with the disjunction of the answers to the disjuncts. But that proposition will, in a great many cases, not answer either one of the disjuncts.

4.2.2. Lifting interrogatives

Finding a correct analysis of coordination is a problem, not only with regard to interrogatives. We run into the same problem with other kinds of expressions. It is, in other words,

a general problem. But one for which also a general solution strategy exists. It is to lift expressions to their corresponding 'term' level, and to define coordination at this higher level. An illustrative instance of this general strategy is the way proper names are analyzed in Montague's PTQ. For many purposes it suffices to view proper names as individual denoting expressions. But to account for coordination of proper names and to assign proper names and other term phrases to a uniform category, it is necessary to lift proper names from individual denoting expressions to expressions denoting sets of properties of individuals (or individual concepts).

If we apply this general procedure to interrogatives as they are analyzed in the core theory, they are lifted from proposition denoting expressions to expressions denoting sets of properties of questions.³⁸ The resulting analysis we will call 'the lifted core theory'. The following rule tells us for any interrogative ϕ which translates as ϕ' in the core theory what its translation in the lifted core theory is:

(LIFT-Int) $\lambda Q[Q(a)(\lambda a\phi')]$

where Q is a variable of type $\langle s, \langle \langle s, t \rangle \rangle, t \rangle$

Not only conjunction, but also disjunction can now be defined adequately by means of a standard rule. The general schemata CONJ and DISJ predict the following rules for coordination of sets of properties of questions:

(CONJ-I) Let ϕ' and ψ' be the translations of lifted interrogatives ϕ and ψ respectively. Their conjunction translates as follows:

$\lambda Q[\phi'(Q) \wedge \psi'(Q)]$

(DISJ-I) Let ϕ' and ψ' be as above. The disjunction of ϕ and ψ translates as follows:

$\lambda Q[\phi'(Q) \vee \psi'(Q)]$

In order to illustrate these definitions we consider again our by now familiar examples:

- (5) Whom does John love?
- (6) Whom does Mary love?
- (7) Whom does John love? And, whom does Mary love?
- (8) Whom does John love? Or, whom does Mary love?

Given LIFT-int, we get the following translations for (5) and (6):

- (9) $\lambda Q[Q(a) \{ \lambda a \lambda i [\lambda x [\text{love}(a)(j,x)] = \lambda x [\text{love}(i)(j,x)] \}]$
- (10) $\lambda Q[Q(a) \{ \lambda a \lambda i [\lambda x [\text{love}(a)(m,x)] = \lambda x [\text{love}(i)(m,x)] \}]$

According to CONJ-I, (7) then translates as (11):

- (11) $\lambda Q[Q(a) \{ \lambda a \lambda i [\lambda x [\text{love}(a)(j,x)] = \lambda x [\text{love}(i)(j,x)] \}] \wedge$
 $Q(a) \{ \lambda a \lambda i [\lambda x [\text{love}(a)(m,x)] = \lambda x [\text{love}(i)(m,x)] \}]$

The general schema INCL predicts the following definition of entailment between interrogatives at this lifted level:

- (12) ϕ entails ψ iff $\forall a \forall Q [\phi'(Q) \Rightarrow \psi'(Q)]$

Given their translations as lifted interrogatives (9) and (10), (5) and (6) each are, as before, entailed by their conjunction (7). So, the correct results which we obtained in the core theory, carry over at this level of analysis.

For (8) we now obtain the following result given DISJ-I:

- (13) $\lambda Q[Q(a) \{ \lambda a \lambda i [\lambda x [\text{love}(a)(j,x)] = \lambda x [\text{love}(i)(j,x)] \}] \vee$
 $Q(a) \{ \lambda a \lambda i [\lambda x [\text{love}(a)(m,x)] = \lambda x [\text{love}(i)(m,x)] \}]$

If we compare this with the result of lifting the low-level disjunction (given in (3) in the previous) section, we see in this case we do get something different:

$$(14) \lambda Q[Q(a) (\lambda \lambda i [\lambda x [\text{love}(a)(j,x)] = \lambda x [\text{love}(i)(j,x)] \vee \\ \lambda x [\text{love}(a)(m,x)] = \lambda x [\text{love}(i)(m,x)]]]]$$

Whereas each element of (13) is a property of a question, this does not hold for (14), since, as we saw above, low-level disjunction does not result in a question.

That in (13) we have found an adequate translation of the disjunction of interrogatives (8), is illustrated by the fact that, given the standard definition of entailment, (13) is entailed by each of (9) and (10), which accounts for the fact that intuitively (8) is entailed by each of (5) and (6).

From these observations we think one can draw the conclusion that lifting interrogatives to expressions which denote sets of properties of questions provides us with the proper level of analysis to define coordination in a uniform and standard way.

Let us conclude this section with a few additional remarks. First of all, lifting interrogatives in fact isn't anything new. In G&S 1982, where we were concerned with *wh*-complements, we argued that they should be analyzed on that level, too. And the reasons we had for that also involved coordination. Of course, lifting interrogatives means lifting verbs that embed them as well. In the lifted core theory such verbs will be analyzed as denoting relations between individuals and intensions of sets of properties of questions. The required 'lowering' effects can be obtained by means of meaning postulates of the usual kind. Combining it with an obvious notation convention, the postulate for such verbs as know, which express relations between individuals and propositions, reads as follows:

$$(15) \forall i \forall x \forall Q [\text{know}(i)(x, Q) = Q(i) (\lambda \lambda q [\text{know}_*(a)(x, q(a))]]]$$

For those Q which denote sets of properties of unique questions, wonder, without meaning postulate, reduces as follows:

$$(16) \forall i \forall x \forall Q [\text{wonder}(i)(x, Q) = Q(i) (\lambda \lambda q [\text{wonder}_+(a)(x, q)])]$$

Here, Q is a variable of type $\langle s, \langle \langle s, \langle \langle s, \langle s, t \rangle \rangle, t \rangle \rangle, t \rangle \rangle$, and q is a variable of type $\langle s, \langle s, t \rangle \rangle$. The lifted analogues of all the interrogatives the core theory deals with, characterize one and the same question at every index. Hence, all sentences in which they occur, can be reduced, using (15) and (16), to their simpler equivalents.

Lifting thus allows us to retain the results the core theory gave us, while at the same time allowing us to deal with interrogatives expressing more than one question. Disjunctions of interrogatives are an example, as we have seen. Choice readings are another. At this stage it can already be observed that lifting interrogatives will enable us to deal with that aspect of choice-readings. A standard quantification rule, though defective in other respects, would allow us to treat an interrogative on such a reading as being associated with different questions. The relevant rule would be the following:

$$(\text{QUANT-I}) \lambda Q[\alpha'(\lambda a \lambda x_n [\phi'(Q)])]$$

It is easily checked that if we quantify in John or Mary into (17) to obtain (18), its translation will be (13), i.e. the same as that of the disjunction (8):

(17) Whom does he₀ love?

(18) Whom does John or Mary love?

Hence, on its choice reading (18) is indeed associated with two different questions, those expressed by (5) and (6). The quantification rule also accounts for the scope properties of both choice and pair-list readings of interrogatives and complements. Using QUANT-I to derive pair-list readings we get, as was the case with conjunction, and for the same reason, results that are similar to those we got in the core theory (and in the intermediary theory). Lifting ensures that we get analogous results with choice readings.

But, as we have shown in previous sections, there is good

reason to believe that these readings are not cases of quantifying-in at all, but of another derivation process, that which derives multiple constituent interrogatives. Before turning to the details of that analysis, however, we will discuss, very briefly, two other issues concerning the relation between the core theory and its lifted version. One has to do with entailment and answerhood, the other with the analysis of linguistic answers.

4.2.3. Answerhood and entailment

By lifting interrogatives to expressions denoting sets of properties of questions, we gain a correct account of coordination, but we lose the intimate and immediate relation that exists between interrogatives as proposition denoting expressions and answerhood. In the core theory, the proposition denoted by an interrogative is the proposition that is its complete and true semantic answer. When lifted, an interrogative no longer denotes a proposition. So where has answerhood gone?

It is still there, of course. The property of being completely and truly answered by a proposition is certainly one of the properties in the set a lifted interrogative denotes. To see that it does, let us first define the notion of a proposition p giving a complete and true semantic answer to a question q at an index a :

$$(ANS) \text{ ans}(a)(p,q) \text{ iff } \forall i [p(i) \rightarrow q(a)(i)]$$

In other words, p gives a complete and true semantic answer to q at a iff it entails the proposition that is the extension of q at a .³⁹

Answerhood as a relation between propositions and questions can be lifted, in a standard way, to a relation between propositions and intensions of sets of properties of questions:

(LIFT-ANS) $\underline{\text{ANS}}(a)(p, Q)$ iff $Q(a)(\lambda a \lambda q[\text{ans}(a)(p, q)])$

Now let q be the question an interrogative expresses in the core theory, and let Q be the intension of the set of properties it expresses if we lift it using LIFT-Int. Then the following holds:

(19) $\underline{\text{ans}}(i)(p, q)$ iff $\underline{\text{ANS}}(i)(p, Q)$, for all i and p

So, for any interrogative it holds that if it is answered at some index by some proposition, then the property of being answered at that index by that proposition is among the properties its lifted counterpart denotes at that index. This means that going from the core theory to its lifted version, we lose none of whatever results concerning answerhood we had.

It is also interesting to look at what happens with answerhood for those interrogatives which fall outside the domain of the core theory. For the disjunction of interrogatives (8), given its translation (13) (see section 4.2.2), application of LIFT-ANS gives the following result:

(8) Whom does John love? Or, whom does Mary love?

(13) $\lambda Q[Q(a)(\lambda a \lambda i[\lambda x[\text{love}(a)(j, x)] = \lambda x[\text{love}(i)(j, x)]]]) \vee$
 $Q(a)(\lambda a \lambda i[\lambda x[\text{love}(a)(m, x)] = \lambda x[\text{love}(i)(m, x)]]])$]

(20) $\underline{\text{ANS}}(a)(p, \lambda a[(13)])$ iff

$\underline{\text{ans}}(a)(p, \lambda a \lambda i[\lambda x[\text{love}(a)(j, x)] = \lambda x[\text{love}(i)(j, x)]]])$ or
 $\underline{\text{ans}}(a)(p, \lambda a \lambda i[\lambda x[\text{love}(a)(m, x)] = \lambda x[\text{love}(i)(m, x)]]])$

According to (20), p gives a complete and true answer to (8) iff it gives such an answer to the question whom John loves, or gives such an answer to the question whom Mary loves (or does both). And this is precisely the correct result.

So, as far as answerhood is concerned, the lifted core theory is at least as satisfactory as the core theory was. Let us now look at entailment.

First of all, it can be noticed that whereas there is a close

connection between answerhood and entailment in the core theory, this tie is loosened in the lifted version. In the core theory, the standard entailment relation gives rise to the following fact:

(21) ϕ entails ψ iff $\forall i \forall p [\text{ans}(i)(p, \lambda a \phi') \Rightarrow \text{ans}(i)(p, \lambda a \psi')]$

One interrogative entails another iff every answer to the first is also an answer to the second.

In the lifted core theory, however, we have only the weaker (22):

(22) If ϕ entails ψ , then $\forall i \forall p [\text{ANS}(i)(p, \lambda a \phi') \Rightarrow \text{ANS}(i)(p, \lambda a \psi')]$

That the reverse does not hold, is quite obvious. When lifted, one interrogative entails another iff the set of properties denoted by the first is always a subset of the set of properties denoted by the second. Clearly, this need not hold for two interrogatives even when it holds that some properties in the first, such as being answered at a certain index by a certain proposition, are always also properties in the second.

That the reverse of (22) does not hold, indicates, in view of (21), that not all entailment relations that the core theory accounts for, are accounted for in the lifted theory as well. An example of an entailment that we 'lose' is that of (24) by (23):

(23) Who walks?

(24) Does John walk?

The conclusion that should be drawn from this is that we should not simply throwaway the core theory, and replace it by the lifted theory. Rather, we should supplement the one by the other. In that case, all entailment relations can be

accounted for, at their appropriate levels. This calls for another way of organizing grammars, so as to allow analyses which take place at different levels. The general principles of such a grammar, which lead to analyses which are both effective and parsimonious, will be discussed in section 6.

4.2.4. Linguistic answers

One of the attractive features of the core theory is that it contains an analysis of characteristic linguistic answers to interrogatives. Such answers are derived by combining the interpretation of an n-place term with the interpretation of the n-place abstract underlying the interrogative they answer.

The major improvement of the lifted theory is that it can handle interrogatives which express more than one question. Beforehand it will be clear that if the analysis of linguistic answers is to carry over, such interrogatives not only need to be associated with more than one question, but also with more than one answer.

The way to go about doing that, is just another instance of our standard lifting routine. We lift abstracts, expressing n-place relations, to expressions denoting sets of properties of such. The following lifting rule tells us for any n-place abstract β which translates as β' in the core theory, what its translation is in the lifted core theory:

$$(\text{LIFT-Abstr}) \lambda R^n [R^n(a)(\lambda a \beta')]$$

Coordination of lifted abstracts can be defined in the standard way. In fact, if we do so, we don't need to state such rules for lifted interrogatives anymore. They become superfluous, once we lift the rule which turns an n-place abstract into an interrogative as follows: Let β' be the translation of a lifted n-place abstract. Then the translation of the corresponding lifted interrogative is the following:

(LIFT-I) $\lambda Q[\beta'(\lambda a \lambda R^n[Q(a)(\lambda a \lambda i[R^n(a) = R^n(i)])])]$

Take two abstracts. If we turn them into interrogatives, lift these, and then conjoin them, we get the same result as when we first lift the two abstracts, then conjoin them, and after that turn the result into a lifted interrogative.

In a similar way, the analysis of linguistic answers that the core theory offers with the (IA)-rule, can be preserved at the lifted level. The only difference is that functional application is reversed. At the low level an exhaustified n-place term is applied to the intension of an n-place abstract. At the lifted level we apply the lifted abstract to the intension of the exhaustified term:⁴⁰

(LIFT-IA) $\beta'(\lambda a[\text{exh}(\lambda a a')])$

Consider the following simple example. The translation of the abstract (25) in the lifted theory is (26):

(25) whom John loves

(26) $\lambda R^1[R^1(a)(\lambda a \lambda x[\text{love}(a)(j,x)])]$

If we apply LIFT-IA to (26) and the translation of the normal, i.e. one-place, term Suzy, the result is (27):

(27) $\forall x[\text{love}(a)(j,x) \leftrightarrow x = s]$

And that is indeed the meaning assigned in the core theory to the constituent answer (29) in the context of the interrogative (28):

(28) Whom does John love?

(29) Suzy.

These considerations show that the core theory and its lifted version are suitably related: the latter is a 'conservative extension' of the former.

4.3. Pair-list readings and choice readings

In this section we turn to the second task we set ourselves, the generalization of the rule which derives multiple constituent interrogatives. Various arguments show that there are strong resemblances between such interrogatives and pair-list and choice readings. This suggests that they are the outcome of one general derivational process.

In the case of choice-readings, it will be necessary to combine this extension of the core theory with the one we outlined in the previous section. Since on a choice-reading an interrogative is associated with more than one question, its derivation on that reading has to be stated on the level of the lifted core theory. For pair-list readings, however, this is not necessary. On such a reading an interrogative can be taken to express just one single question.

In view of this it is possible, and convenient, to define the generalization we are after first on the low level of the core theory, thus obtaining an account of pair-list readings, and after that, to 'lift' it to deal with choice-readings as well.

4.3.1. Pair-list readings

Let us first briefly recall the essentials of how multiple constituent interrogatives are derived in the core theory. Consider the two-constituent interrogative (30):

(30) Whom does which man love?

It is derived from the two-place abstract (31), which translates as (32):

(31) whom which man loves

(32) $\lambda x \lambda y [\text{man}(a)(x) \wedge \text{love}(a)(x,y)]$

In its turn, (31) is the result of a rule which operates on a CN and a one-place abstract, in this case on the CN man and (33), which translates as (34):

(33) whom he₀ loves

(34) $\lambda y[\text{love}(a)(x_0, y)]$

The semantic operation that this rule involves is that of restricted λ -abstraction. An $n+1$ -abstract is formed from an n -place one and a predicate by abstraction over a free variable in the abstract, restricting the abstraction to those objects which satisfy the predicate. In this case, we get (35) from (34) and the translation of man:

(35) $\lambda x_0[\text{man}(a)][\text{love}(a)(x_0, y)]$

And (35) is equivalent to (32).

The two-place abstract underlying (30) can be used in the derivation of characteristic linguistic answers. Also, if we turn it into an interrogative we get de dicto readings, as the translation of (30) illustrates:

(36) $\lambda i[\lambda x \lambda y[\text{man}(a)(x) \wedge \text{love}(a)(x, y)] =$
 $\lambda x \lambda y[\text{man}(i)(x) \wedge \text{love}(i)(x, y)]]$

A complete answer to (30) would specify the extension of the relation of loving, restricted in its first argument to individuals who are men.

Let us now turn to pair-list readings. Consider (37):

(37) Whom do John and Mary love?

On its pair-list reading, (37) too, is answered by specifying the extension of the love-relation, in this case its first argument being restricted to John and Mary. This means that (38) would be a suitable abstract to derive (37) from:

(38) $\lambda x \lambda y [[x = j \vee x = m] \wedge \text{love}(a)(x, y)]$

If we turn (38) into an interrogative we get the correct pair-list reading of (37):

(39) $\lambda i [[\lambda x \lambda y [[x = j \vee x = m] \wedge \text{love}(a)(x, y)] =$
 $\lambda x \lambda y [[x = j \vee x = m] \wedge \text{love}(i)(x, y)] \quad]$

Consider a second example, the pair-list reading of (40):

(40) Whom does every man love?

A complete answer to (40) on this reading has to specify the extension of the love-relation restricted in its first argument to the men. But that means that, at least as far as their answers are concerned, the pair-list reading of (40) and the two-constituent interrogative (30) are the same. Hence, the same abstract (32) that underlies (30) would be a suitable underlying structure for (42) as well.

From these observations we may conclude that in fact pair-list readings of interrogatives are straightforward cases of restricted λ -abstraction too. In the case of multiple constituent interrogatives, the abstraction is restricted to the extension of the property expressed by the CN in the wh-phrase. In the case of pair-list readings, it is restricted to the extension of a property that is uniquely determined by the term. For (37) it is the property of being John or Mary, for (40) it is the property of being a man. It is easy to see what in general the required property determined by the term is. Terms which give rise to pair-list readings are monotone increasing terms which have a unique, not necessarily empty smallest element, extensionally speaking. This smallest element we call the set on which such a term 'lives'.⁴¹ For John and Mary it is the set consisting of John and Mary, and for every man it is the set of men. The property we are after is the property which gives us at each index the set on which the term lives. We call it the property on which it lives.

For pair-list terms it can simply be defined as follows:

$$(LIVE) \underline{live}(\alpha) = \lambda a \lambda x \forall P [\alpha(P) \rightarrow P(a)(x)]$$

In terms of live we can now state the required generalized version of the rule which forms n+1-place abstracts from n-place ones. If α is a term, translating as α' , and β is an n-place abstract, translating as β' , then the n+1-place abstract formed from them translates as follows:

$$(AB-T) \lambda x_n [\underline{live}(\alpha')(a)] \beta'$$

Let us work out one example to illustrate this rule, the derivation of (40). If we apply AB-T to the one-place abstract (34) and the translation of every man we get (41):

$$(41) \lambda x_0 [\underline{live}(\lambda P \forall x [\text{man}(a)(x) \rightarrow P(a)(x)]) (a)] \lambda y [\text{love}(a)(x_0, y)]$$

Application of the definition LIVE and some reduction gives the following expression that denotes the set to which the abstraction is restricted:

$$(42) \{\lambda a \lambda x \forall P [\forall x [\text{man}(a)(x) \rightarrow P(a)(x)] \rightarrow P(a)(x)]\} (a)$$

This is equivalent to (43):

$$(43) \{\lambda a \lambda x [\text{man}(a)(x)]\} (a)$$

And this, reducing somewhat more, gives us (44) as the equivalent of (41):

$$(44) \lambda x_0 [\text{man}(a)] \lambda y [\text{love}(a)((x_0, y)]$$

In its turn, (44) is equivalent to (32), the abstract from which, we concluded above, (40) should be derived.

By means of the rule AB-T we can derive pair-list readings

adequately. That they are answered as multiple constituent interrogatives are, is accounted for by deriving them from two-place abstracts, from which these characteristic linguistic answers can be derived. And the de dicto aspect of their interpretation also comes out as it should.

Obviously, the old rule which derives multiple constituent interrogatives can be regarded as an instance of the general rule AB-T. All we need to do is to give a wh-phrase which CN the same translation as the term every CN.

The entire core theory, including pair-list readings, then consists basically of only three rules.

First, there is the rule AB-T which turns n-place abstracts and terms into n+1-place abstracts.

Second, we have the rule I which turns n-place abstracts into interrogatives.

And third, there is the rule IA which turns n-place abstracts and n-place terms into characteristic linguistic answers.

But there remains one phenomenon to be taken care of, that of choice-readings.

4.3.2. Choice-readings

As we noticed above, a proper treatment of choice readings will involve a combination of two extensions of the core theory. First, we need to proceed to the level of lifted abstracts and interrogatives, since a choice reading involves more than one question. And, secondly, we need the generalization of the abstract formation rule AB-T, since choice readings, like pair-list readings, closely resemble multiple constituent interrogatives. Together these two extensions are to result in a rule which turns n-place lifted abstracts and terms into n+1-place lifted abstracts. To these, the lifted I-rule and the lifted IA-rule, defined in section 4.2.4 will apply.

In order to get an idea of what we are after, consider the lifted version of the AB-T rule:

$$(LIFT-AB-T^*) \lambda R^{n+1} [\beta' (\lambda a \lambda R^n [R^{n+1} (a) (\lambda \lambda x_k [\underline{\text{live}}(\alpha')(a)] R^n(a))])]$$

Here, R^n is a variable over intensions of n -place abstracts, i.e. over n -place relations. And R^{n+1} is a variable over properties of $n+1$ -place relations. In this form, the rule will always result in an expression which denotes a set of properties of a unique $n+1$ -place relation, which is formed from the set of properties of a unique n -place relation and the property on which the term lives. Such a lifted abstract results in a lifted interrogative which characterizes a unique question.

So, in order to deal with choice readings, the rule needs to be generalized so as to result in lifted abstracts which denote sets of properties of more than one relation. For these can be turned into lifted interrogatives which characterize more than one question. Starting from a lifted abstract which denotes the set of properties of a single n -place relation, the rule should turn it into one which denotes a set of properties of several $n+1$ -place relations by combining the single n -place relation with several properties determined by the term.

What we need, then, is a procedure, which we will call choice which operates on a term and extracts from the set of properties it denotes the property or properties that are relevant. Given such a procedure, the general rule can then be stated as follows:

$$(LIFT-AB-T) \lambda R^{n+1} [\beta' (\lambda a \lambda R^n \exists P [\underline{\text{choice}}(\alpha')(P) \wedge R^{n+1} (a) (\lambda \lambda x_k [P(a)] R^n(a))])]$$

What remains to be done is to define the operation choice. It turns sets of properties into sets of properties. For pair-list terms, we already know what the result should be: the singleton set containing the property on which such a term lives. In order to find out which properties are relevant in case we are dealing with terms which give rise to choice readings, let us consider again our stock example (45):

(45) Whom does John or Mary love?

On its choice reading, (45) has to be obtained from a lifted two-place abstract. In its turn, this abstract has to be constructed from the term John or Mary and the lifted one-place abstract (46), which translates as (47), and characterizes the single property which is expressed by (48):

(46) whom he_0 loves

(47) $\lambda R^1 \{ R^1(a) (\lambda a \lambda y [\text{love}(a)(x_0, y)]) \}$

(48) $\lambda y [\text{love}(a)(x_0, y)]$

The interrogative (45) is associated with two different questions. E.g. in a situation in which John loves Suzy, and Mary loves Suzy and Bill, there are two different complete and true semantic answers to (45). These are expressed by (49) and (50):

(49) John, Suzy.

(50) Mary, Suzy and Bill.

And we will take it that the conjunction (51) of (49) and (50), which answers both questions associated with (45), counts as a complete answer as well:

(51) John, Suzy; and Mary, Suzy and Bill.

In the context of (45), (49) answers the question whom John loves, (50) answers the question whom Mary loves, and (51) answers both.

In order to account for this, the two-place abstract from which (45) is to be derived, should translate into an expression which is equivalent with (52):

(52) $\lambda R^2 \{ R^2(a) (\lambda a \lambda x \lambda y [x = j \wedge \text{love}(a)(x, y)]) \vee$
 $R^2(a) (\lambda a \lambda x \lambda y [x = m \wedge \text{love}(a)(x, y)]) \}$

The two relations which (52) characterizes, can be written as the restricted λ -abstracts (53) and (54):

(53) $\lambda x_0 [\lambda x [x = j]] \lambda y [\text{love}(a)(x_0, y)]$

(54) $\lambda x_0 [\lambda x [x = m]] \lambda y [\text{love}(a)(x_0, y)]$

Each of (53) and (54) can be obtained from the single property (48) characterized by the one place abstract (46) and two other properties, using restricted λ -abstraction. In (53), λ -abstraction is restricted to the property of being John, and in (54) it is restricted to the property of being Mary. These two properties are among the properties denoted by the term John or Mary. And if choice is defined in such a way that for this term it results in the set consisting of these two properties, the rule LIFT-AB-T, applied to (46) and John or Mary will result in the required (52).

Let us consider one other example, the choice reading of (55):

(55) Whom do two girls love?

On its choice reading, (55) allows for many different complete and true semantic answers. One may choose any two girls and specify for each one of them whom the individuals are that she loves. An example of a characteristic linguistic answer is (56):

(56) Mary, Bill and Suzy; and Hilary, Peter.

In the context of (55), (56) expresses the proposition that Mary is a girl and that the ones she loves are Bill and Suzy, and that Hilary is a girl, and that the one she loves is Peter. So, one of the relations that should be characterized by the lifted two-place abstract from which (55) is to be derived, is (57):

(57) $\lambda x \lambda y [\text{girl}(a)(x) \wedge [x = m \vee x = h] \wedge \text{love}(a)(x, y)]$

The two-place abstract underlying (55) has to be derived from the term two girls and the one-place abstract (46), which characterizes the single property (48). The two-place relation (57) can be derived from (48) and the property of being a girl and being Mary or Hilary, by means of restricted λ -abstraction. The restricted λ -abstract is (58), which is equivalent to (57):

$$(58) \lambda x_0 [\lambda x [\text{girl}(a)(x) \wedge [x = m \vee x = h]]] \lambda y [\text{love}(a)(x_0, y)]$$

So, if Mary and Hilary are girls, the property of being a girl and being Mary or Hilary, should be among the properties that the operation choice selects from those which the term two girls denotes. Generally, for any two girls a_1 and a_2 , the property of being a girl and being a_1 or a_2 , should be among the properties selected by choice.

Each property in the set that choice gives for two girls is a combination of two properties: the property of being one of two actual girls, and the property of being a girl. Both of these are essential for determining the questions expressed by the choice reading of an interrogative that is constructed from this term, and also for determining the meaning of characteristic linguistic answers to such interrogatives. The first property is essential since such an interrogative as (55) asks to specify for two individuals which actually are girls, whom each of them loves. And the second one is essential since any such specification also asserts that the individuals in question are girls. We referred to this fact earlier by saying that choice readings, like pair-list readings, are to be interpreted *de dicto*. To repeat one argument pertaining to embedded interrogatives, (59) on the intended reading means that John knows of two individuals which are girls that that are girls and whom each of them loves:

(59) John knows whom two girls love

In general, we need the following properties to determine

the choice properties of a term α . First of all, we need the properties of being an element of a minimal element of α . And secondly, we need the property on which α lives. The set of choice properties of α then consists of the conjunction of each of the former properties with the latter.

Consider our example two girls again. Its minimal elements are all sets consisting of two girls. For each such set, being an element of that set is one of the properties we need. The property on which two girls lives, is that of being a girl.⁴² The conjunction of each of the former properties with the property of being a girl gives the required choice properties of two girls.

The procedure described above also gives the required results for our other example, John or Mary. The minimal elements are the singleton sets {John} and {Mary}. The property on which the term John or Mary lives is the property of being John or Mary. The conjunctions of the latter with each of the properties determined by the former, i.e. the property of being John and the property of being Mary, gives the required choice properties. Clearly, the property on which John or Mary lives plays no role, due to the fact that names are treated as rigid designators. Another, related consequence of that analysis of names in the possible worlds framework is that for names no de dicto/de re distinction is made.

It is easy to see that for those terms which give rise to pair-list readings, at a certain index, choice gives a set containing a unique property, of which the extension at that index is the same as that of the property on which the term lives. Since in the rule LIFT-AB-T, abstraction is restricted to the extension of the property or properties that choice gives, the results that the general rule gives for pair-list terms are the same as those that the limited rule LIFT-AB-T* gives.

So, in order to give a definition of choice, we need a general definition of live. We already have the familiar operation exh, the operation of exhaustivization, which gives the minimal elements in the denotation of a term.⁴³

For both pair-list terms and choice terms it holds that they contain at least one not necessarily empty minimal element. So, for both kinds of terms, the set on which it lives is the union of the minimal elements. Hence the property on which such terms live can be defined in terms of exh as follows:

$$(LIVE) \text{ live}(\alpha) = \lambda a \lambda x \exists P [\text{exh}(\alpha)(P) \wedge P(a)(x)]$$

Then, we define the choice properties of α as the conjunctions of the properties of being an element of a minimal element with the live property:

$$(CHOICE) \text{ choice}(\alpha) = \lambda P \exists X [\text{exh}(\alpha)(\lambda a X) \wedge \\ P = \lambda a \lambda x [X(x) \wedge \text{live}(\alpha)(a)(x)]]$$

Given this definition of choice, the rule LIFT-AB-T is now completely implemented.

By way of illustration, we discuss once more our example (55). The two-place (lifted) abstract underlying (55) is derived from the one-place (lifted) abstract (46), which translates as (47), and the term two girls, which translates as (60):

$$(60) \lambda P \exists x \exists y [x \neq y \wedge \text{girl}(a)(x) \wedge \text{girl}(a)(y) \wedge P(a)(x) \wedge P(a)(y)]$$

Application of LIFT-AB-T to (47) and (60) gives (61):

$$(61) \lambda R^2 [(47) (\lambda a \lambda R^1 \exists P [\text{choice}(60)(P) \wedge \\ R^2(a) (\lambda a \lambda x_0 [P(a)] R^1(a))])]]$$

This can be reduced to (62):

$$(62) \lambda R^2 \exists P [\text{choice}(60)(P) \wedge R^2(a) (\lambda a \lambda x_0 [P(a)] \lambda y [\text{love}(a)(x_0, y)])]]$$

Suppose there are three girls, Mary, Hilary, and Jane. In that

case, the minimal elements in the set of sets denoted by (60) are those in (63):

$$(63) \text{ exh(60) = } \{ \{m, h\}, \{m, j\}, \{h, j\} \}$$

The property on which (60) lives is (64):⁴⁴

$$(64) \text{ live(60) = } \lambda a \lambda x [\text{girl}(a)(x)]$$

Hence, in the situation at hand, the choice properties of (60) are the following:

$$(65) \text{ choice(60) = } \{ \lambda a \lambda x [\text{girl}(a)(x) \wedge [x = m \vee x = h]], \\ \lambda a \lambda x [\text{girl}(a)(x) \wedge [x = m \vee x = j]], \\ \lambda a \lambda x [\text{girl}(a)(x) \wedge [x = h \vee x = j]] \}$$

So, in this situation, (62) is equivalent to (66):

$$(66) \\ \lambda R^2 [R^2(a) \{ \lambda a \lambda x \lambda y [\text{girl}(a)(x) \wedge [x = m \vee x = h] \wedge \text{love}(a)(x, y)] \} \vee \\ R^2(a) \{ \lambda a \lambda x \lambda y [\text{girl}(a)(x) \wedge [x = m \vee x = j] \wedge \text{love}(a)(x, y)] \} \vee \\ R^2(a) \{ \lambda a \lambda x \lambda y [\text{girl}(a)(x) \wedge [x = h \vee x = j] \wedge \text{love}(a)(x, y)] \} \}]$$

From the lifted two-place abstract (62), the lifted interrogative (67) is formed by means of the rule LIFT-I:

$$(67) \lambda Q [(62) (\lambda a \lambda R^2 [Q(a) (\lambda a \lambda i [R^2(a) = R^2(i)])])]]$$

This can be reduced to (68):

$$(68) \lambda Q \exists P [\text{choice}(60)(P) \wedge \\ Q(a) (\lambda a \lambda i [\lambda x_0 [P(a) [\lambda y [\text{love}(a)(x_0, y)]] = \\ \lambda x_0 [P(i) [\lambda y [\text{love}(i)(x_0, y)]]]]]]]]$$

So, in the situation indicated above, in which (62) is equivalent to (66), (68) denotes the following set of properties of questions:

(69)

$$\begin{aligned} \lambda Q[Q(a) (\lambda a \lambda i [\lambda x \lambda y [\text{girl}(a)(x) \wedge [x = m \vee x = h] \wedge \text{love}(a)(x, y) = \\ \lambda x \lambda y [\text{girl}(i)(x) \wedge [x = m \vee x = h] \wedge \text{love}(i)(x, y)]) \vee \\ Q(a) (\lambda a \lambda i [\lambda x \lambda y [\text{girl}(a)(x) \wedge [x = m \vee x = j] \wedge \text{love}(a)(x, y) = \\ \lambda x \lambda y [\text{girl}(i)(x) \wedge [x = m \vee x = j] \wedge \text{love}(i)(x, y)]) \vee \\ Q(a) (\lambda a \lambda i [\lambda x \lambda y [\text{girl}(a)(x) \wedge [x = h \vee x = j] \wedge \text{love}(a)(x, y) = \\ \lambda x \lambda y [\text{girl}(i)(x) \wedge [x = h \vee x = j] \wedge \text{love}(i)(x, y)])]] \end{aligned}$$

So, in our sample situation, the interrogative (55) is associated with three different questions. Notice that (55) is interpreted de dicto, and that it is interpreted as a two-constituent interrogative.

These features are both essential for giving a correct account of the meaning of characteristic linguistic answers, such as the constituent answer (70):

(70) Hilary, Peter; and Jane, Suzy.

In the context of (55), (70) expresses the proposition that Hilary is a girl, and the one she loves is Peter, and that Jane is a girl, and that the one she loves is Suzy. The two-place term from which (70) is derived translates as (71):⁴⁵

$$(71) \lambda R^2[R^2(a)(h, p) \wedge R^2(a)(j, s)]$$

The proposition which (70) expresses in the context of (55) is obtained by applying the rule LIFT-IA to (62) and (71):

$$(72) (63) (\lambda a [\text{exh}(\lambda a [(71)])])$$

The exhaustivization of the two-place term (71) can be written out as (73):

$$(73) \lambda R^2 \forall x \forall y [R^2(a)(x, y) \leftrightarrow [[x = h \wedge y = p] \vee [z = j \wedge y = s]]]$$

Consequently, ((72) can be reduced to (74):

$$(74) \exists P[\text{choice}(60)(P) \wedge \forall x \forall y \{ [P(a)(x) \wedge \text{love}(a)(x,y)] \leftrightarrow \\ [x = h \wedge y = p] \vee [x = j \wedge y = s] \} \}]$$

Finally, (74) can be seen to be equivalent to (75):

$$(75) \forall x \forall y \{ [\text{girl}(a)(x) \wedge [x = h \vee x = j] \wedge \text{love}(a)(x,y)] \leftrightarrow \\ [[x = h \wedge y = p] \vee [x = j \wedge y = s]] \}$$

And (75) expresses the proposition which we informally described above.

One final remark. Above, we stated that the interrogative (45) on its choice-reading, can also be answered by (51), which in fact answers both questions associated with (45):

(45) Whom does John or Mary love?

(51) John, Suzy; and Mary, Suzy and Bill.

In order to account for this, (51) has to be viewed as a conjunction of two different answers to two different questions rather than as a conjunctive answer to one question. The latter interpretation it has as an answer to (76) on its pair-list reading, which is associated with just one question:

(76) Whom do John and Mary love?

Depending on which interrogative (51) answers, the two-place term surfacing in it has to be derived in different ways from the two two-place terms surfacing in (49) and (50):

(49) John, Suzy.

(50) Mary, Suzy and Bill.

The latter translate as (77) and (78):

(77) $\lambda R^2[R^2(a)(j,s)]$

(78) $\lambda R^2[R^2(a)(m,s) \wedge R^2(m,b)]$

For (51) as an answer to (76), we can simply take the conjunction of (77) and (78), thus arriving at (79):

$$(79) \lambda R^2 [R^2(a)(j,s) \wedge R^2(a)(m,s) \wedge R^2(a)(m,b)]$$

But as an answer to (45), which is associated with two different questions, we have to make sure that each conjunct functions as a separate answer. I.e. we have to make sure that the abstract underlying (54) distributes over the conjuncts in (51). This is a familiar coordination problem, which has a familiar solution: we have to define conjunction at a lifted level. This we do as follows, we lift two-place terms to expressions denoting sets of properties of low-level two-place term denotations. For (77) and (78), we then get (80) and (81):

$$(80) \lambda R^2 [R^2(a)(\lambda a \lambda R^2 [R^2(a)(j,s)])]$$

$$(81) \lambda R^2 [R^2(a)(\lambda a \lambda R^2 [R^2(a)(m,s) \wedge R^2(a)(m,b)])]$$

If we now apply the standard operation of conjunction to (80) and (81), we arrive at (82):

$$(82) \lambda R^2 [R^2(a)(\lambda a \lambda R^2 [R^2(a)(j,s)]) \wedge R^2(a)(\lambda a \lambda R^2 [R^2(a)(m,s) \wedge R^2(a)(m,b)])]$$

Further, we need a version of the original IA-rule, which is now lifted in both its arguments, and of which the relevant semantic operation is given in (83):

$$(83) \alpha(\lambda a \lambda R^n [\beta(\lambda a [\text{exh}(\lambda a R^n)])])$$

where α is the translation of a lifted n-place term, and β of a lifted n-place abstract.

The reduced translation of the lifted two-place abstract underlying (45) was:

$$(52) \lambda R^2 [R^2(a)(\lambda a \lambda x \lambda y [x = j \wedge \text{love}(a)(x,y)]) \vee R^2(a)(\lambda a \lambda x \lambda y [x = m \wedge \text{love}(a)(x,y)])]$$

The reader can verify that if we apply (83) to (82) and (52), the abstract distributes over the two conjuncts. The proposition that results is that expressed by (84):

$$(84) \quad \forall x[\text{love}(a)(j,x) \leftrightarrow x = s] \wedge \\ \forall x[\text{love}(a)(m,x) \leftrightarrow [x = s \vee x = b]]$$

From the discussion in this section, we draw the following conclusion. Treating interrogatives at a lifted level allows us to deal with choice readings in a satisfactory way. In fact, we need only one rule, LIFT-AB-T, to derive both ordinary constituent interrogatives, pair-list readings, and choice readings. This derivation is adequate insofar as that it assigns all interrogatives a de dicto interpretation. Moreover, it accounts for the fact that pair-list readings and choice readings are like ordinary constituent interrogatives in the way in which they are characteristically answered. And, finally, a suitably lifted version of the IA-rule assigns these answers their correct interpretation.

So, it seems that in order to deal with all these phenomena, we need nothing but the central notion of a question, as it occurs in the core theory, and standard techniques for dealing with problems of coordination, which are used elsewhere in the grammar as well.

4.3.3. Pair-list readings and choice-readings of complements

We argued in section 2.1 that the sentences (85) and (86) both have three different readings:

(85) John knows whom every man loves

(86) John wonders whom every man loves

The first reading results if the term every man in the embedded interrogative has narrow scope. The second reading is obtained by embedding the interrogative on its pair-list reading. In the

latter case, (85) and (86) are equivalent with (87) and (88) respectively:

(87) John knows whom which man loves

(88) John wonders whom which man loves

We get a third reading if the term every man is quantified into the sentence as a whole, and hence has widest scope.

We saw in section 3.2.2 that in the intermediary theory, the second and third reading of (86) coincide, and we argued that that is an incorrect result. It will need little argumentation that within the present analysis, these two readings remain distinct, both for (85) and for (86), precisely because we took care of the *de dicto* nature of pair-list readings. In their reduced form, the third and second reading of (85) are represented by (89) and (90):

$$(89) \text{ know}_*(a)(j, \lambda i [\lambda x \lambda y [\text{man}(a)(x) \wedge \text{love}(a)(x, y)] = \lambda x \lambda y [\text{man}(i)(x) \wedge \text{love}(i)(x, y)]]])$$

$$(90) \forall x [\text{man}(a)(x) \rightarrow \text{know}_*(a)(j, \lambda i [\lambda y [\text{love}(a)(x, y)] = \lambda y [\text{love}(i)(x, y)]]])$$

We also saw in section 2.1 and 3.2.2 that the pair-list and wide scope reading do coincide in case we have a rigid term, like Mary and Bill or everyone, instead of the non-rigid every man. For the latter we would arrive at (91) and (92):

$$(91) \text{ know}_*(a)(j, \lambda i [\lambda x \lambda y [\text{love}(a)(x, y)] = \lambda x \lambda y [\text{love}(i)(x, y)]]])$$

$$(92) \forall x [\text{know}_*(a)(j, \lambda i [\lambda y [\text{love}(a)(x, y)] = \lambda y [\text{love}(i)(x, y)]]])$$

If we assume our domain to remain constant over different indices, (91) and (92) are indeed equivalent, given the standard semantics of know in a possible worlds framework.

Given the intuitive meaning of wonder, this does not hold for this verb. An important part of its meaning can be paraphrased as want to know. And want has a negative implication: want to

know implies know not (as want to have implies have not). This negative element prevents the exportation of coordinated elements within its scope. So, the reason that (91) and (92) are equivalent, but that we do not have an equivalence of the analogous readings of (93):

(93) John wonders whom everyone loves

lies in the specific semantic content of the verbs know and wonder. It is, in other words, a matter of lexical semantics.

For sentences such as (94) and (95), in which an interrogative is embedded that has a choice reading, similar results are obtained:

(94) John knows whom two girls love

(95) John wonders whom two girls love

Both sentences have three different readings. The first is the one in which the term has narrowest scope, the second is the one on which the *wh*-complement has its choice-reading, and finally, there is the reading in which the term is quantified into the sentence as a whole.

In this case, too, it holds that if we replace the non-rigid term two girls, by the rigid one Mary or Suzy, the last two readings of the sentence with know coincide, and both become equivalent to (96):

(96) John knows whom Suzy loves, or John knows whom Mary loves

And for the same reason that with wonder pair-list readings and wide scope readings remain distinct with a rigid term as Mary and Bill, the same holds for a rigid term as Mary or Suzy and choice readings and wide scope readings.

This illustrates that the phenomena concerning pair-list readings and choice readings of complements, discussed in section 2.1 and 2.2, are captured by the analysis developed here.

4.4. Conclusion

The analysis of pair-list readings and choice readings outlined in the previous sections enables us to account for the various phenomena which we observed in section 2. Moreover, it deals with coordination of interrogatives in a completely standard way. And it brings out the parallels that exist between conjunction and pair-list readings and disjunction and choice readings.

As we remarked at the end of section 4.3.1, the entire core theory consists of only three rules: the AB-T-rule which forms abstracts from abstracts and terms; the I-rule which turns abstracts into interrogatives; and the IA-rule which constructs characteristic linguistic answers from abstracts and terms.

For disjunction and choice readings we argued that we need to analyze interrogatives as denoting sets of properties of questions. The last two rules can be lifted to this level of analysis in a completely straightforward way, as we have seen in section 4.2.4. For the abstract formation rule to account for choice readings, we saw in section 4.3.2 that it had to be not only lifted, but also to be generalized.

So, in order to account for the interrogatives the core theory was intended to deal with, three rules suffice. And in order to incorporate disjunctions and choice readings, three rules suffice as well. Moreover, these two sets of rules are related systematically.

We saw in section 4.23 that certain facts concerning entailment relations between core theory interrogatives make it impossible to simply abandon the core theory in favour of its lifted analogue. We should retain both. This calls for a more flexible organization of the grammar, a demand that is underscored by the following observation. Consider sentence (97):

(97) John wonders whom Peter loves or whom Mary loves

This sentence has a reading on which it is equivalent with (98):

(98) John wonders whom Peter loves or John wonders whom
Mary loves

For a proper analysis of this reading of (97) the complement in question has to be derived on a yet higher level. Analogous cases can be found with other constructions, not involving interrogatives.

In section 6, we will discuss the basic principles of an approach that allows one to deal with these phenomena in a flexible way. Before turning to that topic, however, we discuss in the next section the third of the three phenomena observed in section 2, that of mention-some interpretations of interrogatives.

5. A semantic treatment of mention-some interpretations

5.1. Introduction

A third phenomenon besides pair-list and choice readings discussed in section 2, is that of mention-some interpretations. Though the latter have in common with choice readings that they allow for more than one semantic answer, we observed mention-some interpretations to differ from choice readings in important respects.

On its mention-some interpretation, the interrogative (1) elicits answers like (2):

- (1) Where is a pen?
- (2) On my desk.

On its (unlikely) choice reading, (1) would have to behave like a two-constituent interrogative. But judged from the nature of the answer (2), it simply behaves in accordance with what it looks like: a single constituent interrogative. The 'term' surfacing in (2) requires a one-place abstract to combine with to form the proposition it expresses as an answer to (1), viz. that there is a pen on my desk.

Whereas on its choice reading, the term a pen in (1) has wide scope over the wh-phrase where, there is no reason to assume this to be the case for (1) on its mention-some interpretation. The fact that (1) allows for several different completely satisfactory answers is not due to the semantic nature of the existentially quantified term a pen. As was observed in section 2.3, interrogatives which do not contain a term which gives rise to choice readings if it is given wide scope allow for mention-some interpretations equally well.

The choice we are left in answering (1) on its mention-some interpretation is not the choice of a particular pen, but rather the choice of a particular place. If it is existential quantification which underlies choice, then it is not the existential quantification in a pen which triggers the choice involved in the mention-some interpretation of (1). We rather would have to assume that in this case the wh-phrase where involves existential quantification. This is also indicated by the fact that if we take the wh-complement in (3) on its mention-some interpretation, (3) is to be paraphrased as (4) or (5), but not as (6):

- (3) John knows where a pen is
- (4) John knows a place where a pen is
- (5) John knows of a place where a pen is, that there is a pen there
- (6) John knows of a pen where that pen is

Sentence (6) is a correct paraphrase of (3) if the complement is taken on its choice reading, but not if it is taken on its mention-some interpretation.

These are ample reasons to reject the identification of mention-some interpretations and choice readings, as it has actually been proposed by Beinap.⁴⁶ However, these observations do not tell us yet how to deal with the phenomenon. In section 2.3 we indicated that we have some doubt as to whether it is a semantic or a pragmatic phenomenon. In previous papers, we invariably defended the latter option, but we never offered an explicit pragmatic treatment.

In the next section, we will indicate that a pragmatic approach, though intuitively appealing, meets certain difficulties. In section 5.3, we will present a semantic analysis which fits in naturally with the analysis of choice-readings presented above. However, remaining faithful to our earlier position, we conclude in section 5.4 that there remain some problems of which it is hard to see how a semantic approach could solve them.

5.2. Problems for a pragmatic approach

The phrase 'a pragmatic approach' in the title of this section should be interpreted specifically. The pragmatic approach we have in mind runs along the following lines.

The semantic interpretation of an interrogative is the question it expresses on its mention-all interpretation. Its denotation is the proposition expressed by a true and complete semantic answer. Mention-some and mention-all interpretations are not associated with two different semantic interpretations of interrogatives, but with two different notions of answerhood. The mention-all interpretation is linked to the notion of a proposition giving a complete answer to a question. The mention-some interpretation is connected with the notion of a proposition giving a partial answer to a question. What kind of answer is called for depends on the context in which the interrogative is used.

Unlike interrogatives, linguistic answers are ambiguous between a mention-some and a mention-all reading. On its mention-some reading, the term surfacing in a constituent answer is as such combined with the abstract underlying an interrogative. On its mention-all interpretation, the term is combined with the abstract after the term has first been exhaustified.

Whether this intuitively appealing approach is successful or not depends on whether the notion of a partial answer gives a correct characterization of the propositions which intuitively count as completely satisfactory answers to an interrogative on its mention-some interpretation.

In order to be able to decide whether or not this is the case, we need a definition of a notion of partial answerhood. Besides the notion of a proposition giving a complete, true answer to a question at a certain index, the notion of a proposition giving a partial, true answer at an index can be defined as follows:

(ANS) $\text{ans}(a)(p,q)$ iff $\forall i[p(i) \rightarrow q(a)(i)]$

(P-ANS) $\text{p-ans}(a)(p,q)$ iff $\exists i[p(i) \& q(a)(i)] \&$
 $\neg \forall a \exists i[p(i) \& q(a)(i)]$

According to P-ANS, a proposition gives a partial, true answer to a question if it is compatible with the actual true and complete answer, and not with all possible complete answers. It should exclude at least one possible answer.

The success of this approach now depends on whether the following holds:

(MS) p is a completely satisfactory and true mention-some answer to q at an index a iff $\text{p-ans}(a)(p,q)$

Unfortunately, this is not the case. Consider again the interrogative (1) and the answer (2):

- (1) Where is a pen?
 (2) On my desk.

As a mention-some answer to (1), (2) expresses the proposition that there is a pen on my desk. If this happens to be the case, then (2) expresses a completely satisfactory and true mention-some answer to the question expressed by (1). And certainly, it will then constitute a partial, true answer as well. It is compatible with (in fact, even implied by) the complete and true answer which exhaustively specifies all places in the domain of discourse where a pen can be found, since my desk is one of them. And it will exclude other possible answers, viz. those which do not have my desk among the total list of places they specify.

However, there will be many other answers that do meet the criterion of being partial, true answers as well, but which intuitively do not count as completely satisfactory mention some answers. Most prominent among them are negative answers such as (7):

(7) Not in the drawer.

If there is indeed no pen in the drawer, it can easily be seen that then (7) constitutes a partial and true answer to the question expressed by (1) as well. But such negative answers are not completely satisfactory mention-some answers. So, MS holds in one direction, but not in the other. Correct mention-some answers are partial answers, but not all partial answers are mention-some answers as well.

Of course, one might try to find an alternative definition of partial answerhood to do the job. But there are reasons to believe that it will be hard to find one. A constituent interrogative such as (1) is equivalent to the conjunction of all yes/no questions which for a particular place P ask whether there is a pen at P. Each such yes/no question is, so to speak, an ultimate part of the question expressed by (1). Any partial answer has the effect of answering at least one of these ultimate questions. The point is that both a positive and a negative answer to such an ultimate question counts as a partial answer to the question as a whole.

However, only positive specifications of one or more places where a pen is, i.e. only positive answers to one or more of these ultimate questions, count as completely satisfactory mention-some answers. This ultimately means that even a perfectly true complete answer may fail to be a satisfactory mention-some answer. This happens in case (8) is the true answer to (1):

(8) Nowhere.

The answer (8) is a possible complete answer to (1), but it is not a possible mention-some answer. If (8) is the true answer to the question expressed by (1), then it has no true mention-some answers.

What this argumentation shows, is that the outlined pragmatic approach faces a problem. Appealing though a pragmatic analysis to the phenomenon may be, for the moment we see no

way to arrive at an explicit pragmatic analysis which avoids this problem. For that reason, it seems worthwhile to see whether within our framework a semantic account of the phenomenon of mention-some interpretations of interrogatives is possible.

There is one more argument in favour of a semantic solution that we want to draw attention to. Not only interrogatives, but also the corresponding wh-complements have both a mention-some and a mention-all interpretation. This means that a sentence like (9) can both be interpreted as expressing (10), and as expressing (11), and similarly that (12) has an interpretation that can be paraphrased as (13), and one that can be paraphrased as (14):

- (9) John knows where a pen is
- (10) For all places where a pen is, John knows that there is a pen at that place
- (11) For some places where a pen is, John knows that there is a pen at that place
- (12) John wonders where a pen is
- (13) John wants for all places where a pen is, to know whether there is a pen at that place
- (14) John wants for some place where a pen is, to know whether there is a pen there

Since (10) and (11), and (13) and (14) have different truth conditions, it seems that we have to conclude that on their mention-some and mention-all interpretation, (9) and (12) have different truth conditions as well.

But then, under the assumption that semantics is to give a full account of truth conditions of sentences, and under the further assumption that the mention-some/mention-all distinction is a pragmatic one, we could not escape the conclusion that pragmatics would interfere with semantics.

This runs counter to rather basic methodological assumptions about the division of labour between semantics and pragmatics. For this reason, too, it makes sense to investigate the possibility of a semantic analysis of mention-some interpretations.

5.3. A semantic approach

What mention-some interpretations of interrogatives, or mention-some readings as we have decided for the moment, have in common with choice readings, is that in many cases they allow for a choice between several different true and complete semantic answers. Like on a choice reading, an interrogative on a mention-some reading is characteristically associated with more than one question. This means that they are to be treated as lifted interrogatives, i.e. as expressions denoting sets of properties of questions.

Interrogatives are derived from abstracts. To be able to give a correct account for their linguistic answers, interrogatives on choice readings are derived from lifted abstracts. There is no need to do so for mention-some readings. If we apply the interpretation of the term John surfacing in the answer (16), to the interpretation of the abstract (17), we arrive at the proposition expressed by (18), which is a perfect semantic answer to (15) on its mention-some reading:

(15) Who has a pen?

(16) John.

(17) $\lambda x[\exists y[\text{pen}(a)(y) \wedge \text{has}(a)(x,y)]]$

(18) $\exists y[\text{pen}(a)(y) \wedge \text{has}(a)(j,y)]$

For mention-some readings, lifting is essential only at interrogative level. For the sake of uniformity, we can of course start from a lifted abstract, but then it has to be nothing else but (19):

(19) $\lambda R^I [R^I (a) (\lambda a \lambda x [\exists y [\text{pen}(a)(y) \wedge \text{has}(a)(x,y)]])]$

In other words, one and the same (lifted) abstract underlies (1) both on its 'ordinary' mention-all and on its mention-some reading.

This means that we need a second rule of interrogative formation besides (I), which takes care of mention-some readings, and which is to transform a (lifted) abstract into a lifted interrogative. What we are to do is find the semantic operation that is involved in this rule. We have already established what the input of that operation should be. Let us now ask ourselves what its output should be like.

Since mention-some readings leave a choice as to which question to answer, they basically involve disjunction. So, the output should amount to something of the form:

$$(20) \lambda Q[Q(a)(q_1) \vee \dots \vee Q(a)(q_n)]$$

It are the questions q_1, \dots, q_n from which one may choose one to answer if a true answer is to result.

From the discussion in the previous sections, we know which questions these are. E.g. a true answer to (15) on its mention-some reading has to specify a particular person who has a pen. For each and only each individual who actually has a pen, i.e. for each individual in the set denoted by the abstract (17), the true answer to the question whether that individual has a pen counts as a true mention-some answer. So, in this case q_1, \dots, q_n are to be the questions whether x has a pen, for each individual x which in fact has a pen. The true answers to these yes/no questions cannot fail to be positive ones. For an individual x who does not have a pen, the question whether or not he has one is not among q_1, \dots, q_n .

This brings us to the following definition of the semantic operation which corresponds to forming a mention-some interrogative from an abstract β :

$$(I-MS) \lambda Q[\exists x[\beta'(x) \wedge Q(a)(\lambda a \lambda i[\beta'(x) = (\lambda a \beta'(x))(i)]]]]$$

When we apply this rule to the abstract (17), the resulting translation of the mention-some reading of (15) is (21):

(17) Who has a pen?

(21) $\lambda Q[\exists x[\exists y[\text{pen}(a)(y) \wedge \text{has}(a)(x,y)] \wedge$
 $Q(a)(\lambda \lambda i[\exists y[\text{pen}(a)(y) \wedge \text{has}(a)(x,y)] =$
 $\exists y[\text{pen}(i)(y) \wedge \text{has}(i)(x,y)] \]]]]$

The intension of (21), i.e. the meaning of (17) on its mention-some reading, is a function from indices to sets of properties of questions. If x_1, \dots, x_n are the individuals that have a pen at an index i , then (21) denotes the set of properties of questions Q such that the question whether x_1 has a pen has the property Q or ... or the question whether x_n has the property Q . So, at an index, (17) is materially equivalent with the disjunction of those yes/no interrogatives 'Does x have a pen?' which have the true answer 'Yes.'

Notice, that at an index at which nobody has a pen, (21) denotes the empty set. This accounts for the fact that in such a situation, (17) does not have a true mention-some answer.

Let us now take a quick look at the results we obtain for sentences in which the wh-complement corresponding to (17) on its mention-some reading is embedded under verbs such as wonder and know. Sentence (22), in which the complement corresponding to (17) on its mention-some reading is embedded under the intensional verb wonder translates as (23):

(22) John wonders who has a pen

(23) $\text{wonder}(a)(j, \lambda \lambda Q[\exists x[\exists y[\text{pen}(a)(y) \wedge \text{has}(a)(x,y)] \wedge$
 $Q(a)(\lambda \lambda i[\exists y[\text{pen}(a)(y) \wedge \text{has}(a)(x,y)] =$
 $\exists y[\text{pen}(i)(y) \wedge \text{has}(i)(x,y)] \]]]])]$

In virtue of the meaning postulate defined for extensional verbs such as know, the reduced translation of (24) on its mention-some reading is (25):

(24) John knows who has a pen

(25) $\exists x[\exists y[\text{pen}(a)(y) \wedge \text{has}(a)(x,y)] \wedge$
 $\text{know}_*(a)(j, \lambda i[\exists y[\text{pen}(a)(y) \wedge \text{has}(a)(x,y)] =$
 $\exists y[\text{pen}(i)(y) \wedge \text{has}(i)(x,y)] \]]]]$

From this translation, it is transparent that (24) on its mention-some reading can be paraphrased as (26):

- (26) Of someone who has a pen, John knows whether he has a pen

The translation (25) can be further reduced to (27), which accounts for the fact that (24) on its mention-some reading can equally well be paraphrased as (28):

- (27) $\exists x[\exists y[\text{pen}(a)(y) \wedge \text{has}(a)(x,y)] \wedge \text{know}_*(a)(j, \lambda a[\exists y[\text{pen}(a)(y) \wedge \text{has}(a)(x,y)]])]$

- (28) Of someone who has a pen, John knows that he has a pen

If we assume wonder to be decomposable in want to know, then the translation (23) of sentence (22) on its mention-some reading reduces to (29), accounting for the fact that (22) on this reading can be paraphrased as (30). And (29) can be further reduced to (31), accounting for the fact that on this reading (22) can also be paraphrased as (32):

- (29) $\text{want}(a)(j, \lambda a[\exists x[\exists y[\text{pen}(a)(y) \wedge \text{has}(a)(x,y)] \wedge \text{know}_*(a)(j, \lambda i[\exists y[\text{pen}(a)(y) \wedge \text{has}(a)(x,y)] = \exists y[\text{pen}(i)(y) \wedge \text{has}(i)(x,y)]])]])]$

- (30) John wants to know of someone who has a pen whether he has a pen

- (31) $\text{want}(a)(j, \lambda a[\exists x[\exists y[\text{pen}(a)(y) \wedge \text{has}(a)(x,y)] \wedge \text{know}_*(a)(j, \lambda a[\exists y[\text{pen}(a)(y) \wedge \text{has}(a)(x,y)]])]])]$

- (32) John wants to know of someone who has a pen that he has a pen

Notice that if it happens to be the case that nobody has a pen, then (24) on its mention-some interpretation will be false, this even in case John knows that nobody has a pen. i.e. in case (24) is true on its mention-all reading. In virtue of the intensional nature of the verb wonder, it may very well be

true that John wonders who has a pen even in case nobody has one.

Assuming to wonder to imply to not know, (22) on its mention-some reading implies that of nobody who has a pen, John knows that he has a pen, whereas on its mention-all reading it has the weaker implication that not of everybody who has a pen John knows already that he has a pen.

There are some further interesting relations to be observed between mention-some, mention-all and choice-readings. Consider (24) again:

(24) John knows who has a pen

The choice reading of (24) implies its mention-some reading. This is correct, to know of a particular pen who has that pen, implies to know a person who has a pen. The mention-all reading implies the mention-some reading of (24) only if we assume that someone has a pen.

Similar facts can be noticed with respect to the answerhood properties of the three readings of the interrogative (17):

(17) Who has a pen?

Any proposition which gives a true and complete answer to (17) on its choice reading, will give a true and complete answer to (17) on its mention-some reading as well. And except for the proposition that nobody has a pen, any proposition that gives a complete and true answer to (17) on its mention-all reading, gives a true and complete answer to (17) on its mention-some reading as well. And, finally, any proposition which gives a true and complete answer to (17) on its mention-some reading, will give a partial and true answer to (17) on its mention-all reading.

We end this section by discussing one more example that has some peculiarities of its own. It is one of Belnap's favorite examples, the interrogative (33):

(33) Where do two unicorns live?

The interrogative (33) allows for several different interpretations. Suppose we want to make a picture showing two unicorns. In such a context, (33) asks to mention some place where two unicorns live together. This interpretation results if we take (33) on its mention-some reading, derived from the abstract translating as (34):

$$(34) \lambda x[\exists y\exists z[y \neq z \wedge \text{unicorn}(a)(y) \wedge \text{live-at}(a)(y,x) \wedge \text{unicorn}(a)(z) \wedge \text{live-at}(a)(z,x)]]$$

Of course, there is also the corresponding mention-all interpretation of (33), also to be derived from the abstract (34). On that reading, (33) asks to mention all places where two unicorns live together. This interpretation is at stake in a context where we still want to make that picture showing two unicorns, but this time we want to make it at the nicest spot.

But, (33) allows for yet another interpretation. Suppose we want to catch two unicorns for dinner. Then we are interested in finding two places, not necessarily different ones, where two different unicorns live. One might dub this reading of (33) its mention-two reading. It differs from the mention-some reading in that it does not ask for a single place where two unicorns live together. To be able to catch two unicorns they need not be at one and the same place, though this may be handy.

At first sight, one might believe that the mention-two reading of (33) amounts to its choice reading. In fact, this is the way in which Belnap seems to view the matter. But this is not correct. On its choice reading, (33) asks us to identify two different unicorns, and to tell for each of them where it lives. On its choice reading, (33) would elicit an answer like (35):

(35) Bel lives in the wood, and Nap lives near the lake

But this tells us much more than we really need to know in order to be able to make the necessary preparations for our dinner. It may even spoil our appetite to know the names of our poor victims. For our purposes, we would already be quite satisfied with an answer like (36):

(36) In the wood, and near the lake.

And notice that (36) is a typical answer to a one-constituent interrogative, where as on its choice reading, as the answer (35) reveals, (33) is to be analyzed as a two-constituent interrogative.

So, we have to conclude that, pace Belnap, it will not do to identify the so-called mention-two interpretation of (33) with its choice reading. But then the question remains how we are to deal with this interpretation. The answer is simple: by paying due attention to the fact that two unicorns is a plural term. And the expression surfacing in (36), is a plural expression as well. As an answer to (33) on its mention-two reading, (36) expresses that {in the wood, near the lake} is a set of places such that there is a set consisting of (at least) two unicorns such that each member of the set of unicorns is at some member in the set of places (and at each member of the set of places there is some member of the set of unicorns).

As an answer to (33), (36) is just another instance of, what Remko Scha has called, the phenomenon of cumulative quantification. One of Scha's examples is sentence (37):⁴⁷

(37) 600 Dutch firms use 5000 American computers

On its most likely reading, (37) can be paraphrased roughly as (38):

(38) The total number of Dutch firms that use an American computer is 600, and the total number of American computers used by a Dutch firm is 5000

Scha provides a compositional semantic analysis for the phenomenon of cumulative quantification (and some interesting related phenomena besides).

We do not intend to go into technical details at this point, but only want to sketch informally that once it is recognized that (33) has a reading which involves cumulative quantification, its mention-two interpretation has no further problems to offer. It is simply the mention-some interpretation of (33) on its reading involving cumulative quantification.

To get things to work, we take into account that two unicorns and in the wood and near the lake are plural expressions. This means that the former is to be taken as denoting a set of properties of sets (or groups) of individuals, rather than as a set of properties of individuals. And the latter is to be related in a similar way to a set (or group) of places, rather than to two individual places.

Similarly, the abstract underlying (33) on this reading should not, as the abstract (34) did, express a property of individual places, but rather a property of sets (or groups) of places. On its mention-two interpretation, the wh-phrase where in (33) is to be taken as semantically plural, whereas on its mention-one-place-where-two-unicorns-live interpretation, the wh-phrase is semantically singular.

The abstract underlying (33) on its mention-two interpretation would then be something like (39):

$$(39) \lambda X[\exists Y[\text{unicorns}(a)(Y) \wedge |Y| = 2 \wedge \\ \forall x[Y(x) \rightarrow \exists y[X(y) \wedge \text{live-at}(a)(x,y)]] \wedge \\ \forall y[X(y) \rightarrow \exists x[Y(x) \wedge \text{live-at}(a)(x,y)]]]]]$$

It is our claim that such a result can be obtained by using the techniques developed by Scha. This being so, it is clear that if we apply our mention-some interrogative rule (I-MS) to (39), the result will be an interrogative which asks to specify two (not necessarily two different) places such that at these places taken together, there live two different unicorns.

In other words, the mention-two interpretation really amounts to the mention-some interpretation of the cumulative quantification reading of (33), essentially hinging upon the plurality of the term two unicorns occurring in it. (For obvious semantic reasons, there is in this case no corresponding mention-all reading. Any answer to the much simpler question where (mention-all) a unicorn lives would supply basically the same information as an answer to the mention-all cumulative quantification reading.)

This ends our discussion of this semantic approach to the phenomenon of mention-some interpretations. Its basic features can be summed up as follows. It fits in nicely within our general framework for the semantic analysis of interrogatives and *wh*-complements. More in particular, our basic notion of a question as an equivalence relation between indices was seen to apply to mention-some interrogatives equally well as it applies to mention-all interrogatives. This notwithstanding the fact that the notion of a question is intimately tied to that of exhaustiveness.

The general duality of mention-some and mention-all interpretations of interrogatives is accounted for by distinguishing two basic ways of deriving interrogatives from abstracts. To this general duality in the interpretation of interrogatives corresponds a general duality in the interpretation of answers. Two rules of deriving linguistic answers to interrogatives are to be distinguished. Both take a term and the abstract underlying an interrogative as input. The mention-all answer rule first exhaustifies the interpretation of the term, and then applies it to the interpretation of the abstract to form a proposition. The mention-some answer rule forms a proposition from the term and the abstract without applying exhaustivization.

Sofar, this story about a semantic approach to mention-some interpretations has the looks of a success-story. As promised, in the next section we will provide several arguments which throw some doubt upon this semantic approach really being the happy end.

5.4. Problems for a semantic approach

Despite the nice features of the semantic approach presented in the previous section, the feeling remains, at least with us, that the intuitive pragmatic explanation of how mention-some interpretations come about, is more appealing. In what follows, we will try to provide some arguments why we feel this way, and we will point at some problems of which it remains to be seen whether they can be solved on the basis of the semantic approach.

As we saw in section 5.1, it will not suffice to view mention-some interpretations as mere weakenings of the semantic mention-all readings in terms of the notion of partial answerhood. A mention-some answer is more than just a partial answer, it is a particular kind of partial answer, a positive one. But it seems that this is something that can be explained pragmatically in a natural way as well. Consider the example (40):

(40) Where do they sell Italian newspapers?

In a typical mention-some situation, such as the one in which (40) is asked by an Italian tourist, what triggers the mention-some interpretation is our knowledge that your average Italian tourist's concern is for a newspaper. Getting a newspaper is the background concern for the question. To get a newspaper, you need to know a place where they are sold (and that is open for business, etc.). Clearly, to know one such place will generally suffice. So, being aware of this background concern behind the question, it is reasonable to infer that our Italian tourist will be satisfied if we mention some place where Italian newspapers are sold. And notice that by this particular piece of reasoning the particular positive nature of the answer that is required, is predicted as well.

So, it seems that if our pragmatic reasoning takes into account that questions are asked against the background of certain welldefined concerns (such as things people want to have, or to know, and so on), an intuitive and plausible account of mention-some interpretations on the basis of the semantic mention-all reading can be given. Reaching this conclusion is not the same as providing an explicit theory that works, but it might point into the direction in which we have to look for such a theory.

To this it can be added that even if we stick to the semantic status of mention-some interpretations, a pragmatic theory along these lines would be needed anyway. The semantic account predicts an ambiguity between mention-some and mention-all readings. But in actual language use, ambiguities must be resolved. For this we need the same kind of reasoning as the one outlined above. And if we need this same line of pragmatic reasoning anyway in a full theory of language use, why then not use it as leading us to a certain pragmatic interpretation, rather than to posit a semantic ambiguity and to use it to resolve it?

This view is further supported by some observations. First of all, it may be noticed that mention-some interpretations of wh-complements are possible only when they are embedded under verbs which have a human subject, and which are tied to typical human concerns. Examples are sentences such as (41), (42) and (43):

(41) Maria wonders where they sell Italian newspapers

(42) Mario asks where they sell Italian newspapers

(43) Mary knows where they sell Italian newspapers

But when embedded under verbs which are not related to human concerns and which do not have a human subject, it is impossible to give a mention-some interpretation to wh-complements. Witness (44) - (47):

(44) What the average grade is depends on what grade each student has got

- (45) Where you can get gas depends on what day it is
 (46) Does it matter where a pen is?
 (47) Who will come is partly determined by who is invited

Clearly, in all these cases, mention some interpretations make no sense at all, only mention-all interpretations of the embedded *wh*-complements are possible. If the mention-some interpretation would be a distinct semantic reading, it would seem to be predicted that sentences (44) - (47) are ambiguous between a mention-some and a mention-all reading. But they are not.

On a semantic approach this seems hard to account for. One either would have to find distinctive semantic features of the verbs involved which explain why mention-some readings are blocked, or it should be possible to argue that these sentences do have mention-some readings, but that the semantic interpretation of these verbs is such that they coincide with mention-all readings.⁴⁸ We would not want to claim that such strategies will not work. But, as long as they are not explicitly made to work, the semantic approach faces a problem.

On a pragmatic approach, which arrives at mention-some interpretations by a form of reasoning which takes background human concerns into consideration, there is no problem at all. Such pragmatic reasonings only start off if human concerns are involved. And the relevant ones leading to mention-some interpretations are simply not there in case of sentences such as (44) - (47).

Even more problematic for the semantic approach are such sequences of sentences as in (48):

- (48) Where can I get gas around here?
 That depends on what time it is.

One can easily imagine a situation in which the interrogative in (48) gets a mention-some interpretation. In such a situation the sequence (48) makes good sense. But the indicative in (48) clearly involves a mention-all interpretation of the complement

the anaphor that refers to. But its reference is the interrogative in the sequence which we assumed to have a mention-some reading. It seems hard to explain how an anaphoric expression has another reading of the expression it refers back to, than that expression has itself.⁴⁹

Again this is no problem for the pragmatic approach, which assumes that the only semantic reading of both the interrogative and the wh-complement is the mention-all reading.

A last argument concerns the fact that in some languages, such as the one we know best, mention-some interpretations of interrogatives as such tend not to occur. Rather, there is a strong tendency to phrase mention-some requests differently from mention-all ones, i.e. by means of phrases which do not have the form of an interrogative or wh-complement. For example, in Dutch, one would rather not use (49), but (50) instead. And similarly, (52) would be preferred over (51):

- (49) Jan weet wie een vuurtje heeft
John knows who has a light
- (50) Jan weet iemand die een vuurtje heeft
John knows someone who has a light
- (51) Wat is een voorbeeld van een priemgetal?
What is an example of a prime number?
- (52) Geef een voorbeeld van een priemgetal
Give an example of a prime number

None of the arguments put forward here in itself really show that a semantic analysis of mention-some interpretations is basically wrong-directed. But they do indicate that it faces some problems. In our opinion, this is reason enough not to lose sight of the more intuitive, though admittedly not worked out, pragmatic view.

Be this as it may, the semantic analysis sketched in the previous section certainly has its merits, and shows that the existence of mention-some interpretations is not in conflict with the main features of our semantic theory of interrogatives and wh-complements.

6. A flexible approach to Montague grammar

In the previous sections, we have extended the core theory in such a way that conjunctions and disjunctions, pair-list and choice readings, and mention-some interpretations, are brought within its domain of application. We have seen that conjunctions and pair-list readings can already be dealt with adequately within the core theory itself. It is only to be able to account for the other three kinds of (readings of) interrogatives, that we need to lift interrogatives, and in case of choice readings the underlying abstracts as well, to a level at which they denote sets of properties of questions, and not simply questions. The thus resulting theory we referred to as the lifted core theory.

A question that arises is what we are to do with these two theories. Are we to replace the core theory by its lifted version, or are we to retain them both?

In section 4.2.3 we have already indicated that we have to choose the latter option. Many entailment relations between core interrogatives, i.e. those that fall within the domain of the core theory, are covered by the standard definition of entailment only if we take them to express questions. In lifting them, many entailment relations that hold on the lower level are lost.

Let us first point out that the option of retaining both theories is really open to us. It is, since nothing was really found to be wrong with the core theory as such. Within its domain of application, the results are completely in order. As long as we carefully list and restrict the rules we admit in the core theory nothing can go wrong.

The only thing is that its domain of application is limited. In some cases, lifting is really necessary. But why lift the theory as a whole? why not call for the rules and procedures

of the lifted theory just in case the need arises?

There is an obvious objection to this strategy. If we go about this way, we lose a central feature of 'standard' Montague grammar. This being the feature that each syntactic category by means of a general definition is associated with a single semantic type. If our grammar derives both core and lifted interrogatives it seems to lose this characteristic. Of course, there is an obvious way to avoid this and to stay within the standard theory, viz. by declaring that core interrogatives and lifted interrogatives belong to different syntactic categories. But little is gained this way. There seem to be no syntactic arguments at all to support such a proliferation of categories. And it spreads. Not only interrogatives, but also wh-complements and complement-embedding verbs would be infected. Almost any rule involved would have several versions, a core version and a lifted version.

All this is very true, and it would be decisive if not for one thing. The lifted versions of lifted categories and rules, and lifted translations and interpretations, are all predictable from the core ones. It is not really necessary to state them all separately. The core ones suffice, when supplemented with general lifting rules. Each rule and each category assignment plus translation of basic expressions is stated only once, viz. at the lowest level its semantic analysis allows for. General lifting rules tell us in each case what the corresponding lifted rules, categories, types and translations are.

The strategy outlined above has for the first time been proposed explicitly by Barbara Partee and Mats Rooth.⁵⁰ It is a quite attractive alternative for the strategy followed by Montague in PTQ and other papers. Montague's strategy can be characterized as to 'generalize to the worst case'. E.g. in PTQ all intransitive verbs are assigned type $\langle\langle s, e \rangle, t \rangle$, for the simple reason that some such verbs are essentially to be interpreted as expressing properties of individual concepts, even though the majority of transitive verbs simply express properties of individuals, a fact which is accounted for by a meaning-postulate, which in the end reduces these verbs to expressions

of type $\langle e, t \rangle$.

Quite similarly, PTQ treats proper names not as expressions denoting an individual, not as expressions denoting sets of sets of individuals, not even as expressions denoting sets of properties of individuals, but as expressions denoting sets of properties of individual concepts. This in order to bring them in line with quantified terms. The latter can not be treated as individual denoting expressions. For the larger part they could be treated as denoting sets of sets of individuals in a great many contexts, but as objects of intensional transitive verbs such as seek they can be argued to have to denote sets of sets of properties of individual concepts. Since to Montague this seemed to be the worst case, and since he wanted all terms to be of one and the same semantic type in all contexts, proper names are treated the way they are.

To give a last example, and many others could be added, because seek can be argued to denote a relation between individuals and intensions of sets of properties of individual concepts, all transitive verbs are treated as having such complex denotations. Many of them can simply be interpreted as denoting sets of pairs of individuals, a fact which is again accounted for by means of a meaning postulate.

Partee & Rooth defend a strategy which is the opposite of generalizing to the worst case. It is to minimize complexity whenever this is possible. Lexical items should be introduced at the lowest level that their semantic interpretation allows. Lifting to higher levels of interpretation should occur only when this is empirically motivated. Likewise, rules should be stated at the lowest level at which they give empirically correct results.

The most important reason behind this alternative methodological strategy is not economy, but empirical adequacy. A basic assumption behind Montague's approach is that there really is a 'worst case' one can generalize to. As Partee & Rooth point out, and as was already alluded to in section 4.6, there are reasons to doubt this assumption. E.g. the PTQ type-assignments are not high enough for all cases. They do not

allow one to account for that reading of (1) on which it is equivalent to (2), where the disjuncts of the latter are read *de dicto*:

- (1) John seeks a unicorn or a centaur
- (2) John seeks a unicorn or John seeks a centaur

And a similar problem was noted in section 4. for sentences in which a disjunctive *wh*-complement is embedded under an intensional verb, an example which shows that the type assignments in our lifted core theory also are in need of further lifting in some cases.

For this and other reasons, it seems advisable to leave the strategy to generalize to the worst case, and to replace it by a flexible approach. Though several people have provided arguments and analyses that comply with this strategy, no framework has established itself yet. Therefore, we will just indicate in what follows what we think are some fundamental principles of this approach, without going into technical details.

A first principle, and a main difference with 'standard' Montague grammar is that a syntactic category is not assigned a single semantic type, but rather a set of types. This set consists of a basic type, and of predictable types. The idea is that expressions of a certain syntactic category may be interpreted as being of any of the types associated with that category.

A second characteristic is that the predictable types are defined on the basis of the basic type by means of general procedures.

Thirdly, every expression translates into some logical expression of, i.e. is interpreted as a semantic object of, one of the types associated with its category. This is its basic translation, and the type of that translation, one might call its minimal type. Of course, which type is the minimal type of some expression depends on its characteristic semantic features.

A fourth characteristic is that beside a basic translation of its minimal type, every expression also has predictable translations of all types predictable from its minimal type. These predictable translations are obtained from its basic translation by general procedures, which run parallel to the general procedures that define predictable types.

A last important feature is that the translation rule that corresponds to a syntactic rule is basically defined over logical expressions of the basic types that correspond to the categories of the expressions that form the input of the rule. For every predictable type of (one of) its input expressions, there is a predictable 'form of the' translation rule. These are to be defined by using the same kind of procedures that define predictable types and predictable translations.

Let us illustrate these principles by giving some simple examples. Suppose that S and NP are our basic categories, from which we form functional categories A/B, such as $IV = S/NP$, $TV = IV/NP$, and so on. The basic type corresponding to category S is t, and that of NP is e. The basic type of A/B = \langle basic type of B, basic type of A \rangle . So, the basic type of IV is $\langle e, t \rangle$, that of TV is $\langle e, \langle e, t \rangle \rangle$.

Of course, not all NP's can be regarded as individual denoting expressions, nor are all TV's relations between individuals. At least for some quantified NP's, it holds that they need to be analyzed as denoting sets of sets of individuals. So, $\langle \langle e, t \rangle, t \rangle$ should be another type associated with the category NP, one that is predictable from type e. So, one of the general procedures we need is one that shifts any type a into the type $\langle \langle a, t \rangle, t \rangle$. And if we want to take into consideration NP's that refer to individual concepts $\langle s, e \rangle$ should also be a predictable type of category NP, which means that we also need a type shifting rule which shifts a to $\langle s, a \rangle$. But if NP's are lifted, then so must be IV's and TV's in their argument places. So, we also need a procedure that shifts $\langle a, b \rangle$ to $\langle \langle \langle a, t \rangle, t \rangle, b \rangle$. And similarly, there has to be a procedure which takes us from $\langle a, b \rangle$ to $\langle \langle s, a \rangle, b \rangle$.⁵¹

Some NP's have a translation of a minimal type that

equals the basic type, viz. proper names. For others, the minimal type is a non-basic predictable type. Likewise, some TV's, such as the extensional find, have basic translations of the corresponding basic type, whereas others, such as the intensional seek, are of a minimal type that is essentially higher. Notice that in this flexible approach no extensionalizing meaning postulates are needed.

Although the basic translation of a proper name is of type e , we sometimes, e.g. in the case of coordination, need to have a translation of type $\langle\langle e, t \rangle, t \rangle$ as well. With the procedure that shifts a into $\langle\langle a, t \rangle, t \rangle$, we have a procedure that tells us that if α is the translation of type a , $\lambda X_{\langle\langle a, t \rangle, t \rangle} [X(\alpha)]$ is the corresponding translation of type $\langle\langle a, t \rangle, t \rangle$. So, if John translates as j , it translates as $\lambda X[X(j)]$ as well.

Interrogatives can be handled in this flexible approach elegantly too. Interrogatives are sentential expressions. Syntactically, there seems to be no reason not to assign them to category S , the same category that indicative sentences belong to. But semantically, there is a difference. Whereas indicative sentences have as their minimal translation type type t , the basic type of S , the minimal type of interrogative sentences is higher. It is $\langle s, t \rangle$, one of the predictable types associated with S .

All core interrogatives, conjunctions thereof, and interrogatives with pair-list readings, can be analyzed at this minimal level. It is only for disjunctions of interrogatives, for choice readings, and for mention-some readings, that we need to proceed to a higher level. The lifting procedures which we used in analyzing these interrogatives, in fact take us to a predictable higher type associated with the category S . This move is motivated by the semantic characteristics of these constructions. In this respect there is no difference between taking this step and e.g. taking the step from e to $\langle\langle e, t \rangle, t \rangle$ in case of quantified NP's.

Complement embedding verbs can be regarded as expressions of category IV/S . Extensional expressions of this category, such as know, have as their minimal type $\langle\langle s, t \rangle, \langle e, t \rangle \rangle$. When

applied to a complement on a choice reading, for example, they have to be regarded as being expressions of a higher predicted type. Their translation as expressions of this higher type is predicted by the general rules as well. E.g. know then translates as $\lambda Q\lambda x[Q(a)(\lambda\lambda p[\text{know}(a)(x,p)])]$, in which Q is a variable of type $\langle s, \langle \langle s, \langle \langle s, s, t \rangle \rangle, t \rangle \rangle, t \rangle \rangle$.⁵² As this translation illustrates, constructing this higher type translation from the minimal type one, makes the meaning postulate which takes care of the reducibility superfluous.

The minimal translation of intensional complement embedding verbs, such as wonder, is of type $\langle \langle s, \langle \langle s, \langle \langle s, s, t \rangle \rangle, t \rangle \rangle, t \rangle \rangle, \langle e, t \rangle \rangle$. I.e. it is of the higher type translation of know. In certain cases, of course, a lower type result can be obtained by means of the logic that is used. E.g. if the first argument of wonder is the intension of a set of properties of a unique question, the semantics guarantees the existence of an equivalent relation which takes that question as its first argument.⁵³

In section 4.4, we noticed that sentence (3) also has a reading on which it is equivalent to (4):

- (3) John wonders whom Peter loves or whom Mary loves
- (4) John wonders whom Peter loves or John wonders whom Mary loves

Clearly, the techniques sketched above, allow one to deal with this. The types of complements and of wonder can be lifted to predictable types, and get a predictable translation that will make (3) come out with the same meaning as (4). This solution is basically the same as the one that accounts for the wide scope 'or' case involving (1) and (2) discussed above.

All this remains admittedly sketchy, and the exact content of the principles and rules involved requires further investigation, but we feel that these remarks show that an analysis of interrogatives, including pair-list, choice and mention-some readings and coordination of interrogatives such as we have given in the previous sections, can fruitfully be embedded in a flexible approach to Montague grammar.

Notes

- * We would like to thank Renate Bartsch, Theo Janssen and Fred Landman for their comments on an earlier version.
1. See Groenendijk & Stokhof (1982,1983a,1984a,1984b).
 2. The phenomenon of pair-list readings has been discussed previously in Bennett (1977,1979) Karttunen & Peters (1980), Belnap (1982), Scha (1983), and in G&S (1982,1983a). The approach of Karttunen & Peters is discussed in detail in section 3.2.1, that of Bennett & Belnap in section 3.2.4,, and our earlier approach in sections 3.2.2, and 3.2.3. One of the shortcomings of the latter has already been noticed by Scha. His own proposal to deal with the phenomenon presupposes a performative analysis of interrogatives, and is left out of consideration here. Performative analyses in general have been criticised by many authors. As for this particular case, it could be objected that it is hard to see how a performative approach to pair-list readings could be carried over so as to apply to the same phenomenon with *wh*-complements.
 3. Besides these two there is a third reading, called the 'functional reading', on which (1) is answered as in (a):

(a) His best student.

Functional readings are discussed in G&S 1983a. That they constitute a separate reading of interrogatives, and that answers like (a) are not mere abbreviations of typical pair-list answers, such as (3) (a) and (3) (b), can be argued for in several ways, for example by pointing out that such interrogatives as (b), which do not allow for pair-list answers, do have functional ones, such as (c):

(b) Which student did not professor recommend?

(c) His worst student.

In what follows, functional readings will be left out of consideration altogether.

4. The observation made in the previous note concerning the existence of distinct functional readings of interrogatives applies to *wh*-complements, and to sentences containing them, as well. Throughout what follows they will be ignored.

5. The de dicto nature of ordinary constituent interrogatives (or rather of the corresponding wh-complements) is argued for in some detail in section 1.6 of G&S 1982. Basically the same kind of argumentation is used here with respect to pair-list readings. The way we accounted for these readings in G&S 1982 did not account for their de dicto nature, but resulted in de re readings. See also the discussion in sections 3.2.2 and 3.2.3.
6. For a definition of the notion of a rigid term, see G&S 1984b, section 4.2. The collapsing of the pair-list reading and the wide scope reading in case the verb is know and the term rigid, is to a certain extent a matter of the Framework, that of standard possible worlds semantics, that is used here. Given a semantics of propositional attitudes that does not imply logical omniscience, the two readings remain distinct even in case of rigid terms. The entire issue is hence germane to the analysis of interrogatives proper, and will therefore not be taken up in what follows.
7. See Belnap (1981,1982), Belnap & Steel (1976).
8. When we talk about (non)-uniqueness of answers, we mean in this context complete and true semantic answers. Virtually all interrogatives have more than one partial (true) semantic answer. And from a pragmatic point of view, i.e. taking into account the information of the questioner, almost any interrogative will allow for many different complete pragmatic answers. For definitions and discussions of these various notions of answerhood, see G&S 1984a, and G&S 1984b, section 4.
9. Notice that if the wh-phrase in (21) has widest scope this may give rise to two different readings, one in which the plural term two of John's friends is read collectively, and one in which it is read distributively. Furthermore, it may be noticed that the wh-phrase what in many cases tends to be interpreted as ranging over types (kinds) of objects, rather than over concrete objects (tokens of such types).
10. Some of Belnap's favorite examples are (a)-(d) (see for example Belnap 1982):
 - (a) Where is a place where I can get gas on a Sunday?
 - (b) Who are some of your friends?
 - (c) What is the age of one of your children?
 - (d) What is in the basket?

On its most likely reading, the identification of any place where gas is sold on a Sunday, will count as a complete answer to (a). In the next section, and more extensively in section 5, we will argue that this reading of (a), which we call its 'mention-some'-reading, differs in important respects from a choice-reading.

The interrogatives (b) and, more clearly, (c) are examples of interrogatives which naturally give rise to choice readings.

But only, of course, if they are acceptable English sentences to begin with. In fact, we have our doubts about the acceptability of (b) and (c). Like most of Belnap's examples we find them rather marginal. (These doubts are stronger, and perhaps better founded, if we consider their Dutch counterparts.) Belnap himself seems to have some doubts as well, since in Belnap (1982) he states that even in case such examples as (a)-(d) would not exist in English, or in any other natural language, he would prefer a semantic analysis of interrogatives that could deal with them in principle, over one that couldn't. This for the simple reason that one's semantics should be universal enough to be able to deal with them if need arises. We feel sympathetic towards such tolerance. But our primary interest for dealing with choice-readings of interrogatives in this paper is not any intrinsic importance of the phenomenon as a potential or actual phenomenon of natural language. Rather, what we want to show in this paper is that though our notion of a question, the semantic object associated with interrogatives and complements, is intimately tied to that of a unique complete and true semantic answer, this does not diminish in any way its usefulness in dealing with interrogatives that allow for more than one such answer. And if choice-readings do not constitute an example of such, disjunctions of interrogatives do anyway.

One further remark about (b) and (c). We tend to believe that someone who is really interested in the kind of thing that (b) or (d) seem to ask for, would prefer to phrase his request for this information in a different way, for example by using (e) or (f), rather than (b), and (g), rather than (c):

- (e) Mention some of your friends!
- (f) Give me the names of some of your friends!
- (g) Tell me the age of one of your children!

As far as (d) is concerned, according to Belnap both (h) and (i) count as full, complete answers:

- (h) Some apples.
- (i) Three apples.

We are not sure whether we agree. But if Belnap is right, we believe he is because there is an ambiguity at stake. As we already alluded to in note 9, it seems that what might either ask for a specification of kinds, in this case the kinds of objects in the basket, or of objects as such. Clearly, (h) would be an answer to (d) on the first interpretation, and (i) would fit the second one. However, three apples being indefinite and non-rigid, (i) could not count as a complete semantic answer. (See G&S 1984b, section 4, for a general discussion of the relationship between semantic properties of terms and notions of semantic and pragmatic answerhood.) However, given the fact that in most circumstances we do not have, nor need, identity criteria and rigid names for individual apples, it may still be that, pragmatically speaking, (i) is the

best answer we can, and want to, give, given our purposes and linguistic means. In short, we doubt that both kinds of answers are really answers to the same question. And we further doubt that both would count as semantically complete. And only if both these conditions would be fulfilled, (d) would count as an example that is relevant in the present context.

11. Sentence (29) has only two readings, but there are sentences which allow for one more. Consider (a) and (b):

- (a) Bill seeks John or Mary, or Peter or Suzy
 (b) John seeks a unicorn or a centaur

On their intended third reading, (a) and (b) can be paraphrased as (c) and (d) respectively, both disjuncts being read *de dicto*:

- (c) Bill seeks John or Mary, or Bill seeks Peter or Suzy
 (d) John seeks a unicorn, or John seeks a centaur

These readings of (a) and (c) cannot be obtained in the PTQ-fragment (as was observed in Partee & Rooth 1982b). In section 4.6 the same kind of phenomenon is observed with respect to sentences containing a disjunctive *wh*-complement embedded under an intensional verb. In section 6 we will sketch a more flexible approach to Montague grammar, advocated by Partee & Rooth and others, in which these and similar problems can be solved in an elegant way.

12. As examples of readings of interrogatives on which they allow for more than one complete and true semantic answer, mention-some interpretations are cited far more often than choice-readings. To our knowledge, only Belnap seems to have observed the latter. But, as we will argue, he fails to distinguish properly between mention-some interpretations and choice-readings.

The distinction between mention-some interpretations and mention-all interpretations plays an important role in the theory of Hintikka (see e.g. Hintikka 1976, 1978). In his analysis, *wh*-phrases are ambiguous between an existential quantifier reading and a universal quantifier reading. For a general outline, and an evaluation, see G&S 1984c, section 4.4. See further section 5.

13. To some extent, the remarks in note 10 concerning the marginal nature of choice readings, and the observation made there that in many cases one would use different linguistic means to express what such a reading is supposed to express, apply to mention-some interpretations as well. Some examples that support the latter claim are given in section 5.4.
14. Earlier we defended the position that mention-some interpretations are a pragmatic phenomenon (see for example the discussion in G&S 1982, section 6.3). This position is also

- defended by others (Karttunen is an example, see Karttunen 1977, note 4). The distinction between semantic ambiguity and pragmatic multi-interpretability is admittedly vague, and it is certainly not clearly defined outside a theoretical context. As a purely methodologically motivated principle, we draw the line between semantics and pragmatics between truth conditions (or semantic answerhood conditions when we are dealing with interrogatives) and other non-truthconditional aspects of meaning. This presupposes that these other aspects of meaning do not interfere with truth conditions. We use this principle as a guide-line, not so much because we are convinced that it embodies some ultimate truth, but rather because it leads to clearly organized and well-delineated analyses. As with all such methodological principles, it is one that one should be prepared to give up as soon as a descriptively and explanatory superior theory turns up that does without it.
15. The position that the two phenomena are one and the same is implicitly held by Belnap. We will go into this in some detail in section 5.3.
 16. Over the years, several alternatives have been proposed for PTQ's quantification rules. For the larger part, these alternatives are syntactically motivated. To the extent to which these proposals present alternatives for the syntax and have the same semantic effects as the quantification rules which they are to replace, our discussion is intended to apply to them too. For it concerns the semantic part of the mechanism of quantification only, and does not depend on the particulars of some specific syntactic implementation.
 17. See Partee & Rooth (1982a, 1982b) and the references cited there.
 18. The definitions (CT), (CONJ) and (DISJ) are taken from Partee & Rooth (1982a).
 19. According to (INCL) then we have entailment between objects of all kinds of types. It is easy to see that the definition accounts for such entailments as hold between John walks and John walks or talks, and between John and a man, and between to walk and to move, to give a few examples.
 20. An apparent exception to this rule seems to be the 'conjunction' that takes John and Mary, for example, into the expression John and Mary denoting the group, or the collective individual, consisting of John and Mary. For a discussion of the status of such cases see Partee & Rooth (1982a).
 21. Roughly speaking, one may think of the coordination in a term as the disjunction of the conjunction of all the elements in all the minimal elements in the term.

22. A generalization of (QUANT) can be obtained by replacing the type t by an arbitrary type c , and conjoinable by c -conjoinable (the latter notion in its turn is a simple generalization of (CT)). Also one might want to have an extensional version of (QUANT), and perhaps one of which both that extensional version, and the intensional one defined in the text are special instances.

As an illustration of how (QUANT) works, consider what happens if we quantify the term every man into the term he₀'s mother. The first translates as $\lambda P \forall x [\text{man}(a)(x) \rightarrow P(a)(x)]$ and the second as $\lambda P \forall x [\exists y [\text{mother-of}(a)(y, x_0) \leftrightarrow x = y] \wedge P(a)(x)]$. Abbreviate them as α and β respectively. Quantification for x_0 then gives:

$$\begin{aligned} Q(\alpha, x_0, \beta) &= \lambda X_{\langle s, \langle e, t \rangle \rangle} [Q(\alpha, x_0, \beta(X))] = \\ &= \lambda X [Q(\alpha, x_0, \forall x [\exists y [\text{mother-of}(a)(y, x_0) \leftrightarrow x = y] \wedge X(a)(x)])] = \\ &= \lambda X [\alpha(\lambda a \lambda x_0 [\beta(X)])] = \\ &= \lambda X \forall x [\text{man}(a)(x) \rightarrow \exists y [\forall z [\text{mother-of}(a)(z, x) \leftrightarrow y = z] \wedge X(a)(x)]] \end{aligned}$$

A schema similar to (QUANT) can be found in Partee & Rooth (1982a).

23. See e.g. Hausser (1977), (1983). Categorical theories in general are discussed in G&S 1984c, section 4.2. Some remarks and criticism concerning details may be found scattered through the notes in G&S 1984b.
24. See Hamblin (1976), Karttunen (1977). A general discussion of propositional theories can be found in G&S 1984c, section 4.3.
25. See G&S 1984c, note 38.
26. It is perhaps illuminating to pursue this matter a little further. Karttunen derives constituent interrogatives such as (10) by quantifying-in a wh-term. (The essence of this rule is stated in (14) below.) Wh-terms are interpreted as existentially quantified terms, i.e. who translates as (a):

$$(a) \lambda P \exists x [P(a)(x)]$$

Wh-terms are quantified into structures containing a free variable, but these are not, as one might have expected, open interrogatives, but a different kind of expression, called 'proto-questions'. I.e. (10) is not derived from (b) translating as (c), but from (d) translating as (e):

- (b) Does PRO₁ walk?
 (c) $\lambda p [p(a) \wedge (p = \lambda a [\text{walk}(a)(x_1) \vee p = \lambda a [\neg \text{walk}(a)(x_1)])]]$
 (d) ?PRO₁ walks
 (e) $\lambda p [p(a) \wedge p = \lambda a [\text{walk}(a)(x_1)]]$

The result of quantifying into (b) would have been (f), what Karttunen gets by quantifying into (d) is (g):

- (f) $\lambda p [p(a) \wedge \exists x [p = \lambda a [\text{walk}(a)(x)] \vee p = \lambda a [\neg \text{walk}(a)(x)]]]$
 (g) $\lambda p [p(a) \wedge \exists x [p = \lambda a [\text{walk}(a)(x)]]]$

The difference between (f) and (g) is one of exhaustiveness: (g) contains for every individual that walks the proposition that he/she walks; but (f) contains besides those also for every individual that does not walk the proposition that he/she does not walk. So, whereas (g) only exhausts the positive extension of the predicate to walk, (f) also exhausts its negative extension.

Two arguments to favour (f) over Karttunen's (g) can be noticed right away. First, given (f) as translation of (10), it entails (11) under the standard definition of entailment (9). Second, in case no-one walks (g) denotes the empty set, predicting that (10) in such a case has no true answer. But of course it has: the proposition that no-one walks, which is indeed what the propositions denoted by (f) in this case jointly express.

Why then didn't Karttunen opt for (f)? The reason he has is that he wants to avoid a consequence of this construction of constituent interrogatives, viz. that (h) and (i) come out equivalent:

- (h) Who walks?
- (i) Who doesn't walk?

To see whether this is reasonable, notice first of all that (h) and (i) should be equivalent in a model with a fixed domain. Consider (j) and (k):

- (j) John knows who walks
- (k) John knows who doesn't walk

Epistemically, the fixed domain assumption boils down to John knowing all the individuals in the domain. But in that case, the equivalence of (j) and (k) is not only unobjectionable, it is imperative. In Karttunen analysis, however, this cannot be accounted for. Of course, in models with varying domains (h) and (i) should not be equivalent. Or, epistemically speaking again, if John does not know all the individuals, but is mistaken about what actually constitutes the domain, then (j) and (k) should not come out the same. So, on the one hand there is some reason to reject the analysis that leads to (f), but on the other hand there are also reasons to reject the approach Karttunen advocates.

The core theory, which assigns propositions as denotations to interrogatives, rather than sets of such, constitutes a different approach that does avoid these problems. It accounts for entailments such as between (10) and (11), and between (10) and (l) and (m), which incidentally an analysis which leads to (f) does not deal with:

- (l) Does John or Mary walk?
- (m) Does anyone walk?

And it handles the relationship between (h) and (i) properly: they come out equivalent in all models that have a fixed domain, and different in models with varying domains.

27. See Karttunen & Peters (1981).
28. See also the remarks in G&S 1982, section 1.8.
29. See G&S 1979.
30. This formulation is not completely accurate, Karttunen does not quantify into yes/no-interrogatives, but into 'proto-questions'. The difference, and the consequences are discussed in note 26.
31. As we saw in note 26, this was for Karttunen the reason to use 'proto-questions', instead of yes/no-interrogatives. But, as we also saw there, this solution creates other problems, and hence cannot be considered to be satisfactory.
32. One should not be misled, of course, by the fact that most competent speakers of English will know that Bill is a name that refers to a male. Even if such information would belong to the semantic content, the observation is irrelevant. It would at most show that the example is not a happy one, but not that the problem it is used to illustrate does not exist.
33. See G&S 1982 section 3.7 for a definition of the syntactic process and its semantic interpretation. The following fact is important, and will be used implicitly in what follows: if β is an n-place predicate taking arguments of type a_1, \dots, a_n , and x_1, \dots, x_n are variables of these types, then $\lambda x[\alpha] \beta$ is equivalent to $\lambda x_1 \dots \lambda x_n [\alpha(x) \wedge \beta(x_1, \dots, x_n)]$.
34. See G&S 1984b, especially sections 2 and 3, for an extensive discussion of the why and how of exhaustiveness.
35. See the papers by Bennett and Belnap cited in note 2. The formal theory developed by them is rather complex and deviates in important respects from what one is familiar with in Montague grammar. The main features, we trust, can be stated and discussed without going into actual details. But the reader is implored to turn to Bennet and Belnap's papers to check our remarks.
36. In order to deal with choice-readings by means of a quantifying-in process, they need a notion of an 'open proposition'. This they implement in their framework by introducing such open propositions as functions from sequences (of objects) to closed propositions into the object language into which they translate. This move changes and complicates the entire framework, also in places where it has no demonstrable use. This is of course less objectionable if the results obtained are correct, but, as is argued in the text, this is not the case.
37. See note 28.

38. It is arguable that we do not need all the intensionality that is inherent in such an object. Instead of the intension of a set of properties of questions, we could do with the intension of a set of sets of questions. The former object we get if we follow the general strategy for dealing with coordination as it is exemplified in standard Montague grammar. Recently, attempts have been made to develop a more flexible approach, not just for reasons of elegance and parsimony, but also for reasons of empirical adequacy. In such an approach a 'minimally intensional' object can be defined to serve as second argument of complement-embedding verbs. Some sketchy remarks about this flexible approach are made in section 6.
39. For a definition of other notions of answerhood, such as being a complete answer, being and giving a partial answer, and so on, see G&S 1984a, and 1984b, section 4.
40. In section 4.3.2, it will be argued that in some cases the IA-rule needs to be lifted in both its arguments. See (83) in that section.
41. This is in line with the terminology used in the theory of generalized quantifiers.
42. This holds, of course, only if we analyze two girls as a singular quantifier, i.e. as the denoting the set of properties such that two girls have them. There is also a plural interpretation, on which this term denotes the set of properties such that a group (collection) consisting of two girls has them. In that case, the minimal elements are singletons, each consisting of a group of girls with two members. And the property on which the term lives then is that of being a group of girls with two members.
- This plural interpretation of terms is, first of all, needed for a proper analysis of interrogatives containing predicates which have a collective interpretation, such as (a) and (b):

- (a) Where did two girls meet?
 (b) what did two girls carry up the stairs?

Secondly, it is necessary to take plurality into account in order to get a proper analysis of the interrogative discussed in the text, reading two girls as at least two girls.

It should be noted that the property on which two girls lives, is not exactly that of being a girl. If a model contains indices at which there are less than two girls, the property in question is that property that is coextensive with that of being a girl at all indices at which there are at least two girls, and that has the empty set as its extension otherwise. This predicts correctly that at indices of the latter kind, the relevant interrogatives on their choice reading, do not have any true answers. In order to avoid unnecessary complications, we will ignore this nicety in what follows.

43. See G&S 1984b, section 3.1.2, for a definition of the semantic operation of exhaustivization. In section 3.1.3 of that paper it is argued that for exhaustivization to work properly in all cases, some terms have to be analyzed essentially as plural terms. The observations and remarks made there, carry over here, of course. But since in the present context nothing new can be said about these matters, they will be ignored in what follows.
44. See the last remark in note 42.
45. The syntax and semantics of multiple terms is discussed in detail in G&S 1984b, section 3.2.1.
46. See Belnap 1982. All references to Belnap's examples and views that follow are based on this paper.
47. See Scha 1981.
48. This seems to be possible, since it seems that there is a close correspondence between the intension of the mention-some reading of an interrogative and the intension of its mention-all reading. Such verbs as depend express relations between functions, and hence should be taken to be intensional in both arguments. I.e. depend operates on the intensions of two interrogatives. See G&S 1983b. But then, if our conjecture is correct that the correspondence allows us to go from one to the other, which reading we take, seems not to matter.
49. If it cannot be explained, it seems that only the second of the two options mentioned above is a viable one.
50. See Partee & Rooth (1982a, 1982b). Others have discussed type-shifting rules as well, see e.g. van Benthem (1984), and the references given there.
51. Explicit definitions of these four type-shifting rules can be found in Partee & Rooth 1982a. They hypothesize that they form a 'complete' set. It should be noted, however, that not all PTQ-types are obtainable by means of these four procedures. A first, perhaps unimportant case, which is also noted by Partee & Rooth, concerns the PTQ-type of TV's:
 $\langle\langle s, \langle\langle s, \langle\langle s, e \rangle, t \rangle \rangle, t \rangle \rangle, \langle\langle s, e \rangle, t \rangle \rangle$. This is not a predictable type, i.e. it cannot be construed by the procedures of Partee & Rooth from the basic TV-type $\langle e, \langle e, t \rangle \rangle$. What we do get, by applying argument-lifting and argument-intensionalizing, is $\langle\langle s, \langle\langle e, t \rangle, t \rangle \rangle, \langle e, t \rangle \rangle$. In order to get the PTQ-type we would need procedures of another kind. First of all, in order to get the intension of a set of properties, instead of that of a set of sets, we need to be able to intensionalize, not an argument, but an argument of an argument. Generalizing, intensionalizing seems to be a procedure that can be applied at arbitrary depth in arguments. In order to get individual concepts, we need even more. In the argument the concept can

gotten by starting with argument intensionalizing. But in the value of the PTQ-type this will not work. Partee & Rooth argue that getting the properties is not essential. Referring to Dowty, Wall & Peters (1981), they claim that the intension of a set of sets will do. This seems to be correct. As for the individual concepts, they are ignored by Partee & Rooth, presumably because they think they are not needed. This seems not to be correct. Arguments that individual concepts are useful semantic objects also in natural language are given in Janssen (1984a, 1984b). So, there are reasons to want to get individual concepts in the value of a predictable TV-type.

The need for type-shifting procedures that operate on values of functions can be illustrated by two other examples. First, consider expressions of type $\langle e, e \rangle$, such as the father of, himself (in some of its uses), etc. A predictable type should be that of a function that takes a high-level term into a high-level term (whatever one takes this high-level term type to be precisely). In order to get that, we need a procedure that lifts, not arguments of functions, but values. The definitions of such 'value'-procedures which are analogues of the 'argument'-procedures and which moreover are able to operate on arbitrary depth, are not very difficult to give. But a second example illustrates that we need something more complicated than that. Consider three-place verbs. Their basic type is $\langle e, \langle e, \langle e, t \rangle \rangle \rangle$. One of the predictable types should be that in which the second argument is lifted to term-level. And this is a case again of where we have to operate in the argument of a value.

These considerations indicate, we feel, that the four procedures defined by Partee & Rooth do not form a complete set, in the sense that they will allow us to deal with all the types we need basing ourselves on as a set of types associated with syntactic categories which is as basic as possible. Further investigation of these matters is clearly needed.

52. This result presupposes the generalized type-shifting procedures indicated in note 51.
53. This means that the meaning postulate for wonder and similar intensional verbs, which was defined in G&S 1982, section 5.2, is superfluous, c.q. wrong. It is superfluous for all interrogatives that the core theory deals with. In those cases the reduction to a relation need not be imposed, but follows straightforwardly from the semantics itself. In the case of disjunctions of interrogatives, and choice-readings, it produces wrong results, since, given this meaning postulate, we would be able to distribute wonder over the disjuncts.

References

- Belnap, N., 'Approaches to the semantics of questions in natural language. Part I', ms., Pittsburgh, 1981
- Idem, 'Questions and answers in Montague grammar', in: S. Peters & E. Saarinen (eds.), Processes, beliefs and questions, Reidel, Dordrecht, 1982
- Belnap, N. & T. Steel, The logic of questions and answers, Yale University Press, New Haven, 1976
- Bennett, M., 'A response to Karttunen on questions', Linguistics and Philosophy, 1, 1977
- Idem, Questions in Montague grammar, Indiana University Linguistics Club, Bloomington, 1979
- Bentham, J. van, 'The logic of semantics', in: Landman & Veltman (1984)
- Dowty, D., R. Wall & S. Peters, Introduction to Montague semantics, Reidel, Dordrecht, 1981
- Groenendijk, J. & M. Stokhof, 'On the semantic analysis of wh-complements', ms., Amsterdam, 1979
- Idem, 'Semantic analysis of wh-complements', Linguistics and Philosophy, 5, 1982
- Idem, 'Interrogative quantifiers and Skolem-functions', in: K. Ehlich & H. van Riemsdijk (eds.), Connectedness in sentence, discourse and text, Tilburg, 1983a
- Idem, 'A note on dependence as a relation between questions', ms., Amsterdam, 1983b
- Idem, 'On the semantics of questions and the pragmatics of answers', in: Landman & Veltman (1984)
- Idem, 'Questions and Linguistic answers', ms., Amsterdam, 1984b
- Idem, 'Problems and prospects in the theory of questions and answers', ms., Amsterdam, 1984c
- Hamblin, C., 'Questions in Montague English', in B. Partee (ed.), Montague grammar, Academic Press, New York, 1976 (originally in Foundations of Language, 10, 1973)
- Hausser, R., 'The logic of questions and answers', ms., München, 1976

- Idem, 'The syntax and semantics of English mood', in:
F. Kiefer (ed.), Questions and answers, Reidel, Dordrecht,
1983
- Hintikka, J., The semantics of questions and the questions
of semantics, Acta Philosophica Fennica, 28 (4), 1976
- Idem, 'Answers to questions', in: H. Hiz (ed.), Questions,
Reidel, Dordrecht, 1978
- Janssen, T., 'Individual concepts are useful', in: Landman
& Veltman 1984
- Idem, 'Individuals and individual concepts', paper read at
the Fifth Amsterdam Colloquium, august, 1984b
- Karttunen, L., 'Syntax and semantics of questions', Linguistics
and Philosophy, 1, 1977
- Karttunen, L. & S. Peters, 'Interrogative quantifiers', in:
C. Rohrer (ed.), Time, tense and quantifiers, Niemeyer,
Tübingen, 1980
- Partee, B. & M. Rooth, 'Generalized conjunction and type
ambiguity', ms., Amherst, 1982a
- Idem, 'Conjunction, type ambiguity, and wide scope "or"',
ms., Amherst, 1982b
- Landman, F. & F. Veltman (eds), Varieties of formal semantics,
Foris, Dordrecht, 1984
- Scha, R., 'Distributive, collective and cumulative quantifi-
cation', in: J. Groenendijk, T. Janssen & M. Stokhof (eds.),
Formal methods in the study of language, Mathematical
Centre, Amsterdam, 1981
(reprinted in Groenendijk, Janssen & Stokhof (eds.),
Truth, interpretation, information, Foris, Dordrecht, 1984)
- Idem, Logical foundations for question answering, dissertation,
University of Groningen, 1983

SAMENVATTING IN HET NEDERLANDS

Studies over de semantiek van vragen en de pragmatiek van antwoorden

Dit proefschrift is een bundeling van zes studies over verschillende onderwerpen binnen de theorie van vragen en antwoorden. Het theoretisch kader wordt gevormd door de 'logische', of 'formele', semantiek, een model van taalbeschrijving waarin syntactische structuren semantisch worden geïnterpreteerd met gebruikmaking van daartoe in de logica en wiskunde ontwikkelde methoden en technieken.

In de eerste studie wordt beargumenteerd waarom de bestudering van vraagzinnen en van de vraag-antwoord relatie van speciaal belang is binnen dit logisch-semantisch kader. De voornaamste redenen die daarvoor wordt aangevoerd heeft een defensief karakter. De logica wordt vaak verondersteld zozeer te zijn toegesneden op beweren of descriptief taalgebruik, dat andere vormen van taalgebruik principieel buiten haar bereik zouden liggen. Door een logisch-semantische analyse van vraagzinnen, een belangrijke niet-descriptieve taalvorm, te geven die beschrijvende en verklarende waarde heeft, kan een bijdrage worden geleverd aan de weerlegging van deze onjuiste veronderstelling.

Aan de hand van een aantal algemene principes die aan het gebruikte theoretisch kader ten grondslag liggen, zoals het principe van compositionaliteit, wordt gemotiveerd waarom juist bepaalde empirische verschijnselen op het gebied van vragen en antwoorden van speciaal belang worden geacht. Vervolgens worden drie soorten theorieën vergeleken, en getoetst op hun empirische en theoretische adequaatheid. Geconstateerd wordt dat elk van de drie zich primair richt op een bepaald gedeelte van het empirisch domein, en dat unificatie is geboden.

De tweede studie betreft de semantische analyse van vraagzinscomplementen. In latere studies wordt deze overgedragen op vraagzinnen als zodanig. Beide worden opgevat als uitdrukkingen die een propositie denoteren. De propositie die een vraagzin op een bepaalde index (mogelijke wereld) denoteert, is de propositie die een bewerende zin zou moeten uitdrukken om op die index een volledig en waar antwoord te zijn op de door de vraagzin uitgedrukte vraag.

De betekenis van een vraagzin is dan een propositioneel

concept, een functie van indexen naar proposities, die voor elke index de propositie levert die daar een volledig en waar antwoord is. Op die manier karakteriseert de semantische inhoud van een vraagzin een heel bepaalde notie van antwoord, die van een volledig semantisch antwoord. Men kan zeggen dat, zoals de betekenis van een bewerende zin bestaat in de waarheidscondities ervan, de betekenis van een vraagzin bestaat in haar beantwoordingscondities.

Zoals gezegd is de door de semantische analyse vastgelegde notie van antwoord een heel bepaalde, een standaard notie van antwoord. In de praktijk van het taalgebruik zijn vragen in verschillende situaties op vele verschillende manieren te beantwoorden. Niet elke vorm van antwoord is echter in elke situatie even adequaat. In hoeverre dat het geval is, hangt zowel af van de semantische inhoud van een gegeven antwoord, als van de informatie die de vraagsteller in een gegeven situatie reeds ter beschikking staat.

Met name in de vierde studie worden een aantal verschillende noties van antwoord gedefinieerd, die vastleggen onder welke omstandigheden welke propositie een geheel of gedeeltelijk adequaat antwoord op een vraag is. Daarbij wordt de nadruk gelegd op de pragmatische functie van vragen en antwoorden als een vorm van taalgebruik die expliciet is gericht op het vullen van leemten in iemands informatie.

De resulterende abstracte semantische en pragmatische analyse van de vraag-antwoord relatie, wordt in de vijfde studie gerelateerd aan de talige middelen waarmee vragen en antwoorden tot uitdrukking worden gebracht. Daarbij worden noch 'korte' antwoorden, in de vorm van een constituent, noch 'lange' antwoorden, in de vorm van een volledige zin, gedisclineerd. Beargumenteerd wordt dat beide soorten talige antwoorden in gelijke mate voor hun juiste interpretatie afhankelijk zijn van de context zoals die door de vraagzin wordt geboden.

Een belangrijk argument daarvoor geeft de observatie dat beide soorten antwoorden 'exhaustief' worden geïnterpreteerd, zodat een zin als antwoord op een vraag een andere betekenis kan hebben dan de gebruikelijke. Een belangrijk deel van de vijfde studie is gewijd aan het geven van een logische inhoud aan deze voor de analyse van antwoorden zo belangrijke notie van exhaustiviteit.

Structurele ambigüiteiten vormen een van de voornaamste verschijnselen waarvoor een semantische theorie rekenschap moet geven. Zo hebben bepaalde vraagzinnen naast hun 'gewone' interpretatie nog andere lezingen. Voorbeelden daarvan zijn 'paar-lijst' lezingen, 'keuze-vraag' lezingen, 'noem-één' interpretaties, en 'functionele' lezingen. Dat de laatste onderscheiden lezingen vormen wordt beargumenteerd in de derde studie.

De andere drie genoemde vormen van ambigüiteit worden in de zesde en laatst studie het uitvoerigst besproken. Paar-lijst- en keuze-vraag lezingen worden in verband gebracht met coördinatie, respectievelijk conjunctie en disjunctie, van vraagzinnen. Een belangrijke eigenschap van keuze-vraag lezingen, die ze gemeen hebben met noem-één interpretaties, is

dat vraagzinnen met een dergelijke lezing met meerdere verschillende vragen zijn geassocieerd. Degene die een antwoord wordt gevraagd wordt daarbij de keuze gelaten welke van die vragen hij of zij wenst te beantwoorden.

Een juiste behandeling van dit verschijnsel vereist een uitbreiding van de analyse zoals die in de eerdere studies wordt gegeven. Getoond wordt dat de vereiste uitbreiding conservatief van aard is. De oorspronkelijke analyse blijft correct voor alle 'simpele' gevallen. En de middelen waarvan bij de uitbreiding gebruikt wordt gemaakt behelzen een standaardmethode, die ook op vele andere verschijnselen van coördinatie van toepassing is.

De studies bevatten naast een informele uiteenzetting van de probleemstelling en de voorgestelde oplossing, steeds tevens een formele analyse, zoals dat in de logische semantiek gebruikelijk is.

STELLINGEN

van Martin Stokhof bij het proefschrift

Studies on the semantics of questions and the pragmatics of answers

1. Noam Chomsky, Rules and Representations, 165:

"If these conclusions are correct, one might speculate that the familiar quantifier-variable notation would in some sense be more natural for humans than a variable-free notation for logic; it would be more readily understood, for example, in studying quantification theory and would be a more natural choice in the development of the theory. The reason would be that, in effect, the familiar notation is 'read off of' the logical form that is the mental representation for natural language. The speculation seems to me not at all implausible."

Deze claim zou nog aan kracht winnen als ze vergezeld ging van een verklaring van het feit dat het tot het einde van de 19^e eeuw duurde voordat kwantoren en variabelen in de logica werden geïntroduceerd, en dan nog in een notatie (die van Frege's Begriffsschrift) die allesbehalve de 'familiair notation' (die van Peano) is waarop Chomsky hier schijn te doelen.

2. De taal verhoudt zich tot het overdragen van informatie zoals de longen zich verhouden tot het ademen.

(Contra: J. Koster, 'De ontsemiotisering van het wereldbeeld', Gramma, 1983)

3. Overigens duidt een veelvuldig gebruik van analogieën in een wetenschappelijke tekst op een hoog overredings- en een laag overtuigingsgehalte.

4. Het inzicht dat veel van de vragen in Wittgenstein's Philosophische Untersuchungen rethorische vragen zijn, bevordert het begrip van deze tekst aanzienlijk.

5. Een realistische theorie over geloof is onmogelijk.

6. Er zijn geen filosofische vragen, er zijn hoogstens filosofische antwoorden.

STELLINGEN

van Jeroen Groenendijk bij het proefschrift
Studies on the semantics of questions and the pragmatics of answers

1. Als de taalwetenschap de semantiek aan de logica laat, dan laat zij een historische kans onbenut om een linguïstisch interessante semantische theorie van de grond te krijgen.

2. Wittgenstein, Tractatus, 3.12:

"Der Satz ist das Satzzeichen in seiner projektiven Beziehung zur Welt."

Gegeven dat deze uitspraak een wezenlijk kenmerk van de taal tot uitdrukking brengt, zal men in de eerste plaats slechts dan met een grammaticamodel tevreden zijn indien het een theorie over deze relatie omvat, en zal men in de tweede plaats filosofische theorieën over deze relatie niet verontachtzamen.

3. Wittgenstein, Philosophische Untersuchungen, par. 22:

"Wir könnten sehr gut auch jede Behauptung in der Form einer Frage mit nachgesetzter Bejahung schreiben; etwa: "Regnet es? Ja!".
Würde das zeigen, dass in jeder Behauptung einer Frage steckt?"

Ja!

4. Een conversationele implicatuur à la Grice kan worden gedefinieerd als een logisch gevolg van de aanname dat de spreker zich houdt aan de Griceaanse conversationele maxims.
5. Het projectieprobleem voor presupposities kan worden opgelost door een vier-waardig sterk Kleene systeem als semantische basis te nemen, en te combineren met een Griceaanse theorie van conversationele implicaturen, die in sommige gevallen werkt als een pragmatisch filter, en in andere gevallen als een pragmatisch vangnet.
6. De taal is een der middelen waarmee de eindige menselijke geest greep krijgt op het oneindige.