



# Auger electron spectroscopy (AES) and modulation techniques

Wolfgang Ranke  
Dep. Inorganic Chemistry  
Group Surface Analysis  
Fritz-Haber-Institut der MPG

For script:  
see homepage  
or

mail to: [ranke@fhi-berlin.mpg.de](mailto:ranke@fhi-berlin.mpg.de)

## Content

**AES – basics**

**AES – surface sensitivity**

**Electron energy analysis**

**e-beam influences**

**Modulation method, Lock-In**

**Qualitative/quantitative analysis**

**Chemical information**

## **Literature - AES:**

G. Ertl, J. Küppers, Low Energy Electrons and Surface Chemistry, VCH, Weinheim (1985).

J.W. Niemantsverdriet, Spectroscopy in Catalysis, Wiley-VCH, Weinheim (2000).

G.E. McGuire, Auger Electron Spectroscopy Reference Manual, Plenum Press, New York (1979).

L.E. Davis et al., Handbook of Auger Electron Spectroscopy, Physical Electronics Ind. Inc., Eden Prairie (1976).

## **Literature - Lock-In, Modulation techniques:**

M.L. Meade, Lock-In Amplifiers: Principle and Applications, Peter Peregrinus Ltd., London (1983).

R.K. Willardson, A.C. Beer (eds.), Semiconductors and Semimetals, Vol. 9: Modulation Techniques, Academic Press, New York (1972).

## **Wikipedia**

English: <http://en.wikipedia.org>

German: <http://de.wikipedia.org>

# AES - basics

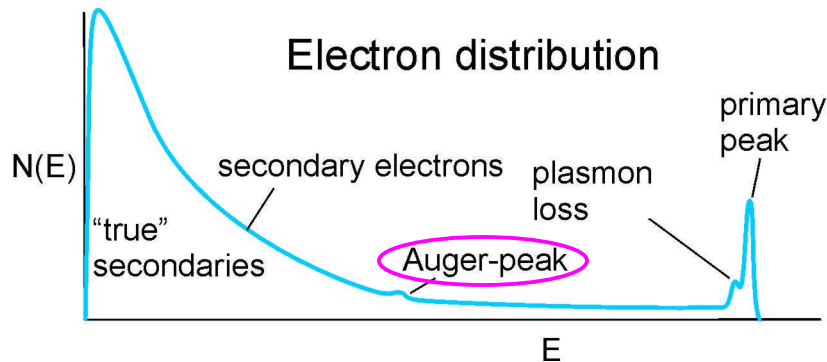
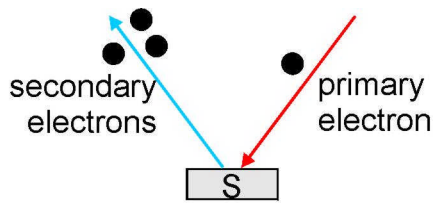
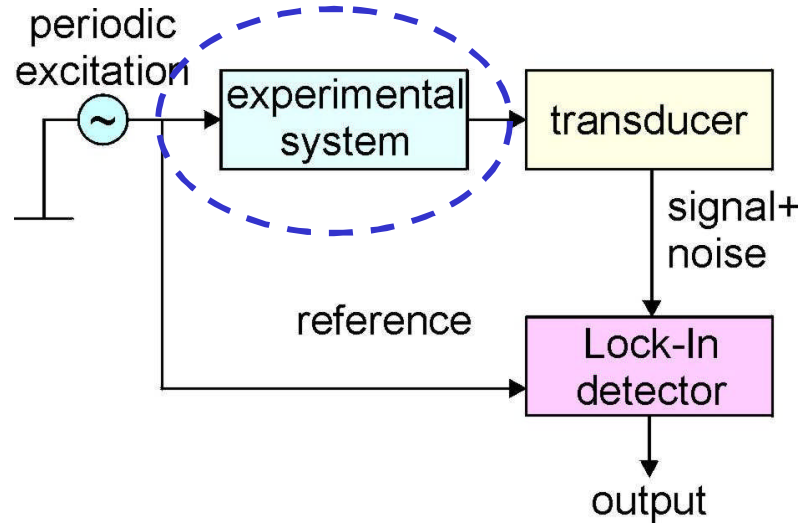

Excitation:

- 😊 Primary electrons, 1-10 kV.  
easy to create.  
(Also possible: X-rays, see XPS).
- 😊 easy to focus ( $< 1\mu\text{m}$ ):  
Scanning-Auger.
- 😊 high intensity:  
fast measurement,
- 😞 damage (esp. adsorbates!)

Secondary electron spectrum:  
Auger- $e^-$  are special  
secondary electrons.

# AES - basics

## Auger process (P. Auger, 1923)

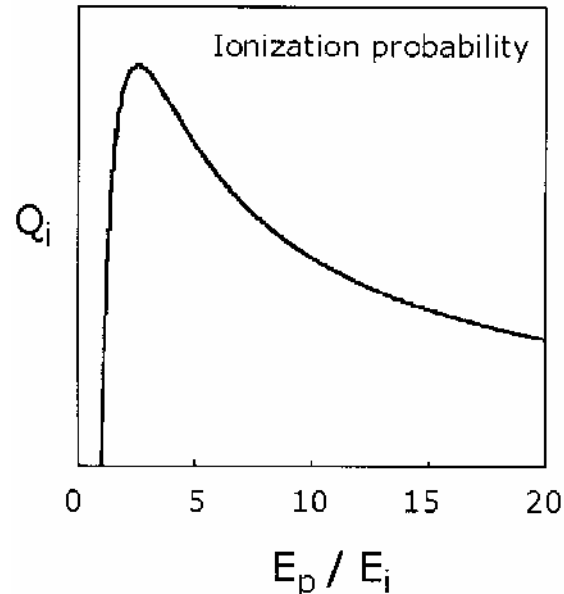
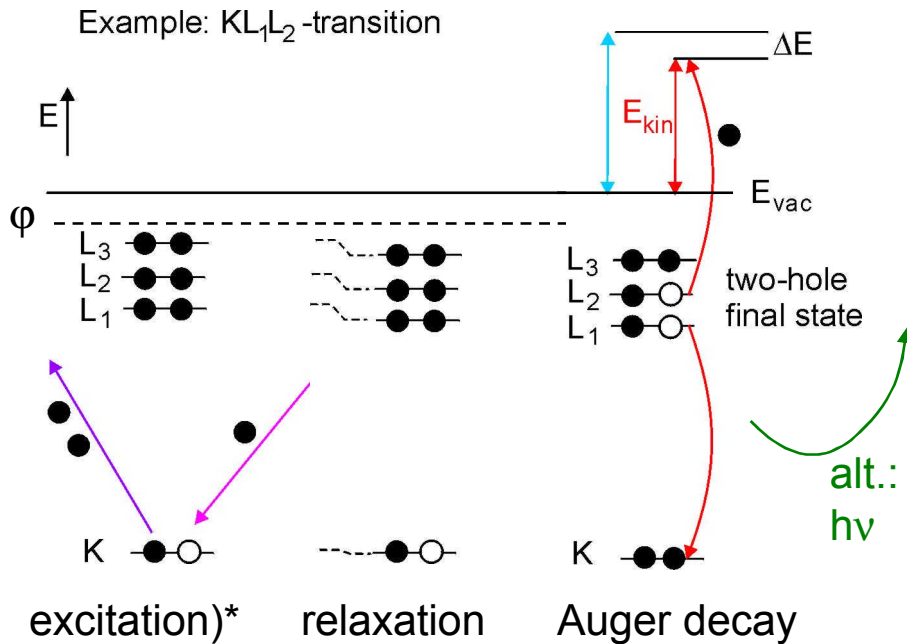

Prob. of core hole creation  
 $E_i$   $e^-$  binding E  
 $E_p$   $e^-$  impact E  
 (prim. E)

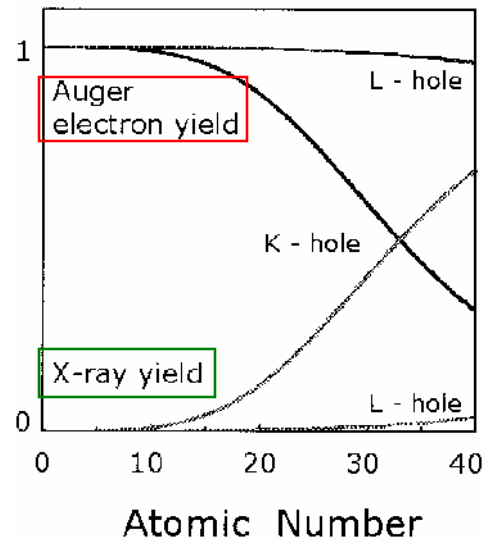

Auger decay preferred for light elements,  
 X-ray decay preferred for heavy elements

$E_{KLM}$  is independent of  $E_p$ . 😊  
 1st approx.:  
 $E_{KLM} = E_K - E_L - E_M - \Delta E - \phi$   
 $E_{KLM}$  kin. energy of Auger electron  
 $E_K$  binding energy of K-electron etc.  
 $\phi$  work function  
 $\Delta E$  relaxation shift

)\* core ionization may also occur by  
 X-ray photoionization ( $\Rightarrow$  XPS)

# AES - basics

Nomenclature:

1s	K	
2s	L <sub>1</sub>	
2p <sub>1/2</sub>	L <sub>2</sub>	
2p <sub>3/2</sub>	L <sub>3</sub>	
3s	M <sub>1</sub>	
3p <sub>1/2</sub>	M <sub>2</sub>	
3p <sub>3/2</sub>	M <sub>3</sub>	
3d <sub>3/2</sub>	M <sub>4</sub>	
3d <sub>5/2</sub>	M <sub>5</sub>	
etc.		

↑  
or V if  
valence  
band  
↓

Two-hole final state:  
no Auger peaks from  
H, He. ☹️

Insulating samples:  
charging problems.  
☹️

# AES – surface sensitivity

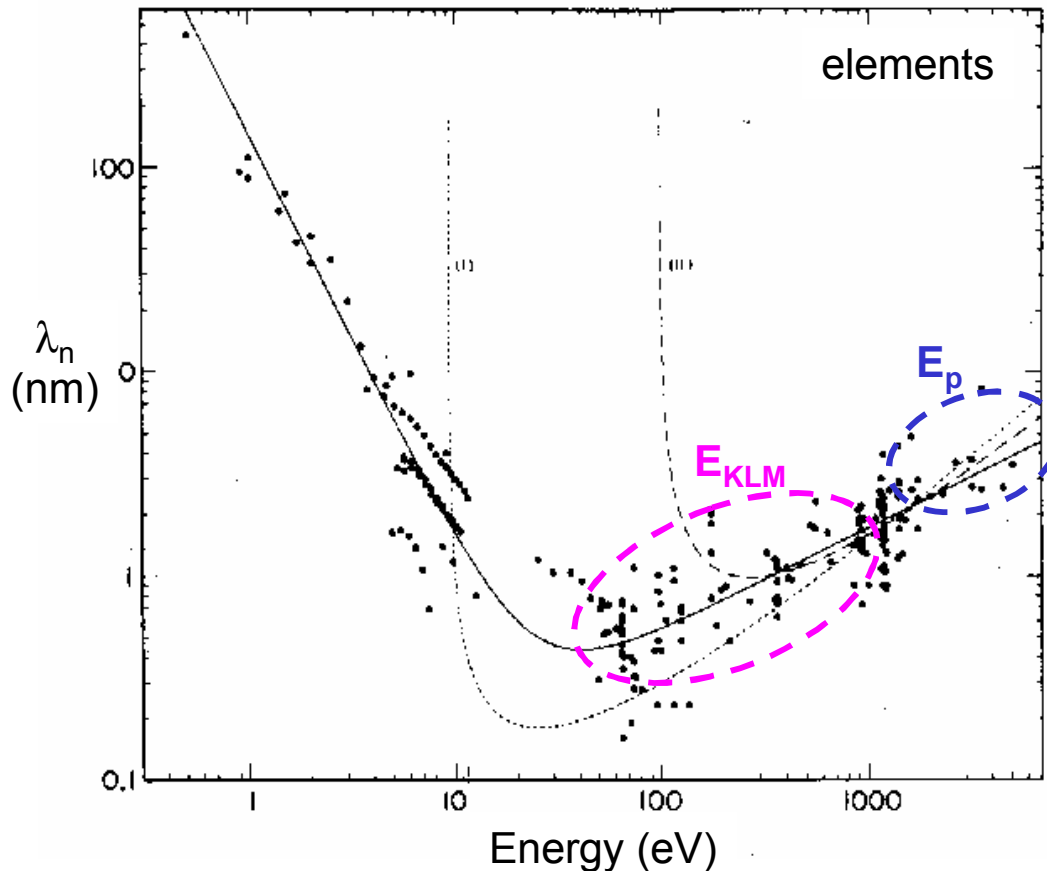

Inelastic electron mean free path  $\lambda$  for elements („universal curve“).

## Surface sensitivity:

- limited penetration depth of  $e_p$ ,
- limited escape depth of  $e_{KLM}$ , only ~0.5 nm at 100 eV (~2-3 ML)
- even higher surface sensitivity for grazing incidence / escape

full curve:

$$I_n = A_n/E^2 + B_n E^{1/2}$$

elements:

$$A_n = 143, B_n = 0.054$$

inorg. compounds:

$$A_n = 641, B_n = 0.096$$

org. compounds:

$$A_n = 31, B_n = 0.087$$

[M.P. Seah, W.A. Dench  
Surf. Interf. Anal. 1, 1 (1979).]

# AES – electron energy analysis

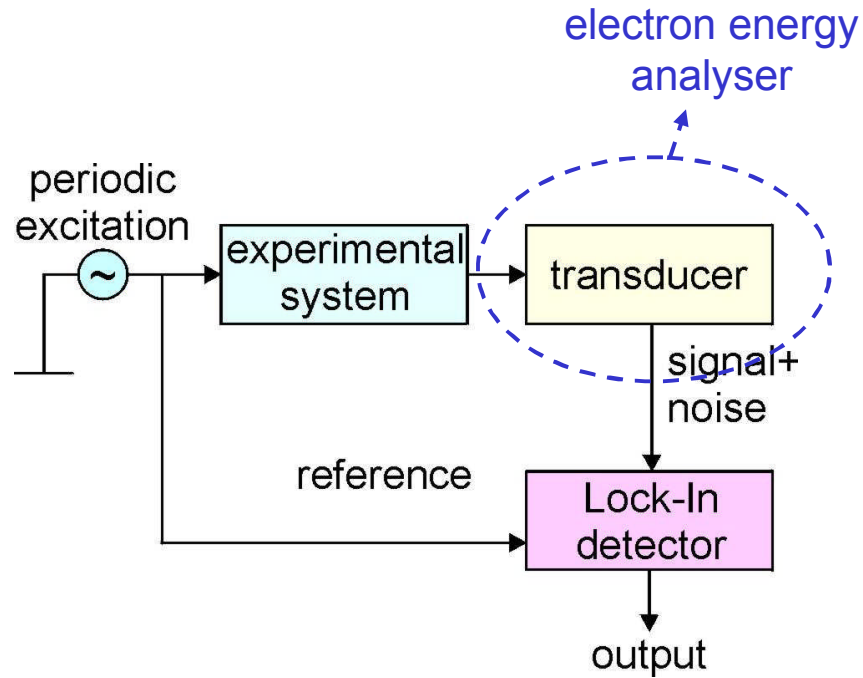

# AES – electron energy analysis

## Example: CMA

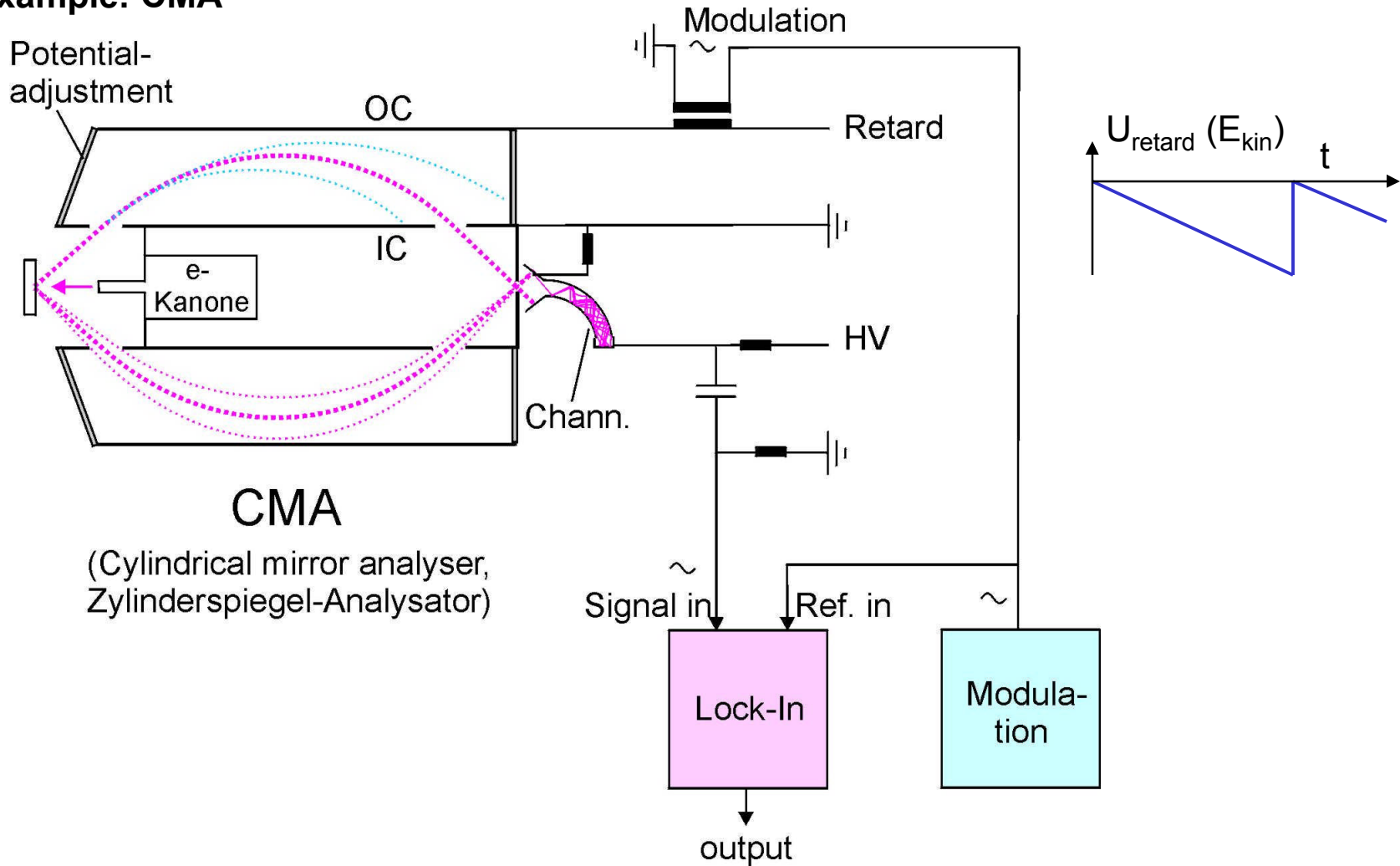

**CMA**  
(Cylindrical mirror analyser,  
Zylinderspiegel-Analysator)

Other analyser types: Hemispherical analyser  
Cylindrical sector analyser,  
Retarding field analyser (LEED optics)



# AES – modulation method

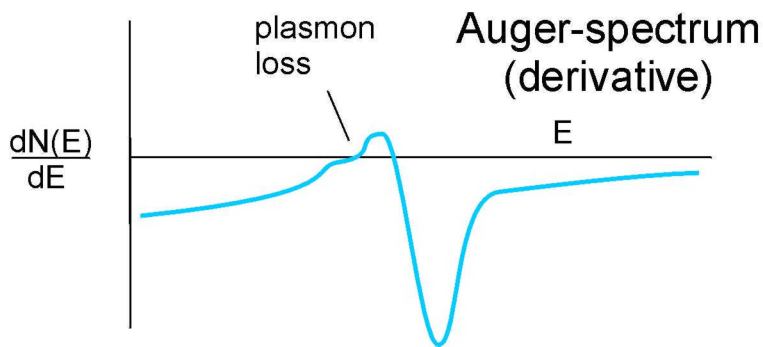
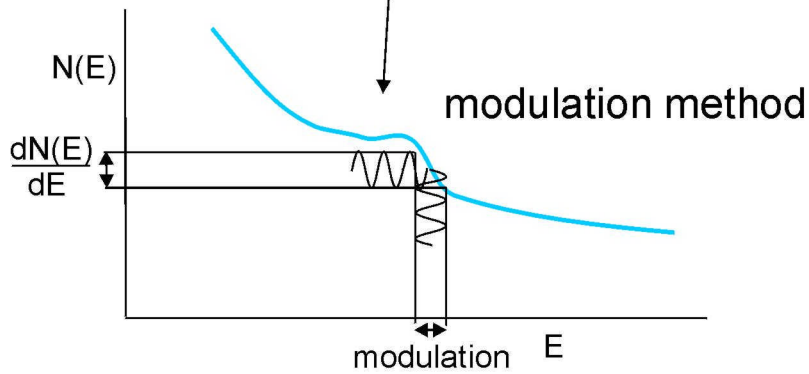
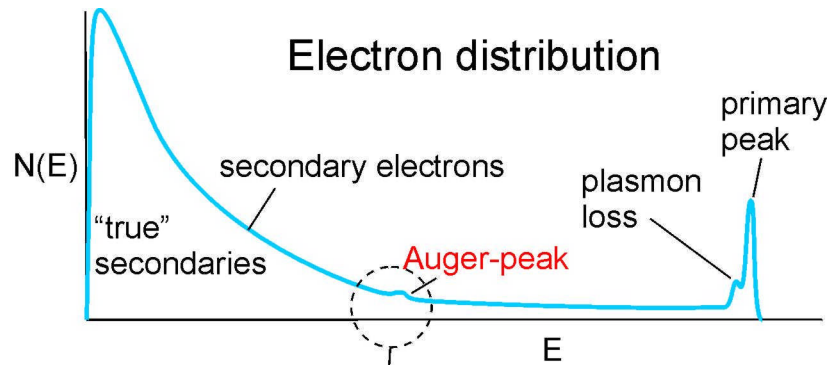

Problem: small signal on high background, noise  $\sim \sqrt{N}$

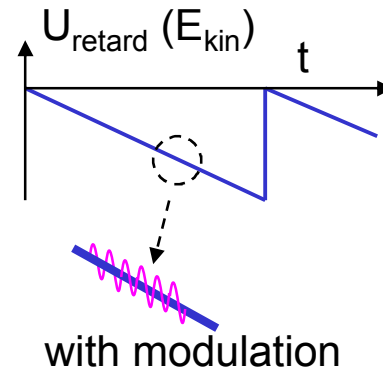
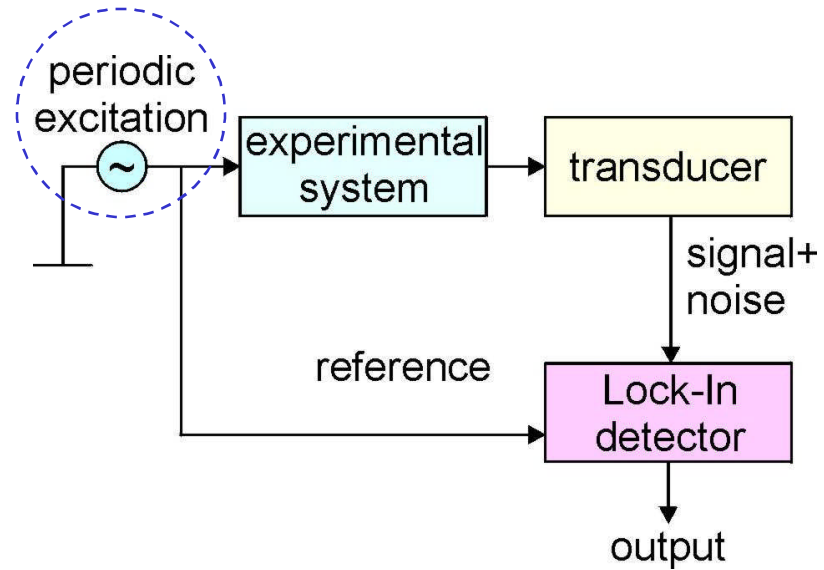

# AES – modulation method

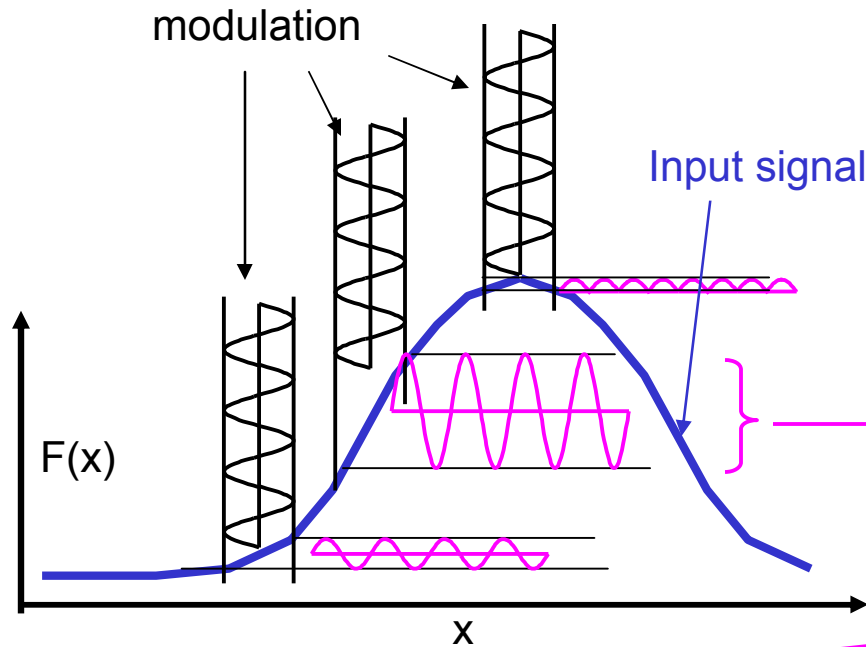

at signal maximum:  
no signal at  $f_{\text{mod}}$   
but signal at  $2 f_{\text{mod}}$ !  
 =>  
 $2 f_{\text{mod}}$ -signal is  
 proportional to  
 curvature = 2<sup>nd</sup> derivative !

amplitude of  
 ac-signal  
 is prop. to  
 1<sup>st</sup> derivative  
 of  $F(x)$

Phase changes  
 by  $180^\circ$  when  
 going from  
 uphill to downhill:  
 Phase-sensitive  
 rectification:  
 Lock-In amplifier

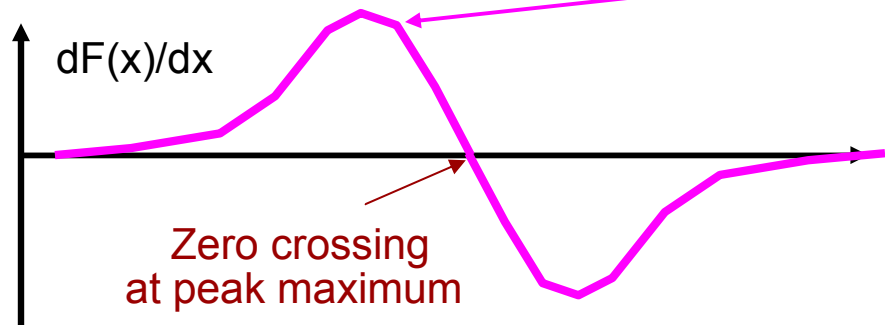

Lock-in  
 output  
 (derivative)

## AES – Lock-In technique

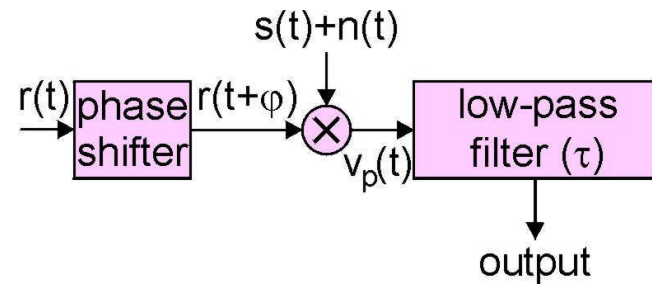
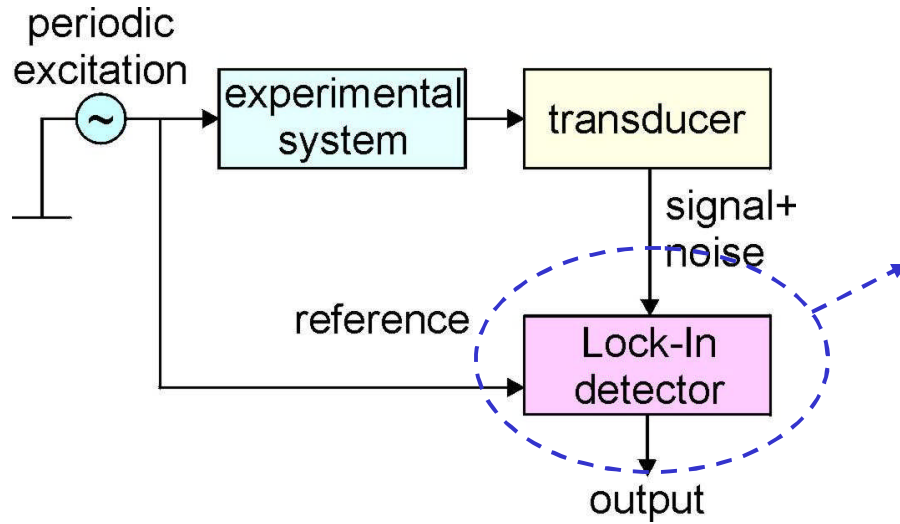

# AES – Lock-In technique

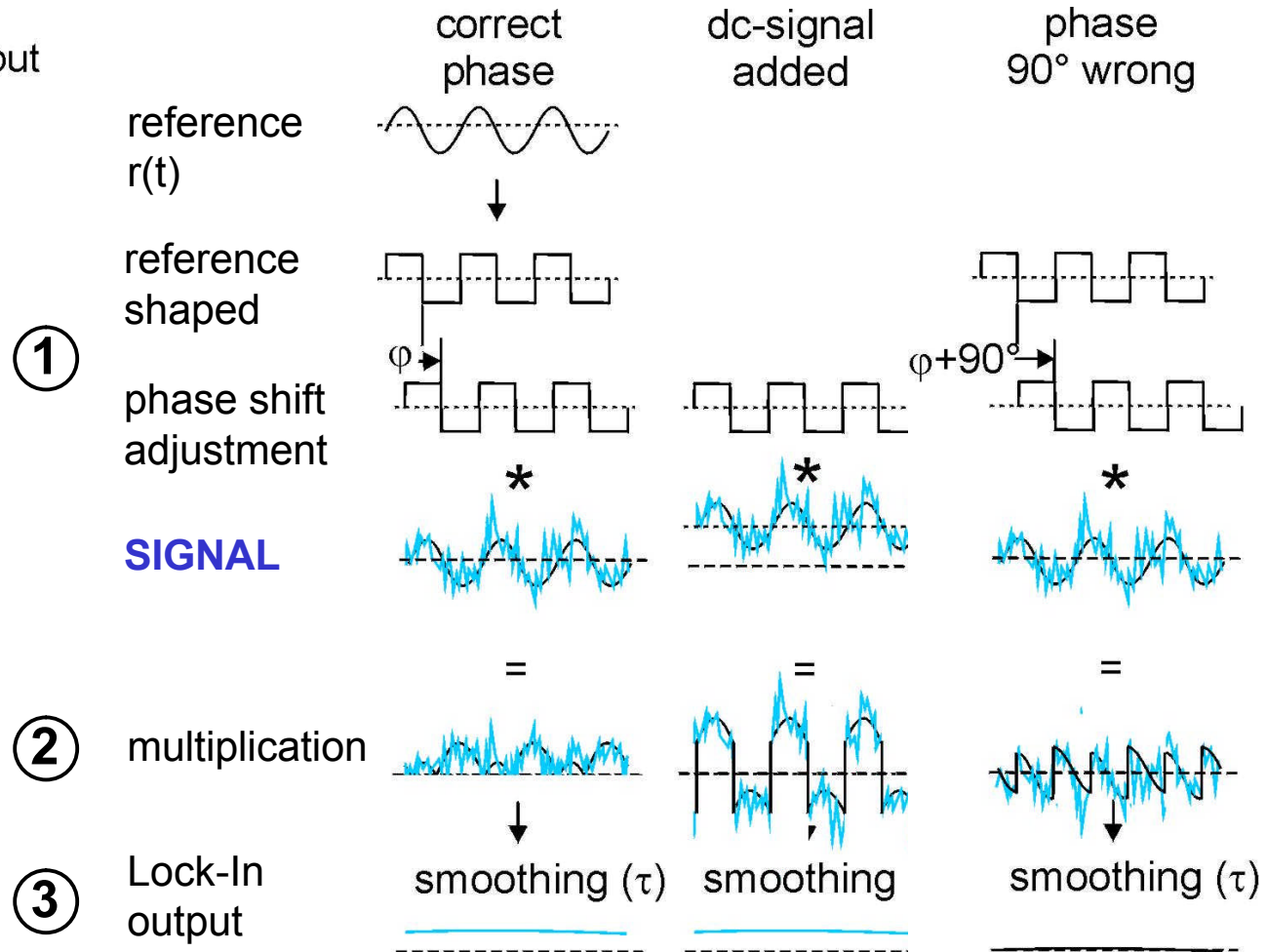
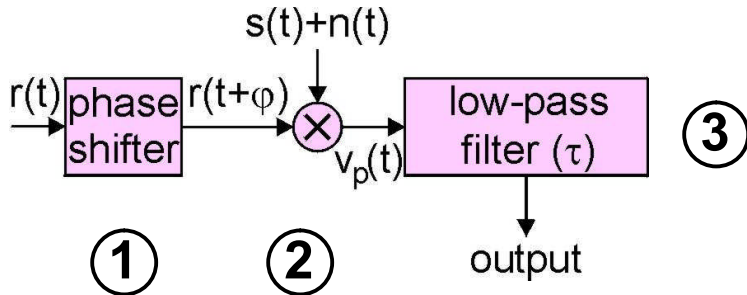

This example:  
S/N~1

Possible:  
up to  $S/N \sim 1/1000$

# AES – Lock-In technique

Lock-In:  
Amplification of  
odd harmonics

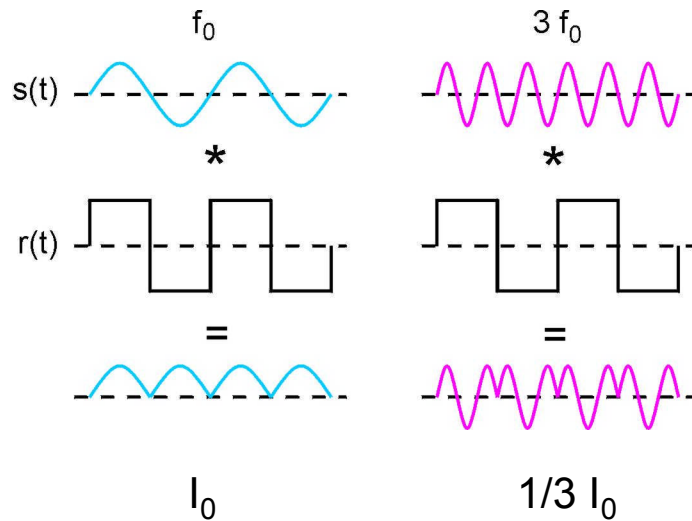

Suppression  
of odd harmonics  
by band-pass  
filter at LI-input

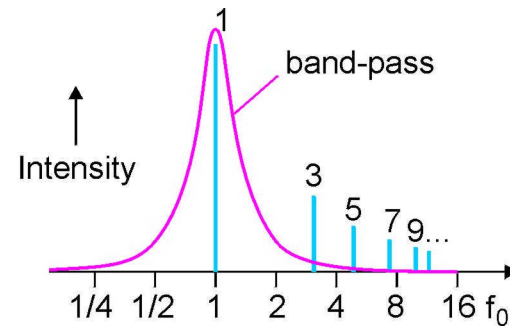

6 db or 12 db  
per octave

# AES – signal smoothing

## Low-pass filter

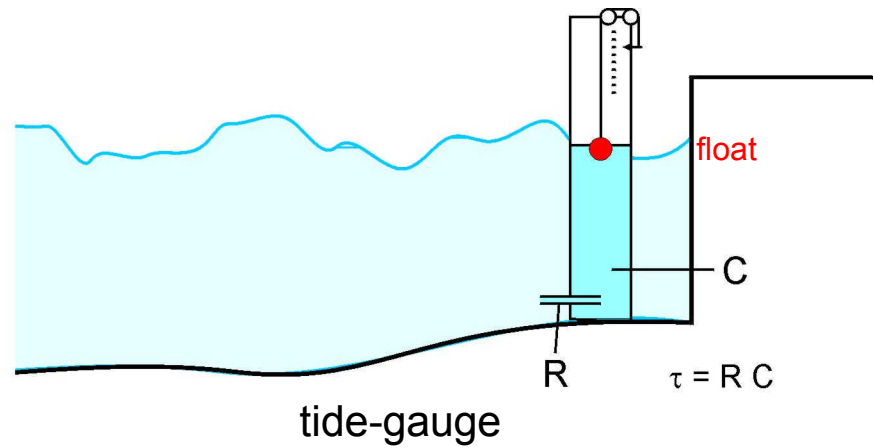
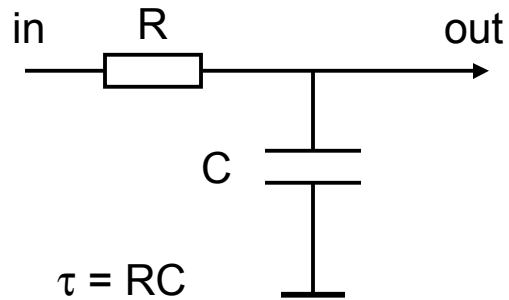

smoothed signal

- always lags behind (by  $\tau$ )
- cannot follow changes faster than  $1/\tau$

# AES – signal smearing

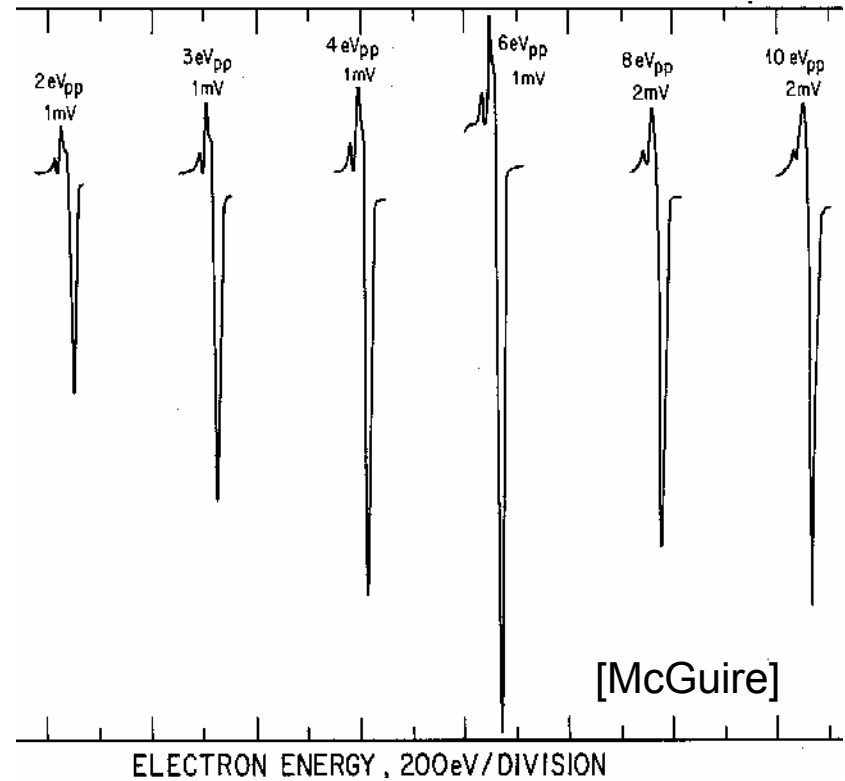
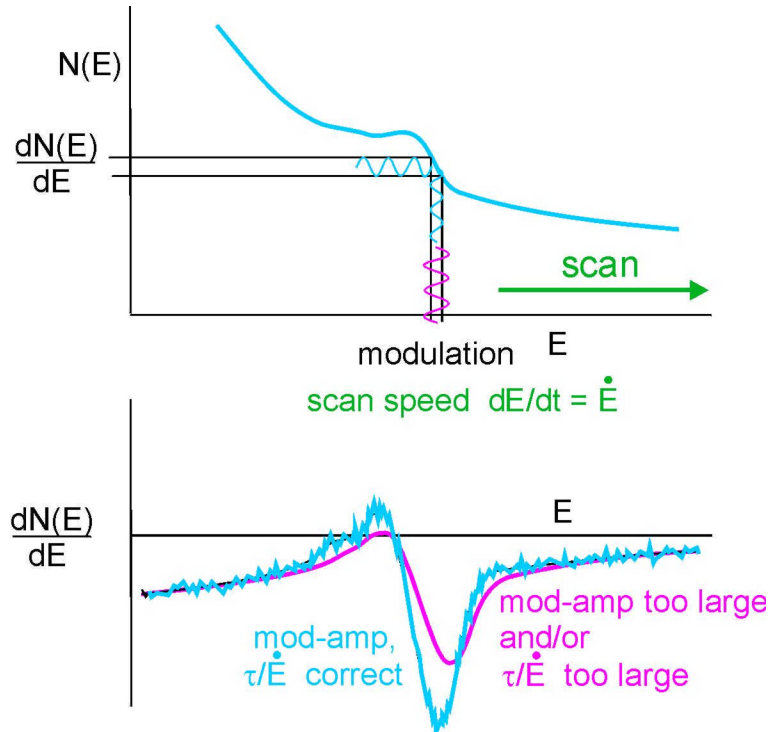

S/N ratio $\sim \tau$ For too high $\tau$ : smearing of structures	For <u>low enough</u> mod.-amp.: output $\sim$ mod.-amp. Then: smearing of structures
--	---

Find best compromise:	peak width : mod.-amp.
	S/N : $\tau$ vs. $dE/dt$

**Energy:**  
Position of (neg.) minimum in 1<sup>st</sup> derivative spectrum (easy to determine)

**Intensity:**  
Often peak-to-peak intensity  
Better minimum-to-zero-line intensity  
(less dependent on loss structure)



# AES – survey of peak positions

All 😊 elements have intense peaks between ~50 eV and ~1500 eV

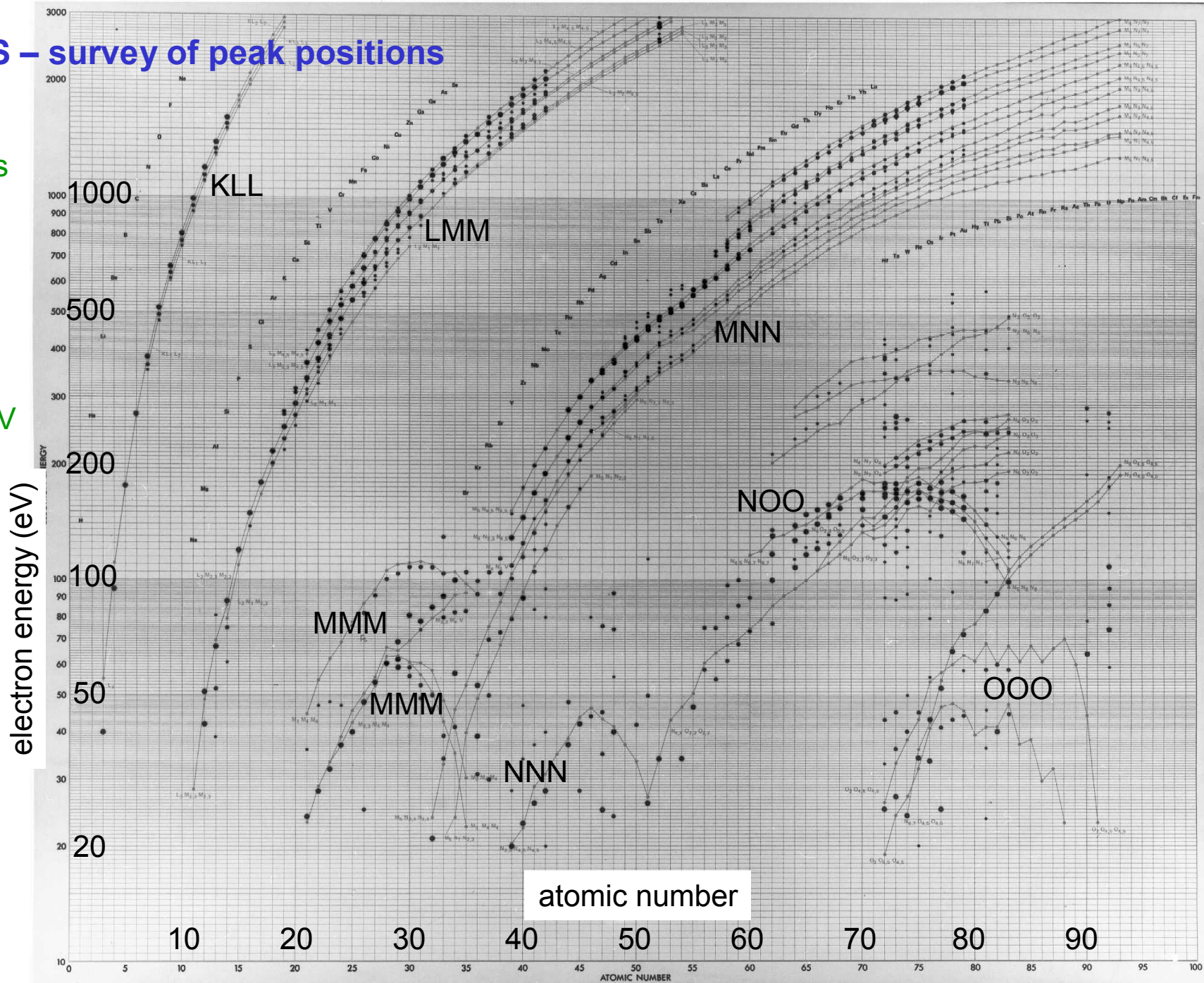



# AES – quantitative aspects

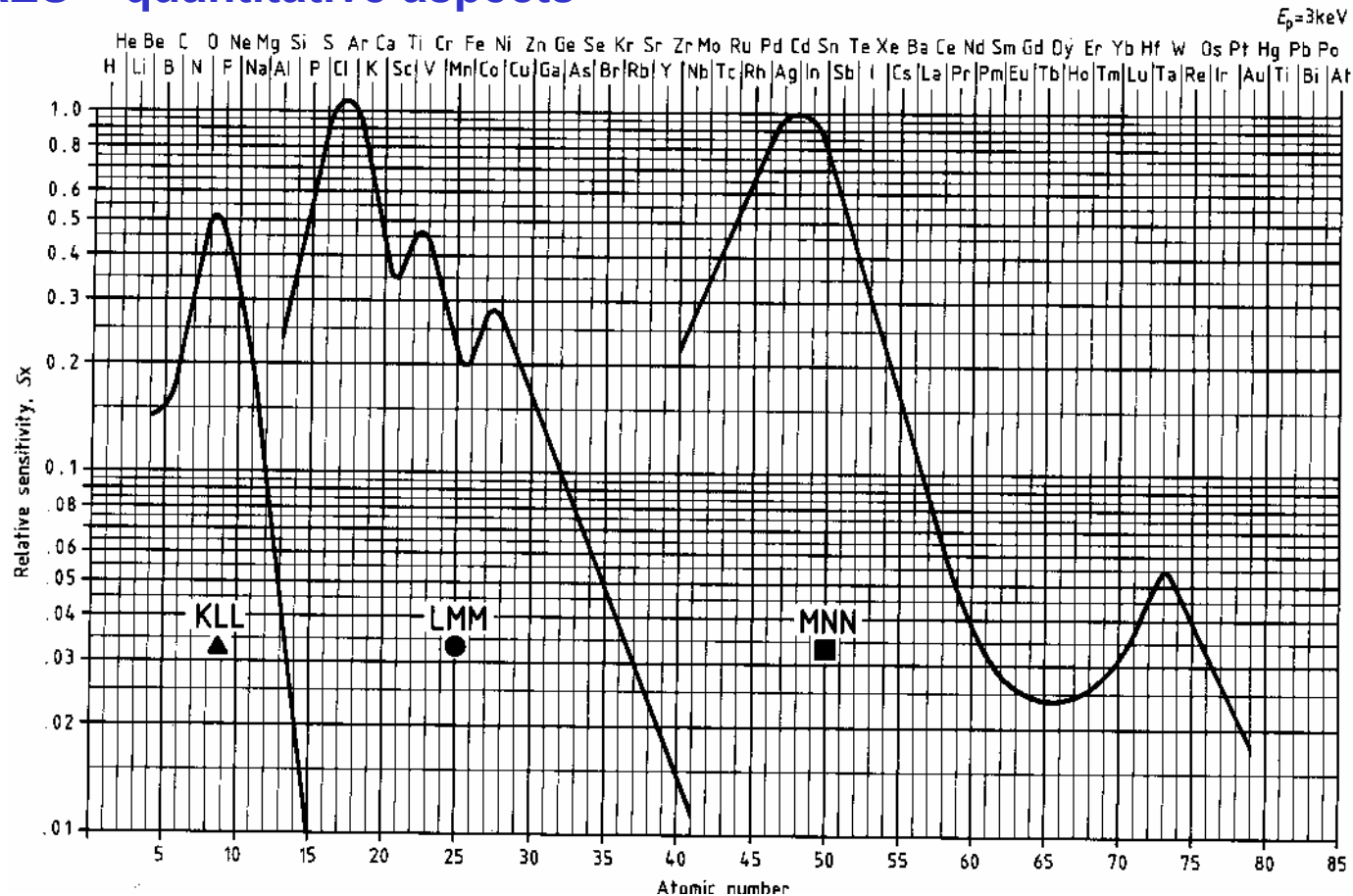

The sensitivity of peaks from all elements does not differ by more than a factor of 10 – 50. 😊

Relative sensitivity factors; attention: valid for certain experimental setup [Davis]

Two components:

$$x_A/x_B \approx \frac{J_A/J_{A0}}{J_B/J_{B0}} = \frac{J_A/S_A}{J_B/S_B}$$

$x_i$  molar fractions

$J_i$  measured intensities

$J_{i0}$  intensity of component alone

$S_i$  rel. sensitivity factors

## AES – quantitative aspects

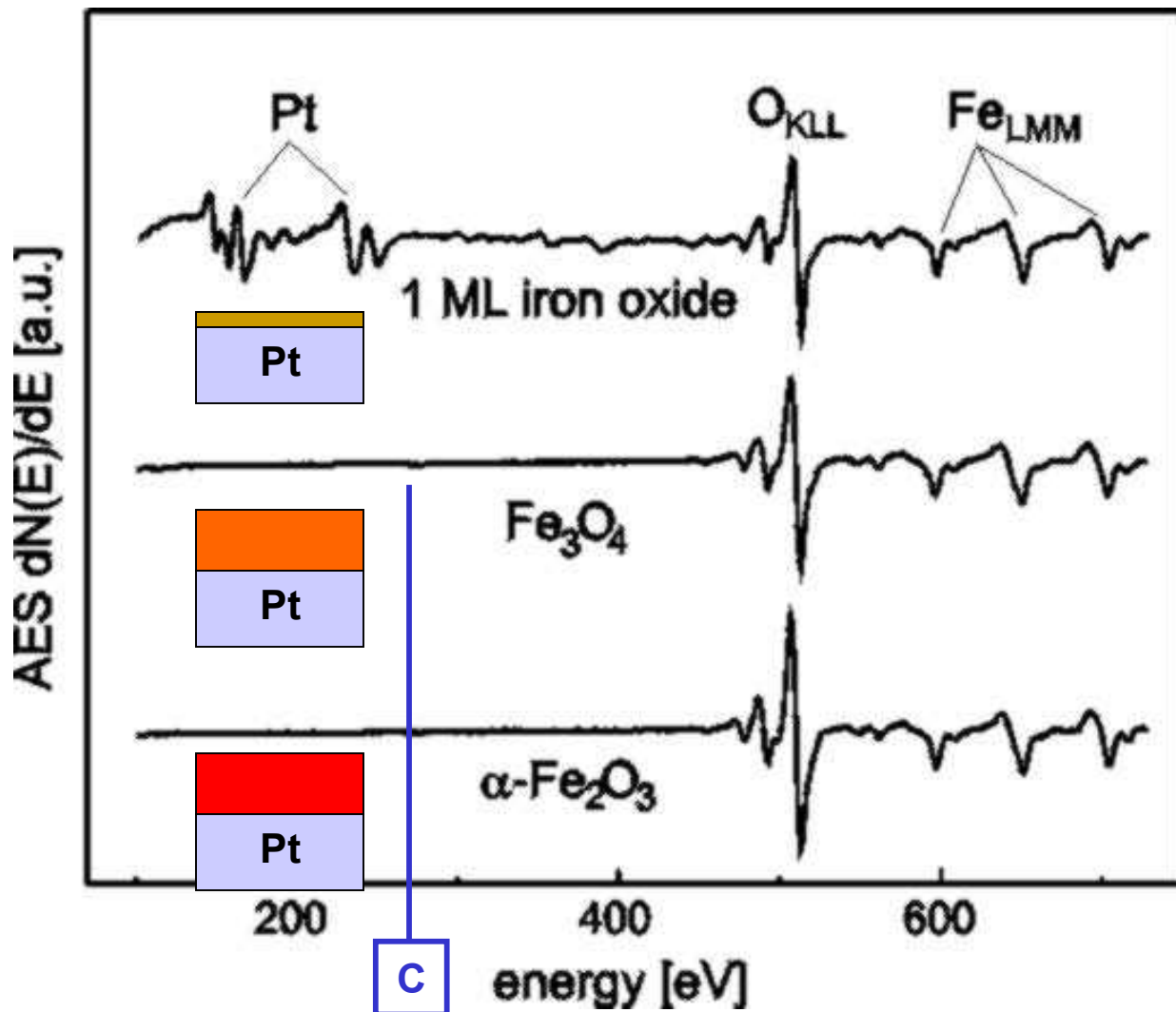

meas.	bulk compos.	derived
$J_{Fe}/J_O$	$x_{Fe}/x_O$	$S_{Fe}/S_O$
0.30	1 „too high“ O-signal explanation: O-terminated	0.3
0.28	0.75	0.37
0.25	0.67	0.37

Handbook:  
0.4

„Auger-clean“

Spectrum appears free of C-peak.  
Actually: noise  $\approx$  3% of O-peak intensity  
 $\rightarrow J_C \leq 3\%$  of  $J_O$  or  $\sim 6\%$  of  $(J_O + J_{Fe})$

Measure with high S/N,  
(slow speed)

# AES – quantitative aspects

example: oxygen

Same signal for

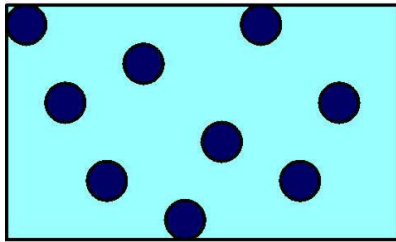

bulk content 15 %

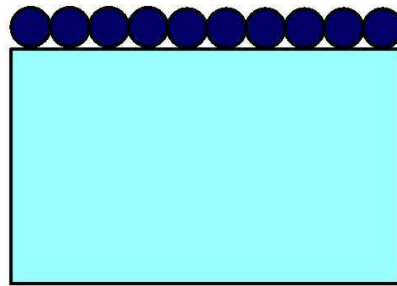

1 ML

## Continuous layer

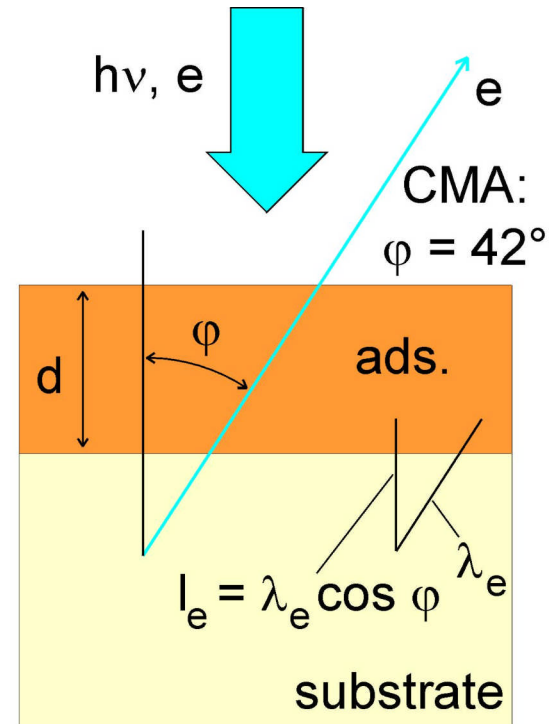

$$J_{\text{sub}} = J_{0,\text{sub}} \exp(-d/l_{e,\text{sub}})$$

$$J_{\text{ad}} = J_{0,\text{ad}} (1 - \exp(-d/l_{e,\text{ad}}))$$

(extinction law)

# AES – quantitative aspects

## Discrete layer model

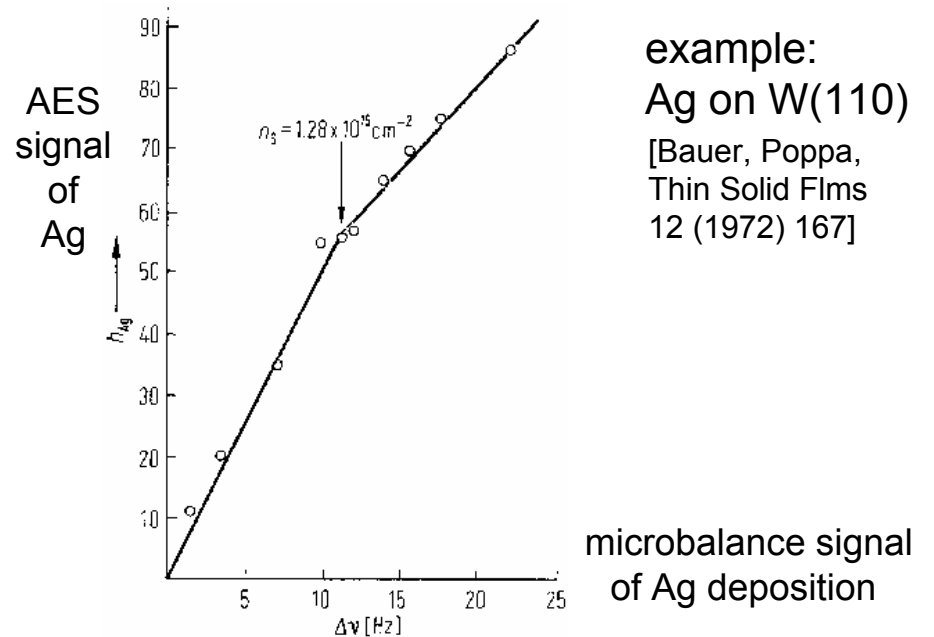
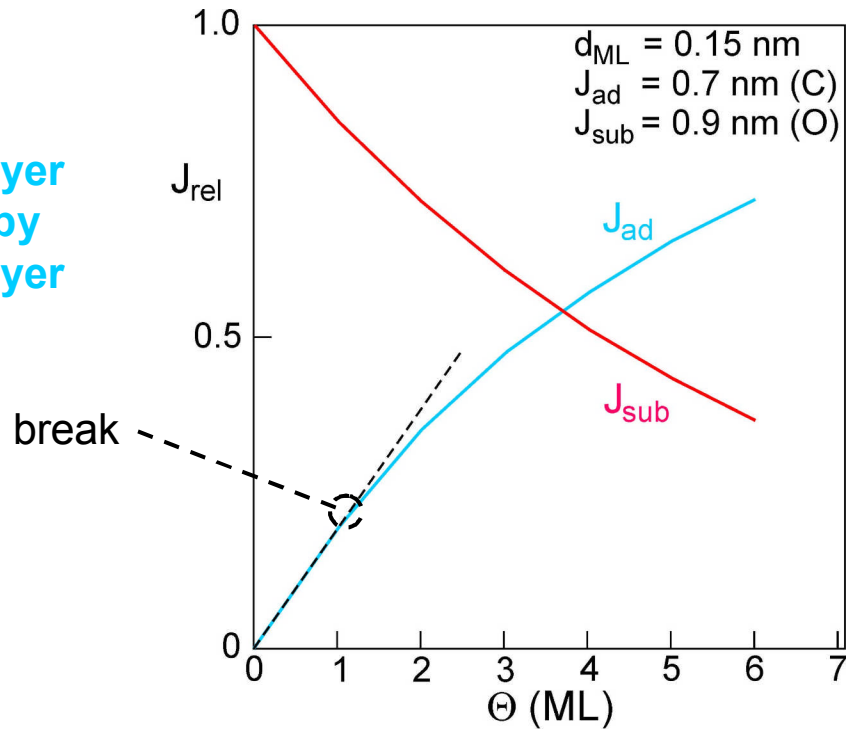
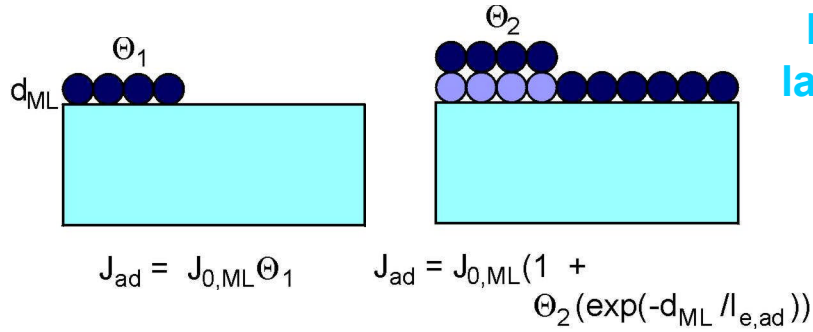

# AES – quantitative aspects

## Discrete layer model

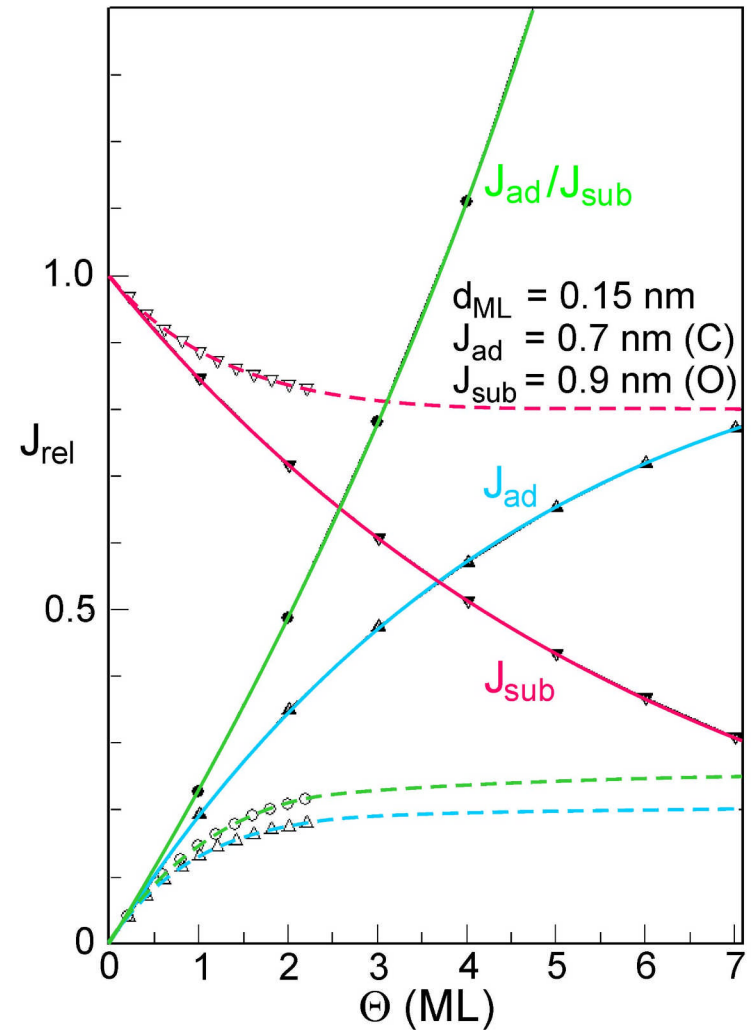
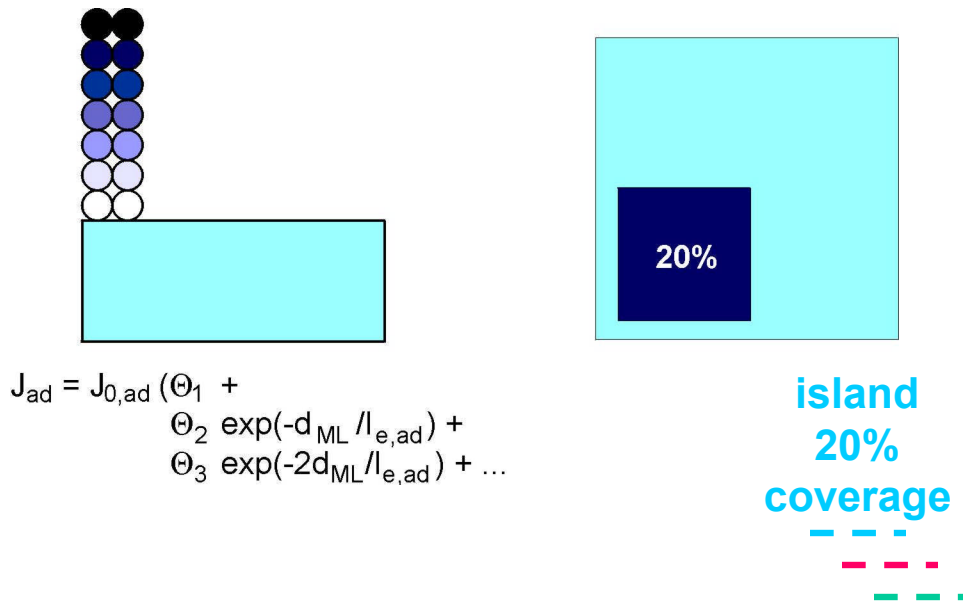
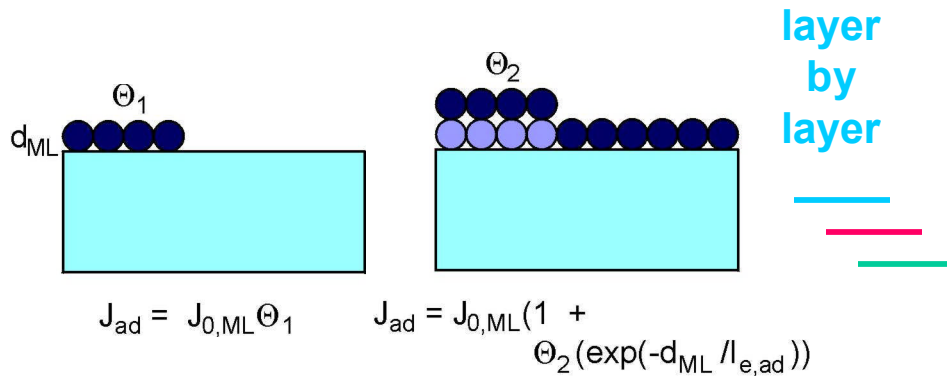

# AES – Peak shapes

Especially if the (wide) valence band is involved, peaks are wide and contain valence band structure.

Example  $Si_{L_{VV}}$  peak: self-folding of V-band, chemical (and relaxation?) shifts.

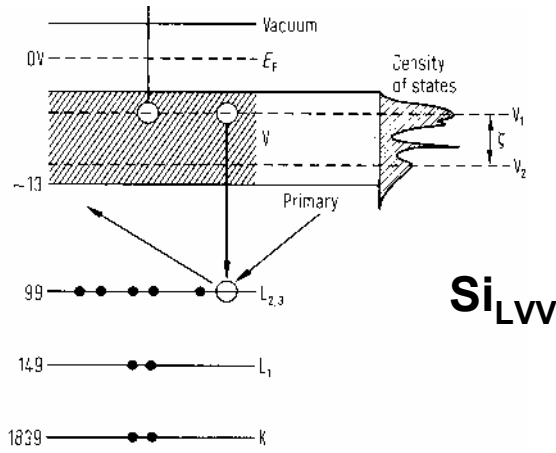

[Ertl, Küppers, fig. 2.13]

[Ertl, Küppers, fig. 2.31]

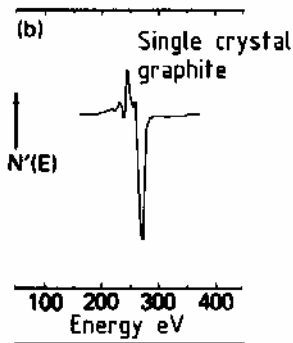
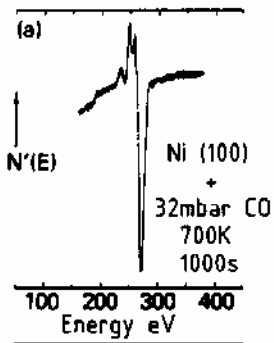
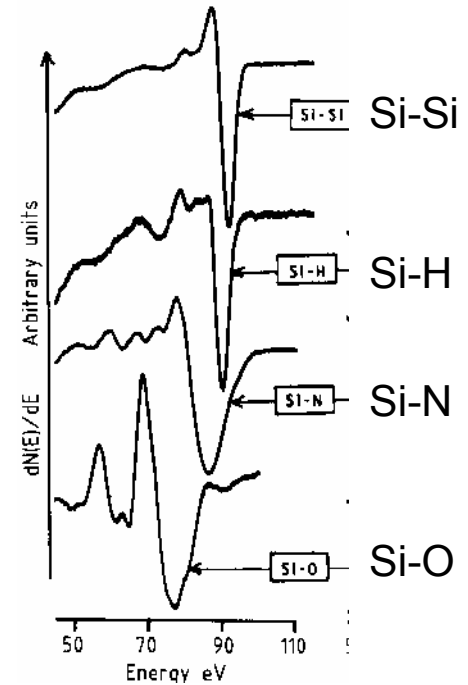

$C_{KVV}$

graphitic ( $sp^2$ )

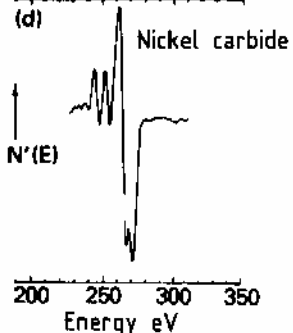
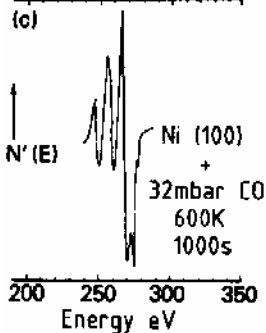

carbide ( $sp^3$ )

[Ertl, Küppers, fig. 2.33]

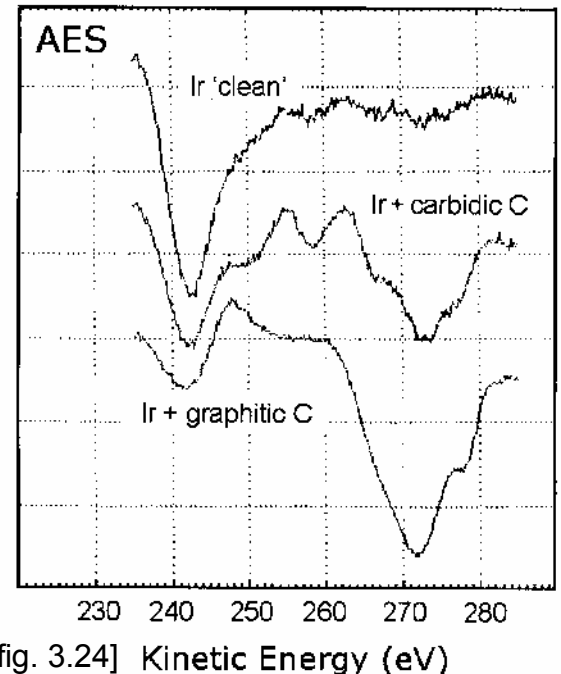

[Niemantsverdriet, fig. 3.24]

# AES – Peak shapes

## electron stimulated oxidation of GaAs

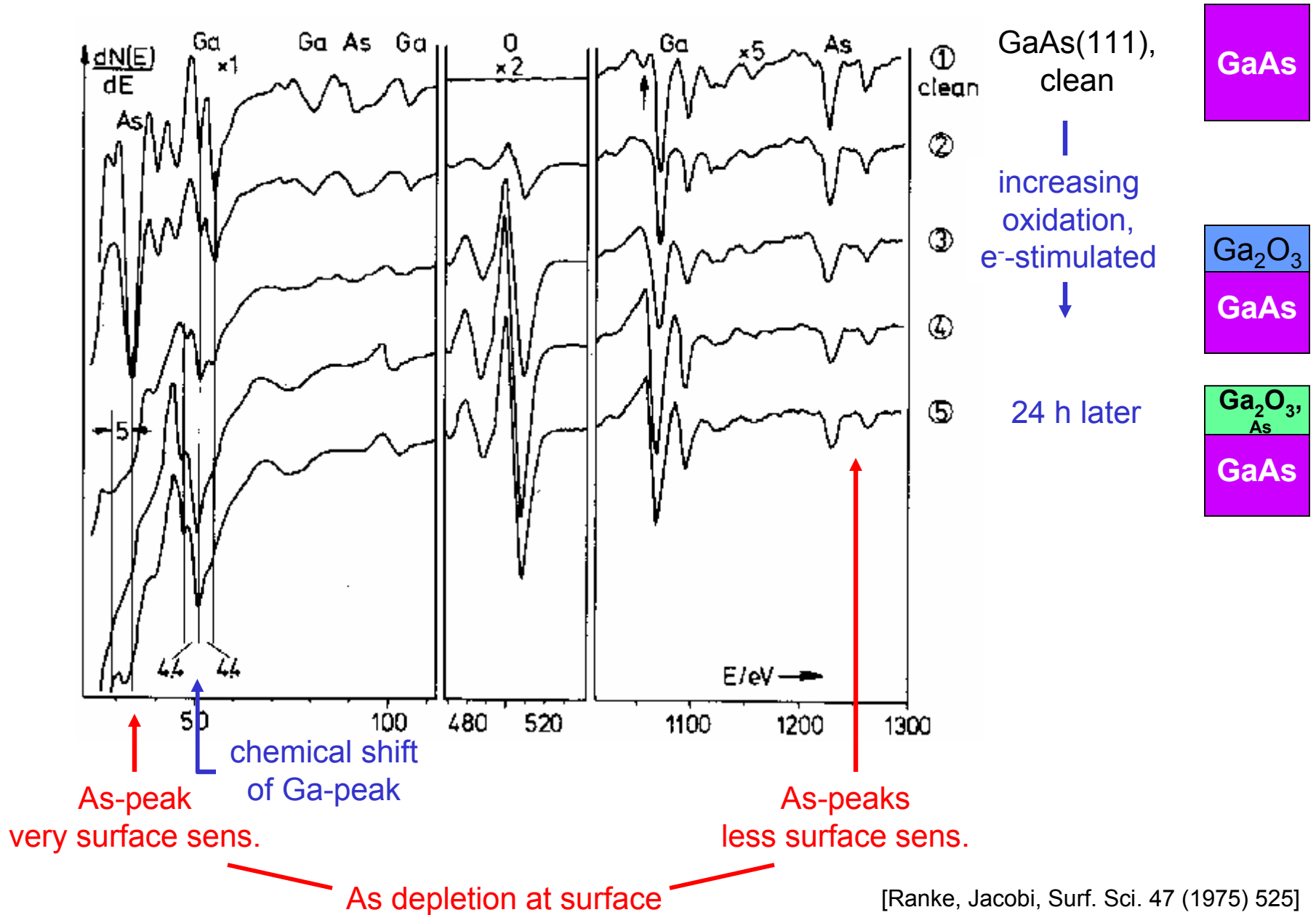

## AES – electron beam influence

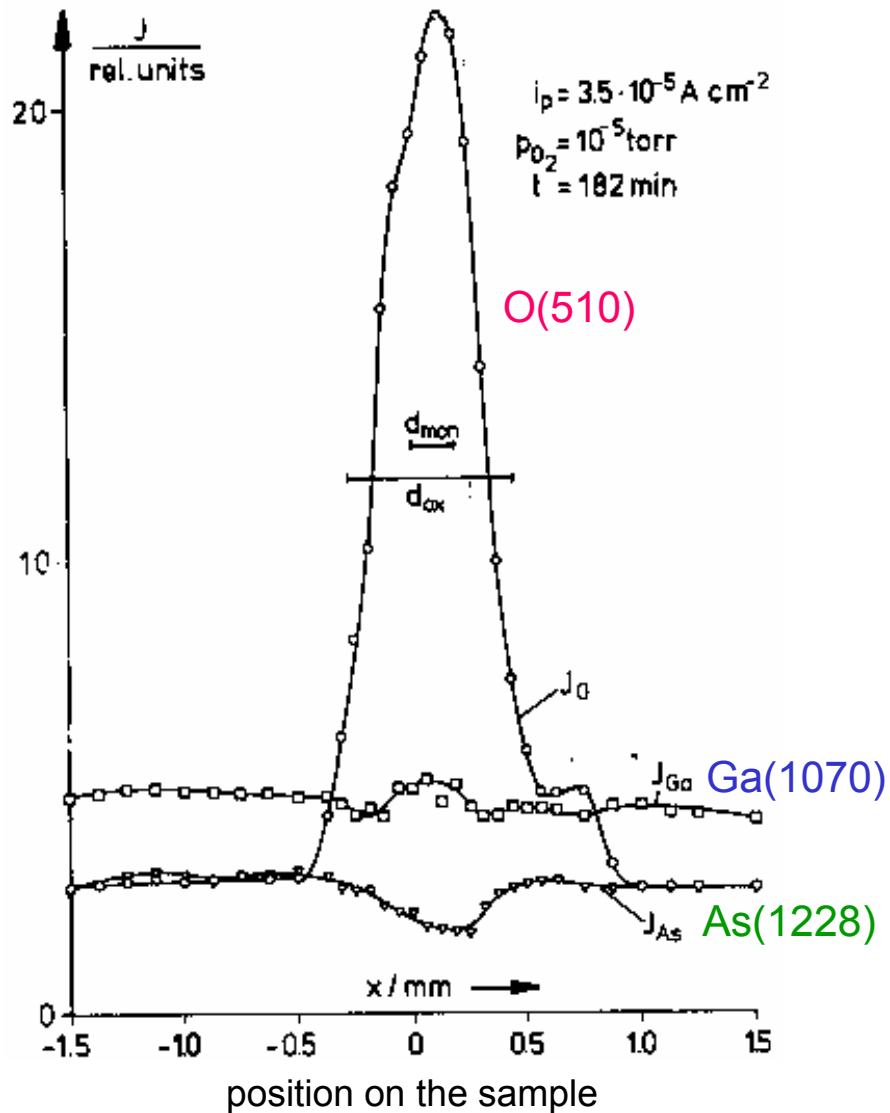

## Example: GaAs(111)-Ga

AES during oxygen admission causes strongly enhanced adsorption on the spot irradiated by electrons: electron-stimulated oxidation.

In the center of the beam, As is depleted and Ga enriched:

$\text{As}_2\text{O}_5$  desorbs (high vapor pressure)  
 $\text{Ga}_2\text{O}_3$  remains.

Probable reason:  
 $e^-$ -induced dissociation of molecularly adsorbed  $\text{O}_2$ .



## AES – electron beam influence

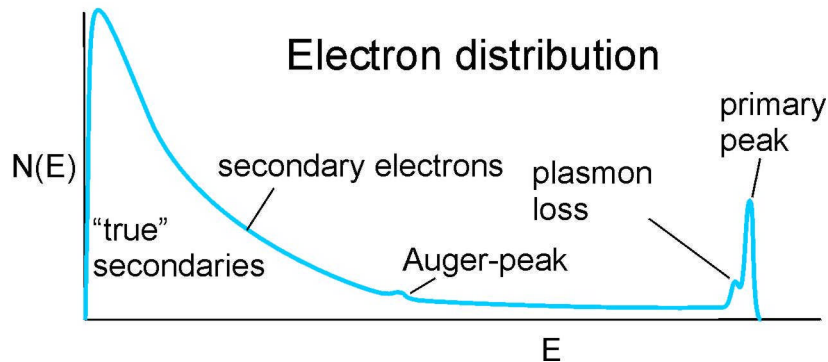
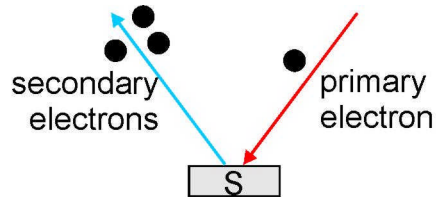

Responsible:

All  $e^-$  with sufficient energy,  
i.e. mainly secondaries.

AES: primary  $e^-$  cause many secondaries  
strongly „destructive“.

XPS, UPS: primary radiation causes less secondaries  
less destructive.

Adsorbates may be  
decomposed and  
(partially) desorb

Affects quantitative analysis.

Substrate usually unaffected.



## AES – Conclusions

- UHV-method
- elemental analysis
- comparatively simple
- independent of excitation energy
- difficult for insulating materials
- surface sensitive (0.4 – 2 nm)
- qualitative analysis simple
- quantitative analysis possible
- destructive (for molecular adsorbates)
- chemical information

[ranke@fhi-berlin.mpg.de](mailto:ranke@fhi-berlin.mpg.de)