

Can gravitational instantons really constrain axion inflation?

Arthur Hebecker,^a Patrick Mangat,^a Stefan Theisen^b and Lukas T. Witkowski^a

^a*Institut für Theoretische Physik, Universität Heidelberg,
Philosophenweg 19, D-69120 Heidelberg, Germany*

^b*Max-Planck-Institut für Gravitationsphysik,
Albert-Einstein-Institut, 14476 Golm, Germany*

E-mail: a.hebecker@thphys.uni-heidelberg.de,
p.mangat@thphys.uni-heidelberg.de, stefan.theisen@aei.mpg.de,
lwitkow@apc.in2p3.fr

ABSTRACT: Axions play a central role in inflationary model building and other cosmological applications. This is mainly due to their flat potential, which is protected by a global shift symmetry. However, quantum gravity is known to break global symmetries, the crucial effect in the present context being gravitational instantons or Giddings-Strominger wormholes. We attempt to quantify, as model-independently as possible, how large a scalar potential is induced by this general quantum gravity effect. We pay particular attention to the crucial issue which solutions can or cannot be trusted in the presence of a moduli-stabilisation and a Kaluza-Klein scale. An important conclusion is that, due to specific numerical prefactors, the effect is surprisingly small even in UV-completions with the highest possible scale offered by string theory.

As we go along, we discuss in detail Euclidean wormholes, cored and extremal instantons, and how the latter arise from 5d Reissner-Nordström black holes. We attempt to dispel possible doubts that wormholes contribute to the scalar potential by an explicit calculation. We analyse the role of stabilised dilaton-like moduli. Finally, we argue that Euclidean wormholes may be the objects satisfying the Weak Gravity Conjecture extended to instantons.

KEYWORDS: Strings and branes phenomenology

ARXIV EPRINT: [1607.06814](https://arxiv.org/abs/1607.06814)

Contents

1	Introduction and summary of results	2
2	Gravitational instanton solutions	5
2.1	Dualisation	6
2.2	Gravitational instantons in the presence of a massless scalar field	9
2.3	Interpretation of the integration constant K_+	14
3	Instanton potentials from Euclidean wormholes	18
4	The limit of validity of gravitational instanton actions	26
5	Gravitational instantons and moduli stabilisation	30
5.1	Gravitational instantons in the presence of a potential	31
5.2	Dilaton couplings from string compactifications	33
5.3	Maximal field displacements of dilatonic fields	35
6	Consequences for large field inflation	37
6.1	Action of the most ‘dangerous’ gravitational instantons	37
6.2	Estimating the critical radius r_c	39
7	Gravitational instantons and the weak gravity conjecture	40
8	Conclusions and outlook	44
A	Derivation of the metric structure of gravitational instantons	46
B	Charge quantisation	47
C	Dualisation under the path integral	48
D	Analytical solutions to Einstein’s equation	50
E	Computation of the instanton action	51
F	Estimating the size of the prefactor \mathcal{A} in the instanton potential	53

1 Introduction and summary of results

Slow-roll inflation relies on flat scalar potentials, making axion-like fields ideal inflaton candidates. This is especially true in the context of large-field inflation. The latter is of particular interest since, on the one hand, it is arguably the most natural form of inflation and, on the other hand, it will be discovered or experimentally ruled out in the foreseeable future.

The flatness of axion potentials (we denote the axion henceforth by θ) is protected by a shift symmetry which is only broken non-perturbatively, i.e. by instantons. However, possible problems with consistently embedding axionic models of inflation in quantum gravity are an issue of continuing concern [1–27]. In particular, the focus has recently been on the Weak Gravity Conjecture [3]. In the context of axions, it states that with growing axion decay constant f_{ax} the action S of the ‘lightest’ instanton decreases, such that the flatness of the potential is spoiled by corrections $\sim \exp(-S)$.

However, the Weak Gravity Conjecture has not been firmly established. In particular, its validity remains unclear outside the domain of UV completions of quantum gravity provided by the presently understood string compactifications. This is even more true for the extension to axions. Moreover, the prefactors of the $\exp(-S)$ corrections mentioned above may be parametrically small, especially if SUSY or the opening up of extra dimensions come to rescue just above the inflationary Hubble scale.

Thus, it is useful to pursue the related but complementary approach of constraining axionic potentials on the basis of gravitational instantons. Indeed, the very fundamental statement that quantum gravity forbids global symmetries is, in the context of shift symmetries, explicitly realised by instantonic saddle points of the path integral of Euclidean quantum gravity. These are also known as Giddings-Strominger wormholes [28]. If, as proposed in [9], gravitational instantons yield significant contributions to the axion potential, some models of natural inflation would be under pressure (at least those with one or only few axions like alignment scenarios), while axion-monodromy inflation models seem to be unaffected.¹ It is our goal to study the effect of Euclidean wormholes and that of related instantonic solutions in detail. In particular, in the spirit of what was said above, we want to be as model-independent and general as possible, ideally relying only on Einstein gravity and the additional axion. The goal is to constrain large classes of string models or even any model with a consistent UV completion. As we go along, we will however be forced to consider certain model-dependent features and take inspiration from the known part of the string theory landscape.

The aim of this paper is thus to determine the strongest constraints on axion inflation due to gravitational instantons. One important aspect of our analysis is that — to be as model-independent as possible — calculations are performed in an effective 4-dimensional Einstein-axion(-dilaton) theory. However, this theory is only valid up to an energy-scale

¹Natural inflation [29] with one axion requires a transplanckian axion field space. Ideas for realising natural inflation in a subplanckian field space of multiple axions were proposed in [30–33]. For models implementing these ideas see e.g. [12, 34–53]. Axion monodromy inflation was introduced in [54, 55] (for a field theory implementation see [56, 57]). A realisation of this idea with enhanced theoretical control is F -term axion monodromy [58–60]. For further work in this context see [61–74].

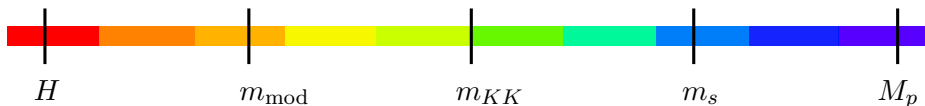

Figure 1. Hierarchy of scales in a string model of inflation.

Λ and, for consistency, we have to make sure that our analysis only includes gravitational instanton solutions within the range of validity of our effective theory.

This leads to the following challenge pointed out in [12] (see also [1]) and which we will repeat here. Given an energy cutoff Λ , gravitational instantons within the range of theoretical control contribute at most as $\delta V \sim e^{-S} \sim e^{-M_p^2/\Lambda^2}$ to the axion potential. Then, gravitational instantons are dangerous for inflation if their contribution to the potential is comparable to the energy density in the inflationary sector, i.e. $\delta V \sim H^2$. If the cutoff Λ is not much above H gravitational instantons are clearly harmless. However, if Λ is close to M_p gravitational instantons can easily disrupt inflation. As a result, the importance of gravitational instantons for inflation hinges on a good understanding of the scale Λ where the 4-dimensional Einstein-axion(-dilaton) theory breaks down.

To arrive at a quantitative expression for Λ requires some knowledge about the UV completion of our theory. Here, we take string theory as our model of a theory of quantum gravity, i.e. we assume that the effective Einstein-axion(-dilaton) theory is derived from string theory upon compactification. String compactifications give rise to a hierarchy of scales as shown in figure 1. Inflation is assumed to take place below the moduli scale m_{mod} where only gravity and one or more axions are dynamical. Above m_{mod} further scalars in the form of moduli become dynamical. As a result, if we want to work with a Einstein-axion theory the cutoff Λ is the moduli scale.

Here, we want to do better. An analysis using 4-dimensional gravitational instantons can in principle be valid up to the Kaluza-Klein (KK) scale m_{KK} , at which a description in terms of a 4-dimensional theory breaks down. However, to be able to go beyond m_{mod} we have to allow for dynamical moduli. Hence, for this purpose Einstein-axion theories are insufficient and we have to study gravitational instantons in Einstein-axion-moduli theories instead.

These considerations give rise to the following structure of our paper. We start by recalling the Giddings-Strominger or Euclidean wormhole solution [28] in section 2. This is a classical solution of the axion-gravity system which gives space-time a ‘handle’ with cross-section S^3 . In fact, this solution can be interpreted as a real saddle point of the path integral only in the dual 2-form theory. We take some care to describe the relevant subtleties of the dualisation procedure in subsection 2.1. Subsequently, we generalise to the case with an additional dilatonic scalar in subsection 2.2. Now extremal as well cored instanton solutions [17, 75] also exist. The situation with a dilaton is important for us as a model of the realistic string-phenomenology case with light moduli. Subsection 2.3 focusses on the way in which cored and extremal gravitational instantons may arise from a Euclidean black 0-brane in an underlying 5d theory. In this way we obtain a UV-completion of cored and extremal gravitational instantons, which can then be understood by parameters of the 5d theory.

Section 3 is devoted to the crucial issue whether a scalar potential is induced by Euclidean wormholes. We will provide an explicit computation of the contributions to the axion potential from Euclidean wormholes. Thereby, we describe how to circumvent a recent counter-argument given in [17], suggesting that Euclidean wormholes could not break the axionic shift-symmetry. Thus, we stress that Euclidean wormholes are by no means less important than cored or extremal gravitational instantons.

In section 4 we calculate the instanton actions for Euclidean wormholes as well as for cored and extremal gravitational instantons. We also give a quantitative answer to the question which gravitational instantons can be trusted within our effective theory with cutoff Λ . The result is as follows. As in the case of gauge instantons one can associate gravitational instantons with an instanton number n . Given an energy cutoff Λ one can then only trust gravitational instantons with a sufficiently high instanton number $n \gg f_{\text{ax}} M_p / \Lambda^2$, where f_{ax} is the axion decay constant.²

In section 5 we take first steps towards studying gravitational instantons in the presence of dynamical moduli. We argue that the case with one light modulus coupled to the Einstein-axion theory can be modelled by an Einstein-axion-dilaton theory with massless dilaton. For one, in subsection 5.1 we show that for our purposes the modulus potential can be neglected if there is a sufficient hierarchy between the modulus mass and the cutoff Λ . The reason is that deep inside the ‘throat’ of a gravitational instanton the modulus mass only gives a subleading contribution to the stress-energy tensor, while curvature and gradient terms dominate. As this region is also the source of the dominant part of the instanton action, we conclude that the action obtained for a massless modulus will remain a good approximation even in the massive case. We then motivate our restriction to moduli with dilatonic couplings. This implies that the modulus φ is coupled to the axion θ through the kinetic term for the axion as $e^{\alpha\varphi}(\partial\theta)^2$. In subsection 5.2 we review that dilatonic couplings arise frequently in string compactification.

In section 6 we analyse possible constraints for inflation due to gravitational instantons. To this end we identify the instantons with the largest contributions to the axion potential in subsection 6.1. We arrive at the strongest constraint if the cutoff Λ is as high as possible. In subsection 6.2 we identify the highest possible cutoff Λ_{max} for an effective 4-dimensional theory arising from a string compactification. This is given by the KK scale of a compactification with smallest possible compactification volume, which we take as the self-dual volume under T-duality. Unfortunately, there is an ambiguity in this definition of Λ_{max} up to factors of π , which can be crucial. We then determine the maximal contribution δV to the axion potential due to gravitational instantons and compare this to the scale of inflation in models of large-field axion inflation. Our main result is as follows. We find that gravitational instantons do not give rise to strong *model-independent* constraints on axion inflation. Extremal gravitational instantons may be important for inflation, but this is model-dependent, as the size of their contribution depends on the value of the dilaton coupling α .

²Note that this implies that we neglect potentially more severe, but incalculable contributions due to instantons with low instanton numbers.

Last, in section 7 we record some observations regarding the Weak Gravity Conjecture (WGC) [3] in the context of gravitational instantons. We pick up the idea from [17] that extremal instantons play the role extremal charged black holes for the WGC. We then find that the WGC appears to be satisfied due to the existence of Euclidean wormholes. This either hints at a realisation of the WGC in the context of gravitational instantons, or implies a different definition of the WGC in the presence of wormholes.

We summarise our findings in section 8 and point out directions for future work. Various appendices contain detailed computations on which some of our results are based, or clarify subtleties which are not absolutely essential for the understanding of the main body of the paper.

Overall, our analysis leaves us with the following: a semi-classical approach to quantum gravity via gravitational instantons does not give rise to strong constraints for large-field inflation. Thus, if quantum gravity has anything to say about large field inflation, the quantum part will have to speak.

2 Gravitational instanton solutions

A model of axion inflation will necessarily involve an axionic field coupled to gravity. One feature of such a system is that it may allow for *gravitational instantons*, i.e. finite-action solutions to the equations of motion of the Euclidean axion-gravity theory.

Our starting point is the Euclidean action for an axionic field θ coupled to gravity, which takes the form ($M_p = 1$)

$$S = \int d^4x \sqrt{g} \left[-\frac{1}{2}R + \frac{1}{2}K g^{\mu\nu} \partial_\mu \theta \partial_\nu \theta \right]. \tag{2.1}$$

The prefactor K can in principle depend on further fields. In this section we ignore the Gibbons-Hawking-York boundary terms, because we will be focussing on the dynamics of the system. Instead of working with the axionic field θ , one can write the action in terms of the dual 2-form B and its field strength $H = dB$:

$$S = \int d^4x \sqrt{g} \left[-\frac{1}{2}R + \frac{1}{2}\mathcal{F} H_{\mu\nu\rho} H^{\mu\nu\rho} \right], \tag{2.2}$$

where $\mathcal{F} = 1/(3!K)$. The field strength H is related to $d\theta$ via

$$H = K \star d\theta. \tag{2.3}$$

The dualisation from (2.1) to (2.2) must be done under the path integral using Lagrange multipliers. We will explain this in the following subsection.

In Euclidean space the theory of the 3-form H coupled to gravity (2.2) then has non-trivial solutions. In particular, *gravitational instantons* are rotationally symmetric solutions with metric

$$ds^2 = \left(1 + \frac{C}{r^4}\right)^{-1} dr^2 + r^2 d\Omega_3^2, \tag{2.4}$$

where the parameter C arises as a boundary condition or integration constant (see appendix A). For $C < 0$ this is known as a *Giddings-Strominger or Euclidean wormhole* [28]:

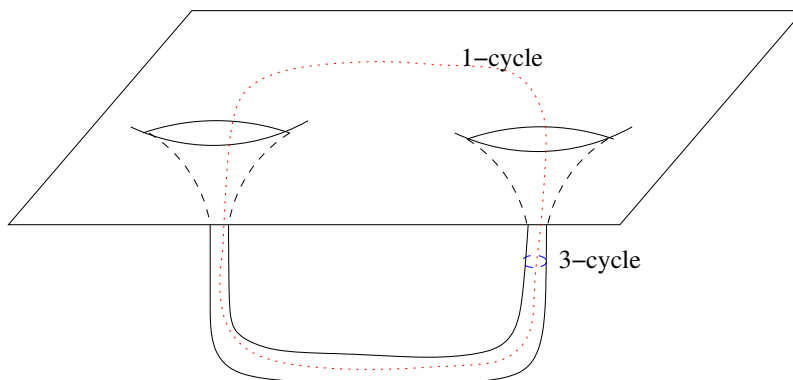

Figure 2. This picture illustrates a Euclidean wormhole, whose two ends are connected to the *same* asymptotically flat space. Then there is a non-trivial 1-cycle (dotted line) passing through the wormhole. The cycle orthogonal to this 1-cycle is a S^3 (symbolised by the dashed line around the right-hand throat).

for large r it approaches flat space, while for decreasing r the geometry exhibits a throat with cross-section S^3 . At $r = |C|^{1/4}$ one encounters a coordinate singularity, where another solution of this type can be attached (see e.g. figure 2 and 3(a) for two possibilities). Gravitational instanton solutions for $C = 0$ and $C > 0$ can also be found if a dilaton-type field is included [17, 75].

Before we extend our system to dilaton-type couplings, we review and discuss several subtleties involved in the aforementioned dualisation between θ and B in Euclidean space.

2.1 Dualisation

For the sake of clarity, in this subsection we index the field variables by their rank, i.e. we write θ_0 and B_2 . Those fields are sourced by an instanton and a microscopic string, respectively. We start from the two Euclidean actions in 4d:³

$$S[\theta_0] = \int_M \frac{1}{2g_\theta^2} F_1 \wedge \star F_1 + iQ_\theta \int_I \theta_0, \quad F_1 = d\theta_0, \quad (2.5)$$

$$S[B_2] = \int_M \frac{1}{2g_B^2} H_3 \wedge \star H_3 + iQ_B \int_\sigma B_2, \quad H_3 = dB_2, \quad (2.6)$$

where M denotes our 4-manifold, I the set of points where the instantons are located, and σ is the surface swept out by the string. One can identify the kinetic terms of (2.5) and (2.6) by imposing

$$H_3 = g_B^2 \star F_1 \quad (2.7)$$

and $g_B^2 = 1/g_\theta^2$. This now becomes a single theory with both strings and instantons allowed and either θ_0 or B_2 to be used locally as the appropriate field variable.

³The appearance of the i -factor in front of the coupling terms can be understood by writing these terms as $\int_M f_p \wedge j_{4-p}$ with p -form field f_p and source current j_{4-p} . One of the relevant tensor components of either f_p or j_{4-p} then always carries a zero-index and hence acquires an i -factor by Wick rotation.

Note that the H_3 -flux is quantised by

$$\int_{S^3} H = n \in \mathbb{Z}, \tag{2.8}$$

as we review in appendix B in the context of the existence of fundamental strings and instantons.

We now couple the 1-form/3-form theory to gravity. It is well-known that choosing either θ_0 or B_2 as the fundamental field leads to Einstein equations differing by an overall sign [28]. Indeed, the action of (2.5) gives the energy-momentum tensor

$$T_{\mu\nu}^{(\theta)} = \frac{1}{g_\theta^2} \left(-\frac{1}{2} g_{\mu\nu} (\partial\theta_0)^2 + \partial_\mu \theta_0 \partial_\nu \theta_0 \right), \tag{2.9}$$

while (2.6) leads to

$$\begin{aligned} T_{\mu\nu}^{(B)} &= \frac{1}{g_B^2} \left(-\frac{1}{2 \cdot 3!} g_{\mu\nu} H_3^2 + \frac{1}{2} H_{\mu\rho\sigma} H_\nu{}^{\rho\sigma} \right) = \\ &= -\frac{1}{g_\theta^2} \left(-\frac{1}{2} g_{\mu\nu} (\partial\theta_0)^2 + \partial_\mu \theta_0 \partial_\nu \theta_0 \right) = -T_{\mu\nu}^{(\theta)}. \end{aligned} \tag{2.10}$$

In the second line we used (2.7) together with $g_B^2 = 1/g_\theta^2$.

The above sign difference implies that Euclidean wormholes exist in the B_2 but not in the θ_0 formulation. Technically, this is due to the Hodge star being introduced before or after the variation w.r.t. the metric. Also at the intuitive level the difference is clear: the H_3 -flux on the transverse S^3 , which is fixed due to the Bianchi identity, supports the finite-radius throat. By contrast, the dual quantity $\theta' \equiv \partial_r \theta$, i.e. the variation of θ along the throat, is *not* fixed by the dual Bianchi identity and the solution is lost.

We note that the *Minkowski-space* Einstein equations remain the same on both sides of the duality. However, we are interested in the path integral in the *Euclidean* theory with gravity, so this observation does not help.

Thus, one may wonder whether Giddings-Strominger wormholes do contribute to the action or whether the dual descriptions are really fully equivalent. This problem has been intensively investigated in the past, see e.g. [1, 28, 76–89] and our present understanding mainly derives from [86–88].

Indeed, it should be possible to resolve the problem by dualising under the Euclidean path integral and following the fate of the instanton solution. We review the dualisation following [80, 86, 87]. To be specific, let M be a cylinder, $M = S^3 \times I$, with an interval $I \subset \mathbb{R}$. This is the simplest relevant topology since the S^3 can carry H_3 -flux, supporting a narrow throat somewhere within I .

Starting on the B_2 -side, the partition function reads

$$Z \sim \int_{\text{b.c.}} d[B_2] \exp \left(- \int_M \frac{1}{2g_B^2} dB_2 \wedge \star dB_2 \right), \tag{2.11}$$

where “b.c.” denotes the boundary conditions $B_2(S_I^3) \equiv B_2^{(I)}$ and $B_2(S_F^3) \equiv B_2^{(F)}$ at the initial and final boundaries S_I^3 and S_F^3 . The possibility of a non-trivial flux, $\int_{S^3} H_3 \neq 0$,

can as usual be implemented by defining B_2 in patches over the transverse S^3 and choosing appropriate transition functions.

One can also express Z as a path integral over H_3 , imposing $dH_3 = 0$ with the help of a Lagrange-multiplier θ_0 :

$$Z \sim \int_{\text{b.c.}} d[H_3]d[\theta_0] \exp \left\{ - \int_M \frac{1}{2g_B^2} \left(H_3 \wedge \star H_3 + 2ig_B^2 \theta_0 dH_3 \right) \right\}. \quad (2.12)$$

The previous B_2 -boundary conditions now translate into boundary conditions on the pull-back⁴ of H_3 to the initial and final boundary, i.e. $H_3(S_I^3) \equiv H_3^{(I)}$ and $H_3(S_F^3) \equiv H_3^{(F)}$. In this language, the information about a possible H_3 -flux is simply part of the H_3 boundary conditions. The θ_0 -integral is unconstrained. The i in front of the Lagrange-multiplier is needed to get a delta-functional $\delta(dH_3)$ in the path integral after integrating out θ_0 . Hence, we have $dH_3 = 0$ and Stokes theorem yields $H_3^{(I)} = H_3^{(F)}$. In other words $Z \sim \delta(H_3^{(I)} - H_3^{(F)})$.

Equation (2.12) can be rewritten by integrating the second term by parts and completing the square:

$$Z \sim \int_{\text{b.c.}} d[H_3]d[\theta_0] \exp \left\{ -i \int_{\partial M} \theta_0 H_3 \right\} \exp \left\{ - \int_M \frac{1}{2g_B^2} \left[(H_3 - ig_B^2 \star d\theta_0) \wedge \star (H_3 - ig_B^2 \star d\theta_0) + g_B^4 d\theta_0 \wedge \star d\theta_0 \right] \right\}. \quad (2.13)$$

According to [80, 86, 87] one can now shift the variable $H_3 \rightarrow \tilde{H}_3 \equiv H_3 - ig_B^2 \star d\theta_0$ and trivially perform the Gaussian integral. One may however also be concerned about this step since, for any fixed θ_0 , the boundary conditions, e.g. $\tilde{H}_3(S_I^3) = H_3(S_I^3) - ig_B^2 \star d\theta_0$, clash with the saddle point value $\tilde{H}_3 = 0$ of the Gaussian integral in the interior of M .

To make this issue more explicit, let us write $H_3 = \langle H_3 \rangle + \delta H_3$, where $\langle H_3 \rangle$ is constant along the S^3 but time dependent. Its boundary values are determined by the H_3 -flux. Furthermore, decompose δH_3 into spherical harmonics on S^3 . If the cylinder M were flat and gravity non-dynamical, we would now simply have a quantum mechanical system of infinitely many, independent oscillators. The dualisation process sketched above would correspond, as is well known from T -duality for a scalar field on the cylinder $S^1 \times \mathbb{R}$, to a canonical transformation ($p \leftrightarrow q$) for each oscillator. In our case, the dual variables are coefficients of the spherical harmonic decomposition of θ_0 .

Let us focus on the most interesting subsystem (see also the discussion in [88]) with the variable $\langle H_3 \rangle \sim p$ and the dual variable $\langle \theta_0 \rangle \sim q$. Thus, we first restrict our attention to the question whether it is correct to naively integrate out q in

$$Z \sim \int_{\text{b.c.}} d[p] \int d[q] \exp \left\{ -\frac{1}{2} \int_{t_i}^{t_f} dt \left[(p - i\dot{q})^2 + \dot{q}^2 \right] \right\}. \quad (2.14)$$

Based on an explicit, discretised calculation in appendix C, we claim this is indeed the case. One can now argue that, also for the full system (2.13) including all oscillators and gravity,

⁴ This is *not* the same as H_3 at the position of the boundaries, which contains time-derivatives of B_2 and should not be constrained.

this formal manipulation with path integrals is correct. It will then also remain correct if, as argued in appendix B, $\langle H_3 \rangle$ is initially quantised, i.e. $\int_{S^3} \langle H_3 \rangle = n \in \mathbb{Z}$. Indeed, this quantisation is ‘neutralised’ once the Lagrange multiplier is introduced and the now continuous variable $\langle H_3 \rangle$ is integrated out as above.

As a result of all this the partition function can eventually be given as

$$Z \sim \int d[\theta_0] \exp \left(- \int_M \frac{1}{2g_\theta^2} d\theta_0 \wedge \star d\theta_0 - i \int_{\partial M} \theta_0 H_3 \right), \quad (2.15)$$

where $g_\theta^2 = 1/g_B^2$. We emphasise that the sign of the kinetic term is the one required for a well-defined Euclidean path integral. This sign will become important below. We also note that this procedure can be straightforwardly generalised to any p -form in arbitrary dimensions $d > p$. Moreover, we observe that despite the shift $H_3 \rightarrow H_3 - ig_B^2 \star d\theta_0$, the field θ_0 can be kept real (see also [87]).⁵

Varying the action in (2.15),

$$\delta S = \int_M \frac{1}{g_\theta^2} \delta\theta_0 d \star d\theta_0 - \int_{\partial M} \frac{1}{g_\theta^2} \delta\theta_0 \star d\theta_0 - i \int_{\partial M} \delta\theta_0 H_3 \stackrel{!}{=} 0, \quad (2.16)$$

we find the equation of motion $d \star d\theta_0 = 0$ in the bulk and

$$H_3(\partial M) = \frac{i}{g_\theta^2} \star d\theta_0(\partial M) \quad (2.17)$$

at the boundary. Thus, the θ_0 path integral has only complex saddle points [86, 87].⁶ Indeed, the possibility of taking θ_0 imaginary at stationary points was discussed before, see e.g. [80, 81].

To summarise, dualisation leads to a Euclidean path integral in which θ_0 is a priori real and the kinetic term has the standard sign. However, a semi-classical evaluation is only possible on the basis of complex saddles. Crucially, the relevant field-theory solutions then also solve Einstein equations because imaginary θ_0 flips the sign of $T_{\mu\nu}^{(\theta)}$ (cf. (2.10)). Thus, one can expect gravitational instantons to contribute consistently both in the B_2 and the θ_0 formulation. Nevertheless, it is natural to use the B_2 path integral to keep the saddle points real [86, 87], and we will do so in what follows.

2.2 Gravitational instantons in the presence of a massless scalar field

One goal of this paper is to study the effect gravitational instantons can have on geometric moduli of string compactifications. In the 4-dimensional theory these moduli appear as scalar fields. Consequently, we will study systems of an axion θ and a scalar φ coupled to

⁵In other references, e.g. [85, 89], the axion field was taken to be imaginary. Then, however, we do not see how to ensure $dH_3 = 0$ using (2.12).

⁶For a treatment of path integrals with complex phase space or complex saddles, see e.g. [90] and [91], respectively.

gravity.⁷ The relevant Euclidean action then takes the form

$$S = \int d^4x \sqrt{g} \left[-\frac{1}{2}R + \frac{1}{2}K(\varphi)g^{\mu\nu}\partial_\mu\theta\partial_\nu\theta + \frac{1}{2}g^{\mu\nu}\partial_\mu\varphi\partial_\nu\varphi \right]. \quad (2.18)$$

Here we already canonically normalised the field φ . At 2-derivative level, the axion θ can only enter the action through a term $\partial_\mu\theta\partial^\mu\theta$ due to its shift symmetry. There is no such symmetry for φ and hence the kinetic term for θ can in general depend on φ . This situation is typically encountered in string compactifications, see subsection 5.2 for examples. In this subsection we consider a massless scalar field φ and apply the subsequent results to the case of a massive scalar in section 5.

As we are interested in gravitational instantons, we should consider the dual formulation of the above theory. The relevant Euclidean action is then

$$S = \int d^4x \sqrt{g} \left[-\frac{1}{2}R + \frac{1}{2}\mathcal{F}(\varphi)H^2 + \frac{1}{2}g^{\mu\nu}\partial_\mu\varphi\partial_\nu\varphi \right], \quad (2.19)$$

where $\mathcal{F} = 1/(3!K) = 1/(3!f_{\text{ax}}^2)$. Here f_{ax} is the φ -dependent analogue of the familiar axion decay constant.

In the following we will review explicit solutions of this system corresponding to gravitational instantons. Following [17] we will construct solutions to the equations of motion for the metric, the 3-form H and the scalar φ .

General solution. For completeness, let us recall the metric given in (2.4):

$$ds^2 = \left(1 + \frac{C}{r^4}\right)^{-1} dr^2 + r^2 d\Omega_3^2.$$

The derivation of the functional form of g_{rr} can be found in appendix A. There we show that the equation of motion for g_{rr} decouples from the equations of motion of the massless fields φ and B . In particular, the form of the metric (2.4) is independent of the functional form of the kinetic terms of these fields. The constant C can a priori be negative, positive or zero. Depending on the sign of this parameter C , this solution has the following interpretations. Using the terminology of [17, 75] we can distinguish between three types of gravitational instantons (see figure 3 for an illustration).

- *Euclidean wormholes* ($C < 0$): the case $C < 0$ leads to a geometry with a throat and we call this solution a Euclidean wormhole. The divergence of g_{rr} at $r = r_0 \equiv |C|^{1/4}$ is only a coordinate singularity. The Ricci scalar R is

$$R = 6\frac{C}{r^6} \quad (2.20)$$

and thus it is finite for all $r \geq r_0$. The locus $r = r_0$ can then be interpreted as the end of one wormhole throat. We can then attach another solution of this type at $r = r_0$

⁷A string compactification will typically give rise to many axionic fields and many geometric moduli. We focus here on one, potentially super-Planckian, light axion which may be identified with the inflaton. Similarly, the scalar can be identified with the lightest modulus. Note that the analysis in this subsection neglects any mass term for the modulus φ , which will be included only later in section 5.

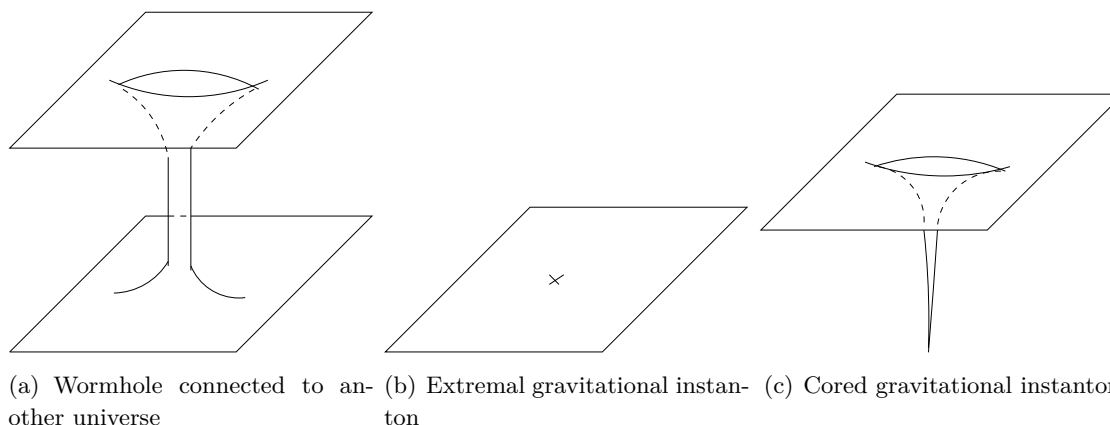

Figure 3. The three types of gravitational instantons are depicted. (a) Euclidean wormhole connecting two asymptotically flat spaces. It is also possible to connect both ends to the same space as shown in figure 2. (b) extremal gravitational instanton: in this case space is flat everywhere. The cross in the middle indicates the locus $r = 0$. (c) cored gravitational instanton: there is a curvature singularity at $r = 0$.

which can either be attached to our universe (see figure 2) or a different universe (see figure 3). In this paper we will only consider wormholes which close again in our universe, i.e. we are dealing with pairs of holes each connected by a “handle”.

- *Extremal instantons* ($C = 0$): the solution for $C = 0$ is called an extremal gravitational instanton [17, 75]. Even though space is flat in that case, the fields φ and θ still exhibit a nontrivial profile. This is possible due to a complete cancellation of terms in the energy-momentum tensor [92].
- *Cored gravitational instantons* ($C > 0$): the case $C > 0$ gives rise to a geometry with a curvature singularity at $r = 0$. Such solutions are called *cored gravitational instantons* [17].

Having reviewed the solution for the metric, we will now solve the equation of motion for H without specifying $\mathcal{F}(\varphi)$. From (2.19) we obtain the equation of motion:

$$d \star H = - \frac{\mathcal{F}'(\varphi)}{\mathcal{F}(\varphi)} d\varphi \wedge \star H. \quad (2.21)$$

We expect that solutions for φ and H should exist that respect the spherical symmetry of the background. We thus propose that $\varphi = \varphi(r)$. Similarly, following [28], we make the ansatz

$$H = h(r)\epsilon \quad (2.22)$$

with ϵ the volume form on S^3 such that

$$\int_{S^3} \epsilon = 2\pi^2 r^3. \quad (2.23)$$

From (2.22) it follows that $\star H \sim h(r)dr$ and the l.h.s. of (2.21) vanishes. As we have chosen $\varphi = \varphi(r)$ the r.h.s. of (2.21) equally vanishes and the equation of motion for H is satisfied.

In addition, H also has to satisfy the Bianchi identity $dH = 0$. This enforces

$$h(r) = \frac{n}{Ar^3}, \tag{2.24}$$

with $A \equiv A(S^3) = 2\pi^2$ the area of the unit sphere. Charge quantisation (2.8) implies that $n \in \mathbb{Z}$.

In order to find the solution for φ it is sufficient to consider the rr -component of the Einstein equations, $G_{rr} = T_{rr}$, which can be shown to be equivalent to the Klein-Gordon equation for φ . It reads

$$\frac{1}{2} \left(1 + \frac{C}{r^4} \right) (\varphi')^2 - \frac{3\mathcal{F}(\varphi)n^2/A^2 + 3C}{r^6} = 0, \tag{2.25}$$

where we already used the solution for H . We also defined $\varphi' \equiv \partial\varphi/\partial r$. The solution for φ can then be found by integrating this differential equation.

Model-dependent solutions. From (2.25) it is clear that explicit solutions for φ will depend on the functional form of the term $\mathcal{F}(\varphi)$. In this subsection we will restrict our attention to functions of the form $\mathcal{F}(\varphi) \sim \exp(-\alpha\varphi)$, where we choose without loss of generality $\alpha > 0$, as this functional form arises frequently in string compactifications. For example, this behaviour is observed when φ is identified with the dilaton. Similarly, the same functional form appears if φ corresponds to the volume modulus in setups with large compactification volume (e.g. [93]) or if φ is a complex structure modulus at large complex structure. We will study such examples in subsection 5.2.

To be specific, we take

$$\mathcal{F}(\varphi) = \frac{1}{3!f_{\text{ax}}^2} \exp(-\alpha\varphi), \tag{2.26}$$

where f_{ax} is from now on a constant. The value of the parameter α will depend on the type of geometric modulus. We can assume $\lim_{r \rightarrow \infty} \varphi(r) = 0$ without loss of generality. Then f_{ax} will correspond to the asymptotic value of the axion decay constant.

In the following, we will summarise the explicit solutions for φ for the Euclidean wormhole, the extremal instanton and for the cored instanton. Further details can be found in appendix D.

- *Euclidean Wormhole* ($C < 0$): the analytical solution to (2.25) in this case is [28, 75]

$$e^{\alpha\varphi(r)} = \frac{1}{\cos^2(K_-)} \cos^2 \left(K_- + \frac{\alpha}{2} \sqrt{\frac{3}{2}} \arcsin \left(\frac{\sqrt{|C|}}{r^2} \right) \right). \tag{2.27}$$

Here, we already implemented the boundary condition $\lim_{r \rightarrow \infty} \varphi(r) = 0$, which also implies that

$$C = -\frac{n^2}{3!f_{\text{ax}}^2 A^2} \cos^2(K_-). \tag{2.28}$$

The integration constant K_- is not a free parameter. This can be seen as follows. When the field reaches the wormhole throat at $r = r_0 \equiv |C|^{1/4}$, the factor $(1 + C/r^4)$ in (2.25) vanishes, hence

$$3\mathcal{F}(\varphi(r_0))n^2/A^2 + 3C = 0. \tag{2.29}$$

Using (2.28), this translates to

$$\cos^2 \left(K_- + \frac{\alpha\pi}{4} \sqrt{\frac{3}{2}} \right) = 1, \quad (2.30)$$

and thus

$$K_- = -\frac{\alpha\pi}{4} \sqrt{\frac{3}{2}}. \quad (2.31)$$

Inserting this back into the solution yields

$$e^{\alpha\varphi(r)} = \frac{1}{\cos^2 \left(\sqrt{3/2} \alpha\pi/4 \right)} \cos^2 \left(\frac{\alpha}{2} \sqrt{\frac{3}{2}} \arccos \left(\frac{\sqrt{|C|}}{r^2} \right) \right). \quad (2.32)$$

To see that one can take two wormhole solutions and glue them together, let us now change coordinates by writing $r = a(t)$ such that the metric becomes

$$ds^2 = dt^2 + a^2(t) d\Omega_3^2. \quad (2.33)$$

One can show that $a(t)$ and $\varphi(t)$ are symmetric under $t \rightarrow -t$. This implies the existence of a “handle” as shown in figure 2, assuming also that the two throats are very distant in \mathbb{R}^4 .

Interestingly, not all values for α will lead to physically acceptable solutions. Note that $\varphi(r)$ is regular everywhere on $r \in [|C|^{1/4}, +\infty)$ only for dilaton couplings in the range $0 \leq \alpha < 2\sqrt{2/3}$. For $\alpha > 2\sqrt{2/3}$ there is always a value of $r > |C|^{1/4}$, where $e^{\alpha\varphi(r)} = 0$, i.e. $\varphi(r) \rightarrow -\infty$. This is consistent with [1, 28, 75]. In our case the field φ corresponds to the string coupling or a geometric modulus of the string compactification. A runaway behaviour $\varphi(r) \rightarrow -\infty$ is then pathological as it would correspond to a limit of decompactification or vanishing string coupling. In all these cases new light states will appear resulting in a loss of control over the effective theory. This pathology is avoided for $\alpha = 2\sqrt{2/3}$. However, in this case we obtain $C = 0$ which will be discussed next. Overall, we find that only the range $0 \leq \alpha < 2\sqrt{2/3}$ is physically allowed for Euclidean wormholes.

Last, note that the limit $\alpha \rightarrow 0$ can be identified with the Giddings-Strominger wormhole [28] which exhibits a constant dilaton profile.

- *Extremal Instanton* ($C = 0$): for the case of an extremal instanton we find

$$e^{\alpha\varphi(r)} = \left(1 + \frac{\alpha n}{4A f_{\text{ax}}} \frac{1}{r^2} \right)^2, \quad (2.34)$$

which is valid for all $\alpha > 0$. (For $\alpha = 2\sqrt{2/3}$ this solution agrees with (2.32). A plot of the dilaton profile in this case can be found in figure 4.). The result can be obtained most easily by solving (2.25) for $C = 0$. Notice that (2.34) with a minus sign in the bracket would in principle also be a solution (see appendix D), but then there would again be a value of $r > 0$ so that $e^{\alpha\varphi} = 0$, leading to the same problems as described above. We hence exclude this possibility.

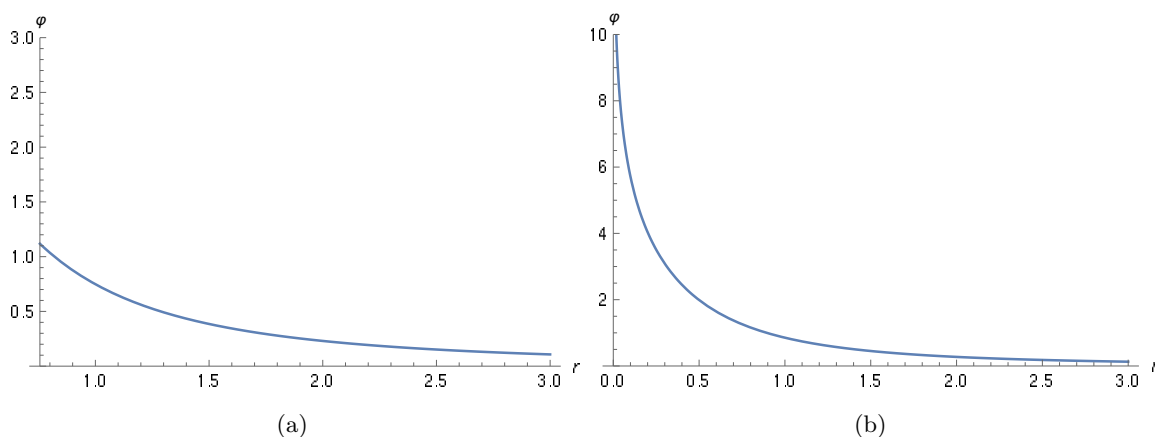

Figure 4. Illustration of dilaton profiles. The values of r and φ are in Planck units. (a) Euclidean wormhole ($C < 0$): here we choose n/f_{ax} such that $C = -\cos^2\left(\alpha\pi\sqrt{3}/2/4\right)$ and plot for $\alpha = 1$. (b) extremal instanton ($C = 0$) with $\alpha = 2\sqrt{2}/3$.

- *Cored gravitational instantons* ($C > 0$): finally, for the case of cored gravitational instantons $C > 0$ one finds [17, 75]

$$e^{\alpha\varphi(r)} = \frac{1}{\sinh^2(K_+)} \sinh^2\left(K_+ + \frac{\alpha}{2}\sqrt{\frac{3}{2}}\text{arcsinh}\left(\frac{\sqrt{C}}{r^2}\right)\right), \quad (2.35)$$

where we again ensured $\lim_{r \rightarrow \infty} \varphi(r) = 0$ by demanding

$$C = \frac{n^2}{3!f_{\text{ax}}^2 A^2} \sinh^2(K_+). \quad (2.36)$$

In figure 5 two plots of the dilaton profile are presented. The integration constant K_+ should be positive in order to again avoid a divergence of φ for some $r > 0$, but is otherwise unconstrained. This is different compared to wormholes or extremal instantons, which do not exhibit a free parameter. From this 4d effective theory one is lead to believe that there exists a whole family of cored instanton solutions parametrised by K_+ . However, by considering the microscopic origin of gravitational instanton solutions, one finds evidence that only certain values of K_+ are allowed, as we will now discuss.

2.3 Interpretation of the integration constant K_+

The integration constant K_+ , or equivalently C , seems to be a free and continuous parameter giving rise to a family of solutions. We want to argue that this is not the case. Note that the cored gravitational instanton solutions are UV-sensitive and therefore a naive 4d field theory treatment is not sufficient. Instead, it is crucial to understand those solutions in a UV-complete theory, such as string theory. In this context the role of the integration constant K_+ becomes clear. Specifically, it was pointed out in [75] that the parameter C is determined by the mass M and charge Q of a dilatonic black brane wrapping internal cycles

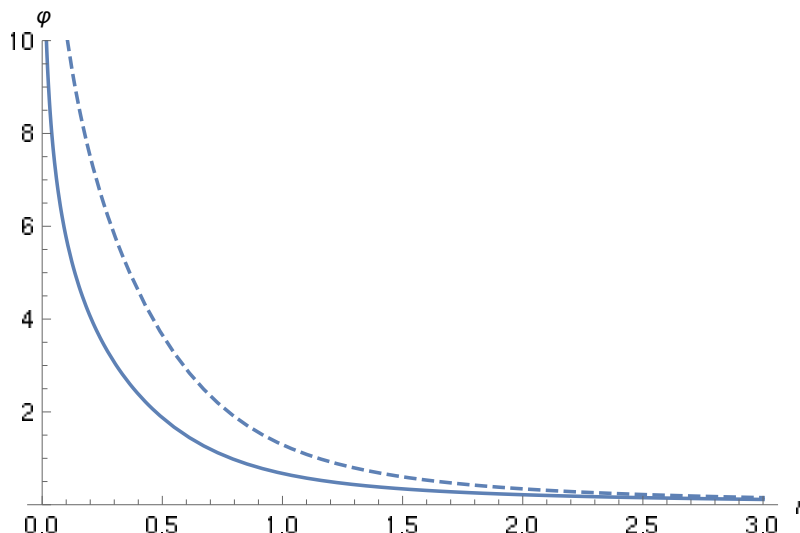

Figure 5. This plot shows dilaton profiles for the cored gravitational instanton with $\alpha = 15$ (solid line) and $\alpha = 0.1$ (dashed line). Again, r and φ are given in Planck units. For the purpose of illustration we have chosen $K_+ = 0.5$ and n/f_{ax} such that $C/\sinh^2 K_+ = 1$.

in a higher-dimensional theory, whose dimensionally reduced action coincides with (2.19). This holds true at least for some values of α . Consequently, we conjecture that C and K_+ generically take discrete and well-defined values determined by the underlying microscopic theory. Further, if the Weak Gravity Conjecture holds in 5d, cored gravitational instantons may not be stable.

We support this conjecture by providing a specific toy-example borrowed from [75]. Following their results, we can consider a five-dimensional model with Euclidean action in 5d Planck units

$$S = \int d^5x \sqrt{\hat{g}} \left[-\frac{1}{2} \hat{R} + \frac{1}{2} (\partial \hat{\phi})^2 + \frac{1}{4} e^{a\hat{\phi}} \hat{F}^2 \right], \quad (2.37)$$

where $\hat{F} = d\hat{A}$ is a 2-form field strength tensor. For the dimensional reduction to a 4d theory we choose⁸

$$ds_{(5)}^2 = e^{2\beta_1\psi} d\tau^2 + e^{2\beta_2\psi} ds_{(4)}^2 \quad (2.38)$$

together with $\hat{A} = \theta d\tau$ and $\hat{\phi} = \phi$, i.e. the fields θ and $\hat{\phi}$ do not depend on the extra-dimensional coordinate τ . In Einstein-frame with canonically normalised kinetic terms dimensional reduction fixes the constants β_1 and β_2 to

$$\beta_1 = -2\beta_2, \quad \beta_2 = \frac{1}{\sqrt{6}}. \quad (2.39)$$

After redefining the fields ϕ and ψ via a rotation in the (ϕ, ψ) -plane we get

$$S = \int d^4x \sqrt{g} \left[-\frac{1}{2} R + \frac{1}{2} (\partial \tilde{\phi})^2 + \frac{1}{2} (\partial \tilde{\psi})^2 + \frac{1}{2} e^{\alpha \tilde{\phi}} (\partial \theta)^2 \right], \quad (2.40)$$

⁸For the purpose of compactification we switch to Euclidean time τ by Wick-rotation. For simplicity we choose the periodicity $\tau \sim \tau + 1$. Later in this subsection we allow the circumference of the S^1 to have length $\ell > 0$. This will then have to be taken into account in order to determine the axion-decay constant.

where g denotes the metric corresponding to the 4d-line-element. Setting $\tilde{\psi} = 0$ in this action one obtains the model considered in (2.18) with dilatonic dependence in the kinetic term of θ . The 4d dilaton coupling α is related to the 5d dilaton coupling a via⁹

$$\alpha^2 = a^2 + \frac{8}{3}. \quad (2.41)$$

Therefore, the interpretation of the 4d theory in terms of a 5d theory is only possible if $\alpha \geq 2\sqrt{2/3}$.

Let us now explicitly relate the integration constant C to microscopic properties of a higher-dimensional theory. In [75] it was shown that for $\alpha = 2\sqrt{2/3}$ the solutions of the 4d model (2.40) can be uplifted to a five-dimensional Reissner-Nordström (RN) black hole solution

$$ds_{(5)}^2 = g_+(\rho)g_-(\rho)d\tau^2 + \frac{d\rho^2}{g_+(\rho)g_-(\rho)} + \rho^2 d\Omega_3^2, \quad \hat{F}_{\tau\rho} = \sqrt{6}\frac{Q}{\rho^3} \quad (2.42)$$

where

$$g_{\pm}(\rho) = 1 - \frac{\rho_{\pm}^2}{\rho^2} \quad (2.43)$$

with

$$\rho_{\pm}^2 = M \pm \sqrt{M^2 - Q^2}. \quad (2.44)$$

We take this as a simple toy-model to argue that C is generically fixed by properties of a black brane wrapping internal cycles. The RN black hole can be interpreted as N particles or 0-branes (or just one 0-brane wrapping the cycle N times) of total mass M and total charge Q . Note however that the ADM-mass M_{ADM} is related to the mass parameter M by $M_{\text{ADM}} = 6\pi^2 M$. Nevertheless, we henceforth call M the mass of the RN-black hole. The charge Q is defined such that $M = Q$ sets the extremality bound. That is, $Q = N\hat{q}\sqrt{6}/(6\pi^2)$, where the charge \hat{q} is defined by $N\hat{q} = 1/2 \int_{S^3} \star_5 \hat{F}$.¹⁰

Upon toroidal dimensional reduction along the coordinate τ with the identification $\tau \sim \tau + \ell$ and the circumference $\ell > 0$ of the compactified dimension, the 5d solution (2.42) turns into an instanton solution (2.4). Note that the coordinate singularity at $\rho = \rho_+$ of the 5d solution becomes a curvature singularity (at $r = 0$) in the 4d solution (2.4). In the subsequent computation we show that our integration constant C is simply given by $C = \ell^2(M^2 - Q^2)$ in 4d Planck units.

Denote by $g_{MN}^{(5)}$ the RN-metric (2.42), where M, N run over the coordinates of the 4d space and the extra-dimensional coordinate τ . Now, rescale the metric as follows: $\tilde{g}_{MN}^{(5)} = g_{MN}^{(5)}/(g_+g_-)$. From the canonical Einstein-Hilbert term we then get:

$$\begin{aligned} \int d^5x \sqrt{g^{(5)}} R[g_{MN}^{(5)}] &= \int d^5x (g_+g_-)^{3/2} \sqrt{\tilde{g}^{(5)}} R[\tilde{g}_{MN}^{(5)}] + \dots = \\ &= \int d^4x \ell (g_+g_-)^{3/2} \sqrt{\tilde{g}^{(4)}} R[\tilde{g}_{\mu\nu}^{(4)}] + \dots \end{aligned} \quad (2.45)$$

⁹Notice that our normalisation of ϕ is such that the prefactors of the Ricci scalar R and the kinetic term $(\partial\phi)^2$ are equal, while in [75] the prefactor of the dilaton has a factor 1/2 relative to R . This is why our dilaton-coupling α differs by a factor of $\sqrt{2}$.

¹⁰For the normalisation we found it useful to translate the conventions in [94, 95] to our situation.

The last term occurs in the compactified 4d theory using the identification $\tau \sim \tau + \ell$. We want to point out that for generic $\ell > 0$ there is a conical singularity at the outer horizon $\rho = \rho_+$. In principle, one could avoid such a conical singularity by choosing the periodicity of τ appropriately (it would be the inverse of the Hawking-temperature [96]), but this would mean to fix the compactification radius. Instead, we accept the conical singularity as a necessary feature of Euclidean branes wrapped on cycles of the compact space.¹¹ Since it is known that Euclidean branes wrapped on non-trivial cycles give rise to instantonic terms (see e.g. [97, 98]), we assume that the corresponding conical spacetimes are saddle-points of the Euclidean path integral.

We go to the Einstein frame (with 4d Planck mass $M_p = 1$) by rewriting the Einstein-Hilbert term using the rescaled metric $g_{\mu\nu}^{(4)} = \ell(g_+g_-)^{3/2}\tilde{g}_{\mu\nu}^{(4)}$. The compactified 4d line-element then reads

$$ds_{(4)}^2 = \ell \frac{d\rho^2}{\sqrt{g_+g_-}} + \ell \sqrt{g_+g_-} \rho^2 d\Omega_3^2. \tag{2.46}$$

For the comparison with the metric (2.4), the obvious coordinate transformation to be made is simply $r^2 = \rho^2 \ell \sqrt{g_+g_-}$. Using the definitions of g_{\pm} it follows

$$r dr = \ell^2 \frac{\rho(\rho^2 - M)}{r^2} d\rho. \tag{2.47}$$

Together with $(\rho^2 - M)^2 = r^4/\ell^2 + (M^2 - Q^2)$, this implies:

$$\ell \frac{d\rho^2}{\sqrt{g_+g_-}} = \frac{dr^2}{1 + \ell^2(M^2 - Q^2)/r^4}. \tag{2.48}$$

Hence, we find the simple relationship

$$C = \ell^2(M^2 - Q^2) \tag{2.49}$$

in 4d Planck units. Upon dimensional reduction of (2.37) and using the periodicity of the Wilson line $\hat{A}_\tau \cong \hat{A}_\tau + \pi/(\hat{q}\ell)$ one can easily check that the axion decay constant reads $f_{\text{ax}} = 1/(2\hat{q}\ell)$ for an axion θ with 2π -periodicity. It follows that

$$C = \frac{N^2}{24\pi^4 f_{\text{ax}}^2} \left[\left(\frac{M}{Q} \right)^2 - 1 \right]. \tag{2.50}$$

We can compare this result to our previous expression (2.36). First, we can identify the wrapping number/number of 0-branes N with the flux number n . We then find that the integration constant K_+ in (2.36) is completely determined by the parameters M and Q describing black holes/branes in the 5d theory. An immediate result is that K_+ and hence

¹¹Note that in the so-called dual frame metric discussed in [75] non-extremal instantons with $\alpha = 2\sqrt{2/3}$ can be interpreted as sections of constant time of the RN black hole metric. In this frame one recovers a wormhole geometry connecting two asymptotically flat regions smoothly. One pays the price of rescaling by a divergent factor. The above is technically different from our approach of obtaining gravitational instantons by compactification of a 5d black hole solution on an S^1 . In our case the RN black hole solution (2.42) in general yields conical singularities.

C are not free parameters. The possible range of values is determined by the spectrum of black branes in the higher-dimensional theory. Furthermore, as M and Q are discrete quantities it follows that C can also only take discrete values (for a given value of f_{ax}). This property is only important as long as M and Q are small. In the macroscopic regime of large M and Q the value of C can be dialed to any positive value and it becomes effectively continuous. We come back to this in section 4.

Notice that the case of $M = Q$, which gives $C = 0$, corresponds to an extremal Reissner-Nordström black hole. In this sense, the name *extremal instanton* for flat 4d solutions (2.4) is justified. In section 4 we comment on how to express the extremal instanton action in terms of ℓ and M_{ADM} , consistent with, for instance, [17, 89, 99].

This example illustrates nicely how 4d cored or extremal instanton solutions can be obtained from black holes/branes with mass M and charge Q . Of course, one could also go beyond such simple toy-models we just discussed, allowing also for dilaton couplings $\alpha \neq 2\sqrt{2/3}$. We expect the relation $C = \ell^2(M^2 - Q^2)$ to be modified by the corresponding parameter $a \neq 0$ in this more general case. Furthermore, one would expect that after SUSY-breaking extremal objects in string theory would appear as non-extremal instantons in the 4d effective theory.

Last, let us remark on possible implications for cored gravitational instantons arising from the Weak Gravity Conjecture. In particular, if the Weak Gravity Conjecture holds in the 5d model we expect that objects with $M > Q$ can in principle decay. As cored gravitational instantons arise from such unstable objects upon dimensional reduction, one may wonder whether this instability is then inherited by the instantons. Here ‘unstable instanton’ means that two instantons exist which cause the same flux change but have smaller total action. In this sense, the contribution of cored instantons to the Euclidean path integral is subdominant if cored instantons are ‘unstable’. This point will be made more precise in section 7.

3 Instanton potentials from Euclidean wormholes

The goal of this section is to show that the one-instanton action, describing a Giddings-Strominger wormhole, gives rise to an instanton potential of the structure $\cos \theta e^{-S}$.

We begin with a brief review of Coleman’s derivation [100, 101] of the energy eigenvalues for a simple one-dimensional quantum mechanical system with periodic potential V , e.g. $V(x) \sim \sin^2(2\pi x)$. These considerations can be applied to quantum field theory and in particular to our system as well.

The Hamiltonian is $H = p^2/2 + V(x)$. An instanton or an anti-instanton correspond to tunnelling events from x to $x + 1$ or $x - 1$, respectively. Using the dilute-gas approximation we can distribute instantons and anti-instantons freely in time. Let us introduce a basis of states $|j\rangle$ in which the particle is localised at $x \simeq j$. Then for some time interval $T > 0$, transition amplitudes are [100]

$$\langle j_+ | e^{-HT} | j_- \rangle = \left(\frac{\omega}{\pi}\right)^{1/2} e^{-\omega T/2} \sum_{N=0}^{\infty} \sum_{\bar{N}=0}^{\infty} \frac{1}{N! \bar{N}!} (K e^{-S_0 T})^{N+\bar{N}} \delta_{(N-\bar{N})-(j_+-j_-)}, \quad (3.1)$$

where j_- and j_+ are the positions of the initial and final state, respectively. N and \bar{N} count the number of instantons and anti-instantons. Moreover, ω is defined by $\omega = V''(0)$. K is the familiar determinant factor, which depends on details of the potential V . S_0 denotes the instanton action. The Kronecker delta can be rewritten as

$$\delta_{ab} = \int_0^{2\pi} \frac{d\theta}{2\pi} e^{i(a-b)\theta}, \tag{3.2}$$

and thus, after performing the summation,

$$\langle j_+ | e^{-HT} | j_- \rangle = \left(\frac{\omega}{\pi}\right)^{1/2} e^{-\omega T/2} \int_0^{2\pi} \frac{d\theta}{2\pi} e^{i(j_- - j_+)\theta} \exp\left(2KT \cos \theta e^{-S_0}\right). \tag{3.3}$$

From this we can read off that the system has an energy eigenbasis

$$|\theta\rangle = \sum_j e^{ij\theta} |j\rangle \tag{3.4}$$

with eigenvalues

$$E(\theta) = \frac{1}{2}\omega - 2K \cos \theta e^{-S_0}. \tag{3.5}$$

This derivation reveals the logic behind the famous contribution $\sim \cos \theta e^{-S}$ to the axion potential in quantum field theory, where the centres of the instantons are not distributed on a time interval but instead in a region of spacetime with volume \mathcal{V} . One then simply has to replace the variable T by the volume \mathcal{V} .

In the following we explain how this computation can be used to derive an instanton potential induced by Euclidean wormholes. In the previous section 2 we reviewed that Euclidean wormholes exist in the presence of a non-vanishing 3-form flux H with quantised charge $n \in \mathbb{Z}$. An instanton would then correspond to a transition from n to $n + 1$. By the logic of Coleman's computation above, this should induce a shift-symmetry breaking potential.

In [17] this was questioned, because Euclidean wormholes appear as conduits and charges would not disappear. In other words, one always has an instanton and an anti-instanton, thus preserving n .

We argue that this issue is more subtle: the two ends of a Euclidean wormhole do not necessarily have to end at the same hypersurface of constant Euclidean time, but can also close on distant hypersurfaces. Similarly, the two ends can have very large spatial separation such that, from a local perspective, a potential à la Coleman should be induced. Then, a Minkowskian observer would only see either the instanton or anti-instanton part of the wormhole and thus find a change in the charge n , see figure 6. This invalidates the reasoning in [17], and hence we do not see any argument against the breaking of the shift-symmetry due to Euclidean wormholes.

We want to make this mathematically more precise. This requires to compute the path integral contribution of all possible wormhole configurations. This allows us to infer the effective potential $V_{\text{eff}}(\theta)$ for the axion field θ . The logic behind the computation of $V_{\text{eff}}(\theta)$ is the following. The expectation value of any observable $\mathcal{O}(\theta)$ is given by

$$\langle \mathcal{O}(\theta) \rangle \sim \int d[\theta] \mathcal{O}(\theta) \exp\left(-\frac{1}{2} \int d^4x f_{\text{ax}}^2(\partial\theta)^2\right) Z_{\text{wh}}[\theta], \tag{3.6}$$

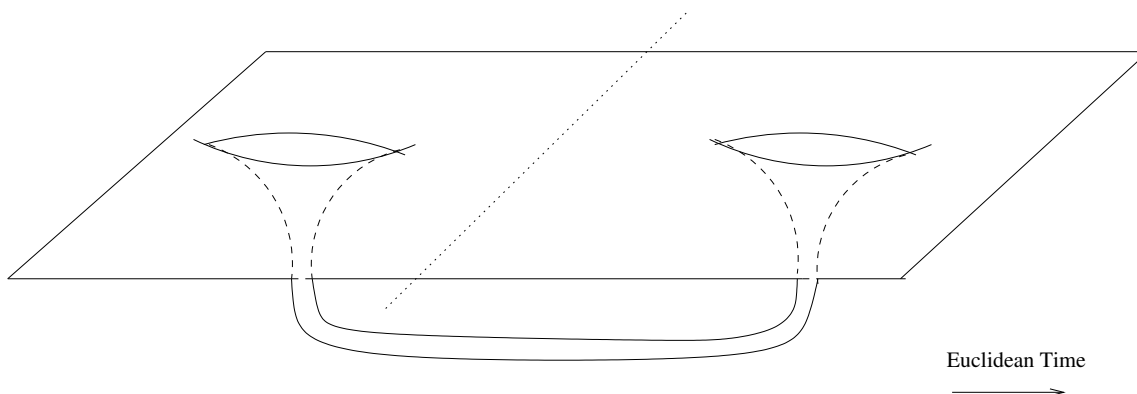

Figure 6. This picture presents a wormhole which opens at some initial time t_i and closes at $t_f > t_i$. The dotted line indicates the separation of the two events.

where the path integral contribution of wormholes is schematically (i.e. no combinatorial factors included yet) given by

$$Z_{\text{wh}}[\theta] \sim \sum_w \prod_{n=1}^w \prod_{m=1}^w \int d^4x_n \int d^4x_m e^{-S} e^{i\theta(x_n)} e^{-S} e^{-i\theta(x_m)} . \quad (3.7)$$

Here w denotes the number of wormholes of a configuration. Note that the phase difference occurs because one factor is for the instantons, the other for anti-instantons. Those factors arise from the second term of (2.5), where $Q_\theta = \pm 1$ (+ for instantons, – for anti-instantons). We write out these factors explicitly, because they finally give rise to the cos-potential for θ . The contribution $Z_{\text{wh}}[\theta]$ induces a change $\delta S_{\text{ind}}(\theta)$ of the action for the axion and we expect

$$\langle \mathcal{O}(\theta) \rangle \sim \int d[\theta] \mathcal{O}(\theta) \exp \left(-\frac{1}{2} \int d^4x f_{\text{ax}}^2 (\partial\theta)^2 - \delta S_{\text{ind}}(\theta) \right) , \quad (3.8)$$

where $\delta S_{\text{ind}}(\theta)$ contains by definition the effective potential of θ plus higher derivative corrections:

$$\delta S_{\text{ind}}(\theta) = \int d^4x (V_{\text{eff}}(\theta) + \text{higher derivative terms}) . \quad (3.9)$$

Hence, the effective potential $V_{\text{eff}}(\theta)$ can be determined by computing Z_{wh} using any field configuration θ for which $V_{\text{eff}}(\theta)$ dominates all derivative terms. We choose a smooth version of the profile

$$\theta(x) = \begin{cases} \theta_0 & \text{for } x \in I \times \mathbb{R}^3 \\ 0 & \text{else,} \end{cases} \quad (3.10)$$

i.e. a profile which is only non-zero in a small Euclidean time interval I (see figure 7) and goes to zero smoothly at the boundary of I . This is illustrated in figure 8. The volumes of $I \times \mathbb{R}^3$ and of the remaining part of Euclidean space are denoted by \mathcal{W} and \mathcal{V} , respectively. We assume that $\mathcal{W} \ll \mathcal{V}$ with \mathcal{W} being large enough to typically contain many wormhole ends. We first check that the derivative terms can indeed be made subdominant with respect to the effective potential. For simplicity, we work near the minimum and use

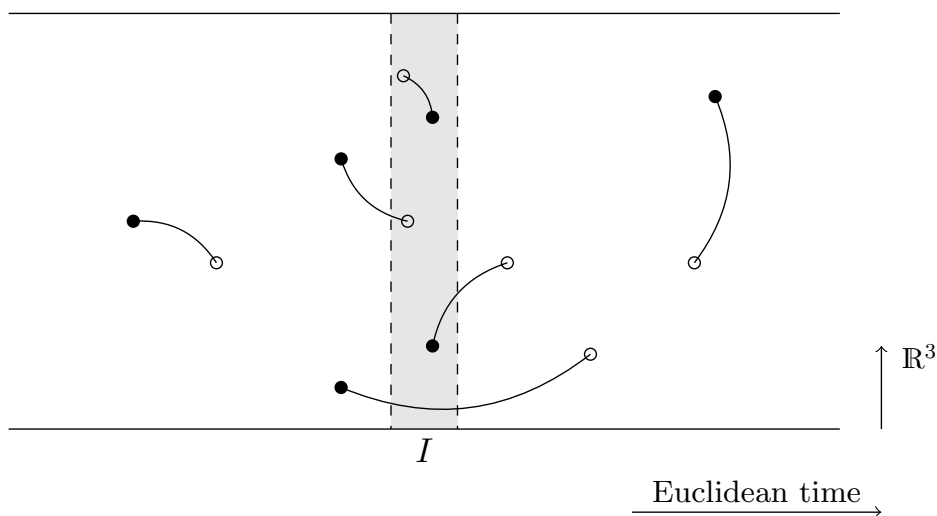

Figure 7. This illustration shows pairs of connected black and white dots, each representing an end of a wormhole (black if the end corresponds to an instanton and white for an anti-instanton). Only few wormholes lie completely inside the shaded region $I \times \mathbb{R}^3$.

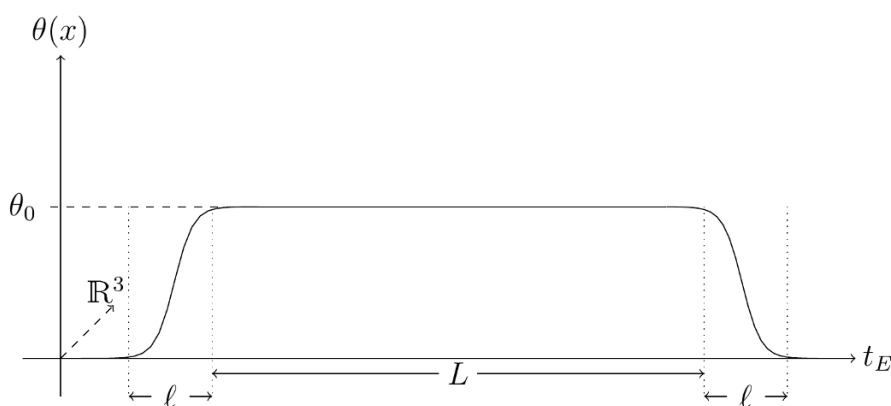

Figure 8. We illustrate the smooth axion profile corresponding to the approximation in (3.10). In the Euclidean time interval of length L the axion field is constant (value θ_0) and outside this interval the field decays smoothly. The characteristic length of this transition from θ_0 to 0 is denoted by ℓ .

the approximation $V_{\text{eff}} \sim m^2 \theta^2$. It is crucial that our axion profile at the boundary of I features a smooth transition of characteristic length ℓ from 0 to θ_0 with $\ell \ll L$, where L is the length of the Euclidean interval I . We then have $\partial\theta \sim \theta_0/\ell$ close to the boundary (and zero elsewhere) and the comparison of $\int d^4x f_{\text{ax}}^2 (\partial\theta)^2$ with $\int d^4x V_{\text{eff}}$ should yield

$$\ell V_3 f_{\text{ax}}^2 \frac{\theta_0^2}{\ell^2} \ll L V_3 m^2 \theta_0^2, \tag{3.11}$$

where V_3 denotes the corresponding 3-volume of the Euclidean spacetime regions we con-

sider. It follows that

$$L \gg \frac{f_{\text{ax}}^2}{m^2 \ell} \tag{3.12}$$

has to be imposed. Note that ℓ cannot be arbitrarily small as we have to ensure that also higher-derivative terms must be subdominant. Comparing $f_{\text{ax}}^2 (\partial\theta)^2$ with $(\partial\theta)^4$ yields

$$\ell \gg \frac{\theta_0}{f_{\text{ax}}} \sim \frac{1}{f_{\text{ax}}} . \tag{3.13}$$

It is not hard to see that these two conditions together with $L \gg \ell$ can be satisfied simultaneously. Thus, our field configuration (3.10) is suitable for the calculation of the effective potential given below. For this computation we find it useful to group the sum in the above expression (3.7) according to the position of the wormhole ends, see again figure 7. Let us assume that a wormhole corresponds, from the perspective of the θ -field theory, simply to an instanton-anti-instanton pair. Then, denoting by θ the field configuration of figure 8, we can write:

$$Z_{\text{wh}}[\theta] \sim \sum_n \frac{1}{n!n!} \prod_{j=1}^n e^{-2S} K^2 (\mathcal{V} + \mathcal{W}e^{i\theta_0}) (\mathcal{V} + \mathcal{W}e^{-i\theta_0}) . \tag{3.14}$$

Note that this differs from the toy model (3.1) in the sense that the sector with $N \neq \bar{N}$ is not contained in (3.14). But this is precisely our point: we want to find out whether a potential can still be generated if we impose $N = \bar{N}$, i.e. an equal number of instantons and anti-instantons. The combinatorial factor $1/(n!)^2$ is due to the indistinguishability of instantons and anti-instantons, respectively. The cross-terms $\mathcal{V}\mathcal{W}e^{\pm i\theta_0}$ correspond to wormholes where only one end is within $I \times \mathbb{R}^3$. The sum can be expressed as a Bessel function I_0

$$Z_{\text{wh}} \sim I_0(x) \tag{3.15}$$

with

$$I_0(x) = \sum_{m=0}^{\infty} \frac{1}{m!m!} \left(\frac{x}{2}\right)^{2m} \tag{3.16}$$

$$x \simeq 2K e^{-S} \mathcal{V} \left(1 + (\mathcal{W}/\mathcal{V}) \cos \theta_0 + \mathcal{O}\left((\mathcal{W}/\mathcal{V})^2\right)\right) . \tag{3.17}$$

Furthermore, there is an integral expression for I_0 :

$$I_0(x) = \frac{1}{2\pi} \int_0^{2\pi} d\phi e^{-x \cos \phi} . \tag{3.18}$$

Hence, we arrive at

$$Z_{\text{wh}} \sim \frac{1}{2\pi} e^x \int_0^{2\pi} d\phi e^{-x(1+\cos \phi)} \simeq \frac{1}{2\pi} e^x \int_0^{2\pi} d\phi e^{-x(\phi-\pi)^2/2} \simeq \frac{1}{\sqrt{2\pi}} \frac{e^x}{\sqrt{x}} , \tag{3.19}$$

where we relied on the fact that in our case x is large (because \mathcal{V} and \mathcal{W} are large). Since we are interested in the effective potential $-\mathcal{W}V_{\text{eff}}(\theta_0) \simeq \ln Z_{\text{wh}}$, we can focus on the exponential factor:

$$Z_{\text{wh}} \sim \exp \left[2K e^{-S} (\mathcal{V} + \mathcal{W} \cos \theta_0) \right] . \tag{3.20}$$

From here it is clear that, to explain the $\mathcal{W} \cos \theta_0$ term, the effective action for θ must contain a potential (which in our case contributes only in the region $I \times \mathbb{R}^3$):

$$V_{\text{eff}}(\theta_0) \sim 2K e^{-S} \cos \theta_0 . \tag{3.21}$$

The θ -dependency is as in the case of an instanton-anti-instanton gas without any constraints imposed. Actually, the term generated by wormhole instantons, which looks like a potential term for the field configuration (3.10), is in fact a non-local interaction term. This can be seen by modifying (3.10) such that $\theta(x) = \theta_{\mathcal{V}} \neq 0$ for $x \in \mathcal{V}$. Then, $\cos(\theta_0)$ in (3.20) is replaced by $\cos(\theta_0 - \theta_{\mathcal{V}})$. Indeed the exponential now contains non-local terms. Globally, this non-local term preserves shift-symmetry. Nevertheless, we observe a crucial effect induced by Giddings-Strominger wormholes: the change of the action due to a local fluctuation, $S[\theta + \delta\theta] - S[\theta]$, corresponds to that induced by a potential $V(\delta\theta) \sim 2K \exp(-S) \cos(\delta\theta)$.

This can also be seen by applying Coleman’s computation [100] to our problem. We are then interested in computing the partition function $Z = \sum_n \langle n | e^{-HT} | n \rangle$. It is therefore sufficient to focus on transition functions $\langle n | e^{-HT} | m \rangle$, although transitions from $|m\rangle$ to $|n\rangle$ will occur as well (the Hamiltonian H is in general non-diagonal in this basis). Due to the trace we do not need to consider the latter in our calculation. The result of this computation has to be compared with the partition function $Z = \int_0^{2\pi} d\theta \langle \theta | e^{-HT} | \theta \rangle / (2\pi)$ in the θ -language.

In the free theory n is the dual variable to our axion field θ , which can be seen as follows: the free theory action for the axion is given by $S = \int d^4x f^2 \dot{\theta}^2 / 2$ or, after integrating out the spatial directions, $S = \int dt A \dot{\theta}^2 / 2$ with $A \equiv f^2 V_3$, where V_3 is the 3-volume (θ is then the zero mode). The canonical momentum p is then given by $p = A \dot{\theta}$. As it is well known from quantum mechanics on S^1 , p is quantised as $p = n \in \mathbb{Z}$. One can therefore relate $|\theta\rangle$ -states to $|n\rangle$ -states via

$$|\theta\rangle = \sum_n e^{in\theta} |n\rangle \tag{3.22}$$

in the free theory (see also [88]), where we chose the normalisation $\langle \theta | \theta' \rangle = 2\pi \delta(\theta - \theta')$. The Hamiltonian of the free theory is then given by $H = n^2 / (2A)$ and in the free theory we have the transition amplitude

$$\langle n | e^{-HT} | n \rangle_{\text{free}} = e^{-Tn^2 / (2A)} . \tag{3.23}$$

Let us now return to interacting theory and take into account the effects of the wormhole gas induced by the coupling of θ to gravity. We assume that instantons and anti-instantons are randomly distributed and that wormhole ends can have arbitrarily long separation with no physical effect. By applying Coleman’s formula (3.1) to our situation and taking into account (3.23), we find:

$$\langle n | e^{-HT} | n \rangle = e^{-Tn^2 / (2A)} \sum_{N=0}^{\infty} \frac{1}{N! N!} (K e^{-S_0 T})^{2N} . \tag{3.24}$$

We emphasise once more that off-diagonal elements $\langle m | e^{-HT} | n \rangle$ are in general non-zero. For instance, if T corresponds to half of the time interval of figure 6, the instanton number

clearly changes by unity. However, such off-diagonal elements never appear explicitly in our calculation, which relies solely on the partition function.

We can once again express the sum in (3.24) by I_0 via (3.16) and then use the integral expression (3.18) with integration variable θ . We find:

$$\langle n|e^{-HT}|n\rangle = e^{-Tn^2/(2A)} \int_0^{2\pi} \frac{d\theta}{2\pi} \exp\left(-2KT \cos\theta e^{-S_0}\right). \quad (3.25)$$

For the partition function $Z = \sum_n \langle n|e^{-HT}|n\rangle$ one then obtains

$$Z(T) \simeq \sqrt{\frac{2\pi A}{T}} \int_0^{2\pi} \frac{d\theta}{2\pi} \exp\left(-2KT \cos\theta e^{-S_0}\right). \quad (3.26)$$

As we already mentioned, this should be compared with

$$Z = \int_0^{2\pi} \frac{d\theta}{2\pi} \langle \theta|e^{-HT}|\theta\rangle. \quad (3.27)$$

For a first naive comparison of (3.26) and (3.27) we ignore the non-exponential T -dependence in the prefactor of (3.26).¹² Then $|\theta\rangle$ is an eigenbasis of the Hamiltonian with eigenvalues $V(\theta)$. We see by comparison with (3.26) that $V(\theta) = 2 \cos\theta K e^{-S_0}$.

We can, however, be more precise and understand also the prefactor. To do so we observe that (3.26) was derived on the basis of (3.24), and in this equation a non-trivial approximation was made: indeed, we placed the factor $\exp(-Tn^2/(2A))$ outside the instanton sum. In general, that is not justified for the following reason. If we start at $t = 0$ with flux number n , and the first instanton occurs e.g. at $t = T_1$, we get a factor $\exp(-T_1 n^2/(2A))$ from the kinetic term. If then the next instanton occurs at T_2 , we get a further factor $\exp(-T_2(n+1)^2/(2A))$ and so on. The times T_i have to be integrated over and these prefactors can not be extracted from the instanton sum. However, we can find conditions under which it is safe to approximate the $(n + N_i)^2$ in the exponents (where N_i is the number of instantons present at some given time) simply by n^2 . To do so we note that, on the one hand, the instanton sum is dominated by instanton numbers of the order of

$$\langle N \rangle \sim K e^{-S_0} T. \quad (3.28)$$

On the other hand typical values of n dominating the sum over $\exp(-Tn^2/(2A))$ are of the order of $n \sim \sqrt{A/T}$. Thus, disregarding N_i relative to n in the $(n + N_i)^2$ -terms will be justified if

$$\langle N \rangle \ll \sqrt{A/T} \quad \text{or} \quad A \gg \langle N \rangle^2 T. \quad (3.29)$$

Given that we anyway choose T large enough to ensure $\langle N \rangle \gg 1$, this implies in particular $A \gg T$.

With this in mind, we return to the corresponding quantum mechanical model. We conjecture that the instanton dynamics is captured by an effective potential $V(\theta) =$

¹²Our parametrisation is then equivalent to $Z(T) = \int dE \rho(E) e^{-ET}$. Thus, we found the partition function. The latter characterises the system unambiguously.

$2 \cos(\theta) K e^{-S_0}$. To confirm this, we calculate the partition function

$$Z(T) \simeq \frac{1}{Z(0)} \int d\theta \int_{\tilde{\theta}(0)=\theta}^{\tilde{\theta}(T)=\theta} d[\tilde{\theta}] \exp \left[- \int_0^T dt \left(A \frac{\dot{\tilde{\theta}}^2}{2} + V(\tilde{\theta}) \right) \right]. \quad (3.30)$$

It has to be compared to (3.26) to establish the correctness of the chosen effective description and, in particular, the potential. But working out (3.30) in the regime $A \gg T$ is easy. Indeed, if we first disregard the potential, we are simply dealing with a 1-dimensional system on the interval $(0, 2\pi)$ and a kinetic-term prefactor A . This prefactor sets the minimum time by which any wave packet unavoidably spreads to an $\mathcal{O}(1)$ width due to quantum dynamics. In addition, the potential has a maximal steepness $|V'| \sim K e^{-S_0}$, leading to a displacement of $K e^{-S_0} T^2 / A \sim \langle N \rangle T / A$ during a time interval T . Our previously derived conditions on A , which underly our derivation of (3.26), are sufficient to ensure that the particle moves only by a distance $\Delta\theta \ll 1$ during the time T . Hence, in evaluating (3.30) we can approximate $V(\tilde{\theta}(t)) \simeq V(\theta)$. The path integral then becomes that of free particle, to be evaluated on times too short for the periodicity of the configuration space to be relevant. One obtains the well-known time-dependence $\sim \sqrt{A/T}$ of the amplitude, to be multiplied by the integral over $\exp(-TV(\theta))$. This is now in perfect agreement with (3.26).¹³

Thus, we find that Giddings-Strominger wormholes give rise to an effective potential $V(\theta) \sim 2K e^{-S} \cos \theta$ in two independent approaches. We wish to remark that in both approaches we can be agnostic about details of the interpretation of wormholes connecting to baby-universes. Crucially, the axionic shift-symmetry is broken locally even if the condition of having equally many instantons and anti-instantons is imposed on the global space-time.

Finally, we wish to remark that the correct choice of the combinatorial factors is a subtle issue. We interpreted a configuration of N wormholes as an instanton-anti-instanton-gas with (anti-)instantons randomly distributed. It is then plausible to include the combinatorial factor $1/(N!)^2$. However, one might argue that each instanton has a corresponding anti-instanton and therefore we should multiply by $N!$ to account for the number of possible pairings. If we assume that the right combinatorial factor is just $1/N!$, we can still do the computation starting with (3.7). We then still get $\cos \theta_0$, but this time the energy density in $I \times \mathbb{R}^3$ scales with

$$V(\theta_0) \sim K^2 \mathcal{V} e^{-2S} \cos \theta_0, \quad (3.31)$$

which diverges as $\mathcal{V} \rightarrow \infty$. Possibilities to avoid this divergence were discussed in [102–105], mostly in the baby-universe interpretation of Giddings-Strominger wormholes. It is possible to express the partition function as an integral over a parameter α , which is an eigenvalue of a baby-universe operator [103].

We rather follow Preskill [104] to sketch the idea of how to evade the divergence: for a combinatorial factor $1/N!$ the partition function reads

$$Z \sim \sum_{N=0}^{\infty} \frac{C^N}{N!} = e^C, \quad (3.32)$$

¹³While our analysis establishes the quantum mechanical model with effective potential $V(\theta) = 2 \cos(\theta) K e^{-S_0}$ only for a certain range of T , we expect it to be valid also for $T \rightarrow \infty$.

where

$$C \sim \bar{z}z, \quad z \equiv K\mathcal{V}e^{-S}e^{i\theta}. \quad (3.33)$$

Clearly, $C \sim \mathcal{V}^2$. But formally, we can write

$$Z \sim \int d\alpha d\bar{\alpha} e^{-\bar{\alpha}\alpha + \alpha\bar{z} + \bar{\alpha}z}. \quad (3.34)$$

If α is integrated out we obtain the divergent result (3.31). (To see $\cos\theta_0$ coming in one has to group terms carefully as in our first computation.) If, as suggested by Preskill [104], one has to fix α to a certain value, the energy density is simply given by¹⁴

$$\rho \sim \alpha e^{-S} \cos\theta. \quad (3.35)$$

In any case, no matter which combinatorial factor is correct and no matter how to interpret α , we always find that a term $\cos\theta$ arises in the effective action.

To summarise, we conclude that Euclidean wormholes are expected to induce an instanton potential $\sim \cos\theta e^{-S}$. It would be interesting to study whether this can be seen more directly by building an analogy between gravitational and gauge instantons, where the role of the term $\theta\text{Tr}(F \wedge F)$ is played by $\theta\text{Tr}(R \wedge R)$.

In the following we apply the presented derivation of the instanton potential to cases of $S = nS_0$, giving rise to potentials of the form $\sum_n \cos(n\theta)e^{-nS_0}$.

4 The limit of validity of gravitational instanton actions

In this section we summarise the instanton actions for all cases $C < 0$, $C = 0$ and $C > 0$ and find limits for the validity of the computation. Qualitatively, we have

$$S \sim \frac{n}{f_{\text{ax}}} \quad (4.1)$$

in all three cases. This is of course already known for Euclidean wormholes, see e.g. [9, 28, 75–81] and also for $C \geq 0$, see e.g. [17, 75].

Furthermore, we address one concern raised in [75]: the cored gravitational instanton solutions have a singularity at $r = 0$ and hence it is unclear whether these solutions can be trusted all the way to the limit $r \rightarrow 0$. In fact, we expect a breakdown of the solutions at some radius $r = r_c > 0$, which will be estimated in section 6. We expect such a cutoff radius to be present in any extra-dimensional theory independently of whether a curvature singularity exists or not. Therefore, even the extremal instantons, which do not have singularities, should only be trusted down to $r = r_c$. The situation is different for the Euclidean wormhole solutions, where we can have full control over the solution as long as $r_0 \gtrsim r_c$, with $r_0 \equiv |C|^{1/4}$ being the radius of the wormhole throat at the centre.

¹⁴Nevertheless, the divergence remains disconcerting. For instance, the expectation value of the number of wormholes in a certain space-time region scales as $\langle N \rangle \sim \mathcal{V}^2$ and it is questionable whether the wormhole gas can be dilute in the limit $\mathcal{V} \rightarrow \infty$. See also discussions in e.g. [104, 106–108].

The limit of validity affects the computation of the instanton action. In the case of $C \geq 0$ one would usually integrate from $r = 0$ to infinity, but instead we can only rely on the contribution from the interval $(r_c, +\infty)$. Whenever a significant fraction of the action comes from $(0, r_c)$, we cannot trust the instanton actions computed in [17, 75] and we will discard these cases.

Thus, the initial task of this section is the evaluation of the on-shell contribution of the integral in (2.19). We proceed by using the equations of motion successively. Details of the computations are presented in appendix E.

At first, by tracing Einstein's equations, we can express the Ricci scalar by the trace of the energy-momentum tensor:

$$R = -T. \tag{4.2}$$

One can then rewrite (2.19) as

$$S = \int_M d^4x \sqrt{g} \mathcal{F}(\varphi) H^2. \tag{4.3}$$

However, this is not yet the full contribution to the instanton action, because the Gibbons-Hawking-York boundary term has to be taken into account. It is

$$S_{\text{GHY}} = - \oint_{\partial M} d^3x \sqrt{h} (K - K_0), \tag{4.4}$$

where h is the determinant of the induced metric on ∂M . K and K_0 are the traces of the extrinsic curvatures of ∂M in M and flat space, respectively.

Then, the instanton action is computed as

$$S_{\text{inst}} = S + S_{\text{GHY}} = \int_M d^4x \sqrt{g} \mathcal{F}(\varphi) H^2 - \oint_{\partial M} d^3x \sqrt{h} (K - K_0). \tag{4.5}$$

Henceforth, we restrict to the case $\mathcal{F}(\varphi) = \exp(-\alpha\varphi)/(3!f_{\text{ax}}^2)$. Using this together with the equation of motion (2.21) and (2.27), (2.34) or (2.35) depending on the choice of C , one can rewrite the first term, S , in the instanton action as an integral over φ . The contribution from S_{GHY} is computed by considering a surface of constant r , see [17] or appendix E.

In the following we analyse the instanton action case by case:

Case $C = 0$. Extremal instanton solutions go along with a flat metric ($C = 0$). Thus, we have

$$S_{\text{GHY}} = 0. \tag{4.6}$$

However, the fields φ and B have a non-trivial profile giving rise to non-vanishing contributions to the instanton action. The full contribution from $r = 0$ to $r = \infty$ is given by

$$S_{\text{inst}} = -\frac{n}{f_{\text{ax}}} \int_{\varphi(0)}^{\varphi(\infty)} d\varphi \exp(-\alpha\varphi/2) = \frac{2}{\alpha} \frac{n}{f_{\text{ax}}}. \tag{4.7}$$

As we explained previously, we cannot trust this computation for radii $r < r_c$. Nevertheless, as long as the main contributions to the action come from the regime $r > r_c$

the result (4.7) can still be used to estimate contributions to the instanton potential in section 6. One should therefore compare the contribution ΔS from the regime $r < r_c$ with (4.7). Unfortunately, the contribution ΔS is UV-sensitive. We assume, however, that the actual UV-contribution ΔS can be parametrically estimated by the naive formula

$$\Delta S = -\frac{n}{f_{\text{ax}}} \int_{\varphi(0)}^{\varphi(r_c)} d\varphi \exp(-\alpha\varphi/2) = \frac{2}{\alpha} \frac{n}{f_{\text{ax}}} \left(1 + \frac{\alpha n}{4A f_{\text{ax}}} \frac{1}{r_c^2}\right)^{-1}, \quad (4.8)$$

where we used (2.34) in the second step. Demanding that $\Delta S \ll S_{\text{inst}}$ implies

$$\frac{\alpha n}{4A f_{\text{ax}}} \gg r_c^2, \quad (4.9)$$

which in turn can be rewritten as a lower bound on S_{inst} :

$$S_{\text{inst}} \gg \frac{8A}{\alpha^2} r_c^2. \quad (4.10)$$

This bound depends on the cutoff r_c and the dilaton coupling α . Interestingly, the bound gets weaker for larger α such that contributions from gravitational instantons become increasingly important with increasing α . However, as we will describe in subsection 5.2, a regime of large dilaton coupling α may not be attainable in string theory. We find that only rather small values of $\alpha \sim \mathcal{O}(1)$ arise from the simplest string compactifications.

Before addressing the next case, we want to point out that (4.7) can be rewritten as

$$S_{\text{inst}} = \ell M_{\text{ADM}} \quad (4.11)$$

in the case of $\alpha = 2\sqrt{2/3}$, where M_{ADM} is the ADM-mass of our *extremal* 5d RN-black hole of subsection 2.3, which is consistent with e.g. [17, 89, 99].¹⁵

Case $C > 0$. The Gibbons-Hawking-York boundary term yields

$$S_{\text{GHY}} = -3Ar^2 \left(\sqrt{1 + \frac{C}{r^4}} - 1 \right) \Big|_{r_c}^{\infty} = 3Ar_c^2 \left(\sqrt{1 + \frac{C}{r_c^4}} - 1 \right), \quad (4.12)$$

where $A = 2\pi^2$.

The contribution from (2.19) is given by the integral

$$\begin{aligned} S &= -\frac{n^2}{A f_{\text{ax}}^2} \int_{\varphi(r_c)}^{\varphi(\infty)} \frac{\exp(-\alpha\varphi)}{\sqrt{n^2 \exp(-\alpha\varphi)/(A^2 f_{\text{ax}}^2) + 6C}} = \\ &= \frac{2n}{\alpha f_{\text{ax}}} \sqrt{\exp(-\alpha\varphi) + \sinh^2 K_+} \Big|_{\varphi(r_c)}^{\varphi(\infty)}, \end{aligned} \quad (4.13)$$

where we used (2.36). Combining those two results and taking $r_c \rightarrow 0$, we obtain the instanton action

$$S_{\text{inst}} = \frac{2}{\alpha} \frac{n}{f_{\text{ax}}} \left(e^{-K_+} + \frac{\alpha}{2} \sqrt{\frac{3}{2}} \sinh K_+ \right). \quad (4.14)$$

¹⁵For the derivation of (4.11) we used that the black hole charge Q is related to n by $n = 2\pi^2 \sqrt{6}Q$. This can be obtained by dimensional reduction of the term $1/(2 \cdot 3!) \int (\star_5 \hat{F})^2$ together with $\hat{F}_{\tau\rho} = \sqrt{6}Q/\rho^3$ and (2.8).

As before, we need to ensure that the integral from $r = 0$ to $r = r_c$ only gives a minor contribution to the full instanton action (4.14). This contribution is

$$\begin{aligned} \Delta S &\equiv (S + S_{\text{GHY}})|_{r=0}^{r=r_c} = \\ &= \frac{2}{\alpha} \frac{n}{f_{\text{ax}}} \left[\sqrt{\exp(-\alpha\varphi(r_c)) + \sinh^2 K_+} - \left(1 - \frac{\alpha}{2} \sqrt{\frac{3}{2}}\right) \sinh K_+ \right] \\ &\quad - 3Ar_c^2 \left(\sqrt{1 + \frac{C}{r_c^4}} - 1 \right). \end{aligned} \tag{4.15}$$

In the limit $r_c^2/\sqrt{C} \ll 1$ this can be simplified to

$$\begin{aligned} \Delta S &= \frac{4n}{\alpha f_{\text{ax}}} \sinh K_+ \left(\frac{r_c^2}{2\sqrt{C}} \right)^{\frac{\alpha}{\sqrt{2/3}}} + 3Ar_c^2 + \dots \\ &= \frac{2n}{\alpha f_{\text{ax}}} \sinh K_+ \left[2 \left(\frac{r_c^2}{\sqrt{C}} \right)^{\frac{\alpha}{2\sqrt{2/3}}} + \frac{\alpha}{2} \sqrt{\frac{3}{2}} \left(\frac{r_c^2}{\sqrt{C}} \right) \right] + \dots, \end{aligned} \tag{4.16}$$

where omitted terms decrease as r_c^4/C . The condition $\Delta S \ll S_{\text{inst}}$ turns out to be self-consistent with the imposed regime $r_c^2/\sqrt{C} \ll 1$. More precisely, by choosing \sqrt{C} sufficiently large one can always ensure that $\Delta S \ll S_{\text{inst}}$. According to (2.36) this is equivalent to choosing $(n \sinh K_+)/f_{\text{ax}}$ sufficiently large. This is very similar to the parametric situation encountered above for $C = 0$.

To determine the strongest constraints on inflation we are interested in identifying the instantons with the smallest action. For a given value of n/f_{ax} and at a fixed dilaton coupling α cored gravitational instantons correspond to a family of solutions parameterised by K_+ (see subsection 2.2). We wish to identify the instanton with the smallest action in this family. As pointed out in subsection 2.3, while K_+ is expected to take discrete values, it can be effectively treated as a continuous parameter in the limit of macroscopic objects. Hence we can determine the solutions with the smallest action by formally extremising (4.14) with respect to K_+ as it was done in [17]. For $\alpha \geq 2\sqrt{2/3}$ the action of cored instantons is always bigger than that of extremal instantons. If $0 < \alpha < 2\sqrt{2/3}$, the smallest cored instanton action is as big as the extremal instanton action for $\alpha = 2\sqrt{2/3}$. To summarise, we obtain

$$S_{\text{cored}}(\alpha) \geq \begin{cases} S_{\text{extremal}}(\alpha) & \text{for } \alpha \geq 2\sqrt{2/3} \\ S_{\text{extremal}}(\alpha = 2\sqrt{2/3}) & \text{for } \alpha < 2\sqrt{2/3} \end{cases}, \tag{4.17}$$

where the extremal instanton action was computed above in (4.7). The upshot is that the contributions to the axion potential due to cored gravitational instantons will always be subleading compared to the effects due to a suitable extremal instanton. As we are interested in determining the strongest constraints on axion inflation, we will hence neglect cored instantons in the following analyses and focus on extremal instantons and Euclidean wormholes instead.

Case $C < 0$. For Euclidean wormholes the coordinate r is defined on $r \in [r_0, +\infty)$, where $r_0 \equiv |C|^{1/4}$ is the size of the wormhole at the centre. As long as $r_0 \gtrsim r_c$ one can safely integrate from $r = r_0$ to $r = \infty$. As $r_0 \equiv |C|^{1/4} \propto n/f_{ax}$ (see (2.28)) the condition $r_0 \gtrsim r_c$ can be fulfilled by choosing n/f_{ax} sufficiently large.

As pointed out in subsection 2.2 we will only consider wormholes with dilaton couplings $\alpha < 2\sqrt{2/3}$ in order to have regular solutions for φ . We then proceed with calculating the action. The Giddings-Hawking-York boundary term vanishes [28],

$$S_{\text{GHY}} = 0, \tag{4.18}$$

since two asymptotically flat regions are connected by a handle and thus the integral gives zero. The on-shell contribution from (2.19) for only half of the wormhole¹⁶ is given by

$$\begin{aligned} S_{\text{inst}} &= -\frac{n^2}{A f_{ax}^2} \int_{\varphi(r_0)}^{\varphi(\infty)} \frac{\exp(-\alpha\varphi)}{\sqrt{n^2 \exp(-\alpha\varphi)/(A^2 f_{ax}^2) - 6|C|}} = \\ &= \frac{2}{\alpha} \frac{n}{f_{ax}} \sin\left(\frac{\alpha\pi}{4} \sqrt{\frac{3}{2}}\right), \end{aligned} \tag{4.19}$$

where we used the solutions for $C < 0$ from subsection 2.2. Notice that the limit $\alpha \rightarrow 0$ corresponds to the Giddings-Strominger wormhole [28], and we have

$$S_{\text{inst}} = \frac{\pi\sqrt{6}}{4} \frac{n}{f_{ax}}. \tag{4.20}$$

Furthermore, in the limit $\alpha \rightarrow 2\sqrt{2/3}$ we find the instanton action of an extremal instanton with $\alpha = 2\sqrt{2/3}$.

Summary. We summarise our results for the instanton action. For one, the instanton action S_{inst} scales as $S_{\text{inst}} \sim n/f_{ax}$ for all three types of gravitational instanton. Results were obtained in an effective theory with a cutoff at a length scale r_c . The existence of this cutoff implies that not all gravitational instanton solutions can be trusted in the framework of the effective theory. One can derive a criterion for deciding which gravitational instantons to include. While numerical factors may vary, this condition exhibits the same parametric behaviour for all three types of gravitational instantons: given a cutoff at a length scale r_c one has to choose $n/f_{ax} \gg r_c^2$ for being able to trust the instanton action computed in the effective theory.

In order to determine the importance of such gravitational instantons it is crucial to estimate the size of the cutoff scale r_c . The first step is to see whether moduli stabilisation places a lower bound on r_c .

5 Gravitational instantons and moduli stabilisation

We now want to make progress towards realistic string compactifications. The pure Einstein-axion system is relevant only below the moduli scale. Above that scale, moduli can play the role of an additional scalar φ with dilatonic coupling to the axion or

¹⁶To get the instanton action, we have to divide the full wormhole action by two, as the wormhole represents a pair of instanton and anti-instanton. For more details, see appendix E.

2-form kinetic term. We will make use of our detailed discussion of this extended system in section 2 and section 4.

5.1 Gravitational instantons in the presence of a potential

We only consider the lightest modulus, which we will call φ . For instance, it could be the saxion associated with the axion θ . We will assume stabilisation at $\varphi = 0$. In the throat region of the instanton, the modulus will be typically driven away from this value. We will assume that this displacement is small enough so that the potential of the modulus can be approximated by a mass term, i.e. $V = m^2\varphi^2/2$.

The obvious extension of (2.2) is then

$$S = \int d^4x \sqrt{g} \left[-\frac{1}{2}R + \frac{1}{2}\mathcal{F}(\varphi)H^2 + \frac{1}{2}g^{\mu\nu}\partial_\mu\varphi\partial_\nu\varphi + V(\varphi) \right]. \quad (5.1)$$

We take \mathcal{F} to be exponential, which is the case discussed in detail earlier and which is typical for string-derived models (see subsection 5.2). Nevertheless, due to the presence of the potential, solutions are more complicated than before. We make the most general ansatz respecting spherical symmetry

$$ds^2 = \lambda(r)dr^2 + r^2d\Omega_3^2, \quad (5.2)$$

as in appendix A. From the derivation therein it becomes clear that $\lambda(r)$ is no longer given by $(1 + C/r^4)^{-1}$. However, we will see that for $r \ll r_* \equiv 1/m$ the mass term is negligible and we can use the approximation $\lambda(r) \simeq (1 + C/r^4)^{-1}$ (cf. the related discussion in [78]). Thus, the three types of gravitational instantons analysed above remain relevant.

The fact that the mass term is negligible close to the centre of the instanton is intuitively clear: the field strength contribution to the energy-momentum tensor increases as one approaches the centre and hence, for sufficiently small r , the contribution from the mass term becomes subdominant. This will become more explicit below.

Employing (5.2), the Einstein equation $G_{rr} = T_{rr}$ and the Klein-Gordon equation read

$$\frac{1}{2}(\varphi')^2 - \lambda(r)V(\varphi) + \frac{3}{r^2}(\lambda(r) - 1) - 3\lambda(r)\mathcal{F}(\varphi)\frac{n^2}{A^2r^6} = 0 \quad (5.3)$$

$$\varphi'' + \left(\frac{3}{r} - \frac{\lambda'(r)}{2\lambda(r)} \right) \varphi' - \lambda(r)V'(\varphi) - 3\lambda(r)\mathcal{F}'(\varphi)\frac{n^2}{A^2r^6} = 0. \quad (5.4)$$

Here we also used (2.22) and (2.24), which specify the profile of H .

Approximation. As already sketched above, the strategy is as follows: let $\varphi_0(r)$ and $\lambda_0(r) \equiv (1 + C/r^4)^{-1}$ be the field and metric profiles for $V \equiv 0$. Then we work out the conditions under which

$$T_{rr}(\varphi_0, \lambda_0) \gg V(\varphi_0). \quad (5.5)$$

This specifies the regime where we can expect the $\varphi_0(r)$ and $\lambda_0(r)$ to provide good approximations to the true solutions $\varphi(r)$ and $\lambda(r)$.

We now go into more detail: the full energy-momentum tensor of (5.1) reads

$$T_{\mu\nu} = -g_{\mu\nu} \left[\frac{1}{2}\mathcal{F}(\varphi)H^2 + \frac{1}{2}\partial_\rho\varphi\partial^\rho\varphi + V(\varphi) \right] + 3\mathcal{F}(\varphi)H_{\mu\rho\sigma}H_\nu{}^{\rho\sigma} + \partial_\mu\varphi\partial_\nu\varphi. \quad (5.6)$$

Taking $\varphi = \varphi_0$ and $\lambda = \lambda_0$ we find

$$T_{rr}(\varphi_0, \lambda_0) = \frac{3C}{r^6(1 + C/r^4)} - \frac{V(\varphi_0)}{1 + C/r^4}, \quad (5.7)$$

where (2.25) was used. We see that the potential is negligible compared to the curvature contributions if (for $C \neq 0$)

$$\left| \frac{3C}{r^6} \right| \gg \frac{1}{2} m^2 \varphi_0^2. \quad (5.8)$$

Appealing again to (2.25), we first consider the regime $r \gg |C|^{1/4}$. Then $\varphi'_0(r) \sim 1/r^3$ and hence

$$\varphi_0(r) \sim \frac{1}{r^2}. \quad (5.9)$$

Here we treat n/A and C as ‘ $\mathcal{O}(1)$ factors’ and disregard them. We explain this below.

With this, (5.8) translates to

$$r \ll r_* \equiv \frac{1}{m}. \quad (5.10)$$

Now, our interest is in the case $m \ll 1$, i.e. in moduli much lighter than the Planck scale. This implies $r_* \gg 1$ so that $r_* \gg |C|^{1/4}$, giving us a large validity range for our approximation $\varphi_0 \sim 1/r^2$. Crucially, while $|C|$ also figured as a large parameter in other parts of this paper, here the much stronger hierarchy $1/m \gg 1$ dominates and our crude approximation concerning ‘ $\mathcal{O}(1)$ factors’ is justified.

Next, we need to consider the region $r \lesssim |C|^{1/4}$. While here the profile $\varphi_0(r)$ is more complicated, we are now deeply inside the regime of large field strength. It is easy to convince oneself that the potential $\sim m^2 \varphi^2$ remains subdominant. What is less obvious is whether the $m^2 \varphi^2$ approximation remains justified, given that the field now moves significantly away from zero. This will be discussed later.

Finally, the extremal instanton with $C = 0$ requires an extra comment. In this case the energy-momentum tensor vanishes and the criterion (5.8) is no longer applicable. Instead, we require that the mass term in (5.3) should be subdominant compared to every other term in this equation, i.e.

$$m^2 \varphi_0^2 \ll \frac{3\mathcal{F}(\varphi_0)n^2}{A^2 r^6}, \quad (5.11)$$

which yields again the condition $r \ll 1/m$ (here we used that \mathcal{F} is approximately constant for large r). Note that in this case the behaviour of φ_0 at large r is specified by (2.34) and the role of the ‘largish’ parameter $|C|^{1/4}$ is taken over by n/f_{ax} .

To summarise, we have now argued rather generally that the gravitational solutions found in the absence of a potential are good approximations for $r \ll 1/m$. We will not need the behaviour of φ outside that region, at $r \rightarrow \infty$. Indeed, by redefining φ we can, as argued before, always ensure that the φ_0 asymptotically approaches the minimum of the potential at $\varphi = 0$. Thus, even while the actual profile of $\varphi(r)$ can significantly deviate from $\varphi_0(r)$ at $r \gg 1/m$, there is no doubt that the fundamental property of φ approaching zero at large r will be maintained. Crucially, since $1/m \gg |C|^{1/4}$ and the action integral is dominated by the region $r \lesssim |C|^{1/4}$, we can also trust the zero-potential solutions for evaluating the action, independently of the large- r region.

5.2 Dilaton couplings from string compactifications

The gravitational solutions in subsection 2.2 were obtained for scalars with dilatonic couplings, i.e. where the prefactor of the kinetic term for the axion is given by $\mathcal{F}(\varphi) = e^{-\alpha\varphi}/(3!f_{\text{ax}}^2)$. This form frequently occurs for effective theories obtained from string theory compactifications. The value of α will depend on the precise identification of the axion and scalar with the corresponding fields in the string compactifications. In the following, we will provide relevant examples.

The axio-dilaton. Let us first consider the case where both the axion and the scalar descend from the axio-dilaton field $S = C_0 + i/g_s$ with string coupling g_s and universal axion C_0 . It appears in the Kähler potential as

$$\mathcal{K} = -\ln\left(-i(S - \bar{S})\right). \tag{5.12}$$

The kinetic term of the Lagrangian $\mathcal{L} \supset \mathcal{K}_{S\bar{S}}\partial_\mu S\partial^\mu \bar{S}$ then becomes

$$\mathcal{L} \supset \frac{g_s^2}{4}(\partial C_0)^2 + \frac{1}{4g_s^2}(\partial g_s)^2. \tag{5.13}$$

Canonical normalisation of our saxion gives $g_s = g_s^0 \exp(\sqrt{2}\varphi)$. Thus, the field strength coupling reads

$$\mathcal{F}(\varphi) = \frac{1}{2 \cdot 3!} \frac{1}{\mathcal{K}_{S\bar{S}}} = \frac{1}{3(g_s^0)^2} \exp(-2\sqrt{2}\varphi), \tag{5.14}$$

so in our notation the dilaton coupling α is $\alpha = 2\sqrt{2}$. Notice that $\varphi \rightarrow \infty$ corresponds to the strong coupling limit, while the weak coupling limit is given by $\varphi \rightarrow -\infty$.

Kähler moduli at large volume. Let us now consider the Kähler moduli sector at large volume. In particular, consider the case where the volume is dominated by one Kähler modulus T . For example, this arises in the scheme of moduli stabilisation known as the Large Volume Scenario (LVS) [93]. The relevant part of the Kähler potential is

$$\mathcal{K} = -2 \ln \mathcal{V} = -3(T + \bar{T}) + \dots \tag{5.15}$$

Here we wish to identify the saxion with $\text{Re}(T)$ and the axion with $\text{Im}(T)$. The leading contribution to the kinetic term for the saxion and axion is then given by

$$\mathcal{K}_{T\bar{T}} = \frac{3}{(T + \bar{T})^2}. \tag{5.16}$$

Canonical normalisation gives

$$\text{Re}(T) = \exp\left(-\sqrt{\frac{2}{3}}\varphi\right), \tag{5.17}$$

and hence

$$\mathcal{F}(\varphi) \sim \exp\left(-2\sqrt{\frac{2}{3}}\varphi\right). \tag{5.18}$$

The dilaton coupling is thus $\alpha = 2\sqrt{2/3}$.

Complex structure moduli in the Large Complex Structure limit (LCS). It is well-known that complex structure moduli in the LCS limit give rise to a shift-symmetric structure in the Kähler potential. Let u be a complex structure modulus in the LCS regime and z denote the remaining complex structure moduli. Then we have

$$\begin{aligned} \mathcal{K} = & -\ln \left(\kappa_{uuu}(u + \bar{u})^3 + \kappa_{uui}(u + \bar{u})^2(z_i + \bar{z}_i) + \frac{\kappa_{uij}}{2!}(u + \bar{u})(z_i + \bar{z}_i)(z_j + \bar{z}_j) \right. \\ & \left. + \frac{\kappa_{ijk}}{3!}(z_i + \bar{z}_i)(z_j + \bar{z}_j)(z_k + \bar{z}_k) + f(z_i) \right), \end{aligned} \quad (5.19)$$

where the κ_{ijk} denote the intersection numbers of the mirror-dual Calabi-Yau three-fold and f is a function of the remaining complex structure moduli z_i and accounts for instantonic corrections to the Kähler potential. For the moment only u shall be stabilised in the LCS limit, i.e.

$$\text{Re}(u) > 1. \quad (5.20)$$

Thus, one obtains

$$\mathcal{K}_{u\bar{u}} = \frac{3}{(u + \bar{u})^2} \quad (5.21)$$

at leading order as long as $\kappa_{uuu} \neq 0$. Omitted terms scale as $(u + \bar{u})^{-3}$. Therefore, canonical normalisation yields

$$\text{Re}(u) = \exp \left(-\sqrt{\frac{2}{3}}\varphi \right), \quad (5.22)$$

and hence $\alpha = 2\sqrt{2/3}$.

In the situations studied so far the saxion and axion arose from the same complex scalar field. However, one may also consider the case where the saxion and axion originate from different moduli. To give just one example, let us again consider the complex structure sector of a CY threefold, but now we will assume that two complex structure moduli u, v are in the LCS regime. Further, we assume the following hierarchy

$$\text{Re}(u) \gg \text{Re}(v) \gg 1. \quad (5.23)$$

We will now consider the axionic field $\text{Im}(v)$ and study the coupling to the saxion $\text{Re}(u)$. As before, the leading contribution to the kinetic term of the saxion is

$$\mathcal{K}_{u\bar{u}} = \frac{3}{(u + \bar{u})^2}, \quad (5.24)$$

and the canonically normalised saxion is given by (5.22). The leading contribution to the kinetic term for the axion is

$$\mathcal{K}_{v\bar{v}} \sim \frac{1}{(u + \bar{u})^2} \sim \exp \left(-2\sqrt{\frac{2}{3}}\varphi \right), \quad (5.25)$$

where omitted terms decrease as $(u + \bar{u})^{-3}$. While both $\mathcal{K}_{u\bar{u}}$ and $\mathcal{K}_{v\bar{v}}$ scale as $(u + \bar{u})^{-2}$, this behaviour has different origins in the two cases. The leading contribution to $\mathcal{K}_{u\bar{u}}$ comes from $\kappa_{uuu}(u + \bar{u})^3$, whereas it is the terms $\kappa_{uvv}(u + \bar{u})(v + \bar{v})^2$ and $\kappa_{uvv}(u + \bar{u})^2(v + \bar{v})$ which contribute to $\mathcal{K}_{v\bar{v}}$ at leading order.

Despite these differences we again find

$$\mathcal{F}(\varphi) \sim \exp\left(-2\sqrt{\frac{2}{3}}\varphi\right), \tag{5.26}$$

and $\alpha = 2\sqrt{2/3}$.¹⁷

Note that in all the cases examined above the dilaton coupling is just outside the range allowing for Euclidean wormhole solutions $0 \leq \alpha < 2\sqrt{2/3}$. This observation and a possible way out have been pointed out in [88, 109]. The idea is as follows. Even if wormholes charged under individual axions do not exist, one can nevertheless find solutions which are charged under more than one axion (see also [110]).

We will conclude this section with an example that allows for the existence of Euclidean wormhole solutions and may be useful to illustrate and develop the above idea. Let us consider both the axio-dilaton sector and the complex structure moduli sector of a CY 3-fold at LCS:

$$\mathcal{K} = -\ln(-i(S - \bar{S})) - \ln(\kappa_{uuu}(u + \bar{u})^3). \tag{5.27}$$

In the spirit of [88, 109, 110] we could now investigate Euclidean wormhole solutions charged under both the universal axion as well as the complex structure axion. Alternatively, we may assume that we can stabilise moduli such that $S = iu$. Then we effectively have the theory of one 4-fold complex structure modulus and we obtain

$$\mathcal{K}_{u\bar{u}} = \frac{4}{(u + \bar{u})^2}. \tag{5.28}$$

Taking the saxion as $\text{Re}(u)$ and the axion as $\text{Im}(u)$ we now find $\alpha = \sqrt{2}$ which lies within the range allowing for wormholes. We leave it for future work to investigate whether this pattern of moduli stabilisation can be realised in a realistic compactification.

5.3 Maximal field displacements of dilatonic fields

In the previous sections we have made progress towards studying gravitational instantons in the presence of moduli. The results of subsection 5.2 imply that a restriction to moduli with dilatonic couplings is well-motivated from string compactifications. We also made progress towards understanding the role of the potential stabilising the modulus in subsection 5.1. In particular, in the regime $r \ll 1/m$ the potential can be ignored and gravitational instanton solutions for a massless dilaton will be good approximations.

There is another effect which we need to take into consideration. When approaching the core of a gravitational instanton, the value of the dilaton increases. In the case of a Euclidean wormhole it reaches a maximum at the wormhole throat, while for extremal and cored instantons the dilaton diverges for $r \rightarrow 0$. However, we cannot afford arbitrarily large field displacements, as this will take us outside the range of validity of our effective theory.

¹⁷This would be different if κ_{uuu} and κ_{vvv} were the only non-vanishing intersection numbers. Then we would still have $\mathcal{K}_{u\bar{u}} \simeq 3/(u + \bar{u})^2$ but now $\mathcal{K}_{v\bar{v}} \sim (v + \bar{v})/(u + \bar{u})^3$ for $\text{Re}(u) \gg \text{Re}(v)$. Assuming that $\text{Re}(v)$ is stabilised such that we can take it as constant, we would now find a dilaton coupling $\alpha = \sqrt{6}$.

To be specific, consider the effective theory of the axio-dilaton at weak string coupling. When approaching the centre of a gravitational instanton solution the string coupling increases compared to its asymptotic value. If it becomes too large the supergravity regime breaks down and we cannot trust our solutions. A similar argument can be made for any effective dilaton-axion theory from string compactifications.

This gives us an additional criterion to decide which gravitational instantons to trust and which ones to disregard. We will analyse this condition focussing on Euclidean wormholes and extremal gravitational instantons. In the following, we will denote by φ_{\max} the threshold value at which the effective theory breaks down.

Euclidean wormholes. For Euclidean wormholes the displacement becomes maximal at the throat of the wormhole. Using our solution for $\varphi(r)$ (2.32) one finds:

$$\varphi(r_0) = -\frac{1}{\alpha} \ln \cos^2 \left(\frac{\alpha\pi}{4} \sqrt{\frac{3}{2}} \right). \tag{5.29}$$

To trust the wormhole solution we require $\varphi(r_0) < \varphi_{\max}$. The maximal displacement only depends on the dilaton coupling α , which is not a free parameter, but a property of the physical system studied. As a result the maximal displacement is model-dependent.

Recall that Euclidean wormhole solutions only exist for dilaton couplings in the range $0 \leq \alpha < 2\sqrt{\frac{2}{3}}$. The maximal displacement at the wormhole throat is smallest for $\alpha = 0$, grows when α is increased and eventually diverges for $\alpha \rightarrow 2\sqrt{\frac{2}{3}}$. To give just one example, the value $\alpha = \sqrt{2}$ yields a displacement $\varphi(r_0) - \varphi(\infty) = \varphi(r_0) \simeq 2.2$ in Planck units, which may already be critical.

Another important result from this section is that the maximal displacement $\varphi(r_0)$ is independent of the ratio n/f_{ax} , or, equivalently, the wormhole radius at the throat r_0 . Hence we do not get any additional constraints on these quantities due to the displacement of the saxion.

Extremal instantons. For extremal gravitational instantons the φ -profile exhibits a divergent behaviour for $r \rightarrow 0$. As laid out in section 4, we will nevertheless trust such solutions as long as the dominant part of the instanton action arises from the region $r > r_c$, where r_c is the length cutoff of our effective theory. This cutoff will be discussed in more detail in subsection 6.2. Here we will show that the displacement of the saxion gives an independent condition for the reliability of our action.

Let us be more precise. Given a threshold value φ_{\max} beyond which our theory breaks down, we can identify a radius r_{\min} at which the dilaton crosses this value: $\varphi(r_{\min}) = \varphi_{\max}$. This can be made explicit using (2.34):

$$e^{\alpha\varphi_{\max}} = \left(1 + \frac{\alpha n}{4Af_{\text{ax}}} \frac{1}{r_{\min}^2} \right)^2. \tag{5.30}$$

To trust our solution we need to ensure that $\Delta S/S \ll 1$, where ΔS is the contribution to the instanton action from the region $r < r_{\min}$. Using (4.7) and (4.8) we find

$$\frac{\Delta S}{S} = \left(1 + \frac{\alpha n}{4Af_{\text{ax}}} \frac{1}{r_{\min}^2} \right)^{-1} = \exp \left(-\frac{\alpha}{2} \varphi_{\max} \right). \tag{5.31}$$

Hence the relevant condition is

$$\exp\left(-\frac{\alpha}{2}\varphi_{\max}\right) \ll 1, \tag{5.32}$$

which gives an additional (model-dependent) constraint.

Last, let us return to one aspect encountered for the case of Euclidean wormholes. There we observed that for $\alpha \rightarrow 2\sqrt{\frac{2}{3}}$ the saxion displacement at the wormhole throat grows without bound and would exceed any finite value φ_{\max} . Note that this does not necessarily constitute a pathology. Rather, the behaviour observed for a wormhole becomes similar to that of an extremal instanton. In fact, in the limit $\alpha \rightarrow 2\sqrt{\frac{2}{3}}$ the Euclidean wormhole becomes a pair of extremal instantons. We can then deal with the divergence of φ as in the case of extremal instantons and cut our solution off at some $r = r_{\min}$.

6 Consequences for large field inflation

In this section we will analyse to what extent gravitational instantons constrain axion inflation. The idea is as follows: we will check whether the contribution to the axion potential δV due to gravitational instantons can be large enough to disrupt inflation.

To be specific, gravitational instantons contribute as

$$\delta V = \mathcal{A} \cos(n\theta) e^{-S}, \tag{6.1}$$

where $S \sim n/f_{\text{ax}}$ (see section 4). Whether such instanton corrections can have significant influence on the slow-roll dynamics clearly depends both on the size of the instanton action S and the prefactor \mathcal{A} . The latter is quoted to be of order M_p^4 [8, 9]. However, in appendix F we give arguments why the prefactor \mathcal{A} can be significantly below the Planck scale in more realistic string compactification models. Specifically, we expect \mathcal{A} to scale as $\mathcal{A} \sim \mathcal{V}^{-5/3}$ with compactification volume \mathcal{V} .

We then compare δV with the size of the axion potential during inflation. For large field inflation the scale of inflation is of the order [111]

$$V_{\text{inflation}} \sim 10^{-8}. \tag{6.2}$$

Hence, whenever we find $\delta V \sim 10^{-8}$ we will conclude that the effects of gravitational instantons on the axion potential are in principle large enough to spoil inflation.

In what follows we compute δV only for the case of a single axion, but our results can be straightforwardly extended to models of N -flation, kinetic alignment and the Kim-Nilles-Peloso mechanism, see [9] for more details.

6.1 Action of the most ‘dangerous’ gravitational instantons

To check whether gravitational instantons are dangerous for inflation, we want to focus on the instantons with the smallest action. At the same time, we need to ensure that these are solutions which we can trust within the framework of our effective theory. In brief, we are interested in the most relevant instanton within the regime of validity of our theory.

The breakdown of our effective gravity theory is crucial in this context, because it will put a lower bound on the instanton action S . As explained in section 4, in a theory with length cutoff r_c we can only trust gravitational instanton solutions with $n/f_{\text{ax}} \gg r_c^2$. This translates into a lower bound on the instanton action as $S \sim n/f_{\text{ax}}$.

To calculate the contributions of gravitational instantons to the axion potential we hence need to determine the cutoff r_c . In subsection 6.2 we will estimate the smallest possible value of r_c at which the description in terms of a 4-dimensional theory may hold. Before doing this it will be instructive to check how large r_c can be so that gravitational instantons still induce a sizeable contribution to the inflaton potential.

Note that gravitational instanton solutions for the case of a massless dilaton will be sufficient for our analysis, despite the fact that we are interested in the case of massive dilaton fields. As described in subsection 5.1 the non-zero potential does not affect the action significantly.

Euclidean wormholes. For any n and f_{ax} the Euclidean wormhole action is computed in (4.19). At the same time the wormhole radius r_0 scales as $r_0 \sim (n/f_{\text{ax}})^{1/2}$ according to (2.28). As we require $r_0 \gtrsim r_c$ we get

$$S_{\text{inst}} \gtrsim (2\pi^2)\sqrt{6}\frac{2}{\alpha} \tan\left(\frac{\alpha\pi}{4}\sqrt{\frac{3}{2}}\right) r_c^2. \tag{6.3}$$

On the allowed interval $0 \leq \alpha < 2\sqrt{2/3}$ the instanton action as a function of α increases monotonically. Therefore, the most dangerous wormhole corresponds to the Giddings-Strominger instanton with $\alpha = 0$. Hence

$$S_{\text{inst}} \geq S_{\text{inst}}(\alpha = 0) \gtrsim 3\pi^3 r_c^2. \tag{6.4}$$

Demanding that $e^{-S} \gtrsim 10^{-8}$ implies $r_c \lesssim 0.4$ (in Planck units).

In subsection 5.2 we found that $\alpha = \sqrt{2}$ can be obtained from string compactifications and still lies in the allowed range of dilaton-couplings appropriate to allow for Euclidean wormholes. This example requires $r_c \lesssim 0.2$ in order to get a contribution of at least $\delta V \sim 10^{-8}$.

Note that the prefactor \mathcal{A} (see appendix F) may potentially lower the size of the contribution to the inflaton potential.

Extremal gravitational instantons. The action for extremal gravitational instantons is obtained from (4.7). However, we have to take into account the computability condition (4.9) for the action. It follows that

$$S_{\text{inst}} > \frac{8 \cdot (2\pi^2)}{\alpha^2} r_c^2. \tag{6.5}$$

In string theory α cannot be chosen arbitrarily large. The largest α we could obtain from string compactifications was $\alpha = 2\sqrt{2}$. Extremal gravitational instantons then become relevant if $r_c \lesssim 1$. Hence, extremal gravitational instantons may turn out to be somewhat more dangerous for axion-inflation than Euclidean wormholes.

We do not consider cored gravitational instantons, for which a similar analysis could be made. The reason is that their action is always larger than that of a suitable extremal instanton (see section 4).

The question we want to address now is how small r_c can be in any controlled model of quantum gravity. Knowing that moduli displacements are not an issue, one would naively expect that $r_c \simeq 1$ can be problematic as we reach already Planck regime. Notice however that it is important to determine r_c as precisely as possible, because due to $\delta V \sim e^{-S} \sim e^{-r_c^2}$ the instanton contributions are very sensitive to every $\mathcal{O}(1)$ -factorchange in the cutoff radius.

6.2 Estimating the critical radius r_c

Let us take string theory as our model of quantum gravity. String compactifications then yield a hierarchy of scales in the effective theory as depicted in figure 1. We expect that going beyond the Kaluza-Klein scale will render our effective description insufficient. The reason is that the gravitational instanton solutions we consider are obtained in a 4-dimensional effective theory which arises from a more fundamental description upon compactification. For the 4-dimensional picture to remain valid, we require the length scale r_c associated with our 4-dimensional solution not to be smaller than the length scale associated to the compactified extra-dimensions.

But how small can this length scale be? In string theory it cannot be arbitrarily small. String compactifications exhibit a property termed T-duality which states that a compactification with a small volume describes the same physics as another compactification with large volume. This gives rise to the notion of a smallest length scale at the self-dual value of the compactification volume.

Putting everything together, we arrive at the smallest possible value r_c where we can trust our effective 4-dimensional analysis. We find that r_c should be related to the length scale of the compact dimensions at self-dual volume \mathcal{V}_{sd} of the compactification space. In this way, we push the KK-scale as close to the Planck scale as possible, allowing us to consider the lightest gravitational instantons we can obtain within the regime of validity of our description.

What we mean by “related” is at this naive level ambiguous. There are at least two “canonical” possibilities to make the definition of r_c more precise. They differ by factors of π , which are unfortunately crucial when comparing e^{-S} with $V_{inflation}$. Given the volume \mathcal{V}_{sd} of the six-dimensional compact space at the self-dual point we can define a length scale as $\mathcal{V}_{sd}^{1/6}$ and a 3-volume by $\mathcal{V}_{sd}^{1/2}$. Two possible definitions of r_c are then:

1. The volume of the S^3 of our wormhole solution should not be smaller than $\mathcal{V}_{sd}^{1/2}$, i.e.

$$2\pi^2 r_c^3 = \mathcal{V}_{sd}^{1/2}. \tag{6.6}$$

2. More generously, the great circle of S^3 should not be smaller than $\mathcal{V}_{sd}^{1/6}$, i.e.

$$2\pi r_c = \mathcal{V}_{sd}^{1/6}. \tag{6.7}$$

As a toy-model to compute \mathcal{V}_{sd} we take T^6 and apply T-duality six times for each S^1 to get $\mathcal{V}_{\text{sd}}(T^6) = \ell_s^6 = (2\pi)^6(\alpha')^3$. To convert this into Planck units, recall that (see e.g. [112])

$$M_p^2 = \frac{4\pi\mathcal{V}}{g_s^2\ell_s^8}. \quad (6.8)$$

In the following we also go to the S-self-dual point $g_s = 1$.

The first criterion (6.6) then gives $r_c M_p = \sqrt{4\pi} \cdot (2\pi^2)^{-1/3} \simeq 1.3$. Using (6.4) and (6.5), which are both in 4d Planck units, the contributions to the axion potential due to gravitational instantons are then:

$$\begin{aligned} \text{Giddings-Strominger wormhole:} & \quad e^{-S} \simeq 10^{-68}, \\ \text{extremal instantons:} & \quad e^{-S} \lesssim 10^{-15} \quad \text{for } \alpha = 2\sqrt{2}. \end{aligned}$$

Hence, in both cases the gravitational instantons appear to be irrelevant for inflation.

If we apply the second criterion (6.7) we have $r_c M_p = 1/\sqrt{\pi} \simeq 0.56$. This yields

$$\begin{aligned} \text{Giddings-Strominger wormhole:} & \quad e^{-S} \simeq 10^{-13}, \\ \text{extremal instantons:} & \quad e^{-S} \lesssim 10^{-3} \quad \text{for } \alpha = 2\sqrt{2}. \end{aligned}$$

Again, Euclidean wormholes contribute to the axion potential too weakly to interfere significantly with inflation. However, extremal instantons can in principle be important, but this will depend on the value of the dilaton coupling α . Note that for $\alpha = 2\sqrt{2/3}$ we still get $e^{-S} \lesssim 6 \cdot 10^{-9}$ for extremal instantons, which is marginal as far as the significance for inflation is concerned. However, we want to emphasise that our numerical results should be taken with a grain of salt. In particular, given a value of a length cutoff r_c we only have a lower bound (6.5) for the action of the most important trustworthy extremal instanton. However, δV is exponentially sensitive to the instanton action. Thus, unless the instanton action is close to saturating the inequality (6.5) the contributions from extremal instantons can quickly become irrelevant for inflation.

Of course, the instanton contribution $\delta V = \mathcal{A}e^{-S} \cos(n\theta)$ also involves the prefactor \mathcal{A} , which we estimate in appendix F. We expect $\mathcal{A} \sim \mathcal{V}^{-5/3}$, which is $\mathcal{O}(1)$ at the self-dual point. Note that in more realistic scenarios away from the self-dual point (i.e. compactifications with a hierarchy of scales) it would suppress the gravitational instanton contributions even further.

Our results can be summarised as follows: overall, we find that gravitational instantons do not give rise to strong *model-independent* constraints on axion inflation, even if we push the KK-scale as close to the Planck-scale as possible. Extremal gravitational instantons may be important for inflation, but this is model-dependent, as the size of their contribution depends on the value of the dilaton coupling α .

7 Gravitational instantons and the weak gravity conjecture

Finally, we want to make further remarks on the relation between gravitational instantons and the Weak Gravity Conjecture (WGC) [3, 9, 17]. The original form of the WGC requires

that the particle spectrum of a consistent, UV-complete gravitational theory with a U(1) gauge field contains at least one particle whose charge-to-mass ratio is larger or equal to that of an extremal black hole [3]. There exists a straightforward generalisation to gravitational theories with an axion coupling to instantons. In the following we will argue in analogy with the WGC for particles with U(1) charges, i.e. we will treat instantons like particles with axion charge.

We start with the theory of an axion with an instanton-induced potential:

$$\mathcal{L} = \frac{1}{2}(\partial\theta)^2 - \sum_i \Lambda_i^4 e^{-S_i} \cos\left(\frac{n_i}{f_{\text{ax}}}\theta\right). \tag{7.1}$$

The WGC then requires the existence of an instanton with

$$z \equiv \frac{n_i/f_{\text{ax}}}{S_i} > z_0, \tag{7.2}$$

for some z_0 to be specified shortly.¹⁸ The quantity z is the equivalent of the charge-to-mass ratio for the instanton, where the charge is given by n/f_{ax} and the mass corresponds to S . When working with black holes an object satisfying $z > z_0$ is referred to as superextremal, while a black hole with $z < z_0$ is termed subextremal. It will be useful to extend this nomenclature to the case of instantons. The WGC then requires the existence of superextremal instantons.

To define the WGC for instantons it is hence important to determine z_0 . In the black hole case z_0 is the charge-to-mass ratio of an extremal RN black hole. By analogy, we will define z_0 as the charge-to-mass ratio of an extremal gravitational instanton as suggested in [17]. There is further support for this assertion. In subsection 2.3 we saw that gravitational instantons in 4d are related to RN black holes in 5d. More specifically, the relation $C = \ell^2(M^2 - Q^2)$ implies that extremal black holes ($M^2 = Q^2$) are in one-to-one correspondence with extremal instantons ($C = 0$). It is thus plausible that extremal instantons play the role of extremal black holes in the WGC. Using our expression (4.7) for the action of an extremal gravitational instanton we find

$$z_0 = \frac{n/f_{\text{ax}}}{S_{\text{extremal}}} = \frac{\alpha}{2}. \tag{7.3}$$

Let us now compute the charge-to-mass ratio z for cored gravitational instantons and Euclidean wormholes to see how they fit into this picture. We begin with cored gravitational instantons. For fixed n/f_{ax} we have

$$S_{\text{cored}}(\alpha) \geq \begin{cases} S_{\text{extremal}}(\alpha) & \text{for } \alpha \geq 2\sqrt{2/3} \\ S_{\text{extremal}}(2\sqrt{2/3}) & \text{for } \alpha < 2\sqrt{2/3}, \end{cases} \tag{7.4}$$

and thus

$$z_{\text{cored}} \leq \begin{cases} z_0 & \text{for } \alpha \geq 2\sqrt{2/3} \\ \frac{2\sqrt{2/3}}{\alpha} z_0 & \text{for } \alpha < 2\sqrt{2/3} \end{cases} \tag{7.5}$$

¹⁸The WGC can be made more precise by adding further attributes to the condition $z > z_0$ [3]. A more careful definition becomes important when several U(1) group factors (or axion species) are present. See [5, 9, 11, 13, 17, 25] for more details.

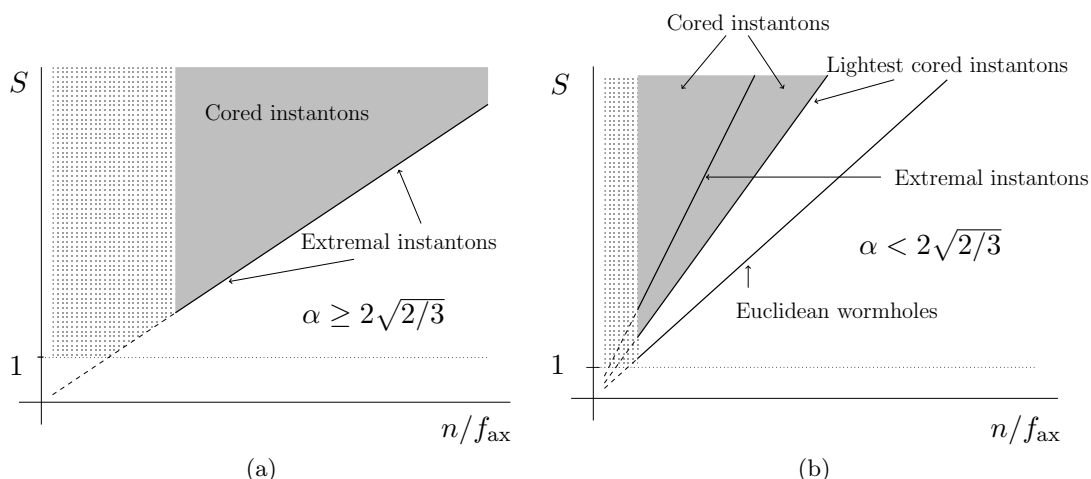

Figure 9. Instanton action S vs. n/f_{ax} for (a) $\alpha \geq 2\sqrt{2/3}$ and (b) $\alpha < 2\sqrt{2/3}$.

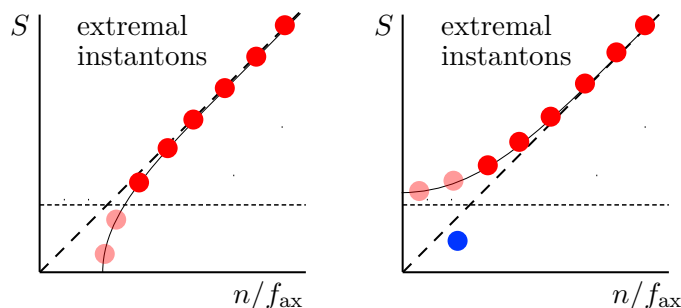

Figure 10. Possible realisations of the WGC for gravitational instantons [113]. Red dots denote extremal gravitational instantons while blue dots correspond to additional superextremal instantons required by the WGC.

We can make the following observation. For $\alpha \geq 2\sqrt{2/3}$ cored gravitational instantons are strictly subextremal and do not satisfy the WGC condition $z > z_0$. They hence play a role akin to subextremal black holes in the WGC for particles. This is consistent with the finding that for $\alpha \geq 2\sqrt{2/3}$ cored gravitational instantons are related to subextremal black holes in higher dimensions (see [75] and subsection 2.3). The situation is different for $\alpha < 2\sqrt{2/3}$. The lightest cored instantons are now superextremal. We illustrate our findings in figure 9.

Next, let us turn to Euclidean wormholes. From (4.19) we find

$$z_{\text{wh}} = \frac{n/f_{\text{ax}}}{S_{\text{wh}}} = \frac{\alpha}{2 \sin\left(\frac{\alpha\pi}{4} \sqrt{\frac{3}{2}}\right)} > \frac{\alpha}{2} = z_0 \tag{7.6}$$

for $0 \leq \alpha < 2\sqrt{2/3}$, which is the allowed range for wormhole solutions. We find that Euclidean wormholes are strictly superextremal. In addition, one can also show that $z_{\text{wh}} > z_{\text{cored}}$. This is displayed in figure 9 (b).

What can one learn from these results about the WGC? We will discuss this question for the two cases $\alpha \geq 2\sqrt{2/3}$ and $\alpha < 2\sqrt{2/3}$ separately.

For $\alpha \geq 2\sqrt{2/3}$ the spectrum of gravitational instantons does not contain any superextremal objects that could satisfy the WGC. This is not surprising. Our analysis is restricted to macroscopic gravitational instantons, while it is expected that microscopic physics is responsible for satisfying the WGC. If the WGC is true, it could be realised in two different ways which are shown in figure 10. For one, extremal gravitational instantons (red dots in figure 10) could satisfy the WGC on their own. This occurs if quantum corrections decrease the instanton action for small n such that they naively become superextremal (l.h.s. of figure 10). If this is not the case (see r.h.s. of figure 10) the WGC requires the existence of additional superextremal instantons (blue dot). At the moment it is not clear which implementation of the WGC, if any, is realised. Unfortunately, our analysis is not suitable for resolving this issue.

Let us move on to $\alpha < 2\sqrt{2/3}$. Interestingly, the set of gravitational instanton solutions now contains superextremal objects in the form of wormholes and cored instantons. It thus seems that the WGC is satisfied in Einstein-axion-dilaton systems in virtue of cored instantons and Euclidean wormholes. Note that this is different to the situations shown in figure 10. Here the WGC would be satisfied by an infinite tower of superextremal macroscopic objects.

Another interpretation of our findings is that the statement of the WGC has to be modified for $\alpha < 2\sqrt{2/3}$. In this regime the ‘lightest’ macroscopic object with given charge n/f_{ax} is not the extremal instanton but the wormhole. Also the correspondence between extremal instantons and extremal black holes in higher dimensions is lost for $\alpha < 2\sqrt{2/3}$. This may imply that the WGC condition is now set by the charge-to-mass ratio of the wormhole rather than that of the extremal instanton. To satisfy the WGC one would then require the existence of states with $z > z_{\text{wh}}$. We leave further investigations on this topic for future work.

Last, there may be further implications for gravitational instantons if the WGC for axions is true: gravitational instantons may not be ‘stable’ in the following sense. To be specific, consider a cored instanton with action S and axion charge n in a theory with $\alpha > 2\sqrt{2/3}$. This corresponds to a tunnelling process between two configurations differing by n units of axion charge. Let us then assume that the WGC is true and implies the existence of instantons with charge-to-mass ratio $z > z_0$, where z_0 is the charge-to-mass of an extremal gravitational instanton as before. An immediate consequence is that a tunnelling process will then always be dominated by the instantons predicted by the WGC. For our example this works as follows. The instantons needed to satisfy the WGC have $z > z_0 \geq z_{\text{cored}}$. Let two such instantons have n_1, S_1 and n_2, S_2 , such that $n_1 + n_2 = n$. Since $z > z_{\text{cored}}$ it follows that $S_1 + S_2 < S$ and tunnelling via two such instantons will dominate over tunnelling via the cored instanton.¹⁹ Hence, we do not expect ‘unstable’ gravitational instantons to be relevant in the path integral computation of the instanton

¹⁹Note that this is equivalent to the statement that (sub-)extremal black holes can in principle decay if the WGC for particles holds.

potential as the major contributions should arise from the instantons satisfying the WGC. We leave a more rigorous analysis of this issue for future work.

8 Conclusions and outlook

It is of great interest to understand whether quantum gravity forbids periodic scalars with large field range and flat potential. The obvious way in which this can happen is via instanton-induced corrections. In detail, there are two specific options: on the one hand, quantum gravity may demand the presence of instantons with certain actions and charges, via a generalized weak gravity conjecture. This is rather indirect: one tries to show that certain things ‘go wrong’ unless the relevant particles (or instantons) exist.

There is, however, also a more direct approach: gravity itself supplies, in a rather direct or ‘constructive’ way the instantons which may lift the flat potential. In the present paper, we have tried to push this direct approach as far as possible, striving also for maximal model-independence.

Our results are as follows. We observe that in a pure axion-gravity system a potential for the axion is generated by Giddings-Strominger wormholes and that this potential is parametrically unsuppressed if the cutoff is at the Planck scale. Trying to be more precise about this, we encountered a surprise: if, as a model of high-cutoff quantum gravity, we take string theory at self-dual coupling and self-dual compactification radius, we are still left with a purely numerical suppression factor of $\exp(-3\pi^2) \simeq 10^{-13}$. Such a result makes it hard to hope for a strong constraint on inflation, even after further refining the analysis.

Furthermore, we continued to ask for generic 4d constraints, but assuming more concretely that the 4d theory arises from string theory with a potentially low moduli scale. First, we found that in this setting nothing too dramatic happens to gravitational instantons: one linear combination of the moduli acts as a 4d dilaton governing the axion coupling; the instantons become more diverse in that extremal and cored gravitational instantons exist in addition to wormholes; the calculation still breaks down only at the Kaluza-Klein scale, which can of course still be high.

Unfortunately, the predictions now become model dependent as the coupling strength of the 4d dilaton to the axion (an $\mathcal{O}(1)$ numerical factor) enters. Taking the highest value for this factor that we could obtain in the simplest models results in a less severe instanton suppression factor of $\exp(-2\pi) \simeq 10^{-3}$. This is of course highly relevant for inflation, but easily avoided by considering models with different dilaton coupling.

In both of the above approaches, the suppression factors start out small and further fall as $\exp(-r^2)$, with r an appropriately normalised compactification radius in 4d Planck units. As a result, while we do believe that gravitational instantons are the most fundamental and model-independent way to constrain field ranges, the numbers appear to allow for enough room for realistic large-field inflation.

Finally, we have attempted to connect our analysis of the various types of gravitational instantons, including their dependence on the axion-dilaton coupling, to the ongoing discussion of the weak gravity conjecture. In particular, we found a intriguing regime where

wormholes are the objects with highest charge-to-mass ratio and may thus be sufficient to satisfy the instanton-axion weak gravity conjecture.

There are many directions for further investigations. By limiting our analysis to gravitational instantons in 4-dimensional Einstein-axion-dilaton theories we were unable to arrive at strong constraints on inflation. While this approach allows us to remain ignorant about the detailed UV completion, we are forced to neglect potentially more important contributions. These would arise from gravitational instantons with low instanton numbers, which are incalculable in the 4-dimensional Einstein-axion-dilaton theory. However, a quantitative analysis may be possible if one assumes that UV physics is described by string theory. It is expected that gravitational instantons will correspond to non-perturbative effects such as D-brane instantons in string theory. To arrive at stronger constraints a better understanding of non-perturbative effects in string theory is desirable. In particular, it is expected that poorly understood non-BPS instantons may become important during inflation [9].

There is a related question that is worthy of further examination. While more important instanton contributions to the axion potential may exist, it is possible that the overall effect on the axion potential vanishes once all such contributions are included. To calculate contributions from ‘more important’ instantons is equivalent to studying instantons in a theory at a higher energy scale. However, taking string theory as our UV completion, we would expect the theory to become supersymmetric and/or higher-dimensional at some scale. It is then possible that, once we work above the supersymmetry scale, there are cancellations between the various instanton contributions to the axion potential. This is somewhat analogous to the cancellation between boson and fermion loops in supersymmetric field theory. We regard it as important to determine whether such cancellations can occur.

While we were unable to arrive at strong model-independent constraints on inflation, gravitational instantons may be important for inflation in models where the dilaton coupling takes sufficiently large values. In the effective 4-dimensional theory the dilaton coupling is a free parameter. However, one would expect that its value is constrained by possible UV completions. Indeed, by considering simple axion-dilaton systems in string compactifications, we find that the dilaton coupling typically takes $\mathcal{O}(1)$ values, i.e. it can neither be very small nor very large. It would be interesting to examine to what extent these results are generic.

The upshot of these points is clear: it is imperative to understand the ultraviolet end of the instanton spectrum.

Acknowledgments

We thank T. Bachlechner, A. Collinucci, A. Font, B. Heidenreich, K.-M. Lee, E. Kiritsis, E. Palti, M. Reece, F. Rompineve, T. Rudelius, M. Salmhofer, J. Stout, I. Valenzuela and T. Weigand for helpful discussions. We are also grateful to the referee for valuable comments on the manuscript. This work was partly supported by the DFG Transregional Collaborative Research Centre TRR 33 “The Dark Universe”. P.M. acknowledges financial support by the Studienstiftung des deutschen Volkes. S.T. would like to thank the Institute for Theoretical Physics in Heidelberg for hospitality during several visits and the Klaus-

Tschira foundation for generous support. He also thanks A. Kashani-Poor and R. Minasian for hospitality at IHP in Paris.

A Derivation of the metric structure of gravitational instantons

We present a derivation of the metric (2.4) following [88], which also shows that C arises as an integration constant. The most general 4d line element with rotational symmetry is

$$ds^2 = \lambda(r)dr^2 + r^2 d\Omega_3^2, \quad (\text{A.1})$$

where $d\Omega_3^2$ represents the metric on S^3 . Let us be more generic than in (2.1) and consider a set of moduli ϕ^I on moduli space with metric G_{IJ} :

$$S = \int d^4x \sqrt{g} \left[-\frac{1}{2}R + \frac{1}{2}G_{IJ}(\phi)g^{\mu\nu}\partial_\mu\phi^I\partial_\nu\phi^J \right]. \quad (\text{A.2})$$

Due to the rotational symmetry of our system we take $\phi^I = \phi^I(r)$. Variation of S with respect to ϕ^K yields the equation of motion

$$\left(\sqrt{g}g^{rr}G_{KJ}\phi'^J \right)' - \frac{1}{2}\sqrt{g}g^{rr}\partial_K G_{JL}\phi'^J\phi'^L = 0. \quad (\text{A.3})$$

Here, the prime denotes the derivative with respect to the coordinate r and ∂_K the derivative with respect to ϕ^K . Let us introduce a new variable τ such that $dr/d\tau = \sqrt{g}g^{rr}$. The equation of motion above can then be rewritten as the geodesic equation on moduli space, i.e.

$$\partial_\tau^2\phi^I + \Gamma_{JL}^I\partial_\tau\phi^J\partial_\tau\phi^L = 0, \quad (\text{A.4})$$

with Christoffel-symbols Γ_{JL}^I for the metric G_{IJ} . Along the geodesics we then have

$$\partial_\tau \left(G_{IJ}\partial_\tau\phi^I\partial_\tau\phi^J \right) = 0 \quad (\text{A.5})$$

or, expressed in the coordinate r ,

$$G_{IJ}\phi'^I\phi'^J = \frac{k}{(\sqrt{g}g^{rr})^2} = \frac{k\lambda(r)}{r^6}, \quad (\text{A.6})$$

where we introduced a constant k and used (A.1).

Furthermore, the rr -component of the energy-momentum tensor is

$$T_{rr} = \frac{1}{2}G_{IJ}\phi'^I\phi'^J \stackrel{(\text{A.6})}{=} \frac{k\lambda(r)}{2r^6}. \quad (\text{A.7})$$

The algebraic form of $\lambda(r)$ can now be read off from the rr -component of Einstein's equations. The rr -component of the Einstein tensor is

$$G_{rr} = \frac{3}{r^2}(1 - \lambda(r)) \quad (\text{A.8})$$

and hence $G_{rr} = T_{rr}$ yields

$$\lambda(r) = \left(1 + \frac{C}{r^4} \right)^{-1}, \quad (\text{A.9})$$

where $C = k/6$ is indeed an integration constant. It is interesting to note that the metric component g_{rr} is determined independently of the functional form of $G_{IJ}(\phi)$.

Also note that the metric is asymptotically flat, because $\lambda(r) \rightarrow 1$ as $r \rightarrow \infty$.

Finally, we want to remark that for the creation of Euclidean wormholes ($C < 0$) it is necessary to have $G_{IJ}\phi'^I\phi'^J < 0$ (see (A.6)). While one cannot simply put a wrong sign into the kinetic term of the scalar fields, one can instead consider a Lagrangian with a 2-form gauge field, whose dual field is an axion. According to our discussions of quantum mechanical dualisation in subsection 2.1, this axion is imaginary at the saddle-point of the path integral and effectively obtains an opposite sign in the kinetic term. Moreover, for solutions with $C \geq 0$ one necessarily needs to include dynamical scalar fields so that $G_{IJ}\phi'^I\phi'^J > 0$.

B Charge quantisation

Let us first recall how flux and charge quantisation usually work in a B_2 -/ θ_0 -theory with strings and fundamental instantons. For any 3-cycle S^3 we have

$$Q_B \int_{S^3} H_3 = 2\pi n \tag{B.1}$$

with integer n .²⁰ Analogously, for any 1-cycle S^1 , we have

$$Q_\theta \int_{S^1} F_1 = 2\pi m, \tag{B.2}$$

$m \in \mathbb{Z}$. Obviously, n and m can only be non-zero if the relevant cycle is either non-trivial in M or if it encloses the appropriate charged object.

The above are just the familiar flux quantisation conditions. In order to derive charge quantisation, we temporarily go back to Minkowskian space and use the equations of motion of

$$S = - \int_M \frac{1}{2g_B^2} H_3 \wedge \star H_3 + Q_B \int_M B_2 \wedge j_2, \tag{B.3}$$

where j_2 is the current modelling the distribution of strings. It can be defined explicitly by $\int_\Sigma j_2 = N$, where N is the number of strings intersecting some surface Σ . Without loss of generality we choose $N = 1$. From the equation of motion for B_2 ,

$$d(1/g_B^2 \star H_3) = -Q_B j_2, \tag{B.4}$$

we find, using Stokes theorem:

$$Q_B = - \int_{\partial\Sigma} 1/g_B^2 \star H_3 = - \int_{\partial\Sigma} F_1 = \frac{2\pi m}{Q_\theta}. \tag{B.5}$$

In the last step we used F_1 -flux quantisation. Thus, we see that

$$Q_B Q_\theta = 2\pi m, \tag{B.6}$$

²⁰This follows from assuming gauge invariance of the coupling term in (2.6), i.e. one can define B_2 with either the south- or north pole of S^3 removed, getting the same result in both cases. This is another argument to see the necessity of the i -factor in front of the coupling terms.

which is the well-known Dirac quantisation condition. For the following, we take the freedom to choose $Q_\theta = 1$, i.e. the periodicity of the axion field is in this case $\theta_0 \rightarrow \theta_0 + 2\pi$. Then, combining (B.6) with $m = 1$ (here we assume that a string with smallest charge exists) and (B.1), we find that the quantisation condition on H_3 can simply be expressed as

$$\int_{S^3} H_3 = n. \tag{B.7}$$

This flux quantisation condition (B.7) is at the heart of gravitational instanton solutions.

Now, we are actually interested in potentials introduced by gravitational instantons, i.e., in shift symmetry breaking by quantum gravity. Hence, assuming the existence of fundamental instantons defeats the purpose. So let us see how far we get with the logic above if we abandon the source term in (2.5).

First, if we allow for geometries with non-trivial 3-cycles, the H_3 flux quantisation condition (B.1) can still be derived. All we need is the existence of strings coupled to B_2 . This then also implies that Q_B is quantised. By contrast, (B.2) cannot be derived without assuming the existence of fundamental instantons. However, if we allow for geometries which also have non-trivial 1-cycles (see figure 2), and if we postulate that the dual potential θ_0 is a globally defined function taking values on S^1 (i.e. $\theta_0 \equiv \theta_0 + 2\pi$), then both (B.2) and charge quantisation, (B.6) and (B.7), follow.

C Dualisation under the path integral

In subsection 2.1 we are interested in computing

$$\langle H_3^{(F)} | e^{-HT} | H_3^{(I)} \rangle \sim \int_{\text{b.c.}} d[H_3] d[\theta_0] \exp \left\{ - \int_M \frac{1}{2g_B^2} (H_3 \wedge \star H_3 + 2ig_B^2 \theta_0 dH_3) \right\}, \tag{C.1}$$

which is (2.12). Here, $T \equiv t_F - t_I$. At the end we want to obtain a path integral over the variable θ_0 , i.e. (2.15). This is nothing but dualising from a set of canonical momentum variables to their generalised coordinates.

Thus, we illustrate the subtleties of the computation leading to (2.15) by considering the quantum-mechanical harmonic oscillator, i.e. $H = q^2/2 + p^2/2$. The momentum p then corresponds to the background flux $\langle H_3 \rangle$ or, more precisely, to the quantised charge n , while the position variable q corresponds to θ_0 . The transition amplitude from state $|q_I\rangle$ to $|q_F\rangle$ reads

$$\langle q_F | e^{-HT} | q_I \rangle = \int d[p] \int_{\text{b.c.}} d[q] \exp \left\{ \int_{t_I}^{t_F} dt (ip\dot{q} - H(q, p)) \right\}, \tag{C.2}$$

with boundary conditions $q(t_I) = q_I$ and $q(t_F) = q_F$ imposed.

In fact we rather want to compute $\langle p_F | e^{-HT} | p_I \rangle$, which is expressed similarly:

$$\begin{aligned} \langle p_F | e^{-HT} | p_I \rangle &= \int d[q] \int_{\text{b.c.}} d[p] \exp \left\{ \int_{t_I}^{t_F} dt (-iq\dot{p} - H(q, p)) \right\} \\ &= \int d[q] \int_{\text{b.c.}} d[p] \exp \left\{ \int_{t_I}^{t_F} dt (ip\dot{q} - H(q, p)) \right\} \exp \{-i(q_F p_F - q_I p_I)\}, \end{aligned} \quad (\text{C.3})$$

where we impose again $p(t_I) = p_I$ and $p(t_F) = p_F$. In the second step we integrated the first term of the exponential by parts. In our case we have $H = q^2/2 + p^2/2$ which allows us to complete the square. Integrating out p without worrying about the boundary conditions to be imposed yields the desired result

$$\langle p_F | e^{-HT} | p_I \rangle \sim \int d[q] \exp(-i(q_F p_F - q_I p_I)) e^{-S[q]}, \quad (\text{C.4})$$

see also [114] for comments on the integration over the momentum. We wish to have a closer look at this decisive step.

To do so, we write the amplitude $\langle p_F | e^{-HT} | p_I \rangle$ as:

$$\langle p_F | e^{-HT} | p_I \rangle = \int dq_I dq_F \langle p_F | q_F \rangle \langle q_F | e^{-HT} | q_I \rangle \langle q_I | p_I \rangle. \quad (\text{C.5})$$

Now let us assume that the two dual relations (C.2) and (C.3) hold. Then, in particular, (C.2) implies

$$\langle q_F | e^{-HT} | q_I \rangle = \int_{\text{b.c.}} d[q] e^{-S[q]}, \quad (\text{C.6})$$

and the result (C.4) follows immediately (use $\langle p | q \rangle = e^{-ipq}$). The operation of integrating out p while disregarding its boundary conditions is thereby indirectly justified.

Finally, we can demonstrate this directly and explicitly by writing²¹

$$\begin{aligned} &\langle p_F | e^{-HT} | p_I \rangle \\ &= \int \prod_{m=0}^N dq_m \prod_{n=0}^{N-1} dp_n \langle p_F | q_N \rangle \langle q_N | e^{-H\epsilon} | p_{N-1} \rangle \langle p_{N-1} | q_{N-1} \rangle \langle q_{N-1} | e^{-H\epsilon} | p_{N-2} \rangle \dots \\ &\quad \dots \langle p_1 | q_1 \rangle \langle q_1 | e^{-H\epsilon} | p_0 \rangle \langle p_0 | q_0 \rangle \langle q_0 | p_I \rangle, \end{aligned} \quad (\text{C.7})$$

where $\epsilon \equiv T/(N+1)$ and $q_0 = q_I$, $q_N = q_F$. This becomes the discretised version of (C.3):

$$\begin{aligned} \langle p_F | e^{-HT} | p_I \rangle &= \int \prod_{m=0}^N dq_m \prod_{n=0}^{N-1} dp_n e^{-iq_N(p_F - p_{N-1}) - H(q_N, p_{N-1})\epsilon} \dots \\ &\quad \dots e^{-iq_1(p_1 - p_0) - H(q_1, p_0)\epsilon} e^{-iq_0(p_0 - p_I)}. \end{aligned} \quad (\text{C.8})$$

For the harmonic oscillator (and in fact for more general potentials $V(q)$) we can integrate out p_0, \dots, p_{N-1} (after completing the square for each p_m). As a result we find

$$\begin{aligned} \langle p_F | e^{-HT} | p_I \rangle &\sim \int \prod_{m=0}^N dq_m \exp \{-iq_N p_F\} \exp \left\{ -\frac{q_N^2}{2}\epsilon - \frac{(q_N - q_{N-1})^2}{2\epsilon} \right\} \dots \\ &\quad \dots \exp \left\{ -\frac{q_1^2}{2}\epsilon - \frac{(q_1 - q_0)^2}{2\epsilon} \right\} \exp \{iq_0 p_I\}. \end{aligned} \quad (\text{C.9})$$

²¹We are grateful to K.-M. Lee for pointing out this possibility and for further discussions on this issue. See also [81].

This is precisely the discretised version of (C.4). Hence, integrating out the momenta from (C.3) to (C.4) without considering the boundaries is indeed justified.

D Analytical solutions to Einstein's equation

Einstein's equation (2.25) which follows from the action (2.19) can be solved analytically. We explain how to arrive at solutions (2.27), (2.34) and (2.35) for $C < 0$, $C = 0$ and $C > 0$, respectively.

First of all, (2.25) can be rewritten as:

$$\pm \int d\varphi \frac{1}{\sqrt{\mathcal{F}(\varphi)n^2/A^2 + C}} = \sqrt{6} \int dr \frac{1}{r^3 \sqrt{1 + C/r^4}}. \quad (\text{D.1})$$

Thus, integral representations can in principle be obtained for any \mathcal{F} . For $\mathcal{F}(\varphi) = 1/(3!f_{\text{ax}}^2) \exp(-\alpha\varphi)$, explicit solutions exist.

For the r.h.s., one finds

$$\sqrt{6} \int dr \frac{1}{r^3 \sqrt{1 + C/r^4}} = \begin{cases} -\sqrt{\frac{3}{2|C|}} \arcsin\left(\frac{\sqrt{|C|}}{r^2}\right) + \text{const} & \text{for } C < 0 \\ -\sqrt{\frac{3}{2C}} \operatorname{arcsinh}\left(\frac{\sqrt{C}}{r^2}\right) + \text{const} & \text{for } C > 0 \\ -\sqrt{\frac{3}{2}} \frac{1}{r^2} + \text{const} & \text{for } C = 0, \end{cases} \quad (\text{D.2})$$

where we use the substitution $y = \sqrt{|C|}/r^2$ for $C \neq 0$. The integral on the l.h.s. can be rewritten as

$$\pm \frac{1}{\sqrt{|C|}} \int d\varphi \frac{1}{\sqrt{k \exp(-\alpha\varphi) \pm 1}}, \quad (\text{D.3})$$

with $k \equiv n^2/(3!|C|A^2 f_{\text{ax}}^2)$. If $C > 0$ ($C < 0$), the positive (negative) sign under the square root applies. In the case of $C > 0$ we substitute

$$\sinh y = \frac{1}{\sqrt{k}} \exp(\alpha\varphi/2), \quad (\text{D.4})$$

and for $C < 0$ we take

$$\sin y = \frac{1}{\sqrt{k}} \exp(\alpha\varphi/2). \quad (\text{D.5})$$

Using appropriate identities for the hyperbolic or trigonometric functions, one arrives at

$$\begin{aligned} \pm \int d\varphi \frac{1}{\sqrt{\exp(-\alpha\varphi)n^2/(3!f_{\text{ax}}^2 A^2) + C}} = & \quad (\text{D.6}) \\ = \begin{cases} \pm \frac{2}{\sqrt{|C|\alpha}} \left[\arcsin\left(\frac{1}{\sqrt{k}} \exp(\alpha\varphi/2)\right) - \text{const} \right] & \text{for } C < 0 \\ \pm \frac{2}{\sqrt{C\alpha}} \left[\operatorname{arcsinh}\left(\frac{1}{\sqrt{k}} \exp(\alpha\varphi/2)\right) - \text{const} \right] & \text{for } C > 0 \\ \pm \frac{2\sqrt{6}A f_{\text{ax}}}{n\alpha} \exp(\alpha\varphi/2) + \text{const} & \text{for } C = 0. \end{cases} \end{aligned}$$

From here one can read off the solutions, which can be rewritten as (2.27), (2.34) or (2.35).

E Computation of the instanton action

We present further details of the computation of the instanton action in section 4. The computation consists of determining the on-shell contribution from the action and the contribution coming from the Gibbons-Hawking-York boundary term. We begin by looking at the latter, where we follow [17].

Gibbons-Hawking-York boundary term. The Gibbons-Hawking-York boundary term is

$$S_{\text{GHY}} = - \oint_{\partial M} d^3x \sqrt{h} (K - K_0), \quad (\text{E.1})$$

as described around (4.4). Starting from our metric ansatz (2.4) we choose hypersurfaces of constant r . The normal unit vector n is then

$$n = \sqrt{1 + \frac{C}{r^4}} \frac{\partial}{\partial r}. \quad (\text{E.2})$$

The trace of the extrinsic curvature is

$$K = \nabla_{\mu} n^{\mu} = \partial_{\mu} n^{\mu} + \Gamma_{\mu\nu}^{\mu} n^{\nu} \quad (\text{E.3})$$

where ∇ is the Levi-Civita connection on M . One finds

$$\Gamma_{\mu r}^{\mu} = \frac{2C}{r^5} \left(1 + \frac{C}{r^4}\right)^{-1} + \frac{3}{r}, \quad (\text{E.4})$$

and therefore

$$K = \nabla_{\mu} n^{\mu} = \frac{3}{r} \left(1 + \frac{C}{r^4}\right)^{1/2}. \quad (\text{E.5})$$

By taking $C = 0$ we can also read off the trace of the extrinsic curvature of ∂M embedded in \mathbb{R}^4 :

$$K_0 = \frac{3}{r}. \quad (\text{E.6})$$

It then follows

$$S_{\text{GHY}} = - \oint_{\partial M} \epsilon_{S^3} (K - K_0) = -3Ar^2 \left[\left(1 + \frac{C}{r^4}\right)^{1/2} - 1 \right] \Big|_{\text{boundary}}, \quad (\text{E.7})$$

with surface area $A = 2\pi^2$ of S^3 . Recall that according to our conventions the volume form on S^3 contains a factor r^3 . Clearly, for $C = 0$ we have $S_{\text{GHY}} = 0$. For $C > 0$ the boundary is at $r = 0$ and at $r = \infty$,

$$S_{\text{GHY}} = 3AC^{1/2}, \quad C > 0. \quad (\text{E.8})$$

In the case of $C < 0$ the integral vanishes, because we always consider instanton-anti-instanton pairs, so $S_{\text{GHY}} = 0$.

These are the results used in section 4.

On-shell contribution. We now evaluate the bulk action (2.19) on-shell, i.e. we plug in the equations of motion successively. As described in section 4, the first step is to express the Ricci scalar R by the trace of the energy-momentum tensor using Einstein's equations:

$$R = -T. \tag{E.9}$$

The energy-momentum tensor $T_{\mu\nu}$ from the action (2.19) is

$$T_{\mu\nu} = -g_{\mu\nu} \left[\frac{1}{2} \mathcal{F}(\varphi) H^2 + \frac{1}{2} \partial_\rho \varphi \partial^\rho \varphi \right] + 3\mathcal{F}(\varphi) H_{\mu\rho\sigma} H_\nu{}^{\rho\sigma} + \partial_\mu \varphi \partial_\nu \varphi. \tag{E.10}$$

Consequently,

$$T = g^{\mu\nu} T_{\mu\nu} = \mathcal{F}(\varphi) H^2 - (\partial\varphi)^2, \tag{E.11}$$

and then (2.19) becomes simply

$$S = \int d^4x \sqrt{g} \mathcal{F}(\varphi) H^2 = A \int dr \frac{r^3}{\sqrt{1+C/r^4}} \mathcal{F}(\varphi) H^2, \tag{E.12}$$

where we used the rotational symmetry of our system. Next, we plug in the solution to (2.21),

$$H = \frac{n}{Ar^3} \epsilon, \tag{E.13}$$

and restrict ourselves to $\mathcal{F}(\varphi) = \exp(-\alpha\varphi)/(3!f_{\text{ax}}^2)$, for which we know the analytical solutions:

$$S = \frac{n^2}{Af_{\text{ax}}^2} \int dr \frac{1}{r^3 \sqrt{1+C/r^4}} \exp(-\alpha\varphi). \tag{E.14}$$

It is then convenient to rewrite the action as an integral over $d\varphi$ using Einstein's equation (2.25). We consider only regular solutions. They are monotonically decreasing and therefore we have $\varphi'(r) < 0$ everywhere. Hence,

$$S = -\frac{n^2}{Af_{\text{ax}}^2} \int d\varphi \frac{\exp(-\alpha\varphi)}{\sqrt{n^2 \exp(-\alpha\varphi)/(A^2 f_{\text{ax}}^2) + 6C}}. \tag{E.15}$$

The integral has to be evaluated case by case.

For extremal gravitational instantons with $C = 0$ we have

$$S = -\frac{n}{f_{\text{ax}}} \int_{\varphi(0)}^{\varphi(\infty)} d\varphi \exp(-\alpha\varphi/2) = \frac{2n}{\alpha f_{\text{ax}}}. \tag{E.16}$$

In the case of $C > 0$ we obtain

$$\begin{aligned} S &= -\frac{n^2}{Af_{\text{ax}}^2} \int_{\varphi(0)}^{\varphi(\infty)} d\varphi \frac{\exp(-\alpha\varphi)}{\sqrt{n^2 \exp(-\alpha\varphi)/(A^2 f_{\text{ax}}^2) + 6C}} \\ &= \frac{2n}{\alpha f_{\text{ax}}} \sqrt{\exp(-\alpha\varphi) + \sinh^2 K_+} \Big|_{\varphi(0)}^{\varphi(\infty)} = \frac{2n}{\alpha f_{\text{ax}}} e^{-K_+}, \end{aligned} \tag{E.17}$$

where we used (2.36) and took $K_+ > 0$. Combining this with the GHY boundary term yields the desired instanton action (4.14).

Finally, for Euclidean wormholes, i.e. for $C < 0$, we have

$$S = \int d^4x \sqrt{g} \mathcal{F}(\varphi) H^2 = 2 \times A \int_{r_0}^{\infty} dr \frac{r^3}{\sqrt{1 - |C|/r^4}} \mathcal{F}(\varphi) H^2, \quad (\text{E.18})$$

where the factor of two occurs because the left integral is over the whole Euclidean space, and hence accounts for the whole wormhole and thus for the instanton and anti-instanton, while the integral on the r.h.s. integrates from the centre of the wormhole to one end. The appearance of this factor may be seen more easily by evaluating the integral on the l.h.s. using the t -coordinate (2.33) and then changing coordinates from t to r . As was noted in [11], this contribution has to be divided by two, because the instanton action S_{inst} should only take into account half of the full wormhole action. Consequently, using the equations of motion as in the previous cases,

$$\begin{aligned} S_{\text{inst}} &= -\frac{n^2}{A f_{\text{ax}}^2} \int_{\varphi(r_0)}^{\varphi(\infty)} d\varphi \frac{\exp(-\alpha\varphi)}{\sqrt{n^2 \exp(-\alpha\varphi)/(A^2 f_{\text{ax}}^2) - 6|C|}} \\ &= \frac{2n}{\alpha f_{\text{ax}}} \left| \sin \left(\frac{\alpha\pi}{4} \sqrt{\frac{3}{2}} \right) \right|. \end{aligned} \quad (\text{E.19})$$

Hence, (4.19) follows, where we can drop the modulus due to the restriction to $0 \leq \alpha < 2\sqrt{2/3}$.

F Estimating the size of the prefactor \mathcal{A} in the instanton potential

The contribution of gravitational instantons to the axion potential is given by $\delta V = \mathcal{A} e^{-S} \cos(n\theta)$. While it has been proposed e.g. in [8, 9] that $\mathcal{A} \sim 1$ (in Planck units), we attempt a somewhat more precise estimate. This is inspired by the analogies between gravitational instantons and instantons arising from Euclidean branes wrapping an internal cycle of the compactification manifold (see e.g. [8, 9, 17]). Let us start by recalling how the latter contributes to the supergravity F -term potential in a simple setup.

We consider a Euclidean brane instanton modifying the perturbative superpotential W_0 as

$$W = W_0 + A(z) e^{-aT}, \quad (\text{F.1})$$

where z denotes the complex structure moduli and T is a Kähler modulus.

Then the supergravity F -term potential

$$V_F = e^K \left(K^{i\bar{j}} D_i W D_{\bar{j}} \bar{W} - 3|W|^2 \right) \quad (\text{F.2})$$

is corrected at leading order by

$$\delta V \sim e^K W_0 A(z) e^{-a\tau}, \quad (\text{F.3})$$

where τ is the real part of T . Recall that $K = -2 \ln \mathcal{V} + \dots$, which gives a suppression by $1/\mathcal{V}^2$. Furthermore, we rewrite the above expression in terms of the gravitino mass $m_{3/2} \sim W_0/\mathcal{V}$ and the KK-scale $m_{\text{KK}} \sim 1/\mathcal{V}^{2/3}$:

$$\delta V \sim \frac{1}{\mathcal{V}^{5/3}} \frac{m_{3/2}}{m_{\text{KK}}} A(z) e^{-a\tau}. \quad (\text{F.4})$$

If we were allowed to compare this with (6.1) then, using $m_{3/2} \lesssim m_{\text{KK}}$, we would conclude that

$$\mathcal{A} \lesssim \frac{A(z)}{\mathcal{V}^{5/3}} \quad (\text{F.5})$$

in Planck units. Here we identified $\exp(-a\tau)$ with $\exp(-S)$ motivated by the obvious analogy: indeed, the Euclidean brane action is proportional to the brane tension and the volume of the cycle. Similarly, the action of a cored gravitational instanton is proportional to the ADM tension of a black brane wrapping a cycle in a higher-dimensional version of the gravitational instanton system, see e.g. [17] for an example.

Nevertheless, our proposal to estimate \mathcal{A} by (F.5) remains nontrivial. Indeed, we first need to consider a large wrapping number n to relate to the calculable regime on the gravitational side. This is unproblematic in the present case since these higher instantons will contribute to W analogously to (F.1). Next, we are *not* interested in Euclidean brane instantons (their effect is well-known) but in some possibly very different type of instanton arising in a string model and not having a simple microscopic description. The claim or proposal implicit in (F.5) is then that this instanton may, conservatively, also be suppressed by a factor \mathcal{A} which becomes small as the KK-scale and SUSY breaking scales go down. This appears to be reasonable since, beyond the simple Euclidean brane case discussed here, higher-dimensional and SUSY-based cancellations are expected to occur above those scales.

Accepting the above proposal, compactification volumes in the range $\mathcal{V} \sim 10^2$ to 10^3 imply $\mathcal{A} \sim 10^{-4}$ and 10^{-5} , respectively, assuming that $A(z) = \mathcal{O}(1)$. Note that in order to avoid destabilisation of the Kähler moduli the compactification volume is at most of order $\mathcal{O}(10^3)$, see e.g. [59, 60, 65]. Nevertheless, the suppression by e^{-S} remains dominant in all regimes we considered.

Open Access. This article is distributed under the terms of the Creative Commons Attribution License ([CC-BY 4.0](https://creativecommons.org/licenses/by/4.0/)), which permits any use, distribution and reproduction in any medium, provided the original author(s) and source are credited.

References

- [1] R. Kallosh, A.D. Linde, D.A. Linde and L. Susskind, *Gravity and global symmetries*, *Phys. Rev. D* **52** (1995) 912 [[hep-th/9502069](#)] [[INSPIRE](#)].
- [2] T. Banks, M. Dine, P.J. Fox and E. Gorbatov, *On the possibility of large axion decay constants*, *JCAP* **06** (2003) 001 [[hep-th/0303252](#)] [[INSPIRE](#)].
- [3] N. Arkani-Hamed, L. Motl, A. Nicolis and C. Vafa, *The String landscape, black holes and gravity as the weakest force*, *JHEP* **06** (2007) 060 [[hep-th/0601001](#)] [[INSPIRE](#)].
- [4] J.P. Conlon, *Quantum Gravity Constraints on Inflation*, *JCAP* **09** (2012) 019 [[arXiv:1203.5476](#)] [[INSPIRE](#)].
- [5] C. Cheung and G.N. Remmen, *Naturalness and the Weak Gravity Conjecture*, *Phys. Rev. Lett.* **113** (2014) 051601 [[arXiv:1402.2287](#)] [[INSPIRE](#)].
- [6] T. Rudelius, *On the Possibility of Large Axion Moduli Spaces*, *JCAP* **04** (2015) 049 [[arXiv:1409.5793](#)] [[INSPIRE](#)].

- [7] A. de la Fuente, P. Saraswat and R. Sundrum, *Natural Inflation and Quantum Gravity*, *Phys. Rev. Lett.* **114** (2015) 151303 [[arXiv:1412.3457](#)] [[INSPIRE](#)].
- [8] T. Rudelius, *Constraints on Axion Inflation from the Weak Gravity Conjecture*, *JCAP* **09** (2015) 020 [[arXiv:1503.00795](#)] [[INSPIRE](#)].
- [9] M. Montero, A.M. Uranga and I. Valenzuela, *Transplanckian axions!?*, *JHEP* **08** (2015) 032 [[arXiv:1503.03886](#)] [[INSPIRE](#)].
- [10] J. Brown, W. Cottrell, G. Shiu and P. Soler, *Fencing in the Swampland: Quantum Gravity Constraints on Large Field Inflation*, *JHEP* **10** (2015) 023 [[arXiv:1503.04783](#)] [[INSPIRE](#)].
- [11] T.C. Bachlechner, C. Long and L. McAllister, *Planckian Axions and the Weak Gravity Conjecture*, *JHEP* **01** (2016) 091 [[arXiv:1503.07853](#)] [[INSPIRE](#)].
- [12] A. Hebecker, P. Mangat, F. Rompineve and L.T. Witkowski, *Winding out of the Swamp: Evading the Weak Gravity Conjecture with F-term Winding Inflation?*, *Phys. Lett. B* **748** (2015) 455 [[arXiv:1503.07912](#)] [[INSPIRE](#)].
- [13] J. Brown, W. Cottrell, G. Shiu and P. Soler, *On Axionic Field Ranges, Loopholes and the Weak Gravity Conjecture*, *JHEP* **04** (2016) 017 [[arXiv:1504.00659](#)] [[INSPIRE](#)].
- [14] D. Junghans, *Large-Field Inflation with Multiple Axions and the Weak Gravity Conjecture*, *JHEP* **02** (2016) 128 [[arXiv:1504.03566](#)] [[INSPIRE](#)].
- [15] B. Heidenreich, M. Reece and T. Rudelius, *Weak Gravity Strongly Constrains Large-Field Axion Inflation*, *JHEP* **12** (2015) 108 [[arXiv:1506.03447](#)] [[INSPIRE](#)].
- [16] E. Palti, *On Natural Inflation and Moduli Stabilisation in String Theory*, *JHEP* **10** (2015) 188 [[arXiv:1508.00009](#)] [[INSPIRE](#)].
- [17] B. Heidenreich, M. Reece and T. Rudelius, *Sharpening the Weak Gravity Conjecture with Dimensional Reduction*, *JHEP* **02** (2016) 140 [[arXiv:1509.06374](#)] [[INSPIRE](#)].
- [18] K. Kooner, S. Parameswaran and I. Zavala, *Warping the Weak Gravity Conjecture*, *Phys. Lett. B* **759** (2016) 402 [[arXiv:1509.07049](#)] [[INSPIRE](#)].
- [19] D. Andriot, *A no-go theorem for monodromy inflation*, *JCAP* **03** (2016) 025 [[arXiv:1510.02005](#)] [[INSPIRE](#)].
- [20] N. Kaloper, M. Kleban, A. Lawrence and M.S. Sloth, *Large Field Inflation and Gravitational Entropy*, *Phys. Rev. D* **93** (2016) 043510 [[arXiv:1511.05119](#)] [[INSPIRE](#)].
- [21] L.E. Ibáñez, M. Montero, A. Uranga and I. Valenzuela, *Relaxion Monodromy and the Weak Gravity Conjecture*, *JHEP* **04** (2016) 020 [[arXiv:1512.00025](#)] [[INSPIRE](#)].
- [22] A. Hebecker, F. Rompineve and A. Westphal, *Axion Monodromy and the Weak Gravity Conjecture*, *JHEP* **04** (2016) 157 [[arXiv:1512.03768](#)] [[INSPIRE](#)].
- [23] F. Baume and E. Palti, *Backreacted Axion Field Ranges in String Theory*, *JHEP* **08** (2016) 043 [[arXiv:1602.06517](#)] [[INSPIRE](#)].
- [24] B. Heidenreich, M. Reece and T. Rudelius, *Axion Experiments to Algebraic Geometry: Testing Quantum Gravity via the Weak Gravity Conjecture*, *Int. J. Mod. Phys. D* **25** (2016) 1643005 [[arXiv:1605.05311](#)] [[INSPIRE](#)].
- [25] B. Heidenreich, M. Reece and T. Rudelius, *Evidence for a Lattice Weak Gravity Conjecture*, [arXiv:1606.08437](#) [[INSPIRE](#)].

- [26] M. Montero, G. Shiu and P. Soler, *The Weak Gravity Conjecture in three dimensions*, *JHEP* **10** (2016) 159 [[arXiv:1606.08438](#)] [[INSPIRE](#)].
- [27] N. Kaloper and A. Lawrence, *A Monodromy from London*, [arXiv:1607.06105](#) [[INSPIRE](#)].
- [28] S.B. Giddings and A. Strominger, *Axion Induced Topology Change in Quantum Gravity and String Theory*, *Nucl. Phys. B* **306** (1988) 890 [[INSPIRE](#)].
- [29] K. Freese, J.A. Frieman and A.V. Olinto, *Natural inflation with pseudo Nambu-Goldstone bosons*, *Phys. Rev. Lett.* **65** (1990) 3233 [[INSPIRE](#)].
- [30] J.E. Kim, H.P. Nilles and M. Peloso, *Completing natural inflation*, *JCAP* **01** (2005) 005 [[hep-ph/0409138](#)] [[INSPIRE](#)].
- [31] S. Dimopoulos, S. Kachru, J. McGreevy and J.G. Wacker, *N-flation*, *JCAP* **08** (2008) 003 [[hep-th/0507205](#)] [[INSPIRE](#)].
- [32] T.C. Bachlechner, M. Dias, J. Frazer and L. McAllister, *Chaotic inflation with kinetic alignment of axion fields*, *Phys. Rev. D* **91** (2015) 023520 [[arXiv:1404.7496](#)] [[INSPIRE](#)].
- [33] G. Shiu, W. Staessens and F. Ye, *Widening the Axion Window via Kinetic and Stückelberg Mixings*, *Phys. Rev. Lett.* **115** (2015) 181601 [[arXiv:1503.01015](#)] [[INSPIRE](#)].
- [34] T.W. Grimm, *Axion inflation in type-II string theory*, *Phys. Rev. D* **77** (2008) 126007 [[arXiv:0710.3883](#)] [[INSPIRE](#)].
- [35] A.R. Liddle, A. Mazumdar and F.E. Schunck, *Assisted inflation*, *Phys. Rev. D* **58** (1998) 061301 [[astro-ph/9804177](#)] [[INSPIRE](#)].
- [36] M. Cicoli, K. Dutta and A. Maharana, *N-flation with Hierarchically Light Axions in String Compactifications*, *JCAP* **08** (2014) 012 [[arXiv:1401.2579](#)] [[INSPIRE](#)].
- [37] E. Palti and T. Weigand, *Towards large r from $[p, q]$ -inflation*, *JHEP* **04** (2014) 155 [[arXiv:1403.7507](#)] [[INSPIRE](#)].
- [38] T.W. Grimm, *Axion Inflation in F-theory*, *Phys. Lett. B* **739** (2014) 201 [[arXiv:1404.4268](#)] [[INSPIRE](#)].
- [39] L.E. Ibáñez and I. Valenzuela, *The inflaton as an MSSM Higgs and open string modulus monodromy inflation*, *Phys. Lett. B* **736** (2014) 226 [[arXiv:1404.5235](#)] [[INSPIRE](#)].
- [40] K. Choi, H. Kim and S. Yun, *Natural inflation with multiple sub-Planckian axions*, *Phys. Rev. D* **90** (2014) 023545 [[arXiv:1404.6209](#)] [[INSPIRE](#)].
- [41] S.H.H. Tye and S.S.C. Wong, *Helical Inflation and Cosmic Strings*, [arXiv:1404.6988](#) [[INSPIRE](#)].
- [42] R. Kappl, S. Krippendorff and H.P. Nilles, *Aligned Natural Inflation: Monodromies of two Axions*, *Phys. Lett. B* **737** (2014) 124 [[arXiv:1404.7127](#)] [[INSPIRE](#)].
- [43] I. Ben-Dayan, F.G. Pedro and A. Westphal, *Hierarchical Axion Inflation*, *Phys. Rev. Lett.* **113** (2014) 261301 [[arXiv:1404.7773](#)] [[INSPIRE](#)].
- [44] C. Long, L. McAllister and P. McGuirk, *Aligned Natural Inflation in String Theory*, *Phys. Rev. D* **90** (2014) 023501 [[arXiv:1404.7852](#)] [[INSPIRE](#)].
- [45] X. Gao, T. Li and P. Shukla, *Combining Universal and Odd RR Axions for Aligned Natural Inflation*, *JCAP* **10** (2014) 048 [[arXiv:1406.0341](#)] [[INSPIRE](#)].
- [46] I. Ben-Dayan, F.G. Pedro and A. Westphal, *Towards Natural Inflation in String Theory*, *Phys. Rev. D* **92** (2015) 023515 [[arXiv:1407.2562](#)] [[INSPIRE](#)].

- [47] Z. Kenton and S. Thomas, *D-brane Potentials in the Warped Resolved Conifold and Natural Inflation*, *JHEP* **02** (2015) 127 [[arXiv:1409.1221](#)] [[INSPIRE](#)].
- [48] T. Ali, S.S. Haque and V. Jejjala, *Natural Inflation from Near Alignment in Heterotic String Theory*, *Phys. Rev. D* **91** (2015) 083516 [[arXiv:1410.4660](#)] [[INSPIRE](#)].
- [49] H. Abe, T. Kobayashi and H. Otsuka, *Natural inflation with and without modulations in type IIB string theory*, *JHEP* **04** (2015) 160 [[arXiv:1411.4768](#)] [[INSPIRE](#)].
- [50] R. Kappl, H.P. Nilles and M.W. Winkler, *Natural Inflation and Low Energy Supersymmetry*, *Phys. Lett. B* **746** (2015) 15 [[arXiv:1503.01777](#)] [[INSPIRE](#)].
- [51] G. Shiu, W. Staessens and F. Ye, *Large Field Inflation from Axion Mixing*, *JHEP* **06** (2015) 026 [[arXiv:1503.02965](#)] [[INSPIRE](#)].
- [52] F. Ruehle and C. Wieck, *Natural inflation and moduli stabilization in heterotic orbifolds*, *JHEP* **05** (2015) 112 [[arXiv:1503.07183](#)] [[INSPIRE](#)].
- [53] R. Blumenhagen, D. Herschmann and F. Wolf, *String Moduli Stabilization at the Conifold*, *JHEP* **08** (2016) 110 [[arXiv:1605.06299](#)] [[INSPIRE](#)].
- [54] E. Silverstein and A. Westphal, *Monodromy in the CMB: Gravity Waves and String Inflation*, *Phys. Rev. D* **78** (2008) 106003 [[arXiv:0803.3085](#)] [[INSPIRE](#)].
- [55] L. McAllister, E. Silverstein and A. Westphal, *Gravity Waves and Linear Inflation from Axion Monodromy*, *Phys. Rev. D* **82** (2010) 046003 [[arXiv:0808.0706](#)] [[INSPIRE](#)].
- [56] N. Kaloper and L. Sorbo, *A Natural Framework for Chaotic Inflation*, *Phys. Rev. Lett.* **102** (2009) 121301 [[arXiv:0811.1989](#)] [[INSPIRE](#)].
- [57] N. Kaloper, A. Lawrence and L. Sorbo, *An Ignoble Approach to Large Field Inflation*, *JCAP* **03** (2011) 023 [[arXiv:1101.0026](#)] [[INSPIRE](#)].
- [58] F. Marchesano, G. Shiu and A.M. Uranga, *F-term Axion Monodromy Inflation*, *JHEP* **09** (2014) 184 [[arXiv:1404.3040](#)] [[INSPIRE](#)].
- [59] R. Blumenhagen and E. Plauschinn, *Towards Universal Axion Inflation and Reheating in String Theory*, *Phys. Lett. B* **736** (2014) 482 [[arXiv:1404.3542](#)] [[INSPIRE](#)].
- [60] A. Hebecker, S.C. Kraus and L.T. Witkowski, *D7-Brane Chaotic Inflation*, *Phys. Lett. B* **737** (2014) 16 [[arXiv:1404.3711](#)] [[INSPIRE](#)].
- [61] M. Berg, E. Pajer and S. Sjors, *Dante's Inferno*, *Phys. Rev. D* **81** (2010) 103535 [[arXiv:0912.1341](#)] [[INSPIRE](#)].
- [62] L. McAllister, E. Silverstein, A. Westphal and T. Wrase, *The Powers of Monodromy*, *JHEP* **09** (2014) 123 [[arXiv:1405.3652](#)] [[INSPIRE](#)].
- [63] S. Franco, D. Galloni, A. Retolaza and A. Uranga, *On axion monodromy inflation in warped throats*, *JHEP* **02** (2015) 086 [[arXiv:1405.7044](#)] [[INSPIRE](#)].
- [64] R. Blumenhagen, D. Herschmann and E. Plauschinn, *The Challenge of Realizing F-term Axion Monodromy Inflation in String Theory*, *JHEP* **01** (2015) 007 [[arXiv:1409.7075](#)] [[INSPIRE](#)].
- [65] A. Hebecker, P. Mangat, F. Rompineve and L.T. Witkowski, *Tuning and Backreaction in F-term Axion Monodromy Inflation*, *Nucl. Phys. B* **894** (2015) 456 [[arXiv:1411.2032](#)] [[INSPIRE](#)].

- [66] L.E. Ibáñez, F. Marchesano and I. Valenzuela, *Higgs-otic Inflation and String Theory*, *JHEP* **01** (2015) 128 [[arXiv:1411.5380](#)] [[INSPIRE](#)].
- [67] R. Blumenhagen, A. Font, M. Fuchs, D. Herschmann and E. Plauschinn, *Towards Axionic Starobinsky-like Inflation in String Theory*, *Phys. Lett. B* **746** (2015) 217 [[arXiv:1503.01607](#)] [[INSPIRE](#)].
- [68] A. Retolaza, A.M. Uranga and A. Westphal, *Bifid Throats for Axion Monodromy Inflation*, *JHEP* **07** (2015) 099 [[arXiv:1504.02103](#)] [[INSPIRE](#)].
- [69] D. Escobar, A. Landete, F. Marchesano and D. Regalado, *Large field inflation from D-branes*, *Phys. Rev. D* **93** (2016) 081301 [[arXiv:1505.07871](#)] [[INSPIRE](#)].
- [70] R. Blumenhagen, C. Damian, A. Font, D. Herschmann and R. Sun, *The Flux-Scaling Scenario: de Sitter Uplift and Axion Inflation*, *Fortsch. Phys.* **64** (2016) 536 [[arXiv:1510.01522](#)] [[INSPIRE](#)].
- [71] T. Kobayashi, A. Oikawa and H. Otsuka, *New potentials for string axion inflation*, *Phys. Rev. D* **93** (2016) 083508 [[arXiv:1510.08768](#)] [[INSPIRE](#)].
- [72] D. Escobar, A. Landete, F. Marchesano and D. Regalado, *D6-branes and axion monodromy inflation*, *JHEP* **03** (2016) 113 [[arXiv:1511.08820](#)] [[INSPIRE](#)].
- [73] A. Hebecker, J. Moritz, A. Westphal and L.T. Witkowski, *Axion Monodromy Inflation with Warped KK-Modes*, *Phys. Lett. B* **754** (2016) 328 [[arXiv:1512.04463](#)] [[INSPIRE](#)].
- [74] A. Landete, F. Marchesano and C. Wieck, *Challenges for D-brane large-field inflation with stabilizer fields*, *JHEP* **09** (2016) 119 [[arXiv:1607.01680](#)] [[INSPIRE](#)].
- [75] E. Bergshoeff, A. Collinucci, U. Gran, D. Roest and S. Vandoren, *Non-extremal D-instantons*, *JHEP* **10** (2004) 031 [[hep-th/0406038](#)] [[INSPIRE](#)].
- [76] B. Grinstein, *Charge Quantization of Wormholes and the Finiteness of Newton's Constant*, *Nucl. Phys. B* **321** (1989) 439 [[INSPIRE](#)].
- [77] K.-M. Lee, *Wormholes and Goldstone Bosons*, *Phys. Rev. Lett.* **61** (1988) 263 [[INSPIRE](#)].
- [78] L.F. Abbott and M.B. Wise, *Wormholes and Global Symmetries*, *Nucl. Phys. B* **325** (1989) 687 [[INSPIRE](#)].
- [79] J.D. Brown, C.P. Burgess, A. Kshirsagar, B.F. Whiting and J.W. York, *Scalar Field Wormholes*, *Nucl. Phys. B* **328** (1989) 213 [[INSPIRE](#)].
- [80] C.P. Burgess and A. Kshirsagar, *Wormholes and Duality*, *Nucl. Phys. B* **324** (1989) 157 [[INSPIRE](#)].
- [81] S.R. Coleman and K.-M. Lee, *Wormholes made without massless matter fields*, *Nucl. Phys. B* **329** (1990) 387 [[INSPIRE](#)].
- [82] G.W. Gibbons, M.B. Green and M.J. Perry, *Instantons and seven-branes in type IIB superstring theory*, *Phys. Lett. B* **370** (1996) 37 [[hep-th/9511080](#)] [[INSPIRE](#)].
- [83] V.A. Rubakov and O. Yu. Shvedov, *A Negative mode about Euclidean wormhole*, *Phys. Lett. B* **383** (1996) 258 [[gr-qc/9604038](#)] [[INSPIRE](#)].
- [84] V.A. Rubakov and O. Yu. Shvedov, *Instability of space-time due to Euclidean wormholes*, [[gr-qc/9608065](#)] [[INSPIRE](#)].
- [85] M.B. Green and M. Gutperle, *Effects of D instantons*, *Nucl. Phys. B* **498** (1997) 195 [[hep-th/9701093](#)] [[INSPIRE](#)].

- [86] E. Bergshoeff, A. Collinucci, A. Ploegh, S. Vandoren and T. Van Riet, *Non-extremal D-instantons and the AdS/CFT correspondence*, *JHEP* **01** (2006) 061 [[hep-th/0510048](#)] [[INSPIRE](#)].
- [87] A. Collinucci, *Instantons and cosmologies in string theory*, Ph.D. thesis, University of Groningen, Groningen, Netherlands (2005).
- [88] N. Arkani-Hamed, J. Orgera and J. Polchinski, *Euclidean wormholes in string theory*, *JHEP* **12** (2007) 018 [[arXiv:0705.2768](#)] [[INSPIRE](#)].
- [89] T. Mohaupt and K. Waite, *Euclidean Actions, Instantons, Solitons and Supersymmetry*, *J. Phys. A* **44** (2011) 175403 [[arXiv:1011.6301](#)] [[INSPIRE](#)].
- [90] E. Witten, *A New Look At The Path Integral Of Quantum Mechanics*, [arXiv:1009.6032](#) [[INSPIRE](#)].
- [91] A. Behtash, G.V. Dunne, T. Schäfer, T. Sulejmanpasic and M. Ünsal, *Complexified path integrals, exact saddles and supersymmetry*, *Phys. Rev. Lett.* **116** (2016) 011601 [[arXiv:1510.00978](#)] [[INSPIRE](#)].
- [92] S.-J. Rey, *The Confining Phase of Superstrings and Axionic Strings*, *Phys. Rev. D* **43** (1991) 526 [[INSPIRE](#)].
- [93] V. Balasubramanian, P. Berglund, J.P. Conlon and F. Quevedo, *Systematics of moduli stabilisation in Calabi-Yau flux compactifications*, *JHEP* **03** (2005) 007 [[hep-th/0502058](#)] [[INSPIRE](#)].
- [94] R.C. Myers and M.J. Perry, *Black Holes in Higher Dimensional Space-Times*, *Annals Phys.* **172** (1986) 304 [[INSPIRE](#)].
- [95] T. Ortin, *Gravity and Strings*, Cambridge Monographs on Mathematical Physics, Cambridge University Press, Cambridge, U.K. (2015).
- [96] S.W. Hawking and D.N. Page, *Thermodynamics of Black Holes in anti-de Sitter Space*, *Commun. Math. Phys.* **87** (1983) 577 [[INSPIRE](#)].
- [97] X.G. Wen and E. Witten, *World Sheet Instantons and the Peccei-Quinn Symmetry*, *Phys. Lett. B* **166** (1986) 397 [[INSPIRE](#)].
- [98] M. Dine, N. Seiberg, X.G. Wen and E. Witten, *Nonperturbative Effects on the String World Sheet*, *Nucl. Phys. B* **278** (1986) 769 [[INSPIRE](#)].
- [99] V. Cortes and T. Mohaupt, *Special Geometry of Euclidean Supersymmetry III: The Local r-map, instantons and black holes*, *JHEP* **07** (2009) 066 [[arXiv:0905.2844](#)] [[INSPIRE](#)].
- [100] S. Coleman, *Aspects of symmetry*, Cambridge University Press, Cambridge, U.K. (1988).
- [101] A.I. Vainshtein, V.I. Zakharov, V.A. Novikov and M.A. Shifman, *ABC's of Instantons*, *Sov. Phys. Usp.* **25** (1982) 195 [[INSPIRE](#)].
- [102] S.B. Giddings and A. Strominger, *Loss of Incoherence and Determination of Coupling Constants in Quantum Gravity*, *Nucl. Phys. B* **307** (1988) 854 [[INSPIRE](#)].
- [103] S.R. Coleman, *Black Holes as Red Herrings: Topological Fluctuations and the Loss of Quantum Coherence*, *Nucl. Phys. B* **307** (1988) 867 [[INSPIRE](#)].
- [104] J. Preskill, *Wormholes in Space-time and the Constants of Nature*, *Nucl. Phys. B* **323** (1989) 141 [[INSPIRE](#)].

- [105] I.R. Klebanov, L. Susskind and T. Banks, *Wormholes and the Cosmological Constant*, *Nucl. Phys. B* **317** (1989) 665 [[INSPIRE](#)].
- [106] W. Fischler and L. Susskind, *A Wormhole Catastrophe*, *Phys. Lett. B* **217** (1989) 48 [[INSPIRE](#)].
- [107] S.R. Coleman and K.-M. Lee, *Escape From the Menace of the Giant Wormholes*, *Phys. Lett. B* **221** (1989) 242 [[INSPIRE](#)].
- [108] J. Polchinski, *Decoupling Versus Excluded Volume or Return of the Giant Wormholes*, *Nucl. Phys. B* **325** (1989) 619 [[INSPIRE](#)].
- [109] E. Bergshoeff, A. Collinucci, U. Gran, D. Roest and S. Vandoren, *Non-extremal instantons and wormholes in string theory*, *Fortsch. Phys.* **53** (2005) 990 [[hep-th/0412183](#)] [[INSPIRE](#)].
- [110] K. Tamvakis, *Two Axion String Wormholes*, *Phys. Lett. B* **233** (1989) 107 [[INSPIRE](#)].
- [111] PLANCK collaboration, P.A.R. Ade et al., *Planck 2015 results. XX. Constraints on inflation*, *Astron. Astrophys.* **594** (2016) A20 [[arXiv:1502.02114](#)] [[INSPIRE](#)].
- [112] J.P. Conlon, *Moduli Stabilisation and Applications in IIB String Theory*, *Fortsch. Phys.* **55** (2007) 287 [[hep-th/0611039](#)] [[INSPIRE](#)].
- [113] M. Reece, *Exploring the Weak Gravity Conjecture*, talk given at the *String Pheno 2016 conference*, Ioannina, Greece, June 20–24, 2016.
- [114] R.P. Feynman, *An Operator calculus having applications in quantum electrodynamics*, *Phys. Rev.* **84** (1951) 108 [[INSPIRE](#)].