



Supporting Information

© 2016 The Authors. Published by Wiley-VCH Verlag GmbH & Co. KGaA, Weinheim

Elucidation of the Enantiodiscrimination Properties of a Nonracemic Chiral Alignment Medium through Gel-based Capillary Electrochromatography: Separation of the Mefloquine Stereoisomers

"Ayat Allah" Al-Massaedh,^[a, b] Manuel Schmidt,^[c] Ute Pyell,^{*[a]} and Uwe M. Reinscheid^{*[c]}

open_201600085_sm_miscellaneous_information.pdf

Contents

1	Experimental Details	S2
2	Chromatographic System	S5
3	Residual Dipolar Coupling Constants – Alignment	S7
4	Calculation of Retention Factors	S8
5	Peak Broadening with Monolithic Capillary	S12
6	Peak Identification	S13
7	Repeatability	S14

1 Experimental Details

Capillary Pretreatment. The fused silica capillaries were first pre-treated with 3-(trimethoxysilyl) propylmethacrylate (bind silane) with the effect to introduce vinylic anchoring groups on the inner wall of the fused silica capillary (covalent attachment of the synthesized gel to the inner capillary wall, method introduced by Hjertén [S. Hjertén, *Arch. Biochem. Biophys.*, Suppl. 1, **1962**, 147]). The capillaries are initially flushed in each case for 15 minutes with acetone, hydrochloric acid solution (0.1 M), sodium hydroxide solution (0.1 M), water, and finally with acetone (cleaning procedure). They are subsequently rinsed for 30 min with a 30 % (v/v) solution of 3-(trimethoxysilyl) propylmethacrylate (bind silane) in acetone. Both ends of the capillary were then sealed with silicone grease and left overnight at room temperature filled with this solution. Finally, the capillaries are rinsed with acetone and water each for 15 minutes.

Gel Synthesis. For the polymerization reaction, 75 mg (*R*)-2-acrylamido-2-phenylethane-1-sulfonic acid ((*R*)-APhES) (Scheme S1A), 31 mg *N,N*-dimethylacrylamide (DMAA), and 2.8 mg *N,N*-methylenebisacrylamide (BIS) were dissolved in either 500 μ L distilled water or 500 μ L distilled water/methanol (75:25, v/v) or 500 μ L distilled water/methanol (50:50, v/v). At the beginning, the polymerization mixture was degassed for 10-15 min using a membrane vacuum pump. Then the apparatus was refilled with argon. After that, 25 μ L of an aqueous 1% (w/v) ammonium persulfate (APS) solution were added to the solution, which was then mixed using a spatula for 3-5 seconds. Subsequently, the capillary is dipped into the reaction mixture, and with help of an argon overpressure (ca. 1-2 bar) the reaction mixture is passed into the capillary. This process continues until the first drop of the polymerization mixture becomes visible on the top of the end of the capillary. Both ends of the capillary were then sealed with silicone grease and the polymerization process was allowed to proceed for 15 minutes at 70 °C (immersion of a container into a water bath). The detection window was created at one section of the capillary using a sharp blade. Before installing the capillary in the CEC instrument, a few millimetres (ca. 10 mm) of the outer polyimide coating were removed from the inlet side of the monolithic capillary. Finally, the capillary is installed in the CEC apparatus and equilibrated with mobile phase at low voltage.

Monolith Synthesis. Monomers, cross-linker, and salt were dissolved in 0.80 mL of 100 mM phosphate buffer (pH = 7.0): 0.081 g (*R*)-2-acrylamido-2-phenylethansulfonic acid ((*R*)-APhES), 0.061 g *N*-isopropylacrylamide (NIP), 0.104 g piperazinediacrylamide (PDA), and 0.036 g ammonium sulfate (AS). Filling the capillary with the polymerization mixture was done with an in-house manufactured capillary-filling apparatus. At the beginning, the polymerization mixture was degassed for 10-15 min using a membrane vacuum pump. Then the apparatus was refilled with argon. After that 15 μ L of 15% (w/v) ammonium persulfate (APS) and 15 μ L of 15% (v/v) *N,N,N',N'*-tetramethylethylenediamine (TEMED) solution were added and the solution was mixed using a spatula for 3-5 s. Subsequently, the capillary was dipped into the reaction mixture, and with help of an argon overpressure (ca. 1-2 bar) the reaction mixture was passed into the capillary. This process was continued until the first drop of the polymerization mixture became visible on the top of the end of the capillary. Both ends of the capillary were then sealed with silicone grease and the polymerization process was allowed to proceed overnight at room temperature. Afterwards, the resulting monolith was rinsed with distilled water for about 2-3 h with the help of an HPLC pump (50-100 bar) and a flow splitter. The detection window was created in the capillary during the rinsing process by burning off 1-2 mm of the outer polyimide coating and pyrolyzing and removing the monolith inside by a stream of water. Before installing the capillary in the CEC instrument, a few mm (ca. 10 mm) of the outer polyimide coating were removed from the inlet side of the monolithic capillary using a sharp blade. Finally, the capillary was installed in the CEC apparatus and rinsed and equilibrated with mobile phase.

Materials. (*R*)-2-acrylamido-2-phenylethansulfonic acid ((*R*)-APhES) was synthesized according to the procedure described in [8]. All chemicals were used without further purification. The racemic mixture and the (+)-enantiomer of the *erythro*-form of mefloquine-HCl was obtained from SynphaBase AG (Pratteln, Switzerland), while the racemic mixture of the *threo*-form of mefloquine-HCl was from Bioblocks (San Diego, CA USA). *N,N,N',N'*-Tetramethylethylenediamine (TEMED), 3-(trimethoxysilyl) propyl methacrylate (bind silane), di-sodium hydrogenphosphate dehydrate, and ammonium sulfate (AS) were from Fluka (Buchs, Switzerland). (\pm)-Propranolol (Scheme S1B) hydrochloride, *N*-isopropylacrylamide (NIP), *N,N*-dimethylacrylamide (DMAA), and *N,N*-methylenebisacrylamide (BIS) were from Sigma Aldrich (Steinheim, Germany). Ammonium peroxodisulfate (APS), acetic acid, sodium dihydrogen phosphate monohydrate, and

triethylamine (TEA) were from Merck (Darmstadt, Germany). 1,4-Bis(acryloyl)piperazine (piperazinediacrylamide, PDA) was from Molekula (Dorset, UK). Acetonitrile and methanol were HPLC grade from VWR-BDH-Prolabo (Leuven, Belgium).

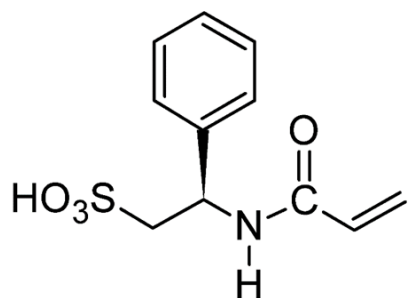

Scheme S1A. Structural formula of the chiral monomer (*R*)-APhES ((2-acrylamide)-2-phenyl-ethanesulfonic acid)

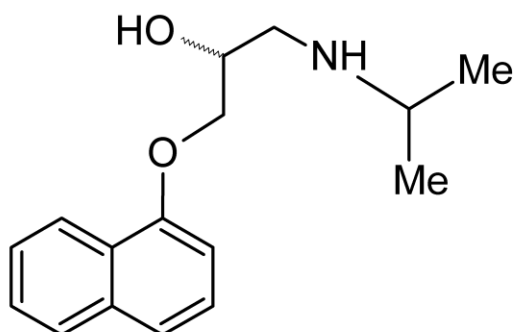

Scheme S1B. Structural formula of racemic propranolol

2 Chromatographic System

Apparatus. The CEC apparatus was already described (A. Wahl, I. Schnell, U. Pyell, *J. Chromatogr. A* **2004**, *1044*, 211-222; see Scheme S2) and consists of a FUG HCN 35-35000 high voltage generator (F.U.G. Elektronik GmbH, Rosenheim, Germany) with an in-house manufactured electronic steering unit for controlled electrokinetic injection, a spectra 100 UV-VIS detector (Thermo Separation Product, San Jose, CA, USA) with detection cell for in-capillary detection, and a Shimadzu (Kyoto, Japan) LC-10 AD HPLC pump for conditioning and equilibrating the monolithic capillary with new mobile phase using 50-100 bar. Data treatment and recording was done with EZ-Chrom 6.6 (Scientific Software, San Roman, CA, USA). Sample solutions (250 mg L⁻¹) were prepared in the mobile phase. Sample injection was performed electrokinetically. Photometric in-gel detection was at a wavelength of 283 nm, while with monoliths UV detection was in a free section of the monolith at a wavelength of 290 nm. Fused silica capillaries (100 µm I.D. x 360 µm O.D.) were from Polymicro Technologies (Phoenix, AZ, USA).

Preparation of Mobile Phases for GBCEC. For those gels synthesized from pure aqueous solutions, mobile phases prepared in pure methanol were used, while with those gels synthesized from solutions in water/methanol (75:25, v/v) also the mobile phase was prepared in water/methanol (75:25, v/v), and for those gels synthesized from solutions in water/methanol (50:50, v/v) also the mobile phase was prepared in water/methanol (50:50, v/v). Mobile phases were prepared by adding the appropriate amounts of pure acetic acid and triethylamine. With all mobile phases the specific electric conductivity and the pH* value were controlled with a pH meter Inolan pH 720 (WTW, Weinheim, Germany), and a conductometer LF 191 (WTW, Weinheim, Germany). The pH* value is the pH in the presence of organic solvent with a pH meter calibrated with aqueous buffer. The pH* was determined with the mobile phase after addition of the organic solvent to the aqueous buffer.

Preparation of Mobile Phases for CEC. With the monolithic capillaries, mobile phases were prepared by mixing acetonitrile with 10mM phosphate buffer. With all mobile phases the specific electric conductivity and the pH* value were controlled as described above.

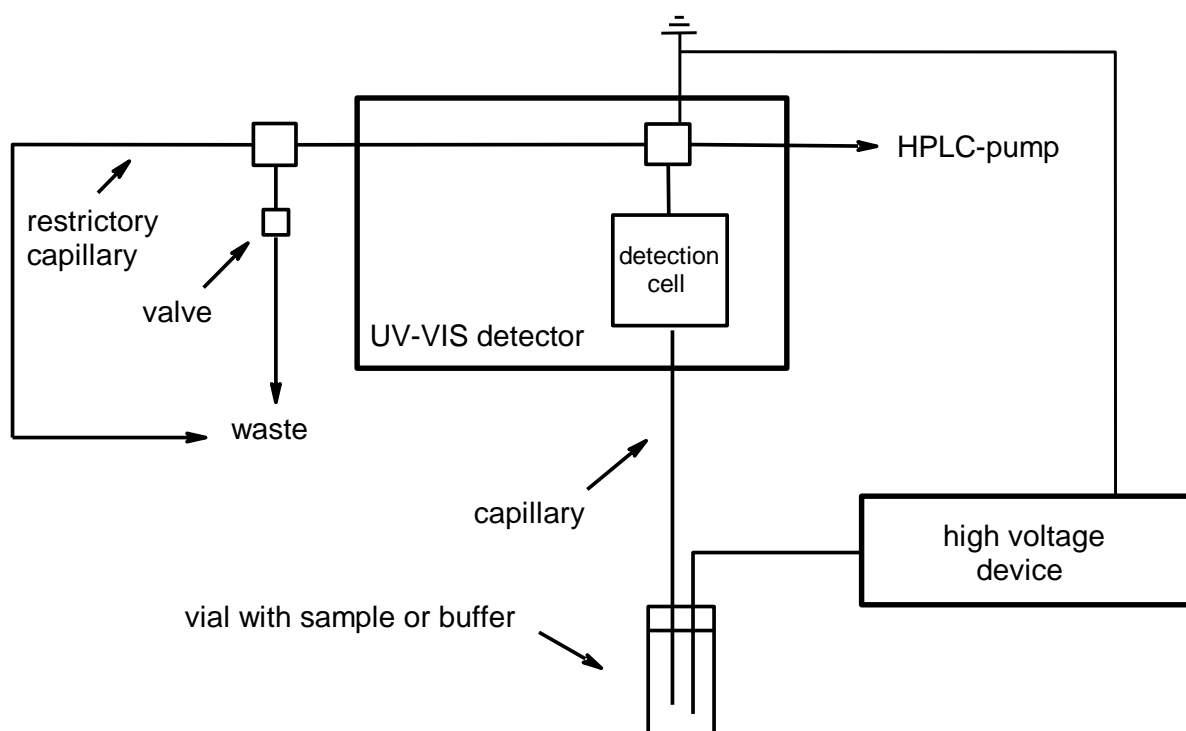

Scheme S2. Scheme of used CEC apparatus. Reproduced with permission from [A. Wahl, I. Schnell, U. Pyell, *J. Chromatogr. A* **2004**, *1044*, 211-222].

3 Residual Dipolar Coupling Constants – Alignment

For experimental details of the measurement of the residual dipolar coupling constants (RDCs) discussed in this publication refer to ESI of [8] of the main text. The principle of alignment in anisotropically deformed gels is illustrated below (Scheme S3A and B).

Under isotropic conditions, anisotropic parameters such as dipolar couplings between two NMR-sensitive nuclei are averaged to zero (F. Kramer, M. V. Deshmukh, H. Kessler, S. J. Glaser, *Conc. Magn. Reson. A* **2003**, 21A, 10-21). So-called alignment media lead to a low degree of orientation and re-introduce observable couplings. Using only a weak alignment, the large dipolar couplings which are in the range of kHz are scaled down to values in the range of Hz (residual dipolar couplings, RDCs) (C. M. Thiele, *Conc. Magn. Reson. A* **2007**, 30A, 65-80). With a set of experimentally determined RDCs, an alignment tensor (a 3×3 matrix with five independent elements) can be calculated, which describes the degree and orientation of the alignment (F. Kramer, M. V. Deshmukh, H. Kessler, S. J. Glaser, *Conc. Magn. Reson. A* **2003**, 21A, 10-21).

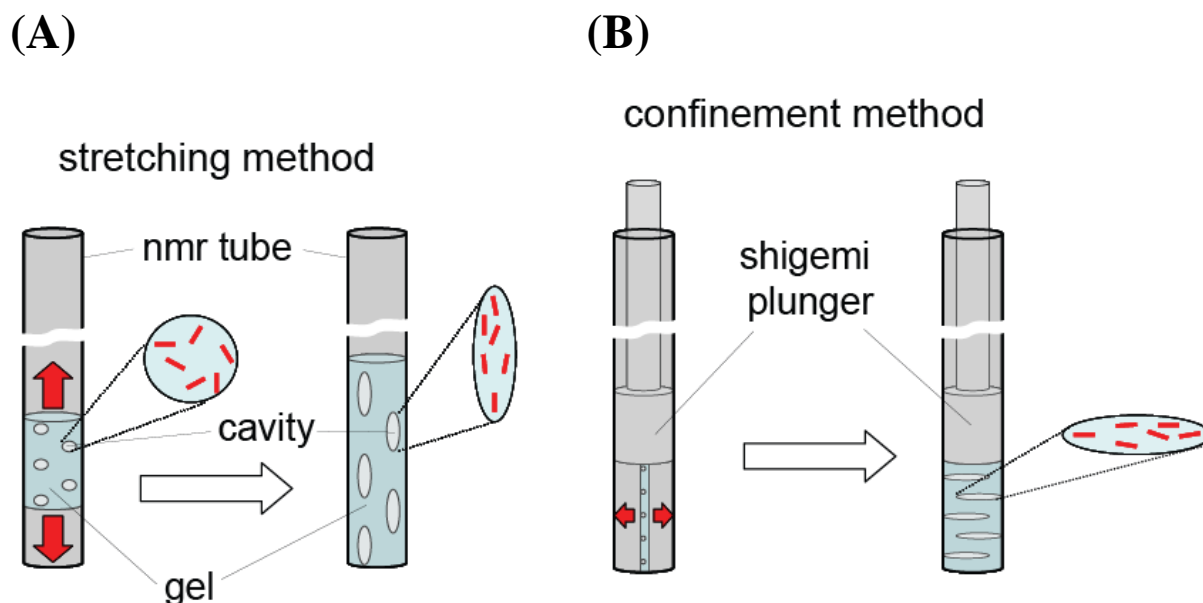

Scheme S3A and B. Schematic view of the different alignment methods: (A) stretching method and (B) confinement method. In the stretching method, the gel swells preferentially along the tube axis, while in the confinement method a Shigemi plunger only allows swelling perpendicular to the tube axis. Circles and ellipsoids indicate the shape of the cavities in which the analyte molecules (rods in red) are aligned.

The influence of the electrolyte concentration on alignment properties of a very similar achiral polyacrylamide gel (APhES replaced by 2-(acrylamide)-2-methyl-propanesulfonic acid (AMPS)) was determined by Trigo-Mouriño *et al.* (P. Trigo-Mouriño, A. Navarro-Vázquez, V. M. Sánchez-Pedregal, *Magn. Reson. Chem.* **2012**, *50*, S29-37). According to these results, we can assume a negligible influence of the selected buffer concentration (2.7 mM) on alignment properties and retention behaviour.

4 Calculation of Retention Factors

Method 1.

In this method, we calculate selectivity factors by comparing retention times obtained with capillaries of different length filled with alignment medium (gels synthesized according to the same method).

We take the retention times from the chromatograms depicted in Figure S5 (Capillary A) and Figure 4 (Capillary B) (for experimental data refer to figure legends).

We start by defining following indexes:

1: relates to the analyte eluted first

2: relates to the analyte eluted later

A: relates to run with Capillary A

B: relates to run with Capillary B

According to this definition we have the following data:

$t_{1,A} = 28.84$ min; $t_{2,A} = 29.33$ min; $t_{1,B} = 54.43$ min; $t_{2,B} = 56.89$ min

$L_{T,A} = 26.20$ cm; $L_{T,B} = 23.40$ cm; $L_{eff,A} = 19.40$ cm; $L_{eff,B} = 16.70$ cm

$U_A = 10.0$ kV; $U_B = 6.1$ kV

with t = migration time, L_T = total length of capillary, L_{eff} = effective length of capillary to detector,

U = applied voltage during separation

Retention factors k and selectivity factors α are defined by (t_0 = hold-up time):

$$k_{1,A} = \frac{t_{1,A} - t_{0,A}}{t_{0,A}}; k_{2,A} = \frac{t_{2,A} - t_{0,A}}{t_{0,A}}; k_{1,B} = \frac{t_{1,B} - t_{0,B}}{t_{0,B}}; k_{2,B} = \frac{t_{2,B} - t_{0,B}}{t_{0,B}}$$

$$\alpha_A = \frac{k_{2,A}}{k_{1,A}}; \alpha_B = \frac{k_{2,B}}{k_{1,B}}$$

First assumption:

$\alpha = \alpha_A = \alpha_B$ (This assumption holds true, if the separation medium is identical.)

From this assumption follows:

$$\frac{t_{2,A} - t_{0,A}}{t_{1,A} - t_{0,A}} = \frac{t_{2,B} - t_{0,B}}{t_{1,B} - t_{0,B}} \quad (\text{Eq. S1})$$

Second assumption:

$$\mu_{\text{mob},A} = \mu_{\text{mob},B} = \mu_{\text{mob}}$$

(This assumption holds true, if differences in the sieving effect can be neglected.)

$\mu_{\text{mob}} = \mu_{\text{eo}} + \mu_{\text{ep,eff}}$ with μ_{mob} = observed mobility of the analyte in the electrokinetic transport zone;

μ_{eo} = electroosmotic mobility and $\mu_{\text{ep,eff}}$ = effective electrophoretic mobility of the analyte in the electrokinetic transport zone (μ_{mob} corresponds to the observed mobility of an ideal hold-up time marker)

From this assumption follows:

$$v_{0,A} = \frac{L_{\text{eff},A}}{t_{0,A}}; v_{0,B} = \frac{L_{\text{eff},B}}{t_{0,B}}; v_{0,A} = \mu_{\text{mob}} \frac{U_A}{L_{T,A}}; v_{0,B} = \mu_{\text{mob}} \frac{U_B}{L_{T,B}}$$

with v_0 = velocity of the analyte in the electrokinetic transport zone.

We can combine:

$$\frac{L_{\text{eff},A}}{t_{0,A}} = \mu_{\text{mob}} \frac{U_A}{L_{T,A}}; \frac{L_{\text{eff},B}}{t_{0,B}} = \mu_{\text{mob}} \frac{U_B}{L_{T,B}}$$

Rearranged (solved for μ_{mob}) and equalized:

$$\frac{L_{T,A} \cdot L_{\text{eff},A}}{U_A \cdot t_{0,A}} = \frac{L_{T,B} \cdot L_{\text{eff},B}}{U_B \cdot t_{0,B}}$$

$$t_{0,A} = t_{0,B} \cdot \frac{U_B}{U_A} \cdot \frac{L_{T,A} \cdot L_{eff,A}}{L_{T,B} \cdot L_{eff,B}}$$

with $F = \frac{U_B}{U_A} \cdot \frac{L_{T,A} \cdot L_{eff,A}}{L_{T,B} \cdot L_{eff,B}}$ we obtain: $t_{0,A} = F \cdot t_{0,B}$ (Eq. S2)

Factor F can be calculated:

$$F = \frac{6.1 \text{ kV} \cdot 26.20 \text{ cm} \cdot 19.40 \text{ cm}}{10.0 \text{ kV} \cdot 23.40 \text{ cm} \cdot 16.70 \text{ cm}} = 0.793$$

Substituting $t_{0,A}$ in Eq. S1 by Eq. S2 results in:

$$\frac{t_{2,A} - F \cdot t_{0,B}}{t_{1,A} - F \cdot t_{0,B}} = \frac{t_{2,B} - t_{0,B}}{t_{1,B} - t_{0,B}}$$

This equation permits the calculation of the hold-up times:

$$t_{2,A} t_{1,B} - t_{2,A} t_{0,B} - F \cdot t_{0,B} t_{1,B} + F \cdot t_{0,B}^2 = t_{1,A} t_{2,B} - t_{1,A} t_{0,B} - F \cdot t_{0,B} t_{2,B} + F \cdot t_{0,B}^2$$

$$t_{1,A} t_{0,B} + F \cdot t_{0,B} t_{2,B} - t_{2,A} t_{0,B} - F \cdot t_{0,B} t_{1,B} = t_{1,A} t_{2,B} - t_{2,A} t_{1,B}$$

$$t_{0,B} = \frac{t_{1,A} t_{2,B} - t_{2,A} t_{1,B}}{t_{1,A} + F \cdot t_{2,B} - t_{2,A} - F \cdot t_{1,B}}$$

$$t_{0,B} = \frac{28.84 \text{ min} \cdot 56.89 \text{ min} - 29.33 \text{ min} \cdot 54.43 \text{ min}}{28.84 \text{ min} + F \cdot 56.89 \text{ min} - 29.33 \text{ min} - F \cdot 54.43 \text{ min}}$$

With the results:

$$t_{0,A} = 24.03 \text{ min}, t_{0,B} = 30.29 \text{ min}$$

$$k_{1,A} = 0.2001; k_{2,A} = 0.2205; k_{1,B} = 0.7970; k_{2,B} = 0.8782$$

$$\alpha_A = 1.102; \alpha_B = 1.102$$

Method 2. In this method, (\pm)-propranolol ($pK_A = 9.46$) is taken as a nonretarded marker of the chromatographic hold-up time (refer to Figure 3 in the main text, and Scheme S1B and Figure S1 in the supporting information). In contrast to mefloquine, showing a clear strong retention due to the obtained resolution for the four stereoisomers, there is no resolution for the two enantiomers of (\pm)-propranolol. Propranolol and mefloquine are basic and can be expected to bear under the conditions of the chromatographic separation an effective charge number of +1. Due to their similar size, they can be regarded to have an approximately identical effective electrophoretic mobility in the electrokinetic transport zone $\mu_{ep,eff}$, which is a prerequisite of using (\pm)-propranolol as a nonretarded marker of the chromatographic hold-up time.

From the chromatogram shown in Figure 3 we obtain the following data: $t_0 = 30.48$ min, $t((1)\text{-t-MQ}) = 42.83$ min, $t((2)\text{-t-MQ}) = 43.84$ min, $t((-)\text{-e-MQ}) = 52.69$ min, $t((+)\text{-e-MQ}) = 54.83$ min.

From the definition of the retention factor k and the selectivity factor α (*cf.*, Page S9) follows:

$k((1)\text{-t-MQ}) = 0.405$, $k((2)\text{-t-MQ}) = 0.438$, $k((-)\text{-e-MQ}) = 0.729$, $k((+)\text{-e-MQ}) = 0.799$,
 $\alpha(\text{t-MQ}) = 1.082$, $\alpha(\text{e-MQ}) = 1.096$.

5 Peak Broadening with Monolithic Capillary

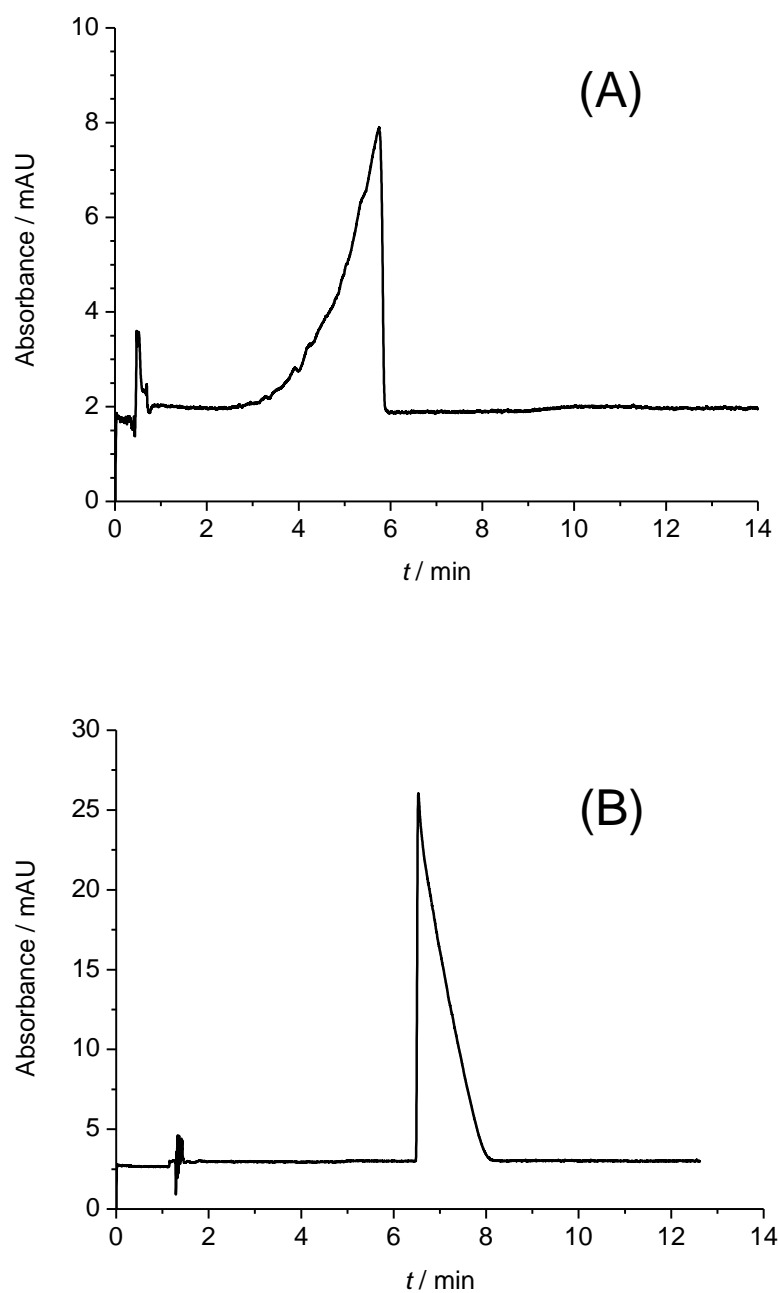

Figure S1. Peak broadening observed for (±)-propranolol with monolithic capillary (refer to Section S2). (A) Mobile phase acetonitrile/10mM phosphate buffer (80:20, v/v) $\text{pH}^* = 5.80$, electric conductivity $70 \mu\text{S cm}^{-1}$; (B) mobile phase: acetonitrile/10mM phosphate buffer (50:50, v/v) $\text{pH}^* = 6.24$, electric conductivity $300 \mu\text{S cm}^{-1}$. Capillary dimensions 232 mm (163 mm) \times 100 μm , UV detection 290 nm, electrokinetic injection 6 kV \times 6 s, separation voltage 22.0 kV, $c(\text{analyte in sample}) = 0.25 \text{ g L}^{-1}$.

6 Peak Identification

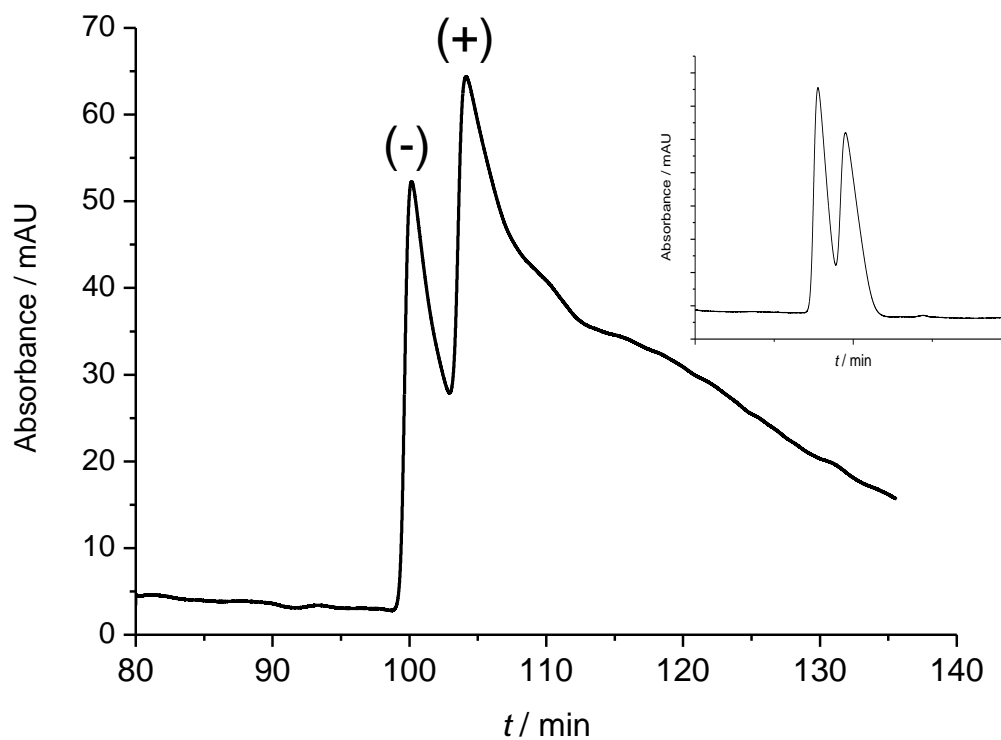

Figure S2. Separation of the enantiomers of erythro-mefloquine by GBCEC with alignment gel as separation medium. Peak identification by spiking the racemic mixture of (\pm)-erythro-mefloquine with (+)-erythro-mefloquine. Mobile phase: methanol buffered with triethylamine/acetic acid pH* = 4.46, electric conductivity $55 \mu\text{S cm}^{-1}$, capillary dimensions 267 mm (198 mm) \times 100 μm . Photometric in-gel detection 283 nm, electrokinetic injection 3 kV \times 3 s. Separation voltage: 3.5 kV, $c(\text{analyte in sample}) = 0.25 \text{ g L}^{-1}$ (sample dissolved in the mobile phase). The inset shows the separation of the enantiomers before spiking the sample (racemic mixture).

7 Repeatability

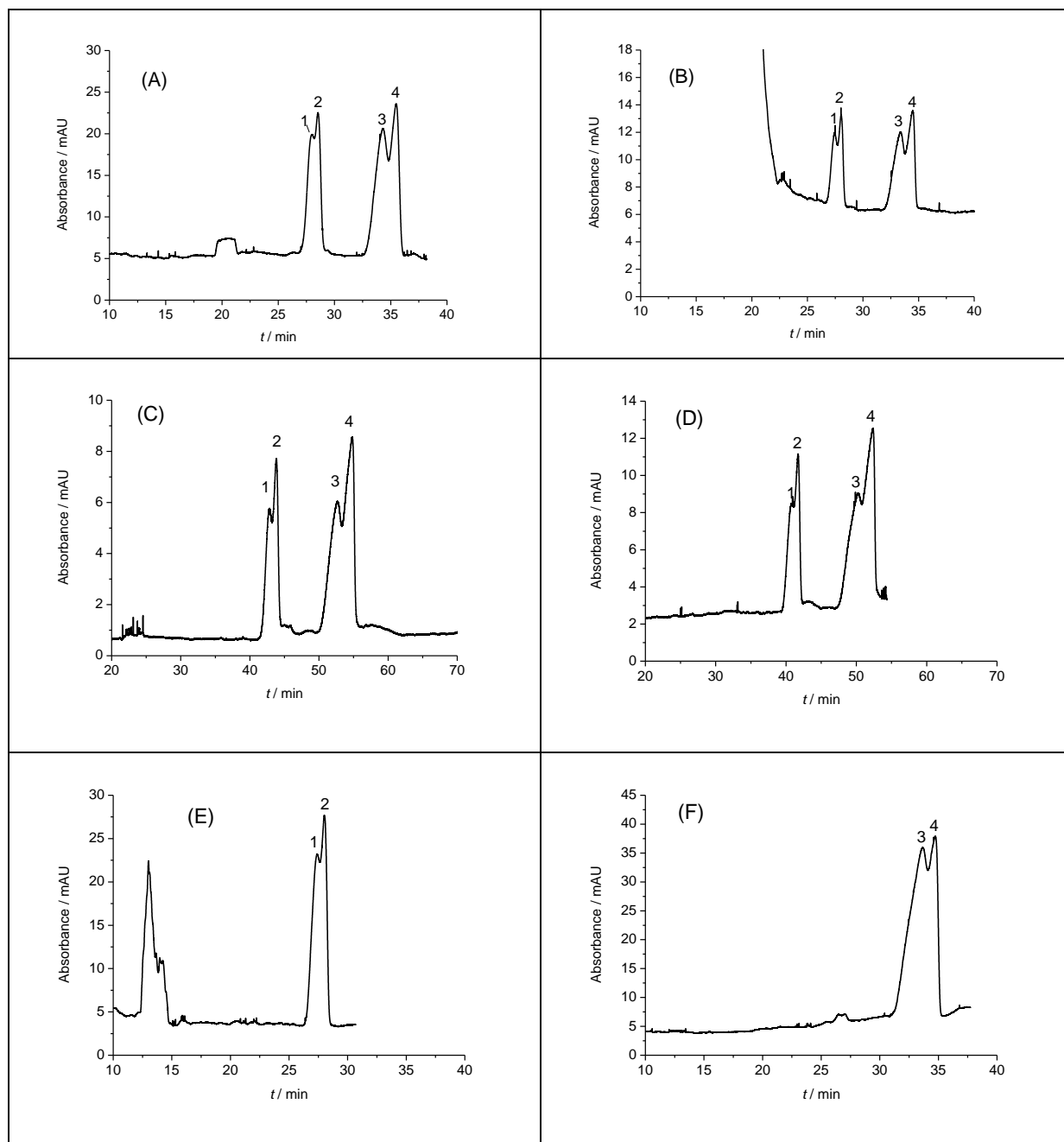

Figure S3. Repeated separation of the four stereoisomers of mefloquine and reference runs with single diastereomer with alignment gel as separation medium. Peak assignment: 1 and 2 (\pm)-*threo*-mefloquine, 3 (*-*)-*erythro*-mefloquine, 4 (*+*)-*erythro*-mefloquine, mobile phase: methanol/water (50:50, v/v) buffered with triethylamine/acetic acid, pH* = 6.66, electric conductivity 125 $\mu\text{S cm}^{-1}$, capillary dimensions 173 mm (102 mm) \times 100 μm , photometric in-gel detection 283 nm, electrokinetic injection 2 kV \times 2 s, separation voltage: (A+B+E+F) 3.0 kV, (C+D) 2.0 kV, c(analyte in sample) = 0.25 g L^{-1} (analyte dissolved in mobile phase).

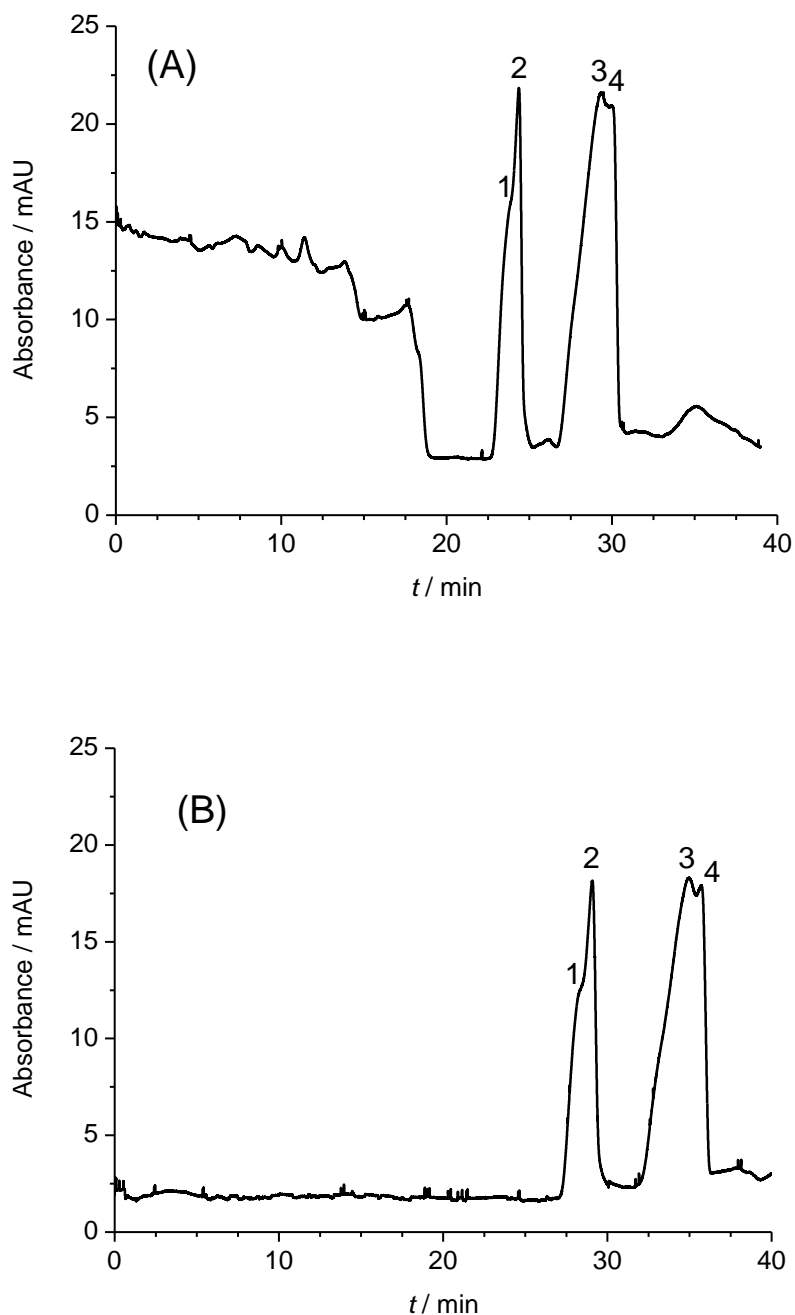

Figure S4. Repeated separation of the four stereoisomers of mefloquine with alignment gel as separation medium. Peak assignment: 1 and 2 (\pm)-*threo*-mefloquine, 3 (-)-*erythro*-mefloquine, 4 (+)-*erythro*-mefloquine, mobile phase: methanol/water (25:75, v/v) buffered with triethylamine/acetic acid, $\text{pH}^* = 6.16$, electric conductivity $123 \mu\text{S cm}^{-1}$, capillary dimensions 170 mm (100 mm) \times 100 μm , photometric in-gel detection 283 nm, electrokinetic injection 2 kV \times 2 s, separation voltage: (A) 3.0 kV, (B) 2.5 kV, $c(\text{analyte in sample}) = 0.25 \text{ g L}^{-1}$ (analyte dissolved in mobile phase).

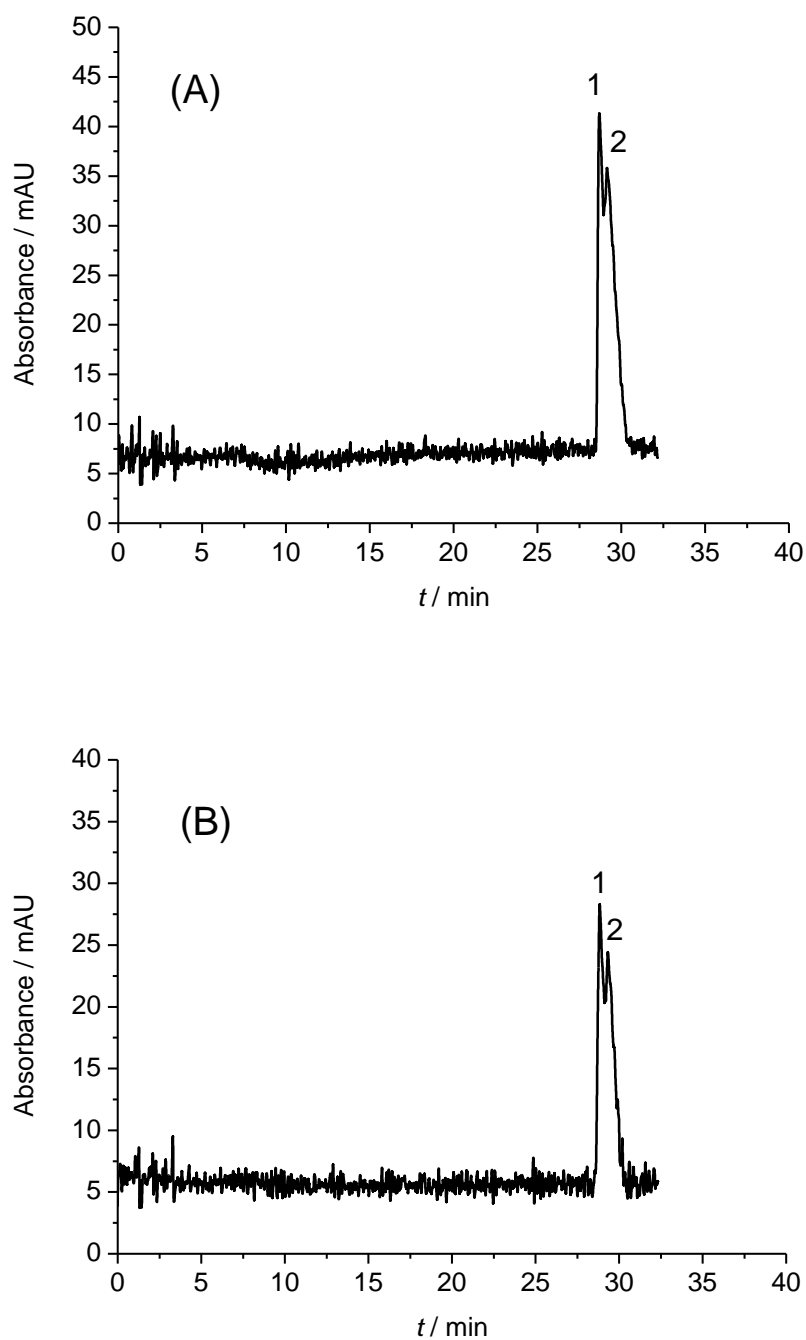

Figure S5. Repeated separation of the enantiomers of (\pm)-*erythro*-mefloquine with alignment gel as separation medium. Peak assignment: 1 (-)-*erythro*-mefloquine, 2 (+)-*erythro*-mefloquine, mobile phase: methanol buffered with triethylamine/acetic acid, $\text{pH}^* = 4.46$, electric conductivity $55 \mu\text{S cm}^{-1}$, capillary dimensions $262 \text{ mm (194 mm)} \times 100 \mu\text{m}$, photometric in-gel detection 283 nm , electrokinetic injection $3 \text{ kV} \times 3 \text{ s}$, separation voltage: 10 kV , $c(\text{analyte in sample}) = 0.25 \text{ g L}^{-1}$ (analyte dissolved in mobile phase).

Table S1. Observed mobilities μ_{ob} for the repeated separation of the four stereoisomers of mefloquine (for experimental parameters refer to Figure. S3, t_R = retention time, U = separation voltage, RSD = relative standard deviation, ref. = reference run with sample containing only single diastereomer).

Analyte	Run	t_R /min	U/kV	$\mu_{ob}/(\text{cm}^2 \text{kV}^{-1} \text{min}^{-1})$
<i>threo</i> -mefloquine-1	1	27.98	3.0	2.103
<i>threo</i> -mefloquine-1	2	27.44	3.0	2.143
<i>threo</i> -mefloquine-1	3	42.83	2.0	2.060
<i>threo</i> -mefloquine-1	4	40.75	2.0	2.165
<i>threo</i> -mefloquine-1	ref.	27.39	3.0	2.147
RSD				2.00%
<i>threo</i> -mefloquine-2	1	28.54	3.0	2.061
<i>threo</i> -mefloquine-2	2	28.03	3.0	2.098
<i>threo</i> -mefloquine-2	3	43.84	2.0	2.013
<i>threo</i> -mefloquine-2	4	41.74	2.0	2.114
<i>threo</i> -mefloquine-2	ref.	28.01	3.0	2.100
RSD				1.97%
(-)- <i>erythro</i> -mefloquine	1	34.31	3.0	1.715
(-)- <i>erythro</i> -mefloquine	2	33.38	3.0	1.762
(-)- <i>erythro</i> -mefloquine	3	52.67	2.0	1.675
(-)- <i>erythro</i> -mefloquine	4	50.25	2.0	1.756
(-)- <i>erythro</i> -mefloquine	ref.	33.67	3.0	1.747
RSD				2.08%
(+)- <i>erythro</i> -mefloquine	1	35.48	3.0	1.658
(+)- <i>erythro</i> -mefloquine	2	34.48	3.0	1.706
(+)- <i>erythro</i> -mefloquine	3	54.78	2.0	1.611
(+)- <i>erythro</i> -mefloquine	4	52.35	2.0	1.686
(+)- <i>erythro</i> -mefloquine	ref.	34.73	3.0	1.693
RSD				2.27%