

MAXIMAL COHEN–MACAULAY MODULES OVER NON–ISOLATED SURFACE SINGULARITIES AND MATRIX PROBLEMS

IGOR BURBAN AND YURIY DROZD

Dedicated to Claus Ringel on the occasion of his birthday

ABSTRACT. In this article we develop a new method to deal with maximal Cohen–Macaulay modules over non–isolated surface singularities. In particular, we give a negative answer on an old question of Schreyer about surface singularities with only countably many indecomposable maximal Cohen–Macaulay modules. Next, we prove that the degenerate cusp singularities have tame Cohen–Macaulay representation type. Our approach is illustrated on the case of $\mathbb{k}\llbracket x, y, z \rrbracket / (xyz)$ as well as several other rings. This study of maximal Cohen–Macaulay modules over non–isolated singularities leads to a new class of problems of linear algebra, which we call representations of decorated bunches of chains. We prove that these matrix problems have tame representation type and describe the underlying canonical forms.

CONTENTS

1. Introduction, motivation and historical remarks	2
2. Generalities on maximal Cohen–Macaulay modules	7
2.1. Maximal Cohen–Macaulay modules over surface singularities	7
2.2. On the category $\text{CM}^{\text{lf}}(A)$	9
3. Main construction	10
4. Serre quotients and proof of Main Theorem	14
5. Maximal Cohen–Macaulay modules over $\mathbb{k}\llbracket x, y, z \rrbracket / (x^2 + y^3 - xyz)$	23
6. Representations of decorated bunches of chains–I	27
6.1. Notation	27
6.2. Bimodule problems	28
6.3. Definition of a decorated bunch of chains	32
6.4. Matrix description of the category $\text{Rep}(\mathfrak{X})$	33
6.5. Strings and Bands	35
7. Representations of decorated bunches of chains–II	38
7.1. Idea of the proof	39
7.2. Reduction Cases	41
7.3. Decorated Kronecker problem	50
8. Maximal Cohen–Macaulay modules over degenerate cusps–I	51
8.1. Maximal Cohen–Macaulay modules over $\mathbb{k}\llbracket x, y, z \rrbracket / (xyz)$	51
8.2. Maximal Cohen–Macaulay modules over $\mathbb{k}\llbracket x, y, u, v \rrbracket / (xy, uv)$	56
8.3. Maximal Cohen–Macaulay modules over $\mathbb{k}\llbracket x, y, z, u, v \rrbracket / (xz, xu, yu, yv, zv)$	57
9. Singularities obtained by gluing cyclic quotient singularities	57
9.1. Non–isolated surface singularities obtained by gluing normal rings	57
9.2. Generalities about cyclic quotient singularities	60
9.3. Degenerate cusps and their basic properties	61

9.4. Irreducible degenerate cusps	62
9.5. Other cases of degenerate cusps which are complete intersections	63
10. Maximal Cohen–Macaulay modules over degenerate cusps–II	64
10.1. Maximal Cohen–Macaulay modules on cyclic quotient surface singularities	65
10.2. Matrix problem for degenerate cusps	67
11. Schreyer’s question	69
12. Remarks on rings of discrete and tame CM–representation type	72
12.1. Non–reduced curve singularities	72
12.2. Maximal Cohen–Macaulay modules over the ring $\tilde{D}((1,0))$	73
12.3. Other surface singularities of discrete and tame CM–representation type	75
12.4. On deformations of certain non–isolated surface singularities	75
13. Appendix A: Category of triples in dimension one	76
14. Appendix B: Decorated conjugation problem	80
14.1. Some preparatory results from linear algebra	82
14.2. Reduction to the decorated chessboard problem	83
14.3. Reduction procedure for the decorated chessboard problem	85
14.4. Indecomposable representations of a decorated chessboard	89
References	91

1. INTRODUCTION, MOTIVATION AND HISTORICAL REMARKS

In this article, we essentially deal with the following question. Let $f \in (x, y, z)^2 \subseteq \mathbb{C}[[x, y, z]] =: S$ be a polynomial. How to describe all pairs $(\varphi, \psi) \in \text{Mat}_{n \times n}(S)^{\times 2}$ such that $\varphi \cdot \psi = \psi \cdot \varphi = f \cdot \mathbb{1}_{n \times n}$? Such a pair of matrices (φ, ψ) is also called *matrix factorization* of f . One of the earliest examples of this kind, dating back to Dirac, is the following formula for a “square root” of the Laplace operator:

$$\Delta := \left[\partial_x^2 + \partial_y^2 + \partial_z^2 \right] \mathbb{1}_{2 \times 2} = \left[\partial_x \begin{pmatrix} 1 & 0 \\ 0 & -1 \end{pmatrix} + \partial_y \begin{pmatrix} 0 & 1 \\ 1 & 0 \end{pmatrix} + \partial_z \begin{pmatrix} 0 & i \\ -i & 0 \end{pmatrix} \right]^2 =: \nabla^2.$$

Equivalently, the pair (φ, φ) is a matrix factorization of the polynomial $f = x^2 + y^2 + z^2$, where $\varphi = \begin{pmatrix} x & y-iz \\ y+iz & -x \end{pmatrix}$. One can show (see, for example [78, Chapter 11]) that up to a certain natural equivalence relation, the pair (φ, φ) is the *only* non–trivial matrix factorization of f . A certain version of this fact was already known to Dirac. One of the results of our paper is a complete classification of all matrix factorizations of the polynomial $f = xyz$, see Subsection 8.1.

According to Eisenbud [38], the problem of description of all matrix factorizations of a polynomial f can be rephrased as the question to classify all *maximal Cohen–Macaulay* modules over the hypersurface singularity $A = S/(f)$. The latter problem can (and actually should) be posed in a much broader context of local Cohen–Macaulay rings or even in the non–commutative set-up of orders over local Noetherian rings. This point of view was promoted by Auslander starting from his work [5]. The theory of maximal Cohen–Macaulay modules over orders (called in this framework *lattices*) dates back to the beginning of the twentieth century and has its origin in the theory of integral representations of finite groups, see for example [24].

For a *Gorenstein* local ring (A, \mathfrak{m}) , Buchweitz observed that the stable category of maximal Cohen–Macaulay modules $\underline{\mathbf{CM}}(A)$ is triangulated and proved that the functor

$$(1.1) \quad \underline{\mathbf{CM}}(A) \longrightarrow D_{\text{sg}}(A) := \frac{D^b(A - \text{mod})}{\text{Perf}(A)}$$

is an equivalence of triangulated categories, where $D^b(A - \text{mod})$ is the derived category of Noetherian A -modules and $\text{Perf}(A)$ is its full subcategory of perfect complexes [14].

In the past decade, there was a significant growth of interest to a study of maximal Cohen–Macaulay modules and matrix factorizations. At this place, we mention only the following four major directions, which were born in this period.

- Kapustin and Li discovered a connection between the theory of matrix factorizations with topological quantum field theories [54].
- Khovanov and Rozansky suggested a new approach to construct invariants of links, based on matrix factorizations of certain polynomials [56].
- Van den Bergh introduced the notion of a non-commutative crepant resolution of a normal Gorenstein singularity [75]. It turned out that this theory is closely related with the study of cluster-tilting objects in stable categories of maximal Cohen–Macaulay modules over Gorenstein singularities [21, 50, 51].
- Finally, Orlov established a close connection between the stable category of *graded* Cohen–Macaulay modules over a *graded* Gorenstein \mathbb{k} -algebra A and the derived category of coherent sheaves on $\text{Proj}(A)$ [62]. This brought a new light on the study of D-branes in Landau–Ginzburg models and provided a new powerful tool for the homological mirror symmetry of Kontsevich [59], see for example [70]. As was proven by Keller, Murfet and Van den Bergh [55], the stable categories of graded and non-graded maximal Cohen–Macaulay modules over a graded Gorenstein singularity are related by a triangulated orbit category construction.

In this article, we deal with the representation–theoretic study of maximal Cohen–Macaulay modules over *surface* singularities. Of course, there are close interactions of this traditional area with all four new directions, mentioned above. Moreover, for surface singularities, the theory of maximal Cohen–Macaulay modules is particularly rich and interesting. In a certain sense (which can be rigorously formulated) it is parallel to the theory of vector bundles on projective curves. Following this analogy, the *normal* surface singularities correspond to *smooth* projective curves.

One of the most beautiful applications of the study of maximal Cohen–Macaulay modules over surface singularities is a conceptual explanation of the *McKay correspondence* for the finite subgroups of $\text{SL}_2(\mathbb{C})$, see [44, 2, 4, 78, 19, 60]. One of the conclusions of this theory states that for the *simple* hypersurface singularities $x^2 + y^{n+1} + z^2$, $n \geq 1$ (type A_n), $x^2y + y^{n-1} + z^2$, $n \geq 4$ (type D_n), $x^3 + y^4 + z^2$, $x^3 + xy^3 + z^2$ and $x^3 + y^5 + z^2$ (types E_6 , E_7 and E_8) there are only finitely many indecomposable matrix factorizations.

According to Buchweitz, Greuel and Schreyer [15], two limiting *non-isolated* hypersurface singularities A_∞ (respectively D_∞) given by the equation $x^2 + z^2$ (respectively $x^2y + z^2$), have only countably many indecomposable maximal Cohen–Macaulay modules. In other words, A_∞ and D_∞ have *discrete* Cohen–Macaulay representation type. Moreover, in [15] it was shown that the simple hypersurface singularities are exactly the hypersurface singularities of finite Cohen–Macaulay representation type. Moreover, if the base field has uncountably many elements, then A_∞ and D_∞ are the only hypersurface singularities with countably many indecomposable maximal Cohen–Macaulay modules.

Going in another direction, in works of Kahn [53], Dieterich [26], Drozd, Greuel and Kashuba [35] it was shown that the *minimally elliptic* hypersurface singularities

$$T_{p,q,r}(\lambda) = x^p + y^q + z^r + \lambda xyz,$$

where $\frac{1}{p} + \frac{1}{q} + \frac{1}{r} \leq 1$ and $\lambda \in \mathbb{C} \setminus \Delta_{(p,q,r)}$ have *tame* Cohen–Macaulay representation type ($\Delta_{(p,q,r)}$ is a certain finite set). In the case $\frac{1}{p} + \frac{1}{q} + \frac{1}{r} = 1$ the singularity $T_{p,q,r}(\lambda)$ is quasi-homogeneous and called *simply elliptic*. For $\frac{1}{p} + \frac{1}{q} + \frac{1}{r} < 1$ it is a *cuspidal singularity*, in this case one may without loss of generality assume $\lambda = 1$. A special interest to the study of maximal Cohen–Macaulay modules over this class of surface singularities is in particular motivated by recent development in the homological mirror symmetry: according to Seidel [68] and Efimov [37], the stable category (of certain equivariant) matrix factorizations of the potential $x^{2g+1} + y^{2g+1} + z^{2g+1} - xyz$ is equivalent to the Fukaya category of a compact Riemann surface of genus $g \geq 2$.

In the approach of Kahn [53], a description of maximal Cohen–Macaulay modules over simply elliptic singularities reduces to the study of vector bundles on elliptic curves, whereas in the case of the cuspidal singularities [35] it boils down to a classification of vector bundles on the Kodaira cycles of projective lines. In both cases the complete classification of indecomposable vector bundles is known: see [3] for the case of elliptic curves and [34, 8] for the case of Kodaira cycles. The method of Dieterich [26] is based on the technique of representation theory of finite dimensional algebras and can be applied only to certain simply elliptic singularities. Unfortunately, neither of these approaches leads to a fairly explicit description of indecomposable matrix factorizations. See, however, recent work of Galinat [42] about the $T_{3,3,3}(\lambda)$ case.

Our article grew up from an attempt to answer the following questions:

- Let A be a non-isolated Cohen–Macaulay surface singularity of discrete Cohen–Macaulay representation type over an uncountable algebraically closed field of characteristic zero. Is it true that $A \cong B^G$, where B is a singularity of type A_∞ or D_∞ and G is a finite group of automorphisms of B ? This question was posed in 1987 by Schreyer [67].
- Can a non-isolated Cohen–Macaulay surface singularity have tame Cohen–Macaulay representation type?

Now we present the main results obtained in this article.

Result A. Let (A, \mathfrak{m}) be a reduced complete Cohen–Macaulay surface singularity, which is not normal (hence non-isolated). We introduce new categories $\text{Tri}(A)$ (*category of triples*) and $\text{Rep}(\mathfrak{X}_A)$ (*category of elements* of a certain *bimodule* \mathfrak{X}_A) and a pair of functors

$$(1.2) \quad \text{CM}(A) \xrightarrow{\mathbb{F}} \text{Tri}(A) \xrightarrow{\mathbb{H}} \text{Rep}(\mathfrak{X}_A),$$

such that \mathbb{F} is an equivalence of categories and \mathbb{H} preserves indecomposability and isomorphism classes of objects, see Theorem 3.5 and Proposition 10.9. In other words, this construction reduces a description of indecomposable maximal Cohen–Macaulay A -modules to a certain problem of linear algebra (matrix problem).

Result B. The above categorical construction leads to a new class of tame matrix problems which we call *representations of a decorated bunch of chains*, see Definition 6.9. It generalizes the usual representations of a bunch of chains [10], which are widely used in the representation theory of finite dimensional algebras and its applications.

This new class of problems is actually interesting by itself. For example, it contains the following generalization of the classical problem to find Jordan normal form of a square matrix. Let $(\mathbb{D}, \mathfrak{n})$ be a discrete valuation ring and $X \in \text{Mat}_{n \times n}(\mathbb{D})$ for some $n \geq 1$. What is the canonical form of X under the transformation rule

$$(1.3) \quad X \mapsto S_1 X S_2^{-1},$$

where $S_1, S_2 \in \text{GL}_n(\mathbb{D})$ are such that $S_1 \equiv S_2 \pmod{\mathfrak{n}}$ (decorated conjugation problem)? It turns out that X can be transformed into a direct sum of canonical forms from Definition 14.2, see Theorem 14.3.

Another problem of this kind is a generalized Kronecker problem, stated as follows. Let \mathbb{K} be the field of fractions of \mathbb{D} , $X, Y \in \text{Mat}_{m \times n}(\mathbb{K})$ be two matrices of the same size. To what form can we bring the pair (X, Y) under the transformation rule

$$(1.4) \quad (X, Y) \mapsto (S_1 X T^{-1}, S_2 Y T^{-1}),$$

where $T \in \text{GL}_n(\mathbb{K})$ and $S_1, S_2 \in \text{GL}_m(\mathbb{D})$ are such that $S_1 \equiv S_2 \pmod{\mathfrak{n}}$? In this case, the complete list of indecomposable canonical forms is given in Subsection 7.3.

For a general decorated bunch of chains \mathfrak{X} there are two types of indecomposable objects in $\text{Rep}(\mathfrak{X})$: *strings* (discrete series) and *bands* (continuous series). We prove this result in Theorem 7.1, a separate treatment of the decorated conjugation problem (1.3) is also given in Section 14.

Result C. Using this technique, we give a *negative* answer on Schreyer’s question. For example, let $R = \mathbb{k}[[u, v]]$ and

$$\underbrace{R \times R \times \dots \times R}_{n+1 \text{ times}} \supset A = \left\{ (r_1, r_2, \dots, r_{n+1}) \mid r_i(0, z) = r_{i+1}(z, 0) \text{ for } 1 \leq i \leq n \right\}.$$

Note that for $n = 1$, the ring A is just a hypersurface singularity of type A_∞ . However, for $n > 1$ it is not isomorphic to A_∞^G or D_∞^G , where G is a finite group.

We prove that A has only countably many indecomposable maximal Cohen–Macaulay modules, see Theorem 11.6. Moreover, for an indecomposable maximal Cohen–Macaulay module M we have the following equality for its multi-rank:

$$\underline{\text{rk}}(M) = (0, \dots, 0, 1, \dots, 1, 0, \dots, 0).$$

Our approach leads to a wide class of non–isolated Cohen–Macaulay surface singularities of discrete Cohen–Macaulay representation type, see Section 11 for details.

Result D. There is an important class of non–isolated Gorenstein surface singularities called *degenerate cusps*. They were introduced by Shepherd–Barron in [71]. For example, the natural limits of $T_{p,q,r}(\lambda)$ –singularities, like the ordinary triple point $T_{\infty\infty\infty} = \mathbb{k}[[x, y, z]]/(xyz)$, are degenerate cusps. We prove that for a degenerate cusp A , the corresponding bimodule \mathfrak{X}_A is a decorated bunch of chains. For example, the classification of maximal Cohen–Macaulay modules over $\mathbb{k}[[x, y, z]]/(xyz)$ reduces to the matrix problem, whose objects are representations of the \tilde{A}_5 –quiver

$$(1.5) \quad \begin{array}{ccccc} & \bullet & \longrightarrow & \circ & \\ & \swarrow & & \searrow & \\ \circ & & & & \bullet \\ & \nwarrow & & \nearrow & \\ & \bullet & \longrightarrow & \circ & \end{array}$$

over the field of Laurent power series $\mathbb{k}((t))$. The transformation rules at the sources \bullet are as for quiver representations, whereas for the targets \circ they are like row transformations in the decorated Kronecker problem (1.4), see (8.1) for the precise definition.

Hence, the degenerate cusps have *tame* Cohen–Macaulay representation type, see Theorem 10.10. This fact is quite surprising for us from the following reason. The category of Cohen–Macaulay modules over a simply elliptic singularity $T_{p,q,r}(\lambda)$ is tame of polynomial growth. The cusp singularities $T_{p,q,r}$ are tame of exponential growth. In the approach of Kahn, one reduces first the classification problem to a description of vector bundles on Kodaira cycles on projective lines. The latter problem can be reduced to representations of a usual bunch of chains [34, 8]. This class of tame matrix problems was believed to be the most general among those with exponential growth. The singularity $T_{\infty\infty\infty}$ is the natural limit of the entire family of all $T_{p,q,r}(\lambda)$ singularities. The tameness of the underlying classification problem would suggest that it has to be of the type which goes beyond representations of bunches of chains. But no problems of such type have been known before in the representation theory of finite dimensional algebras!

Using the periodicity of Knörrer [58], the tameness of degenerate cusps implies that the non-reduced curve singularities $\mathbb{k}[[x, y]]/(x^2y^2)$ and $\mathbb{k}[[x, y]]/(x^2y^2 - x^p)$, $p \geq 3$ are Cohen–Macaulay tame as well (at least if $\text{char}(\mathbb{k}) = 0$), see Theorem 12.1.

The categorical construction (1.2) turns out to be convenient in the following situation. Having a non-isolated Cohen–Macaulay surface singularity A , it is natural to restrict oneself to the category $\underline{\text{CM}}^{\text{lf}}(A)$ of those maximal Cohen–Macaulay modules which are *locally free on the punctured spectrum* of A . It is natural to study this category because

- The stable category $\underline{\text{CM}}^{\text{lf}}(A)$ is Hom-finite, whereas the ambient category $\underline{\text{CM}}(A)$ is not.
- If A is Gorenstein then $\underline{\text{CM}}^{\text{lf}}(A)$ is a triangulated subcategory of $\underline{\text{CM}}(A)$. Moreover, according to Auslander [5], the shift functor $\Sigma = \Omega^{-1}$ is a Serre functor in $\underline{\text{CM}}^{\text{lf}}(A)$ (in other words, $\underline{\text{CM}}^{\text{lf}}(A)$ is a 1-Calabi–Yau category).
- In the terms of the Buchweitz’s equivalence (1.1), $\underline{\text{CM}}^{\text{lf}}(A)$ can be identified with the thick subcategory of $D_{\text{sg}}(A)$ generated by the class of the residue field $\mathbb{k} = A/\mathfrak{m}$, see [55] or [63] for a proof.

It turns out that for a degenerate cusp A , the essential image of $\underline{\text{CM}}^{\text{lf}}(A)$ under the composition $\mathbb{H} \circ \mathbb{F}$ is the additive closure of the category of band objects of $\text{Rep}(\mathfrak{X}_A)$, see Theorem 10.10.

Result E. We illustrate our method on several examples.

- For the singularity $A = T_{23\infty} = \mathbb{k}[[x, y, z]]/(x^3 + y^2 - xyz)$, we give an explicit description of all indecomposable maximal Cohen–Macaulay modules. In fact, our method reduces their description to the decorated Kronecker problem. Moreover, we compute generators of all maximal Cohen–Macaulay modules of rank one (written as ideals in A) and describe several families of matrix factorizations corresponding to them. See Section 5 for details.
- For the singularity $A = T_{\infty\infty\infty} = \mathbb{k}[[x, y, z]]/(xyz)$, we give an explicit description of all indecomposable objects of $\underline{\text{CM}}^{\text{lf}}(A)$. For the rank one objects of $\underline{\text{CM}}^{\text{lf}}(A)$, we compute the corresponding matrix factorizations of the polynomial xyz , see Subsection 8.1 and especially Theorem 8.2 and Proposition 8.6.

According to Sheridan [70, Theorem 1.2] and Abouzaid et al. [1, Section 7.3], the triangulated category $\underline{\text{CM}}^{\text{lf}}(A)$ admits a symplectic mirror description. We

hope that our results will bring a new light in the study of Fukaya categories of Riemann surfaces.

- Our method equally allows to treat those degenerate cusps, which are *not* hyper-surface singularities. We consider the following two cases:
 - $A = T_{\infty\infty\infty\infty} = \mathbb{k}\llbracket x, y, u, v \rrbracket / (xy, uv)$. This surface singularity is a complete intersection. We describe all rank one objects of $\mathrm{CM}^{\mathrm{lf}}(A)$. For some of them, we compute the corresponding presentation matrices, see Subsection 8.2.
 - $A = \mathbb{k}\llbracket x, y, z, u, v \rrbracket / (xz, xu, yu, yv, zv)$. It is a Gorenstein surface singularity, which is not a complete intersection. We explicitly describe all rank one objects of $\mathrm{CM}^{\mathrm{lf}}(A)$, see Subsection 8.3.
- Finally, we treat the integral Cohen–Macaulay surface singularity

$$A = \mathbb{k}\llbracket u, v, w, a, b \rrbracket / (uv - w^2, ab - w^3, aw - bu, bw - av, a^2 - uw^2, b^2 - vw^2),$$

which is representation tame and not Gorenstein, see Subsection 12.2. We describe all maximal Cohen–Macaulay modules of rank one, see Proposition 12.3, and compute some one-parameter families of indecomposable objects of $\mathrm{CM}^{\mathrm{lf}}(A)$ of rank two, see Remark 12.4.

Acknowledgement. Parts of this work were done during the authors stay at Max Planck Institute für Mathematik in Bonn and at the Mathematical Research Institute in Oberwolfach within the “Research in Pairs” programme from March 18 – March 30, 2012 and July 21 – August 2, 2013. The research of the first-named author was supported by the DFG projects Bu–1866/1–1 and Bu–1866/2–1. The research of the second-named author was supported by the INTAS grant 06–1000017–9093. The first-named author would like to thank Duco van Straten for helpful discussions and Wassilij Gnedin for pointing out numerous misprints in the previous version of this paper. Our special thanks go to Lesya Bodnarchuk for supplying us with TikZ pictures illustrating representation theory of decorated bunches of chains.

2. GENERALITIES ON MAXIMAL COHEN–MACAULAY MODULES

Let (A, \mathfrak{m}) be a Noetherian local ring, $\mathbb{k} = A/\mathfrak{m}$ its residue field and $d = \mathrm{kr. dim}(A)$ its Krull dimension. Throughout the paper $A\text{-mod}$ denotes the category of Noetherian (i.e. finitely generated) A -modules, whereas $A\text{-Mod}$ stands for the category of all A -modules, $Q = Q(A)$ is the total ring of fractions of A and \mathcal{P} is the set of prime ideals of height 1.

Definition 2.1. A Noetherian A -module M is called *maximal Cohen–Macaulay* if

$$\mathrm{Ext}_A^i(\mathbb{k}, M) = 0 \quad \text{for all } 0 \leq i < d.$$

2.1. Maximal Cohen–Macaulay modules over surface singularities. In this article we focus on the study of maximal Cohen–Macaulay modules over Noetherian rings of Krull dimension two, also called surface singularities. This case is actually rather special because of the following well-known lemma.

Lemma 2.2. *Let (A, \mathfrak{m}) be a surface singularity, N be a maximal Cohen–Macaulay A -module and M a Noetherian A -module. Then the A -module $\mathrm{Hom}_A(M, N)$ is maximal Cohen–Macaulay.*

Proof. From a free presentation $A^n \xrightarrow{\varphi} A^m \rightarrow M \rightarrow 0$ of M we obtain an exact sequence:

$$0 \longrightarrow \mathrm{Hom}_A(M, N) \longrightarrow N^m \xrightarrow{\varphi^*} N^n \longrightarrow \mathrm{coker}(\varphi^*) \longrightarrow 0.$$

Since $\text{depth}_A(N) = 2$, applying the Depth Lemma twice we obtain:

$$\text{depth}_A(\text{Hom}_A(M, N)) \geq 2.$$

Hence, the module $\text{Hom}_A(M, N)$ is maximal Cohen–Macaulay. \square

The following standard result is due to Serre [69], see also [19, Proposition 3.7].

Theorem 2.3. *Let (A, \mathfrak{m}) be a surface singularity. Then we have:*

- (1) *The ring A is normal (i.e. it is a domain, which is integrally closed in its field of fractions) if and only if it is Cohen–Macaulay and isolated.*
- (2) *Assume A to be Cohen–Macaulay and Gorenstein in codimension one (e.g. A is normal) and M be a Noetherian A -module. Then M is maximal Cohen–Macaulay if and only if it is reflexive.*

The next result underlines some features of maximal Cohen–Macaulay modules which occur only in the case of surface singularities. See for example [19, Proposition 3.2 and Proposition 3.7] for the proof.

Theorem 2.4. *Let (A, \mathfrak{m}) be a reduced Cohen–Macaulay surface singularity with a canonical module K . Then we have:*

- (1) *The canonical embedding functor $\text{CM}(A) \rightarrow A\text{-mod}$ has a left adjoint functor $M \mapsto M^\dagger := M^{\vee\vee} = \text{Hom}_A(\text{Hom}_A(M, K), K)$. In other words, for an arbitrary Noetherian module M and a maximal Cohen–Macaulay module N the map δ induces an isomorphism $\text{Hom}_A(M^\dagger, N) \cong \text{Hom}_A(M, N)$. The constructed functor \dagger will be called Macaulayfication functor.*
- (2) *Moreover, for any Noetherian A -module M the following sequence is exact:*

$$0 \rightarrow \text{tor}(M) \rightarrow M \xrightarrow{\delta} M^\dagger \rightarrow T \rightarrow 0,$$

where $\text{tor}(M) = \ker(M \rightarrow Q \otimes_A M)$ is the torsion part of M and T is some A -module of finite length.

- (3) *Moreover, if A is Gorenstein in codimension one, then for any Noetherian A -module M there exists a natural isomorphism $M^\dagger \cong M^{**}$, where $*$ = $\text{Hom}_A(-, A)$.*

The following lemma provides a useful tool to compute the Macaulayfication of a given Noetherian module.

Lemma 2.5. *In the notations of Theorem 2.4, let M be a Noetherian A -module, which is a submodule of a maximal Cohen–Macaulay A -module X . Let $x \in X \setminus M$ be such that $\mathfrak{m}^t x \in M$ for some $t \geq 1$. Then $M^\dagger \cong \langle M, x \rangle^\dagger$, where $\langle M, x \rangle$ is the A -submodule of X generated by M and x .*

Proof. Consider the short exact sequence $0 \rightarrow M \xrightarrow{i} \langle M, x \rangle \rightarrow T \rightarrow 0$. From the assumptions of Lemma it follows that T is a finite length module. In particular, for any $\mathfrak{p} \in \mathcal{P}$ the map $\iota_{\mathfrak{p}}$ is an isomorphism. By the functoriality of Macaulayfication we conclude that the morphism $\iota^\dagger : M^\dagger \rightarrow \langle M, x \rangle^\dagger$ is an isomorphism in codimension one. By [19, Lemma 3.6], the morphism ι^\dagger is an isomorphism. \square

Let us additionally assume our Cohen–Macaulay surface singularity A to be Henselian and $A \subseteq B$ to be a finite ring extension. Then the ring B is semi-local. Moreover, $B \cong (B_1, \mathfrak{n}_1) \times (B_2, \mathfrak{n}_2) \times \cdots \times (B_t, \mathfrak{n}_t)$, where all (B_i, \mathfrak{n}_i) are local. Assume that all rings B_i are Cohen–Macaulay.

Proposition 2.6. *The functor $B \boxtimes_A - : \text{CM}(A) \rightarrow \text{CM}(B)$ mapping a maximal Cohen–Macaulay module M to $B \boxtimes_A M := (B \otimes_A M)^\dagger$ is left adjoint to the forgetful functor $\text{CM}(B) \rightarrow \text{CM}(A)$. In other words, for any maximal Cohen–Macaulay A -module M and a maximal Cohen–Macaulay B -module N we have:*

$$\text{Hom}_B(B \boxtimes_A M, N) \cong \text{Hom}_A(M, N).$$

Assume additionally A and B to be both reduced. Then for any Noetherian B -module M there exist a natural isomorphism $M^{\dagger A} \cong M^{\dagger B}$ in the category of A -modules.

For a proof, see for example [19, Proposition 3.18]. \square

Lemma 2.7. *Let (A, \mathfrak{m}) be a reduced Noetherian ring of Krull dimension one with a canonical module K . Then for any Noetherian A -module M we have a functorial isomorphism: $M^{\vee\vee} \cong M/\text{tor}(M)$, where $\vee = \text{Hom}_A(-, K)$.*

Proof. From the canonical short exact sequence $0 \rightarrow \text{tor}(M) \rightarrow M \rightarrow M/\text{tor}(M) \rightarrow 0$ we get the isomorphism $(M/\text{tor}(M))^\vee \rightarrow M^\vee$. Since $M/\text{tor}(M)$ is a maximal Cohen–Macaulay A -module and \vee is a dualizing functor, we get two natural isomorphisms

$$M/\text{tor}(M) \xrightarrow{\cong} (M/\text{tor}(M))^{\vee\vee} \xleftarrow{\cong} M^{\vee\vee},$$

being a part of the commutative diagram

$$\begin{array}{ccc} M & \longrightarrow & M/\text{tor}(M) \\ \downarrow & & \downarrow \\ M^{\vee\vee} & \longrightarrow & (M/\text{tor}(M))^{\vee\vee}, \end{array}$$

in which all morphisms are the canonical ones. This yields the claim. \square

Corollary 2.8. *Let (A, \mathfrak{m}) be a reduced Cohen–Macaulay surface singularity with a canonical module K and $A \subseteq R$ be its normalization. Then for any Noetherian A -module M and any $\mathfrak{p} \in \mathcal{P}$ we have a natural isomorphism*

$$(R \boxtimes_A M)_{\mathfrak{p}} \cong R_{\mathfrak{p}} \otimes_{A_{\mathfrak{p}}} M_{\mathfrak{p}}/\text{tor}(R_{\mathfrak{p}} \otimes_{A_{\mathfrak{p}}} M_{\mathfrak{p}}).$$

Proof. Note that $A_{\mathfrak{p}}$ is a reduced Cohen–Macaulay ring of Krull dimension one, $K_{\mathfrak{p}}$ is the canonical module of $A_{\mathfrak{p}}$ and $R_{\mathfrak{p}}$ is the normalization of $A_{\mathfrak{p}}$. Hence, this corollary is a consequence of Lemma 2.7. \square

2.2. On the category $\text{CM}^{\text{lf}}(A)$. Let (A, \mathfrak{m}) be a Cohen–Macaulay ring of an arbitrary Krull dimension d .

Definition 2.9. A maximal Cohen–Macaulay A -module M is locally free on the punctured spectrum of A if for any $\mathfrak{p} \in \text{Spec}(A) \setminus \{\mathfrak{m}\}$ the localization $M_{\mathfrak{p}}$ is a free $A_{\mathfrak{p}}$ -module.

Of course, any maximal Cohen–Macaulay module fulfills the above property provided A is an *isolated singularity*. However, for the non-isolated ones we get a very nice proper subcategory of $\text{CM}(A)$.

Theorem 2.10. *Let $\text{CM}^{\text{lf}}(A)$ be the category of maximal Cohen–Macaulay modules which are locally free on the punctured spectrum. Then the following results are true.*

- *The stable category $\underline{\text{CM}}^{\text{lf}}(A)$ is Hom-finite. This means that for any objects M and N of $\underline{\text{CM}}^{\text{lf}}(A)$ the A -module $\underline{\text{Hom}}_A(M, N)$ has finite length.*
- *Moreover, assume that A is Gorenstein. Then we have:*

- $\underline{\mathbf{CM}}^{\text{lf}}(A)$ is a triangulated subcategory of $\underline{\mathbf{CM}}(A)$.
- The shift functor $\Sigma = \Omega^{-1}$ is a Serre functor in $\underline{\mathbf{CM}}^{\text{lf}}(A)$. This means that for any objects M and N of $\underline{\mathbf{CM}}^{\text{lf}}(A)$ we have a bifunctorial isomorphism

$$\underline{\mathbf{Hom}}_A(M, N) \cong \mathbb{D}\left(\underline{\mathbf{Hom}}_A(N, \Sigma(M))\right),$$

where \mathbb{D} is the Matlis duality functor.

- In the terms of Buchweitz's equivalence (1.1), we have an exact equivalence:

$$\underline{\mathbf{CM}}^{\text{lf}}(A) \longrightarrow \mathbf{thick}(\mathbb{k}) \subset D_{\text{sg}}(A),$$

where $\mathbf{thick}(\mathbb{k})$ is the smallest triangulated subcategory of $D_{\text{sg}}(A)$ containing the class of the residue field \mathbb{k} and closed under direct summands in $D_{\text{sg}}(A)$.

Comment on the proof. For the proof of the first statement, see for example [19, Proposition 9.4]. The second result easily follows from the definition of the triangulated category structure of $\underline{\mathbf{CM}}(A)$. The third statement dates back to Auslander [5, Proposition 8.8 in Chapter 1 and Proposition 1.3 in Chapter 3], see also [78, Chapter 3]. Finally, the proof of the last result is essentially contained in the proof of [55, Proposition A.2] as well as in [63, Lemma 2.6 and Proposition 2.7]. \square

Remark 2.11. Observe that if $d \geq 2$ and M is an objects of $\underline{\mathbf{CM}}^{\text{lf}}(A)$ then there exists $n \geq 1$ such that $M_{\mathfrak{p}} \cong A_{\mathfrak{p}}^n$ for any $\mathfrak{p} \in \text{Spec}(A) \setminus \{\mathfrak{m}\}$. However, this is not true if $d = 1$ and $\text{Spec}(A)$ has several irreducible components.

Let $d \geq 2$, (S, \mathfrak{n}) be a regular ring of Krull dimension $d + 1$ and $f \in \mathfrak{n}^2$ be such that the hypersurface singularity $(A, \mathfrak{m}) = S/(f)$ is reduced. Let $(\varphi, \psi) \in \text{Mat}_{n \times n}(S)^{\times 2}$ be a matrix factorization of f and $\bar{\varphi}, \bar{\psi}$ be the corresponding images in $\text{Mat}_{n \times n}(A)$. Let $M = \text{cok}(\bar{\varphi})$ be the maximal Cohen–Macaulay A -module corresponding to (φ, ψ) . Next, for any $1 \leq p \leq n$, let $I_p(\bar{\varphi})$ be the p -th Fitting ideal of M , i.e. the ideal generated by all $p \times p$ minors of $\bar{\varphi}$.

Lemma 2.12. *Let $(\varphi, \psi) \in \text{Mat}_{n \times n}(S)^{\times 2}$ be a matrix factorization of f and $M = \text{cok}(\bar{\varphi})$. Then M belongs to $\underline{\mathbf{CM}}^{\text{lf}}(A)$ if and only if the following is true.*

- There exists $t \geq 1$ and a unit $u \in S$ such that $\det(\varphi) = u \cdot f^t$.
- $\sqrt{I_{n-t}(\bar{\varphi})} = \mathfrak{m}$ and $I_{n-t+1}(\bar{\varphi}) = 0$.

Proof. Recall that Q denotes the total ring of fractions of A . If M belongs to $\underline{\mathbf{CM}}^{\text{lf}}(A)$ then there exists $t \geq 1$ such that $Q \otimes_A M = Q^t$. By [19, Lemma 2.34], we get the first condition. The second condition follows from [13, Lemma 1.4.8]. \square

3. MAIN CONSTRUCTION

Let (A, \mathfrak{m}) be a reduced complete (or analytic) Cohen–Macaulay ring of Krull dimension two, which is not an isolated singularity. Let R be the normalization of A . It is well-known that R is again complete (resp. analytic) and the ring extension $A \subseteq R$ is finite, see [47] or [25]. Moreover, R is isomorphic to the product of a finite number of normal local rings:

$$R \cong (R_1, \mathfrak{n}_1) \times (R_1, \mathfrak{n}_1) \times \cdots \times (R_t, \mathfrak{n}_t).$$

According to Theorem 2.3, all rings R_i are automatically Cohen–Macaulay.

Let $I = \text{ann}(R/A)$ be the *conductor ideal*. It is easy to see that I is also an ideal in R . Denote $\bar{A} = A/I$ and $\bar{R} = R/I$.

Lemma 3.1. *In the notations as above we have.*

- (1) *The ideal I is a maximal Cohen–Macaulay module, both over A and over R .*
- (2) *The rings \bar{A} and \bar{R} are Cohen–Macaulay of Krull dimension one.*
- (3) *The inclusion $\bar{A} \rightarrow \bar{R}$ induces the injective homomorphism of rings of fractions $Q(\bar{A}) \rightarrow Q(\bar{R})$. Moreover, the canonical morphism $\bar{R} \otimes_{\bar{A}} Q(\bar{A}) \rightarrow Q(\bar{R})$ is an isomorphism.*

Proof. First note that $I \cong \text{Hom}_A(R, A)$. Hence, by Lemma 2.2, the ideal I is maximal Cohen–Macaulay, viewed as A -module. Since the ring extension $A \subseteq R$ is finite, I is also maximal Cohen–Macaulay as a module over R .

Next, the closed subscheme $V(I) \subset \text{Spec}(A)$ is exactly the non-normal locus of A . If A is normal then $A = R$ and there is nothing to prove. If A is not normal, then $\text{kr. dim}(V(I)) \geq 1$. Indeed, by Theorem 2.3, an isolated surface singularity which is not normal, can not be Cohen–Macaulay. Since A is reduced, we have: $\text{kr. dim}(V(I)) = 1$. In particular, $\text{kr. dim}(\bar{A}) = 1 = \text{kr. dim}(\bar{R})$. Applying Depth Lemma to the short exact sequences

$$0 \longrightarrow I \longrightarrow A \longrightarrow \bar{A} \longrightarrow 0 \quad \text{and} \quad 0 \longrightarrow I \longrightarrow R \longrightarrow \bar{R} \longrightarrow 0$$

we conclude that \bar{A} and \bar{R} are both Cohen–Macaulay (but not necessarily reduced).

Let $\bar{a} \in \bar{A}$ be a regular element. Since \bar{R} is a Cohen–Macaulay \bar{A} -module, \bar{a} is regular in \bar{R} , too. Hence, we obtain a well-defined injective morphism of rings $Q(\bar{A}) \rightarrow Q(\bar{R})$.

Finally, consider the canonical ring homomorphism $\gamma : \bar{R} \otimes_{\bar{A}} Q(\bar{A}) \rightarrow Q(\bar{R})$, mapping a simple tensor $\bar{r} \otimes \frac{\bar{a}}{\bar{b}}$ to $\frac{\bar{r}\bar{a}}{\bar{b}}$. Since any element of $\bar{R} \otimes_{\bar{A}} Q(\bar{A})$ has the form $\bar{r} \otimes \frac{\bar{1}}{\bar{b}}$ for some $\bar{r} \in \bar{R}$ and $\bar{b} \in \bar{A}$, it is easy to see γ is injective. Next, consider the canonical ring homomorphism $\bar{R} \rightarrow \bar{R} \otimes_{\bar{A}} Q(\bar{A})$. It is easy to see that $\bar{r} \otimes \bar{1}$ is a non-zero divisor in $\bar{R} \otimes_{\bar{A}} Q(\bar{A})$ provided $\bar{r} \in \bar{R}$ is regular. Since $\bar{R} \otimes_{\bar{A}} Q(\bar{A})$ is a finite ring extension of $Q(\bar{A})$, it is artinian. In particular, any regular element in this ring is invertible. From the universal property of localization we obtain a ring homomorphism $Q(\bar{R}) \rightarrow \bar{R} \otimes_{\bar{A}} Q(\bar{A})$, which is inverse to γ . \square

Lemma 3.2. *Let M be a maximal Cohen–Macaulay A -module. Then we have:*

- *The canonical morphism of $Q(\bar{R})$ -modules*

$$\theta_M : Q(\bar{R}) \otimes_{Q(\bar{A})} (Q(\bar{A}) \otimes_A M) \xrightarrow{\cong} Q(\bar{R}) \otimes_R (R \otimes_A M) \longrightarrow Q(\bar{R}) \otimes_R (R \boxtimes_A M)$$

is an epimorphism.

- *The canonical morphism of $Q(\bar{A})$ -modules*

$$\tilde{\theta}_M : Q(\bar{A}) \otimes_A M \rightarrow Q(\bar{R}) \otimes_A M \xrightarrow{\theta_M} Q(\bar{R}) \otimes_R (R \boxtimes_A M)$$

is a monomorphism.

Proof. By Theorem 2.4, the cokernel of the canonical morphism $R \otimes_A M \rightarrow R \boxtimes_A M$ has finite length. Hence, it vanishes after tensoring with $Q(\bar{R})$. Thus, the map θ_M is surjective. The first statement of lemma is proven.

Denote by $\widetilde{M}' := R \otimes_A M / \text{tor}_R(R \otimes_A M)$ and $\widetilde{M} := \widetilde{M}'^\dagger$. First note that the canonical morphism of A -modules $M \xrightarrow{\kappa} \widetilde{M}'$, $m \mapsto [1 \otimes m]$ is a monomorphism. As a result, the morphism $IM \xrightarrow{\bar{\kappa}} I\widetilde{M}'$, which is a restriction of κ , is also injective. Moreover, $\bar{\kappa}$ is also surjective: for any $a \in I, b \in R$ and $m \in M$ we have: $a \cdot [b \otimes m] = [ab \otimes m] = [1 \otimes (ab) \cdot m]$ and $ab \in I$.

Since the module \widetilde{M}' is torsion free, by Theorem 2.4 we have a short exact sequence

$$0 \longrightarrow \widetilde{M}' \xrightarrow{\xi} \widetilde{M} \longrightarrow T \longrightarrow 0,$$

where T is a module of finite length. It implies that the cokernel of the induced map $I\widetilde{M}' \xrightarrow{\bar{\xi}} I\widetilde{M}$ has finite length as well. Let $M \xrightarrow{j} \widetilde{M}$ be the composition of κ and ξ and $IM \xrightarrow{\bar{j}} I\widetilde{M}$ be the induced map. Then we have the following commutative diagram with exact rows:

$$(3.1) \quad \begin{array}{ccccccc} 0 & \longrightarrow & IM & \longrightarrow & M & \longrightarrow & \bar{A} \otimes_A M \longrightarrow 0 \\ & & \bar{j} \downarrow & & j \downarrow & & \downarrow \eta \\ 0 & \longrightarrow & I\widetilde{M} & \longrightarrow & \widetilde{M} & \longrightarrow & \bar{R} \otimes_R \widetilde{M} \longrightarrow 0. \end{array}$$

Since j is injective and the cokernel \bar{j} is of finite length, snake lemma implies that $\ker(\eta)$ has finite length. Since $Q(\bar{A}) \otimes_{\bar{A}} -$ is an exact functor, we obtain an exact sequence

$$0 \longrightarrow Q(\bar{A}) \otimes_{\bar{A}} \ker(\eta) \longrightarrow Q(\bar{A}) \otimes_{\bar{A}} \bar{A} \otimes_A M \xrightarrow{1 \otimes \eta} Q(\bar{A}) \otimes_{\bar{A}} \bar{R} \otimes_R \widetilde{M}.$$

It remains to take into account that $Q(\bar{A}) \otimes_{\bar{A}} \ker(\eta) = 0$, $Q(\bar{A}) \otimes_{\bar{A}} \bar{R} = Q(\bar{R})$ and $1 \otimes \eta$ coincides with the morphism $\widetilde{\theta}_M$. \square

Definition 3.3. In the notations of this section, consider the following *category of triples* $\text{Tri}(A)$. Its objects are triples $(\widetilde{M}, V, \theta)$, where \widetilde{M} is a maximal Cohen–Macaulay R -module, V is a Noetherian $Q(\bar{A})$ -module and $\theta : Q(\bar{R}) \otimes_{Q(\bar{A})} V \rightarrow Q(\bar{R}) \otimes_R \widetilde{M}$ is an epimorphism of $Q(\bar{R})$ -modules such that the induced morphism of $Q(\bar{A})$ -modules

$$V \longrightarrow Q(\bar{R}) \otimes_{Q(\bar{A})} V \xrightarrow{\theta} Q(\bar{R}) \otimes_R \widetilde{M}$$

is a monomorphism. In what follows, θ will be frequently called *gluing map*.

A morphism between two triples $(\widetilde{M}, V, \theta)$ and $(\widetilde{M}', V', \theta')$ is given by a pair (φ, ψ) , where $\varphi : \widetilde{M} \rightarrow \widetilde{M}'$ is a morphism of R -modules and $\psi : V \rightarrow V'$ is a morphism of $Q(\bar{A})$ -modules such that the following diagram

$$\begin{array}{ccc} Q(\bar{R}) \otimes_{Q(\bar{A})} V & \xrightarrow{\theta} & Q(\bar{R}) \otimes_R \widetilde{M} \\ \downarrow 1 \otimes \varphi & & \downarrow 1 \otimes \psi \\ Q(\bar{R}) \otimes_{Q(\bar{A})} V' & \xrightarrow{\theta'} & Q(\bar{R}) \otimes_R \widetilde{M}' \end{array}$$

is commutative in the category of $Q(\bar{R})$ -modules.

Remark 3.4. Consider the pair of functors

$$(3.2) \quad \text{CM}(R) \xrightarrow{\bar{R} \otimes_R -} Q(\bar{R})\text{-mod} \xleftarrow{Q(\bar{R}) \otimes_{Q(\bar{A})} -} Q(\bar{A})\text{-mod}.$$

Then the category $\text{Tri}(A)$ is a full subcategory of the comma-category defined by (3.2).

The raison d'être for Definition 3.3 is the following theorem.

Theorem 3.5. *In the notations of this section, the functor*

$$\mathbb{F} : \text{CM}(A) \longrightarrow \text{Tri}(A), \quad M \mapsto \mathbb{F}(M) := (R \boxtimes_A M, Q(\bar{A}) \otimes_A M, \theta_M),$$

is an equivalence of categories.

Lemma 3.2 assures that the functor \mathbb{F} is well-defined. The proof of this theorem as well as the construction of a quasi-inverse functor \mathbb{G} will be given in the next section.

Now we shall investigate the compatibility of the functor \mathbb{F} with localizations with respect to the prime ideals of height 1.

Proposition 3.6. *Let $a(I) := \text{ass}(I) = \{\mathfrak{p}_1, \mathfrak{p}_2, \dots, \mathfrak{p}_t\}$ be the associator of the conductor ideal $I \subseteq A$. Then we have:*

- (1) *for all $1 \leq i \leq t$ the ideal \mathfrak{p}_i has height one;*
- (2) *Let $\mathfrak{p} \in \mathcal{P}$. Then $(R/A)_{\mathfrak{p}} = 0$ for all $\mathfrak{p} \notin a(I)$;*
- (3) *Let $\bar{\mathfrak{p}}_i$ be the image of \mathfrak{p}_i in the ring \bar{A} for $1 \leq i \leq t$. Then*

$$Q(\bar{A}) \cong \bar{A}_{\bar{\mathfrak{p}}_1} \times \cdots \times \bar{A}_{\bar{\mathfrak{p}}_t} \text{ and } Q(\bar{R}) \cong \bar{R}_{\bar{\mathfrak{p}}_1} \times \cdots \times \bar{R}_{\bar{\mathfrak{p}}_t}.$$

- (4) *Moreover, for any $\mathfrak{p} \in a(I)$ the ring $R_{\mathfrak{p}}$ is the normalization of $A_{\mathfrak{p}}$, $I_{\mathfrak{p}}$ is the conductor ideal of $A_{\mathfrak{p}}$, $Q(\bar{A})_{\mathfrak{p}} = \bar{A}_{\bar{\mathfrak{p}}}$ and $Q(\bar{R})_{\mathfrak{p}} = \bar{R}_{\bar{\mathfrak{p}}}$.*

Proof. According to Lemma 3.1, the ring \bar{A} is a Cohen–Macaulay curve singularity. Hence, it is equidimensional, what proves the first statement.

It is well-known that $a(I)$ coincides with the set of minimal elements of $\text{Supp}(\bar{A})$, see [69]. Hence, for any $\mathfrak{p} \in \mathcal{P}$ we have: $\bar{A}_{\mathfrak{p}} \neq 0$ if and only if $\mathfrak{p} \in a(I)$. Since the ring extension $\bar{A} \subseteq \bar{R}$ is finite, $\bar{R}_{\mathfrak{p}} \neq 0$ if and only if $\mathfrak{p} \in a(I)$. This proves the second statement.

Next, \bar{A} is a one-dimensional Cohen–Macaulay ring and the set of its minimal prime ideals is $a(0) = \{\bar{\mathfrak{p}}_1, \dots, \bar{\mathfrak{p}}_t\}$. Hence, we have: $\bar{A}_{\bar{\mathfrak{p}}_i} = Q(\bar{A})_{\bar{\mathfrak{p}}_i, Q(\bar{A})}$ for all $1 \leq i \leq t$. Since \bar{A} is Cohen–Macaulay, its total ring of fractions $Q(\bar{A})$ is artinian. Moreover, $\{\bar{\mathfrak{p}}_1 Q(\bar{A}), \dots, \bar{\mathfrak{p}}_t Q(\bar{A})\}$ is the set of maximal ideals of $Q(\bar{A})$. In particular, the morphism

$$Q(\bar{A}) \longrightarrow Q(\bar{A})_{\bar{\mathfrak{p}}_1 Q(\bar{A})} \times Q(\bar{A})_{\bar{\mathfrak{p}}_2 Q(\bar{A})} \times \cdots \times Q(\bar{A})_{\bar{\mathfrak{p}}_t Q(\bar{A})} \longrightarrow \bar{A}_{\bar{\mathfrak{p}}_1} \times \cdots \times \bar{A}_{\bar{\mathfrak{p}}_t}$$

is an isomorphism. Taking into account Lemma 3.1, we obtain an isomorphism

$$\bar{R}_{\bar{\mathfrak{p}}_1} \times \cdots \times \bar{R}_{\bar{\mathfrak{p}}_t} \longrightarrow (\bar{A}_{\bar{\mathfrak{p}}_1} \times \cdots \times \bar{A}_{\bar{\mathfrak{p}}_t}) \otimes_{\bar{A}} \bar{R} \longrightarrow Q(\bar{A}) \otimes_{\bar{A}} \bar{R} \longrightarrow Q(\bar{R}).$$

This concludes a proof of the third statement.

For any prime ideal \mathfrak{p} the ring $R_{\mathfrak{p}}$ is the normalization of $A_{\mathfrak{p}}$. Next, we have: $I_{\mathfrak{p}} = (\text{ann}_A(R/A))_{\mathfrak{p}} \cong \text{ann}_{A_{\mathfrak{p}}}(R_{\mathfrak{p}}/A_{\mathfrak{p}})$, hence $I_{\mathfrak{p}}$ is the conductor ideal of $A_{\mathfrak{p}}$. The ring isomorphisms $Q(\bar{A})_{\mathfrak{p}} \cong \bar{A}_{\bar{\mathfrak{p}}}$ and $Q(\bar{R})_{\mathfrak{p}} \cong \bar{R}_{\bar{\mathfrak{p}}}$ follow from the previous part. \square

Remark 3.7. For a Cohen–Macaulay curve singularity C , there exists the notion of the category of triples $\text{Tri}(C)$ parallel to Definition 3.3, see Section 13.

Proposition 3.8. *For any prime ideal $\mathfrak{p} \in a(I)$ we have the localization functor $\mathbb{L}_{\mathfrak{p}} : \text{Tri}(A) \rightarrow \text{Tri}(A_{\mathfrak{p}})$ mapping a triple $T = (\widetilde{M}, V, \theta)$ to the triple $T_{\mathfrak{p}} = \mathbb{L}_{\mathfrak{p}}(T) = (\widetilde{M}_{\mathfrak{p}}, V_{\mathfrak{p}}, \theta_{\mathfrak{p}})$. Moreover, there is the following diagram of categories and functors*

$$\begin{array}{ccc} \text{CM}(A) & \xrightarrow{A_{\mathfrak{p}} \otimes_A -} & \text{CM}(A_{\mathfrak{p}}) \\ \mathbb{F}^A \downarrow & \swarrow \xi & \downarrow \mathbb{F}^{A_{\mathfrak{p}}} \\ \text{Tri}(A) & \xrightarrow{\mathbb{L}_{\mathfrak{p}}} & \text{Tri}(A_{\mathfrak{p}}) \end{array}$$

where the natural transformation $\xi : \mathbb{F}^{A_{\mathfrak{p}}} \circ (A_{\mathfrak{p}} \otimes_A -) \rightarrow \mathbb{L}_{\mathfrak{p}} \circ \mathbb{F}^A$ is an isomorphism. Moreover, for a triple $T = (\widetilde{M}, V, \theta)$ the gluing morphism θ is an isomorphism if and only if $\theta_{\mathfrak{p}}$ is an isomorphism for all $\mathfrak{p} \in a(I)$.

Proof. Let $T = (\widetilde{M}, V, \theta)$ be an object of $\text{Tri}(A)$. By Proposition 3.6, for any prime ideal \mathfrak{p} the localization $I_{\mathfrak{p}}$ is the conductor ideal of the ring $A_{\mathfrak{p}}$, $Q(\bar{A}) \cong \bar{A}_{\bar{\mathfrak{p}}_1} \times \cdots \times \bar{A}_{\bar{\mathfrak{p}}_t}$ and $Q(\bar{R}) \cong \bar{R}_{\bar{\mathfrak{p}}_1} \times \cdots \times \bar{R}_{\bar{\mathfrak{p}}_t}$. Hence, for any prime ideal $\mathfrak{p} \in a(I)$ we have: $\widetilde{M}_{\mathfrak{p}}$ is a maximal Cohen–Macaulay $R_{\mathfrak{p}}$ -module, $V_{\mathfrak{p}} = V_{\bar{\mathfrak{p}}}$ is a Noetherian $\bar{A}_{\bar{\mathfrak{p}}}$ -module. We have a commutative diagram

$$\begin{array}{ccc} (Q(\bar{R}) \otimes_{Q(\bar{A})} V)_{\bar{\mathfrak{p}}} & \xrightarrow{\theta_{\bar{\mathfrak{p}}}} & (Q(\bar{R}) \otimes_R \widetilde{M})_{\bar{\mathfrak{p}}} \\ \cong \downarrow & & \downarrow \cong \\ \bar{R}_{\bar{\mathfrak{p}}} \otimes_{\bar{A}_{\bar{\mathfrak{p}}}} V_{\bar{\mathfrak{p}}} & \xrightarrow{\theta_{\mathfrak{p}}} & \bar{R}_{\bar{\mathfrak{p}}} \otimes_{R_{\mathfrak{p}}} \widetilde{M}_{\mathfrak{p}} \end{array}$$

where both vertical maps are canonical isomorphisms. In a similar way, we have a commutative diagram

$$\begin{array}{ccc} V_{\bar{\mathfrak{p}}} & \xrightarrow{\tilde{\theta}_{\bar{\mathfrak{p}}}} & (Q(\bar{R}) \otimes_R \widetilde{M})_{\bar{\mathfrak{p}}} \\ \mathbb{1} \downarrow & & \downarrow \cong \\ V_{\mathfrak{p}} & \xrightarrow{\tilde{\theta}_{\mathfrak{p}}} & \bar{R}_{\bar{\mathfrak{p}}} \otimes_{R_{\mathfrak{p}}} \widetilde{M}_{\mathfrak{p}} \end{array}$$

and the morphisms $\tilde{\theta}_{\bar{\mathfrak{p}}}$ and $\theta_{\bar{\mathfrak{p}}}$ are mapped to each other under the adjunction maps.

By Corollary 2.8, for any $\mathfrak{p} \in \mathcal{P}$ and any maximal Cohen–Macaulay A -module M we have an isomorphism $(R \boxtimes_A M)_{\mathfrak{p}}^{\dagger} \rightarrow R_{\mathfrak{p}} \otimes_{A_{\mathfrak{p}}} M_{\mathfrak{p}} / \text{tor}(R_{\mathfrak{p}} \otimes_{A_{\mathfrak{p}}} M_{\mathfrak{p}})$ which is natural in M . Moreover, this map coincides the localization $\theta_{M_{\mathfrak{p}}}$ of θ_M . This shows the claim. \square

Combining Theorem 3.5 and Proposition 3.8, we obtain the following result.

Theorem 3.9. *The functor \mathbb{F} establishes an equivalence between $\text{CM}^{\text{lf}}(A)$ and the full subcategory $\text{Tri}^{\text{lf}}(A)$ of $\text{Tri}(A)$ consisting of those triples $(\widetilde{M}, V, \theta)$ for which the gluing morphism θ is an isomorphism.*

4. SERRE QUOTIENTS AND PROOF OF MAIN THEOREM

The goal of this section is to give a proof of Theorem 3.5. To do that we need the technique of Serre quotient categories, studied by Gabriel in his thesis [41], see also [64].

Definition 4.1. For a Noetherian ring A let $\text{fnlg}(A)$ be the category of finite length modules. Then $\text{fnlg}(A)$ is a thick subcategory, i.e. it is closed under taking kernels, cokernels and extensions inside of $A\text{-mod}$. The Serre quotient category

$$\mathbb{M}(A) = A\text{-mod} / \text{fnlg}(A)$$

is defined as follows.

1. The objects of $\mathbb{M}(A)$ and $A\text{-mod}$ are the same.
2. To define morphisms in $\mathbb{M}(A)$, for any pair of A -modules M and N consider the following partially ordered set of quadruples $I_{M,N} := \{Q = (X, \varphi, Y, \psi)\}$, where X and Y are A -modules, $X \xrightarrow{\varphi} M$ is an injective homomorphism of A -modules whose cokernel belongs to $\text{fnlg}(A)$ and $N \xrightarrow{\psi} Y$ is a surjective homomorphism of A -modules whose kernel belongs to $\text{fnlg}(A)$. For a pair of such quadruples $Q = (X, \varphi, Y, \psi)$ and $Q' = (X', \varphi', Y', \psi')$

we say that $Q \leq Q'$ if and only if there exists morphisms $X' \xrightarrow{\xi} X$ and $Y \xrightarrow{\zeta} Y'$ such that $\varphi' = \varphi\xi$ and $\psi' = \zeta\psi$. Then $I_{M,N}$ is a directed partially ordered set and we define:

$$\mathrm{Hom}_{\mathbf{M}(A)}(M, N) := \varinjlim_{Q \in I_{M,N}} \mathrm{Hom}_A(X, Y).$$

3. Note that for any pair of A -modules M and N we have a canonical homomorphism of abelian groups $p(M, N) : \mathrm{Hom}_A(M, N) \longrightarrow \varinjlim \mathrm{Hom}_A(X, Y) = \mathrm{Hom}_{\mathbf{M}(A)}(M, N)$.

Theorem 4.2. *The category $\mathbf{M}(A)$ is abelian and the canonical functor*

$$\mathbb{P}_A : A\text{-mod} \longrightarrow \mathbf{M}(A)$$

is exact. In particular, if $M \xrightarrow{\psi} N$ is a morphism in $A\text{-mod}$ then $\mathbb{P}_A(\psi)$ is a monomorphism (resp. epimorphism) if and only if the kernel (resp. cokernel) of ψ belongs to $\mathrm{fnlg}(A)$.

Moreover, $\mathbf{M}(A)$ is equivalent to the localized category $\mathbf{M}(A)^\circ = A\text{-mod}[\Sigma^{-1}]$, where the localizing subclass $\Sigma \subset \mathrm{Mor}(A)$ consists of all morphisms in the category $A\text{-mod}$, whose kernels and cokernels have finite length.

Proof. The first part of this theorem was shown by Gabriel, see [41, Chapitre III]. For the second part we refer to [64]. In particular, for any pair of objects M and N and a morphism $M \xrightarrow{\psi} N$ in the category $\mathbf{M}(A)$ there exists an A -module E and a pair of morphisms $M \xleftarrow{\phi} E \xrightarrow{\varphi} N$ such that $\ker(\phi)$ and $\mathrm{coker}(\phi)$ belong to $\mathrm{fnlg}(A)$ and $\psi = \mathbb{P}_A(\varphi) \cdot \mathbb{P}_A(\phi)^{-1}$. \square

It turns out that the category $\mathbf{M}(A)$ is very natural from the point of view of singularity theory. The following theorem summarizes some of its well-known properties.

Theorem 4.3. *Let (A, \mathfrak{m}) be a local Noetherian ring.*

- (1) *If A is Cohen-Macaulay of Krull dimension one then the exact functor $Q(A) \otimes_A - : A\text{-mod} \rightarrow Q(A)\text{-mod}$ induces an equivalence of categories $\mathbf{M}(A) \rightarrow Q(A)\text{-mod}$;*
- (2) *Let $X = \mathrm{Spec}(A)$ and $x = \{\mathfrak{m}\}$ be the unique closed point of X . For $U := X \setminus \{x\}$ let $\iota : U \rightarrow X$ be the canonical embedding and $\mathrm{Coh}_x(X)$ be the category of coherent sheaves on X supported at x . Then the functor ι^* induces an equivalence of categories $\mathrm{Coh}(X)/\mathrm{Coh}_x(X) \rightarrow \mathrm{Coh}(U)$. In particular, the categories $\mathbf{M}(A)$ and $\mathrm{Coh}(U)$ are equivalent.*
- (3) *Let A be of Krull dimension at least two then the canonical functor*

$$\mathbb{I} : \mathrm{CM}(A) \longrightarrow A\text{-mod} \xrightarrow{\mathbb{P}_A} \mathbf{M}(A)$$

is fully faithful. Moreover, if A is a normal surface singularity then the category $\mathrm{Coh}(U)$ is hereditary and $\mathrm{CM}(A)$ is equivalent to the category $\mathrm{VB}(U)$ of locally free coherent sheaves on U .

- (4) *Let A be a reduced Cohen-Macaulay surface singularity then the Macaulayfication functor $\dagger : A\text{-mod} \rightarrow \mathrm{CM}(A)$ induces a functor $\mathbf{M}(A) \rightarrow \mathrm{CM}(A)$ which is left adjoint to the embedding \mathbb{I} . Moreover, for a torsion free A -module M we have a natural isomorphism $M^\dagger \rightarrow \Gamma(\iota_* \iota^* \widetilde{M})$, where \widetilde{M} is the coherent sheaf on X obtained by sheafifying the module M .*

Proof. (1) Let $A\text{-Mod}$ be the category of all A -modules and $\mathrm{Tor}(A)$ be its full subcategory consisting of those modules, for which any element is \mathfrak{m} -torsion. In other words, $\mathrm{Tor}(A)$ is the category of modules, which are direct limits of its finite length submodules.

The total ring of fractions $Q(A)$ is flat as an A -module, hence $\mathbb{F} = Q(A) \otimes_A : A\text{-Mod} \rightarrow Q(A)\text{-Mod}$ is exact. The forgetful functor $\mathbb{G} : Q(A)\text{-Mod} \rightarrow A\text{-Mod}$ is right adjoint to

\mathbb{F} . Now note that the counit of the adjunction $\xi : \mathbb{F}\mathbb{G} \rightarrow \mathbb{1}_{Q(A)\text{-mod}}$ is an isomorphism of functors. Since \mathbb{F} is right exact and \mathbb{G} is exact, the composition $\mathbb{F}\mathbb{G}$ is right exact. Moreover, $\mathbb{F}\mathbb{G}$ commutes with arbitrary direct products. Hence, to prove that ξ is an isomorphism, it is sufficient to show that the canonical morphism of $Q(A)$ -modules

$$\xi_{Q(A)} = \text{mult} : Q(A) \otimes_A Q(A) \longrightarrow Q(A)$$

is an isomorphism, which is a basic property of localization.

Since A is a Cohen–Macaulay ring of Krull dimension one, the category $T = \ker(\mathbb{F})$ is equal to $\text{Tor}(A)$. Let $\widehat{M}(A) = A\text{-Mod}/\text{Tor}(A)$ (one can consult [64] for the definition of the Serre quotients categories in the case they are not small). By [41, Proposition III.2.4] the functor \mathbb{F} induces an equivalence of categories $\bar{\mathbb{F}} : \widehat{M}(A) \rightarrow Q(A)\text{-Mod}$.

It is clear that $\text{Tor}(A) \cap A\text{-mod} = \text{fnlg}(A)$, hence basic properties of Serre quotients imply that the functor given by the composition

$$A\text{-mod}/\text{fnlg}(A) \longrightarrow A\text{-Mod}/\text{Tor}(A) \xrightarrow{\bar{\mathbb{F}}} Q(A)\text{-Mod}$$

is fully faithful. Since $Q(A) = \bar{\mathbb{F}}(A)$ and $\bar{\mathbb{F}} : \text{End}_{M(A)}(A) \rightarrow Q(A)$ is an isomorphism of rings, the functor $\bar{\mathbb{F}} : M(A) \rightarrow Q(A)\text{-mod}$ is essentially surjective.

(2) The proof of this statement is similar to the previous one. The functor $i^* : \text{QCoh}(X) \rightarrow \text{QCoh}(U)$ has a right adjoint $i_* : \text{QCoh}(U) \rightarrow \text{QCoh}(X)$ and the counit of the adjunction $i^*i_* \rightarrow \mathbb{1}_{\text{QCoh}(U)}$ is an isomorphism. It is easy to see that the kernel of the functor i^* is the category $\text{QCoh}_x(X)$ consisting of the quasi-coherent sheaves on X supported at the closed point x . Again, by [41, Proposition III.2.4] the inverse image functor i^* induces an equivalence of categories $\text{QCoh}(X)/\text{QCoh}_x(X) \rightarrow \text{QCoh}(U)$. This functor restricts to a fully faithful functor $\text{Coh}(X)/\text{Coh}_x(X) \rightarrow \text{Coh}(U)$. It remains to verify that this functor is essentially surjective.

Let \mathcal{F} be a coherent sheaf on U , then the direct image sheaf $\mathcal{G} := i_*\mathcal{F}$ is quasi-coherent. However, any quasi-coherent sheaf on a Noetherian scheme can be written as a direct limit of an increasing sequence of coherent subsheaves $\mathcal{G}_1 \subseteq \mathcal{G}_2 \subseteq \dots \subseteq \mathcal{G}$. Since the functor i^* is exact, we obtain an increasing filtration $i^*\mathcal{G}_1 \subseteq i^*\mathcal{G}_2 \subseteq \dots \subseteq i^*\mathcal{G}$. But $i^*\mathcal{G} = i^*i_*\mathcal{F} \cong \mathcal{F}$. Since the scheme U is Noetherian and \mathcal{F} is coherent, it implies that $\mathcal{F} \cong i^*\mathcal{G}_t$ for some $t \geq 1$. Hence, the functor $i^* : \text{Coh}(X) \rightarrow \text{Coh}(U)$ is essentially surjective and the induced functor $\text{Coh}(X)/\text{Coh}_x(X) \rightarrow \text{Coh}(U)$ is an equivalence of categories.

(3) The fact that the functor $\mathbb{I} : \text{CM}(A) \rightarrow M(A)$ is fully faithful, follows for example from [41, Lemme III.2.1]. It is well-known that for a normal surface singularity A the category $\text{Coh}(U)$ is hereditary. A proof of the equivalence between $\text{CM}(A)$ and $\text{VB}(U)$ can be found for instance in [19, Corollary 3.12]. Note that if A is an algebra over \mathbb{C} , the space U is homotopic to the link of the singularity $\text{Spec}(A)$.

(4) Let A be a reduced Cohen–Macaulay surface singularity. From [19, Lemma 3.6] we obtain that $\dagger : A\text{-mod} \rightarrow \text{CM}(A)$ induces the functor $M(A)^\circ \rightarrow \text{CM}(A)$, which for sake of simplicity will be denoted by the same symbol \dagger . Moreover, for any Noetherian A -module M and a Cohen–Macaulay A -module N we have isomorphisms

$$\text{Hom}_{M(A)}(M, N) \xleftarrow{\mathbb{P}_A} \text{Hom}_A(M, N) \longrightarrow \text{Hom}_{\text{CM}(A)}(M^\dagger, N),$$

which are natural in both arguments. For a proof of the isomorphism $M^\dagger \longrightarrow \Gamma(i_*i^*\widetilde{M})$, we refer to [19, Proposition 3.10]. \square

Lemma 4.4. *Let $A \subseteq B$ be a finite extension of Noetherian rings. Then the forgetful functor $\text{for} : B\text{-mod} \rightarrow A\text{-mod}$ and the functor $B \otimes_A - : A\text{-mod} \rightarrow B\text{-mod}$ form an adjoint pair and induce the functors*

$$\text{for} : \mathbf{M}(B) \longrightarrow \mathbf{M}(A) \quad \text{and} \quad B \bar{\otimes}_A - : \mathbf{M}(A) \longrightarrow \mathbf{M}(B)$$

which are again adjoint. Moreover, for an arbitrary A -module X and a B -module Y the following diagram is commutative:

$$\begin{array}{ccc} \text{Hom}_A(X, Y) & \xrightarrow{\text{can}} & \text{Hom}_B(B \otimes_A X, Y) \\ \mathbb{P}_A \downarrow & & \downarrow \mathbb{P}_B \\ \text{Hom}_{\mathbf{M}(A)}(X, Y) & \xrightarrow{\text{can}} & \text{Hom}_{\mathbf{M}(B)}(B \bar{\otimes}_A X, Y) \end{array}$$

where both horizontal maps are canonical isomorphisms given by adjunction.

Proof. Since the ring extension $A \subseteq B$ is finite, the functor $B \otimes_A -$ maps the category $\text{fnlg}(A)$ to $\text{fnlg}(B)$. The functors $\mathbb{F} = B \bar{\otimes}_A - : \mathbf{M}(A)^\circ \rightarrow \mathbf{M}(B)^\circ$ and $\mathbb{G} : \mathbf{M}(B)^\circ \rightarrow \mathbf{M}(A)^\circ$ are obtained from the adjoint pair of functors $B \otimes_A -$ and for using the universal property of the localization:

$$\begin{array}{ccc} A\text{-mod} & \xrightarrow{B \otimes_A -} & B\text{-mod} & & B\text{-mod} & \xrightarrow{\text{for}} & A\text{-mod} \\ \mathbb{P}_A^\circ \downarrow & & \downarrow \mathbb{P}_B^\circ & & \downarrow \mathbb{P}_B^\circ & & \downarrow \mathbb{P}_A^\circ \\ \mathbf{M}(A)^\circ & \xrightarrow{\mathbb{F}} & \mathbf{M}(B)^\circ & & \mathbf{M}(B)^\circ & \xrightarrow{\mathbb{G}} & \mathbf{M}(A)^\circ \end{array}$$

For an A -module M let $\xi_M : M \rightarrow B \otimes_A M$ be the unit of adjunction. Let $\psi : M \rightarrow N$ be a morphism in $\mathbf{M}(A)^\circ$ represented by the pair of $M \xleftarrow{\phi} E \xrightarrow{\varphi} N$, where $\ker(\phi)$ and $\text{coker}(\varphi)$ have finite length. Since the diagram

$$\begin{array}{ccccc} M & \xleftarrow{\phi} & E & \xrightarrow{\varphi} & N \\ \xi_M \downarrow & & \downarrow \xi_E & & \downarrow \xi_N \\ B \otimes_A M & \xleftarrow{1 \otimes \phi} & B \otimes_A E & \xrightarrow{1 \otimes \varphi} & B \otimes_A N \end{array}$$

is commutative, we get a natural transformation of functors $\xi : \mathbb{1}_{\mathbf{M}(A)^\circ} \rightarrow \mathbb{G} \mathbb{F}$. In the similar way, we construct a natural transformation $\zeta : \mathbb{F} \mathbb{G} \rightarrow \mathbb{1}_{\mathbf{M}(B)^\circ}$. Note that the natural transformations

$$\mathbb{F} \xrightarrow{\mathbb{F}(\xi)} \mathbb{F} \mathbb{G} \mathbb{F} \xrightarrow{\zeta \mathbb{F}} \mathbb{F} \quad \text{and} \quad \mathbb{G} \xrightarrow{\xi \mathbb{G}} \mathbb{G} \mathbb{F} \mathbb{G} \xrightarrow{\mathbb{G}(\zeta)} \mathbb{G}$$

are $\mathbb{1}_{\mathbb{F}}$ and $\mathbb{1}_{\mathbb{G}}$, respectively. Hence, (\mathbb{F}, \mathbb{G}) is an adjoint pair of functors. \square

Now we possess all necessary ingredients to formulate an alternative definition of the category of triples $\text{Tri}(A)$, given in Definition 3.3. Note that we have a pair of functors

$$(4.1) \quad \text{CM}(R) \xrightarrow{\bar{R} \bar{\otimes}_R -} \mathbf{M}(\bar{R}) \xleftarrow{\bar{R} \bar{\otimes}_A -} \mathbf{M}(\bar{A}).$$

Definition 4.5. The category $\text{Tri}'(A)$ is the following full subcategory of the comma category defined by the diagram (4.1). Its objects are triples $(\widetilde{M}, V, \theta)$, where \widetilde{M} is a maximal Cohen-Macaulay R -module, V an object of $\mathbf{M}(\bar{A})$ and $\theta : \bar{R} \bar{\otimes}_A V \rightarrow \bar{R} \bar{\otimes}_R \widetilde{M}$ is an epimorphism in $\mathbf{M}(\bar{R})$ such that the adjoint morphism in $\mathbf{M}(\bar{A})$

$$V \longrightarrow \bar{R} \bar{\otimes}_A V \xrightarrow{\theta} \bar{R} \bar{\otimes}_R \widetilde{M}$$

is an monomorphism.

A morphism between two triples $(\widetilde{M}, V, \theta)$ and $(\widetilde{M}', V', \theta')$ is given by a pair (φ, ψ) , where $\varphi : \widetilde{M} \rightarrow \widetilde{M}'$ is a morphism in $\text{CM}(R)$ and $\psi : V \rightarrow V'$ is a morphism in $\text{M}(\bar{A})$ such that the following diagram

$$\begin{array}{ccc} \bar{R} \otimes_{\bar{A}} V & \xrightarrow{\theta} & \bar{R} \otimes_R \widetilde{M} \\ \mathbb{1} \otimes \psi \downarrow & & \downarrow \mathbb{1} \otimes \varphi \\ \bar{R} \otimes_{\bar{A}} V' & \xrightarrow{\theta'} & \bar{R} \otimes_R \widetilde{M}' \end{array}$$

is commutative in the category $\text{M}(\bar{R})$. \square

Recall that for a maximal Cohen–Macaulay module M we denote $\widetilde{M} := R \boxtimes_A M$, whereas θ_M is the canonical morphism of R -modules given by the composition

$$\bar{R} \otimes_{\bar{A}} \bar{A} \otimes_A M \xrightarrow{\cong} \bar{R} \otimes_R R \otimes_A M \xrightarrow{\mathbb{1} \otimes \delta} \bar{R} \otimes_R (R \boxtimes_A M).$$

By Theorem 2.4, the canonical morphism $R \otimes_A M \xrightarrow{\delta} R \boxtimes_A M$ has cokernel of finite length, hence θ_M has finite length cokernel as well. This implies that the morphism

$$\mathbb{P}_{\bar{R}}(\theta_M) : \bar{R} \otimes_{\bar{A}} \bar{A} \otimes_A M \longrightarrow \bar{R} \otimes_R (R \boxtimes_A M)$$

is an epimorphism in $\text{M}(\bar{R})$. Next, we have the following commutative diagram in the category of A -modules:

$$(4.2) \quad \begin{array}{ccccccc} 0 & \longrightarrow & IM & \longrightarrow & M & \xrightarrow{\pi} & \bar{A} \otimes_A M \longrightarrow 0 \\ & & \bar{j} \downarrow & & j \downarrow & & \downarrow \bar{\theta}_M \\ 0 & \longrightarrow & I\widetilde{M} & \longrightarrow & \widetilde{M} & \xrightarrow{\gamma} & \bar{R} \otimes_R \widetilde{M} \longrightarrow 0, \end{array}$$

where $\widetilde{M} = R \boxtimes_A M$, $j : M \rightarrow \widetilde{M}$ is the canonical morphism and \bar{j} is its restriction on IM . The morphism j is injective. Moreover, for any $\mathfrak{p} \in \mathcal{P}$ the morphism $\bar{j}_{\mathfrak{p}} : (IM)_{\mathfrak{p}} \rightarrow (I\widetilde{M})_{\mathfrak{p}}$ is an isomorphism, see the proof of Lemma 13.2. Hence, $\text{coker}(\bar{j})$ is an A -module of finite length. Snake lemma implies that $\ker(\bar{\theta})$ is a submodule of $\text{coker}(\bar{j})$. Hence, it has finite length, too. By Lemma 4.4, the morphisms $\mathbb{P}_{\bar{R}}(\theta_M)$ and $\mathbb{P}_{\bar{A}}(\bar{\theta}_M)$ are mapped to each other under the morphisms of adjunction. This yields the following corollary.

Corollary 4.6. *We have a functor $\mathbb{F}' : \text{CM}(A) \rightarrow \text{Tri}'(A)$ assigning to a maximal Cohen–Macaulay A -module M the triple $(R \boxtimes_A M, \bar{A} \otimes_A M, \mathbb{P}_{\bar{R}}(\theta_M))$. Moreover, the equivalences of categories $\text{M}(\bar{A}) \rightarrow Q(\bar{A})\text{-mod}$ and $\text{M}(\bar{R}) \rightarrow Q(\bar{R})\text{-mod}$ constructed in Theorem 4.3 induce an equivalence of categories $\mathbb{E} : \text{Tri}'(A) \rightarrow \text{Tri}(A)$ such that the functors \mathbb{F} and $\mathbb{E}\mathbb{F}'$ are isomorphic.*

Definition 4.7. Consider the functor $\mathbb{B} : \text{Tri}'(A) \rightarrow \text{M}(A)$ defined as follows. For an object $T = (\widetilde{M}, V, \theta)$ of the category $\text{Tri}'(A)$ let $\widehat{M} := \bar{R} \otimes_R \widetilde{M}$ and $\gamma : \widetilde{M} \rightarrow \widehat{M}$ be the canonical morphism of R -modules. Let $\widetilde{M} \xrightarrow{\bar{\gamma}} \widehat{M}$ be the morphism in $\text{M}(A)$ obtained by applying to γ the functor $\mathbb{P}_{\bar{R}}$ and then the forgetful functor $\text{M}(R) \rightarrow \text{M}(A)$. Then we set

$$N := \mathbb{B}(T) = \ker\left(\widetilde{M} \oplus V \xrightarrow{(\bar{\gamma} \ \bar{\theta})} \widehat{M}\right)$$

and define \mathbb{B} on morphisms using the universal property of a kernel. Equivalently, we have a commutative diagram in the category $\mathbf{M}(A)$:

$$(4.3) \quad \begin{array}{ccccccc} 0 & \longrightarrow & I\widetilde{M} & \xrightarrow{\alpha} & N & \xrightarrow{\pi} & V \longrightarrow 0 \\ & & \downarrow = & & \downarrow \iota & & \downarrow \bar{\theta} \\ 0 & \longrightarrow & I\widetilde{M} & \xrightarrow{\bar{\beta}} & \widetilde{M} & \xrightarrow{\bar{\gamma}} & \widehat{M} \longrightarrow 0. \end{array}$$

According to Corollary 4.6, Theorem 3.5 is equivalent to the following statement.

Theorem 4.8. *The functor $\mathbb{G} : \mathrm{Tri}'(A) \rightarrow \mathrm{CM}(A)$ given by the composition of the functors $\mathbb{B} : \mathrm{Tri}'(A) \rightarrow \mathbf{M}(A)$ and $\dagger : \mathbf{M}(A) \rightarrow \mathrm{CM}(A)$, is quasi-inverse to \mathbb{F}' .*

Proof. Before going to the details, let us first explain the logic of our proof.

- We construct an isomorphism of functors $\mathbb{1}_{\mathrm{CM}(A)} \longrightarrow \mathbb{G} \circ \mathbb{F}'$.
- We show that \mathbb{G} is faithful.
- Finally, we prove that any triple $T \in \mathrm{Ob}(\mathrm{Tri}'(A))$ is isomorphic to $\mathbb{F}'\mathbb{G}(T)$.

The first two statements imply that \mathbb{F}' is fully faithful. The last one shows that \mathbb{F}' is essentially surjective. Hence, \mathbb{F}' is an equivalence of categories and \mathbb{G} is its quasi-inverse.

Now, let M be a maximal Cohen–Macaulay A -module. In the notations of the commutative diagram (4.2), we have the following exact sequence in the category of A -modules:

$$(4.4) \quad M \xrightarrow{\begin{pmatrix} - \\ \pi \end{pmatrix}} \widetilde{M} \oplus \overline{M} \xrightarrow{\begin{pmatrix} \gamma & \bar{\theta} \end{pmatrix}} \widehat{M} \longrightarrow 0,$$

where $\overline{M} = \bar{A} \otimes_A M$. Since $\mathbb{P}_A(\bar{j})$ is an isomorphism in $\mathbf{M}(A)$, the image of the sequence

(4.4) under the functor \mathbb{P}_A becomes short exact. The morphism $M \xrightarrow{\begin{pmatrix} - \\ \pi \end{pmatrix}} \widetilde{M} \oplus \overline{M}$ is natural in the category of A -modules, thus it is natural in $\mathbf{M}(A)$ as well. Hence, we obtain an isomorphism of functors $\mathbb{1}_{\mathrm{CM}(A)} \longrightarrow \mathbb{G} \circ \mathbb{F}'$. This shows that \mathbb{F}' is faithful.

Next, we prove that \mathbb{G} is faithful, too. Let $T = (\widetilde{M}, V, \theta)$ and $T' = (\widetilde{M}', V', \theta')$ be a pair of objects in $\mathrm{Tri}'(A)$ and $T \xrightarrow{(\varphi, \psi)} T'$ be a morphism in $\mathrm{Tri}'(A)$. Let $M = \mathbb{B}(T)$, $M' = \mathbb{B}(T')$ and $\phi = \mathbb{B}((\varphi, \psi))$. Then we have a commutative diagram in the category $\mathbf{M}(A)$:

$$(4.5) \quad \begin{array}{ccccccc} 0 & \longrightarrow & M & \longrightarrow & \widetilde{M} \oplus V & \xrightarrow{(\gamma \ \bar{\theta})} & \widehat{M} \longrightarrow 0 \\ & & \downarrow \phi & & \downarrow \begin{pmatrix} \varphi & 0 \\ 0 & \psi \end{pmatrix} & & \downarrow \widehat{\phi} \\ 0 & \longrightarrow & M' & \longrightarrow & \widetilde{M}' \oplus V' & \xrightarrow{(\gamma' \ \bar{\theta}')} & \widehat{M}' \longrightarrow 0. \end{array}$$

First note that $(\varphi, \psi) = 0$ in $\mathrm{Tri}'(A)$ if and only if $\varphi = 0$. Indeed, one direction is obvious. To show the second, let $\varphi = 0$. Then $\widehat{\phi} = 0$ and $\bar{\theta}' \circ \psi = 0$. It remains to note that $\bar{\theta}'$ is a monomorphism.

Next, a morphism $\varphi : \widetilde{M} \rightarrow \widetilde{M}'$ is zero in $\mathrm{CM}(R)$ if and only if $\mathbb{1} \otimes \varphi : Q(A) \otimes_A \widetilde{M} \rightarrow Q(A) \otimes_A \widetilde{M}'$ is zero in $Q(A) - \mathbf{mod}$. Assume the morphism of triples $(\varphi, \psi) : T \rightarrow T'$ is non-zero. Apply the functor $Q(A) \otimes_A -$ on the diagram (4.5). It follows that $\mathbb{1} \otimes \phi \neq 0$, hence $\mathbb{G}((\varphi, \psi)) \neq 0$ as well. Hence, \mathbb{G} is faithful. From the isomorphism of functors $\mathbb{1}_{\mathrm{CM}(A)} \longrightarrow \mathbb{G} \circ \mathbb{F}'$ it follows that \mathbb{F}' is full.

The difficult part of the proof is to show that \mathbb{F}' is essentially surjective. It is sufficient to show that for an arbitrary triple $T = (\widetilde{M}, V, \theta)$ there exists an isomorphism $T \cong \mathbb{F}'\mathbb{G}(T)$ in the category $\mathrm{Tri}'(A)$. We split our arguments into several logical steps.

Step 1. Since \bar{A} is a Cohen–Macaulay ring of Krull dimension one, the kernel $\text{tor}(V)$ of the canonical map $V \rightarrow Q(\bar{A}) \otimes_{\bar{A}} V$ is annihilated by some power of the maximal ideal. Hence, the canonical map $V \xrightarrow{\nu} V/\text{tor}(V) =: V'$ is an isomorphism in the category $\mathbf{M}(\bar{A})$. We get the following isomorphism in the category $\text{Tri}'(A)$

$$(\mathbb{1}, \nu) : (\widetilde{M}, V, \theta) \longrightarrow (\widetilde{M}, V', \theta'),$$

where the morphism θ' is induced by ν . Hence, we may without loss of generality assume that the object V of the category $\mathbf{M}(\bar{A})$ is represented by a maximal Cohen–Macaulay \bar{A} -module.

Step 2. For a maximal Cohen–Macaulay R -module \widetilde{M} consider the following commutative diagram in the category of R -modules:

$$\begin{array}{ccccccccc} 0 & \longrightarrow & I\widetilde{M} & \xrightarrow{\beta} & \widetilde{M} & \xrightarrow{\gamma} & \widehat{M} & \longrightarrow & 0 \\ & & \downarrow \delta & & \downarrow = & & \downarrow \rho & & \\ 0 & \longrightarrow & (I\widetilde{M})^\dagger & \xrightarrow{\beta^\circ} & \widetilde{M} & \xrightarrow{\gamma^\circ} & \widehat{M}^\circ & \longrightarrow & 0, \end{array}$$

where $I\widetilde{M} \xrightarrow{\delta} (I\widetilde{M})^\dagger$ is the canonical morphism determined by the Macaulayfication functor. Hence, $\text{coker}(\delta)$ is an R -module of finite length. Snake lemma yields that ρ is a surjective morphism of R -modules and $\ker(\rho) \cong \text{coker}(\delta)$. In particular, \widehat{M}° is annihilated by the conductor ideal I , hence it is an \bar{R} -module. Depth Lemma implies that $\text{depth}_R(\widehat{M}^\circ) = \text{depth}_{\bar{R}}(\widehat{M}^\circ) = 1$, hence \widehat{M}° is maximal Cohen–Macaulay over \bar{R} . Moreover, the morphism $\bar{\rho} := \mathbb{P}_{\bar{R}}(\rho) : \widehat{M} \rightarrow \widehat{M}^\circ$ is an isomorphism in $\mathbf{M}(\bar{R})$.

Step 3. In the notations as above we have the following isomorphism in the category $\mathbf{M}(A)$:

$$\ker\left(\widetilde{M} \oplus V \xrightarrow{(\bar{\gamma} \ \bar{\theta})} \widehat{M}\right) \cong \ker\left(\widetilde{M} \oplus V \xrightarrow{(\bar{\gamma}^\circ \ \bar{\theta}^\circ)} \widehat{M}^\circ\right),$$

where $\bar{\theta}^\circ = \bar{\rho} \bar{\theta} : V \rightarrow \widehat{M}^\circ$. Since \widehat{M}° is a maximal Cohen–Macaulay \bar{R} -module, it is also maximal Cohen–Macaulay over \bar{A} . In particular, it has no \bar{A} -submodules of finite length. From the definition of the category $\mathbf{M}(A)$ it follows that $\bar{\theta}^\circ$ can be written as

$$\bar{\theta}^\circ = \mathbb{P}_A(\underline{\tilde{\theta}}) \cdot \mathbb{P}_A(\tau)^{-1}, \quad V \xleftarrow{\tau} V' \xrightarrow{\underline{\tilde{\theta}}} \widehat{M}^\circ,$$

where $\tau : V' \rightarrow V$ is a monomorphism of \bar{A} -modules with cokernel of finite length and $\underline{\tilde{\theta}}$ is a morphism of \bar{A} -modules. Since we have assumed V to be maximal Cohen–Macaulay over \bar{A} , its submodule V' is maximal Cohen–Macaulay over \bar{A} as well. Next, $\bar{\theta}^\circ$ is a monomorphism in $\mathbf{M}(\bar{A})$, hence the kernel of $\underline{\tilde{\theta}}$ has finite length. But $\ker(\underline{\tilde{\theta}})$ is a submodule of a maximal Cohen–Macaulay \bar{A} -module V' . Hence, $\underline{\tilde{\theta}}$ is a monomorphism of \bar{A} -modules. Identifying V and V' in the category $\mathbf{M}(\bar{A})$ we may without loss of generality assume:

- In the triple $T = (\widetilde{M}, V, \theta)$, the module V is Cohen–Macaulay over \bar{A} and the morphism $\bar{\theta}^\circ : V \rightarrow \widehat{M}^\circ$ in $\mathbf{M}(\bar{A})$ is the image of an injective morphism of \bar{A} -modules under the functor $\mathbb{P}_{\bar{A}}$. For sake of simplicity, we denote the latter morphism by the same letter $\bar{\theta}^\circ$.

- The object $N = \mathbb{B}(T) \in \text{Ob}(\mathbf{M}(A))$ can be obtained by applying \mathbb{P}_A to the middle term of the upper short exact sequence in the following diagram in $A\text{-mod}$:

$$(4.6) \quad \begin{array}{ccccccccc} 0 & \longrightarrow & (I\widetilde{M})^\dagger & \xrightarrow{\alpha} & N & \xrightarrow{\pi} & V & \longrightarrow & 0 \\ & & \downarrow = & & \downarrow \iota & & \downarrow \tilde{\theta}^\circ & & \\ 0 & \longrightarrow & (I\widetilde{M})^\dagger & \xrightarrow{\beta^\circ} & \widetilde{M} & \xrightarrow{\gamma^\circ} & \widehat{M}^\circ & \longrightarrow & 0. \end{array}$$

Since $\tilde{\theta}^\circ$ is injective in $\bar{A}\text{-mod}$, snake lemma yields that N is a torsion free A -module.

Step 4. In the notations of the commutative diagram (4.6), consider the canonical morphism $N \xrightarrow{\delta} N^\dagger$. Then we obtain the following commutative diagram in $A\text{-mod}$:

$$\begin{array}{ccccccccc} 0 & \longrightarrow & (I\widetilde{M})^\dagger & \xrightarrow{\alpha} & N & \xrightarrow{\pi} & V & \longrightarrow & 0 \\ & & \downarrow = & & \downarrow \delta & & \downarrow \delta' & & \\ 0 & \longrightarrow & (I\widetilde{M})^\dagger & \xrightarrow{\alpha^\dagger} & N^\dagger & \xrightarrow{\pi'} & W & \longrightarrow & 0, \end{array}$$

where π' and δ' are induced morphisms. Since N is a torsion free A -module, δ is injective and its cokernel has finite length, see Theorem 2.4. Snake lemma implies that $\text{coker}(\delta')$ has finite length, too. Moreover, the universal property of Macaulayfication implies there exists an injective morphism of A -modules $N^\dagger \xrightarrow{j} \widetilde{M}$ such that $j \delta = \iota$. In particular, we have: $j \alpha^\dagger = \iota \alpha = \beta^\circ$ and the following diagram

$$\begin{array}{ccccccccc} 0 & \longrightarrow & (I\widetilde{M})^\dagger & \xrightarrow{\alpha^\dagger} & N^\dagger & \xrightarrow{\pi'} & W & \longrightarrow & 0 \\ & & \downarrow = & & \downarrow j & & \downarrow j' & & \\ 0 & \longrightarrow & (I\widetilde{M})^\dagger & \xrightarrow{\beta^\circ} & \widetilde{M} & \xrightarrow{\gamma^\circ} & \widehat{M}^\circ & \longrightarrow & 0, \end{array}$$

commutes in $A\text{-mod}$, where j' is the morphism induced by j . Since j is injective, the morphism j' is injective as well. Hence, the A -module W is annihilated by the conductor ideal I . Thus, it is a maximal Cohen-Macaulay \bar{A} -module and the morphism $\mathbb{P}_{\bar{A}}(\delta') : V \rightarrow W$ is an isomorphism in $\mathbf{M}(\bar{A})$.

Step 5. In other words, we have shown that any object T of the category $\text{Tri}'(A)$ has a representative $(\widetilde{M}, V, \theta)$ such that V is maximal Cohen-Macaulay, the morphism $V \xrightarrow{\tilde{\theta}^\circ} \widehat{M}^\circ$ belongs to the image of the functor \mathbb{P}_A and the module N given by the diagram (4.6) is maximal Cohen-Macaulay over A . By the definition of the functor \mathbb{G} , we have: $N \cong \mathbb{G}(T)$. It remains to find an isomorphism between the triples $\mathbb{F}'(N)$ and T .

Let $I\widetilde{M} \xrightarrow{\delta} (I\widetilde{M})^\dagger$ be the canonical morphism and $\iota' : I\widetilde{M} \rightarrow (I\widetilde{M})^\dagger$ be the composition of the restriction of ι on IN with δ . Since ι is injective, it is easy to see that the following diagram is commutative:

$$\begin{array}{ccccccccc} 0 & \longrightarrow & IN & \xrightarrow{\beta_N} & N & \xrightarrow{\pi_N} & \bar{N} & \longrightarrow & 0 \\ & & \downarrow \iota' & & \downarrow \iota & & \downarrow \kappa & & \\ 0 & \longrightarrow & (I\widetilde{M})^\dagger & \xrightarrow{\alpha} & N & \xrightarrow{\pi} & V & \longrightarrow & 0. \end{array}$$

By Lemma 13.2, the morphism ι' is injective and its cokernel has finite length. Since $\ker(\kappa)$ is a subobject of $\text{coker}(\iota')$ the morphism $\mathbb{P}_{\bar{A}}(\kappa) : \bar{N} \rightarrow V$ is an isomorphism in $\mathbf{M}(\bar{A})$. Next, the morphism of maximal Cohen–Macaulay A –modules $\iota : N \rightarrow \widetilde{M}$ induces a morphism of maximal Cohen–Macaulay R –modules $\tilde{\iota} : R \boxtimes_A N \rightarrow \widetilde{M}$. Theorem 13.5 implies that $\tilde{\iota}_{\mathfrak{p}} : (R \boxtimes_A N)_{\mathfrak{p}} \rightarrow \widetilde{M}_{\mathfrak{p}}$ is an isomorphism of $A_{\mathfrak{p}}$ –modules for all prime ideals $\mathfrak{p} \in \mathcal{P}$. Hence, $\tilde{\iota}$ is an isomorphism in $\text{CM}(R)$.

Step 6. It remains to observe that $(\tilde{\iota}, \mathbb{P}_{\bar{A}}(\kappa)) : \mathbb{F}'(N) \rightarrow (\widetilde{M}, V, \theta)$ is an isomorphism in the category of triples $\text{Tri}'(A)$. Since both morphisms $\tilde{\iota}$ and $\mathbb{P}_{\bar{A}}(\kappa)$ are known to be isomorphisms, it is sufficient to show that $(\tilde{\iota}, \mathbb{P}_{\bar{A}}(\kappa))$ is a morphism in $\text{Tri}'(A)$. In the notations of the commutative diagram (4.6), this fact follows from the commutativity of the following diagram in the category A –mod:

$$\begin{array}{ccc}
\bar{R} \otimes_A \bar{N} & \xrightarrow{\theta_N} & \bar{R} \otimes_R (R \boxtimes_A N) \\
\downarrow \mathbb{1} \otimes \kappa & \searrow \text{can} & \nearrow \mathbb{1} \otimes \delta \\
& & \bar{R} \otimes_R (R \otimes_A N) \\
& & \searrow \text{can} \\
\bar{R} \otimes_{\bar{A}} V & \xrightarrow{\theta^\circ} & \widehat{M}^\circ \longleftarrow \bar{R} \otimes_R \widetilde{M}, \\
& & \downarrow \mathbb{1} \otimes \tilde{\iota}
\end{array}$$

which can be verified by a simple diagram chasing. Theorem is proven. \square

Remark 4.9. In their recent monograph [60, Section 14.2], Leuschke and Wiegand give a simpler proof of Theorem 3.5 in the special case when \bar{A} and R are both regular.

Observe that we have the following practical rule to reconstruct a maximal Cohen–Macaulay A –module M from the corresponding triple $\mathbb{F}(M) \in \text{Ob}(\text{Tri}(A))$.

Corollary 4.10. *Let $T = (\widetilde{M}, V, \theta)$ be an object of the category of triples $\text{Tri}(A)$. Then there exists a maximal Cohen–Macaulay \bar{A} –module U , an injective morphism of \bar{A} –modules $\varphi : U \rightarrow \bar{R} \otimes_R \widetilde{M}$ and an isomorphism $\psi : Q(\bar{R}) \otimes_{\bar{A}} U \rightarrow Q(\bar{R}) \otimes_{Q(\bar{A})} V$ such that the following diagram*

$$\begin{array}{ccc}
Q(\bar{R}) \otimes_{\bar{A}} U & \xrightarrow{\mathbb{1} \otimes \varphi} & Q(\bar{R}) \otimes_R \widetilde{M} \\
\searrow \psi & & \nearrow \theta \\
& & Q(\bar{R}) \otimes_{Q(\bar{A})} V
\end{array}$$

is commutative in the category of $Q(\bar{R})$ –modules. Consider the following commutative diagram with exact rows in the category of A –modules:

$$\begin{array}{ccccccccc}
0 & \longrightarrow & I\widetilde{M} & \longrightarrow & N & \longrightarrow & U & \longrightarrow & 0 \\
& & \downarrow = & & \downarrow & & \downarrow \varphi & & \\
0 & \longrightarrow & I\widetilde{M} & \longrightarrow & \widetilde{M} & \longrightarrow & \bar{R} \otimes_R \widetilde{M} & \longrightarrow & 0.
\end{array}$$

Then we have: $\mathbb{G}(T) \cong N^\dagger$. In particular, the isomorphism class of N^\dagger does not depend on the choice of U and φ .

As we shall see later, in some cases the module N obtained by the recipe from Corollary 4.10, turns out to be automatically maximal Cohen–Macaulay. This can be tested using the following useful result.

Lemma 4.11. *In the notations of this section, let \widetilde{M} be a maximal Cohen–Macaulay R -module, V be a maximal Cohen–Macaulay \bar{A} -module and $\tilde{\theta} : V \rightarrow \widetilde{M}$ be an injective morphism of \bar{A} -modules. Consider the A -module N given by the following commutative diagram:*

$$\begin{array}{ccccccc} 0 & \longrightarrow & I\widetilde{M} & \longrightarrow & N & \longrightarrow & V \longrightarrow 0 \\ & & \downarrow = & & \downarrow \iota & & \downarrow \tilde{\theta} \\ 0 & \longrightarrow & I\widetilde{M} & \longrightarrow & \widetilde{M} & \longrightarrow & \widetilde{M} \longrightarrow 0. \end{array}$$

Then there is the following short exact sequence of A -modules:

$$(4.7) \quad 0 \longrightarrow N \longrightarrow N^\dagger \longrightarrow H_{\{m\}}^0(\text{coker}(\tilde{\theta})) \longrightarrow 0.$$

In particular, N is a maximal Cohen–Macaulay A -module if and only if $\text{coker}(\tilde{\theta})$ is a maximal Cohen–Macaulay \bar{A} -module.

Proof. By the snake lemma, we get the short exact sequence

$$0 \longrightarrow N \xrightarrow{\iota} \widetilde{M} \longrightarrow \text{coker}(\tilde{\theta}) \longrightarrow 0.$$

Since the module \widetilde{M} is maximal Cohen–Macaulay over A , we have: $H_{\{m\}}^0(\text{coker}(\tilde{\theta})) \cong H_{\{m\}}^1(N)$. On the other hand, the module N is torsion free and in the canonical short exact sequence

$$0 \longrightarrow N \xrightarrow{\delta} N^\dagger \longrightarrow T \longrightarrow 0$$

the module T has finite length. Hence, we have:

$$T \cong H_{\{m\}}^0(T) \cong H_{\{m\}}^1(N) \cong H_{\{m\}}^0(\text{coker}(\tilde{\theta}))$$

yielding the desired short exact sequence (4.7). \square

5. MAXIMAL COHEN-MACAULAY MODULES OVER $\mathbb{k}[[x, y, z]]/(x^2 + y^3 - xyz)$

In this section, we shall illustrate our method of study of maximal Cohen–Macaulay modules over non-isolated surface singularities, based on Theorem 3.5, on the case of the $T_{23\infty}$ -singularity $A = \mathbb{k}[[x, y, z]]/(x^3 + y^2 - xyz)$. We first have to accomplish the following computations.

- Let R be the normalization of A . Then $R = \mathbb{k}[[u, v]]$, where $u = \frac{y}{x}$ and $v = \frac{xz - y}{x}$.
- Next, $I = (x, y)A = (uv)R$ is the conductor ideal. Hence $\bar{A} = A/I = \mathbb{k}[[z]]$, whereas $\bar{R} = \mathbb{k}[[u, v]]/(uv)$. The map $\bar{A} \rightarrow \bar{R}$ sends z to $u + v$.
- Let $\mathbb{D} = \mathbb{k}[[z]]$ and $\mathbb{K} = \mathbb{k}((z))$. Then we have: $Q(\bar{A}) \cong \mathbb{k}((z)) = \mathbb{K}$ and $Q(\bar{R}) \cong \mathbb{k}((u)) \times \mathbb{k}((v)) \cong \mathbb{K} \times \mathbb{K}$.

Let $T = (\widetilde{M}, V, \theta)$ be an object of $\text{Tri}(A)$. Then the following results are true.

- Since R is regular, $\widetilde{M} \cong R^m$ for some integer $m \geq 1$.
- Next, V is just a vector space over the field \mathbb{K} , hence $V \cong \mathbb{K}^n$ for some $n \geq 1$.
- The gluing map θ is given by a pair of matrices of full row rank and the same size: $\theta = (\theta_u, \theta_v) \in \text{Mat}_{m \times n}(\mathbb{K}) \times \text{Mat}_{m \times n}(\mathbb{K})$.

If two triples $T = (\widetilde{M}, V, \theta)$ and $T' = (\widetilde{M}', V', \theta')$ are isomorphic then $\widetilde{M} \cong \widetilde{M}'$ and $V \cong V'$. Describing the isomorphy classes of objects in $\text{Tri}(A)$, we may without loss of generality assume that $\widetilde{M} = \widetilde{M}'$ and $V = V'$. The essential information about the isomorphism class of T is contained in the gluing data θ . The description of isomorphism classes of objects in $\text{Tri}(A)$ leads to the following matrix problem:

$$(5.1) \quad (\theta_u, \theta_v) \mapsto (S_1^{-1}\theta_u T, S_2^{-1}\theta_v T) = (\theta'_u, \theta'_v),$$

where $T \in \text{GL}_n(\mathbb{K})$ and $S_1, S_2 \in \text{GL}_m(\mathbb{D})$ are such that $S_1(0) = S_2(0)$. This matrix problem corresponds to the category of representations of a very special decorated bunch of chains, which will be treated in the full generality in the subsequent section.

Fact. The pair (θ_u, θ_v) splits into a direct sum of the following indecomposable blocks, see Subsection 7.3 below.

Continuous series. Let $l, t \geq 1$ be positive integers, $\omega = ((m_1, n_1), \dots, (m_t, n_t)) \in (\mathbb{Z}_+^2)^t$ be a “non-periodic sequence” such that $\min(m_i, n_i) = 1$ for all $1 \leq i \leq t$ and $\lambda \in \mathbb{k}^*$. Then we have the corresponding canonical form:

$$(5.2) \quad \theta_u = \begin{array}{|c|} \hline \begin{array}{ccccc} A_1 & 0 & 0 & \dots & 0 \\ 0 & A_2 & 0 & \dots & 0 \\ \vdots & \vdots & \ddots & \ddots & \vdots \\ 0 & 0 & \dots & A_{t-1} & 0 \\ 0 & 0 & \dots & 0 & A_t \end{array} \\ \hline \end{array} \quad \theta_v = \begin{array}{|c|} \hline \begin{array}{ccccc} 0 & B_2 & 0 & \dots & 0 \\ 0 & 0 & B_3 & 0 & 0 \\ \vdots & \vdots & \vdots & \ddots & \vdots \\ 0 & 0 & 0 & \dots & B_t \\ C & 0 & 0 & \dots & 0 \end{array} \\ \hline \end{array}$$

where $A_k = z^{m_k} I$, $B_k = z^{n_k} I$ and $C = z^{n_1} J$ with $I = I_l$ the identity $l \times l$ -matrix and $J = J_l(\lambda)$ the Jordan block of size $l \times l$ with the eigenvalue λ .

Discrete series. Let $\omega = (m_0, (m_1, n_1), \dots, (m_t, n_t), n_{t+1})$, where $m_0 = n_{t+1} = 1$ and $\min(m_i, n_i) = 1$ for all $1 \leq i \leq t$. Consider the matrices θ_u and θ_v of the size $(t+1) \times (t+2)$ given as follows:

$$(5.3) \quad \theta_u = \begin{array}{|c|} \hline \begin{array}{ccccc} z^{m_0} & 0 & 0 & \dots & 0 \\ 0 & z^{m_1} & 0 & \dots & 0 \\ \vdots & \vdots & \ddots & \ddots & \vdots \\ 0 & 0 & \dots & z^{m_t} & 0 \end{array} \\ \hline \end{array} \quad \theta_v = \begin{array}{|c|} \hline \begin{array}{ccccc} 0 & z^{n_1} & 0 & \dots & 0 \\ 0 & 0 & z^{n_2} & \dots & 0 \\ \vdots & \vdots & \vdots & \ddots & 0 \\ 0 & 0 & 0 & \dots & z^{n_{t+1}} \end{array} \\ \hline \end{array}$$

In the case $t = 0$ we set $\theta_u = (1 \ 0)$ and $\theta_v = (0 \ 1)$. □

This result is a special case of the classification of indecomposable objects in the category of representations of a decorated bunch of chains, which will be treated in the subsequent sections. We get the following conclusion.

- Let (ω, l, λ) be a band datum as above. Then the triple $(R^{tl}, \mathbb{K}^{tl}, (\theta_u, \theta_v))$ defines an indecomposable maximal Cohen–Macaulay module $M(\omega, l, \lambda)$, which is locally free of rank tl on the punctured spectrum of A . Moreover, any indecomposable object of $\text{CM}^{\text{lf}}(A)$ is described by a triple of the above form.
- Let ω be a string datum as above. Then the triple $(R^{t+1}, \mathbb{K}^{t+1}, (\theta_u, \theta_v))$ defines an indecomposable maximal Cohen–Macaulay A -module $N(\omega)$ of rank $t+1$, which is not locally free on the punctured spectrum. Moreover, any indecomposable object of $\text{CM}(A)$ which does not belong to $\text{CM}^{\text{lf}}(A)$, is isomorphic to some $N(\omega)$.

Our next goal is to describe an algorithm to construct maximal Cohen–Macaulay A -modules corresponding to the canonical forms (5.2) and (5.3). First note the following simple result.

Lemma 5.1. *Let (θ_u, θ_v) be the canonical form given either by a band datum (ω, l, λ) or by a string datum ω . Let $\theta = \theta_u(u) + \theta_v(v) \in \text{Hom}_{\bar{A}}(\bar{A}^p, \bar{R}^q)$ be the corresponding morphism of \bar{A} -modules, where $p = q = tl$ in the case of bands and $p = t+2, q = t+1$ in the case of strings. Then the induced morphism of $Q(\bar{A})$ -modules $\mathbb{1} \otimes \theta : Q(\bar{A})^p \rightarrow Q(\bar{R})^q$ is given by the original matrices $(\theta_u(u), \theta_v(v))$, where we use the canonical isomorphism $Q(\bar{A}) \otimes_{\bar{A}} \bar{R} \rightarrow Q(\bar{R})$.*

As a consequence, we get a complete description of the indecomposable maximal Cohen–Macaulay modules over the ring $A = \mathbb{k}[[x, y, z]]/(x^3 + y^2 - xyz)$.

Corollary 5.2. *Let (θ_u, θ_v) be the canonical form defined by a band datum (ω, l, λ) or by a string datum ω and $\theta = \theta_u(u) + \theta_v(v)$ and p, q be as in Lemma 5.1. Consider the matrix*

$$\bar{\theta} := (xI_q \mid yI_q \mid \theta) \in \text{Mat}_{q \times (2q+p)}(R).$$

Let $L \subseteq R^q$ be the A -module generated by the columns of the matrix $\bar{\theta}$. Then the maximal Cohen–Macaulay A -module $M := L^\dagger = L^{\vee\vee}$ satisfies:

$$\mathbb{F}(M) \cong (R^q, \mathbb{K}^p, (\theta_u, \theta_v)).$$

In other words, M is an indecomposable maximal Cohen–Macaulay A -module corresponding to the canonical forms (5.2) and (5.3).

Corollary 5.2 leads to the following result.

Proposition 5.3. *For the ring $A = \mathbb{k}[[x, y, z]]/(x^3 + y^2 - xyz)$ the classification of maximal Cohen–Macaulay A -modules of rank one is the following.*

- (1) *There exists exactly one maximal Cohen–Macaulay module $N = N(1, \cdot, 1)$ of rank one, which is not locally free on the punctured spectrum. We have the following A -module isomorphisms: $N \cong I \cong R$.*
- (2) *A rank one object of $\text{CM}^{\text{lf}}(A)$ is either regular or has the following form:*

$$M((1, m), \lambda) \cong I_{m, \lambda} \quad \text{and} \quad M((m, 1), 1, \lambda) \cong J_{m, \lambda},$$

where $\lambda \in \mathbb{k}^$ for $m \geq 2$ and $\lambda \in \mathbb{k}^* \setminus \{1\}$ for $m = 1$, $I_{m, \lambda} = \langle x^{m+1}, yx^{m-1} + \lambda(xz - y)^m \rangle \subset A$ and $J_{m, \lambda} = \langle x^{m+1}, y^m + \lambda x^{m-1}(xz - y) \rangle \subset A$.*

Proof. The fact that there exists precisely one object of $\text{CM}(A)$ of rank one, which does not belong to $\text{CM}^{\text{lf}}(A)$, follows from Corollary 5.2. Note that both modules I and R share the property to be maximal Cohen–Macaulay of rank one, being not locally free on the punctured spectrum.

Let $\theta_u = z^m$, $\theta_v = \lambda z^n$ and $\theta = \theta_u(u) + \theta_v(v)$, where $\lambda \in \mathbb{k}^*$ and $\min(m, n) = 1$. Then unless $\max(m, n) = 1$ and $\lambda = 1$, the cokernel of the morphism of \bar{A} -modules $\theta : \bar{A} \rightarrow \bar{R}$ has no finite length submodules. By Lemma 4.11 and Corollary 5.2 we get:

$$M((m, 1), 1, \lambda) = \langle x, y, u^m + \lambda v \rangle_A \subseteq R \quad \text{and} \quad M((1, m), 1, \lambda) = \langle x, y, u + \lambda v^m \rangle_A \subseteq R.$$

Next, observe that $u = \frac{y}{x}$ fulfills the equation $u^2 - zu + x = 0$. By induction it is not difficult to show that for any $m \geq 2$ there exist polynomials $p_m(X, Z)$ and $q_m(X, Z)$ from $\mathbb{k}[[X, Z]]$ such that the following equality holds in R : $u^m = p_m(x, z)u + q_m(x, z)$. Using this fact it is not difficult to derive that

$$y \in \langle x, u + \lambda v^m \rangle_A \cong \langle x^{m+1}, x^m y, x^{m-1} y + \lambda(xz - y)^m \rangle_A.$$

In a similar way, $y \in \langle x, u^m + \lambda v \rangle_A \cong \langle x^{m+1}, x^m y, y^m + \lambda x^{m-1}(xz - y) \rangle_A$. \square

It is very instructive to compute the matrix factorizations corresponding to some rank one Cohen–Macaulay A -modules. Note that the conductor ideal I corresponds to the matrix factorization $\left(\begin{pmatrix} x & y \\ -y & x^2 - yz \end{pmatrix}, \begin{pmatrix} x & -y \\ y & x^2 - yz \end{pmatrix} \right)$.

Consider now the family of modules $M((1, 1), 1, \lambda) \cong \langle x, \frac{y}{x} + \lambda \frac{xz - y}{x} \rangle_A$, where $\lambda \in \mathbb{k}^* \setminus \{1\}$. The special value $\lambda = 1$ has to be treated separately: in this case we have $M((1, 1), 1, \lambda) \cong A$. For $\lambda \neq 1$ we know that $M((1, 1), 1, \lambda) = \langle x^2, y + \frac{\lambda}{\lambda - 1} xz \rangle_A$. The new moduli parameter $\mu = \frac{\lambda}{\lambda - 1}$ takes its values in $\mathbb{P}^1 \setminus \{(1 : -1)\} = (\mathbb{k} \cup \{\infty\}) \setminus \{-1\}$. One can check that $M((1, 1), 1, \lambda)$ has a presentation:

$$A^2 \xrightarrow{\begin{pmatrix} x + \mu(\mu + 1)z^2 & y + \mu xz \\ y - (\mu + 1)xz & -x^2 \end{pmatrix}} A^2 \longrightarrow M((1, 1), 1, \lambda) \longrightarrow 0.$$

Note that the forbidden value $\mu = -1$ corresponds to the module $R \cong I$, whereas the value $\mu = \infty$ corresponds to the regular module A . In other words, the “pragmatic moduli space” of the rank one modules $M((1, 1), 1, \lambda)$ can be naturally compactified to the nodal cubic curve $zy^2 = x^3 + x^2z$, where the unique singular point corresponds to the unique rank one Cohen–Macaulay A -module, which is not locally free on the punctured spectrum. Note that the explicit expression for the presentation matrices of $M((1, 1), 1, \lambda)$ are consistent with the criteria to be locally free on the punctured spectrum from Lemma 2.12.

Next, let us compute the matrix factorization describing the family $M((2, 1), 1, \lambda)$. By Corollary 5.2 we have:

$$M((2, 1), 1, \lambda) = \langle x^3, y^2 + \lambda(xz - y)x \rangle_A = \langle x^3, xyz + \lambda(xz - y)x \rangle_A \cong \langle x^2, y(z - \lambda) + \lambda xz \rangle_A.$$

This family has the following presentation:

$$A^2 \xrightarrow{\begin{pmatrix} x(z - \lambda)^2 + \lambda z^3 & y(z - \lambda) - \lambda xz \\ y(z - \lambda) - xz^2 & x^2 \end{pmatrix}} A^2 \longrightarrow M((2, 1), 1, \lambda) \longrightarrow 0.$$

Our approach can be also applied to describe maximal Cohen–Macaulay modules of higher rank. Consider the long exact sequence

$$0 \longrightarrow A \longrightarrow F \longrightarrow A \longrightarrow \mathbb{k} \longrightarrow 0,$$

corresponding to the generator of the A -module $\text{Ext}_A^2(\mathbb{k}, A) \cong \mathbb{k}$. The module F is called *fundamental module*. By a result of Auslander [4], F is maximal Cohen–Macaulay. It plays a central role in the theory of almost split sequences in the category $\text{CM}(A)$. Let

us compute a presentation of F using our method. First, with some efforts one can show that F corresponds to the triple

$$\left(R^2, \mathbb{K}^2, \left(\begin{pmatrix} 1 & 0 \\ 0 & 1 \end{pmatrix}, \begin{pmatrix} 1 & 1 \\ 0 & 1 \end{pmatrix}\right)\right) \cong \left(R^2, \mathbb{K}^2, (\theta_u = \begin{pmatrix} u & 0 \\ 0 & u \end{pmatrix}, \theta_v = \begin{pmatrix} v & v \\ 0 & v \end{pmatrix})\right).$$

Consider the module N given by the diagram

$$\begin{array}{ccccccc} 0 & \longrightarrow & I^2 & \longrightarrow & N & \longrightarrow & \bar{A}^2 \longrightarrow 0 \\ & & \downarrow = & & \downarrow & & \downarrow \bar{\theta} \\ 0 & \longrightarrow & I^2 & \longrightarrow & R^2 & \longrightarrow & \bar{R}^2 \longrightarrow 0. \end{array}$$

Then we have:

$$N = \left\langle \begin{pmatrix} x^2 \\ 0 \end{pmatrix}, \begin{pmatrix} xy \\ 0 \end{pmatrix}, \begin{pmatrix} 0 \\ x^2 \end{pmatrix}, \begin{pmatrix} 0 \\ xy \end{pmatrix}, \begin{pmatrix} xz \\ 0 \end{pmatrix}, \begin{pmatrix} -y \\ xy \end{pmatrix} \right\rangle_A \subseteq A^2$$

and $F \cong N^\dagger$. Note that the element $a := \begin{pmatrix} x \\ 0 \end{pmatrix} \in A^2$ does not belong to N , however $ma \in N$. Applying Lemma 4.11 and Lemma 2.5 we conclude that

$$F \cong N^\dagger = \left\langle \begin{pmatrix} x \\ 0 \end{pmatrix}, \begin{pmatrix} 0 \\ -x^2 \end{pmatrix}, \begin{pmatrix} -y \\ xy \end{pmatrix}, \begin{pmatrix} 0 \\ xy \end{pmatrix} \right\rangle_A \subseteq A^2.$$

Moreover, F has the following presentation:

$$A^4 \xrightarrow{\begin{pmatrix} y & z & x & 0 \\ 0 & y & 0 & x \\ yz-x^2 & 0 & y & -z \\ 0 & yz-x^2 & 0 & y \end{pmatrix}} A^4 \longrightarrow F \longrightarrow 0.$$

One can check that we have an isomorphism $F \cong \text{syz}^3(\mathbb{k})$, which matches with a result obtained by Yoshino and Kawamoto [79].

Remark 5.4. According to Kahn [53] as well as to Drozd, Greuel and Kashuba [35], the normal surface singularity $B = \mathbb{k}[[x, y, z]]/(x^3 + y^2 + z^p - xyz)$, has tame Cohen–Macaulay representation type for $p \geq 6$. On the other hand, an explicit description of indecomposable maximal Cohen–Macaulay B -modules still remains unknown. It would be interesting to know what objects of $\text{CM}(A)$ can be deformed to objects in $\text{CM}(B)$, as well as to describe the corresponding families explicitly.

6. REPRESENTATIONS OF DECORATED BUNCHES OF CHAINS—I

In this section we introduce a certain type of matrix problems called “representations of decorated bunches of chains” and explain the combinatorics of indecomposable objects.

6.1. Notation. Let \mathbb{D} be a discrete valuation ring, \mathfrak{m} its maximal ideal, $t \in \mathfrak{m}$ an uniformizing element (i.e. such that $(t) = \mathfrak{m}$), $\mathbb{k} = \mathbb{D}/\mathfrak{m}$ the residue field of \mathbb{D} and \mathbb{K} the field of fractions of \mathbb{D} . For an element $a \in \mathbb{D}$ we denote by \bar{a} its image in \mathbb{k} . Similarly, for a matrix $W \in \text{Mat}_{m \times n}(\mathbb{D})$ we denote by $\bar{W} \in \text{Mat}_{m \times n}(\mathbb{k})$ its residue modulo \mathfrak{m} . Finally, $\mathbb{D} \times \mathbb{D} \supset \tilde{\mathbb{D}} = \{(a, b) \mid \bar{a} = \bar{b}\}$ is the *dyad* of \mathbb{D} with itself.

6.2. Bimodule problems. The language of bimodule problems has been introduced by Drozd in [28] as an attempt to formalize the notion of a matrix problem. See also [23] and [29] for further elaborations.

Let R be a commutative ring, \mathcal{A} be an R -linear category and \mathcal{B} be an \mathcal{A} -bimodule. The last means that for any pair of objects A, B of \mathcal{A} we have an R -module $\mathcal{B}(A, B)$ and for any further pair of objects A', B' there are left and right multiplication maps

$$\mathcal{A}(B, B') \times \mathcal{B}(A, B) \times \mathcal{A}(A', A) \longrightarrow \mathcal{B}(A', B'),$$

which are R -multilinear and associative.

Definition 6.1. The *bimodule category* $\text{El}(\mathcal{A}, \mathcal{B})$ (sometimes called *category of elements of the \mathcal{A} -bimodule \mathcal{B}*) is defined as follows. Its objects are pairs (A, W) , where A is an object of \mathcal{A} and $W \in \mathcal{B}(A, A)$. The morphism spaces in $\text{El}(\mathcal{A}, \mathcal{B})$ are defined as follows:

$$\text{El}(\mathcal{A}, \mathcal{B})((A, W), (A', W')) = \{F \in \mathcal{A}(A, A') \mid FW = W'F\}.$$

The composition of morphisms in $\text{El}(\mathcal{A}, \mathcal{B})$ is the same as in \mathcal{A} .

Remark 6.2. The category $\text{El}(\mathcal{A}, \mathcal{B})$ is additive and idempotent complete provided \mathcal{A} is additive and idempotent complete. However, one typically starts with a category \mathcal{A} having the property that the endomorphism algebra of any of its objects is local (obviously, in this case, \mathcal{A} can not be additive). Then one takes the *additive closure* \mathcal{A}^ω of \mathcal{A} and extends \mathcal{B} to an \mathcal{A}^ω -bimodule \mathcal{B}^ω by additivity. Abusing the notation, we write $\text{El}(\mathcal{A}, \mathcal{B})$ having actually the category $\text{El}(\mathcal{A}^\omega, \mathcal{B}^\omega)$ in mind.

Example 6.3. Assume $\mathbb{D} = \mathbb{k}[[t]]$. We define the category \mathcal{A} and bimodule \mathcal{B} as follows.

- \mathcal{A} has three objects: $\text{Ob}(\mathcal{A}) = \{a, b, c\}$.
- The non-zero morphism spaces of \mathcal{A} are:
 - $\mathcal{A}(a, a) = \mathbb{K}1_a$, $\mathcal{A}(b, c) = \langle \nu_1, \nu_2 \rangle_{\mathbb{D}} \cong \mathbb{D}^2$ and $\mathcal{A}(c, b) = \langle \rho_1, \rho_2 \rangle_{\mathbb{D}} \cong \mathbb{D}^2$.
 - $\mathcal{A}(b, b) = \mathbb{k}[[\beta_1, \beta_2]]/(\beta_1\beta_2)$ and $\mathcal{A}(c, c) = \mathbb{k}[[\gamma_1, \gamma_2]]/(\gamma_1\gamma_2)$.
- For $i = 1, 2$ we have the following relations: $\rho_i\nu_i = \beta_i$ and $\nu_i\rho_i = \gamma_i$.
- The bimodule \mathcal{B} is defined by the following rules:
 - $\mathcal{B}(a, b) = \langle \phi_1, \phi_2 \rangle_{\mathbb{K}} \cong \mathbb{K}^2 \cong \mathcal{B}(a, c) = \langle \psi_1, \psi_2 \rangle_{\mathbb{K}}$.
 - For $(x, y) \notin \{(a, b), (a, c)\}$ we have: $\mathcal{B}(x, y) = 0$.
 - The action of \mathcal{A} on \mathcal{B} is given by the following rules:

$$\beta_i \circ \phi_j = \delta_{ij}t \cdot \phi_i, \gamma_i \circ \psi_j = \delta_{ij}t \cdot \psi_i, \nu_i \circ \phi_j = \delta_{ij}t \cdot \psi_i, \rho_i \circ \psi_j = \delta_{ij}t \cdot \phi_i, i, j = 1, 2 \text{ and}$$

$$(\phi_1, \phi_2, \psi_1, \psi_2) \circ (\kappa 1_a) = (\kappa \cdot \phi_1, \kappa \cdot \phi_2, \kappa \cdot \psi_1, \kappa \cdot \psi_2), \kappa \in \mathbb{K}.$$

The entire data can be visualized by the following picture.

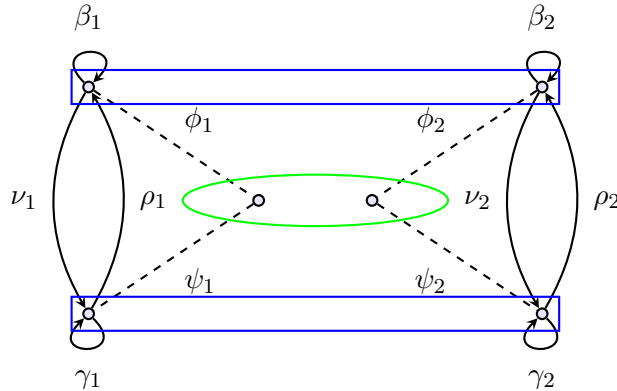

The encircled points represent three objects of the category \mathcal{A} , the solid arrows denote morphisms in \mathcal{A} whereas the dotted ones stand for generators of the bimodule \mathcal{B} .

Let us now derive the matrix problem describing the isomorphy classes of objects of $\text{El}(\mathcal{A}, \mathcal{B})$. For any $x \in \{a, b, c\}$ let Z_x denote the corresponding object of the category \mathcal{A}^ω . Then an object of $\text{El}(\mathcal{A}, \mathcal{B})$ is a pair (Z, W) , where $Z = Z_a^n \oplus Z_b^m \oplus Z_c^p$ and W is a matrix of the following shape:

$$W = \begin{array}{c|ccc|c} & a & b & c & \\ \hline & 0 & 0 & 0 & a \\ \hline & P & 0 & 0 & b \\ \hline & Q & 0 & 0 & c \\ \hline \end{array}$$

Here, $P = \Phi_1\phi_1 + \Phi_2\phi_2$ and $Q = \Psi_1\psi_1 + \Psi_2\psi_2$, where $\Phi_i \in \text{Mat}_{m \times n}(\mathbb{K})$ and $\Psi_i \in \text{Mat}_{p \times n}(\mathbb{K})$ for $i = 1, 2$.

An isomorphism of $(Z, W) \rightarrow (Z, \tilde{W})$ is given by a matrix

$$F = \begin{array}{c|ccc|c} & a & b & c & \\ \hline & S & 0 & 0 & a \\ \hline & 0 & X & R & b \\ \hline & 0 & N & Y & c \\ \hline \end{array}$$

Here, $S \in \text{GL}_n(\mathcal{A}(a, a)) \cong \text{GL}_n(\mathbb{K})$, $X \in \text{GL}_m(\mathcal{A}(b, b))$ and $Y \in \text{GL}_p(\mathcal{A}(c, c))$. Next, we write $R = R_1\rho_1 + R_2\rho_2$ with $R_1, R_2 \in \text{Mat}_{m \times p}(\mathbb{D})$ and $N = N_1\nu_1 + N_2\nu_2$ with $N_1, N_2 \in \text{Mat}_{p \times n}(\mathbb{D})$. Let (X_1, X_2) (respectively (Y_1, Y_2)) be the image of X (respectively Y) under the group homomorphism $\text{GL}_m(\mathcal{A}(b, b)) \rightarrow \text{GL}_m(\mathbb{D}) \times \text{GL}_m(\mathbb{D})$ (respectively $\text{GL}_p(\mathcal{A}(c, c)) \rightarrow \text{GL}_p(\mathbb{D}) \times \text{GL}_p(\mathbb{D})$).

The equality $FW = \tilde{W}F$ leads to the following matrix equalities:

$$(6.1) \quad \begin{cases} X_i\Phi_i + tR_i\Psi_i & = \tilde{\Phi}_i S \\ Y_i\Psi_i + N_i\Phi_i & = \tilde{\Psi}_i S, \end{cases}$$

where $i = 1, 2$. The obtained matrix problem can be visualized by the following picture.

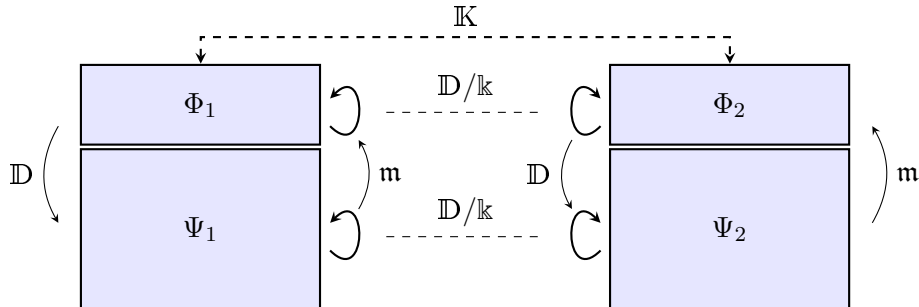

The matrix problem (6.1) can be rephrased as follows.

- We have four matrices Φ_1, Φ_2, Ψ_1 and Ψ_2 over \mathbb{K} . All of them have the same number of columns. The matrices Φ_1 and Φ_2 (respectively, Ψ_1 and Ψ_2) have the same number of rows. We can perform transformations of columns and rows of Φ_1, Φ_2, Ψ_1 and Ψ_2 , which are compositions of the following elementary ones.
- *Simultaneous transformations.* We can perform simultaneous elementary transformations
 - of columns of Φ_1, Φ_2, Ψ_1 and Ψ_2 with coefficients in the field of fractions \mathbb{K} .
 - of rows of Φ_1 and Φ_2 (respectively, Ψ_1 and Ψ_2) with coefficients in the residue field \mathbb{k} .
- *Independent transformations.*
 - We can independently perform (invertible) elementary transformations of rows of matrices Φ_i and Ψ_i , for $i = 1, 2$ with coefficients in the maximal ideal \mathfrak{m} .
 - For $i = 1, 2$, we can add an arbitrary \mathbb{D} -multiple of any row of Φ_i to any row of Ψ_i and an arbitrary \mathfrak{m} -multiple of any row of Ψ_i to any row of Φ_i .

Note that this is precisely the matrix problem, describing maximal Cohen–Macaulay modules over the degenerate cusp $T_{24\infty} = \mathbb{k}\llbracket u, v, w \rrbracket / (u^2 + v^4 - uvw)$. \square

Omitting some details, we state now several other bimodule problems playing a role in the study of maximal Cohen–Macaulay modules over non-isolated surface singularities.

Example 6.4 (*Decorated conjugation problem*). Consider the following category \mathcal{A} and \mathcal{A} -bimodule \mathcal{B} :

- $\text{Ob}(\mathcal{A}) = \{a\}$, $\mathcal{A}(a, a) = \mathbb{k}\llbracket \alpha_1, \alpha_2 \rrbracket / (\alpha_1 \alpha_2) \cong \widetilde{\mathbb{D}}$.
- $\mathcal{B}(a, a) = \langle \varphi \rangle_{\mathbb{K}} \cong \mathbb{K}$. The \mathcal{A} -bimodule structure on \mathcal{B} is given by the following rule: for any $\alpha \in \mathcal{A}(a, a)$ we have $\alpha \circ \varphi = \alpha(t, 0) \cdot \varphi$ and $\varphi \circ \alpha = \alpha(0, t) \cdot \varphi$.

The underlying matrix problem is the following. We have a square matrix $\Phi \in \text{Mat}_{n \times n}(\mathbb{K})$ which can be transformed according to the following rule:

$$(6.2) \quad \Phi \mapsto S_1 \Phi S_2^{-1},$$

where $S_1, S_2 \in \text{GL}_n(\mathbb{D})$ are such that $\bar{S}_1 = \bar{S}_2$.

Example 6.5 (*Decorated Kronecker problem*). The category \mathcal{A} and \mathcal{A} -bimodule \mathcal{B} are defined as follows.

- $\text{Ob}(\mathcal{A}) = \{a, b\}$, $\mathcal{A}(a, a) = \mathbb{k}\llbracket \alpha_1, \alpha_2 \rrbracket / (\alpha_1 \alpha_2) \cong \widetilde{\mathbb{D}}$, $\mathcal{A}(b, b) = \mathbb{K}1_b$, whereas $\mathcal{A}(a, b) = 0 = \mathcal{A}(b, a)$.
- $\mathcal{B}(b, a) = \langle \varphi, \psi \rangle_{\mathbb{K}} \cong \mathbb{K}^2$, $\mathcal{B}(a, a) = \mathcal{B}(b, b) = \mathcal{B}(a, b) = 0$.
- The \mathcal{A} -bimodule structure on \mathcal{B} is given by the following rules.
 - For $\alpha \in \mathcal{A}(a, a)$ we have: $\alpha \circ \varphi = \alpha(t, 0) \cdot \varphi$ and $\alpha \circ \psi = \alpha(0, t) \cdot \psi$.
 - For any $\kappa \in \mathbb{K}$ we have: $(\varphi, \psi) \circ (\kappa 1_b) = (\kappa \varphi, \kappa \psi)$.

The underlying matrix problem is the following. We have a pair of matrices $\Phi, \Psi \in \text{Mat}_{m \times n}(\mathbb{K})$ which can be transformed by the rule:

$$(6.3) \quad (\Phi, \Psi) \mapsto (S_1 \Phi T^{-1}, S_2 \Psi T^{-1}),$$

where $T \in \text{GL}_m(\mathbb{K})$ and $S_1, S_2 \in \text{GL}_m(\mathbb{D})$ are such that $\bar{S}_1 = \bar{S}_2$. This is precisely the matrix problem arising in the classification of maximal Cohen–Macaulay modules over the degenerate cusp $T_{23\infty} = \mathbb{k}\llbracket u, v, w \rrbracket / (u^2 + v^3 - uvw)$, see Section 5.

Example 6.6 (*Decorated chessboard*). For any $n \geq 1$ consider the set $\Sigma = \Sigma_n = \{1, \dots, n\}$ and a permutation σ of Σ . For any $\iota, j \in \Sigma$ introduce symbols $p_{\iota j}$ and $q_{\iota j}$. In what follows, we shall operate with them using the following rules:

$$(6.4) \quad p_{\iota j} p_{j l} = p_{\iota l}, q_{\iota j} q_{j l} = q_{\iota l}, p_{\iota j} q_{j l} = 0 \text{ and } q_{\iota j} p_{j l} = 0 \text{ for all } \iota, j, l \in \Sigma.$$

The category \mathcal{A} and \mathcal{A} -bimodule \mathcal{B} are defined as follows.

- $\text{Ob}(\mathcal{A}) = \Sigma$. For $1 \leq \iota < j \leq n$ we pose:

$$\mathcal{A}(\iota, j) = \mathbb{D}p_{j\iota} \oplus \mathfrak{m}q_{j\iota} \text{ and } \mathcal{A}(j, \iota) = \mathbb{D}q_{\iota j} \oplus \mathfrak{m}p_{\iota j}.$$

- For any $\iota \in \Sigma$ we put $\mathcal{A}(\iota, \iota) = \mathbb{D}1_\iota \oplus \mathfrak{m}p_{\iota\iota} \oplus \mathfrak{m}q_{\iota\iota}/I_\iota$, where I_ι is the \mathbb{D} -module generated by $t \cdot 1_\iota - t \cdot p_{\iota\iota} - t \cdot q_{\sigma(\iota)\sigma(\iota)}$.
- The composition of morphisms in \mathcal{A} is defined by \mathbb{D} -bilinearity and the multiplication rules (6.4).
- For any $\iota, j \in \Sigma$ we put $\mathcal{B}(\iota, j) = \mathbb{K} \cdot \phi_{j\iota}$.
- The action of \mathcal{A} on \mathcal{B} is given by the following rules: for any $\iota, j, l \in \Sigma$ we have

$$p_{\iota j} \phi_{j l} = \phi_{\iota l}, \phi_{\iota j} q_{j l} = \phi_{\iota l}, \phi_{\iota j} p_{j l} = 0 \text{ and } q_{\iota j} \phi_{j l} = 0.$$

The description of isomorphy classes of objects in $\text{El}(\mathcal{A}, \mathcal{B})$ leads to the following matrix problem. Let $\mathbf{d}_1, \dots, \mathbf{d}_n \in \mathbb{Z}_{\geq 0}$ and $\mathbf{d} := \mathbf{d}_1 + \dots + \mathbf{d}_n$. An object of $\text{El}(\mathcal{A}, \mathcal{B})$ is given by a matrix $W \in \text{Mat}_{\mathbf{d} \times \mathbf{d}}(\mathbb{K})$, whose rows and columns are divided into n stripes labeled by elements x_1, \dots, x_n (respectively, y_1, \dots, y_n) so that the x_i -th horizontal stripe and $y_{\sigma(i)}$ -th vertical stripe have width \mathbf{d}_i . One can transform W by the rule: $W \mapsto SWT^{-1}$, where $S, T \in \text{GL}_{\mathbf{d}}(\mathbb{D})$ satisfy the following additional constraints. Consider the division of S and T into n horizontal and vertical stripes, the same as for W . For any $\iota, j \in \Sigma$ let $S_{\iota j}$ (respectively, $T_{\iota j}$) be the corresponding block of size $\mathbf{d}_\iota \times \mathbf{d}_j$. Then

- for any $1 \leq \iota < j \leq n$ we have: $S_{\iota j} \in \text{Mat}_{\mathbf{d}_\iota \times \mathbf{d}_j}(\mathfrak{m})$ and $T_{j\iota} \in \text{Mat}_{\mathbf{d}_j \times \mathbf{d}_\iota}(\mathfrak{m})$,
- for any $\iota \in \Sigma$ we have: $\bar{S}_{\iota\iota} = \bar{T}_{\iota\iota}$.

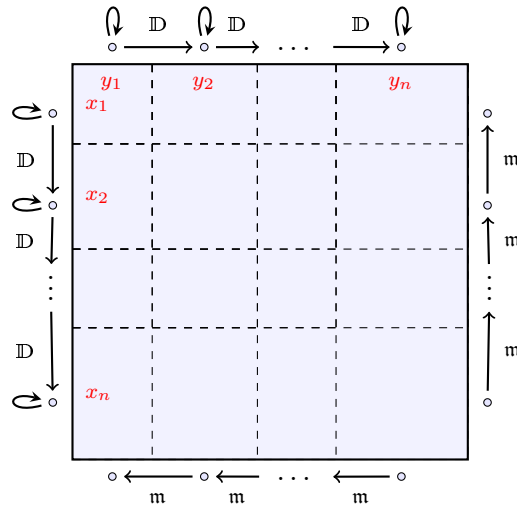

In other words, the matrix problem we obtain is the following.

- For any $1 \leq \iota \leq n$ one can perform arbitrary elementary transformations of rows of the x_ι -th stripe and columns of the $y_{\sigma(\iota)}$ -th stripe of W with coefficients in \mathbb{D} such that modulo \mathfrak{m} they are *inverse* to each other.

- For any $1 \leq i < j \leq n$ one can add any \mathbb{D} -multiple of any row of x_i -th stripe to any row of x_j -th stripe. Similarly, one can add any \mathbb{D} -multiple of any column of y_i -th stripe to any column of y_j -th stripe.
- One can perform arbitrary elementary transformations of rows and columns of W with coefficients in \mathfrak{m} .

Remark 6.7. All bimodule problems from this subsection belong to the class of representations of decorated bunches of chains, which will be introduced in the next subsection. Other (more general) examples of bimodule problems, occurring in the representation theory of finite dimensional algebras and their applications, can be found in [28, 23, 29] as well as [17, 31, 34].

6.3. Definition of a decorated bunch of chains. We start with the following combinatorial data.

- Let I be a set (usually finite or countable).
- For any $i \in I$ we have a pair of totally ordered sets (chains) \mathfrak{E}_i and \mathfrak{F}_i . All these sets are disjoint: $\mathfrak{E}_i \cap \mathfrak{E}_j = \mathfrak{F}_i \cap \mathfrak{F}_j = \emptyset$ for all $i \neq j$ and $\mathfrak{E}_i \cap \mathfrak{F}_j = \emptyset$ for all $i, j \in I$.
- We denote $\mathfrak{E} = \cup_{i \in I} \mathfrak{E}_i$, $\mathfrak{F} = \cup_{i \in I} \mathfrak{F}_i$ and $\mathfrak{X} = \mathfrak{E} \cup \mathfrak{F}$. In this way, \mathfrak{X} becomes a partially ordered set. We use the notation $x < y$ for the partial order in \mathfrak{X} . If $x, y \in \mathfrak{X}$ are such that $x \in \mathfrak{E}_i$ and $y \in \mathfrak{F}_i$ (or vice versa) for some $i \in I$ then we write $x - y$ and say that x and y are “-” related. Elements of \mathfrak{E} (respectively \mathfrak{F}) are called *row elements* (respectively *column elements*).
- Next, we have a relation \sim on \mathfrak{X} such that for any $x \in \mathfrak{X}$ there exists at most one $x' \in \mathfrak{X}$ such that $x \sim x'$. Here, we only consider irreflexive relations, i.e. $z \not\sim z$ for any $z \in \mathfrak{X}$. An element x admitting an equivalent element is called *tied*.
- Finally, we have a suborder \trianglelefteq of \leq on \mathfrak{X} which fulfils the following two conditions.
 - If $x \leq y \leq z$ in \mathfrak{X} and $x \trianglelefteq z$ then $x \trianglelefteq y$ and $y \trianglelefteq z$.
 - If $x \trianglelefteq x$ (such element is called *decorated*) and $x \sim y$ then $y \trianglelefteq y$.

Definition 6.8. The entire data $\mathfrak{X} = (I, \{\mathfrak{E}_i\}_{i \in I}, \{\mathfrak{F}_i\}_{i \in I}, \trianglelefteq, \sim)$ is called *decorated bunch of chains*. In absence of decorated elements, \mathfrak{X} is a usual bunch of chains in the sense of [9, 10], see also [17, 31, 61].

Definition 6.9. Let \mathfrak{X} be a decorated bunch of chains. Then it defines a category $\mathcal{A} = \mathcal{A}(\mathfrak{X}, \mathbb{D})$ and an \mathcal{A} -bimodule $\mathcal{B} = \mathcal{B}(\mathfrak{X}, \mathbb{D})$ in the following way.

- For any $x < y$ as well as $x \geq y$ introduce the symbol p_{yx} .
- Next, for $x, y \in \mathfrak{X}$ we introduce the following \mathbb{D} -module \mathcal{A}_{xy} :

$$\mathcal{A}_{xy} = \begin{cases} \mathbb{K}p_{yx} & \text{if } x < y \text{ and } x \not\trianglelefteq y \\ \mathbb{D}p_{yx} & \text{if } x \trianglelefteq y \\ \mathfrak{m}p_{yx} & \text{if } y \trianglelefteq x \\ 0 & \text{otherwise.} \end{cases}$$

- Now we pose $\text{Ob}(\mathcal{A}) = \tilde{\mathfrak{X}} := \mathfrak{X} / \sim$.
- The sets of morphisms in \mathcal{A} are the following \mathbb{D} -modules:

$$\mathcal{A}(a, b) = \begin{cases} \bigoplus_{x \in a, y \in b} \mathcal{A}_{xy} & \text{if } a \neq b, \\ \mathbb{K}1_a \oplus \bigoplus_{x, y \in a} \mathcal{A}_{xy} & \text{if } a = b, a \text{ is not decorated} \\ (\mathbb{D}1_a \oplus \bigoplus_{x, y \in a} \mathcal{A}_{xy}) / t(1_a - \sum_{x \in a} p_{xx}) & \text{if } a = b, a \text{ is decorated.} \end{cases}$$

- The composition of morphisms in \mathcal{A} is defined by the rule $p_{xy}p_{yz} = p_{xz}$ for any $x, y, z \in \mathfrak{X}$, all other products (if defined) are zero.

- For any $\iota \in I$, $x \in \mathfrak{E}_\iota$ and $y \in \mathfrak{F}_\iota$ introduce the symbol ϕ_{xy} and put

$$\mathcal{B}(a, b) = \bigoplus_{\substack{y \in a \cap \mathfrak{F}, \\ x \in b \cap \mathfrak{E}, \\ x \sim y}} \mathbb{K} \phi_{xy}.$$

- The action of \mathcal{A} on \mathcal{B} is given by the rules

$$\begin{cases} p_{xy} \phi_{yz} = \phi_{xz}, \\ \phi_{xy} p_{yz} = \phi_{xz}, \end{cases}$$

all other products (if defined) are zero.

In what follows, we shall use the notation $\text{Rep}(\mathfrak{X}) = \text{El}(\mathcal{A}(\mathfrak{X}, \mathbb{D}), \mathcal{B}(\mathfrak{X}, \mathbb{D}))$. \square

Example 6.10. Consider the decorated bunch of chains given by the following data.

- The index set $I = \{1, 2\}$. For $\iota \in I$ we have: $\mathfrak{F}_\iota = \{a_\iota\}$, $\mathfrak{E}_\iota = \{b_\iota, c_\iota\}$.
- We have $b_\iota \triangleleft c_\iota$ for $\iota \in I$. In particular, b_1, b_2, c_1, c_2 are decorated. The elements a_1 and a_2 are not decorated.
- We have the following equivalence relations: $a_1 \sim a_2$, $b_1 \sim b_2$ and $c_1 \sim c_2$.

This decorated bunch of chains \mathfrak{X} can be visualized by the following picture:

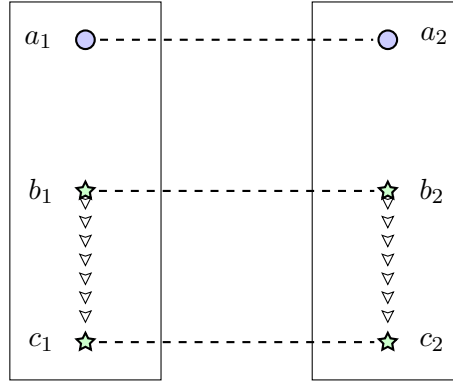

Up to an automorphism, the pair $(\mathcal{A}, \mathcal{B})$ is the one we have considered in Example 6.3. \square

Example 6.11. Let $I = \{*\}$, $\mathfrak{E}_* = \{e\}$, $\mathfrak{F}_* = \{f\}$, $e \sim f$ and e, f are both decorated. Then $\text{Rep}(\mathfrak{X})$ is the bimodule category described in Example 6.4 (decorated conjugation problem). \square

Example 6.12. Let $I = \{1, 2\}$, $\mathfrak{E}_\iota = \{x_\iota\}$ and $\mathfrak{F}_\iota = \{y_\iota\}$ for $\iota \in I$. Let x_1, x_2 be decorated and y_1, y_2 not decorated. We have: $x_1 \sim x_2$ and $y_1 \sim y_2$. Then the corresponding bimodule category $\text{Rep}(\mathfrak{X})$ is the one considered in Example 6.5 (decorated Kronecker problem). \square

Example 6.13. Let $I = \{*\}$, $\mathfrak{E}_* = \{x_1 \triangleleft \dots \triangleleft x_n \triangleleft \dots\}$, $\mathfrak{F}_* = \{y_1 \triangleright \dots \triangleright y_n \triangleright \dots\}$, $x_\iota \sim y_\iota$ for all $\iota \in \mathbb{N}$. Then $\text{Rep}(\mathfrak{X})$ is the bimodule category described in Example 6.6 (decorated chessboard). \square

We conclude this subsection stating the Krull–Schmidt property of $\text{Rep}(\mathfrak{X})$ (which is actually true for much more general class of bimodule problems).

6.4. Matrix description of the category $\text{Rep}(\mathfrak{X})$. Let $\mathfrak{X} = (I, \{\mathfrak{E}_\iota\}_{\iota \in I}, \{\mathfrak{F}_\iota\}_{\iota \in I}, \triangleleft, \sim)$ be a decorated bunch of chains. Then the bimodule category $\text{Rep}(\mathfrak{X})$ admits the following “concrete” description.

- First, we take a function $\mathbf{d} : \mathfrak{X} \rightarrow \mathbb{Z}_{\geq 0}$, $x \mapsto \mathbf{d}_x$, which has finite support and factors through the canonical projection $\mathfrak{X} \rightarrow \tilde{\mathfrak{X}}$ (i.e. $\mathbf{d}_x = \mathbf{d}_y$ if $x \sim y$).
- For any $\iota \in I$, $x \in \mathfrak{E}_\iota$ and $y \in \mathfrak{F}_\iota$ we take a matrix $W_{xy}^{(\iota)} \in \text{Mat}_{\mathbf{d}_x \times \mathbf{d}_y}(\mathbb{K})$.

Then the data $\left(\mathbf{d}, \{W_{xy}^{(\iota)}\}_{\iota \in I, (x,y) \in \mathfrak{E}_\iota \times \mathfrak{F}_\iota}\right)$ uniquely determine an object (Z, W) of $\text{Rep}(\mathfrak{X})$:

- $Z = Z_{a_1}^{\mathbf{d}_1} \oplus \dots \oplus Z_{a_n}^{\mathbf{d}_n}$, where $\tilde{\mathfrak{X}} \supseteq \{a_1, \dots, a_n\} = \text{supp}(\mathbf{d})$. Here, Z_a denotes the object of \mathcal{A}^ω corresponding to the element $a \in \tilde{\mathfrak{X}}$ and $\mathbf{d}_l := \mathbf{d}_{a_l}$ for $1 \leq l \leq n$.
- Assume that $x \in a_p \cap \mathfrak{E}_\iota$ and $y \in a_q \cap \mathfrak{F}_\iota$ for $\iota \in I$ and $1 \leq p, q \leq n$. The \mathbb{D} -module $\mathcal{B}(Z, Z)$ has a direct summand $\mathcal{B}(Z_{a_p}^{\mathbf{d}_p}, Z_{a_q}^{\mathbf{d}_q})$ and $W_{xy}^{(\iota)}$ is the corresponding entry of the element $W \in \mathcal{B}(Z, Z)$.

In these notations, the *total dimension* of (Z, W) is set to be $\dim((Z, W)) = \sum_{x \in \mathfrak{X}} \mathbf{d}_x$.

Proposition 6.14. *Let (Z, W) and (\check{Z}, \check{W}) be two objects of $\text{Rep}(\mathfrak{X})$ given by the matrix data $\left(\mathbf{d}, \{W_{xy}^{(\iota)}\}\right)$ and $\left(\check{\mathbf{d}}, \{\check{W}_{xy}^{(\iota)}\}\right)$ respectively. Then a morphism $(Z, W) \xrightarrow{h} (\check{Z}, \check{W})$ in $\text{Rep}(\mathfrak{X})$ is given by a collection of matrices $\{F_{xu}^{(\iota)}\}_{\iota \in I, x, u \in \mathfrak{E}_\iota}$, $\{G_{vy}^{(\iota)}\}_{\iota \in I, v, y \in \mathfrak{F}_\iota}$ such that*

- $F_{xu}^{(\iota)} \in \text{Mat}_{\check{\mathbf{d}}_x \times \mathbf{d}_u}(A_{xu})$ and $G_{vy}^{(\iota)} \in \text{Mat}_{\check{\mathbf{d}}_v \times \mathbf{d}_y}(A_{vy})$, where

$$A_{xu} = \begin{cases} \mathbb{K} & \text{if } u \leq x \text{ and } u \not\triangleleft x \\ \mathbb{D} & \text{if } u \triangleleft x \\ \mathfrak{m} & \text{if } x \triangleleft u \\ 0 & \text{otherwise} \end{cases}$$

and

$$B_{vy} = \begin{cases} \mathbb{K} & \text{if } y \leq v \text{ and } y \not\triangleleft v \\ \mathbb{D} & \text{if } y \triangleleft v \\ \mathfrak{m} & \text{if } v \triangleleft y \\ 0 & \text{otherwise.} \end{cases}$$

- $F_{xx} = F_{x'x'}$ (respectively $F_{xx} = G_{yy}$) if $x \sim x'$ (respectively $x \sim y$) and x is not decorated and $\bar{F}_{xx} = \bar{F}_{x'x'}$ (respectively $\bar{F}_{xx} = \bar{G}_{yy}$) if $x \sim x'$ (respectively $x \sim y$) and x is decorated;

and such that for any $\iota \in I$ and $(x, y) \in \mathfrak{E}_\iota \times \mathfrak{F}_\iota$ the following equality is true:

$$(6.5) \quad \sum_u F_{xu}^{(\iota)} W_{uy}^{(\iota)} = \sum_v \check{W}_{xv}^{(\iota)} G_{vy}^{(\iota)}.$$

The matrices $\left(\{\check{F}_{xu}^{(\iota)}\}, \{\check{G}_{vy}^{(\iota)}\}\right)$ corresponding to the composition $\tilde{h} \circ h$ of $h = \left(\{F_{xu}^{(\iota)}\}, \{G_{vy}^{(\iota)}\}\right)$ and $\tilde{h} = \left(\{\check{F}_{xu}^{(\iota)}\}, \{\check{G}_{vy}^{(\iota)}\}\right)$ are given by the usual matrix product:

$$\check{F}_{xu}^{(\iota)} = \sum_{c \in \mathfrak{E}_\iota} \check{F}_{xc}^{(\iota)} F_{cu}^{(\iota)} \quad \text{and} \quad \check{G}_{vy}^{(\iota)} = \sum_{c \in \mathfrak{F}_\iota} \check{G}_{vc}^{(\iota)} G_{cy}^{(\iota)}.$$

Proof. It is a straightforward computation, analogous to the one made in Example 6.3. \square

Remark 6.15. “Directedness” of \mathcal{A} implies that a morphism $h = \left(\{F_{xu}^{(\iota)}\}, \{G_{vy}^{(\iota)}\}\right)$ is an isomorphism if and only if all diagonal blocks $F_{xx}^{(\iota)}$ and $G_{yy}^{(\iota)}$ are invertible.

Definition 6.16. Let $X = (Z, W)$ and $\tilde{X} = (\tilde{Z}, \tilde{W})$ be two objects of $\text{Rep}(\mathfrak{X})$. Consider the following \mathbb{D} -module: $\mathcal{I}(X, \tilde{X}) := \text{Rep}(\mathfrak{X})(X, \tilde{X}) \cap \text{rad}(\mathcal{A}(Z, \tilde{Z}))$. Then \mathcal{I} is an ideal in the category $\text{Rep}(\mathfrak{X})$. The quotient category $\underline{\text{Rep}}(\mathfrak{X}) := \text{Rep}(\mathfrak{X})/\mathcal{I}$ is called *stabilized bimodule category*.

Remark 6.17. Since $\mathcal{I}(X, \tilde{X}) \subseteq \text{rad}(\text{Rep}(\mathfrak{X})(X, \tilde{X}))$, the projection functor

$$\text{Rep}(\mathfrak{X}) \xrightarrow{\Pi} \underline{\text{Rep}}(\mathfrak{X})$$

preserves indecomposability and isomorphism classes of objects. Let $h, \hat{h} \in \text{Hom}_{\mathfrak{X}}(X, \tilde{X})$ be given by $h = \left(\{F_{xu}^{(i)}\}, \{G_{vy}^{(i)}\} \right)$ and $\hat{h} = \left(\{\hat{F}_{xu}^{(i)}\}, \{\hat{G}_{vy}^{(i)}\} \right)$. Then $h - \hat{h} \in \mathcal{I}(X, \tilde{X})$ if and only if $F_{xx}^{(i)} \simeq \hat{F}_{xx}^{(i)}$ and $G_{yy}^{(i)} \simeq \hat{G}_{yy}^{(i)}$ for all $i \in I$, $x \in \mathfrak{E}_i$ and $y \in \mathfrak{F}_i$, where \simeq means equality if x (respectively y) is not decorated and equality modulo \mathfrak{m} if x (respectively y) is decorated.

6.5. Strings and Bands. Let \mathfrak{X} be a decorated bunch of chains. To present a description of the isomorphism classes of indecomposable objects of $\text{Rep}(\mathfrak{X})$, we use the combinatorics of *strings and bands*, just as for “usual” (non-decorated) bunches of chains [10].

1. We define an \mathfrak{X} -word as a sequence $w = x_1 r_1 \dots x_{l-1} r_{l-1} x_l$, where $x_i \in \mathfrak{X}$, $r_i \in \{\sim, -\}$ and the following conditions hold:

- $x_i r_i x_{i+1}$ in \mathfrak{X} for each $i \in \{1, 2, \dots, l-1\}$.
- $r_i \neq r_{i+1}$ for each $i \in \{1, 2, \dots, l-2\}$.
- If x_1 is tied, then $r_1 = \sim$, and if x_l is tied, then $r_{l-1} = \sim$.

We call l the *length* of the word w and denote it by $l(w)$. We also denote $\tau(w) = \{i \mid 1 \leq i < l, r_i = -\}$. The word w is said to be *decorable* if at least one of the letters x_1, x_2, \dots, x_l is decorated.

2. A *decoration* of a *decorable* word w is a function $\rho : \tau(w) \rightarrow \mathbb{Z}$. A (unique) decoration of a *non-decorable* word is, by definition, the constant function $\rho : \tau(w) \rightarrow \{0\}$.

3. Two decorations $\rho, \rho' : \tau(w) \rightarrow \mathbb{Z}$ of a *decorable* word w are said to be *neighbour* if there is an index $i \in \tau(w)$ and an integer k such that $x_i \not\sim x_{i+1}$ and

- either x_i is not decorated, $\rho'(i) = \rho(i) + k$ and, if $i > 2$, also $\rho'(i-2) = \rho(i-2) - (-1)^{\sigma(x_i, x_{i-1})} k$, where $\sigma(x, y) = 1$ if both x, y are either row or column labels and $\sigma(x, y) = 0$ if one of them is a row label and the other is a column label.
- or x_{i+1} is not decorated, $\rho'(i) = \rho(i) + k$, and, if $i < n-2$, also $\rho'(i+2) = \rho(i+2) - (-1)^{\sigma(x_{i+1}, x_{i+2})} k$.

Two decorations ρ, ρ' are said to be *equivalent* if there is a sequence of decorations $\rho = \rho_1, \rho_2, \dots, \rho_r = \rho'$ such that ρ_i and ρ_{i+1} are neighbour for $1 \leq i < r$.

4. We denote by w^* the *inverse word* to w , i.e. the word $w^* = x_l r_{l-1} x_{l-1} \dots r_2 x_2 r_1 x_1$. If ρ is a decoration of w , we define the decoration ρ^* of w^* setting $\rho^*(i) = \rho(l-i)$.

5. An \mathfrak{X} -word w of length l is called *cyclic* if $r_1 = r_{l-1} = \sim$ and $x_l - x_1$ in \mathfrak{X} . For such a cyclic word we set $r_l = -$ and define x_i, r_i for all $i \in \mathbb{Z}$ setting $x_{i+ql} = x_i$, $r_{i+ql} = r_i$ for any $q \in \mathbb{Z}$. In particular, $x_0 = x_l$ and $r_0 = -$. Note that the length of a cyclic word is always even. We also set $\tau^+(w) = \tau(w) \cup \{l\}$.

5. A *cyclic decoration* of a *decorable* cyclic word w is a function $\rho : \tau^+(w) \rightarrow \mathbb{Z}$. For such a function we set $\rho(i+ql) = \rho(i)$ for any $q \in \mathbb{Z}$. A (unique) cyclic decoration of a *non-decorable* cyclic word w is, by definition, the constant function $\rho : \tau^+(w) \rightarrow \{0\}$.

6. If w is a cyclic word, we define its k -*shift* as the word

$$w^{(k)} = x_{2k+1}r_{2k+1}r_{2k+2} \cdots x_{2k-1}r_{2k-1}x_{2k}$$

and write

$$(6.6) \quad \sigma(k, w) = \sum_{j=1}^k \sigma(x_{2j-1}, x_{2j}).$$

If ρ is a cyclic decoration of w , we define the cyclic decoration $\rho^{(k)}$ of $w^{(k)}$ setting $\rho^{(k)}(i) = \rho(i - 2k)$.

7. We call a pair (w, ρ) , where w is a cyclic word of length l and ρ is its cyclic decoration, *periodic* if $w^{(k)} = w$ and $\rho^{(k)} = \rho$ for some $k < l/2$.

8. Two cyclic decorations $\rho, \rho' : \tau^+(w) \rightarrow \mathbb{Z}$ of a decorated cyclic word are said to be *neighbour* if there is an index $i \in \tau^+(w)$ and an integer k such that $x_i \not\sim x_{i+1}$ and

- either x_i is not decorated,

$$\rho'(i) = \rho(i) + k \text{ and } \rho'(i - 2) = \rho(i - 2) - (-1)^{\sigma(x_i, x_{i-1})}k,$$

- or x_{i+1} is not decorated,

$$\rho'(i) = \rho(i) + k \text{ and } \rho'(i + 2) = \rho(i + 2) - (-1)^{\sigma(x_{i+1}, x_{i+2})}k.$$

Two cyclic decorations ρ, ρ' are said to be *equivalent* if there is a sequence of cyclic decorations $\rho = \rho_1, \rho_2, \dots, \rho_r = \rho'$ such that ρ_i and ρ_{i+1} are neighbour for $1 \leq i < r$.

9. A pair (w, ρ) , where w is a (cyclic) word and ρ is its (cyclic) decoration, is called a *decorated (cyclic) word*. Two decorated cyclic words (w, ρ) and (w', ρ') are said to be *equivalent* if $w = w'$ and the decorations ρ and ρ' are equivalent.

10. A \sim -*subword* of a word w is its subword v of the form $x \sim y$ or of the form x if $x \approx y$ for any $y \neq x$. We denote by $|x|$ the class of x with respect to \sim and by $[w]$ the set of all \sim -subwords of w . Note that if w is cyclic, every its \sim -subword is of the form $x \sim y$. Thus any word has the form $v_1 - v_2 - \cdots - v_n$, where v_1, v_2, \dots, v_n are its \sim -subwords. If it is cyclic, then $w^{(k)} = v_{k+1} - v_{k+2} - \cdots - v_{k-1} - v_k$. A decoration of the word w is given by the sequence $\nu = (\nu_1, \nu_2, \dots, \nu_{n-1})$ of its values and written as $v_1 \overset{\nu_1}{-} v_2 \overset{\nu_2}{-} \cdots \overset{\nu_{n-1}}{-} v_n$. A cyclic decoration is given by the sequence of its values $\nu = (\nu_1, \nu_2, \dots, \nu_n)$ and written as $\leftarrow v_1 \overset{\nu_1}{-} v_2 \overset{\nu_2}{-} \cdots \overset{\nu_{n-1}}{-} v_n \overset{\nu_n}{-} \rightarrow$. \square

Now we introduce the following objects of the bimodule category $\text{Rep}(\mathfrak{X})$.

Definition 6.18 (Strings). Let w be an \mathfrak{X} -word, $\rho : \tau(w) \rightarrow \mathbb{Z}$ be its decoration. The *string representation* $S(w, \rho) = (Z, S)$ is defined as follows:

- $Z = \bigoplus_{v \in [w]} Z_{|v|}$ and $S \in \mathcal{B}(Z, Z)$.
- Suppose that the decorated word (w, ρ) has a subword $v_i \overset{\nu_i}{-} v_{i+1}$ for some $v_i, v_{i+1} \in [w]$. Then $\mathcal{B}(Z, Z)$ has a direct summand $\mathcal{B}(Z_{|v_{i+1}|}, Z_{|v_i|}) \oplus \mathcal{B}(Z_{|v_i|}, Z_{|v_{i+1}|})$ and we define the corresponding component of S as
 - $t^{\nu_i} \phi_{v_{i+1}v_i} \in \mathcal{B}(Z_{|v_i|}, Z_{|v_{i+1}|})$ if $v_{i+1} \in \mathfrak{E}$ and $v_i \in \mathfrak{F}$,
 - $t^{\nu_i} \phi_{v_i v_{i+1}} \in \mathcal{B}(Z_{|v_{i+1}|}, Z_{|v_i|})$ if $v_i \in \mathfrak{E}$ and $v_{i+1} \in \mathfrak{F}$.
- All other components of S are set to be zero.

Definition 6.19 (Bands). Let w be a cyclic \mathfrak{X} -word of length $l = 2n$, $\rho : \tau^+(w) \rightarrow \mathbb{Z}$ be its cyclic decoration, such that the decorated word (w, ρ) is not equivalent to any periodic one, $m \in \mathbb{N}$ and $\pi = \pi(\xi) \neq \xi$ be an irreducible polynomial of degree d from $\mathbb{k}[\xi]$ if w is decorable and over $\mathbb{K}[\xi]$ if w is not decorable. If w is not decorable, denote by $F = F(\pi^m) \in \text{Mat}_{dm \times dm}(\mathbb{K})$ the Frobenius block corresponding to the polynomial π^m . If w is decorable, denote by F a matrix from $\text{Mat}_{dm \times dm}(\mathbb{D})$ such that its image in $\text{Mat}_{dm \times dm}(\mathbb{k})$ is the Frobenius block corresponding to π^m . The *band representation* $B((w, \rho), m, \pi) = (Z, B)$ is defined as follows:

- $Z = \bigoplus_{v \in [w]} Z_{|v|}^{\oplus dm}$ and $B \in \mathcal{B}(Z, Z)$.
- Suppose that the decorated cyclic word (w, ρ) has a subword $v_i \overset{\nu_i}{\sim} v_{i+1}$, where $v_i, v_{i+1} \in [w]$, $1 \leq i < n$. Then $\mathcal{B}(Z, Z)$ has a direct summand

$$\mathcal{B}(Z_{|v_{i+1}|}^{\oplus dm}, Z_{|v_i|}^{\oplus dm}) \oplus \mathcal{B}(Z_{|v_i|}^{\oplus dm}, Z_{|v_{i+1}|}^{\oplus dm})$$

and we define the corresponding component of B as follows:

- $t^{\nu_i} \phi_{v_{i+1}v_i} I \in \mathcal{B}(Z_{|v_i|}^{\oplus dm}, Z_{|v_{i+1}|}^{\oplus dm})$ if $v_i \in \mathfrak{F}$ and $v_{i+1} \in \mathfrak{E}$,
- $t^{\nu_i} \phi_{v_i v_{i+1}} I \in \mathcal{B}(Z_{|v_{i+1}|}^{\oplus dm}, Z_{|v_i|}^{\oplus dm})$ if $v_{i+1} \in \mathfrak{F}$ and $v_i \in \mathfrak{E}$,

where I is the identity $dm \times dm$ matrix.

- The component of B corresponding to the direct summand

$$\mathcal{B}(Z_{|v_1|}^{\oplus dm}, Z_{|v_n|}^{\oplus dm}) \oplus \mathcal{B}(Z_{|v_n|}^{\oplus dm}, Z_{|v_1|}^{\oplus dm})$$

of $\mathcal{B}(Z, Z)$ is defined as

- $t^{\nu_n} \phi_{v_1 v_n} F \in \mathcal{B}(Z_{|v_n|}^{\oplus dm}, Z_{|v_1|}^{\oplus dm})$ if $v_n \in \mathfrak{F}$ and $v_1 \in \mathfrak{E}$,
- $t^{\nu_n} \phi_{v_n v_1} F \in \mathcal{B}(Z_{|v_1|}^{\oplus dm}, Z_{|v_n|}^{\oplus dm})$ if $v_1 \in \mathfrak{F}$ and $v_n \in \mathfrak{E}$.

- All other components of B are zero.

Example 6.20. Consider the decorated bunch of chains \mathfrak{X} introduced in Example 6.10. Let $a \in \tilde{\mathfrak{X}}$ (respectively $b, c \in \tilde{\mathfrak{X}}$) be the equivalences class of $a_1, a_2 \in \mathfrak{X}$ (respectively, $b_1, b_2; c_1, c_2 \in \mathfrak{X}$). Consider the following decorated cyclic word:

$$(w, \rho) := \leftarrow a_1 \sim a_2 \overset{l_1}{\sim} b_2 \sim b_1 \overset{l_2}{\sim} a_1 \sim a_2 \overset{l_3}{\sim} c_2 \sim c_1 \overset{l_4}{\sim} a_1 \sim a_2 \overset{l_5}{\sim} b_2 \sim b_1 \overset{l_6}{\rightarrow}$$

Let $m \in \mathbb{N}$ and $\xi \neq \pi \in \mathbb{k}[\xi]$ an irreducible polynomial of degree d . Then the band object $B((w, \rho), m, \pi)$ is given by the canonical form

$$\begin{array}{c} \begin{array}{c} a_1 \\ \Phi_1 = \\ \Psi_1 = \end{array} \begin{array}{|c|c|c|} \hline 0 & t^{l_2} I & 0 \\ \hline t^{l_6} F & 0 & 0 \\ \hline 0 & 0 & t^{l_4} I \\ \hline \end{array} \begin{array}{c} b_1 \\ b_2 \\ c_1 \\ c_2 \end{array} \begin{array}{c} a_2 \\ \Phi_2 = \\ \Psi_2 = \end{array} \begin{array}{|c|c|c|} \hline t^{l_1} I & 0 & 0 \\ \hline 0 & 0 & t^{l_2} I \\ \hline 0 & t^{l_3} I & 0 \\ \hline \end{array} \end{array}$$

In the language of bimodule problems, $B((w, \rho), m, \pi)$ is given by the pair (Z, B) , where

$$Z = Z_a^{\oplus dm} \oplus Z_b^{\oplus dm} \oplus Z_a^{\oplus dm} \oplus Z_c^{\oplus dm} \oplus Z_a^{\oplus dm} \oplus Z_b^{\oplus dm}$$

and $B \in \mathcal{B}(Z, Z)$ is given by the following matrix

	a	b	a	c	a	b
a	0	0	0	0	0	0
b	$t^{l_2}\phi_2I$	0	$t^{l_2}\phi_1I$	0	0	0
a	0	0	0	0	0	0
c	0	0	$t^{l_3}\psi_2I$	0	$t^{l_4}\psi_1I$	0
a	0	0	0	0	0	0
b	$t^{l_6}\phi_1F$	0	0	0	$t^{l_5}\phi_2I$	0

where I is the identity matrix of size $dm \times dm$ and F is the Frobenius block of π^m .

7. REPRESENTATIONS OF DECORATED BUNCHES OF CHAINS–II

The goal of this sections is to prove the following result.

Theorem 7.1. *Let \mathfrak{X} be a decorated bunch of chains. Then the description of indecomposable objects of $\text{Rep}(\mathfrak{X})$ is the following.*

- Every string or band representation is indecomposable and every indecomposable object of $\text{Rep}(\mathfrak{X})$ is isomorphic to some string or band representation.
- Any string representation is not isomorphic to any band representation.
- Two string representations $S(w, \rho)$ and $S(w', \rho')$ are isomorphic if and only if either $w = w'$ and ρ and ρ' are equivalent, or $w' = w^*$ and the functions ρ^* and ρ' are equivalent.
- The isomorphism class of a band representation $B((w, \rho), m, \pi)$ with decorable w does not depend on the choice of the matrix $F(\pi^m)$.
- Two band representations $B((w, \rho), m, \pi)$ and $B((w', \rho'), m', \pi')$ are isomorphic if and only if either $w' = w^{(k)}$, $m' = m$, $\pi' = \tilde{\pi}_{k,w}$ and ρ' is equivalent to $\rho^{(k)}$ for some k , or $w' = w^{(k)*}$, $m' = m$, $\pi' = \tilde{\pi}_{k,w}$ and ρ' is equivalent to $\rho^{(k)*}$ for some k , where

$$\tilde{\pi}_{k,w}(\xi) = \begin{cases} \pi(\xi) & \text{if } \sigma(k, w) \text{ is even,} \\ \xi^{\deg(\pi)}\pi(1/\xi) & \text{if } \sigma(k, w) \text{ is odd,} \end{cases}$$

see (6.6) for the definition of the function $\sigma(k, w)$ above.

A special case of this result (decorated chessboard problem) is treated in details in Section 14. This problem is notationally easier to handle, being at the same time an important

ingredient of the proof of general result. So an interested reader is advised to look at the proof of Theorem 14.3 first.

Remark 7.2. It is obvious that any $Y \in \text{Ob}(\text{Rep}(\mathfrak{X}))$ admits a direct sum decomposition

$$Y \cong Y_1^{\oplus m_1} \oplus \cdots \oplus Y_t^{\oplus m_t}$$

with Y_1, \dots, Y_t indecomposable and pairwise non-isomorphic. It follows from the proof of Theorem 7.1 that the endomorphism ring of an indecomposable object of $\text{Rep}(\mathfrak{X})$ is local. According to [7, Chapter I.3.6], the category $\text{Rep}(\mathfrak{X})$ has Krull-Schmidt property, i.e. the set $\{(Y_1, m_1), \dots, (Y_t, m_t)\}$ is uniquely determined by Y (up to isomorphisms of indecomposable summands).

7.1. Idea of the proof. In what follows we use the notation of Subsection 6.4. Let $(Z, W) = (\mathfrak{d}, \{W^{(\iota)}\}_{uv})$ be an object of $\text{Rep}(\mathfrak{X})$. Replacing if necessary, \mathfrak{X} by $\mathfrak{X} \cap \text{supp}(\mathfrak{d})$, we may without loss of generality assume \mathfrak{X} is a finite set. We follow the following convention: if $\mathfrak{E}_i = \{a_1 < \cdots < a_r\}$ and $\mathfrak{F}_i = \{b_1 > \cdots > b_s\}$ then we write the matrix $W^{(\iota)}$ as follows:

$$\begin{array}{c} \begin{array}{cccc} & b_1 & b_2 & \dots & b_s \\ a_1 & \square & \square & \square & \square \\ a_2 & \square & \square & \square & \square \\ \vdots & \square & \square & \square & \square \\ a_r & \square & \square & \square & \square \end{array} \\ \begin{array}{c} \downarrow \\ \downarrow \\ \downarrow \\ \downarrow \end{array} \\ \begin{array}{c} \leftarrow \\ \leftarrow \\ \leftarrow \\ \leftarrow \end{array} \end{array}$$

For $\iota \in I$ we say that $\vec{x} = \{x_1, \dots, x_m\} \subseteq \mathfrak{E}_i$ (respectively, $\vec{y} = \{y_1, \dots, y_m\} \subseteq \mathfrak{F}_i$) is a *maximal elementary subchain* if either $\vec{x} = \{x\}$ and x is not decorated or $x_1 \triangleleft \cdots \triangleleft x_m$ and \vec{x} is maximal with respect to this property. In the latter case we say \vec{x} is decorated. Maximal elementary subchains inherit $<$ ordering from \mathfrak{X} , thus both sets \mathfrak{E}_i and \mathfrak{F}_i split into a union of such subchains. On the set of pairs

$$\mathcal{B}_i := \{(\vec{x}, \vec{y}) \mid \vec{x} \text{ and } \vec{y} \text{ are maximal elementary subchains in } \mathfrak{E}_i, \text{ respectively in } \mathfrak{F}_i\}$$

we introduce the following total ordering: $(\vec{u}, \vec{v}) < (\vec{x}, \vec{y})$ if either $\vec{u} < \vec{x}$ or $\vec{u} = \vec{x}$ and $\vec{v} > \vec{y}$. In the next, we shall use the notation $(\mathfrak{d}, \{W^{(\iota)}\}_{\vec{x}\vec{y}})$ for an object (Z, W) of $\text{Rep}(\mathfrak{X})$. A morphism $(Z, W) \xrightarrow{h} (\check{Z}, \check{W})$ in $\text{Rep}(\mathfrak{X})$ is given by a collection of matrices $F = \{F_{\vec{u}\vec{x}}^{(\iota)}\}$ and $G = \{G_{\vec{y}\vec{v}}^{(\iota)}\}$ satisfying the equality

$$(7.1) \quad \sum_{\vec{u} \subseteq \mathfrak{E}_i} F_{\vec{x}\vec{u}}^{(\iota)} W_{\vec{u}\vec{y}}^{(\iota)} = \sum_{\vec{v} \subseteq \mathfrak{F}_i} \check{W}_{\vec{x}\vec{v}}^{(\iota)} G_{\vec{v}\vec{y}}^{(\iota)}$$

for any $\iota \in I$ and $(\vec{x}, \vec{y}) \in \mathcal{B}_i$, as well as some additional constraints on diagonal blocks described in Proposition 6.14. Note that $F_{\vec{x}\vec{u}}^{(\iota)} = 0$ (respectively $G_{\vec{v}\vec{y}}^{(\iota)} = 0$) for all $\vec{x} < \vec{u}$ (respectively $\vec{v} < \vec{y}$). In particular, equation (7.1) takes the form

$$(7.2) \quad \sum_{\vec{u} < \vec{x}} F_{\vec{x}\vec{u}}^{(\iota)} W_{\vec{u}\vec{y}}^{(\iota)} + F_{\vec{x}\vec{x}}^{(\iota)} W_{\vec{x}\vec{y}}^{(\iota)} = \sum_{\vec{v} < \vec{y}} \check{W}_{\vec{x}\vec{v}}^{(\iota)} G_{\vec{v}\vec{y}}^{(\iota)} + \check{W}_{\vec{x}\vec{y}}^{(\iota)} G_{\vec{y}\vec{y}}^{(\iota)}.$$

Next, observe that for $\vec{x} = \{x_1 \triangleleft \cdots \triangleleft x_m\} \subseteq \mathfrak{E}_i$ the diagonal block $F_{\vec{x}\vec{x}}^{(i)}$ of $F^{(i)}$ splits further into subblocks $F_{x_p x_q}^{(i)}$ of size $\mathbf{d}_{x_p} \times \mathbf{d}_{x_q}$ with coefficients in \mathbb{D} for $1 \leq q \leq p \leq m$ and \mathbf{m} for $1 \leq p < q \leq m$. A similar statement holds for the diagonal blocks $G_{\vec{y}\vec{y}}$ of the matrix $G^{(i)}$ for any decorated maximal elementary subchain $\vec{y} \subseteq \mathfrak{F}_i$.

For $(\vec{x}, \vec{y}) \in \mathcal{B}_i$ consider the following full subcategory of $\text{Rep}(\mathfrak{X})$:

$$(7.3) \quad \text{Ob}(\text{Rep}^{\leq(\vec{x}, \vec{y})}(\mathfrak{X})) := \left\{ (Z, W) \mid W_{\vec{u}\vec{v}}^{(i)} = 0 \text{ for } (\vec{u}, \vec{v}) < (\vec{x}, \vec{y}) \right\}.$$

In a similar way, we define $\text{Ob}(\text{Rep}^{<(\vec{x}, \vec{y})}(\mathfrak{X})) := \left\{ (Z, W) \mid W_{\vec{u}\vec{v}}^{(i)} = 0 \text{ for } (\vec{u}, \vec{v}) \leq (\vec{x}, \vec{y}) \right\}$. If

(Z, W) and (\check{Z}, \check{W}) both belong to $\text{Rep}^{\leq(\vec{x}, \vec{y})}(\mathfrak{X})$ and $(Z, W) \xrightarrow{(F, G)} (\check{Z}, \check{W})$ is a morphism then (7.2) implies that

$$(7.4) \quad F_{\vec{x}\vec{x}}^{(i)} W_{\vec{x}\vec{y}}^{(i)} = \check{W}_{\vec{x}\vec{y}}^{(i)} G_{\vec{y}\vec{y}}^{(i)}.$$

Let $\mathfrak{X}_{(\vec{x}, \vec{y})}$ be the decorated bunch of chains obtained by restriction of \mathfrak{X} on (\vec{x}, \vec{y}) . Equality (7.4) implies that we have the forgetful functor

$$(7.5) \quad \text{Rep}^{\leq(\vec{x}, \vec{y})}(\mathfrak{X}) \longrightarrow \text{Rep}(\mathfrak{X}_{(\vec{x}, \vec{y})}), \quad (Z, W) \mapsto W_{\vec{x}\vec{y}}^{(i)}.$$

Now we are ready to present the main steps of the proof of Theorem 7.1.

- Any object (Z, W) of $\text{Rep}(\mathfrak{X})$ belongs to some subcategory $\text{Rep}^{\leq(\vec{x}, \vec{y})}(\mathfrak{X})$ such that the component $W_{\vec{x}\vec{y}}^{(i)}$ is not zero for some $i \in I$, $\vec{x} \subseteq \mathfrak{E}_i$ and $\vec{y} \subseteq \mathfrak{F}_i$.

	\vec{y}				
	0	0	0	0	0
\vec{x}	0				
	0				

For simplicity we assume here that \vec{x} or \vec{y} is not decorated, otherwise the treatment requires additional notations.

- We bring the matrix $W_{\vec{x}\vec{y}}^{(i)}$, viewed as object of $\text{Rep}(\mathfrak{X}_{(\vec{x}, \vec{y})})$, into a *normal form*. Then we transform the entire object (Z, W) into a *standard form*. If $\text{Rep}_{\text{st}}^{\leq(\vec{x}, \vec{y})}(\mathfrak{X})$ is the full subcategory of *standard objects* (i.e. objects in the standard form) then the embedding $\text{Rep}_{\text{st}}^{\leq(\vec{x}, \vec{y})}(\mathfrak{X}) \hookrightarrow \text{Rep}^{\leq(\vec{x}, \vec{y})}(\mathfrak{X})$ is an equivalence of categories.
- In some cases (e.g. if all elements of \vec{x} and \vec{y} are untied, or if $\vec{x} = \{x\}$, $\vec{y} = \{y\}$ and $x \sim y$), certain direct summands of $W_{\vec{x}\vec{y}}^{(i)}$ viewed as objects of $\text{Rep}(\mathfrak{X}_{(\vec{x}, \vec{y})})$ split up globally as direct summands of (Z, W) in $\text{Rep}(\mathfrak{X})$. Denoting $\text{Rep}_{\text{st}}^{\leq(\vec{x}, \vec{y}), \circ}(\mathfrak{X})$ the full subcategory of $\text{Rep}_{\text{st}}^{\leq(\vec{x}, \vec{y})}(\mathfrak{X})$ consisting of standard objects without such direct summands, we construct a *new bunch of chains* $\mathfrak{X}^{[\vec{x}, \vec{y}]}$ and a *reduction functor* between the stabilized categories

$$(7.6) \quad R^{\vec{x}\vec{y}} : \underline{\text{Rep}}_{\text{st}}^{\leq(\vec{x}, \vec{y}), \circ}(\mathfrak{X}) \longrightarrow \underline{\text{Rep}}^{<(\vec{x}, \vec{y})}(\mathfrak{X}^{[\vec{x}, \vec{y}]})$$

The new bunch of chains $\mathfrak{X}^{[\vec{x}, \vec{y}]}$ is constructed from \mathfrak{X} using an explicit computation of the automorphism group of a “general” object in the category $\text{Rep}(\mathfrak{X}_{(\vec{x}, \vec{y})})$.

- The entire sequence of categories and functors introduced above can be summarized as follows:

$$\underline{\text{Rep}}(\mathfrak{X}) \leftrightarrow \underline{\text{Rep}}^{\leq(\vec{x}, \vec{y})}(\mathfrak{X}) \leftrightarrow \underline{\text{Rep}}^{\leq(\vec{x}, \vec{y}), \circ}(\mathfrak{X}) \xrightarrow{\cong} \underline{\text{Rep}}_{\text{st}}^{\leq(\vec{x}, \vec{y}), \circ}(\mathfrak{X}) \xrightarrow{R^{\vec{x}\vec{y}}} \underline{\text{Rep}}^{<(\vec{x}, \vec{y})}(\mathfrak{X}^{[\vec{x}, \vec{y}]})$$

The reduction functor $R^{\vec{x}\vec{y}}$ is a *representation equivalence* of categories, i.e.

- $R^{\vec{x}\vec{y}}$ is essentially surjective,
- $R^{\vec{x}\vec{y}}((Z, W)) \cong R^{\vec{x}\vec{y}}((Z', W'))$ if and only if $(Z, W) \cong (Z', W')$.

These two properties imply that $R^{\vec{x}\vec{y}}$ maps indecomposable objects to indecomposable ones. Moreover, $R^{\vec{x}\vec{y}}$ reduces the total dimension of objects, what allows to use induction arguments.

- For any band datum $((w, \rho), m, \pi)$ and string datum (v, ν) in \mathfrak{X} we have isomorphisms:

$$(7.7) \quad R^{\vec{x}\vec{y}}\left(B((w, \rho), m, \pi)\right) \cong B((\hat{w}, \hat{\rho}), m, \pi) \quad \text{and} \quad R^{\vec{x}\vec{y}}(S(v, \nu)) \cong S(\hat{v}, \hat{\nu})$$

for appropriate decorated (cyclic) words $(\hat{w}, \hat{\rho})$ and $(\hat{v}, \hat{\nu})$. Moreover, the pair (w, ρ) (respectively (v, ν)) can be uniquely recovered from $(\hat{w}, \hat{\rho})$ (respectively $(\hat{v}, \hat{\nu})$).

7.2. Reduction Cases. In this subsection we give a proof of Theorem 7.1. To simplify the notation, we keep the index $i \in I$ fixed, so it is no longer mentioned when referring for blocks of the matrix $W^{(i)}$ of an object (Z, W) of the category $\text{Rep}^{\leq(\vec{x}, \vec{y})}(\mathfrak{X})$ for $\vec{x} \times \vec{y} \subseteq \mathfrak{E}_i \times \mathfrak{F}_i$.

Case 1. We start with the case $\vec{x} = \{x\}$ and $\vec{y} = \{y\}$, where both x and y are not decorated. Note that $\mathfrak{X}_{(\vec{x}, \vec{y})}$ is a usual (non-decorated) bunch of chains over the field \mathbb{K} .

Case 1a. Assume first that $x \not\sim y$. Let (Z, W) be an object of $\text{Rep}^{\leq(\vec{x}, \vec{y})}(\mathfrak{X})$. In the category $\text{Rep}(\mathfrak{X}_{(\vec{x}, \vec{y})})$ we have an isomorphism:

$$W_{\vec{x}\vec{y}} \cong U := \begin{pmatrix} 0 & 0 \\ 0 & I \end{pmatrix}.$$

If both x and y are untied, then any string $S(x - y)$ splits as a direct summand of (Z, W) . The complement of such strings belongs to the subcategory $\text{Rep}^{<(\vec{x}, \vec{y})}(\mathfrak{X})$. So, from now on we assume that at least one element of $\{x, y\}$ is tied. A straightforward computation shows that

$$\text{End}_{\mathfrak{X}_{(\vec{x}, \vec{y})}}(U) = \left\{ \begin{pmatrix} A & 0 \\ B & C \end{pmatrix}, \begin{pmatrix} D & F \\ 0 & C \end{pmatrix} \right\},$$

where A, B, C, D, F are arbitrary matrices of appropriate size (determined by U) with coefficients in the field \mathbb{K} . The new decorated bunch of chains $\mathfrak{X}^{[\vec{x}, \vec{y}]}$ is defined as follows.

- If $x \sim \tilde{x}$ for some $\tilde{x} \in \mathfrak{X}_j, j \in I$ then we add a new element \tilde{x}_y to \mathfrak{X}_j . We have $a < \tilde{x}_y < b$ in $\mathfrak{X}_j^{[\vec{x}, \vec{y}]}$, whenever $a < \tilde{x} < b$ in \mathfrak{X}_j . Moreover, $\tilde{x} < \tilde{x}_y$.
- Similarly, if $y \sim \tilde{y}$ for some $\tilde{y} \in \mathfrak{X}_\sigma$ then we add to \mathfrak{X}_σ a new element \tilde{y}_x . As above, \tilde{y}_x inherits all order relations from its parent element \tilde{y} . Moreover, $\tilde{y} > \tilde{y}_x$.
- If both x and y are tied then we additionally impose: $\tilde{x}_y \sim \tilde{y}_x$.

The admissible transformations of (Z, W) (i.e. those automorphisms which preserve the reduced form of $W_{\vec{x}\vec{y}}$) are shown in the following picture:

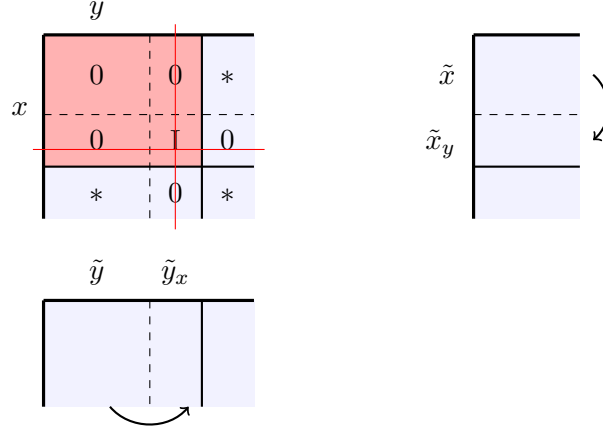

A more formal way to explain the reduction procedure is the following. Crossing–Out Lemma 14.9 implies that we have a representation equivalence (7.6). Note that in this case $\text{Rep}^{\leq(\vec{x},\vec{y})}(\mathfrak{X}) = \text{Rep}^{\leq(\vec{x},\vec{y}),\circ}(\mathfrak{X})$. The correspondence (7.7) is given by the rule

$$u \overset{\alpha}{-} \tilde{x}_y \sim \tilde{y}_x \overset{\beta}{-} v \mapsto u \overset{\alpha}{-} \tilde{x} \sim x \overset{0}{-} y \sim \tilde{y} \overset{\beta}{-} v.$$

If only one element (e.g. x) is tied then the translation rule is analogous:

$$\tilde{x}_y \overset{\gamma}{-} z \mapsto y \overset{0}{-} x \sim \tilde{x} \overset{\gamma}{-} z.$$

Case 1b. Assume now that $x \sim y$. First observe that in $\text{Rep}(\mathfrak{X}_{(\vec{x},\vec{y})})$ we have:

$$W_{\vec{x}\vec{y}} \cong \begin{pmatrix} F & 0 \\ 0 & N \end{pmatrix},$$

where F is an invertible matrix and N is a nilpotent matrix. It is then easy to see that F splits as a direct summand of (Z, W) in $\text{Rep}(\mathfrak{X})$. Moreover, F decomposes into a direct sum of bands $B(w, m, \pi)$, where $w = (\leftarrow x \sim y \rightarrow)$, $m \in \mathbb{N}$ and $\xi \neq \pi \in \mathbb{K}[\xi]$ is a monic irreducible polynomial (note that w is not decorable).

Next, we consider the full subcategory $\text{Rep}^{\leq(\vec{x},\vec{y}),\circ}(\mathfrak{X})$ of $\text{Rep}^{\leq(\vec{x},\vec{y})}(\mathfrak{X})$ consisting of those objects for which the block $W_{\vec{x}\vec{y}}$ is nilpotent. We bring $W_{\vec{x}\vec{y}}$ into its modified Jordan normal form, see Lemma 14.7. Then we reduce the entire matrix $W^{(i)}$ into a standard form by killing with any unit entry ϖ of $W_{\vec{x}\vec{y}}$ all entries of matrices $W_{\vec{x}\vec{u}}$, where $\vec{y} \neq \vec{u} \subseteq \mathfrak{F}_i$ (respectively $W_{\vec{v}\vec{y}}$, where $\vec{x} \neq \vec{v} \subseteq \mathfrak{E}_i$), standing with ϖ in the same row (respectively column). The new decorated bunch of chains $\mathfrak{X}^{[\vec{x},\vec{y}]}$ is defined as follows.

- For any $l \in \mathbb{N}_{\geq 2}$ we introduce new elements $x_l \in \mathfrak{E}_i$ and $y_l \in \mathfrak{F}_i$. It is convenient to pose $x_1 = x$ and $y_1 = y$.
- We have: $x_l \sim y_l$ for all $l \in \mathbb{N}$ and $a < x_l < b$ (respectively $c < y_l < d$) whenever $a < x < b$ (respectively $c < y < d$).
- Finally, we put $\cdots < x_3 < x_2 < x_1$ and $\cdots > y_3 > y_2 > y_1$.

Again, Crossing–Out Lemma 14.9 yields a representation equivalence (7.6) and the translation rule (7.7) is given by the formula

$$u \overset{\alpha}{-} y_l \sim x_l \overset{\beta}{-} v \mapsto u \overset{\alpha}{-} \underbrace{y \overset{0}{-} x \overset{0}{-} \cdots \overset{0}{-} y}_{l \text{ times}} \sim x \overset{\beta}{-} v.$$

The reduction procedure can be illustrated by the following picture:

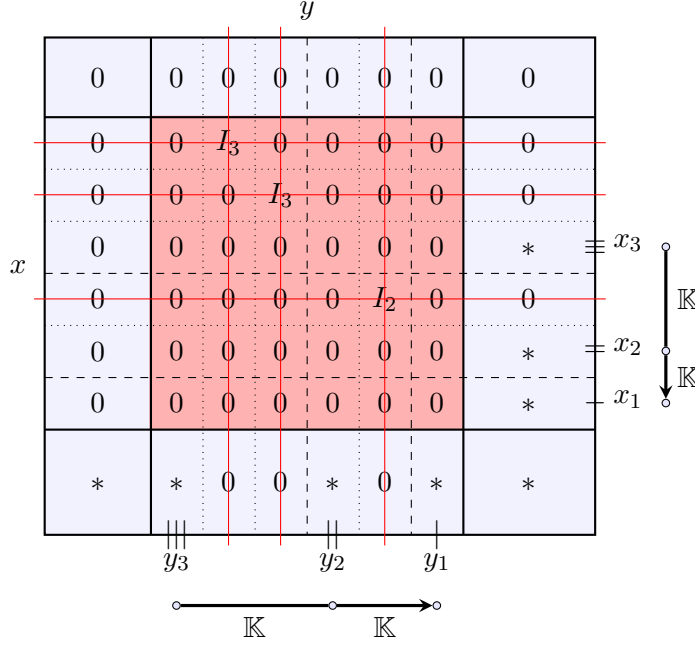

Case 2. Now assume that both maximal elementary subchains \vec{x} and \vec{y} are decorated. The decorated chessboard problem from Example 6.13, treated in details in Section 14, can occur as a special case of such decorated bunch of chains $\mathfrak{X}_{(\vec{x}, \vec{y})}$.

Definition 7.3. Let $m, n \in \mathbb{N}$ and $M \in \text{Mat}_{m \times n}(\mathbb{K})$. The *valuation* of M is the largest integer $\nu = \text{val}(M)$ such that there exists $M_\diamond \in \text{Mat}_{m \times n}(\mathbb{D})$ satisfying $M = t^\nu M_\diamond$. In particular, $\text{val}(M) = \infty$ for $M = 0$.

On the set of pairs $\mathcal{B}_{(\vec{x}, \vec{y})} = \{(u, v) \mid u \in \vec{x}, v \in \vec{y}\}$ consider the following total ordering: $(u, v) < (x, y)$ if either $u < x$ or $u = x$ and $v > y$. Fix the following notations:

- $\text{Rep}^{\leq(\vec{x}, \vec{y}), \nu}(\mathfrak{X})$ is the full subcategory of $\text{Rep}^{\leq(\vec{x}, \vec{y})}(\mathfrak{X})$ consisting of those objects for which $\text{val}(W_{\vec{x}\vec{y}}) \geq \nu$.
- For $(x, y) \in \mathcal{B}_{(\vec{x}, \vec{y})}$ define $\text{Rep}^{\leq(x, y), \nu}(\mathfrak{X})$ to be the full subcategory of $\text{Rep}^{\leq(\vec{x}, \vec{y}), \nu}(\mathfrak{X})$ consisting of those objects for which $\text{val}(W_{uv}) > \text{val}(W_{xy})$ for all $(u, v) < (x, y)$.
- Finally, $\text{Rep}^{<(x, y), \nu}(\mathfrak{X})$ is the full subcategory of $\text{Rep}^{\leq(x, y), \nu}(\mathfrak{X})$ consisting of those objects for which $\text{val}(W_{xy}) > \nu$.

Let $\mathfrak{X}_{(x, y)}$ be the decorated bunch of chains obtained by restricting \mathfrak{X} on (x, y) and (Z, W) be an object of the category $\text{Rep}^{\leq(x, y), \nu}(\mathfrak{X})$, where $(x, y) \in \vec{x} \times \vec{y} \subseteq \mathfrak{E}_i \times \mathfrak{F}_i$ and $\nu \in \mathbb{Z}$.

Case 2a. Assume that $x \not\sim y$. First note that in $\text{Rep}(\mathfrak{X}_{(x, y)})$ we have:

$$W_{xy} = t^\nu (W_{xy})_\diamond \cong t^\nu \begin{pmatrix} t\Psi & 0 \\ 0 & I \end{pmatrix} =: t^\nu U,$$

where I is the identity matrix of size $\text{rk}_{\mathbb{K}}(\overline{(W_{xy})_\diamond})$ and Ψ has coefficients in \mathbb{D} . If both elements x and y are untied then any string $S(x \overset{\nu}{-} y)$ splits up as direct summands of (Z, W) in $\text{Rep}(\mathfrak{X})$, allowing to proceed to the next subcategory $\text{Rep}^{<(x, y), \nu}(\mathfrak{X})$. Hence, we may without loss of generality assume that at least one element of $\{x, y\}$ is tied. Similarly

to Case 1a, we have:

$$\text{End}_{\mathfrak{X}_{(x,y)}}(U) = \left\{ \begin{pmatrix} A & C \\ B & D \end{pmatrix}, \begin{pmatrix} E & F \\ G & D \end{pmatrix} \right\},$$

where A, B, C, D, F, G are matrices over \mathbb{D} of appropriate size (determined by U) satisfying the constraints $A\Psi = \Psi E$, $G = tB\Psi$ and $C = t\Psi F$.

The new decorated bunch of chains $\mathfrak{X}^{[x,y]}$ is defined as follows.

- If $x \sim \tilde{x}$ for some $\tilde{x} \in \mathfrak{X}_j, j \in I$ then we add a new element \tilde{x}_y to \mathfrak{X}_j . We have: $\tilde{x} \triangleleft \tilde{x}_y$ and $a < \tilde{x}_y < b$ provided $a < \tilde{x} < b$ and $a \triangleleft \tilde{x}_y \triangleleft b$ if $a \triangleleft \tilde{x} \triangleleft b$.
- Similarly, if $y \sim \tilde{y}$ for some $\tilde{y} \in \mathfrak{X}_\sigma$ then we add to \mathfrak{X}_σ a new element \tilde{y}_x . We have $c < \tilde{y}_x < d$ whenever $c < \tilde{y} < d$ and $c \triangleleft \tilde{y}_x \triangleleft d$ if $c \triangleleft \tilde{y} \triangleleft d$. Moreover, $\tilde{y} \triangleright \tilde{y}_x$.
- If both x and y are tied then we additionally impose: $\tilde{x}_y \sim \tilde{y}_x$.

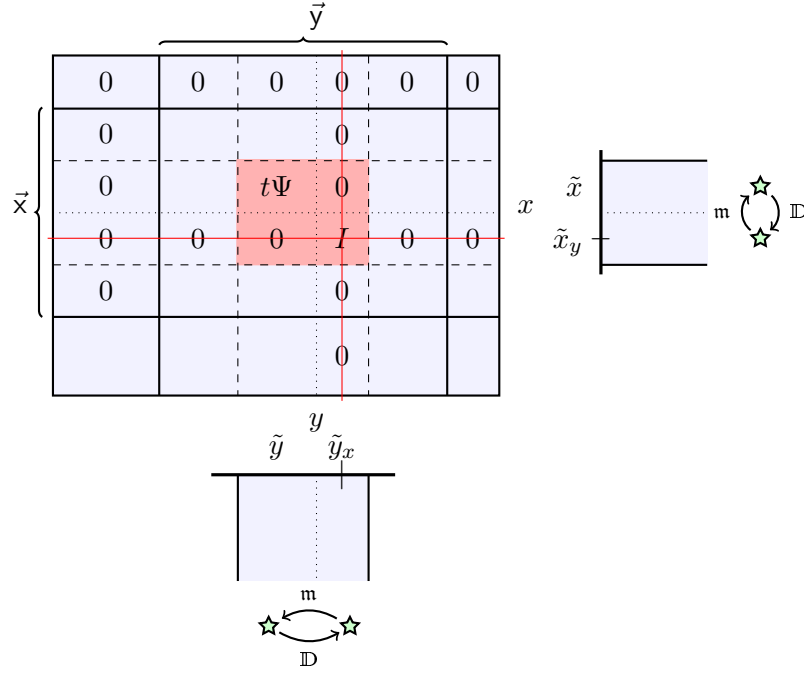

Analogously to (7.6), we get a representation equivalence

$$R_\nu^{xy} : \underline{\text{Rep}}_{\text{st}}^{\leq(x,y),\nu}(\mathfrak{X}) \longrightarrow \underline{\text{Rep}}^{<(x,y),\nu}(\mathfrak{X}^{[x,y]}).$$

The correspondence (7.7) between strings and bands in both categories is given by

$$u \overset{\alpha}{-} \tilde{x}_y \sim \tilde{y}_x \overset{\beta}{-} v \mapsto u \overset{\alpha}{-} \tilde{x} \sim x \overset{\nu}{-} y \sim \tilde{y} \overset{\beta}{-} v.$$

The decorations of decorable words are transferred in a straightforward way. If only one element (e.g. x) is tied then the translation rule is analogous: $\tilde{x}_y \overset{\gamma}{-} z \mapsto y \overset{\nu}{-} x \sim \tilde{x} \overset{\gamma}{-} z$.

Case 2b. Now assume that $x \sim y$. In the category $\text{Rep}(\mathfrak{X}_{(x,y)})$ we have:

$$W_{xy} \cong t^\nu \begin{pmatrix} F & 0 \\ 0 & N \end{pmatrix},$$

where F is invertible over \mathbb{D} and N is nilpotent modulo \mathfrak{m} . As in Case 1b, it is easy to see that $t^\nu F$ splits as a direct summand of (Z, W) in $\text{Rep}(\mathfrak{X})$, decomposing further into a direct

sum of bands $B((w, \rho), m, \pi)$, where $(w, \rho) = (\leftarrow x \sim y \rightarrow^\nu)$, $m \in \mathbb{N}$ and $\xi \neq \pi \in \mathbb{k}[\xi]$ is a monic irreducible polynomial.

Next, consider the full subcategory $\text{Rep}^{\leq(x,y),\nu,\circ}(\mathfrak{X})$ of $\text{Rep}^{\leq(x,y),\nu}(\mathfrak{X})$ consisting of objects for which the matrix $\overline{(W_{xy})}_\diamond$ is nilpotent. Let (Z, W) be an object of $\text{Rep}^{\leq(x,y),\nu,\circ}(\mathfrak{X})$. As in Lemma 14.7, we reduce the block W_{xy} into a normal form. Then we bring the entire matrix $W^{(\nu)}$ into a standard form: if W_{xy} contains an entry ϖ with valuation ν , then for all $(u, v) \in \mathfrak{E}_i \times \mathfrak{F}_i \setminus \{(x, y)\}$ we kill with it all elements of all matrices W_{xu} (respectively W_{vy}) standing in the same row (respectively column) with ϖ .

The new decorated bunch of chains $\mathfrak{X}^{[\vec{x}, \vec{y}]}$ is defined as follows.

- For any $l \in \mathbb{N}_{\geq 2}$ we introduce new decorated elements $x_l \in \mathfrak{E}_i$ and $y_l \in \mathfrak{F}_i$. It is convenient to write $x_1 = x$ and $y_1 = y$.
- For all $l \in \mathbb{N}$ we have: $x_l \sim y_l$ and $a < x_l < b$ (respectively $c < y_l < d$) whenever $a < x < b$ (respectively $c < y < d$). Similarly, $a \triangleleft x_l \triangleleft b$ (respectively $c \triangleleft y_l \triangleleft d$) provided $a \triangleleft x \triangleleft b$ (respectively $c \triangleleft y \triangleleft d$).
- Finally, the ordering between new elements is the following: $\cdots \triangleleft x_3 \triangleleft x_2 \triangleleft x_1$ and $\cdots \triangleright y_3 \triangleright y_2 \triangleright y_1$.

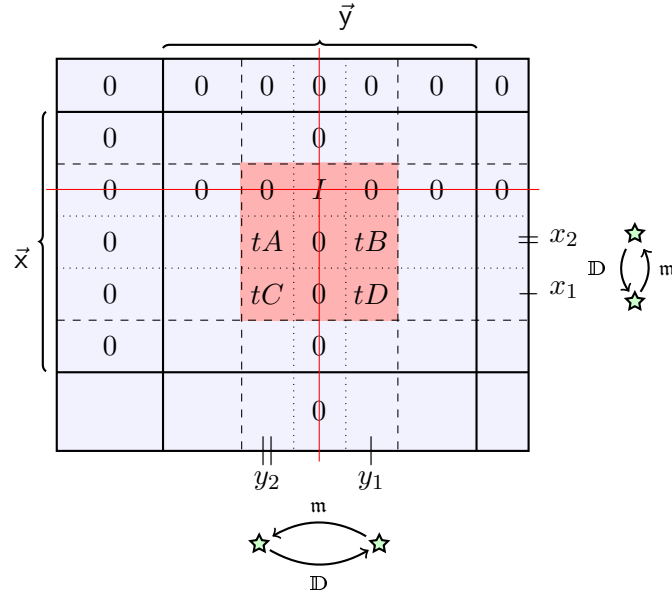

Analogously to (7.6), we get a representation equivalence.

$$R_\nu^{xy} : \underline{\text{Rep}}_{\text{st}}^{\leq(x,y),\nu,\circ}(\mathfrak{X}) \longrightarrow \underline{\text{Rep}}^{\leq(x,y),\nu}(\mathfrak{X}^{[x,y]}).$$

The translation rule (7.7) is given by

$$u \xrightarrow{\alpha} y_l \sim x_l \xrightarrow{\beta} v \mapsto u \xrightarrow{\alpha} \underbrace{y \sim x \xrightarrow{\nu} \cdots \xrightarrow{\nu} y \sim x}_{l \text{ times}} \xrightarrow{\beta} v.$$

Case 3. Assume that $\vec{x} = \{x\}$ is not decorated and $\vec{y} = \{y_1 \triangleright y_2 \triangleright \cdots \triangleright y_n\}$ is decorated, where $\vec{x} \times \vec{y} \subseteq \mathfrak{E}_i \times \mathfrak{F}_i$. This is the most tricky case in the whole reduction procedure. Let (Z, W) be an object of the category $\text{Rep}^{\leq(\vec{x}, \vec{y})}(\mathfrak{X})$.

Case 3a. Assume first that $n = 2$, $\vec{y} = \{y \triangleright z\}$ and $y \not\sim z$. As the first step, observe that any object of $\text{Rep}(\mathfrak{X}_{(\vec{x}, \vec{y})})$ is isomorphic to V given by

$$\begin{array}{c}
 \begin{array}{cc}
 y & z \\
 \hline
 0 & 0 & 0 & 0 \\
 \hline
 0 & 0 & 0 & I_2 \\
 \hline
 0 & I_1 & 0 & 0
 \end{array} \\
 x
 \end{array}$$

If all elements x, y, z are untied, then we can split up from any object of $\text{Rep}^{\leq(\vec{x}, \vec{y})}(\mathfrak{X})$ all direct summands isomorphic to $S(x-y)$ and $S(x-z)$ and proceed to the next subcategory $\text{Rep}^{<(\vec{x}, \vec{y})}(\mathfrak{X})$. So, assume that at least one element of $\{x, y, z\}$ is tied. A direct computation shows that $\text{End}_{\mathfrak{X}_{(\vec{x}, \vec{y})}}(V)$ is the \mathbb{D} -module of all pairs (F, G) of matrices the form

$$(7.8) \quad F = \begin{array}{|c|c|c|} \hline \bullet & 0 & 0 \\ \hline \bullet & *_{1} & \odot_{3} \\ \hline \bullet & *_{4} & *_{2} \\ \hline \end{array} \quad G = \begin{array}{|c|c|c|c|} \hline * & * & * & * \\ \hline 0 & *_{2} & 0 & *_{4} \\ \hline \odot & \odot & * & * \\ \hline 0 & \odot_{3} & 0 & *_{1} \\ \hline \end{array}$$

Here \bullet means that coefficients of the corresponding block belong to \mathbb{K} , $*$ stands for \mathbb{D} and \odot for \mathfrak{m} , equal indices $*_i$ mean that these blocks are equal. The key observation is the following:

- Both non-reduced stripes of the matrix $W^{(i)}$ of the vertical blocks y and z can be transformed by the matrices of the form $\begin{pmatrix} G_{11} & G_{13} \\ G_{31} & G_{33} \end{pmatrix} = \begin{pmatrix} * & * \\ \odot & * \end{pmatrix}$.
- If $x \sim \tilde{x}$ then the admissible transformations of \tilde{x} -block are given by matrices

$$(7.9) \quad \tilde{F} = F = \begin{array}{|c|c|c|} \hline \bullet & 0 & 0 \\ \hline \bullet & *_{1} & \odot \\ \hline \bullet & *_{4} & *_{2} \\ \hline \end{array}$$

where F is the matrix from (7.8).

- If $y \sim \tilde{y}$ then the admissible transformations of \tilde{y} -block are given by matrices $T = \begin{pmatrix} T_{11} & T_{12} \\ T_{21} & T_{22} \end{pmatrix}$, such that $T_{lt} \equiv G_{lt} \pmod{\mathfrak{m}}$ for all $l, t \in \{1, 2\}$. In particular, $T_{21} \equiv 0 \pmod{\mathfrak{m}}$, $T_{22} \equiv F_{33} \pmod{\mathfrak{m}}$ and $T_{11} \equiv G_{11} \pmod{\mathfrak{m}}$, i.e. $T = \begin{pmatrix} * & * \\ \odot & *_{2'} \end{pmatrix}$, where $*_i, *_i'$ means that the corresponding blocks of \tilde{F} and T are equal modulo \mathfrak{m} .
- If $z \sim \tilde{z}$ then the admissible transformations of the \tilde{z} -block are given by matrices $S = \begin{pmatrix} S_{33} & S_{34} \\ S_{43} & S_{44} \end{pmatrix}$, where $S_{lt} \equiv G_{lt} \pmod{\mathfrak{m}}$ for all $l, t \in \{3, 4\}$. In particular, $S_{43} \equiv 0 \pmod{\mathfrak{m}}$, $S_{44} \equiv F_{22} \pmod{\mathfrak{m}}$ and $S_{33} \equiv G_{33} \pmod{\mathfrak{m}}$, i.e. $S = \begin{pmatrix} * & * \\ \odot & *_{1'} \end{pmatrix}$.

The new decorated bunch of chains $\mathfrak{X}^{[\vec{x}, \vec{y}]}$ is defined as follows.

- If $y \sim \tilde{y}$ for some $\tilde{y} \in \mathfrak{X}_j$ then we add a new decorated element \tilde{y}_x to \mathfrak{X}_j . If $z \sim \tilde{z}$ for some $\tilde{z} \in \mathfrak{X}_\kappa$ then we add a new decorated element \tilde{z}_x to \mathfrak{X}_κ . Finally, if $x \sim \tilde{x}$ for some $\tilde{x} \in \mathfrak{X}_\tau$ then we add two *decorated* elements \tilde{x}_y and \tilde{x}_z to \mathfrak{X}_τ (note that \tilde{x} itself is *not decorated*)!
- The new elements inherit all orderings from their parent elements and parent chains. For example, if $a < \tilde{y} < b$ in \mathfrak{X}_j then also $a < \tilde{y}_x < b$ in $\mathfrak{X}_j^{[\tilde{x}, \tilde{y}]}$ etc.
- We have: $\tilde{y} \triangleright \tilde{y}_x$, $\tilde{z} \triangleright \tilde{z}_x$ and $\tilde{x} < \tilde{x}_z < \tilde{x}_y$.
- Finally, we have impose equivalences $\tilde{x}_y \sim \tilde{y}_x$ and $\tilde{x}_z \sim \tilde{z}_x$.

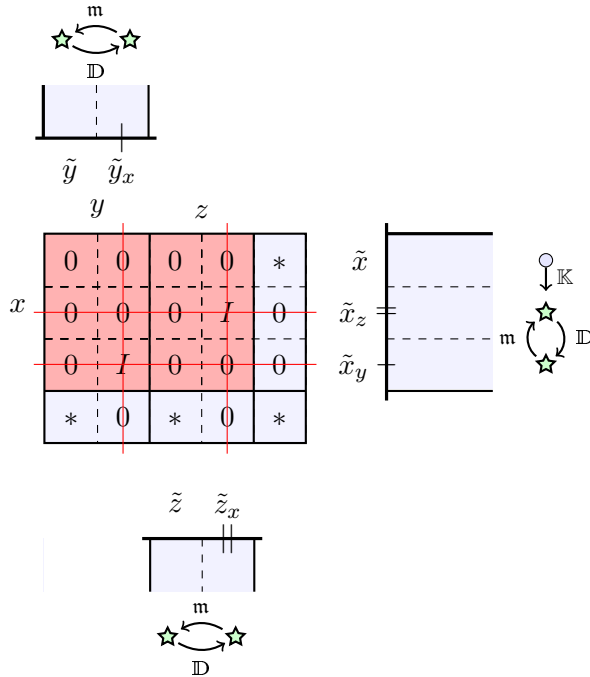

The above computations and Crossing-Out Lemma 14.9 yield a representation equivalence (7.6). Note that in this case $\text{Rep}^{\leq(\tilde{x}, \tilde{y})}(\mathfrak{X}) = \text{Rep}^{\leq(\tilde{x}, \tilde{y}), \circ}(\mathfrak{X})$. The translation rule (7.7) is given by the formulae

$$\tilde{x}_z \sim \tilde{z}_x \mapsto \tilde{x} \sim x - y \sim \tilde{y} \quad \text{and} \quad \tilde{y}_x \sim \tilde{x}_y \mapsto \tilde{y} \sim y - x \sim \tilde{x}.$$

Case 3b. Now assume that $n = 2$, $\vec{y} = \{y \triangleright z\}$ but this time $y \sim z$. Note that any object of $\text{Rep}(\mathfrak{X}_{(\vec{x}, \vec{y})})$ is isomorphic to some U given by

		y				z			
		0	0	0	0	0	0	0	0
		0	0	0	0	0	0	0	I_2
x		0	0	0	0	0	I_3	0	0
		0	0	0	I_2	0	0	0	0
		0	0	I_1	0	0	0	0	0

If all elements x, y, z are untied, then we can split up all direct summands of (Z, W) isomorphic to the strings $S(x - y \sim z)$, $S(x - z \sim y)$ and $S(x - z \sim y - x)$. In this case we

just proceed to the next category $\text{Rep}^{<(\vec{x}, \vec{y})}(\mathfrak{X})$. Hence, we might assume that at least one element of $\{x, y, z\}$ is tied. A direct computation shows that $\text{End}_{\mathfrak{X}^{(\vec{x}, \vec{y})}}(U)$ is the \mathbb{D} -module of all pairs of matrices (F, G) of the form

$$(7.10) \quad F = \begin{array}{|c|c|c|c|c|} \hline \bullet & 0 & 0 & 0 & 0 \\ \hline \bullet & *_{1} & \odot_{5} & \odot_{6} & \odot_{7} \\ \hline \bullet & *_{\beta} & *_{2} & \odot_{8} & \odot_{9} \\ \hline \bullet & *_{\gamma} & *_{\delta} & *_{1'} & \odot_{\alpha} \\ \hline \bullet & *_{\varphi} & *_{\psi} & *_{\theta} & *_{3} \\ \hline \end{array} \quad G = \begin{array}{|c|c|c|c|c|c|} \hline *_{4} & * & * & * & * & * & * & * \\ \hline \odot & *_{2'} & \odot & * & * & * & * & * \\ \hline 0 & 0 & *_{3} & *_{\theta} & 0 & *_{\psi} & 0 & *_{\varphi} \\ \hline 0 & 0 & \odot_{\alpha} & *_{1'} & 0 & *_{\delta} & 0 & *_{\gamma} \\ \hline \odot & \odot & \odot & \odot & *_{4'} & * & * & * \\ \hline \odot & \odot & \odot_{9} & \odot_{8} & 0 & *_{2} & 0 & *_{\beta} \\ \hline \odot & \odot & \odot & \odot & \odot & \odot & *_{3'} & * \\ \hline \odot & \odot & \odot_{7} & \odot_{6} & 0 & \odot_{5} & 0 & *_{1} \\ \hline \end{array}$$

We follow here the same conventions as in Case 3a. In particular, $(*_i, *_i')$ means that the corresponding blocks are equal modulo \mathfrak{m} . By notational reasons, the congruences $G_{tl} \equiv G_{t+4l+4} \pmod{\mathfrak{m}}$ for $1 \leq t, l \leq 4$ are not reflected in (7.10).

- The admissible transformations of the non-reduced part of y -stripe are given by matrices of the form $\begin{pmatrix} G_{11} & G_{12} \\ G_{21} & G_{22} \end{pmatrix} = \begin{pmatrix} *_{4} & * \\ \odot & *_{2'} \end{pmatrix}$.
- The admissible transformations of the non-reduced part of z -stripe are given by matrices of the form $\begin{pmatrix} G_{55} & G_{57} \\ G_{75} & G_{77} \end{pmatrix} = \begin{pmatrix} *_{4'} & * \\ \odot & *_{3'} \end{pmatrix}$.
- If there exists $x \sim \tilde{x}$ then \tilde{x} -stripe is transformed by matrices

$$(7.11) \quad \tilde{F} = F = \begin{array}{|c|c|c|c|c|} \hline \bullet_{0} & 0 & 0 & 0 & 0 \\ \hline \bullet & *_{1} & \odot & \odot & \odot \\ \hline \bullet & * & *_{2} & \odot & \odot \\ \hline \bullet & * & * & *_{1'} & \odot \\ \hline \bullet & * & * & * & *_{3} \\ \hline \end{array}$$

whereas the non-reduced part of x -stripe is transformed by the matrix (\bullet_{0}) .

The new decorated bunch of chains $\mathfrak{X}^{[\vec{x}, \vec{y}]}$ is defined as follows.

- We add to \mathfrak{F}_i two decorated elements y_z and z_y which satisfy $y \triangleright y_z$, $z \triangleright z_y$ and inherit from their parent elements y and z all order relations.
- If $x \sim \tilde{x}$ for some $\tilde{x} \in \mathfrak{X}_j$ then we add to \mathfrak{X}_j new *decorated* elements \tilde{x}_{zy} , \tilde{x}_{yz} , \tilde{x}_y and \tilde{x}_z . They inherit all order relations from their parent element \tilde{x} and satisfy $\tilde{x} < \tilde{x}_{zy} \triangleleft \tilde{x}_z \triangleleft \tilde{x}_{yz} \triangleleft \tilde{x}_y$.
- Finally, we impose new equivalence relations $y_z \sim \tilde{x}_z$, $z_y \sim \tilde{x}_y$ and $\tilde{x}_{yz} \sim \tilde{x}_{zy}$.

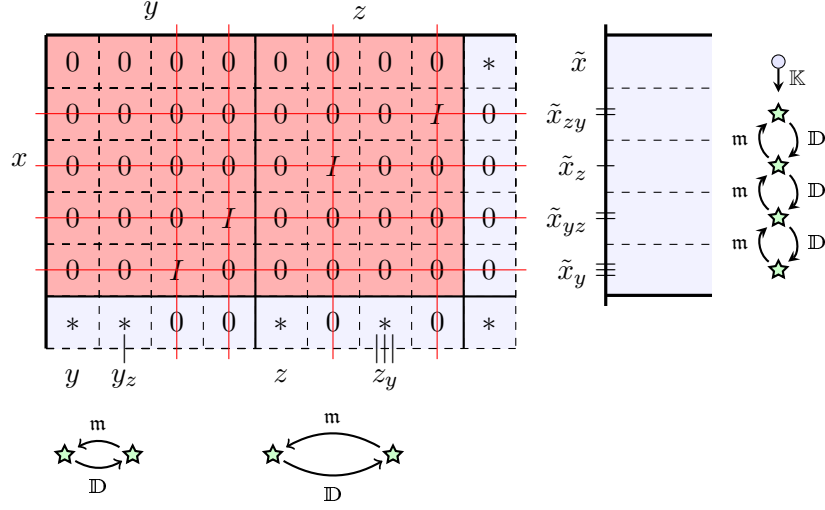

Again, we have a representation equivalence (7.6). The translation rule (7.7) is as follows:

$$\tilde{x}_{yz} \sim \tilde{x}_{zy} \mapsto \tilde{x} \sim x \overset{0}{-} y \sim z \overset{0}{-} x \sim \tilde{x}, \quad z_y \sim \tilde{x}_y \mapsto z \sim y \overset{0}{-} x \sim \tilde{x}$$

and $y_z \sim \tilde{x}_z \mapsto y \sim z \overset{0}{-} x \sim \tilde{x}$.

Case 3c. Consider now the general case when $\vec{x} = \{x\}$ with x not decorated and $\vec{y} = \{y_1 \triangleright \cdots \triangleright y_n\}$ with all y_1, \dots, y_n decorated. First one shows that any indecomposable object of the restricted decorated bunch of chains $\mathfrak{X}_{(\vec{x}, \vec{y})}$ is isomorphic either to $S(x)$, or to $S(a)$ for some untied $a \in \vec{y}$, or to $S(b \sim c)$ where $b, c \in \vec{y}$, or to $S(x - a)$, $S(x - b \sim c)$, $S(x - b \sim c - x)$, where $a, b, c \in \vec{y}$ are as above. The new decorated bunch of chains $\mathfrak{X}^{[\vec{x}, \vec{y}]}$ is defined as follows.

- For any pair $b \sim c$ in \vec{y} we add to \mathfrak{F}_i new decorated elements b_c and c_b , which satisfy $b \triangleright b_c$ and $c \triangleright c_b$ and inherit all order relations from their parent elements b and c .
- For any pair $a \sim \tilde{a}$ with $a \in \vec{y}$ such that $\tilde{a} \in \mathfrak{X}_j$ and $\tilde{a} \notin \vec{y}$, we add to \mathfrak{X}_j a new decorated element \tilde{a}_x which inherits all order relations from its parent \tilde{a} and satisfies $\tilde{a} \triangleright \tilde{a}_x$.
- If there exists $x \sim \tilde{x}$ for some $\tilde{x} \in \mathfrak{X}_\sigma$ then for any $a \in \vec{y}$ we add to \mathfrak{X}_σ a new *decorated* element \tilde{x}_a . Moreover, for any pair $b, c \in \vec{y}$ such that $b \sim c$ we add to \mathfrak{X}_σ a pair of decorated elements \tilde{x}_{bc} and \tilde{x}_{cb} . All these new elements inherit all orderings from their parent \tilde{x} .
- Assume that $\tilde{x} \parallel x$ and $\{a \triangleleft b \triangleleft f \triangleleft c \triangleleft d\} \subseteq \vec{y}$ with $b \sim c$. Then we have

$$\tilde{x} < \tilde{x}_d \triangleleft \tilde{x}_{cb} \triangleleft \tilde{x}_c \triangleleft \tilde{x}_f \triangleleft \tilde{x}_{bd} \triangleleft \tilde{x}_b \triangleleft \tilde{x}_a.$$

- In the above notations we impose the following equivalence relations.
 - If $b, c \in \vec{y}$ are such that $b \sim c$ then $\tilde{x}_b \sim c_b$, $\tilde{x}_c \sim b_c$ and $\tilde{x}_{bc} \sim \tilde{x}_{cb}$.
 - If for $a \in \vec{y}$ there exists $\tilde{a} \notin \vec{y}$ such that $a \sim \tilde{a}$ then $\tilde{x}_a \sim \tilde{a}_x$.

Then we have a representation equivalence (7.6) with translation rules (7.7) for strings and bands given by

$$\tilde{x}_b \sim c_b \mapsto \tilde{x} \sim x \overset{0}{-} b \sim c, \quad \tilde{x}_c \sim b_c \mapsto \tilde{x} \sim x \overset{0}{-} c \sim b, \quad \tilde{x}_{bc} \sim \tilde{x}_{cb} \mapsto \tilde{x} \sim x \overset{0}{-} b \sim c \overset{0}{-} x \sim \tilde{x}$$

and $\tilde{x}_a \sim \tilde{a}_x \mapsto \tilde{x} \sim x \overset{0}{-} a \sim \tilde{a}$. The case when \vec{x} is decorated and \vec{y} not decorated is completely analogous. \square

7.3. Decorated Kronecker problem. Consider now the decorated bunch of chains \mathfrak{X} given in Example 6.12, arising in the classification of maximal Cohen–Macaulay modules over $T_{23\infty}$. Note that all elements of \mathfrak{X} are tied. This implies that without loss of generality, we can begin any word w (cyclic or not) with a column element. This convention has another advantage as it reduces the variety of non–equal but isomorphic canonical forms. According to Theorem 7.1, there are four types of indecomposable objects in $\text{Rep}(\mathfrak{X})$, namely:

Case 1. Bands $B((w, \rho), m, \pi)$, where

$$(w, \rho) = \leftarrow y_2 \sim y_1 \overset{\mu_1}{-} x_1 \sim x_2 \overset{\nu_1}{-} y_2 \sim y_1 \overset{\mu_2}{-} x_1 \sim x_2 \overset{\nu_2}{-} \cdots \leftarrow y_2 \sim y_1 \overset{\mu_n}{-} x_1 \sim x_2 \overset{\nu_n}{-} \rightarrow,$$

m is any natural number and $\pi \neq \xi$ is any irreducible polynomial. We may without loss of generality assume that $\mu_1 = \cdots = \mu_n = 1$. In this case, the only condition on the decoration is that the sequence of integers $\boldsymbol{\nu} = (\nu_1, \nu_2, \dots, \nu_n)$ is non–periodic. We set $M_1 = I_{dmn}$, where $d = \deg(\pi)$ while

$$M_2 = \begin{array}{ccccc} 0 & t^{\nu_1} I & 0 & \dots & 0 \\ 0 & 0 & t^{\nu_2} I & \dots & 0 \\ \vdots & \vdots & \ddots & \ddots & \vdots \\ 0 & 0 & 0 & \ddots & t^{\nu_{n-1}} I \\ t^{\nu_n} F & 0 & 0 & \dots & 0 \end{array}$$

where I is the identity $dm \times dm$ matrix and F is the Frobenius block of π^m .

Case 2. The “degenerate band” corresponding to the “forbidden” polynomial $\pi = x$ is given by the string $S(w, \rho)$, where

$$(w, \rho) = y_2 \sim y_1 \overset{\mu_1}{-} x_1 \sim x_2 \overset{\nu_1}{-} y_2 \sim y_1 \overset{\mu_2}{-} x_1 \sim x_2 \cdots \overset{\nu_{n-1}}{-} y_2 \sim y_1 \overset{\mu_n}{-} x_1 \sim x_2.$$

Again, the decoration ρ can be chosen in such a way that $\mu_1 = \cdots = \mu_n = 1$. Then the matrix $M_1 = I_{n+1}$, while

$$M_2 = \begin{array}{ccccc} 0 & t^{\nu_1} & 0 & \dots & 0 \\ 0 & 0 & t^{\nu_2} & \dots & 0 \\ \vdots & \vdots & \ddots & \ddots & \vdots \\ 0 & 0 & 0 & \ddots & t^{\nu_n} \\ 0 & 0 & 0 & \dots & 0 \end{array}$$

Of course, there is also the symmetric object, obtained by permuting indices 1 and 2.

Case 3. There exists a family of “non-square” indecomposable representations $S(w, \rho)$:

$$M_1 = \begin{array}{|c|} \hline \begin{array}{ccccc} 1 & 0 & \dots & 0 & 0 \\ 0 & 1 & \dots & 0 & 0 \\ \vdots & \vdots & \ddots & \ddots & \vdots \\ 0 & 0 & \dots & 1 & 0 \end{array} \\ \hline \end{array} = M_2 = \begin{array}{|c|} \hline \begin{array}{ccccc} 0 & t^{\nu_1} & 0 & \dots & 0 \\ 0 & 0 & t^{\nu_2} & \dots & 0 \\ \vdots & \vdots & \ddots & \vdots & \vdots \\ 0 & 0 & 0 & \dots & t^{\nu_n} \end{array} \\ \hline \end{array}$$

given by the decorated word

$$(w, \rho) = y_2 \sim y_1 \overset{\mu_1}{-} x_1 \sim x_2 \overset{\nu_1}{-} y_2 \sim y_1 \overset{\mu_2}{-} x_1 \sim x_2 \overset{\mu_2}{-} \dots - y_2 \sim y_1 \overset{\mu_n}{-} x_1 \sim x_2 \overset{\nu_n}{-} y_2 \sim y_1.$$

As before, we have posed $\mu_1 = \dots = \mu_n = 1$. Moreover, we may additionally (and without loss of generality) assume that $\nu_n = 1$.

Case 4. Finally, we have the “dual object” to the previous string object:

$$M_1 = \begin{array}{|c|} \hline \begin{array}{ccccc} 1 & 0 & \dots & 0 \\ 0 & 1 & \dots & 0 \\ \vdots & \vdots & \ddots & \vdots \\ 0 & 0 & \dots & 1 \\ 0 & 0 & \dots & 0 \end{array} \\ \hline \end{array} = M_2 = \begin{array}{|c|} \hline \begin{array}{ccccc} 0 & 0 & \dots & 0 \\ t^{\nu_1} & 0 & \dots & 0 \\ 0 & t^{\nu_2} & \dots & 0 \\ \vdots & \vdots & \ddots & \vdots \\ 0 & 0 & \dots & t^{\nu_n} \end{array} \\ \hline \end{array}$$

given by the decorated word

$$(w, \rho) = x_2 \sim x_1 \overset{\mu_1}{-} y_1 \sim y_2 \overset{\nu_1}{-} x_2 \sim x_1 \overset{\mu_2}{-} \dots - y_1 \sim y_2 \overset{\nu_n}{-} x_2 \sim x_1.$$

As above, we have posed $\mu_1 = \dots = \mu_n = 1$.

The isomorphism classes of strings in all Cases 2–4 are uniquely determined by the corresponding sequences $\boldsymbol{\nu} = (\nu_1, \dots, \nu_n)$. Two bands $B(\boldsymbol{\nu}, m, \pi)$ and $B(\boldsymbol{\nu}', m', \pi')$ are isomorphic if and only if $m = m'$, $\pi = \pi'$ and $\boldsymbol{\nu}'$ is a rotation of $\boldsymbol{\nu}$.

8. MAXIMAL COHEN-MACAULAY MODULES OVER DEGENERATE CUSPS-I

In this section we consider in details three other important examples of degenerate cusps: $\mathbb{k}[[x, y, z]]/(xyz)$, $\mathbb{k}[[x, y, z, w]]/(xy, zw)$ and $\mathbb{k}[[x, y, z, u, v]]/(xz, xu, yv, zv)$.

8.1. Maximal Cohen-Macaulay modules over $\mathbb{k}[[x, y, z]]/(xyz)$. Consider a $T_{\infty\infty\infty}$ -singularity $A = \mathbb{k}[[x, y, z]]/(xyz)$. Let

$$\pi : A \longrightarrow R = R_1 \times R_2 \times R_3 = \mathbb{k}[[x_1, y_2]] \times \mathbb{k}[[y_1, z_2]] \times \mathbb{k}[[z_1, x_2]]$$

be its normalization, where $\pi(x) = x_1 + x_2$, $\pi(y) = y_1 + y_2$ and $\pi(z) = z_1 + z_2$. For the conductor ideal $I = \text{ann}_A(R/A)$ we have:

$$I = \langle xy, xz, yz \rangle_A = \langle x_1y_2, y_1z_2, z_1x_2 \rangle_R.$$

Next, we have: $\bar{A} = A/I = \mathbb{k}[[x, y, z]]/(xy, xz, yz)$ and $\bar{R} = R/I = \bar{R}_1 \times \bar{R}_2 \times \bar{R}_3 = \mathbb{k}[[x_1, y_2]]/(x_1y_2) \times \mathbb{k}[[y_1, z_2]]/(y_1z_2) \times \mathbb{k}[[z_1, x_2]]/(z_1x_2)$. It is convenient to introduce the ring $\tilde{A} = \mathbb{k}[[x]] \times \mathbb{k}[[y]] \times \mathbb{k}[[z]]$. Note that the canonical map $\bar{A} \rightarrow \bar{R}$ factorizes through \tilde{A} .

It is convenient to visualize an object of the category $\text{Rep}(\mathfrak{X}_A)$ as a representation of the “decorated” quiver (1.5) over the field $\mathbb{K} = \mathbb{k}((t))$:

$$(8.1) \quad \begin{array}{ccccc} & & \mathbb{K}^{n_x} & \xrightarrow{\Theta_3^x} & \mathbb{K}^{m_3} & & \\ & \Theta_1^x \swarrow & & & & \nwarrow \Theta_3^z & \\ & \mathbb{K}^{m_1} & & & & \mathbb{K}^{n_z} & \\ & \Theta_1^y \swarrow & & & & \nwarrow \Theta_2^z & \\ & \mathbb{K}^{n_y} & \xrightarrow{\Theta_2^y} & & \mathbb{K}^{m_2} & & \end{array}$$

The isomorphism classes of objects in $\text{Rep}(\mathfrak{X}_A)$ correspond to the transformation rule

$$(8.2) \quad \Theta_i^a \mapsto S_{ia} \Theta_i^a T_a^{-1}, \quad i \in \{1, 2, 3\} \text{ and } a \in \{x, y, z\},$$

where $T_a \in \text{GL}_{n_a}(\mathbb{K})$ and $S_{ia} \in \text{GL}_{m_i}(\mathbb{D})$ are such that $S_{1x}(0) = S_{1y}(0)$, $S_{2y}(0) = S_{2z}(0)$ and $S_{3x}(0) = S_{3z}(0)$. Our goal is to describe the indecomposable objects of $\text{CM}^{\text{lf}}(A)$.

Definition 8.1. Consider the following *band datum* (ω, l, λ) , where:

- $\omega = ((a_1, b_1, c_1, d_1, e_1, f_2), (a_2, b_2, c_2, d_2, e_2, f_3), \dots, (a_t, b_t, c_t, d_t, e_t, f_1)) \in \mathbb{Z}^{6t}$ for some $t \geq 1$ such that $\min(a_i, f_i) = \min(b_i, c_i) = \min(d_i, e_i) = 1$ for all $1 \leq i \leq t$.
- $l \in \mathbb{Z}_{>0}$ and $\lambda \in \mathbb{k}^*$.

Then we attach to the data (ω, l, λ) the following matrices:

$$\Theta_1^x = \begin{array}{|c|} \hline A_1 & 0 & \dots & 0 \\ \hline 0 & A_2 & \dots & 0 \\ \hline \vdots & \vdots & \ddots & \vdots \\ \hline 0 & 0 & \dots & A_t \\ \hline \end{array} \quad \Theta_1^y = \begin{array}{|c|} \hline B_1 & 0 & \dots & 0 \\ \hline 0 & B_2 & \dots & 0 \\ \hline \vdots & \vdots & \ddots & \vdots \\ \hline 0 & 0 & \dots & B_t \\ \hline \end{array}$$

$$\Theta_2^y = \begin{array}{|c|} \hline C_1 & 0 & \dots & 0 \\ \hline 0 & C_2 & \dots & 0 \\ \hline \vdots & \vdots & \ddots & \vdots \\ \hline 0 & 0 & \dots & C_t \\ \hline \end{array} \quad \Theta_2^z = \begin{array}{|c|} \hline D_1 & 0 & \dots & 0 \\ \hline 0 & D_2 & \dots & 0 \\ \hline \vdots & \vdots & \ddots & \vdots \\ \hline 0 & 0 & \dots & D_t \\ \hline \end{array}$$

$$\Theta_3^x = \begin{array}{|c|} \hline 0 & F_2 & \dots & 0 \\ \hline \vdots & \vdots & \ddots & \vdots \\ \hline 0 & 0 & \dots & F_t \\ \hline H & 0 & \dots & 0 \\ \hline \end{array} \quad \Theta_3^z = \begin{array}{|c|} \hline E_1 & 0 & \dots & 0 \\ \hline 0 & E_2 & \dots & 0 \\ \hline \vdots & \vdots & \ddots & \vdots \\ \hline 0 & 0 & \dots & E_t \\ \hline \end{array}$$

where $A_k = t^{a_k} I$, $B_k = t^{b_k} I$, $C_k = t^{c_k} I$, $D_k = t^{d_k} I$, $F_k = t^{f_k} I$, $E_k = t^{e_k} I$, and $H = t^{f_1} J$ with $I = I_l$ the identity $l \times l$ matrix and $J = J_l(\lambda)$ the Jordan block of size $l \times$

l with the eigenvalue λ . Denote $\Theta^x = \Theta_1^x(x_1) + \Theta_3^x(x_2)$, $\Theta^y = \Theta_1^y(y_2) + \Theta_2^y(y_1)$ and $\Theta^z = \Theta_2^z(z_2) + \Theta_3^z(z_1)$. The indecomposable maximal Cohen–Macaulay A -module $M = M(\omega, l, \lambda)$ attached to the band datum (ω, l, λ) is constructed by the following recipe:

- Consider the A -linear morphism $\bar{\Theta} = [\Theta^x | \Theta^y | \Theta^z] : \tilde{A}^{lt} \rightarrow \bar{R}^{lt}$, where we write $\tilde{A}^{lt} = \mathbb{k}[[x]]^{lt} \oplus \mathbb{k}[[y]]^{lt} \oplus \mathbb{k}[[z]]^{lt}$ and use the isomorphisms $\text{Hom}_{\bar{A}}(\mathbb{k}[[x]], \bar{R}) \cong \mathbb{k}[[x]]$.
- Consider the torsion free A -module $L = L(\omega, l, \lambda)$ given by the following commutative diagram with exact rows:

$$\begin{array}{ccccccc} 0 & \longrightarrow & I^{lt} & \longrightarrow & L & \longrightarrow & \tilde{A}^{lt} \longrightarrow 0 \\ & & \downarrow = & & \downarrow & & \downarrow \bar{\Theta} \\ 0 & \longrightarrow & I^{lt} & \longrightarrow & R^{lt} & \longrightarrow & \bar{R}^{lt} \longrightarrow 0. \end{array}$$

- From the above description it follows that L is the A -submodule of R^{lt} generated by the columns of the matrix $\left(x_1 y_2 I \mid y_1 z_2 I \mid z_1 x_2 I \mid \Theta^x \mid \Theta^y \mid \Theta^z \right) \in \text{Mat}_{lt \times 6lt}(R)$.
- Finally, we have: $M(\omega, l, \lambda) = L(\omega, l, \lambda)^{\vee\vee}$. Moreover, the following sequence is exact: $0 \rightarrow L(\omega, l, \lambda) \rightarrow M(\omega, l, \lambda) \rightarrow H_{\{m\}}^0(\text{coker}(\bar{\Theta})) \rightarrow 0$.

The ring $R = R_1 \times R_2 \times R_3$ is a subring of the total ring of fractions $Q(A)$. The units of R_i ($1 \leq i \leq 3$) are the idempotents $e_1 = \frac{xy}{xy+yz+zx}$, $e_2 = \frac{yz}{xy+yz+zx}$ and $e_3 = \frac{xz}{xy+yz+zx}$. It is easy to see that $e_1 + e_2 + e_3 = 1$ and $e_i e_j = \delta_{ij} e_i$ for all $1 \leq i, j \leq 3$. In these notations we can write the elements $x_1, x_2, y_1, y_2, z_1, z_2$ of the normalization R as elements of the total ring of fractions $Q(A)$ in the following way: $x_1 = e_1 x$, $y_2 = e_1 y$, $y_1 = e_2 y$, $z_2 = e_2 z$, $z_1 = e_3 z$ and $x_2 = e_3 x$. Next, the element $xy + yz + zx \in A$ is not a zero divisor. Since the module L is torsion free, we have: $L \cong (xy + yz + zx) \cdot L \subseteq A^{lt}$. Consider the matrices:

$$\begin{array}{l} \tilde{\Theta}_1^x = \begin{array}{|c|} \hline \tilde{A}_1 \quad 0 \quad \dots \quad 0 \\ \hline 0 \quad \tilde{A}_2 \quad \dots \quad 0 \\ \hline \vdots \quad \vdots \quad \ddots \quad \vdots \\ \hline 0 \quad 0 \quad \dots \quad \tilde{A}_t \\ \hline \end{array} \quad \tilde{\Theta}_1^y = \begin{array}{|c|} \hline \tilde{B}_1 \quad 0 \quad \dots \quad 0 \\ \hline 0 \quad \tilde{B}_2 \quad \dots \quad 0 \\ \hline \vdots \quad \vdots \quad \ddots \quad \vdots \\ \hline 0 \quad 0 \quad \dots \quad \tilde{B}_t \\ \hline \end{array} \\ \\ \tilde{\Theta}_2^y = \begin{array}{|c|} \hline \tilde{C}_1 \quad 0 \quad \dots \quad 0 \\ \hline 0 \quad \tilde{C}_2 \quad \dots \quad 0 \\ \hline \vdots \quad \vdots \quad \ddots \quad \vdots \\ \hline 0 \quad 0 \quad \dots \quad \tilde{C}_t \\ \hline \end{array} \quad \tilde{\Theta}_2^z = \begin{array}{|c|} \hline \tilde{D}_1 \quad 0 \quad \dots \quad 0 \\ \hline 0 \quad \tilde{D}_2 \quad \dots \quad 0 \\ \hline \vdots \quad \vdots \quad \ddots \quad \vdots \\ \hline 0 \quad 0 \quad \dots \quad \tilde{D}_t \\ \hline \end{array} \\ \\ \tilde{\Theta}_3^x = \begin{array}{|c|} \hline 0 \quad \tilde{F}_2 \quad \dots \quad 0 \\ \hline \vdots \quad \vdots \quad \ddots \quad \vdots \\ \hline 0 \quad 0 \quad \dots \quad \tilde{F}_t \\ \hline \tilde{H} \quad 0 \quad \dots \quad 0 \\ \hline \end{array} \quad \tilde{\Theta}_3^z = \begin{array}{|c|} \hline \tilde{E}_1 \quad 0 \quad \dots \quad 0 \\ \hline 0 \quad \tilde{E}_2 \quad \dots \quad 0 \\ \hline \vdots \quad \vdots \quad \ddots \quad \vdots \\ \hline 0 \quad 0 \quad \dots \quad \tilde{E}_t \\ \hline \end{array} \end{array}$$

where $\tilde{A}^k = x^{a_k+1}yI$, $\tilde{B}^k = y^{b_k+1}xI$, $\tilde{C}^k = y^{c_k+1}zI$, $\tilde{D}^k = z^{d_k+1}yI$, $\tilde{F}^k = x^{a_k+1}zI$, $\tilde{E}^k = z^{a_k+1}xI$ and $\tilde{H} = x^{f_1+1}zJ$ with $I = I_l$ the identity $l \times l$ matrix and $J = J_l(\lambda)$ the Jordan block of size $l \times l$ with the eigenvalue λ . Denote $\tilde{\Theta}^x = \tilde{\Theta}_1^x + \tilde{\Theta}_3^x$, $\tilde{\Theta}^y = \tilde{\Theta}_1^y + \tilde{\Theta}_2^y$, $\tilde{\Theta}^z = \tilde{\Theta}_2^z + \tilde{\Theta}_3^z$ and consider the A -module $L'(\omega, l, \lambda)$ generated by the columns of the matrix $((xy)^2I \mid (yz)^2I \mid (xz)^2I \mid \tilde{\Theta}^x \mid \tilde{\Theta}^y \mid \tilde{\Theta}^z) \in \text{Mat}_{6lt \times 6lt}(A)$.

Theorem 8.2. *Let $A = \mathbb{k}\llbracket x, y, z \rrbracket / (xyz)$, (ω, l, λ) be a band datum as in Definition 8.1 and $L'(\omega, l, \lambda)$ the torsion free A -module defined above. Then we have:*

- The module $M(\omega, l, \lambda) := L'(\omega, l, \lambda)^{\vee\vee}$ is an indecomposable maximal Cohen–Macaulay module over A , locally free of rank lt on the punctured spectrum.
- Any indecomposable object of $\text{CM}^{\text{lf}}(A)$ is isomorphic to some module $M(\omega, l, \lambda)$.
- $M(\omega, l, \lambda) \cong M(\omega', l', \lambda')$ if and only if $l = l'$, $\lambda = \lambda'$ and ω' is obtained from ω by a cyclic shift.

Remark 8.3. The indecomposable maximal Cohen–Macaulay A -modules which are not locally free on the punctured spectrum, correspond to the string data. They can be described along similar lines as above, but there are more cases one needs to consider. Therefore we leave it to an interested reader as an exercise.

Corollary 8.4. *Let M be a rank one object of $\text{CM}^{\text{lf}}(A)$. Then we have:*

$$M \cong M(\omega, \lambda) := \langle (xy)^2, (yz)^2, (xz)^2, x^{m_1+1}y + \lambda x^{m_2+1}z, y^{n_1+1}z + y^{n_2+1}x, z^{l_1+1}x + z^{l_2+1}y \rangle_A^{\vee\vee}$$

for some $\omega = ((m_1, m_2), (n_1, n_2), (l_1, l_2)) \in \mathbb{Z}^6$ and $\lambda \in \mathbb{k}^*$, where

$$\min(m_1, m_2) = \min(n_1, n_2) = \min(l_1, l_2) = 1.$$

Moreover, $M(\omega, \lambda) \cong M(\omega', \lambda')$ if and only if $\omega = \omega'$ and $\lambda = \lambda'$.

Remark 8.5. It is very instructive to consider the case $m_1 = m_2 = n_1 = n_2 = l_1 = l_2 = 1$ and $\lambda = 1$. First note that

$$L := \langle (xy)^2, (yz)^2, (xz)^2, x^2y + x^2z, y^2z + y^2x, z^2x + z^2y \rangle = \langle x^2y + x^2z, y^2z + y^2x, z^2x + z^2y \rangle.$$

Let $r = xy + yz + xz \in A$. Then we have: $\mathfrak{m} \cdot r \subset L$. From Lemma 2.5 it follows that $L^{\vee\vee} = (r) \cong A$. Hence, $M(((1, 1), (1, 1), (1, 1)), 1) \cong A$, what of course matches with the general theory.

The classification of rank one objects of $\text{CM}^{\text{lf}}(A)$ obtained in Corollary 8.4 can be elaborated one step further.

Proposition 8.6. *Let M be a non-regular rank one object of $\text{CM}^{\text{lf}}(A)$. Then its minimal number of generators is equal to two or three.*

1. *Assume M is generated by two elements. Then there exists a bijection $\{u, v, w\} \rightarrow \{x, y, z\}$, a pair of integers $p, q \geq 1$ and $\lambda \in \mathbb{k}^*$ such that $M = \text{coker}(A^2 \xrightarrow{\theta} A^2)$ with $\theta = \theta_i((p, q), \lambda)$, $1 \leq i \leq 3$, where*

$$\theta_1((p, q), \lambda) = \begin{pmatrix} u & 0 \\ v^p + \lambda w^q & vw \end{pmatrix}, \quad \theta_2((p, q), \lambda) = \begin{pmatrix} \lambda u + v^p w^q & w^{q+1} \\ u^{q+1} & vw \end{pmatrix}$$

and $\theta_3((p, q), \lambda) = \theta_1((p, q), \lambda)^{\text{tr}}$.

2. Assume M is generated by three elements. Then there exists a bijection $\{u, v, w\} \rightarrow \{x, y, z\}$, a triple of integers $m, n, l \geq 1$ and $\lambda \in \mathbb{k}^*$ such that $M = \text{coker}(A^3 \xrightarrow{\theta} A^3)$ with $\theta = \theta_i((m, n, l), \lambda)$, $4 \leq i \leq 7$, where

$$\theta_4((m, n, l), \lambda) = \begin{pmatrix} u & w^l & 0 \\ 0 & v & u^m \\ \lambda v^n & 0 & w \end{pmatrix}, \quad \theta_5((m, n, l), \lambda) = \begin{pmatrix} u & w^l & \lambda v^n \\ 0 & v & u^m \\ 0 & 0 & w \end{pmatrix},$$

$$\theta_6((m, n, l), \lambda) = \theta_4((m, n, l), \lambda)^{\text{tr}} \quad \text{and} \quad \theta_7((m, n, l), \lambda) = \theta_5((m, n, l), \lambda)^{\text{tr}}.$$

Proof. By Corollary 8.4 we know that $M \cong M(\omega, \lambda) = L(\omega, \lambda)^{\vee\vee}$ for some $\omega = ((m_1, m_2), (n_1, n_2), (l_1, l_2)) \in \mathbb{Z}^6$ and $\lambda \in \mathbb{k}^*$, where $\min(m_1, m_2) = \min(n_1, n_2) = \min(l_1, l_2) = 1$.

Case 1a. Assume $m_1 = n_1 = l_1 = 1$. Denote for simplicity $m_2 = m$, $n_2 = n$, $l_2 = l$ and

$$u_1 = x^2y + \lambda x^{m+1}z, \quad u_2 = y^2z + y^{n+1}x \quad \text{and} \quad u_3 = z^2x + z^{l+1}y.$$

Then we have: $(xy)^2 = xu_1$, $(yz)^2 = yu_2$ and $(xz)^2 = zu_3$. Hence, $L = \langle u_1, u_2, u_3 \rangle_A$. Moreover, L is already maximal Cohen–Macaulay and we have an exact sequence

$$A^3 \xrightarrow{\begin{pmatrix} z & -y^n & 0 \\ 0 & x & -z^l \\ -\lambda x^m & 0 & y \end{pmatrix}} A^3 \longrightarrow L \longrightarrow 0.$$

Case 1b. Assume $m_2 = n_2 = l_2 = 1$. Again, we denote $m_1 = m$, $n_1 = n$, $l_1 = l$ and

$$v_1 = x^{m+1}y + \lambda x^2z, \quad v_2 = y^{n+1}z + y^2x \quad \text{and} \quad v_3 = z^{l+1}x + z^2y.$$

Then we have: $(xy)^2 = zv_1$, $(yz)^2 = yv_3$ and $\lambda(xz)^2 = zv_1$. Hence, $L = \langle v_1, v_2, v_3 \rangle_A$. As in the previous case, L is maximal Cohen–Macaulay and we have an exact sequence

$$A^3 \xrightarrow{\begin{pmatrix} \lambda x & 0 & -y^n \\ -z^l & y & 0 \\ 0 & -x^m & z \end{pmatrix}} A^3 \longrightarrow L \longrightarrow 0.$$

Case 2. Assume $m_1 = l_1 = n_2 = 1$. Denote $m_2 = m$, $n_1 = n$ and $l_2 = l$. The case $n = 1$ has been already treated in Case 1a. Hence, without loss of generality we may assume that $n \geq 2$. Denote

$$w_1 = x^2y + \lambda x^{m+1}z, \quad w_2 = y^{n+1}z + y^2x \quad \text{and} \quad w_3 = z^2x + z^{l+1}y.$$

We have: $(xy)^2 = xw_1$ and $(xz)^2 = xw_3$. Hence, $L = \langle (yz)^2, w_1, w_2, w_3 \rangle_A$. Note that the case $m = l = 1$ has been already considered in Case 1b.

Case 2a. Assume $m = 1$ and $l \geq 2$. Consider the element $r = xy + y^n z + \lambda(xz + z^l y) \in A$ and the module $\tilde{L} = \langle L, r \rangle_A \subseteq A$. First note that

$$xr = w_1, \quad yr = w_2 + \lambda z^{l-2}(yz)^2 \quad \text{and} \quad zr = y^{n-2}(yz)^2 + \lambda w_3.$$

By Lemma 2.5, the Macaulayfications of the modules L and \tilde{L} are isomorphic. Moreover, $\tilde{L} = \langle r, (yz)^2 \rangle_A$ is maximal Cohen–Macaulay and we have an exact sequence

$$A^2 \xrightarrow{\begin{pmatrix} x & y^{n-1} + \lambda z^{l-1} \\ 0 & -yz \end{pmatrix}} A^2 \longrightarrow \tilde{L} \longrightarrow 0.$$

Case 2b. Assume $m \geq 2$. The case $l = 1$ reduces to the Case 2a. Hence, we may without loss of generality assume that $l \geq 2$. Consider the element $r = xy + y^n z + \lambda x^m z \in A$ and $\tilde{L} = \langle L, r \rangle_A \subseteq A$. Then we have: $xr = w_1$, $yr = w_2$ and $zr = y^{n-2}(yz)^2 + \lambda x^{m-1}w_3$.

Hence, the Macaulayfications of L and \tilde{L} are isomorphic. Next, $\tilde{L} = \langle (yz)^2, w_3, r \rangle_A$ is maximal Cohen–Macaulay and it has a presentation

$$A^3 \xrightarrow{\begin{pmatrix} x & -z^{l-1} & -y^{n-2} \\ 0 & y & -\lambda x^{m-1} \\ 0 & 0 & z \end{pmatrix}} A^3 \longrightarrow \tilde{L} \longrightarrow 0.$$

Note that the case $n = 2$ has to be treated separately because in that case the presentation is not minimal. Indeed, $(yz)^2 = z(xy + y^2z + \lambda x^m z) = zr$. Hence,

$$\tilde{L} = \langle xz^2 + yz^{l+1}, xy + y^2z + \lambda x^m z \rangle_A \subseteq A$$

is generated by two elements. It is easy to see that \tilde{L} has a presentation

$$A^2 \xrightarrow{\begin{pmatrix} \lambda y + x^{m-1} z^{l-1} & z^l \\ x^m & xz \end{pmatrix}} A^2 \longrightarrow \tilde{L} \longrightarrow 0.$$

It remains to observe that the remaining cases reduce to the ones considered above. \square

Remark 8.7. Contrary to the case of simple elliptic singularities [52, Proposition 5.23], not all indecomposable maximal Cohen–Macaulay modules over A are gradable. For example, $\text{coker} \begin{pmatrix} x & y^p + \lambda z^q \\ 0 & yz \end{pmatrix}$ is not gradable for $(p, q) \neq (2, 2)$ and $\lambda \in \mathbb{k}^*$, since its first Fitting ideal $(x, yz, y^p + \lambda z^q)$ is not graded.

Remark 8.8. In recent works of Sheridan [70, Theorem 1.2] and Abouzaid et al. [1, Section 7.3] a version of the homological mirror symmetry for the category $\underline{\text{CM}}^{\text{lf}}(A)$ was established. We hope that our result will contribute to a better understanding of the Fukaya side of this correspondence. In particular, it would be interesting to describe explicitly the symplectic images of rank one matrix factorizations obtained in this subsection.

8.2. Maximal Cohen–Macaulay modules over $\mathbb{k}\llbracket x, y, u, v \rrbracket / (xy, uv)$. It seems that the only concrete examples of families of indecomposable maximal Cohen–Macaulay modules over surface singularities, which have been constructed so far, deal with the case of hypersurface singularities. From this perspective it is particularly interesting to consider the case of the degenerate cusp $A = \mathbb{k}\llbracket x, y, u, v \rrbracket / (xy, uv)$. Indecomposable maximal Cohen–Macaulay modules over A can be described using essentially the same technique as in Subsection 8.1. Since the computations do not contain any new phenomena, we omit them and only state the final result.

Proposition 8.9. *Denote $J = \langle (xu)^2, (xv)^2, (yu)^2, (yv)^2 \rangle_A$. Let M be a rank one object in $\text{CM}^{\text{lf}}(A)$. Then $M \cong M(\omega, \lambda) :=$*

$$\left\langle J, x^{m_1+1}u + \lambda x^{m_2+1}v, u^{n_1+1}y + u^{n_2+1}x, y^{p_1+1}v + y^{p_2+1}u, v^{q_1+1}x + v^{q_2+1}y \right\rangle_A^{\vee\vee} \subseteq A$$

for some $\omega = ((m_1, m_2), (n_1, n_2), (p_1, p_2), (q_1, q_2)) \in \mathbb{Z}^8$ and $\lambda \in \mathbb{k}^*$, where

$$\min(m_1, m_2) = \min(n_1, n_2) = \min(p_1, p_2) = \min(q_1, q_2) = 1.$$

Moreover, $M(\omega, \lambda) \cong M(\omega', \lambda')$ if and only if $\omega = \omega'$ and $\lambda = \lambda'$.

Remark 8.10. Let $m_1 = n_1 = p_1 = q_1 = 1$ and $m_2 = m, n_2 = n, p_2 = p, q_2 = q$.

- If $m = n = p = q = 1$ and $\lambda = 1$ then $M(\omega, \lambda) \cong A$.
- Otherwise, we have:

$$M(\omega, \lambda) \cong \langle x^2u + \lambda x^{m+1}v, u^2y + u^{n+1}x, y^2v + y^{p+1}u, v^2x + v^{q+1}y \rangle_A \subseteq A.$$

- Moreover, $M(\omega, \lambda)$ has a presentation

$$A^8 \xrightarrow{\begin{pmatrix} y & 0 & 0 & 0 & v & u^n & 0 & 0 \\ 0 & v & 0 & 0 & 0 & x & y^p & 0 \\ 0 & 0 & x & 0 & 0 & 0 & u & v^q \\ 0 & 0 & 0 & u & \lambda x^m & 0 & 0 & y \end{pmatrix}} A^4 \longrightarrow M(\omega, \lambda) \longrightarrow 0.$$

□

8.3. Maximal Cohen–Macaulay modules over $\mathbb{k}\llbracket x, y, z, u, v \rrbracket / (xz, xu, yu, yv, zv)$. It seems that even less is known about a concrete description of maximal Cohen–Macaulay modules over Gorenstein surface singularities which are not complete intersections. In this subsection we elaborate the classification of rank one objects of $\text{CM}^{\text{lf}}(A)$ for $A = \mathbb{k}\llbracket x, y, z, u, v \rrbracket / (xz, xu, yu, yv, zv)$. Again, all necessary computations are completely parallel to the ones done in Subsection 8.1. Hence, we omit them and state the final result.

Proposition 8.11. *Denote $J = \langle (xy)^2, (yz)^2, (zu)^2, (uv)^2, (vx)^2 \rangle_A$. Let M be a rank one object in $\text{CM}^{\text{lf}}(A)$. Then $M \cong M(\omega, \lambda) :=$*

$$\left\langle J, v^{m_1+1}x + \lambda v^{m_2+1}u, x^{n_1+1}y + x^{n_2+1}v, y^{p_1+1}z + y^{p_2+1}x, z^{q_1+1}u + z^{q_2+1}y, u^{t_1+1}v + u^{t_2+1}z \right\rangle_A^{\vee\vee}$$

for some $\omega = ((m_1, m_2), (n_1, n_2), (p_1, p_2), (q_1, q_2), (t_1, t_2)) \in \mathbb{Z}^{10}$ and $\lambda \in \mathbb{k}^*$, where

$$\min(m_1, m_2) = \min(n_1, n_2) = \min(p_1, p_2) = \min(q_1, q_2) = \min(t_1, t_2) = 1.$$

Moreover, $M(\omega, \lambda) \cong M(\omega', \lambda')$ if and only if $\omega = \omega'$ and $\lambda = \lambda'$.

Remark 8.12. Let $m_1 = n_1 = p_1 = q_1 = t_1 = 1$, whereas $m_2 = m, n_2 = n, p_2 = p, q_2 = q$ and $t_2 = t$. If $m = n = p = q = t = 1$ and $\lambda = 1$ then $M(\omega, \lambda) \cong A$. Otherwise, we have:

$$M(\omega, \lambda) \cong \langle v^2x + \lambda v^{m+1}u, x^2y + x^{n+1}z, y^2z + y^{p+1}x, z^2u + z^{q+1}y, u^2v + u^{t+1}z \rangle_A \subseteq A.$$

□

9. SINGULARITIES OBTAINED BY GLUING CYCLIC QUOTIENT SINGULARITIES

In this section we recall the definition and some basic properties of an important class of non-isolated surface singularities called “degenerate cusps”, see [71, 73].

9.1. Non-isolated surface singularities obtained by gluing normal rings. Let \mathbb{k} be an algebraically closed field and $(R_1, \mathfrak{n}_1), (R_2, \mathfrak{n}_2), \dots, (R_t, \mathfrak{n}_t)$ be complete local normal \mathbb{k} -algebras of Krull dimension two, where $t \geq 1$. For any $1 \leq i \leq t$ let $\pi_i : R_i \longrightarrow \bar{R}_i \cong \mathbb{k}\llbracket \bar{u}_i, \bar{v}_i \rrbracket / (\bar{u}_i \bar{v}_i)$ be a surjective ring homomorphism, $u_i, v_i \in R_i$ be some preimages of \bar{u}_i and \bar{v}_i respectively and $I_i = \ker(\pi_i)$. Consider the ring homomorphism

$$\tilde{\pi}_i := (\tilde{\pi}_i^{(1)}, \tilde{\pi}_i^{(2)}) : R_i \longrightarrow D := \mathbb{k}\llbracket u \rrbracket \times \mathbb{k}\llbracket v \rrbracket$$

obtained by composing π_i with the normalization map $\mathbb{k}\llbracket \bar{u}_i, \bar{v}_i \rrbracket / (\bar{u}_i \bar{v}_i) \rightarrow \mathbb{k}\llbracket u \rrbracket \times \mathbb{k}\llbracket v \rrbracket$.

Definition 9.1. In the above notations, consider the subring A of the ring $R := R_1 \times R_2 \times \dots \times R_t$ defined as

$$(9.1) \quad A := \left\{ (r_1, r_2, \dots, r_t) \in R \mid \tilde{\pi}_i^{(2)}(r_i) = \tilde{\pi}_{i+1}^{(1)}(r_{i+1}), 1 \leq i \leq t \right\},$$

where we identify R_{t+1} with R_1 and π_{t+1} with π_1 .

Proposition 9.2. *In the above notations we have:*

- (1) *The ring A is local and reduced. The ring extension $A \subseteq R$ is finite.*

- (2) Let $I := \{(r_1, r_2, \dots, r_t) \in R \mid \pi_i(r_i) = 0, 1 \leq i \leq t\}$. Then $I = \text{Hom}_A(R, A)$. In other words, I is the conductor ideal.
- (3) The ring A is Noetherian and complete and R is its normalization. In particular, A has Krull dimension two.
- (4) We have: $\bar{A} := A/I \cong \mathbb{k}[[\bar{w}_1, \bar{w}_2, \dots, \bar{w}_t]]/(\bar{w}_i \bar{w}_j \mid 1 \leq i < j \leq t)$ and $\bar{R} = R/I = \mathbb{k}[[\bar{u}_1, \bar{v}_1]]/(\bar{u}_1 \bar{v}_1) \times \dots \times \mathbb{k}[[\bar{u}_t, \bar{v}_t]]/(\bar{u}_t \bar{v}_t)$. The canonical morphism $\bar{A} \rightarrow \bar{R}$ maps \bar{w}_i to $\bar{v}_i + \bar{u}_{i+1}$ for all $1 \leq i \leq t$, where $\bar{u}_{t+1} = \bar{u}_1$.
- (5) The ring A is Cohen-Macaulay.

Proof. (1) Let $r = (r_1, r_2, \dots, r_t) \in R$ be an element of A . Then $r_1(0) = r_2(0) = \dots = r_t(0) \in \mathbb{k}$ and r is invertible if and only if $r_1(0) \neq 0$. This shows that A is local. Since A is a subring of a reduced ring, it is reduced, too. To show that the ring extension $A \subseteq R$ is finite, we consider separately the following two cases.

Case 1. Let $t \geq 2$ and e_1, e_2, \dots, e_t be the idempotent elements of R corresponding to the units of the rings R_1, R_2, \dots, R_t . Then we have: $R = \langle e_1, e_2, \dots, e_t \rangle_A$. Indeed, let $r = (r_1, r_2, \dots, r_t) \in R$ be an arbitrary element. By the definition, we have: $r_i = e_i \cdot r$ and $r = r_1 + r_2 + \dots + r_t$. Hence, it is sufficient to show that for any $1 \leq i \leq t$ and any $r_i \in R_i$ we have: $r_i \in \langle e_1, e_2, \dots, e_t \rangle_A$.

To prove this, it is sufficient to show the following statement: given an element $r_i \in R_i$ there exist such elements $r_j \in R_j, j \neq i$ that $r = (r_1, r_2, \dots, r_t) \in A$. Note that without loss of generality we may assume $r_i \in \mathfrak{n}_i$. Then $\tilde{\pi}_i(r_i) \in D$ belongs to the radical $\bar{\mathfrak{n}}$ of the ring D . Since the ring homomorphism $\tilde{\pi}_i : R_i \rightarrow D$ induces a surjective map $\mathfrak{n}_i \rightarrow \bar{\mathfrak{n}}$, there exist elements $r_j \in \mathfrak{n}_j, j \in \{i-1, i+1\}$ such that $\tilde{\pi}_i^{(1)}(r_i) = \tilde{\pi}_{i-1}^{(2)}(r_{i-1})$ and $\tilde{\pi}_i^{(2)}(r_i) = \tilde{\pi}_{i+1}^{(1)}(r_{i+1})$. Proceeding by induction, we get an element $r = (r_1, r_2, \dots, r_t) \in A$ we are looking for.

Case 2. Let $t = 1$ and $u = u_1, v = v_1 \in R$ be some preimages of the elements $\bar{u} = \bar{u}_1$ and $\bar{v} = \bar{v}_1 \in \bar{R}$ under the map $\bar{\pi} = \bar{\pi}_1$. Then we have: $R = \langle u, v \rangle_A$.

Indeed, any element $r \in R$ can be written as $r = c + up(u) + vq(v) + r'$ for some power series $p, q \in \mathbb{k}[[T]]$, a scalar $c \in \mathbb{k}$ and $r' \in I = \ker(\bar{\pi}) \subseteq A$. Let $\bar{w} = \bar{u} + \bar{v} \in \bar{R}$ and $w \in R$ be its preimage in $A \subseteq R$. Then the element $r'' := r - up(w) - vq(w)$ belongs to I , hence to A , and the result follows.

(2) Since π is a ring homomorphism, it is clear that I is an ideal in R and A . We need to show that $I = J := \text{ann}_A(R/A) = \{a \in A \mid aR \subseteq A\}$. The inclusion $I \subseteq J$ is obvious. Hence, we have to show that $J \subseteq I$.

Since J is an ideal in R , we have an isomorphism of R -modules $J = J_1 \oplus J_2 \oplus \dots \oplus J_t$, where J_i is an ideal in R_i for all $1 \leq i \leq t$. Again, we distinguish two cases.

Case 1. Let $t \geq 2$ and $a = (a_1, a_2, \dots, a_t) \in J$, where $a_i = e_i \cdot a, 1 \leq i \leq t$. In order to show that $a \in I$ it is sufficient to prove that $\pi_i(a_i) = 0$ for all $1 \leq i \leq t$.

By the definition, the element $a_i = e_i \cdot a = (0, \dots, 0, a_i, 0, \dots, 0)$ belongs to $J \subseteq A$ for all $1 \leq i \leq t$. It implies that $\tilde{\pi}_i^{(k)}(a_i) = 0$ for $k = 1, 2$, thus $\pi_i(a_i) = 0$ for all $1 \leq i \leq t$ as wanted.

Case 2. Let $t = 1$. Then any element $a \in A$ can be written in the form $a = p(w) + a'$, where $p(T) \in \mathbb{k}[[T]]$ is a formal power series and $a' \in I$. If a belongs to J then we have:

$$\tilde{\pi}^{(1)}(ua) = up(u) = \tilde{\pi}^{(2)}(ua) = 0.$$

Hence, $p(T) = 0$ and $a = a' \in I$.

(3) Since R is a Noetherian ring and I is an ideal in R , I is a finitely generated R -module. Next, R is a finite module over A , hence there exist elements $c_1, c_2, \dots, c_l \in I$ such that $I = \langle c_1, c_2, \dots, c_l \rangle_A$. For any $1 \leq i \leq t$ let $w_i = v_i + u_{i+1} \in A$. Then any element $a \in A$ can be written in the form $a = \sum_{i=1}^t p_i(w_i) + c$, where $c \in I$ and $p_i(T) \in \mathbb{k}[[T]]$, $1 \leq i \leq t$ are

some power series. Consider the ring homomorphism $S := \mathbb{k}[[x_1, \dots, x_t; z_1, \dots, z_l]] \xrightarrow{\varphi} R$ defined by the rule: $\varphi(x_i) = w_i$ for all $1 \leq i \leq t$ and $\varphi(z_j) = c_j$ for all $1 \leq j \leq l$. It is clear that the image of φ belongs to A . In order to show A is Noetherian and complete, it is sufficient to prove that the ring homomorphism $\varphi : S \rightarrow A$ is surjective.

For any integer $q \geq 1$, let \check{A}_q be the image of A under the canonical morphism $R \rightarrow R/\mathfrak{n}^q$. To show φ is surjective it suffices to prove that the ring homomorphism $S \rightarrow \check{A}_q$ is surjective for all $q \geq 1$. Any element $a \in A$ can be written as

$$a = \sum_{i=1}^t p_i(w_i) + \sum_{j=1}^l b'_j c_j + \sum_{j=1}^l b''_j c_j$$

where $p_1, \dots, p_t \in \mathbb{k}[[T]]$, $b'_1, \dots, b'_l \in \mathbb{k}$ and $b''_1, \dots, b''_l \in I$. Then

$$a^{(1)} := \sum_{i=1}^t p_i(w_i) + \sum_{j=1}^l b'_j c_j \in \text{Im}(\varphi) \quad \text{and} \quad a - a^{(1)} \in \mathfrak{n}^2.$$

Writing similar expansions for $b''_1, \dots, b''_l \in I \subseteq A$, we end up with a sequence of elements $\{a^{(n)}\}_{n \geq 1}$ such that $a^{(n)} \in \text{Im}(\varphi)$ and $a - a^{(n)} \in \mathfrak{n}^{n+1}$ for all $n \geq 1$. This shows the surjectivity of φ .

We have shown that the ring A is Noetherian and the ring extension $A \subseteq R$ is finite. Hence, A has Krull dimension two. Moreover, the total rings of fractions of A and R are equal. Indeed, if $t \geq 2$ then $R = \langle e_1, \dots, e_t \rangle_A$, where all elements $e_i \in R$ satisfy the equation $e_i^2 = e_i$, hence $e_i \in Q(A)$. For $t = 1$ we have the equality $u^2 - uw + uv = 0$, where $w \in A$ and $uv \in I \subseteq A$. Hence, $u \in Q(A)$. In a similar way, $v \in Q(A)$. Thus, in both cases we have $Q(A) = Q(R)$, hence R is the normalization of A .

(4) Recall that we have: $\bar{R} = R/I = \mathbb{k}[[\bar{u}_1, \bar{v}_1]]/(\bar{u}_1 \bar{v}_1) \times \dots \times \mathbb{k}[[\bar{u}_t, \bar{v}_t]]/(\bar{u}_t \bar{v}_t)$. By the definition, the ring $\bar{A} \subseteq \bar{R}$ is generated by power series in the elements $\bar{w}_i = \bar{v}_i + \bar{u}_{i+1}$, where $1 \leq i \leq t$.

In \bar{R} we have the relations $\bar{w}_i \bar{w}_j = 0$ for all $i \neq j$. Assume there exists an additional relation in \bar{A} between $\bar{w}_1, \dots, \bar{w}_t$. Then it has necessarily the form: $\bar{w}_i^n = 0$ for some $1 \leq i \leq t$ and $n \geq 1$. But this implies that we have the relations $\bar{v}_i^n = 0 = \bar{u}_{i+1}^n$. Contradiction. Hence, we have: $\bar{A} \cong \mathbb{k}[[\bar{w}_1, \bar{w}_2, \dots, \bar{w}_t]]/(\bar{w}_i \bar{w}_j \mid 1 \leq i < j \leq t)$ and the canonical imbedding $\bar{A} \rightarrow \bar{R}$ is given by the rule $\bar{w}_i \mapsto \bar{v}_i + \bar{u}_{i+1}$.

(5) We have a short exact sequence of Noetherian A -modules $0 \rightarrow A \rightarrow R \rightarrow R/A \rightarrow 0$. Since R is a normal surface singularity, it is Cohen-Macaulay. In particular,

$$\text{depth}_R(R) = 2 = \text{depth}_A(R).$$

Next, the A -module R/A is annihilated by I , hence it is an \bar{A} -module. Moreover, we have an isomorphism of \bar{A} -modules $R/A \cong \bar{R}/\bar{A}$. Our goal is to show that $\text{depth}_{\bar{A}}(\bar{R}/\bar{A}) = 1$. It is equivalent to the statement that the \bar{A} -module \bar{R}/\bar{A} has no finite length submodules. Let $\bar{\mathfrak{m}}$ be the maximal ideal of \bar{A} . It suffices to show that there is no element $r \in \bar{R} \setminus \bar{A}$ such that $\bar{\mathfrak{m}} \cdot r \in \bar{A}$.

Let $p_i, q_i \in \mathbb{k}[[T]]$ be power series such that $p_i(0) = q_i(0)$ for all $1 \leq i \leq t$ and $r = ((p_1(\bar{u}_1), q_1(\bar{v}_1)), \dots, (p_t(\bar{u}_t), q_t(\bar{v}_t))) \in \bar{R}$ be an element satisfying $\bar{w}_i \cdot r \in A$. But this implies that for all $1 \leq i \leq t$ we have equalities of the power series $Tq_i(T) = Tp_{i+1}(T)$. Hence, $q_i = p_{i+1}$ for all $1 \leq i \leq t$ and $r \in \bar{A}$ as wanted. Applying the Depth Lemma we get: $\text{depth}_A(A) = 2$, hence A is Cohen-Macaulay. \square

Summary. In the notations of Proposition 9.2 we have: the ring A is Noetherian, local, reduced, complete and Cohen-Macaulay. The ring R is the normalization of A and I is the conductor ideal. The canonical commutative diagram

$$\begin{array}{ccc} A & \longrightarrow & \bar{A} \\ \downarrow & & \downarrow \\ R & \longrightarrow & \bar{R} \end{array}$$

is a pull-back diagram in the category of Noetherian rings. Moreover, we have:

$$Q(\bar{A}) \cong \mathbb{k}((\bar{w}_1)) \times \dots \times \mathbb{k}((\bar{w}_t)) \text{ and } Q(\bar{R}) \cong (\mathbb{k}((\bar{u}_1)) \times \mathbb{k}((\bar{v}_1))) \times \dots \times (\mathbb{k}((\bar{u}_t)) \times \mathbb{k}((\bar{v}_t)))$$

and the canonical ring homomorphism $Q(\bar{A}) \rightarrow Q(\bar{R})$ sends the element \bar{w}_i to $\bar{v}_i + \bar{u}_{i+1}$.

Lemma 9.3. *In the notations of Proposition 9.2 we have: for any prime ideal $\mathfrak{p} \in \mathcal{P}$ the localization $A_{\mathfrak{p}}$ is either regular or $\hat{A}_{\mathfrak{p}} \cong \mathbb{k}(\mathfrak{p})[[u, v]]/(uv)$, where $\mathbb{k}(\mathfrak{p})$ is the residue field of $A_{\mathfrak{p}}$. In particular, the ring A is Gorenstein in codimension one.*

Proof. Let $\mathfrak{p} \in \mathcal{P}$. By Proposition 3.6, the local ring $A_{\mathfrak{p}}$ is regular unless \mathfrak{p} belongs to the associator of the conductor ideal I . Let $\bar{\mathfrak{p}}$ be the image of \mathfrak{p} in \bar{A} . Then $\bar{\mathfrak{p}}$ is a prime ideal in \bar{A} of height zero, $R_{\bar{\mathfrak{p}}}$ is the normalization of $A_{\mathfrak{p}}$, $I_{\bar{\mathfrak{p}}}$ is the conductor ideal of $A_{\mathfrak{p}}$ and we have a pull-back diagram

$$\begin{array}{ccc} A_{\mathfrak{p}} & \longrightarrow & \bar{A}_{\bar{\mathfrak{p}}} \\ \downarrow & & \downarrow \\ R_{\mathfrak{p}} & \longrightarrow & \bar{R}_{\bar{\mathfrak{p}}} \end{array}$$

in the category of Noetherian rings. Since we know that $\bar{A} \cong \mathbb{k}[[\bar{w}_1, \bar{w}_2, \dots, \bar{w}_t]]/(\bar{w}_i \bar{w}_j \mid 1 \leq i < j \leq t)$, we have: $\bar{\mathfrak{p}} = \langle \bar{w}_1, \dots, \bar{w}_{i-1}, \bar{w}_{i+1}, \dots, \bar{w}_t \rangle$ for some $1 \leq i \leq t$. We get: $\bar{A}_{\bar{\mathfrak{p}}} = \mathbb{k}((\bar{w}_i))$ and $\bar{R}_{\bar{\mathfrak{p}}} = \mathbb{k}((\bar{v}_i)) \times \mathbb{k}((\bar{u}_{i+1}))$. Hence, the conductor ideal of the local one-dimensional ring $A_{\mathfrak{p}}$ is its maximal ideal. Next, $A_{\mathfrak{p}}$ contains its residue field $\mathbb{k}((t))$ and there exists a pull-back diagram

$$\begin{array}{ccc} A_{\mathfrak{p}} & \longrightarrow & \mathbb{k}((t)) \\ \downarrow & & \downarrow \\ R_{\mathfrak{p}} & \longrightarrow & \mathbb{k}((t)) \times \mathbb{k}((t)). \end{array}$$

Hence, the completion of $A_{\mathfrak{p}}$ is isomorphic to $\mathbb{k}((t))[[u, v]]/(uv)$, as wanted. \square

9.2. Generalities about cyclic quotient singularities. Let $S = \mathbb{k}[[u, v]]$ and $G = C_{n,m} \subset \text{GL}_2(\mathbb{k})$ be a small cyclic subgroup of order n . Then without loss of generality we may assume that G is generated by the matrix $g = \begin{pmatrix} \xi & 0 \\ 0 & \xi^m \end{pmatrix}$, where ξ is a primitive n -th root of unity, and $0 \leq m < n$ is such that $\text{gcd}(m, n) = 1$. The group G acts on S by

the rule $u \xrightarrow{g} \xi u$, $v \xrightarrow{g} \xi^m v$. Let $R = R(n, m) = S^G$ be the corresponding ring of invariants and $\Pi = \Pi(n, m) = \{0, 1, \dots, n-1\}$. For an element $l \in \Pi$ we denote by \bar{l} the unique element in Π such that $l = \bar{l}m \pmod{n}$. The following result is due to Riemenschneider [65]

Theorem 9.4. *In the above notations we have:*

- (1) $R = \mathbb{k}\llbracket u^n, u^{n-1}v^{\bar{1}}, \dots, uv^{\overline{n-1}}, v^n \rrbracket \subset S = \mathbb{k}\llbracket u, v \rrbracket$.
- (2) *More precisely, let $n/(n-m) = a_1 - 1/(a_2 - \dots - 1/a_e)$ be the expansion of $n/(n-m)$ into a continuous fraction, where $a_i \geq 2$ for all $1 \leq i \leq e$. Define the positive integers c_i and d_i by the following recurrent formulae:*

$$c_0 = n, c_1 = n - m, c_{i+1} = a_i c_i - c_{i-1}, \quad d_0 = 0, d_1 = 1, d_{i+1} = a_i d_i - d_{i-1}.$$

Then $R = \mathbb{k}\llbracket x_0, x_1, \dots, x_e, x_{e+1} \rrbracket / L$, where $x_i = u^{c_i} v^{d_i}$ ($i = 0, 1, \dots, e+1$) and the ideal $L \subset \mathbb{k}\llbracket x_0, x_1, \dots, x_e, x_{e+1} \rrbracket$ is generated by the relations

$$(9.2) \quad x_{i-1} x_{j+1} = x_i x_j \prod_{k=i}^j x_k^{a_k - 2} \quad 1 \leq i \leq j \leq e.$$

- (3) *Let J be the ideal in R generated by (x_1, x_2, \dots, x_e) . Then $J = (u^{n-1}v^{\bar{1}}, \dots, uv^{\overline{n-1}})_R$ and $\bar{R} := R/J = \mathbb{k}\llbracket x_0, x_{e+1} \rrbracket / (x_0 x_{e+1}) \cong D = \mathbb{k}\llbracket x, y \rrbracket / (xy)$.*
- (4) *The closed subset $V(J) \subset \mathbf{Spec}(R)$ is the image of the union of the coordinate axes $V(uv) \subset \mathbf{Spec}(S)$ under the map $\mathbf{Spec}(S) \rightarrow \mathbf{Spec}(R)$.*

In what follows we shall also need the following result of Brieskorn [12, Satz 2.10] about the exceptional divisor of a minimal resolution of singularities of $\mathbf{Spec}(R)$.

Theorem 9.5. *Let $X = \mathbf{Spec}(R)$, $o = \{\mathfrak{m}\} \in X$ be its unique closed point and $\tilde{X} \xrightarrow{\pi} X$ be a minimal resolution of singularities. Then the exceptional divisor $E = \pi^{-1}(o)$ is a tree of projective lines. More precisely, the dual graph of E is*

$$\begin{array}{ccccccc} b_1 & \text{---} & b_2 & \text{---} & \dots & \text{---} & b_f \\ \bullet & & \bullet & & & & \bullet \end{array}$$

where $n/m = b_1 - 1/(b_2 - \dots - 1/b_f)$ is the expansion of n/m into a continuous fraction such that and $b_i \geq 2$ for all $1 \leq i \leq f$.

9.3. Degenerate cusps and their basic properties. In this subsection we recall the definition of an important class of non-isolated surface singularities called *degenerate cusps*.

Definition 9.6. Let $t \geq 1$ and $\underline{w} = ((n_1, m_1), (n_2, m_2), \dots, (n_t, m_t)) \in (\mathbb{Z}^2)^t$ be a collection of integers such that $0 \leq m_i < n_i$ and $\gcd(m_i, n_i) = 1$ for all $1 \leq i \leq t$. Let $R_i = R(n_i, m_i) = \mathbb{k}\llbracket u_i, v_i \rrbracket^{C_{n_i, m_i}} \subseteq \mathbb{k}\llbracket u_i, v_i \rrbracket$ be the corresponding cyclic quotient singularity (in our convention, $R_i = \mathbb{k}\llbracket u_i, v_i \rrbracket$ if $(n_i, m_i) = (1, 0)$), $J_i \subseteq R_i$ the ideal defined in Theorem 9.4 and $A = \tilde{A}(\underline{w}) \subseteq R_1 \times R_2 \times \dots \times R_t =: R$ be the ring obtained by the construction of Definition 9.1. Then A is called *degenerate cusp of type \underline{w}* .

Lemma 9.7. *Given a local complete \mathbb{k} -algebra A , which is a degenerate cusp. Then its type \underline{w} is uniquely determined up to an action of the dihedral group D_t (i.e. up to a shift and reflection).*

Sketch of a proof. Let $X = \mathbf{Spec}(A)$ and $Y \xrightarrow{\pi} X$ be its *improvement*, see [71] and [73, 74]. Let $o = \{\mathfrak{m}\} \in X$ be the unique closed point of X and $Z = \pi^{-1}(o)$ be the exceptional divisor. Then Z is a cycle of projective lines. Moreover, Z is a union of trees of projective lines: $Z = Z_1 \cup Z_2 \cup \dots \cup Z_t$, where each Z_i is isomorphic to the exceptional divisor E_i of a

minimal resolution \tilde{X}_i of the cyclic quotient singularity $\text{Spec}(R(n_i, m_i))$. The irreducible components of each tree Z_i have the same intersection multiplicities in Y as the intersection multiplicities of the corresponding irreducible components of E_i in \tilde{X}_i . These components E_1, E_2, \dots, E_t intersect precisely at those points of E , where the variety Y is not smooth. Thus, Theorem 9.5 allows to reconstruct the parameters $(n_1, m_1), (n_2, m_2), \dots, (n_t, m_t)$ as well as the order of gluing of the corresponding cyclic quotient singularities. \square

The following important result is due to Shepherd–Barron [71, Lemma 1.1].

Theorem 9.8. *Let A be a degenerate cusp. Then A is Gorenstein.*

9.4. Irreducible degenerate cusps. In this subsection we write down equations of irreducible degenerate cusps. Let $\bar{R} = \mathbb{k}[[x_0, x_1, \dots, x_e, x_{e+1}]]/L$ be a cyclic quotient singularity (9.2) and $J \subset \bar{R}$ be the ideal defined by (x_1, \dots, x_e) . Then $\bar{R} := \bar{R}/J = \mathbb{k}[[x_0, x_{e+1}]]/x_0x_{e+1}$ and we define the ring A via the pull-back diagram in the category of commutative rings

$$(9.3) \quad \begin{array}{ccc} A & \longrightarrow & \bar{A} \\ \downarrow & & \downarrow \gamma \\ R & \longrightarrow & \bar{R}, \end{array}$$

where $\bar{A} = \mathbb{k}[[\bar{z}]]$ and $\gamma : \bar{A} \rightarrow \bar{R}$ maps \bar{z} to $\bar{x}_0 + \bar{x}_{e+1}$. Our goal is to write explicitly a list of generators and relations of the ring A .

Case 1. Consider first case when the cyclic group is trivial and $R = \mathbb{k}[[u, v]]$. Then the ring A is generated by the power series in $x = u + v$, $y = uv$ and $z = u^2v$. In the quotient ring $Q(R)$ we have the equalities

$$u = \frac{z}{y} \quad \text{and} \quad v = \frac{xy - z}{y}.$$

The equality $y = uv$ implies the relation: $y^3 + z^2 - xyz = 0$. We have a ring homomorphism $\pi : \mathbb{k}[[x, y, z]] \rightarrow R$ defined by the formulae $x \mapsto u + v$, $y \mapsto uv$ and $z \mapsto u^2v$, whose image is the ring A . Moreover, $y^3 + z^2 - xyz$ belongs to $\ker(\pi)$. If $\ker(\pi)$ has further generators then $\mathbb{k}[[x, y, z]]/\ker(\pi)$ has Krull dimension which is not bigger than one. Contradiction. Hence, A is a hypersurface singularity

$$(9.4) \quad A = \mathbb{k}[[x, y, z]]/(y^3 + z^2 - xyz).$$

Case 2. Let $e = 1$, $n \geq 2$ and $m = n - 1$. Then $R = \mathbb{k}[[u, v, w]]/(v^n - uw)$ and $J = (v)$. As in the previous case, one can show that A is generated by the power series in $x = v$, $y = uv$ and $z = u + w$. In the quotient ring $Q(R)$ we have the equalities

$$u = \frac{y}{x} \quad \text{and} \quad w = \frac{xz - y}{x}.$$

Hence, the relation $uw = v^n$ reads as $x^{n+2} + y^2 = xyz$. As in the previous case, we get:

$$(9.5) \quad A = \mathbb{k}[[x, y, z]]/(x^{n+2} + y^2 - xyz).$$

Since $x^{n+2} + y^2 - xyz = x^{n+2} + (y - \frac{1}{2}xz)^2 + \frac{1}{4}x^2z^2$, the equation of A can be rewritten in the form $A = \mathbb{k}[[x, y, z]]/(x^2(x^n + z^2) + y^2)$.

Case 3. Let $e = 2$ and $n/(n - m) = p - 1/q = (pq - 1)/q$, where $p, q \geq 2$. The ring $R = \mathbb{k}[[x_0, x_1, x_2, x_3]]/L$ is given by Riemenschneider's relations

$$x_0x_2 = x_1^p, \quad x_1x_3 = x_2^q \quad \text{and} \quad x_0x_3 = x_1^{p-1}x_2^{q-1}.$$

The subring $A \subset R$ is generated by the elements $x = x_1$, $y = x_2$ and $z = x_0 + x_3$. We have the following equality in R : $x_1^{p+1} + x_2^{q+1} = x_1x_2(x_0 + x_3)$. Hence, we get:

$$(9.6) \quad A = \mathbb{k}[[x, y, z]]/(x^{p+1} + y^{q+1} - xyz), \quad p, q \geq 2.$$

Summing up, in all considered cases we get the singularities

$$T_{pq\infty} = \mathbb{k}[[x, y, z]]/(x^p + y^q - xyz),$$

where $p \geq q \geq 2$ and $(p, q) \neq (2, 2)$.

Case 4. Let $e = 3$ and $n/(n - m) = p - 1/(q - 1/r)$, where $p, q, r \geq 2$. Then $R = \mathbb{k}[[u, x, y, z, v]]/L$, where the Riemenschneider's relations are:

$$(9.7) \quad uy = x^p, \quad xz = y^q, \quad yv = z^r, \quad uz = x^{p-1}y^{q-1}, \quad xv = y^{q-1}z^{r-1}, \quad uv = x^{p-1}y^{q-2}z^{r-1}.$$

The ring A is generated by the power series in the elements $w = u + v$, x, y and z . Next, we have the following equality in R : $wy^q = wxz = (u + v)xz = x^py^{q-1} + y^{q-1}z^r$, implying the equality $wy = x^p + z^r$. One can show that in this case we have:

$$A = \mathbb{k}[[x, y, z, w]]/(xz - y^q, yw - x^p - z^r)$$

for $p, q, r \geq 2$. In other words, A is a $T_{prq\infty}$ -singularity.

Case 5. For $e \geq 4$ the ring A is no longer a complete intersection. For the sake of completeness, we write its presentation via generators and relations as well. Let $0 < m < n$ be coprime integers and

$$\frac{n}{n - m} = a_1 - 1/(a_2 - \dots - 1/a_e),$$

the expansion of $n/(n - m)$ into a continuous fraction, where $a_i \geq 2$ for all $1 \leq i \leq e$. Then one can show that $A = \mathbb{k}[[x_1, x_2, \dots, x_e, z]]/L$, where the ideal L is generated by

$$(9.8) \quad \left\{ \begin{array}{l} zx_2 = x_1^{a_1} + x_3 \left(\prod_{l=3}^e x_l^{a_l-2} \right) x_e, \\ zx_{e-1} = x_1 \left(\prod_{l=1}^{e-2} x_l^{a_l-2} \right) x_{e-2}, \\ zx_i = x_1 \left(\prod_{l=1}^{i-1} x_l^{a_l-2} \right) x_{i-1} + x_{i+1} \left(\prod_{l=i+1}^e x_l^{a_l-2} \right) x_e, \quad 2 < i < e - 2, \\ x_{i-1}x_{j+1} = x_i \left(\prod_{k=i}^j x_k^{a_k-2} \right) x_j, \quad 2 \leq i \leq j \leq e - 1. \end{array} \right.$$

9.5. Other cases of degenerate cusps which are complete intersections. In this subsection we describe all other cases of degenerate cusps which are complete intersections.

Case 6. Let $R = \mathbb{k}[[x_1, x_2]] \times \mathbb{k}[[y_1, y_2]]$. Then A is generated by the power series in the elements $x = (x_1, y_2)$, $y = (x_2, y_1)$ and $z = (x_1x_2, 0)$. The following relation is obviously satisfied: $xyz = z^2$. Hence, we have:

$$(9.9) \quad A = \mathbb{k}[[x, y, z]]/(xyz - z^2) \cong \mathbb{k}[[x, y, z]]/(x^2y^2 + z^2).$$

Case 7. Let $R = \mathbb{k}[[x_1, x_2]] \times \mathbb{k}[[y_0, y_1, y_2]]/(y_0y_2 - y_1^p)$, $p \geq 2$. Then A is generated by the power series in the elements $x = (x_1, y_0)$, $y = (x_2, y_2)$ and $z = (0, y_1)$. Moreover, we have: $xyz = z^{p+1}$ and

$$(9.10) \quad A = \mathbb{k}[[x, y, z]]/(xyz - z^{p+1}), \quad p \geq 2.$$

In other words, Case 6 and Case 7 yield the class of $T_{p\infty\infty}$ -singularities.

Case 8. Let $R = \mathbb{k}[[x_1, x_2]] \times \mathbb{k}[[y_1, y_2]] \times \mathbb{k}[[z_1, z_2]]$. Then the ring A is generated by the power series in the elements $x = (x_2, y_1, 0)$, $y = (0, y_2, z_1)$ and $z = (x_1, 0, z_2)$. They satisfy the relation $xyz = 0$ and we have:

$$(9.11) \quad A = \mathbb{k}[[x, y, z]]/(xyz).$$

This is a singularity of type $T_{\infty\infty\infty}$.

Case 9. Let $R = \mathbb{k}[[x_0, x_1, x_2]]/(x_0x_2 - x_1^p) \times \mathbb{k}[[y_0, y_1, y_2]]/(y_0y_2 - y_1^q)$, $p, q \geq 2$. Then the degenerate cusp A is generated by the power series in the elements

$$x = (x_0, y_2), y = (x_2, y_0), z = (x_1, 0) \quad \text{and} \quad w = (0, y_1).$$

We have the following equalities in R : $xy = z^p + w^q$ and $zw = 0$. One can show that

$$(9.12) \quad A = \mathbb{k}[[x, y, z, w]]/(z^p + w^q - xy, wz),$$

i.e. A is a singularity of type $T_{pq\infty\infty}$.

Case 10. Let $R = R_1 \times R_2$, where $R_1 = \mathbb{k}[[x_1, x_2]]$ and $R_2 = \mathbb{k}[[y_0, y_1, y_2, y_3]]/(y_0y_2 - y_1^p, y_1y_3 - y_2^q, y_0y_3 - y_1^{p-1}y_2^{q-1})$, where $p, q \geq 2$. Then A is generated by the power series in the elements $x = (x_1, y_3)$, $y = (x_2, y_0)$, $z = (0, y_1)$, $w = (0, y_2)$ and we have:

$$(9.13) \quad A = \mathbb{k}[[x, y, z, w]]/(yw - z^p, xz - w^q)$$

is a singularity of type $T_{p\infty q\infty}$.

Case 11. Let $R = \mathbb{k}[[x_1, x_2]] \times \mathbb{k}[[y_1, y_2]] \times \mathbb{k}[[z_0, z_1, z_2]]/(z_0z_2 - z_1^p)$, where $p \geq 2$. Then the ring A is generated by the power series in the elements

$$x = (x_2, y_1, 0), y = (0, y_2, z_0), z = (x_1, 0, z_2), w = (0, 0, z_1).$$

The following relations are satisfied: $xw = 0$ and $yz = w^p$ and we get

$$(9.14) \quad A = \mathbb{k}[[x, y, z, w]]/(xw, yz - w^p).$$

This is a $T_{p\infty\infty\infty}$ -singularity.

Case 12. Let $R = \mathbb{k}[[x_1, x_2]] \times \mathbb{k}[[y_1, y_2]] \times \mathbb{k}[[z_1, z_2]] \times \mathbb{k}[[w_1, w_2]]$. Then A is generated by the power series in the elements

$$x = (x_2, y_1, 0, 0), y = (0, y_2, z_1, 0), z = (0, 0, z_2, w_1) \quad \text{and} \quad w = (x_1, 0, 0, w_2)$$

and we have:

$$(9.15) \quad A = \mathbb{k}[[x, y, z, w]]/(xz, yw)$$

is a singularity of type $T_{\infty\infty\infty\infty}$.

10. MAXIMAL COHEN–MACAULAY MODULES OVER DEGENERATE CUSPS–II

The goal of this section is to deduce the matrix problem describing maximal Cohen–Macaulay modules over the degenerate cusp $A = \hat{A}(\underline{w})$, where $\underline{w} = ((n_1, m_1), \dots, (n_t, m_t))$ with $0 \leq m_i < n_i$ and $\gcd(n_i, m_i) = 1$ for $1 \leq i \leq t$. Recall that the normalization of A is $R = R_1 \times R_2 \times \dots \times R_t$, where each component $R_i = R(n_i, m_i)$, $1 \leq i \leq t$ is a cyclic quotient singularity of type (n_i, m_i) . As a first step, we recall a description of indecomposable maximal Cohen–Macaulay modules over cyclic quotient singularities.

10.1. Maximal Cohen–Macaulay modules on cyclic quotient surface singularities. Let \mathbb{k} be an algebraically closed field of characteristic zero, $S = \mathbb{k}[[u, v]]$ and $G = C_{n,m} \subset \mathrm{GL}_2(\mathbb{k})$ be a cyclic subgroup group of order n generated by the matrix $g = \begin{pmatrix} \xi & 0 \\ 0 & \xi^m \end{pmatrix}$, where ξ is a primitive n -th root of unity, and $0 \leq m < n$ is such that $\mathrm{gcd}(m, n) = 1$. Let $R = R(n, m) = S^G$ be the corresponding ring of invariants, $\Lambda = S * G$ the skew group ring and $\Pi = \{0, 1, \dots, n-1\}$. For $l \in \Pi$ we denote by \bar{l} the unique element in Π such that $l = \bar{l}m \bmod n$. Recall that

$$R = \mathbb{k}[u^n, u^{n-1}v^{\bar{1}}, \dots, uv^{\overline{n-1}}, v^n] \subset S = \mathbb{k}[[u, v]] \subset \Lambda = \mathbb{k}[[u, v]] * G$$

is the center of Λ , $\mathrm{rad}(\Lambda) = (u, v) * G$ and $\Lambda/\mathrm{rad}(\Lambda) \cong \mathbb{k}[G]$. The following result is due to Auslander [4], see also [77, 78].

Theorem 10.1. *Let $\mathrm{Pro}(\Lambda)$ be the category of finitely generated projective left Λ -modules. Then the functor (of taking invariants) $\mathrm{Pro}(\Lambda) \rightarrow \mathrm{CM}(R)$, assigning to a projective module P its invariant part $P^G = \{x \in P \mid g \cdot x = x \text{ for all } g \in G\}$ and to a morphism $P \xrightarrow{f} Q$ its restriction $f|_{P^G}$, is an equivalence of categories.*

Let U be an irreducible representation of G . Then it defines a left Λ -module $P_U := S \otimes_{\mathbb{k}} U$, where an element $p[g] \in \Lambda$ acts on a simple tensor $r \otimes v$ by the rule

$$p[g] \cdot (r \otimes v) = pg(r) \otimes g(v).$$

It is easy to see that P_U is projective and indecomposable and the top of P_U is U viewed as a Λ -module.

Since G is a finite cyclic group, all its irreducible representations are one-dimensional. For any $l \in \Pi$ let $V_l = \mathbb{k}$ be the representation of G determined by the condition $g \cdot 1 = \xi^{-l}$. From Theorem 10.1 we obtain the following description of indecomposable maximal Cohen–Macaulay modules over R .

Corollary 10.2. *There exist precisely n indecomposable maximal Cohen–Macaulay R -modules. For any $l \in \Pi$ the corresponding maximal Cohen–Macaulay R -module I_l is*

$$(10.1) \quad I_l = (S \otimes_{\mathbb{k}} V_l)^G \cong \left\{ \sum_{i,j=0}^{\infty} a_{ij} u^i v^j \mid i + mj = l \bmod n, a_{ij} \in \mathbb{k} \right\} \subset S.$$

In other words, $I_l = \langle u^l, u^{l-1}v^{\bar{1}}, \dots, uv^{\overline{l-1}}, v^{\bar{l}} \rangle_R \subset S$.

Our next goal is to describe the morphisms between the indecomposable maximal Cohen–Macaulay R -modules.

Lemma 10.3. *For any $p \in \Pi$, let $P_p = S \otimes_{\mathbb{k}} V_p$ be the corresponding projective left Λ -module. Next, for any $p, q \in \Pi$ we set:*

$$S_{p,q} = \left\{ \sum_{i,j=0}^{\infty} a_{ij} u^i v^j \mid i + mj = q - p \bmod n, a_{ij} \in \mathbb{k} \right\} \subset S.$$

Then we have:

- For any pair $p, q \in \Pi$ we have an isomorphism of R -modules $S_{p,q} \rightarrow \mathrm{Hom}_{\Lambda}(P_p, P_q)$ assigning to a power series $a \in S_{p,q}$ the map $r \otimes 1 \mapsto ar \otimes 1$.

- Moreover, these isomorphisms are compatible with compositions of morphisms: for any triple $p, q, t \in \Pi$ the diagram

$$\begin{array}{ccc} S_{q,t} \times S_{p,q} & \longrightarrow & \text{Hom}_\Lambda(P_q, P_t) \times \text{Hom}_\Lambda(P_p, P_q) \\ \text{mult} \downarrow & & \downarrow \circ \\ S_{p,t} & \longrightarrow & \text{Hom}_\Lambda(P_p, P_t) \end{array}$$

is commutative.

- In particular, for any $p \in \Pi$ we have an isomorphism of rings

$$R = S_{p,p} \longrightarrow \text{End}_\Lambda(P_p).$$

Proof. We only give a proof of the first statement of this lemma, since the remaining two follow from the first one. For any pair $p, q \in \Pi$ we certainly have:

$$\text{Hom}_\Lambda(P_p, P_q) \subseteq \text{Hom}_S(P_p, P_q) = \text{Hom}_S(S \otimes_{\mathbb{k}} V_p, S \otimes_{\mathbb{k}} V_q) \cong \text{Hom}_S(S, S) \cong S.$$

Hence, any Λ -linear morphism φ from P_p to P_q is given by the multiplication with a certain power series $a \in S$. In other words, $\varphi = \varphi_a$, where $\varphi_a(b \otimes 1) = ab \otimes 1$ for $b \in S$. Since φ_a has to be Λ -linear, we have:

$$\varphi_a(g \cdot (b \otimes 1)) = ag(b) \otimes \xi^{-p} = g \cdot \varphi_a(b \otimes 1) = g(a)g(b) \otimes \xi^{-q},$$

where g is a generator of G . It implies that $g(a) = \xi^{q-p} a$, hence $a \in S_{q-p}$ as stated. \square

Corollary 10.4. *Let P be a projective left Λ -module. Then $P \cong \bigoplus_{p \in \Pi} P_p^{m_p}$ for some uniquely determined multiplicities $m_p \in \mathbb{Z}_+$. Moreover, any endomorphism $\varphi \in \text{End}_\Lambda(P)$ can be written in the matrix form $\varphi = (\varphi_{q,p})$, where $\varphi_{q,p} \in \text{Mat}_{m_p \times m_q}(S_{q,p})$ for all $p, q \in \Pi$. Moreover, φ is an isomorphism if and only if the matrices $\varphi_{p,p}(0) \in \text{Mat}_{m_p \times m_p}(\mathbb{k})$ are invertible for all $p \in \Pi$.*

Lemma 10.5. *Let $J = \langle u^{n-1}v^{\bar{1}}, \dots, \overline{uv^{n-1}} \rangle_R$ be the ideal introduced in Theorem 9.4 and $\bar{R} = R/J$. Then the following statements are true.*

- We have a ring isomorphism $\psi = \psi_0 : D = \mathbb{k}[[x, y]]/(xy) \rightarrow \bar{R}$ given by the formula $\psi(x) = u^n$ and $\psi(y) = v^n$.
- For any $p \in \Pi \setminus \{0\}$ there exists an isomorphism of D -modules

$$\psi_p : \mathbb{k}[[x]] \oplus \mathbb{k}[[y]] \longrightarrow \bar{R} \otimes_R I_p / \text{tor}_{\bar{R}}(\bar{R} \otimes_R I_p)$$

given by $\psi_p(1_x) = [1 \otimes u^p]$ and $\psi_p(1_y) = [1 \otimes v^{\bar{p}}]$.

Proof. The first statement of this lemma is a part of Theorem 9.4. We only give a proof of the second statement.

Since R is a domain and I_p is maximal Cohen–Macaulay over R of rank one, the module $\bar{R} \otimes_R I_p / \text{tor}_{\bar{R}}(\bar{R} \otimes_R I_p)$ is maximal Cohen–Macaulay of multi-rank $(1, 1)$ over the ring D . Hence, it is sufficient to show that ψ_p is well-defined and is an epimorphism. In order to show ψ_p is well-defined, it is sufficient to check that $x \cdot \psi_p(1_y) = 0 = y \cdot \psi_p(1_x)$. The first equality follows from the fact that

$$x \cdot \psi_p(1_y) = [1 \otimes u^n v^{\bar{p}}] = [\overline{u^{n-m}v} \otimes u^m v^{\bar{p}-1}] = 0$$

in $\bar{R} \otimes_R I_p / \text{tor}_{\bar{R}}(\bar{R} \otimes_R I_p)$ because $u^{n-m}v \in J$ and $u^m v^{\bar{p}-1} \in I_p$ (note that $\bar{p} - 1 \geq 0$). The second equality $y \cdot \psi_p(1_x) = 0$ can be proven in the same way.

In order to show ψ_p is surjective, recall that $I_p = \langle u^p, u^{p-1}v^{\bar{1}}, \dots, uv^{\overline{p-1}}, v^{\bar{p}} \rangle_R$. Hence, it is sufficient to prove that for any pair $1 \leq i, j < n$ such that $i + mj = p \pmod n$ we have:

$$1 \otimes u^i v^j \in \text{tor}_{\bar{R}}(\bar{R} \otimes_R I_p).$$

To show this, it is sufficient to observe that

$$x \cdot (1 \otimes u^i v^j) = 1 \otimes u^{n+i} v^j = \overline{u^{n-m} v} \otimes u^{i+m} v^{j-1} = 0$$

in $\bar{R} \otimes_R I_p$ because $u^{n-m} v \in J$ and $u^{i+m} v^{j-1} \in I_p$. In a similar way, we have the equality $y \cdot (1 \otimes u^i v^j) = 0$ in $\bar{R} \otimes_R I_p$. \square

Definition 10.6. On the set $\Pi = \{0, 1, \dots, n-1\}$ there are two orderings \leq_x and \leq_y defined as follows:

- $p \leq_x q$ if and only if $p \leq q$, where p and q are regarded as natural numbers.
- $p \leq_y q$ if and only if $\bar{p} \leq \bar{q}$, where \bar{p} and \bar{q} are regarded as natural numbers.

Proposition 10.7. Let $M = \bigoplus_{p \in \Pi} I_p^{m_p}$ be a maximal Cohen–Macaulay module over R .

- If $m = \sum_{p \in \Pi} m_p$ then we have an isomorphism

$$(10.2) \quad \psi_M : \bar{Q}(M) := Q(\bar{R}) \otimes_{\bar{R}} (\bar{R} \otimes_R M / \text{tor}(\bar{R} \otimes_R M)) \longrightarrow \mathbb{k}((x))^m \oplus \mathbb{k}((y))^m,$$

induced by the isomorphisms ψ_p ($p \in \Pi$) from Lemma 10.5.

- Let $\varphi \in \text{End}_R(M)$ be an automorphism of M and $\bar{\varphi}$ be the induced automorphism of $\bar{Q}(M)$. Taking the basis of $\bar{Q}(M)$ induced by ψ_M , the endomorphism $\bar{\varphi}$ can be written as a pair of matrices $\bar{\varphi}^x = (\bar{\varphi}_{q,p}^x) \in \text{GL}_m(\mathbb{k}[[x]])$ and $\bar{\varphi}^y = (\bar{\varphi}_{q,p}^y) \in \text{GL}_m(\mathbb{k}[[y]])$, where
 - $\bar{\varphi}_{q,p}^x \in \text{Mat}_{m_q \times m_p}(\mathbb{k}[[x]])$ if $p \leq_x q$ and $\bar{\varphi}_{q,p}^x \in \text{Mat}_{m_q \times m_p}(x\mathbb{k}[[x]])$ if $p >_x q$.
 - $\bar{\varphi}_{q,p}^y \in \text{Mat}_{m_q \times m_p}(\mathbb{k}[[y]])$ if $p \leq_y q$ and $\bar{\varphi}_{q,p}^y \in \text{Mat}_{m_q \times m_p}(y\mathbb{k}[[y]])$ if $p >_y q$.
 - For any $p \in \Pi$ we have: $\bar{\varphi}_{p,p}^x(0) = \bar{\varphi}_{p,p}^y(0) \in \text{GL}_{m_p}(\mathbb{k})$.
- Any pair of matrices $(\bar{\varphi}^x, \bar{\varphi}^y) \in \text{GL}_m(\mathbb{k}[[x]]) \times \text{GL}_m(\mathbb{k}[[y]])$ having a decomposition into blocks as above and satisfying the above conditions, is induced by an automorphism $\varphi \in \text{End}_R(M)$.

Proof. It is a corollary of Theorem 10.1, Lemma 10.3, Corollary 10.4 and Lemma 10.5. \square

10.2. Matrix problem for degenerate cusps. Let $A = \tilde{A}(\underline{w})$ be the degenerate cusp of type $\underline{w} = ((n_1, m_1), (n_2, m_2), \dots, (n_t, m_t))$. By Theorem 3.5, we have an equivalence of categories $\text{CM}(A) \xrightarrow{\mathbb{F}} \text{Tri}(A)$. Hence, the classification of indecomposable maximal Cohen–Macaulay modules over A reduces to a description of indecomposable objects of the category of triples $\text{Tri}(A)$. The latter problem turns out to be more accessible, because it can be reformulated as a certain matrix problem. To see this, recall that

- The normalization R of the ring A splits into the product,

$$R = R_1 \times R_2 \times \cdots \times R_t,$$

where $R_i = R(n_i, m_i)$ is the cyclic quotient singularity of type (n_i, m_i) .

- If $I = \text{ann}_A(R/A)$ is the conductor ideal and $\bar{A} = A/I$ and $\bar{R} = R/I$ then

$$\bar{A} \cong \mathbb{k}[[z_1, z_2, \dots, z_t]]/L,$$

where the ideal L is generated by the monomials $z_i z_j$, $1 \leq i \neq j \leq t$ and

$$\bar{R} = \mathbb{k}[[x_1, y_1]]/(x_1 y_1) \times \mathbb{k}[[x_2, y_2]]/(x_2 y_2) \times \cdots \times \mathbb{k}[[x_t, y_t]]/(x_t y_t).$$

- Under the canonical morphism $\bar{A} \rightarrow \bar{R}$, the element z_i ($1 \leq i \leq t$) is mapped to $x_i + y_{i-1}$, where $y_0 = y_t$.
- Let $\mathbb{K} = \mathbb{k}((z))$. Then we have:

$$Q(\bar{A}) \cong \mathbb{K} \times \cdots \times \mathbb{K} \quad \text{and} \quad Q(\bar{R}) \cong (\mathbb{K} \times \mathbb{K}) \times \cdots \times (\mathbb{K} \times \mathbb{K}),$$

where the product is taken t times.

Let $T = (\widetilde{M}, V, \theta)$ be an object of the category $\text{Tri}(A)$. Then the following is true.

- The R -module \widetilde{M} decomposes into a direct sum

$$(10.3) \quad \widetilde{M} \cong \bigoplus_{i=1}^t \bigoplus_{p=0}^{n_i-1} I_{i,p}^{d_{i,p}}$$

for some uniquely determined multiplicities $d_{i,p} \in \mathbb{Z}_{\geq 0}$, where $I_{i,p}$ is the rank one maximal Cohen–Macaulay R_i -module defined by (10.1).

- The second term of the triple T is a module V over the semi-simple ring $Q(\bar{A}) \cong \mathbb{K} \times \cdots \times \mathbb{K} = \mathbb{K}_1 \times \cdots \times \mathbb{K}_t$. Hence,

$$(10.4) \quad V \cong \mathbb{K}_1^{l_1} \oplus \cdots \oplus \mathbb{K}_t^{l_t}$$

for some uniquely determined multiplicities $l_1, l_2, \dots, l_t \in \mathbb{Z}_{\geq 0}$.

- Applying the isomorphism $\psi_{\widetilde{M}}$ from (10.2), we get:

$$(10.5) \quad Q(\bar{R}) \otimes_R \widetilde{M} \cong (\mathbb{K} \oplus \mathbb{K})^{d_1} \oplus (\mathbb{K} \oplus \mathbb{K})^{d_2} \oplus \cdots \oplus (\mathbb{K} \oplus \mathbb{K})^{d_t},$$

where $d_i = \sum_{p=0}^{n_i-1} d_{i,p}$ for every $1 \leq i \leq t$.

- The morphism $\theta : Q(\bar{R}) \otimes_{Q(\bar{A})} V \rightarrow Q(\bar{R}) \otimes_R \widetilde{M}$ is given by a collection of matrices $((\theta_1^x, \theta_1^y), (\theta_2^x, \theta_2^y), \dots, (\theta_t^x, \theta_t^y))$, where $\theta_i^x \in \text{Mat}_{d_i \times l_i}(\mathbb{K})$ and $\theta_i^y \in \text{Mat}_{d_i \times l_{i+1}}(\mathbb{K})$. For any $1 \leq i \leq t$ these matrices satisfy the following conditions:

$$(10.6) \quad \begin{cases} \theta_i^x, \theta_i^y & \text{have both full row rank.} \\ \begin{pmatrix} \theta_i^y \\ \theta_{i-1}^x \end{pmatrix} & \text{has full column rank.} \end{cases}$$

Definition 10.8. Consider the decorated bunch of chains $\mathfrak{X}_A = \mathfrak{X}(\underline{w})$ defined as follows.

- The index set $I = \{1, \dots, t\} \times \{x, y\}$. We identify two integers p, q modulo $t+1$, when talking about elements of I .
- For any $(i, u) \in I$ we set: $\mathfrak{F}_{(i,u)} = \{f_{(i,u)}\}$ and $\mathfrak{E}_{(i,u)} = \{e_{(i,u)}^{(0)}, \dots, e_{(i,u)}^{(n_i-1)}\}$.
- All elements of $\mathfrak{E}_{(i,u)}$ are decorated, whereas the (unique) element of $\mathfrak{F}_{(i,u)}$ is not decorated. Moreover, we have the following ordering on the elements of $\mathfrak{E}_{(i,u)}$:

$$e_{(i,x)}^{(0)} \triangleleft e_{(i,x)}^{(1)} \triangleleft \cdots \triangleleft e_{(i,x)}^{(n_i-1)} \quad \text{and} \quad e_{(i,y)}^{(0)} \triangleleft e_{(i,y)}^{(\bar{1})} \triangleleft \cdots \triangleleft e_{(i,y)}^{(\overline{n_i-1})}.$$

Here, for any $1 \leq p \leq n_i$ we denote by \bar{p} the unique element of $\{1, \dots, n_i - 1\}$ such that $p = \bar{p}m_i \bmod n_i$.

- Finally, for any $1 \leq i \leq t$ and $0 \leq p \leq n_i - 1$ we have the following equivalence relations:

$$e_{(i,x)}^{(p)} \sim e_{(i,y)}^{(p)} \quad \text{and} \quad f_{(i,y)} \sim f_{((i+1),x)}.$$

Let $T = (\widetilde{M}, V, \theta)$ be an object of $\text{Tri}(A)$, where \widetilde{M} is given by (10.3) and V by (10.4). The isomorphism (10.5) allows to express the gluing morphism θ via a collection of matrices $((\theta_1^x, \theta_1^y), \dots, (\theta_t^x, \theta_t^y))$. Note, that the direct sum decomposition (10.3) induces a division

of these matrices into horizontal blocks, endowing their rows with certain “weights”, indicating their origin from a direct summand of \widetilde{M} . Concretely, for any $1 \leq i \leq t$ and $0 \leq p \leq n_i - 1$, we have $d_{i,p}$ rows of weight $e_{(i,x)}^{(p)}$ in the matrix θ_i^x (respectively $d_{i,p}$ rows of weight $e_{(i,y)}^{(p)}$ in the matrix θ_i^y). The weight of any columns of θ_i^x (respectively θ_i^y) is $f_{i-1,x}$ (respectively $f_{i,y}$).

Proposition 10.9. *The assignment $T \mapsto ((\theta_1^x, \theta_1^y), \dots, (\theta_t^x, \theta_t^y))$ extends to the functor*

$$(10.7) \quad \text{Tri}(A) \xrightarrow{\mathbb{H}} \text{Rep}(\mathfrak{X}_A),$$

satisfying the following two properties:

- $T \in \text{Ob}(\text{Tri}(A))$ is indecomposable if and only if $\mathbb{H}(T)$ is indecomposable;
- $T', T'' \in \text{Ob}(\text{Tri}(A))$ are isomorphic if and only if $\mathbb{H}(T')$ and $\mathbb{H}(T'')$ are isomorphic.

Proof. It is a consequence of Proposition 10.7 and Definition 10.8. \square

Hence, we obtain the following result, which is one the main achievements of this work.

Theorem 10.10. *Let A be a degenerate cusp. Then the following is true.*

- The category $\text{CM}(A)$ is representation-tame.
- Moreover, the essential image of the category $\text{CM}^{\text{lf}}(A)$ under $\mathbb{H} \circ \mathbb{F}$ is the category $\text{Rep}^{\text{bd}}(\mathfrak{X}_A)$, which is the additive closure of the category of band objects of $\text{Rep}(\mathfrak{X}_A)$.

Proof. According to Theorem 3.5, we have an equivalence of categories $\text{CM}(A) \xrightarrow{\mathbb{F}} \text{Tri}(A)$. By Proposition 10.9, the functor $\text{Tri}(A) \xrightarrow{\mathbb{H}} \text{Rep}(\mathfrak{X}_A)$ preserves indecomposability and isomorphism classes of objects. Hence, tameness of $\text{Rep}(\mathfrak{X}_A)$ implies tameness of $\text{CM}(A)$.

Next, let M be an indecomposable object of $\text{CM}(A)$ and $\mathbb{F}(M) := T = (\widetilde{M}, V, \theta)$ the corresponding triple. By Theorem 3.9, M is locally free on the punctured spectrum if and only if θ is an isomorphism. The classification of indecomposable objects of $\text{Rep}(\mathfrak{X}_A)$ implies that θ is an isomorphism if and only if $\mathbb{H}(T)$ is a band object. \square

Remark 10.11. Rephrasing Theorem 10.10 in different terms, we get the following result.

- The indecomposable maximal Cohen–Macaulay A -modules, which are locally free on the punctured spectrum, correspond to the band objects of $\text{Rep}(\mathfrak{X}_A)$.
- Those indecomposable maximal Cohen–Macaulay A -modules, which are not locally free on the punctured spectrum, correspond to the string objects of $\text{Rep}(\mathfrak{X}_A)$, satisfying the additional constraint (10.6).

11. SCHREYER’S QUESTION

According to Buchweitz, Greuel and Schreyer [15], the hypersurface singularities $A_\infty = \mathbb{k}[[x, y, z]]/(xy)$ and $D_\infty = \mathbb{k}[[x, y, z]]/(x^2y - z^2)$ have only countably many indecomposable maximal Cohen–Macaulay modules. We gave a different proof of this result in [19, Chapter 5], removing the assumption $\text{char}(\mathbb{k}) \neq 2$ required in [15]. In 1987, Schreyer posed the following question [67, Section 7.2.2].

Question. Let \mathbb{k} be an uncountable algebraically closed field of characteristic zero and A be a Cohen–Macaulay surface singularity having only countably many indecomposable maximal Cohen–Macaulay modules. Is it true that $A \cong B^G$, where B is a singularity of type A_∞ or D_∞ and G is a finite group of automorphisms of B ?

In this section, we show that the answer on Schreyer’s question is negative. In fact, there exists a wide class of Cohen–Macaulay surface singularities of discrete Cohen–Macaulay

representation type. Note that $\text{Spec}(A)$ has at most two irreducible components for a ring A of type B^G as above. As we shall see below, this need not be the case for an arbitrary Cohen–Macaulay surface singularity of discrete Cohen–Macaulay representation type.

Definition 11.1. Let $t \geq 2$ and $\underline{w} = ((n_1, m_1), \dots, (n_t, m_t)) \in \mathbb{Z}^{2t}$ be any sequence such that $0 \leq m_i < n_i$ and $\gcd(n_i, m_i) = 1$ for $1 \leq i \leq t$. Set $R = R_1 \times \dots \times R_t$, where $R_i = R(n_i, m_i) = \mathbb{k}[[u_i, v_i]]^{C_{n_i, m_i}} \subseteq \mathbb{k}[[u_i, v_i]]$ is the corresponding cyclic quotient singularity. As usual, for $(n_i, m_i) = (1, 0)$ we set $R_i = \mathbb{k}[[u_i, v_i]]$. Let $J_i \subseteq R_i$ the ideal defined in Theorem 9.4, $\bar{R}_i = R_i/J_i \cong \mathbb{k}[[x_i, y_i]]/(x_i y_i)$ and

$$C := \mathbb{k}[[z_0, z_1, \dots, z_t]]/(z_i z_j \mid 0 \leq i < j \leq t).$$

Let $A := A(\underline{w}) \subseteq R$ be the ring defined through the following pull-back diagram in the category of commutative rings:

$$\begin{array}{ccc} A & \longrightarrow & C \\ \downarrow & & \downarrow \gamma \\ R & \xrightarrow{\pi} & \bar{R}_1 \times \dots \times \bar{R}_t, \end{array}$$

where π is the canonical projection and γ is given by the following rule: $\gamma(z_0) = y_1$, $\gamma(z_i) = x_i + y_{i+1}$ for $1 \leq i \leq t-1$ and $\gamma(z_t) = x_t$. \square

Proposition 11.2. *The following results are true.*

- The ring A is a complete reduced Cohen–Macaulay surface singularity and R is the normalization of A .
- Let $I = \text{ann}_A(R/A)$ be the conductor ideal, $\bar{A} = A/I$ and $\bar{R} = R/I$. Then we have the following isomorphisms:

$$\bar{A} \cong \mathbb{k}[[z_1, \dots, z_{t-1}]]/(z_i z_j \mid 1 \leq i < j \leq t-1)$$

and $\bar{R} \cong \mathbb{k}[[x_1]] \times \mathbb{k}[[x_2, y_2]]/(x_2 y_2) \times \dots \times \mathbb{k}[[x_{t-1}, y_{t-1}]]/(x_{t-1} y_{t-1}) \times \mathbb{k}[[y_t]]$. The canonical morphism $\bar{A} \rightarrow \bar{R}$ sends z_i to $x_i + y_{i+1}$ for all $1 \leq i \leq t-1$.

The proof of this proposition is the same as of Proposition 9.2 and is therefore omitted. \square

Remark 11.3. By Proposition 11.2, the ring $A(\underline{w})$ has the same total ring of fractions as $R = R(n_1, m_1) \times \dots \times R(n_t, m_t)$. Hence, $\text{Spec}(A)$ has t irreducible components. Note that $A(1, 0) \cong \mathbb{k}[[u, v, w]]/(uv)$ is the A_∞ -singularity.

Definition 11.4. Consider the decorated bunch of chains $\check{\mathfrak{X}} = \check{\mathfrak{X}}(\underline{w})$ defined as follows.

- The index set $I = \{(1, y)\} \cup (\{2, \dots, t-1\} \times \{x, y\}) \cup \{(t, x)\}$.
- For any $(i, u) \in I$ we put: $\mathfrak{F}_{(i, u)} = \{f_{(i, u)}\}$ and $\mathfrak{E}_{(i, u)} = \{e_{(i, u)}^{(0)}, \dots, e_{(i, u)}^{(n_i-1)}\}$.
- All elements of $\mathfrak{E}_{(i, u)}$ are decorated, whereas the (unique) element of $\mathfrak{F}_{(i, u)}$ is not decorated. Moreover, we have the following ordering on the elements of $\mathfrak{E}_{(i, u)}$:

$$e_{(i, x)}^{(0)} \triangleleft e_{(i, x)}^{(1)} \triangleleft \dots \triangleleft e_{(i, x)}^{(n_i-1)} \quad \text{and} \quad e_{(i, y)}^{(0)} \triangleleft e_{(i, y)}^{(\bar{1})} \triangleleft \dots \triangleleft e_{(i, y)}^{(\overline{n_i-1})}.$$

Here, for any $1 \leq p \leq n_i$ we denote by \bar{p} the unique element of $\{1, \dots, n_i-1\}$ such that $p = \bar{p} m_i \bmod n_i$.

- We have the following equivalence relations.
 - $e_{(i, x)}^{(p)} \sim e_{(i, y)}^{(p)}$ for any $2 \leq i \leq t-1$ and $0 \leq p \leq n_i-1$.
 - $f_{(i, y)} \sim f_{((i+1), x)}$ for any $1 \leq i \leq t-1$.

Making the same choices as those preceding Proposition 10.9, we get the following result.

Proposition 11.5. *We have a functor $\text{Tri}(A) \xrightarrow{\mathbb{H}} \text{Rep}(\check{\mathfrak{X}})$, satisfying:*

- $T \in \text{Ob}(\text{Tri}(A))$ is indecomposable if and only if $\mathbb{H}(T)$ is indecomposable;
- $T', T'' \in \text{Ob}(\text{Tri}(A))$ are isomorphic if and only if $\mathbb{H}(T')$ and $\mathbb{H}(T'')$ are isomorphic.

Theorem 11.6. *The ring $A = A(\underline{w})$ has discrete Cohen–Macaulay representation type. Moreover, any indecomposable maximal Cohen–Macaulay A -module has multi-rank of type $(0, \dots, 0, 1, \dots, 1, 0, \dots, 0)$.*

Proof. As we have shown before, the category $\text{Rep}(\check{\mathfrak{X}}(\underline{w}))$ has discrete representation type (there are no bands in this case). Hence, $\text{CM}(A)$ has discrete representation type, too. Moreover, indecomposable objects of $\text{Tri}(A)$ are described by the following data $((p, q), \kappa, \omega)$, where

- $(p, q) \in \mathbb{Z}^2$ are such that $1 \leq p \leq q \leq t$.
- $\kappa = (k_p, \dots, k_q) \in \mathbb{Z}^{q-p+1}$ with $0 \leq k_l \leq n_l - 1$ for $p \leq l \leq q$.
- $\omega = (b_p, \dots, b_q)$. For $\max(2, p) \leq l \leq \min(q, t-1)$ we have: $b_l = (a_l, c_l) \in \mathbb{Z}^2$, while $b_1 = c_1 \in \mathbb{Z}$ (if $p = 1$) and $b_t = a_t \in \mathbb{Z}$ (if $q = t$). Moreover, we impose that $\min(a_{l+1}, c_l) = 1$ for all $p \leq l \leq q-1$.

If $T_{p,q}(\kappa, \omega) = (\widetilde{M}, V, \theta) \in \text{Ob}(\text{Tri}(A))$ is the triple corresponding to $((p, q), \kappa, \omega)$, then we have: $\widetilde{M} = I_{p,k_p} \oplus \dots \oplus I_{q,k_q}$. Let $M = M_{p,q}(\kappa, \omega)$ be the maximal Cohen–Macaulay A -module corresponding to $T_{p,q}(\kappa, \omega)$. Then we have: $Q \otimes_A M \cong Q_p \oplus \dots \oplus Q_q$, where $Q = Q(A) = Q(R)$ is the total ring of fractions of A and $Q_l = Q(R_l)$ is the quotient field of R_l , $1 \leq l \leq t$. This proves the statement about the multi-rank of an indecomposable maximal Cohen–Macaulay A -module. \square

Example 11.7. Since all proofs in this section are written in a sketchy way, we describe in details the following example. For $t \geq 1$ and $1 \leq i \leq t+1$, let $R_i = \mathbb{k}[[x_i, y_i]]$ and

$$R := R_1 \times \dots \times R_{t+1} \supset A := \left\{ (r_1, r_2, \dots, r_{t+1}) \mid r_i(0, z) = r_{i+1}(z, 0) \text{ for } 1 \leq i \leq t \right\}.$$

Consider the following elements of R : $u = (x_1, 0, 0, \dots, 0)$, $z_1 = (y_1, x_2, 0, \dots, 0)$, \dots , $z_t = (0, \dots, 0, y_t, x_{t+1})$ and $v = (0, \dots, 0, 0, y_{t+1})$. Then A is the ring of formal power series in u, v, z_1, \dots, z_t . Note that $A \cong A(\underline{w})$ for $\underline{w} = \underbrace{((1, 0), \dots, (1, 0))}_{t+1 \text{ times}}$. As in Proposition

9.2 one can show that R is the normalization of A . As usual, let $I = \text{ann}_A(R/A)$ be the conductor ideal, $\bar{A} = A/I$ and $\bar{R} = R/I$. Then we have:

$$I = \langle u, z_1 z_2, \dots, z_{t-1} z_t, v \rangle_A, \quad \bar{A} = \mathbb{k}[[z_1, \dots, z_t]] / (z_p z_q \mid 1 \leq p < q \leq t)$$

and $\bar{R} = \mathbb{k}[[y_1]] \times \mathbb{k}[[x_2, y_2]] / (x_2 y_2) \times \dots \times \mathbb{k}[[x_t, y_t]] / (x_t y_t) \times \mathbb{k}[[x_{t+1}]]$. Under the canonical embedding $A \rightarrow R$, z_i is mapped to $y_i + x_{i+1}$ for all $1 \leq i \leq t$. The matrix problem, corresponding to the description of isomorphy classes of object in $\text{Rep}(\check{\mathfrak{X}}_A)$, is the following.

- We have $2t$ matrices $\left((\theta_1^{(x)}, \theta_1^{(y)}), \dots, (\theta_t^{(x)}, \theta_t^{(y)}) \right)$, where $\theta_i^{(x)} \in \text{Mat}_{m_{i+1} \times n_i}(\mathbb{K})$ and $\theta_i^{(y)} \in \text{Mat}_{m_i \times n_i}(\mathbb{K})$, for some $m_1, \dots, m_{t+1}, n_1, \dots, n_t \in \mathbb{N}$.
- These matrices can be transformed using the rule:

$$(\theta_i^{(x)}, \theta_i^{(y)}) \mapsto (S_i^{(x)} \theta_i^{(x)} T_i^{-1}, S_i^{(y)} \theta_i^{(y)} T_i^{-1}),$$

where $T_i \in \text{GL}_{n_i}(\mathbb{K})$ for $1 \leq i \leq t$; whereas $S_i^{(x)} \in \text{GL}_{m_{i+1}}(\mathbb{D})$, $S_i^{(y)} \in \text{GL}_{m_i}(\mathbb{D})$ are such that $S_{i+1}^{(x)}(0) = S_i^{(y)}(0)$ for $1 \leq i \leq t-1$.

Observe that the obtained matrix problem is very close to the problem of classification of indecomposable representations of the quiver

$$\vec{Q} := \circ \longleftarrow \bullet \longrightarrow \circ \longleftarrow \bullet \longrightarrow \circ \cdots \circ \longleftarrow \bullet \longrightarrow \circ$$

of type A_{2t+1} over the field \mathbb{K} . In fact, there is an obvious map

$$\text{Ob}(\text{Rep}(\check{\mathfrak{X}})) \longrightarrow \text{Ob}(\text{Rep}(\vec{Q})),$$

which is however not functorial (for category $\text{Rep}(\check{\mathfrak{X}})$, morphisms at sources \bullet are as for quiver representations, whereas for targets \circ they are given by “decorated rules”). Nevertheless, in these terms it is convenient to state the final result. Using just elementary linear algebra one can show that the indecomposable objects of $\text{Ob}(\text{Rep}(\check{\mathfrak{X}}))$ can be written as follows:

$$\dots \longrightarrow 0 \longleftarrow \mathbb{K} \xrightarrow{z^{e_1}} \mathbb{K} \xleftarrow{z^{e_2}} \dots \xleftarrow{z^{e_n}} \mathbb{K} \longrightarrow 0 \longleftarrow \dots,$$

where the left (respectively right) zero can be both sink and source. Of course, those indecomposable objects of $\text{Rep}(\check{\mathfrak{X}})$ which belong to the image of \mathbb{H} , have to satisfy certain additional constraints, analogous to (10.6).

Let us now describe the indecomposable objects of $\text{CM}^{\text{f}}(A)$. They are classified by a discrete parameter $\omega = ((a_1, c_1), \dots, (a_t, c_t)) \in \mathbb{Z}^{2t}$, where $\min(a_i, c_i) = 1$ for $1 \leq i \leq t$. If $M(\omega)$ is the corresponding maximal Cohen–Macaulay A -module, then for $\mathbb{F}(M(\omega)) =: T \cong (\widetilde{M}, V, \theta)$ we have:

- $\widetilde{M} = R_1 \oplus \dots \oplus R_{t+1}$,
- $V = \mathbb{K}_1 \oplus \dots \oplus \mathbb{K}_t$,
- $\theta_i^{(x)} = (z^{a_i})$ and $\theta_i^{(y)} = (z^{c_i})$ for $1 \leq i \leq t$.

As usual, we have: $M((1, 1), \dots, (1, 1)) \cong A$. □

12. REMARKS ON RINGS OF DISCRETE AND TAME CM-REPRESENTATION TYPE

12.1. Non-reduced curve singularities. First note that our results on classification of maximal Cohen–Macaulay modules over surface singularities imply the following interesting conclusions for non-reduced curve singularities.

Theorem 12.1. *Let \mathbb{k} be an algebraically closed field of characteristic zero, $f = x^2y^2$ or $x^2y^2 + x^p$, $p \geq 3$ and $A = \mathbb{k}[[x, y]]/(f)$. Then the curve singularity A has tame Cohen–Macaulay representation type.*

Proof. According to Knörrer [58], the ring A has the same Cohen–Macaulay representation type as the surface singularity $B = \mathbb{k}[[x, y, z]]/(f + z^2)$. Hence, it is sufficient to observe that B is a degenerate cusp. Indeed, $u^2 + uvw = (u + \frac{1}{2}vw)^2 - \frac{1}{4}v^2w^2 = z^2 - x^2y^2$ for $z = u + \frac{1}{2}vw$, $x = v$ and $y = \frac{1}{2}w$. In a similar way, $u^2 + v^p + uvw = (u + \frac{1}{2}vw)^2 + v^p - \frac{1}{4}v^2w^2 = z^2 + x^p - x^2y^2$ for $z = u + \frac{1}{2}vw$, $x = v$ and $y = \frac{1}{2}w$. □

Remark 12.2. Note that Knörrer’s periodicity theorem [58] only requires that the characteristic of the base field \mathbb{k} is different from two. Since the normalization of $A = \mathbb{k}[[u, v, w]]/(u^2 + uvw)$ is a product of two regular rings, A is tame in the case of an arbitrary characteristic. Hence, $\mathbb{k}[[x, y]]/(xy)^2$ is tame provided $\text{char}(\mathbb{k}) \neq 2$. We conjecture that the rings from Theorem 12.1 are tame in the case of an arbitrary field \mathbb{k} . This is consistent with tameness of singularities $P_{\infty q} := \mathbb{k}[[x, y, z]]/(y^q - z^2, xy)$ for $q \in \mathbb{N}_{\geq 2} \cup \{\infty\}$ proven in [20] by different methods.

Recall that by results of Kahn [53], Dieterich [27], Drozd and Greuel [33], the reduced curve singularities $T_{p,q}(\lambda) = \mathbb{k}[[x, y]]/(x^p + y^q + \lambda x^2 y^2)$, where $\frac{1}{p} + \frac{1}{q} \leq \frac{1}{2}$ and $\lambda \in \mathbb{k} \setminus \{\text{finite set of values}\}$, have tame Cohen-Macaulay representation type for an arbitrary base field \mathbb{k} . See also [21] for an alternative approach to study maximal Cohen-Macaulay modules over some $T_{p,q}(\lambda)$ -singularities via cluster tilting theory.

12.2. Maximal Cohen-Macaulay modules over the ring $\tilde{D}((1,0))$. Let \mathbb{k} be any field, $R = \mathbb{k}[[x, y]]$, $\bar{R} = \mathbb{k}[[x, y]]/(xy)$ and $\pi : R \rightarrow \bar{R}$ the canonical projection. Let $\bar{A} = \mathbb{k}[[\tilde{x}, \tilde{y}]]/(\tilde{x}\tilde{y})$, $\tilde{\gamma} : \bar{A} \rightarrow \bar{R}$ the ring homomorphism given by the rule $\tilde{\gamma}(\tilde{x}) = x^2$ and $\tilde{\gamma}(\tilde{y}) = y^2$ and $\bar{D}(1,0) := A = \pi^{-1}(\tilde{\gamma}(\bar{A}))$. Then we have:

$$\mathbb{k}[[x, y]] \supset A = \mathbb{k}[[x^2, y^2, xy, x^2y, y^2x]] \cong \mathbb{k}[[u, v, w, a, b]]/J,$$

where $J = (uv - w^2, ab - w^3, aw - bu, bw - av, a^2 - uw^2, b^2 - vw^2)$. Obviously, A has the following \mathbb{Z}_2 -symmetry: $u \leftrightarrow w, w \leftrightarrow v, a \leftrightarrow b$. Moreover, the following results are true.

- The ring A is an integral Cohen-Macaulay surface singularity.
- The ring R is the normalization of A .
- We have: $\text{Ext}_A^2(\mathbb{k}, A) \cong \mathbb{k}^2$. In particular, A is not Gorenstein.
- Let $I = \text{ann}_A(R/A)$ be the conductor ideal. Then we have: $I = \langle w, a, b \rangle_A = \langle xy \rangle_R$. In particular, we can identify A/I with \bar{A} , R/I with \bar{R} and the canonical ring homomorphism $A/I \rightarrow R/I$ with $\tilde{\gamma}$.

Let $\mathbb{K} = \mathbb{k}((z))$, $\mathbb{L} = \mathbb{k}((z^2))$, $\mathbb{D} = \mathbb{k}[[z]]$ and $\mathfrak{m} = z\mathbb{k}[[z]]$. Then $Q(\bar{A}) \cong \mathbb{L}_1 \times \mathbb{L}_2$ and $Q(\bar{R}) \cong \mathbb{K}_1 \times \mathbb{K}_2$, where $\mathbb{L}_i = \mathbb{L}$ and $\mathbb{K}_i = \mathbb{K}$ for $i = 1, 2$. An object T of the category of triples $\text{Tri}(A)$ has the following form: $T = (\tilde{M}, V, \theta)$, where $\tilde{M} \cong R^m$, $V \cong \mathbb{L}_1^{p_1} \oplus \mathbb{L}_2^{p_2}$ and the gluing map θ is given by a pair of matrices (Θ_1, Θ_2) , where $\Theta_i \in \text{Mat}_{m \times p_i}(\mathbb{K})$ for $i = 1, 2$. Additionally,

- Θ_1 and Θ_2 have full row rank.
- If $\Theta_i = \Theta'_i + z\Theta''_i$ with $\Theta'_i, \Theta''_i \in \text{Mat}_{m \times p_i}(\mathbb{L})$ then $\begin{pmatrix} \Theta'_i \\ \Theta''_i \end{pmatrix} \in \text{Mat}_{2m \times p_i}(\mathbb{L})$ has full column rank, $i = 1, 2$.

The problem of classification of isomorphism classes of objects in $\text{Tri}(A)$ reduces to the following matrix problem:

$$(12.1) \quad (\Theta_1, \Theta_2) \mapsto (S_1^{-1}\Theta_1T_1, S_2^{-1}\Theta_2T_2),$$

where $S_1, S_2 \in \text{GL}_m(\mathbb{D})$ are such that $S_1(0) = S_2(0)$ and $T_i \in \text{GL}_{p_i}(\mathbb{L})$ for $i = 1, 2$.

Proposition 12.3. *Up to isomorphism, there exist only the following maximal Cohen-Macaulay A -modules of rank one (written as ideals in A):*

Θ_1	Θ_2	Module
(1)	(1)	A
(z)	(z)	(w^2, a, b)
(z)	(1)	(w^2, a, vw)
(1)	(z)	(w^2, b, uw)
($1z$)	($1z$)	$R \cong I$
(1)	($1z$)	(w, b)
($1z$)	(1)	(w, a)
(z)	($1z$)	(w^2, a, b, vw)
($1z$)	(z)	(w^2, a, b, uw)

(12.2)

Moreover, the modules in the upper part of the table are locally free on the punctured spectrum, whereas the ones in the lower part are not. In particular, up to isomorphism there exist only finitely many maximal Cohen–Macaulay A -modules of rank one.

Proof. It is not difficult to see that in rank one, there are only those possibilities for the canonical forms of Θ_1 and Θ_2 , which are presented in the Table (12.2). Recall, that the condition for Θ_1 and Θ_2 to be square and invertible is equivalent to the statement that the corresponding maximal Cohen–Macaulay module is locally free on the punctured spectrum.

Let us consider in details the case $\Theta_1 = (z)$ and $\Theta_2 = (1)$. First note that this pair is equivalent to $\bar{\Theta}_1 = (z)$ and $\bar{\Theta}_2 = (z^2)$. Let $\tilde{\theta} : \bar{A} \rightarrow \bar{R}$ be the \bar{A} -linear map sending 1 to $x + y^2$. Then the induced $\mathbb{L} \times \mathbb{L}$ -linear map

$$\mathbb{L} \times \mathbb{L} = Q(\bar{A}) \otimes_{\bar{A}} \mathbb{1} \xrightarrow{\mathbb{1} \times \tilde{\theta}} Q(\bar{A}) \otimes_{\bar{A}} \bar{R} \xrightarrow{\text{can}} Q(\bar{R}) = \mathbb{K} \times \mathbb{K}$$

is given by the pair $(\bar{\Theta}_1, \bar{\Theta}_2)$. Consider the torsion free A -module L given by the pull-back diagram

$$\begin{array}{ccccccc} 0 & \longrightarrow & I & \longrightarrow & L & \longrightarrow & \bar{A} \longrightarrow 0 \\ & & \text{id} \downarrow & & \downarrow & & \downarrow \tilde{\theta} \\ 0 & \longrightarrow & I & \longrightarrow & R & \longrightarrow & \bar{R} \longrightarrow 0. \end{array}$$

Let $M = L^{\vee\vee}$. The reconstruction procedure tells that M is the maximal Cohen–Macaulay A -module corresponding to the triple $(R, \mathbb{L}_1 \oplus \mathbb{L}_2, ((z), (1)))$. We have:

$$R \supset L := \left((w, a, b), \frac{a}{w} + v \right)_A \xrightarrow{w \cdot} (w^2, wa, wb, a + vw)_{rA}.$$

It is easy to see that $a \in R$ has the property that $\mathfrak{m} \cdot a \in L$. Hence, a belongs to the Macaulayfication of L . It is not difficult to see that

$$M = (a)_A + L = (w^2, a, vw)_A \subset A$$

is maximal Cohen–Macaulay. This proves the result. All remaining cases can be treated in a similar way. Proposition is proven. \square

Remark 12.4. First one-parameter families of indecomposable maximal Cohen–Macaulay A -modules arise in rank two. Consider for example the following pair of matrices

$$(12.3) \quad \Theta_1 = \begin{pmatrix} 1 & z \\ z^m & 0 \end{pmatrix} \quad \text{and} \quad \Theta_2 = \begin{pmatrix} 1 & z \\ \lambda z^n & 0 \end{pmatrix},$$

where $m, n \in \mathbb{Z}_{>0}$ and $\lambda \in \mathbb{k}^*$. They define an indecomposable maximal Cohen–Macaulay A -module $M((n, m), \lambda)$ of rank two, which is locally free on the punctured spectrum. Moreover, $M((n, m), \lambda) \cong M((n', m'), \lambda')$ if and only if $n = n', m = m'$ and $\lambda = \lambda'$. Assume that n and m are even: $n = 2\bar{n}$ and $m = 2\bar{m}$. Consider the following ideals in A : $I_1 = (w^2, a, b)$ and $I_2 = (w, a, b)$. As in the proof of Proposition 12.3 one can show that

$$(12.4) \quad M((n, m), \lambda) \cong \left\langle \left(\begin{pmatrix} a_1 \\ a_2 \end{pmatrix} + \begin{pmatrix} w \\ u^{\bar{m}} + \lambda v^{\bar{n}} \end{pmatrix} \mid a_p \in I_p, p = 1, 2 \right) \right\rangle \subset A^2.$$

12.3. Other surface singularities of discrete and tame CM–representation type.

According to Buchweitz, Greuel and Schreyer, the singularity $D_\infty = \mathbb{k}[[x, y, z]]/(x^2y - z^2)$ has discrete Cohen–Macaulay representation type, see also [19, Theorem 5.7]. This singularity does not belong to the class of surface singularities introduced in Definition 11.1. This certainly means that the list of surface singularities of discrete Cohen–Macaulay representation type given in Definition 11.1 is not exhaustive.

Definition 12.5. Let $t \geq 1$ and $\underline{w} = ((n_1, m_1), (n_2, m_2), \dots, (n_t, m_t)) \in (\mathbb{Z}^2)^t$ be a collection of integers such that $0 \leq m_i < n_i$, and $\gcd(m_i, n_i) = 1$ for all $1 \leq i \leq t$. Let $R_i = R(n_i, m_i) = \mathbb{k}[[u_i, v_i]]^{C_{n_i, m_i}} \subseteq \mathbb{k}[[u_i, v_i]]$ be the corresponding cyclic quotient singularity, $J_i \subseteq R_i$ the ideal defined in Theorem 9.4, $\bar{R}_i = R_i/J_i \cong \mathbb{k}[[x_i, y_i]]/(x_i y_i)$ and $\pi : R \rightarrow \bar{R}_1 \times \dots \times \bar{R}_t$ to be the canonical projection. Consider the ring

$$C := \mathbb{k}[[u, z_1, \dots, z_{t-1}, v]] / (z_i z_j, 1 \leq i < j \leq t-1; uz_i, vz_i; 1 \leq i \leq t-1).$$

- Let $\gamma : C \rightarrow \bar{R}_1 \times \dots \times \bar{R}_t$ be the ring homomorphism given by the rule: $\gamma(u) = x_1^2$, $\gamma(z_i) = y_i + x_{i+1}$ for $1 \leq i \leq t-1$ and $\gamma(z_t) = y_t$.
- In a similar way, let $\tilde{\gamma} : C \rightarrow \bar{R}_1 \times \dots \times \bar{R}_t$ be given by the rule: $\gamma(u) = x_1^2$, $\gamma(z_i) = y_i + x_{i+1}$ for $1 \leq i \leq t-1$ and $\gamma(z_t) = y_t^2$.
- We set $D(\underline{w}) = \pi^{-1}(\gamma(C))$.
- In a similar way, we define $\tilde{D}(\underline{w}) := \pi^{-1}(\tilde{\gamma}(C))$.

Note that $D(1, 0) \cong \mathbb{k}[[x, y, z]]/(x^2y - z^2)$ is a hypersurface singularity of type D_∞ , whereas $\tilde{D}(1, 0)$ was considered in Subsection 12.2.

Remark 12.6. Let A be of type $D(\underline{w})$ (respectively $\tilde{D}(\underline{w})$). The description of indecomposable objects of the category of triples $\text{Tri}(A)$ leads to some new matrix problem, somewhat analogous to “representations of a bunch of *semi-chains*” in the sense of [10]. It can be shown that this matrix problem has discrete representation type for $A = D(\underline{w})$ and tame representation type for $A = \tilde{D}(\underline{w})$. Details will be treated elsewhere.

12.4. On deformations of certain non–isolated surface singularities. In this subsection we state a conjecture inspired by our study of maximal Cohen–Macaulay modules over surface singularities. It can be formulated in pure deformation–theoretic terms.

Conjecture 12.7. *Let \mathbb{k} be an algebraically closed field of characteristic zero and $X \xrightarrow{\pi} B$ be a flat morphism of Noetherian schemes over \mathbb{k} of relative dimension two. For a closed point $b \in B$ denote by X_b the scheme–theoretic fiber $\pi^{-1}(b)$. Let $b_0 \in B$ be a closed point and $X_0 = X_{b_0} = \text{Spec}(A)$ be the corresponding fiber. Assume that for all closed points $b \in B \setminus \{b_0\}$ the scheme X_b is normal. Let $\underline{w} = ((n_1, m_1), \dots, (n_t, m_t))$ with $0 \leq m_i < n_i$ and $\gcd(n_i, m_i) = 1$ for $1 \leq i \leq t$.*

- *Assume that A has a singularity of type $A(\underline{w})$ or $D(\underline{w})$. Then there exists an open neighborhood B' of b_0 such that for all $b \in B' \setminus \{b_0\}$ the surface X_b has only quotient singularities.*
- *Assume A is a degenerate cusp (i.e. it is of type $\tilde{A}(\underline{w})$). Then there exists an open neighborhood B' of b_0 such that for all $b \in B' \setminus \{b_0\}$ the scheme X_b has only simple, simple elliptic or cusp singularities.*
- *Assume A is of type $\tilde{D}(\underline{w})$. Then there exists an open neighborhood B' of b_0 such that for all $b \in B' \setminus \{b_0\}$ the scheme X_b has only quotient or log–canonical singularities.*

The evidence for this conjecture is the following. By results of Auslander [4] and Esnault [39] it is known that the quotient surface singularities are the only surface singularities of finite Cohen–Macaulay representation type. In particular, the representation-finite Gorenstein surface singularities are precisely the simple hypersurface singularities.

By results of Kahn [53] and Drozd, Greuel and Kashuba [35] it is known that log-canonical surface singularities have tame Cohen–Macaulay representation type. Moreover, conjecturally these are the only tame normal surface singularities. The semi-continuity conjecture (known to be true in the case of reduced curve singularities [57, 32]) states that the representation type can be only improved by a flat local deformation: Cohen–Macaulay finite singularities deform to Cohen–Macaulay finite singularities, Cohen–Macaulay discrete singularities deform to Cohen–Macaulay finite or discrete singularities and Cohen–Macaulay tame singularities can not deform to Cohen–Macaulay wild singularities. This philosophy is confirmed by a result of Esnault and Viehweg stating that the class of quotient surface singularities is closed under deformations [40].

13. APPENDIX A: CATEGORY OF TRIPLES IN DIMENSION ONE

The goal of this section is to provide full details of a construction, which allows to reduce a description of Cohen–Macaulay modules over a local Cohen–Macaulay ring (A, \mathfrak{m}) of Krull dimension *one* to a matrix problem. It seems that for the first time a construction of this kind appeared in the work of Drozd and Roiter [36] and Jacobinski [48]. Similar constructions appeared in the works of Ringel and Roggenkamp [66], Green and Reiner [45], Wiegand [76], Dieterich [27] and recent monograph of Leuschke and Wiegand [60].

Since this construction plays a key role in our approach to maximal Cohen–Macaulay modules over non-isolated surface singularities and its presentation in all above references is essentially different from the one given below, we have decided to include its detailed exposition in this appendix.

Let (A, \mathfrak{m}) be a local Cohen–Macaulay ring of Krull dimension one (not necessarily reduced), $A \subseteq R$ be a finite ring extension such that $R \subseteq Q(A)$, where $Q(A)$ is the total ring of fractions of A . Note that R is automatically Cohen–Macaulay. Let $I = \text{ann}_A(R/A)$ be the corresponding conductor ideal. Typically, A is supposed to be reduced and R is the normalization of A . In that case, assuming the completion \hat{A} to be reduced, the ring extension $A \subseteq R$ is automatically finite, see [11, Chapitre 9, AC IX.33].

Lemma 13.1. *In the notations as above, I is a sub-ideal of the Jacobson’s radical of R . Moreover, the rings $\bar{A} = A/I$ and $\bar{R} = R/I$ have finite length.*

Proof. Let $\mathfrak{n}_1, \dots, \mathfrak{n}_t$ be the set of the maximal ideals of R . Since the ring extension $A \subseteq R$ is finite, for any $1 \leq i \leq t$ we have: $\mathfrak{n}_i \cap A = \mathfrak{m}$. Since I is a proper ideal in A , it is contained in \mathfrak{m} . Hence, I is contained in $\mathfrak{n} = \mathfrak{n}_1 \cap \mathfrak{n}_2 \cap \dots \cap \mathfrak{n}_t$, too.

Let \mathfrak{p} be a prime ideal in A of height zero. Then $I_{\mathfrak{p}} = \text{ann}_{A_{\mathfrak{p}}}(R_{\mathfrak{p}}/A_{\mathfrak{p}}) = A_{\mathfrak{p}}$, thus $\bar{A}_{\mathfrak{p}} = 0$. It implies that the associator of the A -module \bar{A} is $\{\mathfrak{m}\}$, hence \bar{A} has finite length. Since the extension $\bar{A} \subseteq \bar{R}$ is finite, \bar{R} has finite length, too. \square

Lemma 13.2. *For a maximal Cohen–Macaulay A -module M we denote by*

$$\widetilde{M} := R \otimes_A M / \Gamma_{\{\mathfrak{n}\}}(R \otimes_A M), \quad \overline{M} := \bar{A} \otimes_A M \quad \text{and} \quad \widehat{M} := \bar{R} \otimes_R \widetilde{M}.$$

Then the following results are true.

- (1) \widetilde{M} is a maximal Cohen–Macaulay module over R ;
- (2) the canonical morphism of A -modules $M \xrightarrow{JM} \widetilde{M}$, $m \mapsto [1 \otimes m]$ is injective;

- (3) the canonical morphism $\overline{M} \xrightarrow{\tilde{\theta}_M} \widehat{M}$, $\bar{a} \otimes m \mapsto \bar{a} \otimes_{JM}(m)$ is injective and the induced morphism $\bar{R} \otimes_{\bar{A}} \overline{M} \xrightarrow{\theta_M} \widehat{M}$, $\bar{r} \otimes \bar{m} \mapsto \bar{r} \cdot \tilde{\theta}_M(\bar{m})$ is surjective.

Proof. Since \widetilde{M} has no \mathfrak{n} -torsion submodules, it is maximal Cohen–Macaulay over R . Next, M is a torsion free A -module, hence $\ker(j_M)$ is also torsion free. However, the morphism

$$Q(A) \otimes_A M \xrightarrow{1 \otimes j_M} Q(R) \otimes_R \widetilde{M}$$

is an isomorphism, hence $\ker(j_M) = 0$. As a result, the morphism $IM \xrightarrow{\bar{j}_M} I\widetilde{M}$, which is a restriction of j_M , is also injective. Moreover, \bar{j}_M is also surjective: for any $a \in I, b \in R$ and $m \in M$ we have: $a \cdot [b \otimes m] = [ab \otimes m] = [1 \otimes (ab) \cdot m]$ and $ab \in I$.

Next, we have the following commutative diagram with exact rows:

$$(13.1) \quad \begin{array}{ccccccc} 0 & \longrightarrow & IM & \longrightarrow & M & \longrightarrow & \overline{M} \longrightarrow 0 \\ & & \bar{j}_M \downarrow & & j_M \downarrow & & \downarrow \tilde{\theta}_M \\ 0 & \longrightarrow & I\widetilde{M} & \longrightarrow & \widetilde{M} & \longrightarrow & \widehat{M} \longrightarrow 0. \end{array}$$

Since j_M is injective and \bar{j}_M is an isomorphism, by the snake lemma $\tilde{\theta}_M$ is a monomorphism. Finally, note that θ_M coincides with the composition of canonical morphisms:

$$\bar{R} \otimes_{\bar{A}} \bar{A} \otimes_A M \longrightarrow \bar{R} \otimes_R R \otimes_A M \longrightarrow \bar{R} \otimes_R (R \otimes_A M / \text{tor}_R(R \otimes_A M)),$$

where the first morphism is an isomorphism and the second one is an epimorphism. \square

Definition 13.3. Consider the following *category of triples* $\text{Tri}(A)$. Its objects are the triples $(\widetilde{M}, V, \theta)$, where \widetilde{M} is a maximal Cohen–Macaulay R -module, V is a Noetherian \bar{A} -module and $\theta : \bar{R} \otimes_{\bar{A}} V \rightarrow \bar{R} \otimes_R \widetilde{M}$ is an epimorphism of \bar{R} -modules such that the induced morphism of \bar{A} -modules $\tilde{\theta} : V \rightarrow \bar{R} \otimes_{\bar{A}} V \xrightarrow{\theta} \bar{R} \otimes_R \widetilde{M}$ is a monomorphism. A morphism between two triples $(\widetilde{M}, V, \theta)$ and $(\widetilde{M}', V', \theta')$ is given by a pair (ψ, φ) , where $\psi : \widetilde{M} \rightarrow \widetilde{M}'$ is a morphism of R -modules and $\varphi : V \rightarrow V'$ is a morphism of \bar{A} -modules such that the following diagram of A -modules

$$\begin{array}{ccc} \bar{R} \otimes_{\bar{A}} V & \longrightarrow & \bar{R} \otimes_R \widetilde{M} \\ \mathbb{1} \otimes \varphi \downarrow & & \downarrow \mathbb{1} \otimes \psi \\ \bar{R} \otimes_{\bar{A}} V' & \longrightarrow & \bar{R} \otimes_R \widetilde{M}' \end{array}$$

is commutative.

Remark 13.4. Note that the morphisms θ and $\tilde{\theta}$ correspond to each other under the canonical isomorphisms $\text{Hom}_{\bar{R}}(\bar{R} \otimes_{\bar{A}} V, \bar{R} \otimes_R \widetilde{M}) \cong \text{Hom}_{\bar{A}}(V, \bar{R} \otimes_R \widetilde{M})$.

Definition 13.3 is motivated by the following theorem.

Theorem 13.5. *The functor $\mathbb{F} : \text{CM}(A) \rightarrow \text{Tri}(A)$ mapping a maximal Cohen–Macaulay module M to the triple $(\widetilde{M}, \overline{M}, \theta_M)$, is an equivalence of categories. Next, let N be a maximal Cohen–Macaulay A -module corresponding to a triple $(\widetilde{N}, V, \theta)$. Then N is free if and only if \widetilde{N} and V are free and θ is an isomorphism.*

Proof. We have to construct a functor $\mathbb{G} : \text{Tri}(A) \rightarrow \text{CM}(A)$, which is quasi-inverse to \mathbb{F} . For a triple $T = (\widetilde{M}, V, \theta)$ consider the canonical morphism $\gamma := \gamma_{\widetilde{M}} : \widetilde{M} \rightarrow \widehat{M} := \bar{R} \otimes_R \widetilde{M}$ and define $N := \mathbb{G}(T)$ by taking a kernel of the following morphism in $A\text{-mod}$:

$$0 \longrightarrow N \xrightarrow{\begin{pmatrix} - \\ \pi \end{pmatrix}} \widetilde{M} \oplus V \xrightarrow{(\gamma \ \tilde{\theta})} \widehat{M} \longrightarrow 0.$$

Equivalently, we have a commutative diagram in the category of A -modules

$$(13.2) \quad \begin{array}{ccccccc} 0 & \longrightarrow & I\widetilde{M} & \xrightarrow{\alpha} & N & \xrightarrow{\pi} & V \longrightarrow 0 \\ & & \downarrow = & & \downarrow \iota & & \downarrow \tilde{\theta} \\ 0 & \longrightarrow & I\widetilde{M} & \xrightarrow{\beta_{\widetilde{M}}} & \widetilde{M} & \xrightarrow{\gamma_{\widetilde{M}}} & \widehat{M} \longrightarrow 0. \end{array}$$

In other words, $N = \gamma^{-1}(\text{Im}(\tilde{\theta}))$.

Since $\tilde{\theta}$ is a monomorphism, the snake lemma implies that ι is a monomorphism, too. Moreover, \widetilde{M} is torsion free viewed as A -module, hence N is torsion free as well. From the definition of morphisms in the category $\text{Tri}(A)$ and the universal property of a kernel it follows that the correspondence $\text{Tri}(A) \in T \mapsto N \in \text{CM}(A)$ uniquely extends on the morphisms in $\text{Tri}(A)$. Hence, \mathbb{G} is a well-defined functor.

Let M be a Noetherian A -module and $\pi_M : M \rightarrow \bar{M} := \bar{A} \otimes_A M$ be the canonical morphism. Then we have the short exact sequence

$$0 \longrightarrow M \xrightarrow{\begin{pmatrix} - \\ \pi_M \end{pmatrix}} \widetilde{M} \oplus \bar{M} \xrightarrow{(\gamma_{\widetilde{M}} \ \tilde{\theta}_M)} \widehat{M} \longrightarrow 0,$$

yielding an isomorphism of functors $\xi : \mathbb{1}_{\text{CM}(A)} \rightarrow \mathbb{G} \circ \mathbb{F}$. In particular, this implies that \mathbb{F} is faithful.

Next, we show that \mathbb{G} is faithful. Let $T = (\widetilde{M}, V, \theta)$ and $T' = (\widetilde{M}', V', \theta')$ be a pair of objects in $\text{Tri}(A)$ and $(\varphi, \psi) : T \rightarrow T'$ be a morphism in $\text{Tri}(A)$. Let $N = \mathbb{G}(T)$, $N' = \mathbb{G}(T')$ and $\phi = \mathbb{G}((\varphi, \psi))$. Then we have a commutative diagram in the category of A -modules:

$$(13.3) \quad \begin{array}{ccccccc} 0 & \longrightarrow & N & \longrightarrow & \widetilde{M} \oplus V & \xrightarrow{(\gamma \ \tilde{\theta})} & \widehat{M} \longrightarrow 0 \\ & & \downarrow \phi & & \downarrow \begin{pmatrix} \psi & 0 \\ 0 & \varphi \end{pmatrix} & & \downarrow \widehat{\psi} \\ 0 & \longrightarrow & N' & \longrightarrow & \widetilde{M}' \oplus V' & \xrightarrow{(\gamma' \ \tilde{\theta}')} & \widehat{M}' \longrightarrow 0. \end{array}$$

First note that $(\varphi, \psi) = 0$ in $\text{Tri}(A)$ if and only if $\psi = 0$. Indeed, one direction is obvious. To show the second, assume $\psi = 0$. Then $\widehat{\psi} = 0$ and $\tilde{\theta}' \circ \varphi = 0$. Since $\tilde{\theta}'$ is a monomorphism, we have: $\varphi = 0$.

Next, a morphism of Cohen–Macaulay R -modules $\psi : \widetilde{M} \rightarrow \widetilde{M}'$ is zero if and only if $\mathbb{1} \otimes \psi : Q(A) \otimes_A \widetilde{M} \rightarrow Q(A) \otimes_A \widetilde{M}'$ is zero in $Q(A)\text{-mod}$. Suppose the morphism of triples $(\varphi, \psi) : T \rightarrow T'$ is non-zero. Apply the functor $Q(A) \otimes_A -$ on the diagram (13.3). It follows that $\mathbb{1} \otimes \phi \neq 0$, hence $\mathbb{G}((\varphi, \psi)) \neq 0$ as well. Hence, \mathbb{G} is faithful.

Since we have constructed an isomorphism of functors $\xi : \mathbb{1}_{\text{CM}(A)} \rightarrow \mathbb{G} \circ \mathbb{F}$ and \mathbb{G} is faithful, it implies that \mathbb{F} is also full. Hence, to prove that \mathbb{F} is an equivalence of categories, it remains to check that \mathbb{F} is essentially surjective. For this, it is sufficient to show that for any object $T = (\widetilde{M}, V, \theta) \in \text{Tri}(A)$ we have: $T \cong \mathbb{F}\mathbb{G}(T)$.

Let $N := \mathbb{G}(T)$, so that we have the diagram (13.2). In these notations, the morphism $\iota : N \rightarrow \widetilde{M}$ restricts to the morphism $\bar{\iota} : IN \rightarrow I\widetilde{M}$ such that the following diagram is

commutative:

$$\begin{array}{ccc} IN & \xrightarrow{\varepsilon} & N \\ \bar{\iota} \downarrow & & \downarrow \iota \\ I\widetilde{M} & \xrightarrow{\beta_{\widetilde{M}}} & \widetilde{M}, \end{array}$$

where ε is the canonical inclusion. From the equality $\iota\alpha\bar{\iota} = \beta_{\widetilde{M}}\bar{\iota} = \iota\varepsilon$ and the fact that ι is a monomorphism, we conclude that $\alpha\bar{\iota} = \varepsilon$. In particular, we obtain the following commutative diagram with exact rows:

$$\begin{array}{ccccccccc} 0 & \longrightarrow & I\widetilde{N} & \xrightarrow{\beta_{\widetilde{N}}} & \widetilde{N} & \xrightarrow{\gamma_{\widetilde{N}}} & \widehat{N} & \longrightarrow & 0 \\ & & \bar{j}_N \uparrow & & \uparrow j_N & & \uparrow \widehat{\theta}_N & & \\ 0 & \longrightarrow & IN & \xrightarrow{\varepsilon} & N & \xrightarrow{\pi_N} & \widetilde{N} & \longrightarrow & 0 \\ & & \bar{\iota} \downarrow & & \downarrow = & & \downarrow \varphi & & \\ 0 & \longrightarrow & I\widetilde{M} & \xrightarrow{\alpha} & N & \xrightarrow{\pi} & V & \longrightarrow & 0 \\ & & = \downarrow & & \downarrow \iota & & \downarrow \widehat{\theta} & & \\ 0 & \longrightarrow & I\widetilde{M} & \xrightarrow{\beta_{\widetilde{M}}} & \widetilde{M} & \xrightarrow{\gamma_{\widetilde{M}}} & \widehat{M} & \longrightarrow & 0. \end{array}$$

First observe that by the snake lemma, the morphism φ is an epimorphism. Next, there exists a unique morphism of R -modules $\psi : \widetilde{N} \rightarrow \widetilde{M}$ such that $\psi \circ j_N = \iota$ in the category $A\text{-mod}$. This follows from the natural isomorphisms

$$\text{Hom}_A(N, \widetilde{M}) \cong \text{Hom}_R(R \otimes_A N, \widetilde{M}) \cong \text{Hom}_R(\widetilde{N}, \widetilde{M}).$$

Since the morphisms ι and j_N are rational isomorphisms (i.e. they become isomorphisms after applying the functor $Q(A) \otimes_A -$) the map ψ is a rational isomorphism, too. Hence, ψ is a monomorphism.

Consider the morphism $\widehat{\psi} : \widehat{N} \rightarrow \widehat{M}$ induced by ψ . It is not difficult to see that the following diagram is commutative:

$$(13.4) \quad \begin{array}{ccc} \bar{R} \otimes_{\bar{A}} \widetilde{N} & \xrightarrow{\theta_N} & \widehat{N} \\ \mathbb{1} \otimes \varphi \downarrow & & \downarrow \widehat{\psi} \\ \bar{R} \otimes_{\bar{A}} V & \xrightarrow{\theta} & \widehat{M}. \end{array}$$

Since the morphisms θ and φ are epimorphisms, $\widehat{\psi}$ is an epimorphism, too. Moreover, by Lemma 13.1, I is a subideal of the Jacobson's radical of R . Hence, by Nakayama's lemma, ψ is an epimorphism, hence an isomorphism.

Note, that the map $I\widetilde{N} \xrightarrow{\bar{\psi}} I\widetilde{M}$, which is a restriction of ψ , is again an isomorphism. Since $\bar{\iota} = \bar{\psi} \circ \bar{j}_N$ and \bar{j}_N is an isomorphism, $\bar{\iota}$ is an isomorphism, too. Hence, φ is an isomorphism as well. The commutativity of the diagram (13.4) implies that we get the following isomorphism $(\psi, \varphi) : (\widetilde{N}, \widetilde{N}, \theta_N) \rightarrow (\widetilde{M}, V, \theta)$ in the category $\text{Tri}(A)$. This concludes the proof of the fact that \mathbb{F} and \mathbb{G} are quasi-inverse equivalences of categories.

It remains to characterize the triples corresponding to the images of free modules. One direction is clear: if $M = A^n$ for some $n \geq 1$ then $\mathbb{F}(M) \cong (R^n, \bar{A}^n, \theta)$, where θ is given by the identity matrix in $\text{Mat}_{n \times n}(\bar{R})$.

On the other hand, let $T = (R^n, \bar{A}^n, \theta)$ be a triple, such that the morphism $\theta \in \text{Mat}_{n \times n}(\bar{R})$ is an isomorphism. First note the induced morphism $\tilde{\theta} : \bar{A}^n \rightarrow \bar{R}^n$ is automatically injective. Next, Nakayama's lemma implies that the canonical morphism $\text{GL}_n(R) \rightarrow \text{GL}_n(\bar{R})$ is an epimorphism. This means that θ can be lifted to an isomorphism $\psi : R^n \rightarrow \bar{R}^n$ and we get an isomorphism of triples $(\psi, \mathbb{1}) : (R^n, \bar{A}^n, \mathbb{1}) \rightarrow (R^n, \bar{A}^n, \theta)$. Hence, the triple T belongs to the image of the functor \mathbb{F} . Since \mathbb{F} and \mathbb{G} are quasi-inverse equivalences of categories, this concludes the proof of the theorem. \square

Remark 13.6. There also exists a global version of Theorem 13.5 describing vector bundles and torsion free sheaves on a singular curve X in terms of vector bundles on the normalization \tilde{X} and some gluing data, see [34, Proposition 42] as well as [16, Theorem 1.3 and Theorem 3.2]. See also [8, Section 3], [31, Chapter 3] and [22, Section 5.1] for further elaborations as well as [18, Theorem 4.2] for a generalization of this construction on the (bounded from above) derived category of coherent sheaves of a singular curve.

14. APPENDIX B: DECORATED CONJUGATION PROBLEM

Starting with a work [36], the technique of matrix problems began to play an important role in various classification results (proofs of representation finiteness and tameness) in commutative algebra and algebraic geometry. For instance, proofs of the following results are essentially based on the representation theory of bunches of (semi-)chains [9].

- The proof of tameness of the category of indecomposable torsion free modules over curve singularities $P_{pq} := \mathbb{k}\langle x, y, z \rangle / (x^p + y^q - z^2, xy)$, where $p, q \in \mathbb{N}_{\geq 2} \cup \{\infty\}$ and $(p, q) \neq (2, 2)$, see [33, 20].
- A description of indecomposable vector bundles and torsion free sheaves on Kodaira cycles of projective lines [34, 8, 31] as well as of indecomposable coherent sheaves on them [18].
- The proof of tameness of the category of indecomposable torsion free modules over the cusp curve singularities $T_{pq} := \mathbb{k}\langle x, y \rangle / (x^p + y^q + x^2y^2)$, where $\frac{1}{p} + \frac{1}{q} < \frac{1}{2}$.

On the other hand, it seems that the technique of proofs of [9] is not really known apart of the community of people working in the domain of representation theory of finite dimensional algebras. On our mind, it requires further elaborations. In this section, we want to illustrate some central ideas of [61, 9] on the following example, which generalizes the classical conjugation problem of square matrices (Jordan–Frobenius normal form). In what follows, we shall use the same notation as in Section 6.

Definition 14.1. We say that two matrices $W, \tilde{W} \in \text{Mat}_{n \times n}(\mathbb{K})$ are equivalent if there exists a pair of matrices $S, T \in \text{GL}_n(\mathbb{D})$ satisfying the condition $\tilde{S} = \tilde{T}$, such that $\tilde{W} = SWT^{-1}$. In what follows we shall write $W \simeq \tilde{W}$, whereas \sim will denote the usual conjugacy equivalence over \mathbb{k} . A description of the canonical form of a square matrix over \mathbb{K} with respect to \simeq equivalence relation is called *decorated conjugation problem*.

Being a rather special example of the category of representations of a decorated bunch of chains, the decorated conjugation problem incorporates many key features of the general case treated in Theorem 7.1.

Definition 14.2. Consider now the following canonical forms.

1. For any tuple $\boldsymbol{\mu} = (\mu_1, \dots, \mu_n) \in \mathbb{Z}^n$ consider the $(n+1) \times (n+1)$ matrix

$$S(\boldsymbol{\mu}) = \begin{array}{|c|} \hline \begin{array}{ccccc} 0 & t^{\mu_1} & 0 & \dots & 0 \\ 0 & 0 & t^{\mu_2} & \dots & 0 \\ \vdots & \vdots & \ddots & \ddots & \vdots \\ 0 & 0 & 0 & \ddots & t^{\mu_n} \\ 0 & 0 & 0 & \dots & 0 \end{array} \\ \hline \end{array}$$

2. Similarly, let $\boldsymbol{\nu} = (\nu_1, \dots, \nu_n) \in \mathbb{Z}^n$ be a non-periodic sequence, $m \in \mathbb{N}$ and $\xi \neq \pi(\xi) \in \mathbb{k}[\xi]$ be an irreducible monic polynomial of degree d . Let $F \in \text{Mat}_{md \times md}(\mathbb{D})$ be such that $\bar{F} = F(\pi^m) \in \text{Mat}_{md \times md}(\mathbb{k})$, where $F(\pi^m)$ is the Frobenius block corresponding to the polynomial π^m . Consider the following $d m n \times d m n$ matrix

$$B(\boldsymbol{\nu}, m, \pi) = \begin{array}{|c|} \hline \begin{array}{ccccc} 0 & t^{\nu_1} I & 0 & \dots & 0 \\ 0 & 0 & t^{\nu_2} I & \dots & 0 \\ \vdots & \vdots & \ddots & \ddots & \vdots \\ 0 & 0 & 0 & \ddots & t^{\nu_{n-1}} I \\ t^{\nu_n} F & 0 & 0 & \dots & 0 \end{array} \\ \hline \end{array}$$

where I is the identity matrix of size $dm \times dm$. □

The main goal of this section is to give a complete proof of the following result.

Theorem 14.3. *Let $W \in \text{Mat}_{n \times n}(\mathbb{K})$. Then we have:*

$$(14.1) \quad W \simeq \text{diag}(B(\boldsymbol{\nu}_1, m_1, \pi_1), \dots, B(\boldsymbol{\nu}_t, m_t, \pi_t), S(\boldsymbol{\mu}_1) \dots, S(\boldsymbol{\mu}_p)),$$

for certain data $(\boldsymbol{\nu}_1, m_1, \pi_1), \dots, (\boldsymbol{\nu}_t, m_t, \pi_t), \boldsymbol{\mu}_1, \dots, \boldsymbol{\mu}_p$ as above. Moreover, the blocks $B(\boldsymbol{\nu}, m, \pi)$ and $S(\boldsymbol{\mu})$ are indecomposable (they do not split further) and the following uniqueness results are true.

- The equivalence class of $B(\boldsymbol{\nu}, m, \pi)$ does not depend on the choice of a lift F of the Frobenius block $F(\pi^m)$. In fact, it only depends on the conjugacy class of \bar{F} over \mathbb{k} . In particular, if \mathbb{k} is algebraically closed and $\lambda \in \mathbb{k}^*$ then the Frobenius block $F((\xi - \lambda)^m)$ can be replaced by the Jordan block $J_m(\lambda)$.
- $B(\boldsymbol{\nu}, m, \pi) \not\simeq S(\boldsymbol{\mu})$ for any data $(\boldsymbol{\nu}, m, \pi)$ and $\boldsymbol{\mu}$.
- $S(\boldsymbol{\mu}) \simeq S(\boldsymbol{\mu}')$ if and only if $\boldsymbol{\mu}' = \boldsymbol{\mu}$.
- For $\boldsymbol{\nu} = (\nu_1, \nu_2, \dots, \nu_n)$ set $\boldsymbol{\nu}^{(1)} = (\nu_n, \nu_1, \dots, \nu_{n-1})$. Then we have:

$$B(\boldsymbol{\nu}^{(1)}, m, \pi) \simeq B(\boldsymbol{\nu}, m, \pi)$$

- Moreover, $B(\boldsymbol{\nu}, m, \pi) \simeq B(\tilde{\boldsymbol{\nu}}, \tilde{m}, \tilde{\pi})$ if and only if $(\pi, m) = (\tilde{\pi}, \tilde{m})$ and $\tilde{\boldsymbol{\nu}} = \boldsymbol{\nu}^{(l)}$ for some $l \in \mathbb{Z}$.
- The decomposition (14.1) is unique up to automorphisms of direct summands and permutation of blocks (Krull–Schmidt property).

Remark 14.4. Note the following statements about the above canonical forms $B(\boldsymbol{\nu}, m, \pi)$ and $S(\boldsymbol{\mu})$.

- The matrix $S(\boldsymbol{\mu})$ can be viewed as $B(\boldsymbol{\nu}, 1, \pi)$ where $\pi = \xi$ is the “forbidden” polynomial and $\boldsymbol{\nu} = (\mu_1, \dots, \mu_n, \nu)$ for $\boldsymbol{\mu} = (\mu_1, \dots, \mu_n)$ and some $\nu \in \mathbb{Z}$. However, this identification is not natural from the point of view of generalizations of the decorated conjugation problem (like representations of decorated bunches of chains).
- If the word $\boldsymbol{\nu}$ is periodic then the corresponding matrix $B(\boldsymbol{\nu}, m, \pi)$ is decomposable (at least, if $\text{char}(\mathbb{k}) = 0$).
- Theorem 14.3 is a special case of Theorem 7.1. In the notation of Example 6.11, the canonical form $B(\boldsymbol{\nu}, m, \pi)$ corresponds to the band object $B((w, \rho), m, \pi)$, where

$$(w, \rho) = \leftarrow f \sim e \xrightarrow{\nu_1} f \sim e \xrightarrow{\nu_2} \dots \xrightarrow{\nu_{n-1}} f \sim e \xrightarrow{\nu_n} .$$

Similarly, the canonical form $S(\boldsymbol{\mu})$ corresponds to the string object $S(w, \rho)$, where

$$(w, \rho) = f \sim e \xrightarrow{\mu_1} f \sim e \xrightarrow{\mu_2} \dots \xrightarrow{\mu_n} f \sim e.$$

In the notation of Theorem 7.1, we can always start our \mathfrak{X} -word (cyclic or not) with $f \in \mathfrak{F}$, reducing the number of non-equal but equivalent canonical forms.

14.1. Some preparatory results from linear algebra. In this subsection we collect some elementary results from linear algebra, playing a key role in the proof of Theorem 14.3. All proofs are sometimes lengthy, but always straightforward, so we leave them for an interested reader.

Lemma 14.5. *Let $Y \in \text{Mat}_{m \times n}(\mathbb{D})$ be such that $\text{rk}_{\mathbb{k}}(\bar{Y}) = r$. Then there exist $S \in \text{GL}_m(\mathbb{D})$ and $T \in \text{GL}_n(\mathbb{D})$ such that*

$$SYT^{-1} = \begin{pmatrix} I & 0 \\ 0 & tZ \end{pmatrix},$$

where $I = I_r$ is the identity matrix of size $r \times r$ and $Z \in \text{Mat}_{(m-r) \times (n-r)}(\mathbb{D})$.

Lemma 14.6. *Let $Y \in \text{Mat}_{m \times m}(\mathbb{D})$. Then the following results are true.*

- Assume that $\bar{Y} \in \text{Mat}_{m \times m}(\mathbb{k})$ is invertible. Then $Y \simeq \text{diag}(Y_1, \dots, Y_n)$, where $\bar{Y}_l = F(\pi_l^{r_l})$ for some irreducible polynomials $\xi \neq \pi_l \in \mathbb{k}[\xi]$ and $r_l \in \mathbb{N}$, $1 \leq l \leq n$.
- Assume that

$$\bar{Y} \sim \begin{pmatrix} \bar{Z} & 0 \\ 0 & \bar{N} \end{pmatrix},$$

where \bar{Z} is a square invertible matrix and \bar{N} a nilpotent matrix. Then

$$Y \simeq \begin{pmatrix} Y^* & 0 \\ 0 & Y^\circ \end{pmatrix},$$

where Y^* and Y° are such that $\bar{Y}^* = \bar{Z}$ and $\bar{Y}^\circ = \bar{N}$.

Lemma 14.6 shows that the description of the canonical form of $X \in \text{Mat}_{m \times m}(\mathbb{D})$ with respect to the \simeq equivalence relation reduces to the case when the matrix \bar{X} is nilpotent.

Next, recall the following version of the Jordan normal form of a nilpotent matrix.

Lemma 14.7. *Let $N \in \text{Mat}_{m \times m}(\mathbb{k})$ be a nilpotent matrix. Then we have:*

$$N \sim N(\underline{m}) := \begin{array}{c|ccc|ccc} \dots & & \vdots & & \vdots & & \vdots \\ \hline & 0 & I_3 & 0 & 0 & 0 & 0 \\ \dots & 0 & 0 & I_3 & 0 & 0 & 0 \\ & 0 & 0 & 0 & 0 & 0 & 0 \\ \hline \dots & 0 & 0 & 0 & 0 & I_2 & 0 \\ & 0 & 0 & 0 & 0 & 0 & 0 \\ \dots & 0 & 0 & 0 & 0 & 0 & 0 \end{array}$$

where the sequence $\underline{m} = (m_n, \dots, m_1) \in \mathbb{Z}_{\geq 0}^n$ is uniquely determined by N , $m = nm_n + \dots + 2m_2 + m_1$ and I_l is the identity matrix of size $m_l \times m_l$ for all $1 \leq l \leq n$.

From Lemma 14.7 one can easily deduce the following result.

Proposition 14.8. *Let $W \in \text{Mat}_{m \times m}(\mathbb{D})$ be such that \bar{W} is nilpotent. Then*

$$W \simeq W_0 + tZ = \begin{array}{c|ccc|ccc} \dots & & \vdots & & \vdots & & \vdots \\ \hline & 0 & I_3 & 0 & 0 & 0 & 0 \\ \dots & 0 & 0 & I_3 & 0 & 0 & 0 \\ & 0 & 0 & 0 & 0 & 0 & 0 \\ \hline \dots & 0 & 0 & 0 & 0 & I_2 & 0 \\ & 0 & 0 & 0 & 0 & 0 & 0 \\ \dots & 0 & 0 & 0 & 0 & 0 & 0 \end{array} + t \begin{array}{c|ccc|ccc} \dots & & \vdots & & \vdots & & \vdots \\ \hline & 0 & 0 & 0 & 0 & 0 & 0 \\ \dots & 0 & 0 & 0 & 0 & 0 & 0 \\ & Z_{33} & 0 & 0 & Z_{32} & 0 & Z_{31} \\ \hline \dots & 0 & 0 & 0 & 0 & 0 & 0 \\ & Z_{23} & 0 & 0 & Z_{22} & 0 & Z_{21} \\ \dots & Z_{13} & 0 & 0 & Z_{12} & 0 & Z_{11} \end{array}$$

where the block division of Z is the same as of $W_0 = N(\underline{m})$.

Finally, we shall need the following elementary but quite useful result. Let R be any ring and $X \in \text{Mat}_{m \times n}(R)$. For any $1 \leq l \leq m$ and $1 \leq t \leq n$ we denote by $X^{\#(l,t)}$ the $(m-1) \times (n-1)$ -matrix obtained from X by crossing out its l -th row and t -th column.

Lemma 14.9 (Crossing-Out Lemma). *Let $m, \check{m}, n, \check{n} \in \mathbb{N}$ and $1 \leq i \leq m$, $1 \leq \check{i} \leq \check{m}$, $1 \leq j \leq n$ and $1 \leq \check{j} \leq \check{n}$. Next, let $W \in \text{Mat}_{m \times n}(R)$ (respectively, $\check{W} \in \text{Mat}_{\check{m} \times \check{n}}(R)$) be such that all elements of the i -th row and j -th column of W (respectively, of the \check{i} -th row and \check{j} -th column of \check{W}) but w_{ij} (respectively $w_{\check{i}\check{j}}$) are zero. Let $S \in \text{Mat}_{\check{m} \times m}(R)$ and $T \in \text{Mat}_{n \times \check{n}}(R)$ be such that $SW = \check{W}T$. Then we have the following equality:*

$$(14.2) \quad S^{\#(i,i)} W^{\#(i,j)} = \check{W}^{\#(\check{i},\check{j})} T^{\#(j,j)}$$

14.2. Reduction to the decorated chessboard problem. The further strategy is the following: we shall apply only those transformations of W which do not “spoil” the canonical form of W_0 and preserve the block structure of Z in the decomposition from Proposition 14.8. The following statement plays a key role in this reduction procedure.

Proposition 14.10. *Let $\underline{m} = (m_n, \dots, m_1), \underline{\tilde{m}} = (\tilde{m}_n, \dots, \tilde{m}_1) \in \mathbb{Z}_{\geq 0}^n$ be two collections of non-negative integers, $m = m_1 + 2m_2 + \dots + nm_n$ and $\tilde{m} = \tilde{m}_1 + 2\tilde{m}_2 + \dots + n\tilde{m}_n$. Let*

$$(14.3) \quad T(\underline{m}, \underline{\tilde{m}}) := \left\{ A \in \text{Mat}_{\tilde{m} \times m}(\mathbb{k}) \mid AN(\underline{m}) = N(\underline{\tilde{m}})A \right\}.$$

Then this vector space has the following explicit description:

$$T(\underline{m}, \tilde{\underline{m}}) = \left\{ A = \begin{array}{c|ccc|ccc} \cdots & & \cdots & & \cdots & & \cdots \\ \hline & A_{33}^1 & A_{33}^2 & A_{33}^3 & A_{32}^1 & A_{32}^2 & A_{31}^1 \\ \vdots & 0 & A_{33}^1 & A_{33}^2 & 0 & A_{32}^1 & 0 \\ \hline & 0 & 0 & A_{33}^1 & 0 & 0 & 0 \\ \vdots & 0 & A_{23}^1 & A_{23}^2 & A_{22}^1 & A_{22}^2 & A_{21}^1 \\ \vdots & 0 & 0 & A_{33}^1 & 0 & A_{22}^1 & 0 \\ \hline \vdots & 0 & 0 & A_{13}^1 & 0 & A_{12}^1 & A_{11}^1 \end{array} \right\} A_{kl}^{(p)} \in \text{Mat}_{\tilde{m}_k \times m_l}(\mathbb{k})$$

Proof. Straightforward computation, see for example [43, Section VIII.2]. \square

For $\underline{p} = (p_1, \dots, p_n)$ and $p = p_1 + \dots + p_n$ consider the following parabolic subalgebras $P^\pm(\underline{p})$ of the matrix algebra $\text{Mat}_{p \times p}(\mathbb{k})$:

$$P^+(\underline{p}) = \left\{ B^+ = \begin{array}{c|cccc} B_{11}^+ & B_{12}^+ & \cdots & B_{1n}^+ \\ 0 & B_{22}^+ & \cdots & B_{2n}^+ \\ \vdots & \vdots & \ddots & \vdots \\ 0 & 0 & \cdots & B_{nn}^+ \end{array} \right\} B_{lk} \in \text{Mat}_{p_l \times p_k}(\mathbb{k})$$

and $P^-(\underline{p})$ is the “transpose” of $P^+(\underline{p})$. Let

$$D(\underline{p}) = \{(B^+, B^-) \in P^+(\underline{p}) \times P^-(\underline{p}) \mid B_{ll}^+ = B_{ll}^-, 1 \leq l \leq n\}$$

be the “dyad” of $P^+(\underline{p})$ and $P^-(\underline{p})$.

Corollary 14.11. *Let $\underline{m} = (m_n, \dots, m_1) \in \mathbb{Z}_{\geq 0}^n$ and $E(\underline{m}) := T(\underline{m}, \underline{m})$. Then the map*

$$(14.4) \quad R : E(\underline{m}) \longrightarrow D(\underline{m}), \quad A \mapsto (B^+, B^-),$$

where B^\pm are the following matrices

$$B^- = \begin{array}{c|ccc} \cdots & \vdots & \vdots & \vdots \\ \cdots & A_{33}^1 & 0 & 0 \\ \cdots & A_{23}^1 & A_{22}^1 & 0 \\ \cdots & A_{13}^1 & A_{12}^1 & A_{11}^1 \end{array} \quad B^+ = \begin{array}{c|ccc} \cdots & \vdots & \vdots & \vdots \\ \cdots & A_{33}^1 & A_{32}^1 & A_{31}^1 \\ \cdots & 0 & A_{22}^1 & A_{21}^1 \\ \cdots & 0 & 0 & A_{11}^1 \end{array}$$

is a surjective algebra homomorphism. Moreover, the induced algebra homomorphism

$$\bar{R} : E(\underline{m})/\text{rad}(E(\underline{m})) \longrightarrow D(\underline{m})/\text{rad}(D(\underline{m}))$$

is an isomorphism.

Proof. The fact that R is an algebra homomorphism follows from the following observation. Let $A \in E(\underline{m})$ be written as in Proposition 14.10. Then apart of the blocks from the “diagonal mega-blocks”, either of two blocks of A , mirror to each other along the main diagonal, is zero. Proofs of the remaining statements are straightforward. \square

Definition 14.12. For a matrix $Y \in \text{Mat}_{m \times n}(\mathbb{K})$, define its *valuation* $\text{val}(Y)$ as the biggest $\nu \in \mathbb{Z}$ such that $Y = t^\nu Y_\diamond$ for some $Y_\diamond \in \text{Mat}_{m \times n}(\mathbb{D})$. In particular, the valuation of the zero matrix is infinity.

To proceed with the further reduction, it is convenient to use the formalism of decorated bunches of chains, introduced in Section 6. Let \mathfrak{J} (respectively \mathfrak{X}) be the decorated bunch of chains introduced in Example 6.11 (decorated conjugation problem), respectively in Example 6.13 (decorated chessboard problem), where the permutation σ is trivial.

Definition 14.13. For any $\nu \in \mathbb{Z}$ consider the following full subcategory of $\text{Rep}(\mathfrak{X})$:

$$\text{Rep}(\mathfrak{X}(\nu)) := \left\{ W \in \text{Ob}(\text{Rep}(\mathfrak{X})) \mid \text{val}(W) \geq \nu \right\}.$$

Next, consider the full subcategory of $\text{Rep}(\mathfrak{J})$:

$$\text{Rep}^0(\mathfrak{J}(0)) := \left\{ W \in \text{Ob}(\text{Rep}(\mathfrak{J}(0))) \mid \bar{W} \text{ is nilpotent} \right\}.$$

Finally, let $\text{Rep}_{\text{st}}^0(\mathfrak{J}(0))$ be the full subcategory of $\text{Rep}^0(\mathfrak{J}(0))$ consisting of standard objects, i.e. of matrices W as in Proposition 14.8. For such W we set

$$Z_{\text{red}} := \begin{array}{|c|} \hline \begin{array}{ccc} \cdots & \vdots & \vdots & \vdots \\ \cdots & Z_{33} & Z_{32} & Z_{31} \\ \cdots & Z_{23} & Z_{22} & Z_{21} \\ \cdots & Z_{13} & Z_{12} & Z_{11} \end{array} \\ \hline \end{array}$$

The next result follows from Lemma 14.9, Proposition 14.10 and Corollary 14.11.

Proposition 14.14. *The map $R : \underline{\text{Rep}}_{\text{st}}^0(\mathfrak{J}(0)) \rightarrow \underline{\text{Rep}}(\mathfrak{X}(0))$, $W \mapsto Z_{\text{red}}$ extends to a \mathbb{D} -linear functor sending a morphism (S, T) to (S^\sharp, T^\sharp) . Here, S^\sharp (respectively T^\sharp) is the matrix obtained from S (respectively T) by crossing out appropriate zero columns and rows according to the decomposition of W_0 in the presentation as in Proposition 14.8. Moreover, the functor R is a representation equivalence, i.e.*

- R is essentially surjective.
- For $W, W' \in \text{Ob}(\underline{\text{Rep}}_{\text{st}}^0(\mathfrak{J}(0)))$ we have: $R(W) \cong R(W')$ if and only if $W \cong W'$.

Remark 14.15. Note that the last two properties imply that $W \in \text{Ob}(\underline{\text{Rep}}_{\text{st}}^0(\mathfrak{J}))$ is indecomposable if and only if $R(W)$ is indecomposable.

Proposition 14.14 shows that the proof of Theorem 14.3 reduces to a classification of “indecomposable decorated chessboards”. At first glance it looks like a digression because the new matrix problem seems to be more general (and complicated) than the original one. However, it turns out to be an illusion. In the next subsection we shall see that the decorated chessboard problem is “self-reproducible” in an appropriate sense.

14.3. Reduction procedure for the decorated chessboard problem. As in the previous subsection, let \mathfrak{X} be the decorated bunch of chains from Example 6.6 with trivial permutation parameter σ . Recall from Subsection 6.4 that an object of $\text{Rep}(\mathfrak{X})$ is given by the data $W = (\mathbf{d}, \{W_{pq}\}_{p,q \in \mathbb{N}})$, where

- $\mathbf{d} : \mathbb{N} \rightarrow \mathbb{Z}_{\geq 0}$, $p \mapsto \mathbf{d}_p$ is a function with finite support.
- For any $p, q \in \mathbb{N}$, W_{pq} is a matrix from $\text{Mat}_{\mathbf{d}_p \times \mathbf{d}_q}(\mathbb{K})$.

A morphism $W = (\mathbf{d}, \{W_{pq}\}) \longrightarrow \check{W} = (\check{\mathbf{d}}, \{\check{W}_{pq}\})$ is given by a collection of matrices $(F_\bullet, G_\bullet) = (\{F_{uv}\}, \{G_{uv}\})$ such that $F_{uv}, G_{uv} \in \text{Mat}_{\check{d}_u \times \check{d}_v}(\mathbb{D})$ for $u, v \in \mathbb{N}$; $\bar{F}_{uu} = \bar{G}_{uu}$ for all $u \in \mathbb{N}$ and $F_{uv} \in \text{Mat}_{\check{d}_u \times \check{d}_v}(\mathbf{m})$ for $u < v$ and $G_{uv} \in \text{Mat}_{\check{d}_u \times \check{d}_v}(\mathbf{m})$ for $u > v$, satisfying the following constraint:

$$(14.5) \quad \sum_{l < p} F_{pl} W_{lq} + F_{pp} W_{pq} + \sum_{l > p} F_{pl} W_{lq} = \sum_{t > q} \check{W}_{pt} G_{tq} + \check{W}_{pq} G_{qq} + \sum_{t < q} \check{W}_{pt} G_{tq}.$$

Definition 14.16. Consider the following ordering on $\mathbb{N} \times \mathbb{N}$: $(p, q) < (p', q')$ if $p < p'$ or $p = p'$ and $q > q'$. Let $W = (\mathbf{d}, \{W_{ij}\})$ be an object of $\text{Rep}(\mathfrak{X})$. We say that the block W_{pq} is minimal if $\text{val}(W_{pq}) \leq \text{val}(W_{p'q'})$ for all $(p', q') \in \mathbb{N} \times \mathbb{N}$ and $\text{val}(W_{pq}) < \text{val}(W_{p'q'})$ for $(p', q') < (p, q)$.

Definition 14.17. For any $(p, q) \in \mathbb{N} \times \mathbb{N}$, let $\text{Rep}^{\leq(p,q)}(\mathfrak{X}(\nu))$ be the full subcategory of $\text{Rep}(\mathfrak{X}(\nu))$ consisting of those objects W for which the block W_{pq} is minimal.

Convention. Let $Y \in \text{Mat}_{m \times n}(\mathbb{K})$ be such that $\text{val}(Y) \geq \nu$. In what follows we shall use the notation $Y = t^\nu Y_\diamond$ for an appropriate $Y_\diamond \in \text{Mat}_{m \times n}(\mathbb{D})$.

Case 1. Suppose that $p \neq q$. Then there exist $F_{pp} \in \text{GL}_{\check{d}_p}(\mathbb{D})$, $G_{qq} \in \text{GL}_{\check{d}_q}(\mathbb{D})$ such that

$$(\check{W}_{pq})_\diamond := F_{pp}(W_{pq})_\diamond G_{qq}^{-1} = \begin{pmatrix} I & 0 \\ 0 & t\Psi \end{pmatrix}$$

for some matrix Ψ with coefficients over \mathbb{D} . Moreover, the entire system of matrices $W = \{W_{ij}\}$ can be transformed into the following ‘‘standard’’ form: $W = t^\nu W_\diamond$, where W_\diamond is the following matrix:

		y_p		y_q			
		*	B_1	B_2	0	*	*
x_p		0	0	0	I	0	0
		*	*	*	0	$t\Psi$	*
x_q		C_1	D_1^1	D_1^2	0	E_1	G_1
		C_2	D_2^1	D_2^2	0	E_2	G_2
		*	F_1	F_2	0	*	*
			y_p^1	y_p^2			

Let $\text{Rep}_{\text{st}}^{\leq(p,q)}(\mathfrak{X}(\nu))$ be the full subcategory of $\text{Rep}^{\leq(p,q)}(\mathfrak{X}(\nu))$ consisting of objects in the standard form. Clearly, the embedding $\text{Rep}_{\text{st}}^{\leq(p,q)}(\mathfrak{X}(\nu)) \hookrightarrow \text{Rep}^{\leq(p,q)}(\mathfrak{X}(\nu))$ is an equivalence of categories.

Definition 14.18. Consider a new decorated chessboard $\mathfrak{X}^{(p,q)} = \check{\mathfrak{X}}$ defined as follows:

- $x_q \mapsto \{x_q^{(1)}, x_q^{(2)}\}$ and $y_p \mapsto \{y_p^{(1)}, y_p^{(2)}\}$,
- The new order on $\check{\mathfrak{C}}$ and $\check{\mathfrak{F}}$ is defined as follows:

$$x_l \triangleleft x_q^{(1)} \triangleleft x_q^{(2)} \triangleleft x_t \text{ and } y_r \triangleright y_p^{(1)} \triangleright y_p^{(2)} \triangleright y_s \text{ for all } l < q < t \text{ and } r < p < s.$$

- The new equivalence relation (defining an appropriate bijection between the column and row labels from Example 6.6) is the following:

$$x_p \sim y_p^{(2)}, y_q \sim x_q^{(2)} \quad \text{and} \quad x_q^{(1)} \sim y_p^{(1)}.$$

The remaining equivalence relations in $\check{\mathfrak{X}}$ are the same as in \mathfrak{X} .

Let W be an object of $\text{Rep}_{\text{st}}^{\leq(p,q)}(\check{\mathfrak{X}}(\nu))$ such that $\overline{(W_{pq})_{\diamond}} \neq 0$. Consider the object W^{\sharp} of $\text{Rep}(\check{\mathfrak{X}})$ obtained from W by the following operations.

- We cross out all rows and columns of W , containing the entry 1 in the block W_{pq} .
- Next, we give new weights $x_q^{(1)}, x_q^{(2)}$ to the horizontal stripe x_q and $y_p^{(1)}, y_p^{(2)}$ to the vertical stripe y_p induced by the block division of the matrix W_{pq} .

If $\overline{(W_{pq})_{\diamond}} = 0$ then we pose $W^{\sharp} = W$.

Example 14.19. For the object W given in the example above we have $W^{\sharp} = t^{\nu}W_{\diamond}^{\sharp}$, where W_{\diamond}^{\sharp} is the following matrix:

	y_p^1	y_p^2	y_q	
	*	B_1	B_2	*
x_p	*	*	*	$t\Psi$
x_q^1	C_1	D_1^1	D_1^2	E_1
x_q^2	C_2	D_2^1	D_2^2	E_2
	*	F_1	F_2	*

Proposition 14.20. *The assignment $R^{pq} : \underline{\text{Rep}}_{\text{st}}^{\leq(p,q)}(\check{\mathfrak{X}}(\nu)) \rightarrow \underline{\text{Rep}}^{<((p,q),\nu)}(\check{\mathfrak{X}}(\nu))$, $W \mapsto W^{\sharp}$ is a representation equivalence of categories, where $\underline{\text{Rep}}^{<((p,q),\nu)}(\check{\mathfrak{X}}(\nu))$ is the full subcategory of $\text{Rep}^{\leq(p,q)}(\check{\mathfrak{X}}(\nu))$ consisting of those objects U for which $\text{val}(U_{pq}) > \nu$.*

Proof. Let $(F_{\bullet}, G_{\bullet}) : W \rightarrow \tilde{W}$ be a morphism in $\text{Rep}_{\text{st}}^{\leq(p,q)}(\mathfrak{X})$. Equality (14.5) implies:

$$F_{pp} \begin{pmatrix} I & 0 \\ 0 & t\Psi \end{pmatrix} = \begin{pmatrix} I' & 0 \\ 0 & t\Psi' \end{pmatrix} G_{qq} \pmod{\mathfrak{m}}.$$

Thus we have: $\bar{G}_{pp} = \bar{F}_{pp} = \begin{pmatrix} X & Y \\ 0 & T \end{pmatrix} \pmod{\mathfrak{m}}$ and $\bar{F}_{qq} = \bar{G}_{qq} = \begin{pmatrix} X & 0 \\ Z & S \end{pmatrix} \pmod{\mathfrak{m}}$ for appropriate matrices X, Y, Z, T and S over \mathbb{k} .

By Crossing-Out Lemma 14.9, the equality $F_{\bullet}W = \tilde{W}G_{\bullet}$ yields the equality $F_{\bullet}^{\sharp}W^{\sharp} = \tilde{W}^{\sharp}G_{\bullet}^{\sharp}$, where F_{\bullet}^{\sharp} (respectively G_{\bullet}^{\sharp}) is obtained from F_{\bullet} (respectively G_{\bullet}) by crossing-out appropriate columns and rows. Hence, we obtain a well-defined map

$$R^{pq} : \text{Hom}_{\mathfrak{X}}(W, \tilde{W}) \rightarrow \text{Hom}_{\check{\mathfrak{X}}}(W^{\sharp}, \tilde{W}^{\sharp}), \quad (F_{\bullet}, G_{\bullet}) \mapsto (F_{\bullet}^{\sharp}, G_{\bullet}^{\sharp}).$$

Note that $R^{pq} : \underline{\text{Rep}}_{\text{st}}^{\leq(p,q)}(\check{\mathfrak{X}}(\nu)) \rightarrow \underline{\text{Rep}}^{<((p,q),\nu)}(\check{\mathfrak{X}}(\nu))$ is indeed a functor.

To show that R^{pq} is a representation equivalence, it is sufficient to prove the following statement. Let $\check{f} : W^{\sharp} \rightarrow \tilde{W}^{\sharp}$ be an *isomorphism* in $\underline{\text{Rep}}^{<((p,q),\nu)}(\check{\mathfrak{X}}(\nu))$. Then there

exists an isomorphism $f : W \longrightarrow \tilde{W}$ in $\underline{\text{Rep}}_{\text{st}}^{\leq(p,q)}(\mathfrak{X}(\nu))$ such that $R^{pq}(f) = \check{f}$. Since any isomorphism in $\underline{\text{Rep}}(\check{\mathfrak{X}})$ can be written as a composition of elementary transformations, it suffices to prove liftability of an elementary transformation. However, this property follows from a direct case-by-case verification. \square

Case 2. Suppose that $p = q$. According to Lemma 14.6, we have: $(W_{pp})_{\diamond} \simeq \begin{pmatrix} Z & 0 \\ 0 & N \end{pmatrix}$, where the matrix Z is invertible and N is nilpotent. It is then clear, that $W \simeq t^{\nu}V$, where V is the following matrix:

$$\begin{array}{c}
 y_p \\
 \begin{array}{|c|c|c|c|}
 \hline
 & 0 & & \\
 \hline
 0 & Z & 0 & 0 \\
 \hline
 & 0 & N & \\
 \hline
 & 0 & & \\
 \hline
 \end{array} \\
 x_p
 \end{array}$$

In particular, $t^{\nu}Z$ splits as a direct summand of W . Thus, we may restrict ourselves on the full subcategory $\underline{\text{Rep}}^{\leq(p,p),\circ}(\mathfrak{X}(\nu))$ of $\underline{\text{Rep}}^{\leq(p,p)}(\mathfrak{X}(\nu))$ consisting of those objects for which $\overline{(W_{pp})_{\diamond}}$ is a nilpotent matrix. According to Proposition 14.8, $(W_{pp})_{\diamond} \simeq N + tZ$, where N is the normal form of $\overline{(W_{pp})_{\diamond}}$ as in Lemma 14.7. Then $W \simeq t^{\nu}V$, where V is the following matrix:

$$\begin{array}{c}
 y_p \\
 \begin{array}{|c|c|c|c|c|c|c|c|}
 \hline
 & & 0 & 0 & 0 & & & \\
 \hline
 & \dots & \vdots & \vdots & \vdots & & & \\
 \hline
 0 & \dots & 0 & I_3 & 0 & 0 & 0 & 0 & 0 \\
 \hline
 0 & \dots & 0 & 0 & I_3 & 0 & 0 & 0 & 0 \\
 \hline
 & & tZ_{33} & 0 & 0 & tZ_{32} & 0 & tZ_{31} & \\
 \hline
 0 & \dots & 0 & 0 & 0 & 0 & I_2 & 0 & 0 \\
 \hline
 & & tZ_{23} & 0 & 0 & tZ_{22} & 0 & tZ_{21} & \\
 \hline
 & & tZ_{13} & 0 & 0 & tZ_{12} & 0 & tZ_{11} & \\
 \hline
 & & 0 & 0 & 0 & & & & \\
 \hline
 \end{array} \\
 x_p
 \end{array}$$

Let $\underline{\text{Rep}}_{\text{st}}^{\leq(p,p),\circ}(\mathfrak{X}(\nu))$ be the full subcategory of $\underline{\text{Rep}}^{\leq(p,p),\circ}(\mathfrak{X}(\nu))$ consisting of objects having the above standard form. Clearly, the inclusion $\underline{\text{Rep}}_{\text{st}}^{\leq(p,p),\circ}(\mathfrak{X}(\nu)) \hookrightarrow \underline{\text{Rep}}^{\leq(p,p),\circ}(\mathfrak{X}(\nu))$ is an equivalence of categories.

Definition 14.21. Consider a new decorated chessboard $\mathfrak{X}^{(p,p)} = \check{\mathfrak{X}}$ defined as follows.

- The sets \mathfrak{E}_* and \mathfrak{F}_* are obtained by replacing

$$x_p \mapsto \{\dots \triangleleft x_p^{(l)} \triangleleft \dots \triangleleft x_p^{(2)} \triangleleft x_p^{(1)}\} \quad \text{and} \quad y_p \mapsto \{\dots \triangleright y_p^{(l)} \triangleright \dots \triangleright y_p^{(2)} \triangleright y_p^{(1)}\}.$$

Abusing the notation, we shall also write $x_p^{(1)} = x_p$ and $y_p^{(1)} = y_p$.

- The new ordering in $\check{\mathfrak{X}}$ is defined as follows:

$$x_m \triangleleft x_p^{(l)} \triangleleft x_n \quad \text{and} \quad y_m \triangleright y_p^{(l)} \triangleright y_n$$

for any $m < p < n \in \mathbb{N}$ and any $l \in \mathbb{N}$.

- We have the equivalence relations $x_p^{(l)} \sim y_p^{(l)}$ for any $l \in \mathbb{N}$ as well as all remaining old equivalences $x_n \sim y_n$ for $n \neq p$.

Again, for any object W of $\text{Rep}_{\text{st}}^{\leq(p,p),\circ}(\check{\mathfrak{X}}(\nu))$ let W^\sharp be the object of $\text{Rep}(\check{\mathfrak{X}})$ obtained from W by the following operations.

- We cross out those rows of weight x_p and columns of weight y_p of the matrix W , which contain the entry 1 in the normal form N .
- The survived rows of stripe x_p and columns of stripe y_p get new labels $x_p^{(l)}$ and $y_p^{(l)}$ according to the block division of the normal form of N (i.e. the upper label is l if the corresponding column/row corresponds to the nilpotent Jordan block $J_l(0)$).

Proposition 14.22. *The map $R^{pp} : \text{Rep}_{\text{st}}^{\leq(p,p),\circ}(\check{\mathfrak{X}}(\nu)) \longrightarrow \text{Rep}^{(p,p),\nu}(\check{\mathfrak{X}}(\nu))$ is functorial, where $\text{Rep}^{(p,p),\nu}(\check{\mathfrak{X}}(\nu))$ is the full subcategory of $\text{Rep}(\check{\mathfrak{X}}(\nu))$ consisting of those objects V for which $\text{val}(V_{pp}) > \nu$. Moreover, R^{pp} is a representation equivalence of categories.*

Proof. All major steps are basically the same as in Proposition 14.20. First, we use the equality (14.5), Proposition 14.10 and Crossing–Out Lemma 14.9 to construct a map

$$R^{pp} : \text{Hom}_{\check{\mathfrak{X}}}(W, \tilde{W}) \longrightarrow \text{Hom}_{\check{\mathfrak{X}}}(W^\sharp, \tilde{W}^\sharp)$$

for any pair of objects W, \tilde{W} of $\text{Rep}_{\text{st}}^{\leq(p,p),\circ}(\check{\mathfrak{X}}(\nu))$. The functoriality of R^{pp} on the level of stabilized bimodule categories is clear. Finally, the claim that for any isomorphism $\check{f} : W^\sharp \longrightarrow \tilde{W}^\sharp$ in $\text{Rep}^{(p,p),\nu}(\check{\mathfrak{X}}(\nu))$ there exists an isomorphism $f : W \longrightarrow \tilde{W}$ in $\text{Rep}_{\text{st}}^{\leq(p,p),\circ}(\check{\mathfrak{X}}(\nu))$ such that $R^{pp}(f) = \check{f}$, is essentially a consequence of Corollary 14.11. \square

14.4. Indecomposable representations of a decorated chessboard. Let $\check{\mathfrak{X}}$ be a bunch of chains from Example 6.6. In this part, we describe indecomposable objects of $\text{Rep}(\check{\mathfrak{X}})$ (assume for simplicity of notation that the permutation σ is trivial). Although the final answer can be stated in completely elementary terms, for the proof it is convenient to use the formalism of strings and bands from Subsection 6.5.

Observe that any element of $\check{\mathfrak{X}}$ is tied. Hence, without loss of generality we may start any $\check{\mathfrak{X}}$ –word (cyclic or not) with an element of \mathfrak{F} . Concretely, a decorated word defining a string representation has the form

$$(14.6) \quad (w, \rho) = y_{j_1} \sim x_{j_1} \xrightarrow{\mu_1} y_{j_2} \sim x_{j_2} \xrightarrow{\mu_2} \cdots \xrightarrow{\mu_n} y_{j_{n+1}} \sim x_{j_{n+1}}$$

for any $n \in \mathbb{Z}_{\geq 0}$, $j_1, \dots, j_{n+1} \in \mathbb{N}$ and $(\mu_1, \dots, \mu_n) \in \mathbb{Z}^n$. Similarly, a cyclic decorated word defining a band representation has the form

$$(14.7) \quad (w, \rho) = \leftarrow y_{i_1} \sim x_{i_1} \xrightarrow{\nu_1} y_{i_2} \sim x_{i_2} \xrightarrow{\nu_2} \cdots \xrightarrow{\nu_{n-1}} y_{i_n} \sim x_{i_n} \xrightarrow{\nu_n}$$

where $n \in \mathbb{N}$ and $((i_1, \nu_1), \dots, (i_n, \nu_n)) \in (\mathbb{N} \times \mathbb{Z})^n$ is a non–periodic sequence. For a decorated word (w, ρ) (respectively for a non–periodic cyclic decorated word (w, ρ) , $m \in \mathbb{N}$ and an irreducible polynomial $\xi \neq \pi \in \mathbb{k}[\xi]$) consider the objects $S(w, \rho)$ (respectively $B((w, \rho), m, \pi)$) given by the same matrix as in Definition 14.2 but with an additional labeling of rows and columns with weights $x_{j_1}, \dots, x_{j_{n+1}}$ and $y_{j_1}, \dots, y_{j_{n+1}}$ (respectively, with x_{i_1}, \dots, x_{i_n} and y_{i_1}, \dots, y_{i_n}).

Example 14.23. Let $(w, \rho) = \leftarrow y_1 \sim x_1 \overset{3}{-} y_1 \sim x_1 \overset{-2}{-} y_2 \sim x_2 \overset{0}{-} y_1 \sim x_1 \overset{3}{-} y_2 \sim x_2 \overset{1}{-}$, $m \in \mathbb{N}$, $\lambda \in \mathbb{k}^*$ and $\pi = \xi - \lambda$. Then we get the following canonical forms: $B((w, \rho), m, \pi) =$

$$\begin{array}{c} \begin{array}{cc} & \begin{array}{cc} y_1 & y_2 \end{array} \\ \begin{array}{c} x_1 \\ x_1 \\ x_2 \\ x_1 \\ x_2 \end{array} & \begin{array}{ccccc} \boxed{\begin{array}{ccccc} 0 & t^3 I & 0 & 0 & 0 \\ 0 & 0 & t^{-2} I & 0 & 0 \\ 0 & 0 & 0 & I & 0 \\ 0 & 0 & 0 & 0 & t^3 I \\ tJ & 0 & 0 & 0 & 0 \end{array}} \end{array} & \simeq & \begin{array}{cc} & \begin{array}{cc} y_1 & y_2 \end{array} \\ \begin{array}{c} x_1 \\ x_1 \\ x_2 \end{array} & \begin{array}{cc|cc} \boxed{\begin{array}{cc|cc} 0 & t^3 I & 0 & 0 & 0 \\ 0 & 0 & 0 & t^{-2} I & 0 \\ 0 & 0 & 0 & 0 & t^3 I \end{array}} \\ \hline \begin{array}{c} x_2 \\ x_2 \end{array} & \begin{array}{cc|cc} \boxed{\begin{array}{cc|cc} 0 & 0 & I & 0 & 0 \\ tJ & 0 & 0 & 0 & 0 \end{array}} \end{array} \end{array} \end{array}$$

where as usual, $I = I_m$ is the identity $m \times m$ matrix and $J = J_m(\lambda)$ is the Jordan block of size $m \times m$ with eigenvalue λ .

Lemma 14.24. *Let $p, m \in \mathbb{N}$, $\nu \in \mathbb{Z}$ and $\xi \neq \pi \in \mathbb{k}[\xi]$ and irreducible polynomial. Then the band object $W = B((w, \rho), m, \pi)$ with $(w, \rho) = \leftarrow y_p \sim x_p \overset{\nu}{-}$ is indecomposable. Similarly, the string object $S(w, \rho)$ with $(w, \rho) = \underbrace{y_p \sim x_p \overset{\nu}{-} y_p \sim x_p \overset{\nu}{-} \cdots \overset{\nu}{-} y_p \sim x_p}_{m \text{ times}}$ is indecomposable as well.*

Proof. Let W be an object as above. It is sufficient to show that the endomorphism algebra $\Lambda := \text{End}_{\mathfrak{X}}(W)$ is local. To prove this, observe that $t\Lambda \subseteq \text{rad}(\Lambda)$ and $\Lambda/t\Lambda = \mathbb{k}[\xi]/(\pi^m)$ (where $\pi = \xi$ is the string case). \square

Lemma 14.25. *For any band datum $((w, \rho), m, \pi)$ and $l \in \mathbb{Z}$ we have an isomorphism*

$$B((w, \rho), m, \pi) \cong B((w^{(l)}, \rho^{(l)}), m, \pi),$$

where $(w^{(l)}, \rho^{(l)})$ is the rotation of (w, ρ) by l positions. In particular, we may always achieve that the decoration of the exceptional edge takes the maximal value among all $\rho(i)$ for $i \in \tau(w^+)$.

Proof. It is a straightforward linear algebra argument. \square

Now we have all ingredients to state and prove the main theorem of this section.

Theorem 14.26. *Let \mathfrak{X} be a decorated chessboard as above.*

- (1) *The string objects $S(w, \rho)$ and band objects $B((w, \rho), m, \pi)$ are indecomposable.*
- (2) *Moreover, any indecomposable object of $\text{Rep}(\mathfrak{X})$ is isomorphic to some string or band object.*
- (3) *We have: $B((w, \rho), m, \pi) \not\cong S(\tilde{w}, \tilde{\rho})$ for any band datum $((w, \rho), m, \pi)$ and string datum $(\tilde{w}, \tilde{\rho})$.*
- (4) *Fixing the conventions (14.6) and (14.7) (any \mathfrak{X} -word starts with a column element) we also get:*
 - (a) *$S(w, \rho) \cong S(w', \rho')$ if and only if $(w, \rho) = (w', \rho')$.*
 - (b) *$B((w, \rho), m, \pi) \cong B((\tilde{w}, \tilde{\rho}), \tilde{m}, \tilde{\pi})$ if and only if $(\pi, m) = (\tilde{\pi}, \tilde{m})$ and (w, ρ) is a rotation of $(\tilde{w}, \tilde{\rho})$.*
- (5) *A decomposition of an object of $\text{Rep}(\mathfrak{X})$ into a direct sum of indecomposable objects is unique up to a permutation and automorphisms of indecomposable direct summands.*

Proof. The main ingredients are provided by Propositions 14.20 and 14.22.

(1). Let W be either band or string object. According to Lemma 14.24, the band object $B((w, \rho), m, \pi)$ with $(w, \rho) = \leftarrow y_p \sim x_p \xrightarrow{\nu}$ is indecomposable for any $p \in \mathbb{N}$, $\nu \in \mathbb{Z}$. In all other cases, W belongs to some subcategory $\text{Rep}^{\leq(p,q)}(\mathfrak{X}(\nu))$ (with $p \neq q$) or $\text{Rep}^{\leq(p,p),\circ}(\mathfrak{X}(\nu))$, for some $\nu \in \mathbb{Z}$. We assume that $\overline{(W_{pq})_\diamond} \neq 0$. Recall that we have constructed representation equivalences

- $R = R^{pq} : \text{Rep}^{\leq(p,q)}(\mathfrak{X}(\nu)) \longrightarrow \text{Rep}^{((p,q),\nu)}(\check{\mathfrak{X}}(\nu))$ and
- $R = R^{pp} : \text{Rep}^{\leq(p,p),\circ}(\mathfrak{X}(\nu)) \longrightarrow \text{Rep}^{((p,p),\nu)}(\check{\mathfrak{X}}(\nu))$.

Then the following key property is true:

$$(14.8) \quad R\left(B((w, \rho), m, \pi)\right) \cong B((\check{w}, \check{\rho}), m, \pi) \quad \text{and} \quad R(S(w, \rho)) \cong S(\check{w}, \check{\rho}),$$

where (w, ρ) and $(\check{w}, \check{\rho})$ are related by the following rules.

- In the case $p \neq q$ replace, $x_q^{(2)}$ by x_q , $y_p^{(2)}$ by y_p and every fragment $u \xrightarrow{\alpha} y_p^{(1)} \sim x_q^{(1)} \xrightarrow{\beta} v$ in $(\check{w}, \check{\rho})$ by $u \xrightarrow{\alpha} y_p \sim x_p \xrightarrow{\nu} y_q \sim x_q \xrightarrow{\beta} v$ to get (w, ρ) .
- In the case $p = q$, replace every fragment $u \xrightarrow{\alpha} y_p^{(l)} \sim x_p^{(l)} \xrightarrow{\beta} v$ in $(\check{w}, \check{\rho})$ by $u \xrightarrow{\alpha} y_p \sim \underbrace{x_p \xrightarrow{\nu} \cdots \xrightarrow{\nu} y_p}_{l \text{ times}} \sim x_p \xrightarrow{\beta} v$ to get (w, ρ) .

In the case of bands, we use Lemma 14.25 to move the Frobenius block F from the matrix W_{pp} (if necessary). Now, the indecomposability of bands and strings follow from Lemma 14.24 and formula (14.8) by induction on the size of the matrix.

(2). Let $W \in \text{Rep}(\mathfrak{X})$ be an indecomposable object, $\nu = \text{val}(W)$ and $(p, q) \in \mathbb{N}^2$ are such that the block W_{pq} is minimal. Assume first that $p = q$ and $\overline{(W_{pq})_\diamond}$ is not nilpotent. Then W must contain some band $B((w, \rho), m, \pi)$ as a direct summand, where $(w, \rho) = \leftarrow y_p \sim x_p \xrightarrow{\nu}$. According to Lemma 14.24, the latter object is indecomposable, hence W coincides with it. Otherwise, consider the reduction functor R^{pq} . The result follows from the formulae (14.8) by induction.

(3) and (4). These parts follow from the formulae (14.8) and the fact that the reduction functor R is a representation equivalence.

(5) The Krull–Schmidt property follows from the observation that the endomorphism algebra of an indecomposable object of $\text{Rep}(\mathfrak{X})$ is local, see [7, Chapter I.3.6]. \square

Finally, it remains to observe that Theorem 14.3 is a special case of Theorem 14.26.

REFERENCES

- [1] M. Abouzaid, D. Auroux, A. Efimov, L. Katzarkov and D. Orlov, *Homological mirror symmetry for punctured spheres*, J. Amer. Math. Soc. **26** (2013), no. 4, 1051–1083.
- [2] M. Artin and J.-L. Verdier, *Reflexive modules over rational double points*, Math. Ann. **270** (1985), no. 1, 79–82.
- [3] M. Atiyah, *Vector bundles over an elliptic curve*, Proc. Lond. Math. Soc. (3) **7** (1957) 414–452.
- [4] M. Auslander, *Rational singularities and almost split sequences*, Trans. Amer. Math. Soc. **293** (1986), no. 2, 511–531.
- [5] M. Auslander, *Functors and morphisms determined by objects*, In Representation Theory of Algebras, Lecture Notes in Pure Appl. Math. **37**, (1978), 1–244.
- [6] C. Baciuc, *Maximal Cohen–Macaulay modules and stable vector bundles*, Computational commutative and non-commutative algebraic geometry, 65–73, NATO Sci. Ser. III Comput. Syst. Sci., **196** (2005).

- [7] H. Bass, *Algebraic K-theory*, W. A. Benjamin, New York, 1968.
- [8] L. Bodnarchuk, I. Burban, Yu. Drozd and G.-M. Greuel, *Vector bundles and torsion free sheaves on degenerations of elliptic curves*, Global aspects of complex geometry, 83–128, Springer, Berlin, 2006.
- [9] V. M. Bondarenko, *Bunches of semichained sets and their representations*, Preprint 88.60 of Institute of Mathematics, Kiev, 1988.
- [10] V. M. Bondarenko, *Representations of bundles of semichained sets and their applications*, Algebra i Analiz **3** (1991), no. **5**, 38–61.
- [11] N. Bourbaki, *Éléments de mathématique. Algèbre commutative. Chapitres 8 et 9*, Springer (2006).
- [12] E. Brieskorn, *Rationale Singularitäten komplexer Flächen*, Invent. Math. **4** (1968), 336–358.
- [13] W. Bruns and J. Herzog, *Cohen–Macaulay Rings*, Cambridge Studies in Advanced Mathematics 39, Cambridge Univ. Press, 1993.
- [14] R.-O. Buchweitz, *Maximal Cohen–Macaulay modules and Tate–Cohomology over Gorenstein rings*, Preprint 1987.
- [15] R. Buchweitz, G.-M. Greuel and F.-O. Schreyer, *Cohen–Macaulay modules on hypersurface singularities II*, Invent. Math. **88** (1987), no. **1**, 165–182.
- [16] I. Burban, *Abgeleitete Kategorien und Matrixprobleme*, PhD Thesis, Kaiserslautern 2003, available at <https://kluedo.ub.uni-kl.de/files/1434/phd.pdf>.
- [17] I. Burban and Yu. Drozd, *Derived categories of nodal algebras*, J. Algebra 272 (2004) 46–94.
- [18] I. Burban and Yu. Drozd, *Coherent sheaves on rational curves with simple double points and transversal intersections*, Duke Math. J. **121** (2004), no. **2**, 189–229.
- [19] I. Burban and Yu. Drozd, *Maximal Cohen–Macaulay modules over surface singularities*, Trends in representation theory of algebras and related topics, 101–166, EMS Ser. Congr. Rep., Eur. Math. Soc., Zürich (2008).
- [20] I. Burban and W. Gnedin, *Cohen–Macaulay modules over some non-reduced curve singularities*, arXiv:1301.3305.
- [21] I. Burban, O. Iyama, B. Keller and I. Reiten, *Cluster tilting for one-dimensional hypersurface singularities*, Adv. Math. **217** (2008), no. **6**, 2443–2484.
- [22] I. Burban and B. Kreuzler, *Vector bundles on degenerations of elliptic curves and Yang–Baxter equations*, Memoirs of the AMS, vol. **220**, no. **1035** (2012).
- [23] W. Crawley-Boevey, *Matrix problems and Drozd’s theorem*, Topics in algebra, Banach Center Publ. **26**, Part **1**, 199–222 (1990).
- [24] C. Curtis and I. Reiner, *Methods of representation theory. Vol. I. With applications to finite groups and orders*, Wiley–Interscience Publication (1990).
- [25] T. de Jong and G. Pfister, *Local Analytic Geometry*, Advanced Lectures in Mathematics, Vieweg 2000.
- [26] E. Dieterich, *Tame orders*, In Topics in Algebra, Part 1 (Warsaw, 1988), Banach Center Publ. **26**, Part 1, PWN, Warsaw, 1990, 233–261.
- [27] E. Dieterich, *Lattices over curve singularities with large conductor*, Invent. Math. **114** (1993), no. **2**, 399–433.
- [28] Yu. Drozd, *Matrix problems, and categories of matrices*, Investigations on the theory of representations, Zap. Nauchn. Semin. Leningr. Otd. Mat. Inst. Steklova **28**, 144–153 (1972).
- [29] Yu. Drozd, *Reduction algorithm and representations of boxes and algebras*, Comptes Rendue Math. Acad. Sci. Canada, 23 (2001), 97–125.
- [30] Yu. Drozd, *Vector bundles and Cohen–Macaulay modules*, In Representations of Finite Dimensional Algebras and Related Topics in Lie Theory and Geometry, Fields Inst. Commun., **40**, Amer. Math. Soc., Providence, RI, (2004), 189–222.
- [31] Yu. Drozd, *Vector bundles over projective curves*, IMPA, Rio de Janeiro, 2008.
- [32] Yu. Drozd and G.-M. Greuel, *Tame-wild dichotomy for Cohen–Macaulay modules*, Math. Ann. **294** (1992), no. **3**, 387–394.
- [33] Yu. Drozd and G.-M. Greuel, *Cohen–Macaulay module type*, Compositio Math. **89** (1993), no. **3**, 315–338.
- [34] Yu. Drozd and G.-M. Greuel, *Tame and wild projective curves and classification of vector bundles*, J. Algebra **246** (2001), no. **1**, 1–54.
- [35] Yu. Drozd, G.-M. Greuel and I. Kashuba, *On Cohen–Macaulay modules on surface singularities*, Mosc. Math. J. **3** (2003), no. **2**, 397–418.
- [36] Yu. Drozd and A. Roiter, *Commutative rings with a finite number of indecomposable integral representations*, Izv. Akad. Nauk SSSR Ser. Mat. **31** (1967), 783–798.

- [37] A. Efimov, *Homological mirror symmetry for curves of higher genus*, Adv. Math. **230** (2012), no. **2**, 493–530.
- [38] D. Eisenbud, *Homological algebra on a complete intersection, with an application to group representations*, Trans. Amer. Math. Soc. **260** (1980), no. **1**, 35–64.
- [39] H. Esnault, *Reflexive modules on quotient surface singularities*, J. Reine Angew. Math. **362** (1985), 63–71.
- [40] H. Esnault and E. Viehweg, *Two-dimensional quotient singularities deform to quotient singularities*, Math. Ann. **271** (1985), no. **3**, 439–449.
- [41] P. Gabriel, *Des catégories abéliennes*, Bull. Soc. Math. France **90** (1962), 323–448.
- [42] L. Galinat, *Orlov’s Equivalence and Maximal Cohen–Macaulay Modules over the Cone of an Elliptic Curve*, arXiv:1302.1383, to appear in Math. Nachrichten.
- [43] F. Gantmacher, *The theory of matrices*, vol. **1**, Providence, AMS Chelsea Publishing (1998).
- [44] G. González–Sprinberg and J.-L. Verdier, *Construction géométrique de la correspondance de McKay*, Ann. Sci. École Norm. Sup. (4) **16** (1983), no. **3**, 409–449 (1984).
- [45] E. Green and I. Reiner, *Integral representations and diagrams*, Michigan Math. J. **25** (1978), no. **1**, 53–84.
- [46] G.-M. Greuel and H. Knörrer, *Einfache Kurvensingularitäten und torsionsfreie Moduln*, Math. Ann. **270** (1985), no. **3**, 417–425.
- [47] G.-M. Greuel, C. Lossen and E. Shustin, *Introduction to Singularities and Deformations*, Springer Monographs in Mathematics. Springer, Berlin, 2007.
- [48] H. Jacobinski, *Sur les ordres commutatifs avec un nombre fini de réseaux indécomposables*, Acta Math. **118** (1967), 1–31.
- [49] J. Herzog, *Ringe mit nur endlich vielen Isomorphieklassen von maximalen, unzerlegbaren Cohen–Macaulay–Moduln*, Math. Ann. **233** (1978), no. **1**, 21–34.
- [50] O. Iyama and I. Reiten, *Fomin–Zelevinsky mutation and tilting modules over Calabi–Yau algebras*, Amer. J. Math. **130** (2008), no. **4**, 1087–1149.
- [51] O. Iyama and Yu. Yoshino, *Mutation in triangulated categories and rigid Cohen–Macaulay modules*, Invent. Math. **172** (2008), no. **1**, 117–168.
- [52] C. Kahn, *Reflexive Moduln auf einfach–elliptischen Flächensingularitäten*, Dissertation, Bonner Mathematische Schriften (1988).
- [53] C. Kahn, *Reflexive modules on minimally elliptic singularities*, Math. Ann. **285** (1989), no. **1**, 141–160.
- [54] A. Kapustin and Yi Li, *Topological correlators in Landau–Ginzburg models with boundaries*, Adv. Theor. Math. Phys. **7** (2003), no. **4**, 727–749.
- [55] B. Keller, D. Murfet and M. Van den Bergh, *On two examples by Iyama and Yoshino*, Compos. Math. **147** (2011), no. **2**, 591–612.
- [56] M. Khovanov and L. Rozansky, *Matrix factorizations and link homology*, Fund. Math. **199** (2008), no. **1**, 1–91.
- [57] H. Knörrer, *Torsionsfreie Moduln bei Deformation von Kurvensingularitäten*, Singularities, Representation of Algebras and Vector Bundles, Lecture Notes Math. **1273** (1987), 150–155.
- [58] H. Knörrer, *Cohen–Macaulay modules on hypersurface singularities I*, Invent. Math. **88** (1987), no. **1**, 153–164.
- [59] M. Kontsevich, *Homological algebra of mirror symmetry* Proceedings of the International Congress of Mathematicians, vol. 1 (Zürich, 1994), 120–139, Birkhäuser (1995).
- [60] G. Leuschke and R. Wiegand, *Cohen–Macaulay representations*, AMS Mathematical Surveys and Monographs **181** (2012).
- [61] L. Nazarova and A. Roiter, *On a problem of I. M. Gelfand*, Functional analysis and its applications **7**, (1973) no. **4**, 54–69.
- [62] D. Orlov, *Derived categories of coherent sheaves and triangulated categories of singularities*, in Algebra, arithmetic, and geometry. In honor of Y. I. Manin on the occasion of his 70th birthday, Vol. II, Birkhäuser, Progress in Mathematics **270**, 503–531 (2009).
- [63] D. Orlov, *Formal completions and idempotent completions of triangulated categories of singularities*, Adv. Math. **226** (2011), no. **1**, 206–217.
- [64] N. Popescu, *Abelian categories with applications to rings and modules*, London Mathematical Society Monographs, no. **3**, Academic Press (1973).
- [65] O. Riemenschneider, *Zweidimensionale Quotientensingularitäten: Gleichungen und Syzygien*, Arch. Math. **37** (1981), 406–417.

- [66] C.-M. Ringel and K. Roggenkamp, *Diagrammatic methods in the representation theory of orders*, J. Algebra **60** (1979), no. **1**, 11–42.
- [67] F.-O. Schreyer, *Finite and countable CM-representation type*, In Singularities, Representation of Algebras, and Vector Bundles, Lecture Notes Math. **1273** (1987), 9–34.
- [68] P. Seidel, *Homological mirror symmetry for the genus two curve*, J. Algebraic Geom. **20** (2011), no. **4**, 727769.
- [69] J.-P. Serre, *Local Algebra*, Springer Monographs in Mathematics. Springer-Verlag, Berlin (2000).
- [70] N. Sheridan, *On the homological mirror symmetry conjecture for pairs of pants*, J. Differential Geom. **89** (2011), no. **2**, 271–367.
- [71] N. Shepherd-Barron, *Degenerations with numerically effective canonical divisor*, The birational geometry of degenerations, 33–84, Progr. Math. **29**, Birkhäuser (1983).
- [72] J. Stevens, *Degenerations of elliptic curves and equations for cusp singularities*, Math. Ann. **311** (1998), no. **2**, 199–222.
- [73] J. Stevens, *Improvements of nonisolated surface singularities*, J. London Math. Soc. (2) **39** (1989), no. **1**, 129–144.
- [74] D. van Straten, *Weakly normal surface singularities and their improvements*, Dissertation, Leiden 1987.
- [75] M. Van den Bergh, *Three-dimensional flops and noncommutative rings*, Duke Math. J. **122** (2004), no. **3**, 423–455.
- [76] R. Wiegand, *Noetherian rings of bounded representation type*, Commutative algebra, 497–516, Math. Sci. Res. Inst. Publ. **15**, 1989.
- [77] J. Wunram, *Reflexive modules on cyclic quotient surface singularities*, In Singularities, Representation of Algebras and Vector Bundles, Lecture Notes Math. **1273** (1987), 221–231.
- [78] Y. Yoshino, *Cohen–Macaulay Modules over Cohen–Macaulay Rings*, London Mathematical Society Lecture Note Series **146**, Cambridge Univ. Press, 1990.
- [79] Y. Yoshino and T. Kawamoto, *The fundamental module of a normal local domain of dimension 2*, Trans. Amer. Math. Soc. **309** (1988), no. **1**, 425–431.

UNIVERSITÄT ZU KÖLN, MATHEMATISCHES INSTITUT, WEYERTAL 86-90, D-50931 KÖLN, GERMANY
E-mail address: burban@math.uni-koeln.de

INSTITUTE OF MATHEMATICS NATIONAL ACADEMY OF SCIENCES, TERESCHENKIVSKA STR. 3, 01004 KYIV, UKRAINE
E-mail address: drozd@imath.kiev.ua